

CHAPTER 5. USING THE SEQUENCER

This chapter explains how to use the V50 sequencer. You will learn how to record and edit your own original songs.

ABOUT THE SEQUENCER

What is a sequencer?

A sequencer is a device that records a musical performance and plays it back. The data recorded by a sequencer is not sound, but the actual musical performance. This means that it is possible to replay the same notes using a different voice than when recording, or to freely change the tempo. It is also possible to edit a certain section of the song, or rearrange the entire song.

Tracks

The V50 sequencer has eight "tracks". A track is a single part (the part played by one instrument) of a song. Since eight tracks are available, a song can have up to eight different parts playing together. For example the eight tracks might be used as follows.

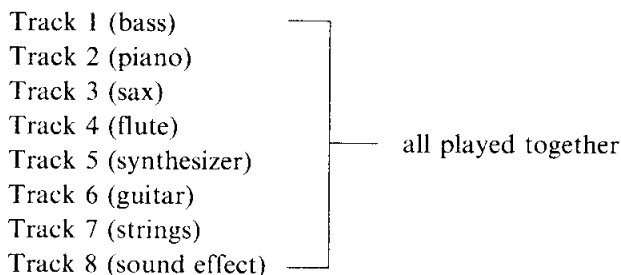

Each track is recorded separately. For example you might record the bass part on track 1, and then record the piano part on track 2 while listening to the bass part. By repeating this process, you can record as many tracks as you need. To use all eight tracks, you will need to record eight times.

Note:

Since a track can contain program change data to switch voices, a single track can play different sounds at different times. This allows you to use an unlimited number of sounds in a single song. However, no more than eight sounds can be produced at one time.

Realtime recording and step recording

There are two ways to record each track.

(1) Realtime recording

Record the notes with the exact timing that you play them on the keyboard.

(2) Step recording

Use the bar graph in the display to enter notes one by one, specifying the pitch and length for each note.

It is often thought that realtime recording is for good keyboard players, and step recording is for those who cannot play keyboard well. This is not always true. For example, you might use a slow tempo when realtime recording a difficult phrase, and then play it back at a faster tempo. Or you can use the "quantize" function to correct the timing of notes you recorded in realtime.

Use the two recording methods in the combination that is most efficient for each situation.

Songs

The V50 can remember eight songs, with each song containing eight tracks. However, the total number of notes for all tracks of all songs must not exceed 16,000. This means that depending on the length or complexity of a song, you may not be able to record all eight songs.

Note:

If aftertouch, pitch bend wheel, and modulation wheel data is recorded, the note capacity will be less.

Sequencer data

The eight songs in V50 memory will not remain in memory when the power is turned off.

After recording a song, remember to save it to disk before turning the power off. Data you saved can be recalled using the load function explained on page 105. Page 105 explains how to save, and page 105 explains how to load.

The sequencer and the synthesizer

The V50 sequencer and synthesizer are built into the same unit, but are essentially independent. Please remember the following points.

When using the sequencer to record keyboard playing

When you select the recording track in sequencer recording mode, the keyboard transmit channel will automatically be changed to the transmit channel for that sequence track. This eliminates having to set the keyboard transmit channel to match the receive channel of the tone generator (single or performance) so as to be able to hear the sound of the track being recorded.

However, when you move to synthesizer performance mode after recording in the sequencer, remember that the keyboard transmit channel has been changed. This may mean that playing the keyboard will not make the synthesizer sound.

In this case, you can hold the [-] key, and press [TR1] - [TR8] or [RHY] to set the transmit channel of the keyboard to the receive channel of the selected instrument.

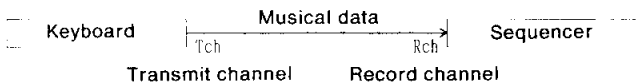

Normally, the receive channel of the sequencer will be set to "Kbd". This allows you to record sequence data from the V50 keyboard. Unless you are using an external keyboard to record sequencer data, leave it at this setting. (Page 88 tells how to set the sequencer receive channel.) When using an external keyboard to record data into the V50 sequencer, set the sequencer receive channel to match the MIDI transmit channel of the external keyboard.

When replaying a sequencer recording using the synthesizer

There are three basic situations.

(1) Using performance mode to replay each track with its own voice.

In this case, set the transmit channel of each sequencer track (each recorded track) to match the receive channel of the instrument playing the voice for that track.

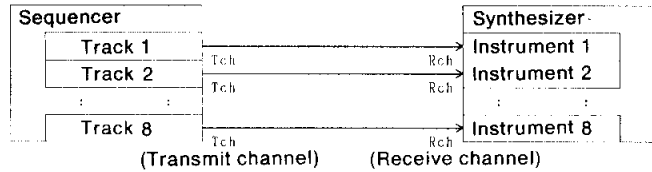

(2) Using single play mode to replay all tracks using a single sound.

In this case, set the transmit channels of all tracks (each recorded track) to match the basic receive channel of the synthesizer.

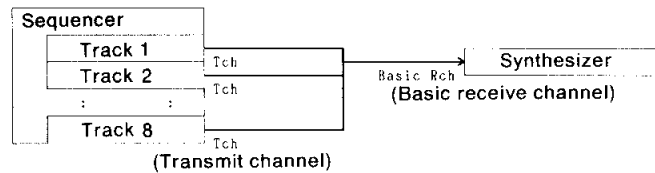

(3) While using single play mode to play one sound, play the remaining tracks using external tone generator modules or synthesizers.

In this case, set the transmit channel of each track (each recorded track) to match the basic receive channel of the synthesizer and the receive channels of the external devices.

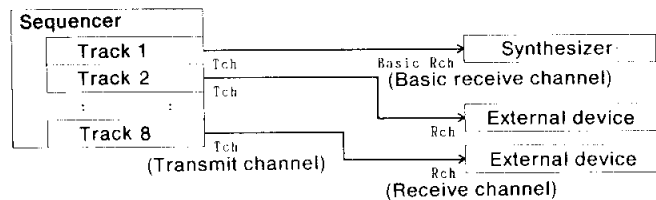

Note:

When sending program change messages from the V50 sequencer to external devices, set the MIDI function "Program change" setting to "TransFilter" (see page 101).

As you become more familiar with the sequencer, you will find other ways to use it. To set the sequencer transmit channel, see page 90. To set the performance receive channel, see page 25. To set the basic receive channel, see page 99.

SYNTHESIZER PREPARATIONS

Before starting to record using the sequencer, make the following settings to initialize a performance memory for use with the sequencer.

Note:

If you will be using only one voice with the sequencer, these preparations are unnecessary.

Since you can specify voices when making sequencer recording settings, there is no need to select each voice after initializing.

When using one to four sequencer tracks

Use the performance initialize function to select "SEQ4" as the initialization setting.

- (1) Press **PERFORMANCE** to enter performance play mode.
- (2) Select a performance number.
- (3) Press **OTHERS**.
- (4) Press the below "> Init".
- (5) Press the below "SEQ4".
- (6) Press **+1** to initialize the performance for four tracks.

When using five or more sequencer tracks.

Use the performance initialize function to select "SEQ8" as the initialization setting.

- (1) Press **PERFORMANCE** to enter performance play mode.
- (2) Select a performance number.
- (3) Press **OTHERS**.
- (4) Press the below "> Init".
- (5) Press the below "SEQ8".
- (6) Press **+1** to initialize the performance for eight tracks.

RHYTHM MACHINE PREPARATIONS

When recording and playing back with the sequencer, the rhythm song selected by the rhythm machine will also play back. According to the situation, you will need to use one of the following procedures.

If the sequencer song you are going to record uses a rhythm song which already exists

Select the song in the rhythm song play mode of the rhythm machine mode. The rhythm song will play during sequencer recording and playback.

If you want to create the rhythm song before recording the sequencer song

Before beginning sequencer recording, create the rhythm song in rhythm machine mode. Then select the song in the rhythm play mode of the rhythm machine mode. The rhythm song will play during sequencer recording and playback.

If you will be creating the rhythm song after recording the sequencer song, or if you will not be using rhythm sounds

If the rhythm song contains no data yet, go ahead and record the sequencer song. If the rhythm song contains data, you can either erase it, or select a different rhythm song that contains no data.

During sequencer recording and playback, the rhythm machine will not sound.

Here are some other possibilities.

It is often convenient to keep a simple rhythm pattern playing while you record in the sequencer.

Method 1: Create a simple rhythm song.

The song in the following example will repeat rhythm pattern P00 for 200 times.

Part01 = ||:

Part02 = PTN P00

Part03 = PTN P00

Part04 = :|| × 99

Method 2: In rhythm pattern play mode of the rhythm machine, select a rhythm pattern and keep it playing while you record using the sequencer.

With this method, the pattern will continue repeating even when you are not recording or playing back.

REALTIME RECORDING PROCEDURE

Here we will explain the procedure for realtime recording. The procedure can be illustrated as follows.

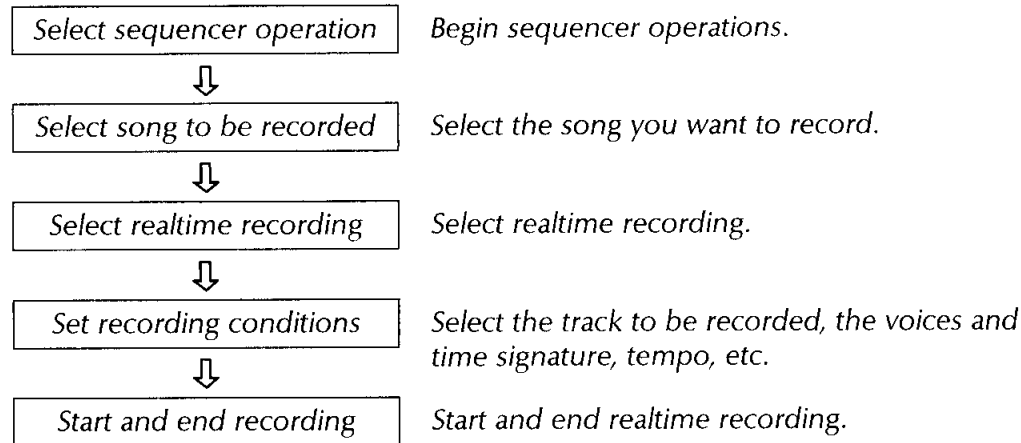

Select sequencer operation

From performance play mode, single play mode, or rhythm mode, enter the sequencer mode as follows.

- (1) Press **[SEQ]** to enter sequencer mode and get the following display.

```
PLAY SONG>           Time   >Meas>Tempo
▶1: NewSong          4/4     001  120
```

All sequencer operations are carried out in this mode.

Select a song to record

Select the number of the song to be recorded.

- (1) Move the cursor to the far left, and specify a song 1 – 8 to record. If setup data has already been stored for the song, the display may show “withSETUP” or “Song only” when you select the song. (This choice is explained on page 87.)

Select realtime recording

Here we will explain the most basic way to select realtime recording. For details, see page 94.

- (1) Press **[JOB]** to get the following display.

```
SEQUENCER JOB SELECT>   Select one!
>Setup>Tch>Song>Edit>Rec      >EXIT
```

- (2) Press the below “> Rec” to get the following display.

```
RECORD MODE> ▶Mode   >Condition
Free = 100% Realtime  Replace   >EXIT
```

- (3) Making sure that the cursor is located at “> Mode”, select the recording mode. Select from “Realtime”, “Step”, or “Punch”. In this example we will select “Realtime”.
- (4) Move the cursor to “> Condition”, and set the recording condition. Select from “Replace” (replace the previous recording) and “Overdub” (add to the previous recording). In this example we will select “Replace”.
- (5) Press the below “> EXIT” twice.

Set recording conditions

This is where you select the song and tracks to be recorded, and set time signature, tempo, and the voices to be used.

Note:

You cannot change the time signature of a track that has already been recorded. When you want to begin recording from the middle of the song, use $\square \gg$ and $\square \ll$ to change the measure, or move the cursor to "> Meas" and directly specify the measure. However if no data exists, you will not be able to advance the measure.

- (1) Press $\square \circ$ to enter recording mode and get the following display.

```
RECORD> >Mode>Voice>Time >Meas▶Tempo
Reface IND 100 4/4 001 120
```

- (2) Press $\square \text{TR1}$ - $\square \text{TR8}$ to select the track to be recorded. The LED at the left of $\square \text{TR1}$ - $\square \text{TR8}$ will indicate the selected track. Normally you will begin recording from track 1. Tracks which already contain data will be indicated by a green LED. Only one track can be recorded at a time. It is not possible to select more than one track for recording at once.
- (3) Move the cursor to "> Mode" and select the voice mode. You can hold the $\square -$ key, and press $\square \text{TR1}$ - $\square \text{TR8}$ or $\square \text{RHY}$ to set the transmit channel of the keyboard to the receive channel of the selected instrument.
When "SGL" (single) is selected, single play mode will be used.
When "PFM" (performance) is selected, performance play mode will be used.
When "IND" (individual) is selected, the voice of the instrument that matches the transmit channel of the track will be used.
- (4) Move the cursor to "> Voice" and select the voice number. You can hold the $\square -$ key, and press $\square \text{TR1}$ - $\square \text{TR8}$ or $\square \text{RHY}$ to set the transmit channel of the keyboard to the receive channel of the selected instrument.

When "> Mode" is set to "SGL", specify the voice number.

When "> Mode" is set to "PFM", specify the performance number.

When "> Mode" is set to "IND", specify the voice number.

- (5) Move the cursor to "> Time" and set the time signature. Select from 1/4 - 4/4, 1/8 - 8/8, and 1/16 - 16/16.
- (6) Move the cursor to "> Tempo" and set the tempo of the song. Select from a range of 30 - 240 quarter notes per minute.

Start and stop recording

Here is the procedure for actual recording.

- (1) Press $\square \triangleright$, and a two-measure countdown will begin. For example, if you have selected a time signature of 4/4, quarter notes will sound eight times (4 x 2 measures). The display will show the count until recording begins; "- 8, - 7, ...".
- (2) When the count reaches "0", recording will begin. Notes and chords you play on the keyboard will be recorded. If you move the cursor to "> voice" and select a different voice, the voice change will be recorded as part of the data.
- (3) When you are finished, press $\square \square$ to end realtime recording. Page 87 explains how to replay the performance you have just recorded.

If you make a mistake

If you make a mistake in realtime recording, you have the following possibilities.

- (1) Record over again from the beginning. Press $\square \circ$, $\square \triangleright$ and record over from the beginning.
- (2) Re-record only the measures where the mistakes in playing were made. Using the punch-in function explained on page 88, you can re-record only these measures.
- (3) Correct the mistake using step recording (see page 84).

Selecting single or performance memories while recording

If the transmit channel of the track being recorded matches the basic receive channel of the synthesizer, the performance you specify will be selected. If it does not match, there will be no change.

The voice mode and voice number you specified in the "> Mode" and "> Voice" settings are temporary. If you want to record these voice changes as sequencer data, perform the operations during sequencer recording.

STEP RECORDING PROCEDURE

The procedure for step recording is as follows.

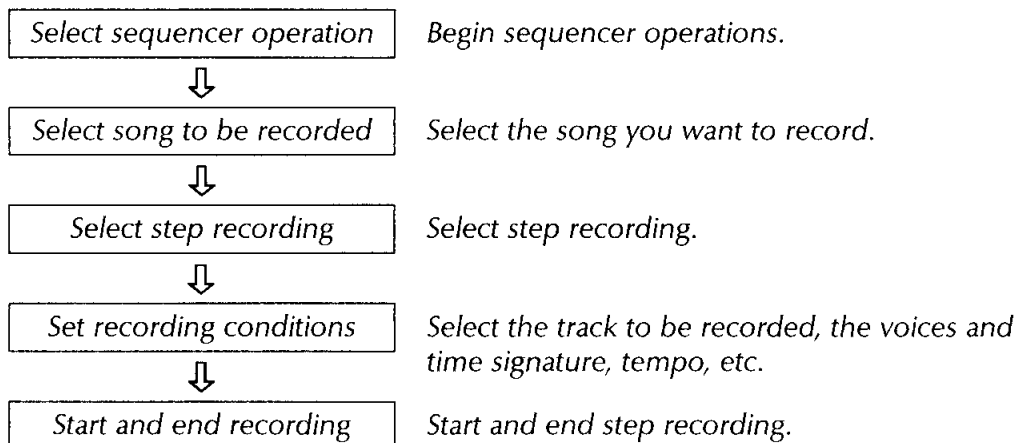

Select the sequencer function

From performance play mode, single play mode, or rhythm mode, enter the sequencer mode as follows.

- (1) Press **[SEQ]** to enter sequencer mode and get the following display.

```
PLAY SONG>           Time   >Meas>Tempo
▶1: NewSong          4/4     001 120
```

All sequencer operations are carried out in this mode.

Select a song to record

Select the number of the song to be recorded.

- (1) Move the cursor to the far left, and specify a song 1–8 to record. If setup data has already been stored for the song, the display will show “withPFM” or “Song only” when you select the song. (This choice is explained on page 87.)

Select step recording

Here we will explain the most basic way to select step recording. For details, see page 94.

- (1) Press **[JOB]** to get the following display.

```
SEQUENCER JOB SELECT>   Select one!
>Setup>Tch>Song>Edit>Rec   >EXIT
```

- (2) Press the below “> Rec” to get the following display.

```
RECORD MODE> ▶Mode   >Condition
free = 100% Realtime  Replace   >EXIT
```

- (3) Making sure that the cursor is located at “> Mode”, select the recording mode. Select from “Realtime”, “Step”, or “Punch”. In this example we will select “Step”.

- (4) Press the below “> EXIT” twice.

Note:

In step recording, “Overdub” will always be used regardless of the “> Condition” setting.

Set recording conditions

This is where you select the song and tracks to be recorded, and set time signature, tempo, and the performance or voice to be used. However if no data exists, you will not be able to advance the measure.

Note:

You cannot change the time signature of a track that has already been recorded. When you want to begin recording from the middle of the song, use and to change the measure, or move the cursor to “> Meas” and directly specify the measure.

- (1) Press to enter recording mode and get the following display.

STEP REC)	>Mode	>Voice	>Time	>Meas	>Tempo
Overdub	IND	100	4/4	001	120

- (2) Press **[TR1]** - **[TR8]** to select the track to be recorded. The LED at the left of **[TR1]** - **[TR8]** will indicate the selected track. Normally you will begin recording from track 1. Tracks which already contain data will be indicated by a green LED. Only one track can be recorded at a time. It is not possible to select more than one track for recording at once.
- (3) Move the cursor to "> Mode" and select the voice mode. You can hold the **[]** key, and press **[TR1]** - **[TR8]** or **[RHY]** to set the transmit channel of the keyboard to the receive channel of the selected instrument.
 - When "SGL" (single) is selected, single play mode will be used.
 - When "PFM" (performance) is selected, performance mode will be used.
 - When "IND" (individual) is selected, the voice of the instrument that matches the transmit channel of the track will be used.
- (4) Move the cursor to "> Voice" and select the voice number. You can hold the **[]** key, and press **[TR1]** - **[TR8]** or **[RHY]** to set the transmit channel of the keyboard to the receive channel of the selected instrument.
 - When "> Mode" is set to "SGL", specify the voice number.
 - When "> Mode" is set to "PFM", specify the performance number.
 - When "> Mode" is set to "IND", specify the voice number.
- (5) Move the cursor to "> Time" and set the time signature. Select from 1/4 - 4/4, 1/8 - 8/8, and 1/16 - 16/16.
- (6) Move the cursor to "> Tempo" and set the tempo of the song. Select from a range of 30 - 240 quarter notes per minute.

Start and stop recording

Here is the procedure for recording.

- (1) Press **[▶]** to get the following display.

This shows the length of a note

M001	♪	= - - - - - + - - - - - + - - - - - + - - - - -
		▶ GateTime ▶ PmChange

This is known as the "bar graph" display. In step recording, use this bar graph to specify the length and timing of each note. This bar graph shows the data for one measure. The number of the measure currently displayed is shown at the left side. The "+" mark indicates each beat. In the example above, the time signature is 4/4, and "-----+" is the length of one beat. This means that each "-" or "+" indicates the length of a 32nd note.

- (2) Use **[-1]** (◀) or **[+1]** (▶) to move to the position where you will begin recording. For example, if you want to record a note at the beginning of the second beat, move the cursor (|) to the "-" after the first "+".
- (3) Use the numeric keys to specify the note length. Select a note length from "o" to "♪". The bar graph will display "-" marks to indicate the length of the note.

For example, if you press **[3]** (♪), the bar graph will show the following.

| = - - - - - + - - - - - + - - - - - + - - - - - |

For example, if you press **[4]** (♪), the bar graph will show the following.

| = - - - - - + - - - - - + - - - - - + - - - - - |

Pressing the same note length twice will result in a note length of double value.

For example if you press **[4]** (♪) twice, the bar graph will show the following.

| = - - - - - + - - - - - + - - - - - + - - - - - |

To enter a dotted note, select the desired note length, and then press the dot key **[8]** (·).

For example, if you press **[4]** (♪) and then **[8]** (·), the bar graph will show the following.

| = - - - - - + - - - - - + - - - - - + - - - - - |

To enter a triplet, select the desired note length, and then press the triplet key **[9]** (≡).

For example, to enter $\overset{3}{\text{♪}}$, you would press **[4]** (♪) and then **[9]** (≡).

| = - - - - - + - - - - - + - - - - - + - - - - - |

↳ In the case of triplets, the bar will not show the exact note length.

To enter a tie (two added note values), select the first note, then press **[7]** (TIE), and then select

the second note. This will add the two selected note values.

For example, to tie ♩ and ♪, press (♩), (TIE), and (♪).

|=====+-----+-----|

To enter a slur (extended note length) or staccato (shortened note length), press the below "> GateTime" to get the following display. (The example shows the display when (♩) and then the below "GateTime" are pressed.)

```

M001 ♩ |=====+-----+-----|
                Norm>Stac>Slur      >EXIT
  
```

In this display, press the below the function you want. When "Stac" is selected, the note will sound for 50% of its length. When "Slur" is selected, the note will sound for 99% of its length. When "Norm" is selected (or when not otherwise specified), the note will sound for 80% of its length.

- (4) Specify the note pitch from the keyboard. You may play single notes or chords from the keyboard to specify the pitch of the note. To enter a rest, press (REST). When you specify the note pitch, the " - " in the bar graph will disappear, and a ◆ will indicate the position of the note you just input.
- (5) Repeat steps (2), (3), and (4) to input your song.
- (6) When finished recording, press . This completes step recording. Page 87 explains how to play back the song you recorded.

Inputting program changes

You can input program change data to switch voices during a song. Move the cursor to the position in the bar graph at which you want the voice change to occur, and press the below "> PgmChange". After specifying the voice or performance to change, press the below "GO". The bar graph will show a "p" to indicate that a program change has been inserted.

When a program change specifies a performance

In this case, the specified performance will be selected only if the transmit channel of that track matches the basic receive channel of the synthesizer. If it does not match, nothing will happen.

To delete a note you entered

If you input a wrong note, move the cursor to the position of the note and press (ERASE). All notes in the specified 32nd note region will be erased (including program change data).

The voice mode and voice number you specified in the "> Mode" and "> Voice" settings are temporary. If you want to record these voice changes as sequencer data, perform the operations during sequencer recording.

PLAYING A SONG

To play back a song, use the following procedure.

- (1) Press **[SEQ]**. (If you are already in sequencer mode, there is no need to do so.) The display will appear as follows.

PLAY SONG>	Time	>Meas>	Tempo
▶1:Sunset	4/4	001	120

The LEDs at the left of **[TR1]**–**[TR8]** will light green. If desired, it is possible to playback only certain tracks. Page 87 explains this “Track Mute” function.

- (2) Select the number (1–8) of the song to be played. If you select the number of a song that was stored with setup data, there will be a message allowing you to select “with SETUP” or “Song only”.

with SETUP

Select performance number, voice number, and rhythm song number along with the song number.

Song only

Select only the song, and not performance number or rhythm song number.

- (3) If necessary, you can set the measure at which to begin playing, and change the tempo.

Specify the measure using **[◀]** and **[▶]**, or by moving the cursor to “> Meas” and specifying the measure number.

Tempo can also be modified while playing back.

- (4) Specify tempo by moving the cursor to “> Tempo” and entering the tempo. You can also set the tempo by moving the data entry slider while pressing **[SEQ]**.

- (5) Press **[▶]** to begin playback. All tracks that contain data will play back.

- (6) To stop playing, press **[□]**. To resume playing from where you stopped, press **[▶]**. To resume playing from the beginning of the song, press **[□]** and **[◀]** together, and then press **[▶]**.

Track mute

Normally when playing back the sequencer, the LEDs at the left of **[TR1]**–**[TR8]** will light green, and when you press **[▶]**, all tracks will be played back. The “mute” function allows you to hear only specified tracks.

To mute a track when in sequencer play mode (while stopped, or during playback), press the **[TR1]**–**[TR8]** of the track you do not want to hear. The LED of that track will begin to blink green. The blinking tracks will remain silent, and only the unmuted tracks will be played back.

It is also possible to mute tracks before beginning to record.

In the same way, pressing **[RHY]** will mute the rhythm machine.

Note:

If you mute all tracks, there will be no sound. When the song number is changed, muting will be defeated.

PUNCH-IN RECORDING

Punch-in recording allows you to re-record only a specified measure or measures using realtime recording, using the following procedure.

- (1) Press **[JOB]** to get the following display.

```
SEQUENCER JOB SELECT)  Select one!
>Setup>Tch>Song>Edit>Rec  >EXIT
```

- (2) Press the below "> Rec" to get the following display.

```
RECORD MODE) ▶Mode  >Condition
free = 100% Realtime  Replace  >EXIT
```

- (3) Make sure that the cursor is located at "> Mode", and change the recording mode to "Punch". In punch-in recording, "Replace" will always be used regardless of the "> Condition" setting.

```
RECORD MODE) ▶Mode  >Condition
free = 81% Punch    Replace  >EXIT
```

- (4) Press to get the following display.

```
PUNCH REC)▶Mode>Voice  >Meas >In >Out
           IND P22      001 001 001
```

- (5) Specify the measure from which to start playback (Meas), and the beginning (In) and end (Out) of the measures to be re-recorded. Make sure that "Meas" \leq "In" \leq "Out".
- (6) Press **[TR1]** – **[TR8]** to select the track to punch-in.
- (7) Press . Playback will begin from the measure you specified in "Meas". When the measure "In" is reached, recording will automatically begin.

Play the keyboard to re-record the specified section.

When the measure "Out" is reached, recording will automatically end. This completes punch-in recording.

SETUP FUNCTIONS

These functions determine the receive channel and various other aspects of the sequencer. In sequencer mode, press **[JOB]** to get the following display.

```
SEQUENCER JOB SELECT)  Select one!
>Setup>Tch>Song>Edit>Rec  >EXIT
```

Press the below "> Setup" to get the following display.

```
SETUP)▶Rch>A.T  >Vel  >Click  >Sync
      Kbd off  on   Rec    int  >EXIT
```

(1) (2) (3) (4) (5)

If you press the below "> EXIT" you will return to the previous display.

(1) Receive channel

■ Function

Set the receive channel of the sequencer.

■ Settings

Kbd, 1 – 16, om

■ Explanation

This determines the MIDI channel that the sequencer will receive. Select from the following.

Kbd..... Record from the V50 keyboard. MIDI messages from external devices will not be recorded.

1 – 16... Record incoming MIDI messages of the specified channel. When recording MIDI messages from an external device, set this to match the transmit channel of the external device.

omn..... Record incoming MIDI messages of any channel.

■ Note:

Unless this "receive channel" is set to "kbd", your playing on the V50 keyboard will not be recorded.

(2) Aftertouch

■ Function

Determine aftertouch reception.

■ Settings

off, on

■ Explanation

This determines whether to record the aftertouch of the V50 keyboard or an external device.

off..... Aftertouch messages will neither be received nor recorded.

on..... Aftertouch messages will be received and recorded. If your playing uses aftertouch, it will be played back just as it was recorded.

These settings are effective only during recording.

(3) Velocity

■ Function

Determine key velocity reception.

■ Settings

off, on

■ Explanation

This determines whether to record the velocity of the V50 keyboard or an external device.

off..... Key velocity data will neither be received nor recorded.

on..... Key velocity data will be received and recorded. The key velocity of each note you play will be played back just as it was recorded.

These settings are effective only during recording.

(4) Click

■ Function

Determine when the click will sound.

■ Settings

off, rec, play, always

■ Explanation

This setting determines when the click (the metronome) will sound. Select one of the following.

off..... There will be no click.

Rec..... The click will sound only during realtime and punch-in recording. Normally you will use this setting.

Play/Rec.. The click will sound during realtime recording and playback.

Always..... The click will sound at all times while in sequencer mode.

(5) Sync

■ Function

Select the clock (timing source) for the sequencer.

■ Settings

int, MIDI

■ Explanation

This setting selects what will control the tempo. Select one of the following.

int..... Tempo will be controlled by the internal clock. Normally this is the setting you will select.

MIDI..... MIDI clock signals will determine the tempo. Select this setting when you want to control the tempo of the V50 sequencer from an external device.

Note:

When "MIDI" is selected, sequence playback and realtime recording will not be possible unless a clock signal is being received from an external device. (Step recording will be possible.)

The clock selected here applies to both the rhythm machine and the sequencer. If you select "MIDI" here, the rhythm machine will also be set to MIDI clock. This setting can also be made from the rhythm machine mode (see page 68).

SETTING TRANSMIT CHANNELS

Set the MIDI channel on which each sequencer track will transmit data.

In sequencer mode, press **[JOB]** to get the following display.

```
SEQUENCER JOB SELECT)  Select one!
>Setup>Tch>Song>Edit>Rec      >EXIT
```

Press the below ">Tch" to get the following display. (The displays will differ depending on whether the synthesizer mode is Single Play mode or Performance Play mode.)

If a synthesizer Voice is selected (single mode).

```
TRANSMIT CHANNEL)  Single Mode  Rch =1
 1/  2/  1/  1/  3/  4/ off/ off
```

If a synthesizer Performance is selected (multi mode).

```
R  1/  2/  3/  4/  5/  6/  7/  8
T  1/  2/  3/  4/  5/  6/  7/  8
```

The lower line of each display shows the channel that each track will transmit. In single mode, the upper right of the display will show the receive channel. In multi mode, the upper line ("R") will show the receive channel for each instrument.

■ Function

Set the output channel of each track.

■ Settings

off, 1–16

■ Explanation

This sets the MIDI channel that each track of the sequencer will transmit.

In single mode (single play mode), the V50 will play only the track data that is transmitted on a channel that matches the tone generator "Rch=" setting.

In multi mode (performance play mode), each track will play the instrument that matches its transmit channel (the lower line).

"off" indicates that data is not transmitted.

SONG JOB FUNCTIONS

Here you can name or clear a song.

In sequencer play mode, select the song to name (or clear), and press **[JOB]** to get the following display.

```
SEQUENCER JOB SELECT)  Select one!
>Setup>Tch>Song>Edit>Rec      >EXIT
```

Press the below ">Song" to get the following display.

```
SONG> NAME          Song Clear
1: NewSong  ← →      >GO      >EXIT
(1)          (2)
```

Pressing the below ">EXIT" will return to the previous display.

(1) Song name

■ Function

Set a name for the song.

■ Settings

Maximum of 8 characters.

■ Explanation

Set a name for the song. Page 17 explains how to enter characters.

(2) Song clear

■ Function

Erase the song data.

■ Explanation

This function erases the song name and the data of all tracks, and will initialize meter and tempo, etc.

Press the below ">GO". Press **[+1]** in response to the confirming message, and the song will be erased.

EDIT FUNCTIONS

Here you can do various editing operations on each track of a song.

In sequencer play mode, select the song to edit, and press **[JOB]** to get the following display.

```
SEQUENCER JOB SELECT)  Select one!  
>Setup>Tch>Song>Edit>Rec      >EXIT
```

Press the below ">Edit" to get the following display.

```
EDIT TRACK)           Select one!  
>Mix >Qntz>Del >Ins >Copy>Eras>Remv>EXIT
```

Pressing the below ">EXIT" will return to the previous display.

Track mix down

Press the below ">Mix".

```
TRACK MIX DOWN)  
Tr ▶1 and Tr >1  to Tr >1      >GO >EXIT
```

■ Function

Mix down (combine) the data of two tracks into one track.

■ Settings

1-8 (select track)

■ Explanation

This will mix the data of two different tracks and put it in a single track. For example, if you had recorded a piano part by playing each hand separately into different tracks, you could use this function to combine the two tracks into a single track.

The first two "Tr" numbers are the source tracks. The third "Tr" is the destination track. After specifying the three tracks, press the below ">GO". Press **[+1]** in response to the confirming message, and track mix down will be executed.

Note:

Once you have mixed down two tracks, you will no longer be able to play them with separate voices. Also, the previous data will be erased.

Quantize

Press the below "Qntz".

```
QUANTIZE)           ▶Tr  >Size  
1 1/16              >GO >EXIT
```

■ Function

Correct each note to the nearest specified timing.

■ Settings

1-8 (select track), 1/48, 1/32, 1/16, 1/12, 1/8, 1/6, 1/4 (size)

■ Explanation

Quantization will move the start timing of each note to the nearest interval of the specified value.

The following diagram is an example of a track recorded in realtime, and played with inaccurate timing.



The notes on the second and third beat are slightly out of time. Quantize can be used to correct such notes. If we set "Size" to "1/4" and execute this quantize function, the notes will be moved to the nearest beat of "1/4", as follows.



"Size" is the smallest time value that will be allowed to remain after this operation is executed. This means that if you intended your music to contain 16th notes, you should specify 1/16. If you quantized using 1/8, some of the 16th notes might be moved to the nearest 8th note. (The length of the notes will remain unchanged.)

After specifying the track and size, press the below ">GO". Press **[+1]** in reply to the confirming message, and quantize will be executed.

Note:

It is not possible to reverse the effects of quantization. If your music contains triplets, use a quantization value such as 1/6, 1/12, or 1/24.

Delete

Press the below ">Del".

```
DELETE> Delete Measure (All tracks)
from ▶001 to >001 >GO >EXIT
```

■ Function

Delete the specified range of measures.

■ Explanation

The specified range of measures will be deleted from the entire song (all tracks). Measures following this range will be moved forward.

measure

1	2	3	4	5	6	7	8	9
---	---	---	---	---	---	---	---	---

Specify measures "from 002 to 005"

measure

1	6	7	8	9	10	11	12	13
---	---	---	---	---	----	----	----	----

If you specify measures "from 002 to 005" as shown in the upper diagram, the song will change as shown in the lower diagram. (The measures will be renumbered as "1, 2, 3,...")

After specifying the beginning and end measures to be deleted, press the below ">GO". Press +1 in reply to the confirming message, and the measures will be deleted.

Insert

Press the below ">Ins".

```
INSERT> Insert Measure (All tracks)
from ▶001 to >001 Ins >001 >GO >EXIT
```

■ Function

Insert the specified measures into another location.

■ Explanation

The specified range of measures (all tracks) will be copied and inserted into another location. Measures at the specified destination will be pushed back.

measure

1	2	3	4	5	6	7	8	9
---	---	---	---	---	---	---	---	---

Specify measures "from 002 to 003 Ins to 006"

measure

1	2	3	4	5	2	3	6	7
---	---	---	---	---	---	---	---	---

If you specify measures "from 002 to 003 Ins to 006" as shown in the upper diagram, the song will change as shown in the lower diagram. (The measures will be renumbered as "1, 2, 3,...")

After specifying the beginning and end measures of the source, and the measure of the destination, press the below ">GO". Press +1 in reply to the confirming message, and the measures will be inserted.

Note:

Insert affects all tracks. It is not possible to insert measures into just one track.

Copy

Press the below ">Copy".

```
COPY> Copy Measure
Tr ▶1 >001 to Tr >1 >001 >GO >EXIT
```

■ Function

Copy the specified range of measures to another location.

■ Explanation

The specified range of measures from a specified track will be copied to another location. The data previously in that location will be replaced by the newly copied data. This function allows you to copy measures between tracks.

measure

1	2	3	4	5	6	7	8	9
---	---	---	---	---	---	---	---	---

Specify "Tr1 002 - 003 to Tr1 006"

measure

1	2	3	4	5	2	3	8	9
---	---	---	---	---	---	---	---	---

If you specify “Tr1 002 - 003 to Tr1 006” as shown in the upper diagram, the song will change as shown in the lower diagram. (The measures will be renumbered as “1, 2, 3,...”)

After specifying the track, and beginning and end measures of the source, and the track and measure of the destination, press the below “>GO”. Press in reply to the confirming message, and the measures will be copied.

Eraser

Press the below “> Erase”.

```
ERASE> Erase Measure
Tr 1 from >001 to >001 >GO >EXIT
```

Function

Erase the data in the specified range of measures.

Explanation

The data in the specified range of measures will be erased, and replaced with rests. This allows you to erase part of a single track, or part of all tracks (when “all” is selected instead of a track number).

measure

1	2	3	4	5	6	7	8	9
---	---	---	---	---	---	---	---	---

Specify “Tr1” from 002 to 003”

measure

1	2	3	4	5	2	3	8	9
---	---	---	---	---	---	---	---	---

These measures are blank (all rests)

If you specify “Tr1 from 002 to 003” as shown in the upper diagram, the song will change as shown in the lower diagram.

After specifying the track, and beginning and end measures, press the below “>GO”. Press in reply to the confirming message, and the measures will be erased.

If the specified range of measures covers the first and last (or later) measures of the track, then the specified track will be empty, and its LED will go off.

Remove

Press the below “> Remv”.

```
REMOVE EVENT>
#Cnt > 0+> 0 Tr>1 >001+>001 >GO >EXIT
```

Function

Remove the specified data from the specified measures.

Explanation

This removes pitch bend wheel data, aftertouch data, or other control change data and program changes from the specified range of measures. The note data will remain.

Select one of the types of data to be removed.

Cnt..... Remove control change data. When this is selected, you will also be able to specify the range of control change numbers 0–127 to be removed.

P.B...... Remove pitch bend wheel data.

A.T...... Remove aftertouch data.

After specifying the track and type of data to be removed (and when “Cnt” is selected, the range of control numbers), the track, and beginning and end measures, press the below “>GO”. Press in reply to the confirming message, and the specified data will be removed.

SETTING RECORDING CONDITIONS

This is where you make various settings related to sequencer recording.

In sequencer mode, press **JOB** to get the following display.

```
SEQUENCER JOB SELECT)  Select one!  
>Setup>Tch>Song>Edit>Rec      >EXIT
```

Press the below ">Rec" to get the following display.

```
RECORD MODE)  Mode      >Condition  
free = 100% Realtime  Replace  >EXIT  
└──(1)──┘ └──(2)──┘ └──(3)──┘
```

(1) Free

■ Function

Displays the remaining sequencer memory.

■ Explanation

This indicates the percentage of sequencer memory that is available for recording. 100% indicates that no data is present. 0% indicates that no more data can be recorded.

(2) Recording mode

■ Function

Select the recording mode.

■ Settings

realtime, step, punch

■ Explanation

Select one of the following three recording modes.

Realtime... Realtime recording (see page 82).

Step Step recording (see page 84).

Punch..... Punch-in recording (see page 88).

(3) Recording condition

■ Function

Select the realtime recording condition.

■ Settings

Replace, Overdub

■ Explanation

Select one of the following two realtime recording conditions.

Replace The newly recorded data will replace the old data. (The old data will be erased.)

Overdub ... The newly recorded data will be combined with the old data.

Note:

When you begin recording using "Replace", all the old data in the measures from where recording began to where recording ended will be erased.

STORING SETUP DATA

The data that is stored for each sequencer song includes the voices, performances, and number of the rhythm song used with that sequencer song. When you load sequencer data from disk and start playback, all this data will be loaded as well, meaning that all necessary data and settings will be made automatically.

Use the following procedure to store setup data.

(1) In sequencer mode, press **STORE/COPY** to get the following display.

```
STORE)  Mode      Are you sure ?  
Store SETUP data to song 1 ?
```

(2) Press **+1** to store setup data.

Note:

Remember to save the song data itself before you turn the power off. If you fail to do so, the setup data will be lost along with the song data.

- This operation stores only the "number" of the performance and rhythm song. This means that if rhythm song "1" was selected when you stored, if a different rhythm is in rhythm song "1" when you play the song back, playback will be incorrect.

In order to play back the correct rhythm for the sequencer song, remember to select "ALL" when saving to disk. (Page 105 tells how to save data.)

- Tempo data is included in a sequencer song, and has no relation with setup data.

CHAPTER 6. UTILITY FUNCTIONS

This chapter explains card and disk operations, settings for MIDI reception and transmission, micro tuning, performance effect, and initialization of voices and performances.

CARD OPERATIONS

Types of memory card

The V50 uses two types of card.

ROM card:

Voice and performance data stored on ROM cards can only be read (not written to). You cannot use a ROM card to store your own original voices or performances. Voice or performance cards are of this type.

RAM card (MCD32 or MCD64):

Voice, performance or rhythm machine data can be saved to or loaded from a RAM card. Use a RAM card to store your own original voices, performances, or rhythm machine data.

This type of card has a write protect slider switch. When this switch is "on", data cannot be stored to the card. When you need to store data to a card, set its write protect switch to "off". (Use a pointed non-metallic object such as a toothpick to move the switch.)

Note:

Cards are very fragile. Do not bend or drop them, or subject them to high temperatures, high humidity, or excessive dust.

Do not allow foreign objects to enter the card slot.

Always turn the power off before inserting or removing a card.

Cards contain a backup battery with a lifespan of approximately 5 years. When the backup battery in a card nears the end of its lifespan, the V50 display will show "Change card battery" when you select a card voice or card performance.

When this occurs, copy the contents of the card to another card or to disk, and contact your dealer or authorized Yamaha service center to have the battery replaced. (When the battery is replaced, the memory contents of the card will be lost.)

About card formatting

When you purchase a new RAM card, you must "format" it before using it to save data. Page 95 explains how to format a card.

About card banks

A MCD32 card has 1 bank, and a MCD64 card has 2 banks. (It may help to think of a "bank" as being like a drawer in a file cabinet. A single file cabinet may contain one or more drawers, each with different information.) Saving, loading, and formatting is done separately for each bank.

Card format

Format cards using the following procedure.

Note:

Even if a card is formatted, the old data in the card will *not* be lost.

- (1) Press **[CARD]** to get the following display.

```
UT CARD> ▶BANK Format
                1  unfmtd  >Form>Save>Load
```

- (2) Select the bank to format. When using an MCD32, select 1. When using an MCD64, select 1 or 2.
- (3) Press the below "> Form" to get the following display.

```
UT CARD>  FORMAT  Select one !
                U50SYN  U50RHY  >EXIT
```

You can press the below "> EXIT" to return to the previous display.

(4) Press a to specify one of the following two formats.

V50SYN... In this format, the card can be used to store voice data, performance data, or synthesizer setup data.

V50RHY.. In this format, the card can be used to store rhythm part data, song data, or rhythm machine setup data.

The display will ask "Are you sure?"

(5) Press +1, and the selected bank will be formatted.

Data saved and loaded from card

The following data can be transferred between internal and card memory.

Synthesizer data

Data type	Abbreviation	Contents
All data	SynALL	<ul style="list-style-type: none"> ● Voice data (100 voices) ● Performance data (100 performances) ● Program change table data ● Performance effect data ● Micro tuning data ("oct" and "full" only) ● System data
Voice & performance data	V&PF	<ul style="list-style-type: none"> ● Voice data (100 voices) ● Performance data (100 performances)
Setup All Data	setAL	<ul style="list-style-type: none"> ● Program change table data ● Performance effect data ● Micro tuning data ("oct" and "full" only)
Program change table data	PCT	<ul style="list-style-type: none"> ● Program change table data
Performance effect data	PEFCT	<ul style="list-style-type: none"> ● Performance effect data
Micro tuning data	MCT	<ul style="list-style-type: none"> ● Micro tuning data ("oct" and "full" only)
System data	SYS	<ul style="list-style-type: none"> ● Master tuning ● Synthesizer volume ● Basic receive channel ● Transmit channel ● Program change mode ● Control change mode ● Aftertouch mode ● Pitch bend mode ● Note on/off ● Device number ● Memory protect (INT/CRT) ● Combine ● Power on message ● MIDI on/off ● Local on/off ● Data entry assign ● Controller reset ● Fixed velocity ● Velocity curve ● EG forced damp ● Voice dump

Rhythm machine data

Data type	Abbreviation	Contents
Rhythm all data	ALL	<ul style="list-style-type: none"> ● Rhythm pattern data (100 patterns) ● Rhythm song data (8 songs) ● Rhythm setup data
Rhythm sequence data	R.SEQ	<ul style="list-style-type: none"> ● Rhythm pattern data (100 patterns) ● Rhythm song data (8 songs)
Rhythm setup data	SETUP	<ul style="list-style-type: none"> ● Rhythm setup data

Note:

Sequencer data cannot be saved to card.

Save

This is where you save data to a card. This function does not allow you to save individual voices or performances to card. (To store individual voices or performances, use the "store" function explained on page 119.)

Two complete sets of rhythm data (all rhythm patterns, all songs, and rhythm machine setup data) will fit in a single bank of a card. When saving rhythm machine data to card, specify whether to save or load "A" or "B". Synthesizer data occupies an entire bank of a card.

Note:

If the write protect switch on the RAM card is "on", or the memory protect setting (card) is "on", you will get a "Memory Protected" display, and save will not be executed.

Data will be saved into the selected bank, overwriting any data which may have been in that bank. Be careful not to overwrite important data by mistake.

You cannot save to a bank which has not been formatted.

You cannot save to a ROM card.

- (1) Press **[CARD]** to get the following display.

```
UT CARD) 1BANK Format
          1 V50SYN  >Form>Save>Load
```

- (2) Specify the bank into which to save data. When using an MCD32, select 1. When using an MCD64, select 1 or 2. The format of the selected bank will be displayed under "Format". When saving synthesizer data, be sure to select a bank that has been formatted to "V50SYN". When saving rhythm machine data, be sure to select a bank that has been formatted to "V50RHY".

- (3) Press the below "> Save" to get the following display.

```
UT CARD) SAVE Select one !
Synth      Rhythm(toA) Rhythm(toB)>EXIT
```

You can press the below "> EXIT" to return to the previous display.

- (4) Press the to select the type of data to save.

Synth..... Save synthesizer data.

Rhythm to (A)... Save rhythm machine data to bank section A

Rhythm to (B).... Save rhythm machine data to bank section B

If you have selected "Synth", the following display will appear.

```
UT CARD) SAVE Synth select one !
Signal U&PF SetAL PCT PEFC MCT SYS >EXIT
```

If you have selected "Rhythm(A)" or "Rhythm(B)", the following display will appear.

```
UT CARD) SAVE Rhythm(toA) Select one !
RHYALL      R.SEQ      SETUP >EXIT
```

- (5) Press a to select the type of data to save. The chart on page 96-97 explains the contents of each type. You will get a message of "Are you sure?"

- (6) Press **[+1]**, and the specified data will be saved to the selected bank of the card.

Load

Load allows you to load data from the card into V50 memory.

Note:

If the memory protect (internal) is "on", you will get an error message of "Memory Protected", and will not be able to load. (However, R.SEQ is an exception.)

When you execute load, the voice, performance, and setup data etc. will be lost. Be careful not to overwrite any data you wanted to keep.

- (1) Press **CARD** to get the following display.

```
UT CARD> ▶BANK Format
          1 US05YN >Form>Save>Load
```

- (2) Select the bank from which to load. When using an MCD32, select 1. When using an MCD64, select 1 or 2.

- (3) Press the below "> Load" to get the following display.

```
UT CARD> LOAD Select one !
Synth Rhythm(A) Rhythm(B) SEQ(YS)>EXIT
```

- (4) Press a to select one of the following types of data to load.

Synth Load synthesizer data.

Rhythm(A) .. Load rhythm machine data from bank section A.

Rhythm(B)... Load rhythm machine data from bank section B.

SEQ(YS)..... Load sequence data from a YS200/B200 synthesizer.

Demo sequence data from the YS200/B200/TQ5 can be loaded, but may not be played back correctly.

If you have selected "Synth", the following display will appear.

```
UT CARD> LOAD Synth select one !
Synth U&PF SetAL PCT PEFC T MCT SYS >EXIT
```

If you have selected "Rhythm(A)" or "Rhythm(B)", the following display will appear.

```
UT CARD> LOAD Rhythm(A) select one !
RhyALL R.SEQ SETUP >EXIT
```

If you have selected "SEQ(YS)", proceed to step (6)

- (5) Press a to select the type of data to load. The chart on page 96-97 explains the contents of each type. You will get a message of "Are you sure?"
- (6) Press **+1** and the data will be loaded from card to V50 internal memory.

MIDI FUNCTIONS

Channel information

(MIDI on/off, basic receive channel, transmit channel, local on/off)

Press **[MIDI]**, and then press the below “ChInfo” to get the following display.

```
UT MIDI) |Midi>BasicRch >KbdTch>Local
           on omni          1 on >EXIT
(1) (2) (3) (4)
```

This is where you make overall settings for MIDI transmission. Press the below “> EXIT” to return to the previous display.

(1) MIDI on/off

■ Function

Select whether or not you will receive and transmit MIDI data.

■ Settings

off, on

■ Explanation

This determines whether or not the V50 will communicate via MIDI with external devices. When you want to use MIDI, set this “on”. If not, set it “off”. Realtime messages and common messages are not affected by this switch.

(2) Basic receive channel

■ Function

Set the MIDI receive channel

■ Settings

1 – 16, omni

■ Explanation

This determines the receive channel for single play mode.

When using the internal sequencer or an external device to play the V50 in single play mode, set this to match the transmit channel of the MIDI device, or select “omni” (omni on).

When “omni” (omni on) is selected, data on any channel 1 – 16 will be received.

When program change is set to “common”, this acts as the program change receive channel.

Note:

Set the MIDI receive channel of each instrument in performance play mode using the performance edit setting **[TR4]** (RECV CH) (see page 25).

(3) Keyboard transmit channel

■ Function

Set the MIDI keyboard transmit channel.

■ Settings

1 – 16

■ Explanation

This sets the channel on which the V50 will transmit data to external devices.

When using the V50 keyboard to play external synthesizers (such as the DX7II) or tone generator modules (such as the TX802 or TX16W), set the MIDI receive channel of the external devices to match this MIDI transmit channel.

In single play mode, the V50 will sound regardless of this transmit channel setting.

In performance mode, pressing and **[TR1]** – **[TR8]** and **[RHY]** will set the transmit channel to the corresponding instruments.

Note:

In performance play mode, if the channel specified in **[TR4]** (RECV CH) does not match this transmit channel, playing the keyboard will not produce sound.

(4) Local on/off

■ Function

Separate the keyboard and tone generator.

■ Settings

off, on

■ Explanation

This determines how the V50 keyboard and tone generator are connected. When this is set “on”, the keyboard is connected to the tone generator. When this is set “off”, the keyboard is disconnected from the tone generator, and playing the keyboard in single play mode will not produce sound.

When this is set “off”, the V50 can be used as two separate devices; a MIDI keyboard (without a tone generator) and a tone generator module.

When the power is turned on, this is set “on”.

Switch (MIDI control change, MIDI aftertouch, MIDI pitch bend)

Press **[MIDI]**, then press the below "> Switch" to get the following display.

```

UT  MIDI>▶Cont.Change>A.Touch >PitchBend
           norm           G16      off>EXIT
           (1)           (2)      (3)
    
```

You can press the below "EXIT" to return to the previous display.

(1) MIDI control change

■ Function

Determine how control change messages are received.

■ Settings

off, norm, G1 – G16

■ Explanation

This determines how control change messages (controllers except for aftertouch and pitch bend) are received. (Reception of aftertouch and pitch bend are set independently.)

In single play mode, only the control change messages that are received on the basic receive channel will have any effect.

Select from the following.

off..... Even if control change messages are received from the keyboard or sequencer, they will be ignored.

norm..... Control change messages from the keyboard or sequencer will have effect only if their channel matches the receive channel.

G1 – G16.. Control change messages from the keyboard or sequencer will have effect only if their channel matches the receive channel.

In addition, control change messages of the channel specified here (G1 – G16) will affect instruments of *all* channels (i.e., they will have a global effect).

When this is set to "norm" or "G1 – G16", control change messages will be transmitted, but when set to "off", control change messages will not be transmitted.

About global channel

Normally, different instruments are set to receive a different MIDI channel, and be controlled separately by incoming messages on their own channel.

Global channel is when a certain specified channel is given "global" or "overall" control over *all* instruments regardless of their receive channel setting. When data is received on the specified global channel, it will affect all instruments regardless of their receive channel setting.

The following diagram shows the effect that messages on two different channels will have when a global channel of "G3" has been set.

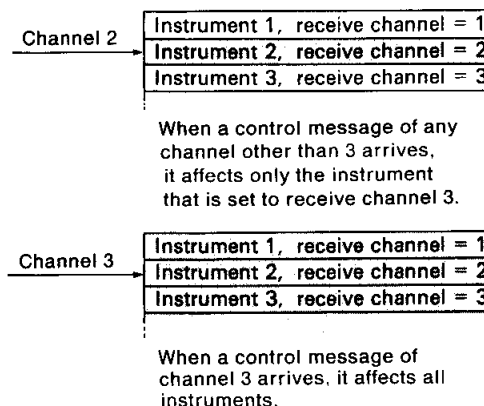

(2) MIDI aftertouch

■ Function

Set reception conditions for aftertouch messages.

■ Settings

off, norm, G1 – G16

■ Explanation

This determines reception conditions for aftertouch messages. Details of each setting are the same as for MIDI control change explained in the previous section.

(3) MIDI pitch bend

■ Function

Set reception conditions for pitch bend messages.

■ Settings

off, norm, G1 – G16

■ Explanation

This determines reception conditions for pitch bend messages. Details of each setting are the same as for MIDI control change explained in the previous section.

Condition (note on/off, data entry assign)

Press **[MIDI]**, then press the below ">Cond" to get the following display.

```

UT  MIDI> ▶Note on/off    >D.EntryAssign
           all             0(undef)>EXIT
    (1)                (2)
  
```

You can press the below ">EXIT" to return to the previous display.

(1) Note on/off

```

UT  MIDI> ▶Note on/off    >D.EntryAssign
           all             0(undef)>EXIT
    (1)                (2)
  
```

■ Function

Specify note reception.

■ Settings

all, odd, even

■ Explanation

This determines how note on messages (data telling that a note has been played) are received from the sequencer or from MIDI. Select one of the following three.

all The normal condition.

odd When "odd" is selected, the V50 will produce sound only in response to odd-numbered notes. (MIDI note on messages include a note number telling which note was played.)

even When "even" is selected, the V50 will produce sound only in response to even-numbered notes.

This function allows you to use two V50s (or a TX81Z, etc.) to increase the total polyphony. The following diagram shows how two V50s can be connected to increase the polyphony to 32 notes. The notes sounded from the keyboard are not affected by this setting.

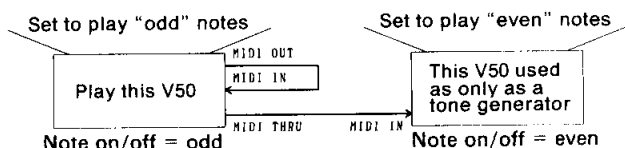

- Connect the MIDI OUT of the transmitting V50 to its own MIDI IN.
- Connect the MIDI THRU of the transmitting V50 to the MIDI IN of the V50 being used as a tone generator.
- Set one V50 to play even notes, and the other V50 to play odd notes.
- Set the local on/off of the transmitting V50 to "off".

(2) Data entry assign

■ Function

Set the control change number transmitted by the data entry slider.

■ Settings

0-31

■ Explanation

This determines which control change number will be transmitted when you move the data entry slider while in performance play mode or single play mode.

As you select a control number, the name of the controller assigned to that number will be shown in parenthesis, as in the following example.

(Example) 1 (Mod.W) modulation wheel
 2 (BC) breath controller
 4 (FC) foot controller

"(undef)" indicates that the selected control number has not yet been defined as a part of the MIDI standard.

For example, if you set this to "2 (BC)", the data entry slider can act as a breath controller while in performance play mode or single play mode.

Note:

This function only transmits MIDI control change messages. The actual result will depend on the settings of the receiving device.

Program change

Press **[MIDI]**, then press the below ">PgmCng" to get the following display.

```

UT  MIDI> ▶Pgm Change
           individual    >Init>Edit>EXIT
  
```

You can press the below ">EXIT" to return to the previous display.

■ Function

Specify how program changes from the internal sequencer or from external devices will be received.

■ Settings

off, common, individual, direct TransFilter

■ Explanation

When program change messages are sent to the V50 from the internal sequencer or from an external device via MIDI, this setting will determine how they are received. Select one of the following.

off

Program change messages will be ignored.

common

In both single play mode and performance play mode, when a program change on the basic receive channel is received, the voice or performance specified by the program change receive table will be selected.

individual

In performance play mode, when a program change message is received on the receive channel of an instrument, the voice specified by the program change receive table will be selected.

direct

In performance play mode, incoming program change messages will directly select the voice for the instrument with the corresponding receive channel. (The program change table is ignored.)

TransFilter

Program changes recorded in the V50 sequencer differ from ordinary program change messages, and actually contain *two* program change signals. (The first signal selects internal, card, or preset memory, and the second signal is the actual voice number.)

This means that when the V50 sequencer is used to select programs of an external device, an extra program change message is transmitted.

If "TransFilter" is selected, the first program change will be filtered out, and only the second will be transmitted. For reception, this is the same as individual.

The program change table is explained in the following section.

When this function is set to "off", the V50 will not transmit program change messages. Also, if the device number is at any setting other than "off", the V50 will transmit system exclusive data whenever a program is changed, and will not transmit a program change message.

If device number is "off" and program change is at any setting other than "off", then a program change message will be sent on the specified transmit channel.

Note:

When "individual" is selected, program changes will refer to the program change table, but if the program change table entry is a performance number, it will be ignored. (Only voices can be selected when "ind" "individual" is selected.)

Program change table initialize

Press **[MIDI]**, then press the below "> PgmCng", and press the below "> Init" to get the following display.

```
UT MIDI> Initialize PGM change table ?
                                     >EXIT
```

You can press the below "> EXIT" to return to the previous display.

■ Function

Initialize the program change table.

■ Explanation

When most MIDI instruments receive a program change message, they select the voice of the same number as the program change message. This means that when several such MIDI instruments are connected, their internal memories must be rearranged so that each will select the desired voice in response to a single program change message.

However, the V50 has a "program change table" that allows you to specify which voice (or performance) is selected in response to each incoming program change message. (When "direct" is selected, this program change table is ignored.)

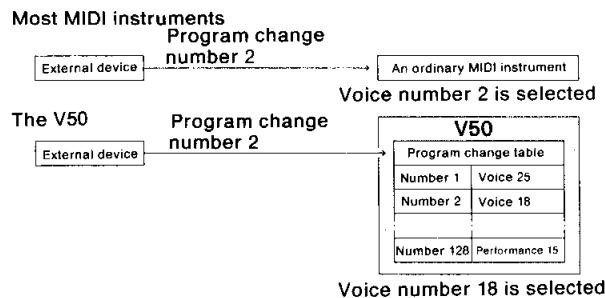

This function allows you to initialize the program change table to the following condition.

Number	Setting	Number	Setting
1	I00	101	P00
2	I01	102	P01
:	:	:	:
100	I99	128	P27

When you press **[+1]** you will be asked "Are you sure?". Press **[+1]** again, and the program change table will be initialized.

Program change table edit

Press **[MIDI]**, press the below ">PgmCng", and press the below ">Edit" to get the following display.

```
UT MIDI) Edit Pgm change table
↓ PGM ↑ PGM 1= I00(Strings 1) >EXIT
```

You can press the below ">EXIT" to return to the previous display.

■ Function

Edit the program change table.

■ Explanation

The program change number is displayed on the left of the "=", and on the right side, the V50 voice or performance number is displayed.

Press the below the up/down arrows in the display to select the program change number (displayed at left), and specify the voice number which it will select (displayed at right). Use **[INT]**, **[CARD]**, or **[PRESET]** to select internal, card, or preset voices. To select performances, press **[PERFORMANCE]** while pressing **[INT]**, **[CARD]**, or **[PRESET]**.

In this way, set a voice or performance to be selected by each incoming program change.

Program change transmit

This is not actually a utility function, but we will explain it here. This allows you to transmit a program change message from MIDI OUT without affecting the V50.

When in performance play mode or single play mode, press and hold **[PERFORMANCE]** or **[SINGLE]**, and the display will show "Sending Pc No.---". Continuing to press the key, use the **[0]** - **[9]** keys to enter a three-digit (001-128)

program change number. The specified program change will be sent on the specified transmit channel at the instant you release **[PERFORMANCE]** or **[SINGLE]**.

Exclusive message (device number)

Press **[MIDI]**, and press the below ">Exclusive" to get the following display.

```
UT MIDI) Device No.
1 >Bulk >EXIT
```

You can press the below ">EXIT" to return to the previous display.

■ Function

Set the MIDI channel on which to receive and transmit system exclusive messages.

■ Settings

off, 1-16, all

■ Explanation

This sets the MIDI channel on which system exclusive messages (data for voices and performances, etc.) will be transmitted and received. Select one of the following.

off..... Exclusive messages will not be transmitted.

1-16... Exclusive messages will be transmitted on the channel specified here. (The next section explains the actual transmission.)

all..... Exclusive messages of any channel will be received. Channel 1 will be used for transmission.

Note:

When this is "off", exclusive messages will not be transmitted, and when a V50 voice is selected, a program change message will be transmitted.

The device receiving the exclusive message must be set to match the channel specified here.

When this is off, the following Bulk Dump display will not display.

Exclusive message (bulk dump)

Press **[MIDI]**, press the below ">Exclusive", and press the below ">BULK" to get the following display.

```
UT DUMP) BULK DUMP      Select one !
          VOICE PFM SETUP SEQ RHY >EXIT
```

Press the below "> EXIT" to return to the previous display.

■ **Function**

Transmit exclusive messages.

■ **Settings**

VOICE, PFM, SETUP, SEQ, R.SEQ

■ **Explanation**

The selected type of exclusive message will be transmitted. Select one of the following five.

VOICE Transmit voice data. After selecting this, select internal, preset, or card, and specify the range of voices to be transmitted (00-24, 25-49, 50-74, 75-99, or ALL to transmit voices 0-99).

PFM Transmit performance data. After selecting this, select internal, preset, or card, and specify the range of performances to be transmitted (00-24, 25-49, 50-74, 75-99, or ALL to transmit performances 0-99).

SETUP Transmit setup data. After selecting this, select the type of setup data to be transmitted. The table on page 96 explains the various types of setup data.

SEQ Transmit sequence data. After selecting this, select the type of sequence data to be transmitted (sequence all, sequence data, sequence setup).

R.SEQ Transmit rhythm data (pattern data, song data). After selecting this, select the type of rhythm data to be transmitted (rhythm all, rhythm sequence, rhythm setup).

When you have selected the type of data to be transmitted, the display will show "Transmit ready?"

When you press +1 an exclusive message of the specified data will be sent.

DISK FUNCTIONS

About the disk

Unlike a memory card, a single disk can contain many different types of data, and many different sets of each type.

A newly-purchased disk must be formatted before it can be used (see page 108).

Note:

Formatting a disk will erase all the data it contained. Be careful not to format a disk that contains valuable data.

The V50 uses 3.5" 2DD disks. (It cannot use 3.5" 2D or 2HD disks.) Be sure to use the correct type of disk.

Disks have a write protect slider located at the lower left. When this slider is on (the window is open), writing data or formatting is not possible. Leave this slider on when you want to keep valuable data from accidentally being erased.

Save

You can save various types of data to disk. The procedure is as follows.

Note:

Disks that have not been formatted cannot be used. If the write protect slider is on, data cannot be saved.

- (1) Insert the disk into the disk drive. (Newly-purchased disks must be formatted before they can be used to save data.)
- (2) Press **[DISK]** to get the following display.

```
UT DISK)          Select one !
>Save>Load>Del  >Rename  >MDR >Dir >Job
```

- (3) Press the below "> Save" to get the following display.

```
UT DISK) SAVE Select one !
ALL SYN SEQ R.SEQ CARD >EXIT
```

You can press the below "> EXIT" to return to the previous display.

- (4) Press a to select one of the following types of data to save.

ALL..... Save synthesizer data (internal voice, internal performance, setup), sequencer data (all songs, setup), and rhythm machine data (pattern, song, setup) to disk.

SYN..... Save only synthesizer data to disk.

SEQ Save only sequencer data (a single song) to disk.

R.SEQ Save all data of the rhythm machine.

CARD Save all data from the specified bank of the currently inserted card to disk.

You will then get the following display. (The "ALL" display will differ according to the data that was selected.)

```
UT DISK) SAVE ALL Set name & Push GO
>File 01 NewFile (ALL) + + >GO
```

- (5) Select a file number, and set a file name for the data you are saving. Page 17 explains how to enter characters.

If you want to write over (replace) an already existing file, move the cursor to "> File", and select the file by number.

- (6) Press the below "> GO" and you will get a message "Are you sure?", and if the disk is near the limit of its capacity, you will get a warning message. If so, select "> EXIT".
- (7) Press **[+1]** and the specified data will be saved to a file on disk. An indication of the free space on disk (in kilobytes) will be displayed.

Load

Load previously saved data from disk using the following procedure.

Note:

When memory protect (internal) is on, you will get a message of "Memory Protected", and will not be able to load. (SEQ and CARD are exceptions to this.)

When you execute load, the data in internal memory (of the type that is being loaded) will be erased. Be sure to check before loading.

- (1) Insert the disk into the disk drive.
- (2) Press **[DISK]** to get the following display.

```

UT DISK)          Select one !
>Save>Load>Del  >Rename  >MDR >Dir >Job

```

- (3) Press the below "> Load" to get the following display.

```

UT DISK) LOAD Select one !
ALL SYN SEQ R.SEQ CARD >EXIT

```

You can press the below ">EXIT" to return to the previous display.

- (4) Press a to select one of the following types of data to load.

ALL..... Load synthesizer, sequencer, and rhythm machine data from disk.

SYN..... Load only synthesizer data from disk.

SEQ Load a sequencer song from disk into the currently selected song memory.

R.SEQ Load only rhythm machine data (pattern, song) from disk.

CARD Load all data from disk into the currently inserted card. Remember that this will erase all the data that was previously in the card.

Be sure to select the same type of data as when you saved. For example, if you saved "ALL" data to a disk file, it is not possible to load only the synthesizer data from that file.

You will then get the following display. (The "ALL" display will differ according to the data that was selected.)

```

UT DISK) LOAD ALL Sel file & push GO
File 01 :SunShine(ALL) 20K >GO >EXIT

```

This cannot be executed if the card memory protect is on.

- (5) Select the file to load into memory. The name of the selected file will be displayed.
- (6) Press the below ">GO" and you will get a message of "Are you sure?".
- (7) Press +1 and the specified data file will be loaded from disk into the V50's memory.

Delete

This function deletes a disk file. The procedure is as follows.

Note:

If the disk's memory protect switch is on, it is not possible to delete.

- (1) Insert the disk into the disk drive.
- (2) Press DISK to get the following display.

```

UT DISK)          Select one !
>Save>Load>Del  >Rename  >MDR >Dir >Job

```

- (3) Press the below ">Del" to get the following display.

```

UT DISK) DELETE Select one !
ALL SYN SEQ R.SEQ CARD >EXIT

```

You can press the below ">EXIT" to return to the previous display.

- (4) Press a to select the type of data to delete. Be sure to select the same type as when you saved the data. For example if you saved "ALL" data to a disk file, it is not possible to delete only the synthesizer data from that file.

You will then get the following display. (The "ALL" display will differ according to the data that was selected.)

```

UT DISK) DELETE ALL Sel file & push GO
File 01 :SunShine(ALL) 20K >GO >EXIT

```

- (5) Select the file to be deleted. The name of the selected file will be displayed.
- (6) Press the below ">GO" and you will get a message of "Are you sure?".
- (7) Press +1 and the specified file of data will be deleted.

Rename

This changes the name of a disk file. The procedure is as follows.

Note:

If the disk's memory protect switch is on, it is not possible to rename.

- (1) Insert the disk into the disk drive.
- (2) Press **DISK** to get the following display.

```
UT DISK)          Select one !
>Save>Load>Del  >Rename  >MDR >Dir >Job
```

- (3) Press the below ">Rename" to get the following display.

```
UT DISK) RENAME  Select one !
ALL SVN SEQ R.SEQ  CARD  >EXIT
```

You can press the below ">EXIT" to return to the previous display.

- (4) Press a to select the type of data in the file to rename.

You will then get the following display. (The "ALL" display will differ according to the data that was selected.)

```
UT DISK) RENAME ALL Set name & Push GO
#File 01 >SunShine(ALL) ← → >GO
```

- (5) Select the file to be renamed, and modify the filename. (Page 17 explains how to enter characters.)
- (6) Press the below ">GO" and you will get a message of "Are you sure?".
- (7) Press **+I** and the specified file will be renamed.

MDR

The MDR (MIDI data recorder) function allows you to save (In) or load (Out) any type of MIDI bulk data (voice data, sequence data, etc.) as a disk file on the V50 disk.

Press **DISK**, and then press the below ">MDR" to get the following display.

```
UT DISK) MDR      Select one !
>In  >Out >Del >Rename >IntTime >EXIT
```

The first steps of MDR operation are the same as when saving (In) and loading (Out) other V50 data. (However there is no selection of the type of data.) MDR disk files can also be deleted or renamed.

MDR functions use the V50 internal memory, and sequencer data will be cleared. Before beginning MDR operations, save any important sequencer and rhythm data to disk or card.

(1) In (receive MIDI data from an external device and save it to disk).

For the first steps of the MDR procedure, follow the steps explained for saving (see page 105). Specify the file name and press the below ">GO" to get the "Are you sure?" message. For the remaining steps, use the following procedure.

- (1) In response to the "Are you sure?" message, press **+I**.
- (2) The V50 will wait for data to arrive.
- (3) Operate the external device to transmit the desired MIDI data.
- (4) When transmission is over, press the below ">GO".
- (5) The received data will be saved to disk.

(2) Out (load MIDI data from disk and transmit it to an external device)

The procedure is the same as explained for loading from disk (see page 105).

Note:

MDR data will be transmitted on the same channel as it was received, so set the receiving device to the appropriate channel number.

Reception can continue until the internal memory (64K byte) is full.

IntTime (interval time)

The "IntTime" (interval time) setting adjusts the speed at which MDR data is transmitted. Press the below ">IntTime" to get the following display.

```
UT DISK) MDR
Interval Time = 1 x 100 ms >EXIT
```

When transmitting MDR data, the time you specify here as "1 x 100ms" will be inserted as a waiting interval between every 1kB and every block of data transmitted. If the external device has difficulty receiving the data correctly, set a longer interval time, and try again.

Directory

This allows you to see the number and names of files on a disk. The procedure is as follows.

- (1) Insert the disk into the disk drive.
- (2) Press **[DISK]** to get the following display.

```
UT DISK)      Select one !
>Save>Load>Del >Rename  >MDR >Dir >Job
```

- (3) Press the below ">Dir" to get the following display.

```
UT DISK) DIRECTORY      Total: 52 Files
▶File 01 :SunShine(ALL)  20K      >EXIT
```

You can press the below ">EXIT" to return to the previous display.

- (4) Select the file number to view the file name and file size. The upper line shows the total number of files on disk. The "ETC" shown in () indicates files that were saved by a device other than the V50.

Format

This function formats a disk. Newly-purchased disks must be formatted before they can be used. You can also use this format function to erase all the files on a disk. The procedure is as follows.

Note:

Formatting will erase all the data on the disk. Formatting is not possible if the disk's write protect slider is on the "on" position.

- (1) Insert the disk into the disk drive.
- (2) Press **[DISK]** to get the following display.

```
UT DISK)      Select one !
>Save>Load>Del >Rename  >MDR >Dir >Job
```

- (3) Press the below ">Job" to get the following display.

```
UT DISK)      Insert DISK and select one !
>Format  >Backup  >Status  >EXIT
```

You can press the below ">EXIT" to return to the previous display.

- (4) Press the below ">Format" to get the message "Are you sure?"

- (5) Press **[+1]** and formatting will begin. (Formatting takes approximately 1 minute and 10 seconds.)

Backup

This function copies an entire disk to another disk, making a backup copy.

It is important to make backup copies of your disks to avoid losing important data.

Note:

Backup works by repeating the following three steps.

- (1) Read the original disk (source).
- (2) Store the data in V50 internal memory.
- (3) Write the data to the duplicate disk (copy).

As you can see from step (2), the backup function uses the V50 sequencer and rhythm pattern internal memory. When you use the backup function, sequence data, and rhythm pattern and rhythm song data will be lost. Before using the backup function, be sure to store important sequence and rhythm data to disk.

The duplicate disk must already be formatted.

All the old data in the duplicate disk will be erased.

- (1) Press **[DISK]** to get the following display.

```
UT DISK)      Select one !
>Save>Load>Del >Rename  >MDR >Dir >Job
```

- (2) Press the below ">Job" to get the following display.

```
UT DISK)      Set DISK and select one !
>Format  >Backup  >Status  >EXIT
```

You can press the below ">EXIT" to return to the previous display.

- (3) Press the below ">BackUp" to get the message "*** SEQ/R.SEQ data will be cleared. Sure?".
- (4) Press **[+1]** to get the message "*** Set original disk & push **[YES]**".
- (5) Insert the original disk (source) into the disk drive.
- (6) Press **[+1]**. After a while you will get the message "*** Set duplicate disk & push **[YES]**".
- (7) Insert the duplicate disk (copy) into the disk drive.
- (8) Press **[+1]**. After a while you will get the message "*** Set original disk & push **[YES]**".

The upper line of the display will show the percentage of the total disk that has been copied.

Repeat steps (5) – (8) until backup is completed.

When backup is completed, you will get the message “Backup completed !”

Status

This allows you to check the condition of the disk. The number of files, total used bytes, and total remaining bytes will be displayed.

- (1) Insert the disk into the disk drive.
- (2) Press **DISK** to get the following display.

```
UT DISK>          Select one !
>Save>Load>Del  >Rename  >MDR >Dir >Job
```

- (3) Press the below “>Job” to get the following display.

```
UT DISK>  Insert DISK and select one !
>Format  >Backup  >Status  >EXIT
```

You can press the below “>EXIT” to return to the previous display.

- (4) Press the below “>Status” to get a display like the following.

```
UT DISK> STATUS
Total=52files, Used= 50K,Free=663K >EXIT
```

The lower line shows the number of files on disk, total used bytes, and total remaining bytes.

MEMORY PROTECT

Memory protect (internal, card)

Press **MEMORY PROTECT** to get the following display.

```
UT MEMORY PROTECT>  ▶INT      >CARD
                    off       on
                    └(1)┘     └(2)┘
```

Memory protect keeps internal and card memory from being accidentally written over and lost.

(1) Internal

■ Function

Protect setting for internal memory.

■ Settings

off, on

■ Explanation

This turns internal memory protect on/off. When set to “on”, voice or performance data cannot be stored to internal memory, nor can card, disk, or MIDI data be loaded into memory. When the power is turned on, this will be set “on”.

(2) Card

■ Function

Protect setting for card memory

■ Settings

off, on

■ Explanation

This turns card memory protect on/off. When set to “on”, voice or performance data cannot be stored to card memory, nor can internal data be saved into card memory. When the power is turned on, this will be set “on”.

Note:

The card itself also has a memory protect switch. If the card switch is on, data cannot be saved even if this the card memory protect is turned “off”.

SETUP FUNCTIONS

Master tuning, synthesizer volume

Press **[SETUP]**, then press the below ">Tune" to get the following display.

```
UT  SETUP) ▶Master Tuning >Synth Vol
                +0 (440.0Hz)  90      >EXIT
```

(1) (2)

You can press the below ">EXIT" to return to the previous display.

(1) Master tuning

■ Function

Set master tuning.

■ Settings

-64 — +64

■ Explanation

Master tuning affects the entire V50 in both performance play mode and single play mode. In performance play mode this will adjust the overall tuning of all instruments.

The setting can be adjusted over a range of approximately one half step up or down. At a setting of 0, A3 will be 440.0Hz. A setting of -64 is -100 cents (one half step down), and a setting of +64 is 98.4 cents (approximately one half step up).

This function allows you to tune the V50 to instruments that are not tuned to A3 = 440Hz.

(2) Synthesizer volume

■ Function

Set the synthesizer volume.

■ Settings

0 - 99

■ Explanation

This is used to adjust the volume balance between the synthesizer section and the rhythm machine. 0 is minimum volume, and 99 is maximum volume.

Note:

At a setting of 0, you will not be able to hear the synthesizer.

Combine

Press **[SETUP]**, then press the below ">Comb" to get the following display.

```
UT  SETUP) ▶Combine(with FUNCTION)
                on                      >EXIT
```

You can press the below ">EXIT" to return to the previous display.

■ Function

Disconnect function data from a voice.

■ Settings

off, on

■ Explanation

Each voice data setting is actually divided into two types of data; voice data and function data. The voice data determines the sound of the voice, and the function data determines how the voice is controlled. This combine function disconnects the function data from the rest of the voice data.

When function data is disconnected, selecting a different voice will change only the voice data, preserving the previous function data. This allows you to change only the voice while preserving the settings (modulation wheel, aftertouch, foot controller, effect etc.) that determine how it is controlled.

"on" is the usual setting, when function data is not disconnected. When set to "off", function data is disconnected.

This setting also applies to performance mode, and the voice function data and effect data will be preserved even when a different performance is selected. If you set combine "off" and select a different voice or performance, the first character of the voice or performance name will be displayed in lower case to indicate that the function settings of the previously selected voice are being used.

Controller reset

Press **[SETUP]**, then press the below ">Ctrl" to get the following display.

```
UT  SETUP) ▶Controller Reset
                hold                      >EXIT
```

You can press the below ">EXIT" to return to the previous display.

■ Function

Determine controller reset condition.

■ Settings

hold, reset

■ Explanation

Controller reset determines the condition of the controllers (modulation wheel, pitch bend wheel, breath controller, foot controller, etc.) when a voice or performance is selected.

For example, if you advance the modulation wheel and then select a different voice or performance, this setting determines whether the newly selected voice or performance will be affected by the modulation wheel.

When this is set to "hold", the previous controller data will be apply to the newly selected voice or performance. When this is set to "reset", the controller data will be initialized regardless of the actual controller position whenever a voice or performance is selected, and the newly selected voice will have no modulation wheel effect. However, the instant you move the modulation wheel even slightly, the modulation wheel effect used by the newly selected voice or performance will immediately be applied.

Performance effect (delay)

This sets the delay performance effect. The delay effect adds additional, delayed notes of the same (or different) pitch as the originally played note.

The V50 has memory for four independent settings of the performance delay effect; Delay1, Delay2, Delay3, and Delay4.

This effect can be used in single play mode only while editing the performance delay.

To use this effect in performance play mode, set the performance effect selection in (OTHERS) to "Delay1" - "Delay4".

Settings can be copied from one performance delay memory to another (see page 120).

Each performance delay memory has the following four settings.

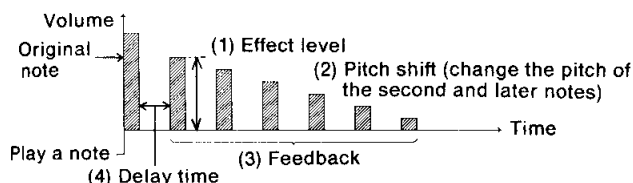

Note:

Only one out of the twelve performance effects (delay 1 - 4, pan 1 - 4, chord 1 - 4) can be used at one time.

The delay effect is effective for up to four notes. If you play four notes, the fourth note will have the correct delay effect. However the instant you play the fifth note, the delay note of the first played note will disappear.

In performance play mode, the delay effect will apply only to the first instrument in the performance. (Usually instrument 1.)

The actual number of feedback repeats will depend on key velocity and the effect level.

If the velocity sensitivity of the carrier operator is 0, the effect level will not equal the original level even if the effect level is set to 99.

Press **SETUP**, press the below ">P.Efct", and press the below "delay" to get the following display.

```

UT SETUP>  ▶EDIT DELAY  Select one !
delay1     delay2     delay3     delay4>EXIT

```

You can press the below ">EXIT" to return to the previous display.

Select the delay you wish to set (delay1 - delay4). For example, if you press the below "delay1", you will get a display like the following.

```

UT DELAY1> ▶DelayTime >PitchShift
              1.28sec      +0 >NEXT>EXIT
              (1)         (2)

```

In addition, if you press the below ">NEXT" you will get a display like the following.

```

UT DELAY1> ▶Feedback >EffectLevel
              6          90 >NEXT>EXIT
              (3)         (4)

```

If you press the below ">NEXT" once again, you will return to the previous display.

(1) Delay time

■ Function

Set the delay time.

■ Settings

0.01 - 1.28

■ Explanation

This is the time from when the original note sounds to when the first delay note sounds. Set the delay time over a range of 0.01 – 1.28 seconds.

(2) Pitch shift

■ Function

Set the pitch shift.

■ Settings

-24 – +24

■ Explanation

If this setting is other than 0, the second and later notes will each be higher or lower by the specified amount. With a setting of 0, each delay note will be the same pitch. With a setting of -1 – -24 the delay notes will descend, and with a setting of +1 – +24 the delay notes will ascend.

For example, if this setting is +2, the delay notes will ascend the whole-tone scale.

(3) Feedback

■ Function

Set the feedback.

■ Settings

0 – 7

■ Explanation

Feedback regulates the number of delay repetitions. Larger settings will cause more repetitions. The actual number of repetitions will depend on the key velocity of the note (the force with which the note is played), and the effect level.

(4) Effect level

■ Function

Set the effect level.

■ Settings

0 – 99

■ Explanation

Set the delay level in relation to the original sound. With a setting of 0, the delay volume will be 0 (no delay effect), and with a setting of 99, the delay will approximately the same volume as the original sound. (Only if the key velocity sensitivity of the carrier operators is other than zero.)

Performance effect (pan)

This programs another one of the performance effects; pan. When the L and R outputs are connected to a stereo system or to two amps, this pan effect causes the sound to move between the left and right outputs. (You can also hear this effect through headphones.)

The V50 has memory for four independent settings of the performance pan effect; pan1, pan2, pan3, and pan4.

This effect can be used in single play mode only while editing the performance delay.

To use this effect in performance play mode, set the performance effect selection in (OTHERS) to "Pan1" – "Pan4".

Settings can be copied from one performance pan memory to another (see page 120).

Each performance pan memory has the following three settings.

Note:

Only one out of the twelve performance effects (delay 1 – 4, pan 1 – 4, chord 1 – 4) can be used at one time.

When using this in single play mode, the maximum simultaneous notes will be set to eight notes.

In performance play mode, the pan effect will apply only to instruments whose **TR8** (OUTPUT ASSIGN) setting is either L or R. (The pan effect will not apply to instruments whose output assign setting is "L+R".)

When the effect parameter Stereo Mix is off, and effect select is not off, then Performance Pan will have no effect. Also, with some settings, the pan effect will be difficult to notice.

Press **SETUP**, press the below ">P.Efct", and press the below "pan" to get the following display.

```
UT SETUP)  ▶EDIT PAN   Select one !
pan1      pan2      pan3      pan4)EXIT
```

You can press the below ">EXIT" to return to the previous display.

Select the pan memory you wish to set (pan1 – pan4). For example if you press the below "pan1", you will get a display like the following.

```
UT PAN1)  ▶Select >Direction>PanRange
          LFO      L→R      99 >EXIT
```

(1) (2) (3)

(1) Select

■ Function

Select the type of pan effect.

■ Settings

LFO, VEL, NOTE

■ Explanation

Select one of the following three types of pan effect.

LFO Use a vibrato generator to move the sound left and right.

Vel..... Move the sound left or right depending on the key velocity.

Note Move the sound left or right depending on the note pitch.

(2) Direction

■ Function

Select the direction of pan movement.

■ Settings

L→R, L←R

■ Explanation

The effects will differ according to the setting made for "select".

When LFO is selected

If the **TR3** (LFO) of the voice is set to Sync=on, selecting "L→R" will make the sound begin from the left side. Selecting "L←R" will make the sound begin from the right side.

If Sync=off, the "L←R" or "L→R" setting will not make much difference.

When Vel is selected

When "L→R" is selected, lightly played notes will be toward the left, and strongly played notes will be toward the right. When "L←R" is selected, the opposite will be true.

When Note is selected

When "L→R" is selected, lower notes will be toward the left, and higher notes will be toward the right. When "L←R" is selected, the opposite will be true.

Note:

If you play several keys at once in single play mode, the position of the sound will be determined by the velocity or pitch of the first note.

In performance play mode, the position of the sound will be determined by the velocity or pitch of the first note of the lowest-numbered instrument that is being played.

(3) Pan range

■ Function

Set the depth of the pan effect.

■ Settings

0-99

■ Explanation

This determines the depth of the pan effect. A setting of 0 will be no effect, and 99 is maximum effect.

Performance effect (chord)

This sets the "chord" performance effect. The chord effect allows you to sound up to four notes by playing a single key.

The V50 has memory for four independent settings of the performance chord effect; chord1, chord2, chord3, and chord4.

This effect can be used in single play mode only while editing the performance delay.

To use this effect in performance play mode, set the performance effect selection in (OTHERS) to "chord1" - "chord4".

Settings can be copied from one performance chord memory to another (see page 120).

Note:

Only one out of the twelve performance effects (delay 1-4, pan 1-4, chord 1-4) can be used at one time.

In performance play mode, the chord effect will apply only to the lowest-numbered of the instruments that are sounding.

A chord can be set for each of the twelve keys in the C3-B3 octave. Each chord can include notes of any octave.

Press **SETUP**, press the below ">P.Efct", and press the below "chord" to get the following display.

```
UT SETUP)  EDIT CHORD  Select one !
chord1    chord2    chord3    chord4)EXIT
```

You can press the below ">EXIT" to return to the previous display.

Now select the chord you want to edit (chord1 - chord4). For example if you press the below "chord1", you will get a display like the following.

```
UT CHORD1)  C3 is .....  >KBD
+ key +    C3/ E3/ * / *  in >EXIT
```

The upper line of the display shows the key (C3 in this example) for the chord you are setting. The lower line shows the notes that will be played when you press the specified key. For example, in the next example if you pressed C3, the notes E3 and G3 would sound.

```
UT CHORD1) C3 is ..... >KBD
← key → ▶ C3/ E3/ G3/ * in >EXIT
```

Use the below “←” and “→” to select the key in the upper line. Use the data entry slider or to modify the notes in the lower line. Also, after selecting the key in the upper line, move the cursor to “>KBD”, and the chord you play on the keyboard will be set as the chord in the lower line.

Repeat this to set a chord for each of the twelve keys C3 – B3.

Note:

When a preset or card performance is selected, modifying a performance effect parameter will only affect the internal data, so the effect will not change. When you want to change these settings for preset or card performances, temporarily store that performance to internal memory before changing the effect settings.

About microtuning

Microtuning allows you to specify the pitch of each note. Normally, most music of today divides the octave into twelve steps. This is known as equal temperament. There are many other temperaments, and most music of previous centuries was written using one of these other temperaments. Also, 20th century music sometimes divides a half-step into two or even four smaller intervals.

The V50 has 11 preset tunings including equal temperament. In addition, two user memories are provided for you to create your own temperaments.

The 11 preset tunings are shown on page 29.

To use a micro tuning in single play mode, enter the micro tuning edit function we will be explaining in this section.

To use a micro tuning in performance play mode, set the (OTHERS) micro tuning select to the temperament you want to use.

The following two user micro tunings are provided.

(1) Octave

Set the pitch for the twelve notes C3 – B3. Other octaves will automatically be adjusted to the same relative pitch steps.

(2) Full keyboard

Set the pitch for each note C-2 – G8 in the MIDI note range. (This is a broader range than the V50 61- note keyboard covers.)

Note:

The micro tuning you set will be remembered even when the power is turned off. However only two memories are provided for your own original micro tunings (one “octave”, one “full”). If you want to create more tunings than this, you will have to save the data for each to a card (see page 97).

Microtuning (octave edit)

This is where you set the pitch for each of the twelve notes C3 – B3. Other octaves will be automatically adjusted to the same relative pitch steps.

If desired, you can use the initialization function explained next to initialize the user octave microtuning to one of the 11 presets, and then use this octave edit function to adjust the data as needed.

Press STEP, press the below “>Micro”, then press the below “OCT. Edit” to get the following display.

```
UT MICRO) OCT. C3 key set
▶CRS >FINE C3 +10( 3018) ← → >EXIT
```

The note in the center of the upper row is the note whose pitch you are specifying. The center of the lower row shows the actual pitch that is produced when you play that note. For example, in the above display, the pitch produced when the note “C3” is played will be + 10 steps above the “C3” of equal temperament. One step is 1/64th of a note (1.5625 cents). The parentheses show the pitch of the note in steps starting from C#-1.

When the cursor is at “CRS”, modify the note name in the lower line. When the cursor is at “FINE”, increase or decrease the step units in the lower line.

To change the note displayed in the upper line, press a key C3 – B3 on the keyboard, or press the below “←” or “→”.

Microtuning (octave initialize)

To simplify creating your own octave micro tuning, this function allows you to copy a preset micro tuning into the user octave micro tuning memory. You can then modify it as desired.

Press **[SETUP]**, press the below "> Micro", then press the below "OCT. Init" to get the following display.

```
UT  MICRO> INIT      ▶Table      >key
>GO                2:Pure(major)  C  >EXIT
```

Select the micro tuning to initialize to. (If necessary, specify the tonic.) Then press the below "yes". Press **[+1]**, and the user octave tuning will be initialized.

Microtuning (full keyboard edit)

This is where you set the pitch for each of the note in the MIDI note range C-2 – G8.

If desired, you can use the initialization function explained next to initialize the user full keyboard microtuning to one of the 11 presets, and then use this full keyboard edit function to adjust the pitch for each note as needed.

Press **[STEP]**, press the below "> Micro", then press the below "FULL Edit" to get the following display.

```
UT  MICRO> FULL.  C-2      key set
▶CRS >FINE  C#1 +10( 10) ←  → >EXIT
```

The note in the center of the upper row (C-2 in the above example) is the key whose pitch you are specifying. The center of the lower row shows the actual pitch that is produced when you play that key. For example in the above display, the pitch produced when the key "C-2" is played will be +10 steps above the "C#-1" of equal temperament. One step is 1/64th of a note (1.5625 cents). The parentheses show the pitch of the note in steps starting from C#-1.

When the cursor is at "CRS", modify the note name in the lower line. When the cursor is at "FINE", increase or decrease the step units in the lower line.

To change the note displayed in the upper line, press a key on the keyboard, or press the below "←" or "→".

Microtuning (full keyboard initialize)

To simplify creating your own full keyboard micro tuning, this function allows you to copy a preset micro tuning into the user full keyboard micro tuning memory. You can then modify it as desired.

Press **[SETUP]**, press the below "> Micro", then press the below "FULL Init" to get the following display.

```
UT  MICRO> INIT      ▶Table      >key
>GO                2:Pure(major)  C  >EXIT
```

Select the micro tuning to initialize to. (If necessary, specify the tonic.) Then press the below "GO". Press **[+1]**, and the user octave tuning will be initialized.

Velocity (fixed velocity, velocity curve)

Press **[SETUP]**, and press the below "> Vel" to get the following display.

```
UT  SETUP>▶FixedVelocity >VelCurve
                                127      0(norm) >EXIT
                                (1)      (2)
```

You can press the below "> EXIT" to return to the previous function.

(1) Fixed velocity

■ Function

Set a fixed velocity for every note.

■ Settings

off, 1 – 127

■ Explanation

This sets the velocity produced when a key is pressed. Normally, it will be set to "off", and the velocity of a note will be determined by how strongly it is played.

However, setting this to a value of 1 – 127 will make each note produce velocity specified here, regardless of how strongly the key was actually played.

(2) Velocity curve

■ Function

Set a curve for velocity response.

■ Settings

0 – 7

■ Explanation

This setting determines how velocity values will change in response to stronger or softer playing. Higher settings in the range of 0 – 5 will produce higher velocity even in response to softer playing. (I.e., a setting of 5 would be the most "sensitive".) A setting of 6 is a nearly flat curve, but the maximum velocity will be 80. A setting of 7 is reverse velocity (the stronger you play, the lower the velocity becomes). When power is turned on, 0 (norm) is selected.

Damp (EG forced damp, voice damp)

Press **SETUP**, then press the below "> Damp" to get the following display.

```
UT  SETUP>  EG Damp  >Voice Damp
           fast      on      >EXIT
           (1)      (2)
```

You can press the below "> EXIT" to return to the previous display.

(1) EG forced damp

■ Function

This determines how notes beyond the maximum polyphony will be handled.

■ Setting

veryslow, slow, medium, fast

■ Explanation

When an instrument in performance play mode receives more notes than allowed by its maximum notes setting, or when more than 16 notes are received in single play mode, this setting determines how the overflowing notes will be handled.

For example, in single play mode when the 17th note is received, the oldest note will be turned off. This EG forced damp determines how quickly the oldest note will be turned off.

When EG forced damp is "fast"

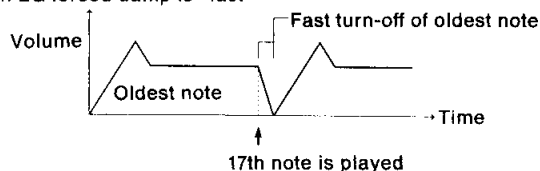

When EG forced damp is "very slow"

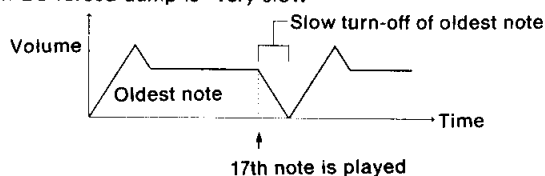

A setting of "fast" takes the shortest time to turn off the oldest note, and a setting of "veryslow" takes the longest time.

As you can see from the diagram, EG forced damp reduces the click noise produced when a note is turned off instantly. The longer the setting, the less noise there will be. However sounds with a quick attack (piano, organ, etc.) will sound rather unnatural with a long forced damp setting, since the notes will begin perceptibly later than they should. In such cases, set EG forced damp to "fast".

(2) Voice damp

■ Function

Determine if notes will continue to sound through a voice change when in single mode.

■ Settings

off, on

■ Explanation

When "on" is selected, notes sounding when a voice is selected will be turned off. When "off" is selected, notes will continue to sound, and the newly selected voice will be used for the next note. However, LFO and effect data will change at the instant the voice is selected.

OTHER FUNCTIONS

Voice initialize

From single play mode or voice edit mode, press **[OTHERS]** to get the following display.

```
UT OTHERS> VOICE          Select one !
>Init >Recall             >PresetLoad
```

■ Function

Initialize a voice.

■ Explanation

This function sets a voice to an initial state, with settings at maximum or minimum, producing the simplest possible sound.

Press the below "> Init" to get the message "Are you sure?". Press **[+1]** and the voice will be initialized.

Note:

The voice function data will be initialized even if the combine setting is "off".

Performance initialize

From performance play mode or performance edit mode, press **[OTHERS]** to get the following display.

```
UT OTHERS> PFM          Select one !
>Init >Recall >VoiceEdit >PresetLoad
```

Press the below "> Init" to get the following display.

```
UT OTHERS> PFM  INIT  Select one !
SNGL DUAL SPLT 4LYR 8LYR SEQ4 SEQ8 >EXIT
```

You can press the below "> EXIT" to return to the previous display.

■ Function

Initialize a performance.

■ Explanation

You can initialize to one of the following seven types.

SNGL..... Just a single instrument

DUAL..... Two instruments sounding together

SPLT..... Two instruments split at B2/C3

4LYR..... Four instruments sounding together

8LYR..... Eight instruments sounding together

SEQ4..... Setting for playing four instruments from the sequencer

SEQ8..... Setting for playing eight instruments from the sequencer

Page 125 shows the initial settings for each of these. Press a below the desired initialization setting, and you will be asked "Are you sure?". Press **[+1]** and the performance will be initialized.

Voice recall

From single play mode or voice edit, press **[OTHERS]** to get the following display.

```
UT OTHERS> VOICE          Select one !
>Init >Recall             >PresetLoad
```

■ Function

Recall a voice.

■ Explanation

This function recalls the voice you were most recently editing. This is especially useful when, while editing a voice, you select another voice by mistake before saving your edited voice.

Press the below "> Recall" to get the message "Are you sure?". Press **[+1]** and the previously edited voice will be recalled.

Performance recall

From performance play mode or performance edit, press **[OTHERS]** to get the following display.

```
UT OTHERS> PFM          Select one !
>Init >Recall >VoiceEdit >PresetLoad
```

■ Function

Recall a performance.

■ Explanation

This function recalls the performance you were most recently editing. This is especially useful when, while editing a performance, you select another performance by mistake before saving your edited performance.

Press the below "> Recall" to get the message "Are you sure?". Press **[+1]** and the previously edited performance will be recalled.

Preset load

From single play mode, performance play mode, or voice or performance edit, press **[OTHERS]**. (The following example shows the voice display.)

```
UT OTHERS> VOICE          Select one !
>Init >Recall             >PresetLoad
```

Press the below ">PresetLoad" to get the following display.

```
UT OTHERS> PRESET LOAD   Select one !
ALL          PEFCT MCT   >EXIT
```

You can press the below ">EXIT" to return to the previous display.

■ Function

Load the preset performance effects and/or micro tunings.

■ Explanation

This loads the preset performance effects settings, and/or the preset micro tuning settings into internal user memory.

Select one of the following presets to load.

ALL..... Load performance effects and micro tunings.

PEFCT.... Load only performance effects.

MCT..... Load only micro tunings.

When you press a to select the preset, you will get a message "Are you sure?". Press **[+1]** and the preset will be loaded.

Note:

This function will erase all performance effect and micro tuning settings in internal user memory.

If internal user memory contains performance effect and micro tuning settings that you want to keep, save them to card or disk before using this function.

Voice edit

From performance play mode or performance edit, press **[OTHERS]** to get the following display.

```
UT OTHERS> PFM          Select one !
>Init >Recall >VoiceEdit >PresetLoad
```

■ Function

From editing a performance, jump to editing a voice.

■ Explanation

From performance editing, this allows you to instantly jump to edit one of the voices in the performance.

Press the below ">Voice Edit" to get the following display.

```
UT OTHERS> VOICE EDIT   which voice ?
I01/ I03/ I13/ */ */ */ */ *
```

Press a to select the voice you want to edit, and you will jump to voice editing mode. (However the upper left of the display will show "M1111" instead of the usual "E1111".)

You can repeat this to edit several voices of a performance at once.

Note:

If you edit a voice using this function and press **[SINGLE]** before storing the voice, you will get a message "*** go to SGL mode Sure?". If you now press **[+1]**, the voice being edited will return to the original data.

If you have edited voice data from this function, you will be able to individually store the modified voices (see page 119).

This mode is unlike normal single mode in the following ways.

- (1) EFCT edit and copy
- (2) compare mode
- (3) operator on/off

If you press a button other than an edit button, you will return to the above menu.

Note:

If you turn an instrument's MAX NOTES=0 while in multi-voice edit, the sound you are editing will disappear.

STORE FUNCTIONS

Voice store

From single play mode, press **STORE/COPY** to get the following display.

```
SINGLE MODE>
Mem Store I23 -> I ?
```

■ Function

Store a voice to internal or card memory.

■ Explanation

Store the currently selected voice as an internal voice or card voice.

While continuing to press **STORE/COPY**, specify the voice number to store.

Press **INT** or **CARD** to select internal or card memory. When you have input the store destination, release **STORE/COPY**. You will be asked "OK?", and when you press **+1** the voice will be stored.

Note:

When internal memory protect is on, the right edge of the display will show "Prot?" (protect), and by pressing the below it, you can temporarily defeat protect.

When card memory protect is on, or when the card memory protect slider is on, voices cannot be saved to card memory.

Voices cannot be stored in a card that has not been formatted.

Performance store

From performance play mode, press **STORE/COPY** to get the following display.

```
PERFORMANCE MODE>
PFM Store I04 -> I ?
```

■ Function

Store a performance to internal or card memory.

■ Explanation

Store the currently selected performance as an internal performance or card performance.

While continuing to press **STORE/COPY**, specify the performance number to store. Press **INT** or

CARD to select internal or card memory. When you have input the store destination, release **STORE/COPY**. You will be asked "OK?", and when you press **+1** the performance will be stored.

Note:

When internal memory protect is on, the right edge of the display will show "Prot?" (protect), and by pressing the below it, you can temporarily defeat protect.

When card memory protect is on, or when the card memory protect slider is on, performances cannot be saved to card memory.

Performances cannot be stored in a card that has not been formatted.

Voice store when using voice edit

When you have finished editing, press **OTHERS** and then **STORE/COPY** to get the following display.

```
UT OTHERS> STORE VOICE  which voice ?
i01/ i03/ I13/ */ */ */ */ *
```

■ Function

Store after using the voice edit function.

■ Explanation

You will get a blinking message "which voice?". While continuing to press **STORE/COPY**, press the below the voice you want to store. Specify the voice number destination, and release **STORE/COPY**. You will be asked "OK?", so press **+1**.

If you want to store other voices, repeat this procedure.

Note:

When the card memory protect slider is on, voices cannot be saved to card memory.

Voices cannot be stored in a card that has not been formatted.

If you have entered this function from internal performance, voices can be stored only in internal memory. If from card, only in card memory.

Storing using the voice edit function is possible only in the voice edit display.

COPY FUNCTIONS

Effect copy

While setting voice or performance (EFFECT) data, press **STORE/COPY** to get the following display.

```
EFFECT COPY>   EFCT=1:Reverb Hall
                current effect data -> I ?
```

■ Function

Copy effect settings between voices or performances.

■ Explanation

This function copies the effect settings of the currently selected voice or performance to another voice or performance.

While continuing to press **STORE/COPY**, specify the voice number or performance number copy destination. When you have input the store destination, release **STORE/COPY**. You will be asked "OK?", and when you press **+1** the effect settings will be stored to the specified voice or performance.

Note:

When internal memory protect is on, effects cannot be copied to internal memory.

When card memory protect is on, or when the card memory protect slider is on, effects cannot be copied to card memory.

Effects cannot be copied to a card that has not been formatted.

Single voice effects cannot be copied to a performance, nor vice versa.

Performance effect copy

While setting **SETUP** performance effects, press **STORE/COPY** to get the following display.

```
PFM EFFECT COPY>
                delay 1 --> delay ?
```

■ Function

Copy settings between each type of performance effect 1-4.

■ Explanation

This function copies the settings of the currently selected performance effect to another performance effect of the same type.

While continuing to press **STORE/COPY**, specify the copy destination, and then release **STORE/COPY**. You will be asked "OK?", and when you press **+1** the performance effect settings will be copied to the specified performance effect.

Note:

A performance effect can be copied only to another performance effect of the same type.

Envelope generator copy

While setting a voice's envelope generator, press **STORE/COPY** to get the following display.

```
EG COPY>   set source & destination OP !
            >OP? --> >OP?
```

■ Function

Copy envelope generator settings between operators.

■ Explanation

This function copies the following settings (envelope generator and keyboard scaling) from one operator to another operator.

Envelope generator data AR, D1R, D2R, RR
(SHIFT is not included)

Keyboard scaling data LS, RS

While continuing to press **STORE/COPY**, specify the copy source and destination, and then release **STORE/COPY**. When you specify the destination, the envelope generator settings will be copied between the specified operators.

COMPARE FUNCTIONS

Voice compare

While editing a voice, press **COMPARE**.

```
c1111 ALG)      4+3w      >Feedback(OP4)
▶ALG=4         2+1+      7
```

■ Function

Compare the edited and original versions of a voice.

■ Explanation

While editing a voice, press **COMPARE**. The “e” in the upper left of the display will change to a “c”, and you will be able to hear the voice as it was before you began editing.

Press **COMPARE** once again to return to the edited voice.

Note:

While compare is selected, editing is not possible. Nor is it possible to move to another mode. During compare, the LED at the left of **SINGLE** will light to indicate compare mode.

Performance compare

While editing a performance, press **COMPARE**.

```
c.ED ▶AssignMode  >name : SunLight
DVA                                     ← →
```

■ Function

Compare the edited and original versions of a performance.

■ Explanation

While editing a performance, press **COMPARE**. The “e” in the upper left of the display will change to a “c”, and you will be able to hear the performance as it was before you began editing.

Press **COMPARE** once again to return to the edited performance.

Note:

While compare is selected, editing is not possible. During compare, the LED at the left of **PERFORMANCE** will light to indicate compare mode.

APPENDIX

TROUBLESHOOTING

The V50 has a very large number of functions. Each one is closely related to the others, and one function can sometimes have an unexpected effect on another function. Another possibility is that the amp or mixer system is not operating correctly. This chapter will explain some difficulties you may encounter, and give possible reasons for them.

The following points will help you determine whether the problem is with the V50 itself, with the amp/speaker system, or with the audio and MIDI cables connecting the system.

- Plug a set of headphones into the V50 and listen for audio output.

If so, the problem is in the amp or mixer system, or in the cables used for connection.

- Check whether the problem occurs with other performances or voices.

If the problem occurs only with a specific performance or voice, the problem is in the performance or voice setting. If the problem occurs with all performances or voices, check the other settings (utility mode, etc.).

When you have a general idea of where the problem is, consult the following tables.

Problems in the amp, mixer, or audio cable

Problem	Possible reason	Page reference
No sound	Is the amp turned on?	—
	Is the amp (or mixer) volume up?	—
	Are the V50 outputs correctly connected to the amp inputs?	10
	Is the audio cable faulty?	—
Distorted sound	Is the V50 connected to the mic inputs?	10

Problems in the performance

Problem	Possible reason	Page reference
No sound	Are the maximum note settings correct?	24
	Do the MIDI receive and transmit channels match?	25, 99
	Is volume turned up for each instrument?	27
	Is the output assign for each instrument turned off?	27
	Are the high/low note limits for each instrument correct?	25
	Are the instruments turned off?	25

Problem	Possible reason	Page reference
Keys play the wrong pitch	Is note shift set to a non-zero value?	27
	Is detune set to a non-zero value?	26
	Are micro tuning settings correct?	28
Unsteady pitch	Are you using detuned instruments in alternate assign?	26
Can't play chords	Are the maximum note settings correct?	24
	Are you using a voice that is set to mono mode?	49

Problems in the voice

Problem	Possible reason	Page reference
No sound	Is the output level of the carrier operators turned up?	48
	Is a setting of the pitch envelope generator level PL1 – PL3 too low to hear?	47
	Is a foot controller controlling the volume (or volume pedal) at minimum position?	50
	Are breath controller and aftertouch EG bias set to high values?	52, 53
Keys play the wrong pitch	Is transpose set to a value other than midC = C3?	49
	Are the oscillator frequencies correctly set?	44
	Are the oscillators detuned?	44
Unsteady pitch	If LFO P Mode Sens. and P Mod Depth are set to high values, the resulting heavy vibrato will cause unsteady pitch.	43
	Is FC Pitch turned up although a foot controller is not connected?	50
	The normal pitch will sound if the pitch envelope generator PL1 – PL3 are all set to 50.	47
	Is the breath controller or aftertouch P.Bias set to a high value?	52, 53
	Is the portamento time set at maximum?	50
Can't play chords	Is mono mode selected?	49

Problems in other areas

Problem	Possible reason	Page reference
No sound	Is the fixed velocity set too low?	115
	Is the synthesizer volume at 0?	110
Some keys do not produce sound	Is note on/off set to odd or even?	101
Keys play the wrong pitch	Is the master tuning set at other than 0?	110
Can't use card performances or voices	Are the contents of the card bank correct?	95
	Is the correct bank selected?	95

Problems with the sequencer

Problem	Possible reason	Page reference
Sequencer does not make sound	Is the synthesizer volume raised?	110
	Are the TR1 – TR8 LEDs lit?	87
	Do the transmit channels of each track match the receive channels of the synthesizer?	25, 90

Problems with the rhythm machine

Problem	Possible reason	Page reference
Rhythm machine does not make sound	Is the rhythm machine volume raised?	77

Preset voices

The V50's preset memory contains the following voices.

00	Strings 1	25	MellowBr	50	FolkGtr 1	75	IceBell
01	PowerBrass	26	FloatBrass	51	FolkGtr 2	76	SpaceBell
02	MetalSpace	27	Trumpet	52	E.Guitar 1	77	Sunbeam
03	Piano	28	Trombone	53	E.Guitar 2	78	BreathHit
04	E.Piano	29	Sax	54	Guitar	79	Suspense
05	ClinkDecay	30	Strings 2	55	FingerdB.	80	Wire 1
06	SoftCloud	31	Strings 3	56	SynBass 2	81	Whasp
07	Metalimba	32	BrightStrg	57	SynBass 3	82	Sandarimba
08	PanFlute	33	WideString	58	FretlessB.	83	Cosmic
09	SynBass 1	34	SoftString	59	UprightBass	84	Elegant
10	E.Piano 2A	35	Strings 4	60	Flute	85	HuskeyOrg.
11	E.Piano 2B	36	ClassicStr	61	Oboe	86	Wire 2
12	PianoAtck	37	Strg+Chime	62	Clarinet	87	Wire 3
13	E.Organ 1	38	CelloEns.	63	Violin	88	Wire 4
14	E.Organ 2	39	Pizzicato	64	Cello	89	Bells
15	Vibe	40	Ensemble 1	65	Whistle	90	SteelDrum
16	Marimba	41	DayBreak	66	Recorder	91	ShrineBell
17	Celeste	42	FluteVoice	67	Harmonical	92	SoftTimpani
18	Clavi	43	AngelChoir	68	Harmonica2	93	OilDrum
19	LargePipes	44	Ensemble 2	69	Harp	94	HandBells
20	SolidBrs	45	PEGvoice	70	AnalogLead	95	Strike 1
21	LowCutBrs	46	Ensemble 3	71	Dist.Lead	96	Strike 2
22	HiPeakBrs	47	WoodEns.	72	MetalAtck	97	Space
23	AttackBrs	48	Universe	73	WoodThump	98	Woosh
24	SoftLead	49	Forest	74	PuffPanFlt	99	Thunder

Preset performances

The V50's preset memory contains the following performances.

00	"V"Lead 1	25	Sequence	50	Scatter 2	75	Bs/E.Piano
01	"V"Brass 1	26	VibeEp	51	W-limba	76	Bs/Wire
02	Metal 1	27	PopsBrass2	52	TakeOff	77	Bs/MuteTp.
03	BalladEp	28	SaxSection	53	GrowVoice	78	Explosion
04	Piano	29	Waahz	54	Harp	79	Ac.Guitar
05	Ensemble 1	30	Mystery	55	Ep+Strings	80	Valley
06	"V"String1	31	Fanfare	56	"V"Brass 3	81	Metal 3
07	12stGuitar	32	DeepBell	57	"V"Brass 4	82	HolloWood
08	PopsBrass1	33	E.Organ 1	58	PanFlute	83	Fugue
09	Universe	34	Clinkimba	59	Huskey	84	Dist.Lead
10	Pizzicato	35	Meteor	60	E.Guitar	85	E.Organ 2
11	SaxLead	36	Strings 1	61	VlbePiano	86	Tinqule
12	WarmStrgs	37	"V"Bass 2	62	"V"Bass 3	87	Tropical
13	"V"String2	38	"DX"Ep	63	Strings 2	88	Elegant
14	"V"Bass 1	39	FloatChime	64	Resonance	89	SteelPiano
15	PuffBrass	40	Ensemble 2	65	SoftBrass	90	Ensemble 4
16	Cotton	41	PanBells	66	Ensemble 3	91	Metal 4
17	Sunbeam	42	BigBand	67	"V"Bass 4	92	OilDrum
18	Metal 2	43	AttackBass	68	TaikoBells	93	DragonHit
19	SpaceBells	44	"V"Lead 3	69	WirePiano	94	*Pops
20	HeavyMetal	45	"V"Lead 4	70	Clavi	95	*Funk
21	Chorus	46	SeqMarimba	71	Stakkato	96	*Rock
22	"V"Lead 2	47	Bells 1	72	Harmonica	97	*Jazz
23	MildBrass	48	Bells 2	73	PuffLead	98	*Latin
24	"V"Brass 2	49	Scatter 1	74	Bs/Brass	99	*V50 Demo

Initialized performance settings

SNGL

NAME	SINGLE							
INST NUMBER	1	2	3	4	5	6	7	8
ASSIGN MODE	DVA							
NOTES	0	off	off	off	off	off	off	off
VOICE NUMBER	100	*	*	*	*	*	*	*
MIDI RECEIVE CH	1	*	*	*	*	*	*	*
LIMIT / LOW	C-2	*	*	*	*	*	*	*
LIMIT / HIGH	G8	*	*	*	*	*	*	*
INST DETUNE	+0	*	*	*	*	*	*	*
NOTE SHIFT	+0	*	*	*	*	*	*	*
VOLUME	99	*	*	*	*	*	*	*
OUTPUT ASSIGN	L+R	*	*	*	*	*	*	*
LFO SELECT	1	*	*	*	*	*	*	*
MICRO TUNING	Equal							
	off	*	*	*	*	*	*	*
P. BPFECT	off	*	*	*	*	*	*	*
BPFECT	off	*	*	*	*	*	*	*

4LYR

NAME	4 LAYER							
INST NUMBER	1	2	3	4	5	6	7	8
ASSIGN MODE	DVA							
NOTES	0	0	0	0	off	off	off	off
VOICE NUMBER	100	100	100	100	*	*	*	*
MIDI RECEIVE CH	1	1	1	1	*	*	*	*
LIMIT / LOW	C-2	C-2	C-2	C-2	*	*	*	*
LIMIT / HIGH	G8	G8	G8	G8	*	*	*	*
INST DETUNE	-2	-1	+1	+2	*	*	*	*
NOTE SHIFT	+0	+0	+0	+0	*	*	*	*
VOLUME	95	95	95	95	*	*	*	*
OUTPUT ASSIGN	L+R	L+R	L+R	L+R	*	*	*	*
LFO SELECT	1	2	vib	vib	*	*	*	*
MICRO TUNING	Equal							
	off	off	off	off	*	*	*	*
P. BPFECT	off	off	off	off	*	*	*	*
BPFECT	off	off	off	off	*	*	*	*

DUAL

NAME	DUAL							
INST NUMBER	1	2	3	4	5	6	7	8
ASSIGN MODE	DVA							
NOTES	0	0	off	off	off	off	off	off
VOICE NUMBER	100	100	*	*	*	*	*	*
MIDI RECEIVE CH	1	1	*	*	*	*	*	*
LIMIT / LOW	C-2	C-2	*	*	*	*	*	*
LIMIT / HIGH	G8	G8	*	*	*	*	*	*
INST DETUNE	+0	+2	*	*	*	*	*	*
NOTE SHIFT	+0	+0	*	*	*	*	*	*
VOLUME	99	99	*	*	*	*	*	*
OUTPUT ASSIGN	L+R	L+R	*	*	*	*	*	*
LFO SELECT	1	2	*	*	*	*	*	*
MICRO TUNING	Equal							
	off	off	*	*	*	*	*	*
P. BPFECT	off	off	*	*	*	*	*	*
BPFECT	off	off	*	*	*	*	*	*

8LYR

NAME	8 LAYER							
INST NUMBER	1	2	3	4	5	6	7	8
ASSIGN MODE	DVA							
NOTES	0	0	0	0	0	0	0	0
VOICE NUMBER	100	100	100	100	100	100	100	100
MIDI RECEIVE CH	1	1	1	1	1	1	1	1
LIMIT / LOW	C-2	C-2	C-2	C-2	C-2	C-2	C-2	C-2
LIMIT / HIGH	G8	G8	G8	G8	G8	G8	G8	G8
INST DETUNE	+0	+0	-1	+1	-2	+2	-4	+4
NOTE SHIFT	+0	+0	+0	+0	+0	+0	+0	+0
VOLUME	92	92	92	92	92	92	92	92
OUTPUT ASSIGN	L+R	L+R	L+R	L+R	L+R	L+R	L+R	L+R
LFO SELECT	1	2	vib	vib	vib	vib	vib	vib
MICRO TUNING	Equal							
	off	off	off	off	off	off	off	off
P. BPFECT	off	off	off	off	off	off	off	off
BPFECT	off	off	off	off	off	off	off	off

SPLT

NAME	SPLIT							
INST NUMBER	1	2	3	4	5	6	7	8
ASSIGN MODE	DVA							
NOTES	0	0	off	off	off	off	off	off
VOICE NUMBER	100	100	*	*	*	*	*	*
MIDI RECEIVE CH	1	1	*	*	*	*	*	*
LIMIT / LOW	C-2	C3	*	*	*	*	*	*
LIMIT / HIGH	B2	G8	*	*	*	*	*	*
INST DETUNE	+0	+0	*	*	*	*	*	*
NOTE SHIFT	+0	+0	*	*	*	*	*	*
VOLUME	99	99	*	*	*	*	*	*
OUTPUT ASSIGN	L+R	L+R	*	*	*	*	*	*
LFO SELECT	1	2	*	*	*	*	*	*
MICRO TUNING	Equal							
	off	off	*	*	*	*	*	*
P. EFFECT	off	off	*	*	*	*	*	*
EFFECT	off	off	*	*	*	*	*	*

SEQ8

NAME	SEQUENCER8							
INST NUMBER	1	2	3	4	5	6	7	8
ASSIGN MODE	DVA							
NOTES	0	0	0	0	0	0	0	0
VOICE NUMBER	100	101	102	103	104	105	106	107
MIDI RECEIVE CH	1	2	3	4	5	6	7	8
LIMIT / LOW	C-2	C-2	C-2	C-2	C-2	C-2	C-2	C-2
LIMIT / HIGH	G8	G8	G8	G8	G8	G8	G8	G8
INST DETUNE	+0	+0	+0	+0	+0	+0	+0	+0
NOTE SHIFT	+0	+0	+0	+0	+0	+0	+0	+0
VOLUME	99	99	99	99	99	99	99	99
OUTPUT ASSIGN	L+R	L+R	L+R	L+R	L+R	L+R	L+R	L+R
LFO SELECT	1	2	vib	vib	vib	vib	vib	vib
MICRO TUNING	Equal							
	off	off	off	off	off	off	off	off
P. EFFECT	off	off	off	off	off	off	off	off
EFFECT	off	off	off	off	off	off	off	off

SEQ4

NAME	SEQUENCER4							
INST NUMBER	1	2	3	4	5	6	7	8
ASSIGN MODE	DVA							
NOTES	0	0	0	0	off	off	off	off
VOICE NUMBER	100	101	102	103	*	*	*	*
MIDI RECEIVE CH	1	2	3	4	*	*	*	*
LIMIT / LOW	C-2	C-2	C-2	C-2	*	*	*	*
LIMIT / HIGH	G8	G8	G8	G8	*	*	*	*
INST DETUNE	+0	+0	+0	+0	*	*	*	*
NOTE SHIFT	+0	+0	+0	+0	*	*	*	*
VOLUME	99	99	99	99	*	*	*	*
OUTPUT ASSIGN	L+R	L+R	L+R	L+R	*	*	*	*
LFO SELECT	1	2	vib	vib	*	*	*	*
MICRO TUNING	Equal							
	off	off	off	off	*	*	*	*
P. EFFECT	off	off	off	off	*	*	*	*
EFFECT	off	off	off	off	*	*	*	*

Initialized voice settings

					VOICE NAME	INIT VOICE		
OPERATOR	1	2	3	4	POLY / MONO MODE	Poly		
ALGORITHM	1				PITCH BEND RANGE	4		
FEEDBACK LEVEL	0				FOOT SW	Sus		
LFO	WAVE	triangl			PORTAMENTO	MODE	Full	
	SPEED	35				TIME	0	
	DELAY	0			FOOT CONTROL	VOLUME	40	
	SYNC	off				PITCH	0	
	PMD	0				AMPLITUDE	0	
SENSITIVITY	AMD	0			MODULATION	PITCH	50	
	PMS	6				WHEEL	AMPLITUDE	0
	AMS	0			BREATH CONTROL	PITCH	0	
	AME	off	off	off		off	AMPLITUDE	0
	EBS	0	0	0		0	PITCH BIAS	+0
OSCILLATOR	KVS	+0	+0	+0	EG BIAS	0		
	MODE	r	r	r	r	PITCH	0	
	FIX SHIFT	*	*	*	*	AFTER TOUCH	AMPLITUDE	0
	FIX RANGE	*	*	*	*		PITCH BIAS	+0
	FREQUENCY	1.00	1.00	1.00	1.00	EG BIAS	0	
ENVELOPE GENERATOR	WAVE	w1	w1	w1	w1	REVERB	RATE	off
	DETUNE	0	0	0	0		EFFECT	SELECT
	AR	31	31	31	31	BALANCE		*
	DIR	31	31	31	31	OUT LEVEL		*
	D1L	15	15	15	15	STEREO MIX		*
D2R	0	0	0	0	PARAM 1	*		
PITCH ENVELOPE GENERATOR	RR	15	15	15	15	PARAM 2	*	
	SHIFT	off	off	off	off	PARAM 3	*	
	PR1	99			OUTPUT LEVEL			
	PL1	50						
	PR2	99						
PL2	50							
PR3	99							
KEYBOARD SCALING	RATE	0	0	0	0			
TRANSPOSE	LEVEL	+0	+0	+0	+0			
		C3						

SPECIFICATIONS

● Synthesizer section

Keyboard:	61-note (C1 – C6), velocity and pressure sensitive
Tone generators:	4-operator 8-algorithm FM, 8 selectable waveforms
Polyphony:	16 notes maximum simultaneous, last note priority, 8-voice multi-timbral
Internal memory:	100 internal voices 100 preset voices 100 internal performances 100 preset performances 12 (3 types × 4 each) performance effects (delay, pan, chord) 2 micro tuning (octave, full) program change table system setup

● Sequencer section

Tracks:	8 (maximum 16 note polyphony/track, maximum 32 note total polyphony for all tracks)
Songs:	8
Resolution:	192th note (internal clock) 96th note (MIDI clock) 32nd note (step record)
Internal memory:	64Kbyte (approximately 16,000 notes)

● Rhythm section

Tone generation:	PCM
Polyphony:	8 notes
Internal memory:	100 preset patterns 100 internal patterns

● Other

Digital effects:	32 types (parameters programmable for each voice and performance)
Terminals:	OUTPUT L/MONO, OUTPUT R, VOLUME, FC, FS, START/STOP, MIDI IN, OUT, THRU, BREATH CONTROL, PHONES
Display:	40 character 2 line, backlit
Power consumption:	25 W
Power requirements:	USA and Canadian model; 120 V 60Hz General model; 220 – 240 V 50 Hz
Dimensions (W × D × H):	1002 mm × 326 mm × 98 mm (3' 3 1/2" × 1' 7/8" × 3' 7/8")
Weight:	11.2 Kg (24 lbs 11 oz)

MIDI DATA FORMAT

SYNTHESIZER SECTION

MIDI reception/ transmission block diagram

1. MIDI reception conditions

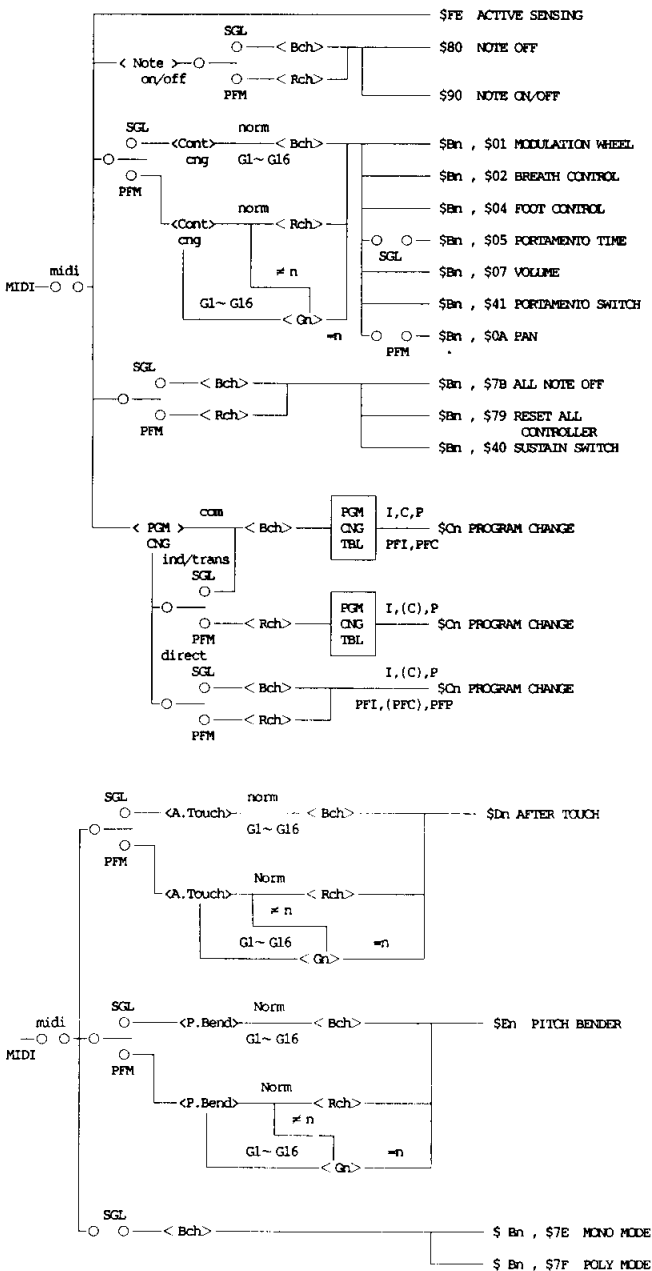

Bch — Basic Rcv. ch.
 Rch — Receive ch.
 Gn — Global ch.

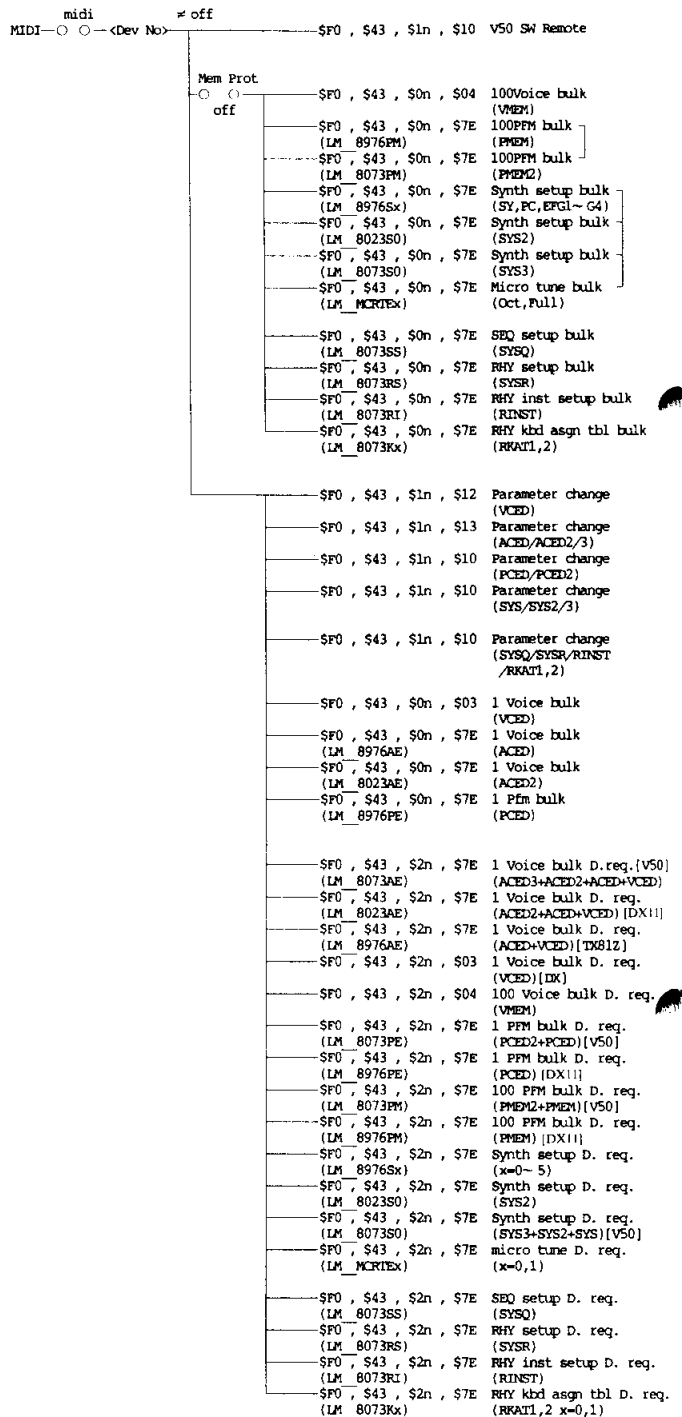

Dev No = Device Number

VCEd = Voice edit buffer
 ACED = Additional voice edit buffer (for TXB1Z)
 ACED2/3 = Additional voice edit buffer 2/3 (for DX11-V50)
 PCED = Performance edit buffer
 PCED2 = Performance edit buffer 2
 VMEM = Voice memory
 PMEM = Performance memory
 PMEM2 = Performance memory 2

2. MIDI transmission condition

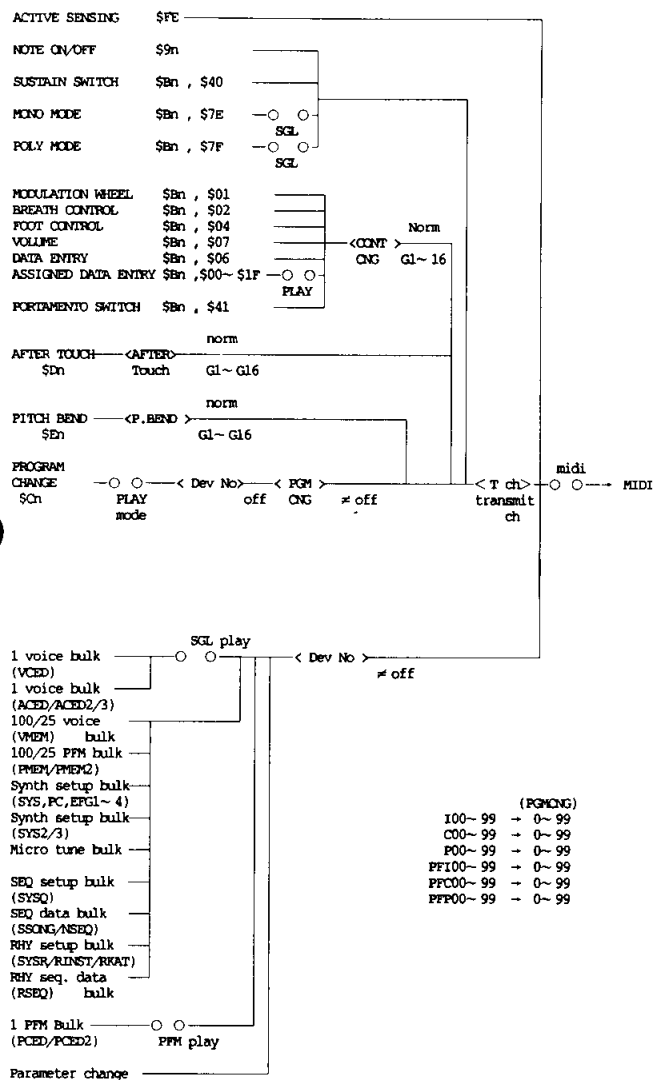

3. Channel message

3.1 Transmission

3.1.1 Note on/off

Transmitted note range = C1 (36) – C6 (96)

Velocity range = 0 – 127 (0: note off)

3.1.2 Control change

When the following controllers are moved, MIDI is transmitted.

ctl#	parameter	data rng
1	Modulation wheel	0...127
2	Breath control	0...127
4	Foot control	0...127
6	Data entry slider at not play mode	0...127
7	Volume pedal	0...127
64	Sustain switch	0, 127
65	Portamento switch	0, 127
0~31	Assigned Data entry slider at Play mode	0...127

*1 The control change switch cannot turn transmission on/off.

◆ In system setup mode, the transmission mode can be selected.

off : No control changes are transmitted.

norm/G1 – G16 : Transmitted on the channel specified by Trns.ch

3.1.3 Program change

When a voice is selected in single mode, or when a performance is selected in performance mode, a program change is transmitted. Regardless of the mode, the program change number is assigned as follows.

I, P, C, PFI, PFC, PFF → Program change no.
00 – 99 → 00 – 99

Transmission can be turned on/off by mode.

1) off:

program changes are not transmitted

2) common/individual/direct:

Transmitted when voice/performance is selected in SYNTH mode.

However, program changes transmitted from the internal sequencer for data created on the V50 consist of bytes, and are transmitted as follows.

pgm change	mode	memory	
#119	IND	INT	(I) or (C)
#120		not used	
#121	IND	PRESET	(P)
#122	SGL	INT	(I)
#123	SGL	CARD	(C)
#124	SGL	PRESET	(P)
#125	PFM	INT	(PFI)
#126	PFM	CARD	(PFC)
#127	PFM	PRESET	(PFF)

See the reception section for the meaning of mode (IND/SGL/PFM).

3) Transfilter:

Transmit on the channel specified by Trans.ch. However program changes from the internal sequencer will be transmitted as a single byte without program changes above 119 (for SEQ mode). (For tone generators other than the V50.)

3.1.4 Pitch bend

Pitch bend is transmitted with 7 bit resolution.

◆ Transmission on/off is possible in system setup (off, norm, G1 – G16). The contents are the same as for control change.)

3.1.5 Aftertouch

◆ Transmission on/off is possible in system setup (off, norm, G1 – G16). The contents are the same as for control change.)

3.1.6 Channel mode messages

The following messages are transmitted when the mono/poly mode of a voice is changed.

★ MONO mode (\$Bn, \$7E, \$01) only in single mode

★ POLY mode (\$Bn, \$7F, \$00) only in single mode

3.2 Reception

3.2.1 Note on/off

Note reception range = C-2 – G8

Velocity range = 0 – 127 (only note on)

◆ In system setup, the following settings are possible.

normal = all note numbers are received

odd = only odd note numbers are received

even = only even note numbers are received

3.2.2 Control change

The following parameters can be controlled via MIDI.

ctl#	parameter	data msg
1	Modulation wheel	0...127
2	Breath control	0...127
4	Foot control	0...127
5	Portament time	0...127
7	Volume	0...127
10	PAN	0...127
64	Sustain switch	0...127
65	Portamento switch	0...127

*1 Only in single mode

*2 Only in performance mode, 0-42 (L), 43-85 (L+R), 86-127 (R).

*3 Reception cannot be turned on/off by the control change switch.

◆ Reception mode is set in system setup.

- off : No control changes are received.
- norm : Control changes are received by each channel (normal setting).
- G1-G16 : A global channel can be set, indicated by the number following the "G". Control changes received on this channel will apply to all channels (apply to all instruments). Each instrument will receive data both from this global channel and from the channel specified for the instrument, with last-data priority.

3.2.3 Program change

When a program change is received, the unit responds as follows. Five types of reception mode can be selected in system setup.

- 1) off: Program changes are not received.
- 2) common: Program changes are received and converted to the number assigned by the program change table. If the selected table entry contains a PFM number (PF00-99), it will cause the V50 to move from single to performance mode.
- 3) individual: Select this setting when you want to select voices for each instrument in performance mode. The program change table is still consulted, but if the selected table entry assigns a performance, it is ignored. In single mode, selecting "individual" has the same effect as selecting "com".

The selected voice will depend on whether an INT or CRT performance is currently selected.

Program change table data	Currently selected performance	
	INT	CARD
I00 - I99	I00 - 99	C00 - 99
C00 - C99	I00 - 99	C00 - 99
P00 - P99	←	←
PF100 - PF199	Ignored	←
PF200 - PF299	Ignored	←
PF300 - PF399	Ignored	←
PF400 - PF499	Ignored	←

4) direct (V50 mode):

In this case, the program change table is not consulted, and response is fixed as follows. Also, program changes of #119 and above are used as follows to change the mode, and following program changes will select voices in that mode. If a program change #00-99 is received without having received a mode select program change, it will be processed as "IND INT"

pgm change	mode & memory		
#00-99	00-99 in that mode		
#119	IND	INT	(I) or (C)
#120	not used		
#121	IND	PRESET	(P)
#122	SGL	INT	(I)
#123	SGL	CARD	(C)
#124	SGL	PRESET	(P)
#125	PFM	INT	(PFI)
#126	PFM	CARD	(PFC)
#127	PFM	PRESET	(PPF)

Meaning of each mode

- IND (individual): Select the voice for each instrument in pfm mode.
- SGL (single): Change to single mode, and select the specified single mode voice.
- PFM (performance): Change to performance mode, and select the specified voice of performance mode.

5) TransFilter: For reception, this is identical to "individual".

3.2.4 Pitch bend

Pitch bend reception uses only the MSB.

- ◆ The reception mode can be selected in system setup (off, norm, G1-G16). Contents are the same as for control changes.

3.2.5 Aftertouch

- ◆ The reception mode can be selected in system setup (off, norm, G1-G16). Contents are the same as for control changes.

3.2.6 Channel mode messages

- ★ ALL NOTE off (\$Bn, \$7B, \$00)
- ★ MONO mode (\$Bn, \$7E, \$01) only in single mode
- ★ POLY mode (\$Bn, \$7F, \$00) only in single mode

3.3 Functional diagram of keyboard and tone generator

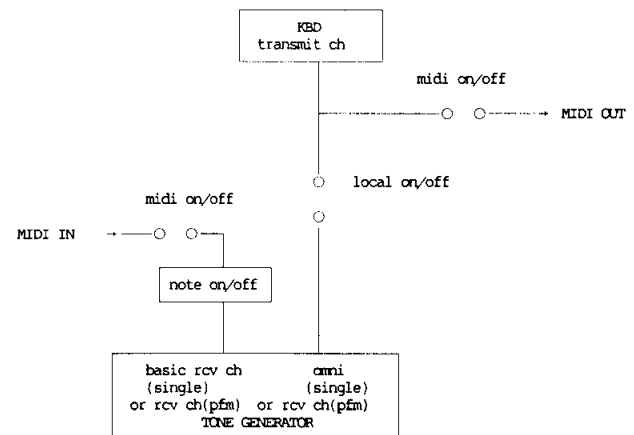

Note 1: In single mode, sound will be produced even if the basic receive channel and the transmit channel do not match.

Note 2: A distinction is made between note on messages from the keyboard and note on messages from MIDI. However no distinction is made between controller data from the keyboard and controller data from MIDI (sustain switch, control change, aftertouch, pitch bend).

4. System exclusive messages

4.1 Parameter changes

This unit transmits and receives the following 13 types of parameter change. (However, 13.Remote Switch is only received.) For 13.Remote Switch, the screen will be the same as when the switch is pressed.

- ```

1). VCED parameter change
2). ACED / ACED2 / ACED3 parameter change
3). PCED parameter change
4). PCED2 parameter change
5). System parameter change(SYS,SYS2,SYS3)
6). Effect parameter change(EFG1~4)] SYN
7). Micro tuning parameter change(OCT,FULL)] setup
8). Program change Table para. change
9). SEQ system parameter change(SYSQ).....SEQ setup
10). rhythm system parameter change(SYSR)
11). rhythm inst setup parameter change(RINST1,2)] RHYTHM
12). rhythm keyboard assign table] setup
system parameter change(RKACT1,2)
13). Remote switch parameter change

```

Parameter change format is as follows.

#### ★ Format for 1) -- 3)

```

11110000 f0
01000011 43
0001nnnn nnnn = Device No
099999hh ggggg = group number , hh = sub group number
0ppppppp ppppppp = parameter number
0ddddd dddddd = data
11110111 f7

```

For details of ggggg, hh, ppppppp, dddddd, see the following items.

- ★ For the format of 4)... see 4.1.4.
- ★ For the format of 5)... see 4.1.5.
- ★ For the format of 6)... see 4.1.6.
- ★ For the format of 7)... see 4.1.7.
- ★ For the format of 8)... see 4.1.8.
- ★ For the format of 9)–12)... see 4.1.9.
- ★ For the format of 13)... see 4.1.10.

#### 4.1.1 VCED parameter change

```

ggggg = 00100 (4)
hh = 10 (2)

```

VCED (Voice edit buffer) messages change data one parameter at a time. For ppppppp (parameter number) and dddddd (data), see table 1.

Single mode is automatically entered when this message is received.

#### 4.1.2 ACED / ACED2 / ACED3 parameter change

```

ggggg = 00100 (4)
hh = 11 (3)

```

ACED/ACED2 (Additional voice edit buffer) messages change data one parameter at a time. For ppppppp (parameter number) and dddddd (data), see table 1.

Single mode is automatically entered when this message is received.

#### 4.1.3 PCED parameter change

```

ggggg = 00100 (4)
hh = 00 (0)
pppppp = (0-109)

```

PCED (Performance edit buffer) messages change data one parameter at a time. For ppppppp (parameter number) and dddddd (data), see table 1.

Performance mode is automatically entered when this message is received.

#### 4.1.4 PCED2 parameter change

★ Format

```

11110000 f0
01000011 43
0001nnnn nnnn = Device No
099999hh ggggg = 00100 (4) , hh = 00 (0)
0ppppppp ppppppp = 1101110 (110)
0kkkkkkk kkkkkkk = Parameter number
0ddddd dddddd = data
11110111 f7

```

PCED2 messages change data one parameter at a time. For kkkkkkk (parameter number) and dddddd (data), see table 1. Performance mode is automatically entered when this message is received.

#### 4.1.5 System parameter change (SYS, SYS2, SYS3)

##### ★ Format

```

11110000 f0
01000011 43
0001nnnn nnnn = Device No
099999hh ggggg = 00100 (4) , hh = 00 (0)
0ppppppp ppppppp = 1111011 (123)
0kkkkkkk kkkkkkk = Parameter number
0ddddd dddddd = data
11110111 f7

```

These messages change system data one parameter at a time. For kkkkkkk (parameter number) and dddddd (data), see table 3.

#### 4.1.6 Effect parameter change

##### ★ Format

```

11110000 f0
01000011 43
0001nnnn nnnn = Device No
099999hh ggggg = 00100 (4) , hh = 00 (0)
0ppppppp ppppppp = 1111100 (124:EFG1),1111000(120:EFG2)
0kkkkkkk kkkkkkk = Parameter number ,1111001(121:EFG3)
0ddddd dddddd = data ,1111010(122:EFG4)
11110111 f7

```

These messages change PFM Effect (delay, pan, chord) data one parameter at a time. The value of ppppppp sets the group number.

```

EFG1 : delay1,pan1,chord1
EFG2 : delay2,pan2,chord2
EFG3 : delay3,pan3,chord3
EFG4 : delay4,pan4,chord4

```

For kkkkkkk (parameter number) and dddddd (data), see table 3.

#### 4.1.7 Micro tuning parameter change

##### ★ Format

```

11110000 f0
01000011 43
0001nnnn nnnn = Device No
099999hh ggggg = 00100 (4) , hh = 00 (0)
0ppppppp ppppppp = 1111101 (125:OCT),1111110(126:FULL)
0kkkkkkk kkkkkkk = key number
0hhhhhhh hhhhhh = data (high)
01111111 1111111 = data (low)
11110111 f7

```

These messages change micro tuning data one key at a time. For kkkkkkk (key number) and dddddd (data), see table 3.

#### 4.1.8 Program change parameter change

##### ★ Format

```

11110000 f0
01000011 43
0001nnnn nnnn = Device No
099999hh ggggg = 00100 (4) , hh = 00 (0)
0ppppppp ppppppp = 1111111 (127)
0kkkkkkk kkkkkkk = PGM change No
0hhhhhhh hhhhhh = data (high)
01111111 1111111 = data (low)
11110111 f7

```

These messages change the PGM Change Table data. Data has the following meaning.

| ## | high data | low data |               |
|----|-----------|----------|---------------|
| 0  | 0 - 99    |          | I00 - I99     |
| 1  | 0 - 99    |          | C00 - C99     |
| 2  | 0 - 99    |          | P00 - P99     |
| 3  | 0 - 99    |          | PF100 - PF199 |
| 4  | 0 - 99    |          | PF000 - PF099 |
| 5  | 0 - 99    |          | PF00 - PF99   |

For kkkkkkk (PGM change number), see table 3.

#### 4.1.9 SYSQ, SYSR, RINST, RKAT parameter change

##### ★ Format

```

11110000 f0
01000011 43
0001nnnn rrrrr = Device No
0ggggghh ggggg = 00100 (4), hh = 00 (0)
0ppppppp ppppppp = 111 - 116
0kkkkkkk kkkkkkk = Parameter number
0ddddd dddddd = data
11110111 £7

p=111 : SYSQ (SEQ system)
p=112 : SYSR (RHYTHM system)
p=113 : RINST1 (RHYTHM inst setup (VCL, PAN))
p=114 : RINST2 (RHYTHM inst setup (NOTE))
p=115 : RKAT1 (RHYTHM kbd assign table 1)
p=116 : RKAT2 (RHYTHM kbd assign table 2)

```

These messages change the setup data for rhythm and sequencer, one parameter at a time. Some of these parameters are not received while playing.

For kkkkkkk (parameter number) and dddddd (data), see table 3.

#### 4.1.10 Remote switch parameter change

##### ★ Format

```

11110000 f0
01000011 43
0001nnnn rrrrr = Device No
0ggggghh ggggg = 00100 (4), hh = 00 (0)
0ppppppp ppppppp = 1110110 (118)
0kkkkkkk kkkkkkk = switch number
0ddddd dddddd = data
11110111 £7

ddddd = 1111111 ($7F) ON
 = 0000000 OFF

```

These parameters are for reception only, and allow all panel switches to be remotely controlled. They cause the same effect as when that switch is pressed. Reception for this data cannot be turned off by the various MIDI switches.

For kkkkkkk (switch number), see table 1.

#### 4.2 Voice data bulk dump

There are two types of voice data bulk dump, as follows.

- 1) Voice edit buffer bulk dump
- 2) Voice memory bulk dump

◆ For the format details of each type of bulk data dump, see tables 1, 2, and 3.

##### 4.2.1 Voice edit buffer bulk dump

The voice data in the voice edit buffer is transmitted when a voice is selected in PLAY mode of single mode, or when Init Voice or Recall Edit is executed. When this is received, it will be loaded into the voice edit buffer. ACED2 is parameter data added to the TX81Z parameters for the DX11. ACED3 is parameter data added to the DX11 parameters for the V50.

###### a) Transmission

Data is transmitted in the following order. There is a time interval of approximately 100ms between each bulk data.

- 1) ACED3 (Additional voice edit buffer3) bulk data
- 2) ACED2 (Additional voice edit buffer2) bulk data
- 3) ACED (Additional voice edit buffer) bulk data
- 4) VCED (voice edit buffer) bulk data

###### b) Reception

When data is received, operation is as follows. — indicates that the data does not change.

| Received data | Buffer | VCED | ACED    | ACED2   | ACED3   |
|---------------|--------|------|---------|---------|---------|
| VCED only     |        | set  | cleared | cleared | cleared |
| ACED only     |        | —    | set     | cleared | cleared |
| ACED + VCED   |        | set  | set     | cleared | cleared |

|                             |     |     |     |         |
|-----------------------------|-----|-----|-----|---------|
| ACED2 only                  | —   | —   | set | cleared |
| ACED2 + ACED                | —   | set | set | cleared |
| ACED2 + ACED + VCED         | set | set | set | cleared |
| ACED3 only                  | —   | —   | —   | set     |
| ACED3 + ACED2               | —   | —   | set | set     |
| ACED3 + ACED2 + ACED        | —   | set | set | set     |
| ACED3 + ACED2 + ACED + VCED | set | set | set | Set     |

#### 4.2.2 Voice memory bulk dump

This transmits/receives data for the 100 voices in internal memory, or preset/card voice data (100 voices) all together or 25 voices at a time.

VMEM (voice memory) bulk data is the combination of VCED, ACED, ACED2, and ACED3.

(twenty-five V50 voices) + (eight INIT VOICE voices) = 32 voices

##### a) Transmission

Data is transmitted in the following order.

- a-1) When transmitting ALL.
  - header (block1)
  - VMEM (00-24)
  - header (block2)
  - VMEM (25-49)
  - header (block3)
  - VMEM (50-74)
  - header (block4)
  - VMEM (75-99)

- a-2) When transmitting one block at a time.

header (specified block)  
VMEM

##### b) Reception

When VMEM is received, "Midi Received" and the name of the received block will be displayed. VMEM 32 voice bulk data without a header is loaded directly into I00 - I31.

#### 4.3 Performance data bulk dump

There are two types of performance data bulk dump, as follows.

- 1) Performance edit buffer bulk dump
- 2) Performance memory bulk dump

##### 4.3.1 Performance edit buffer bulk dump

When a performance is selected in PLEY mode of performance mode, or when Init Performance or Recall Performance has been executed, the performance data in the performance edit buffer will be transmitted. When this data is received, the performance data will be loaded into the performance edit buffer.

◆ For the details of the bulk dump data format, see tables 1, 2, and 3.

###### a) Transmission

Data is transmitted in the following order. There is an interval of approximately 100ms between each bulk data.

- 1) PCED2 (performance edit buffer 2) bulk data
- 2) PCED (performance edit buffer) bulk data

##### 4.3.2 Performance memory bulk dump

This transmits/receives data for the 100 performances in internal, preset or card memory, either all together or 25 performances at a time.

◆ For the details of the bulk dump data format, see tables 1, 2, and 3.

###### a) Transmission

Data is transmitted in the following order. There is an interval of approximately 100ms between each bulk data.

- 1) PMEM2 (performance memory 2) bulk data
- 2) PMEM (performance memory) bulk data

Data is transmitted in the following order.

- a-1) When transmitting ALL.  
 header (block1)  
 PMEM2 (00-24)  
 PMEM (00-24)  
 header (block2)  
 PMEM2 (25-49)  
 PMEM (25-49)  
 header (block3)  
 PMEM2 (50-74)  
 PMEM (50-74)  
 header (block4)  
 PMEM2 (75-99)  
 PMEM (75-99)

- a-2) When transmitting one block at a time.  
 header (specified block)  
 PMEM2  
 PMEM

b) Reception

When PMEM is received, "Midi Received" and the name of the received block will be displayed. PMEM 32 performance bulk data without a header is loaded directly into PFI00 - PFI31.

When data is received, operation is as follows. - indicates that the data does not change.

| Received data | Buffer | PCED    | PCED2 | PMEM    | PMEM2 |
|---------------|--------|---------|-------|---------|-------|
| PCED only     | set    | default | -     | -       |       |
| PCED2 only    | -      | set     | -     | -       |       |
| PCED2 + PCED  | set    | set     | -     | -       |       |
| PMEM only     | -      | -       | set   | default |       |
| PMEM2 only    | -      | -       | -     | set     |       |
| PMEM2 + PMEM  | -      | -       | set   | set     |       |

4.4 SYNTH system setup data bulk dump

This transmits and receives the system setup data of the V50. For transmission, this is divided into four types of bulk data. (EF is divided into EFG1 - EFG4.) SYS2 data contains parameters added to TX81Z parameters for the DX11. SYS3 data contains parameters added to DX11 parameters for the V50.

- SYS..... System (SYS3 → SYS2 → SYS)
- PCT..... Program Change table
- P.EFCT..... Effect data (EFG1, 2, 3, 4)
- MCT..... Micro tuning data (OCT, FULL)

When "SetALL" is selected and transmission executed to transmit all of the above data (except for System data), the data will be transmitted in the following order.

1. PCT
2. P.EFCT (EFG1 → 2 → 3 → 4)
3. MCT Transmits/receives the data currently in the OCT, FULL micro tuning buffers.

- ◆ For details of each bulk dump data format, see tables 2 and 3.
- ◆ EFG n (n = 1 - 4) indicates the set of delay n, pan n, and chord n.

4.5 SEQ data bulk dump

This transmits and receives system setup data and sequence data for the currently selected song of the V50 internal sequencer. When receiving sequence data, it will be loaded into the current song only if the current song is empty. (Data is not received while playing.) For transmission, the data is divided into three types of bulk data.

- SETUP..... System (SYSQ)
- SSONG..... current sequence song data
- NSEQ..... current sequence data

If "SeqALL" is selected and transmission executed, the above three types of data will be successively transmitted in the following order.

1. SSONG
2. NSEQ
3. SETUP

- ◆ For details of each bulk dump data format, see table 2 for SETUP, and see the format table of the sequencer section for NSEQ and SSONG.

4.6 RHYTHM data bulk dump

This transmits and receives system setup data and sequence data for the V50 rhythm machine. (Data is not received while playing.) For transmission, the data is divided into four types of bulk data.

- SETUP..... System (SYSR)  
 ..... inst setup (RINST)  
 ..... keyboard assign table (RKAT1,2)
- RSEQ..... rhythm sequence data

If "RhyqALL" is selected and transmission executed, data will be transmitted in the following order.

- 1) SYSR
- 2) RINST
- 3) RKAT1
- 4) RKAT2
- 5) RSEQ

- ◆ For details of each bulk dump data format, see table 4.

4.7 Dump request

Dump request is possible for all types of bulk data.

- ◆ For details of each message, see table 5.

5. System common messages (for SEQ/RHYTHM)

5.1 Status F2 (song position pointer)

Received only. (except in REC mode of SEQ/R)

5.2 Status F1, F3 ... F7

Aside from internally registering as status bytes, these have no effect.

6. System realtime messages (for SEQ/RHYTHM)

6.1 Status F8, FA, FB, FC

Received.

6.2 Status F9, FD, FF

After decoding, these have no effect.

6.3 Status FE (active sensing)

- a) Transmission  
 FE is transmitted at intervals of approximately 170msec.
- b) Reception  
 Once FE is received, if no MIDI data appears for longer than approximately 300msec, the MIDI reception buffer is cleared, and if there are remaining Key Ons, they are turned Off.



< Table 1 >

Parameters in the table surrounded by “%%” are parameters which have been added to or modified from TX81Z parameters.

Parameters in the table surrounded by “###” are parameters which have been added to or modified from DX11 parameters.

Parameter list of parameter change and bulk

\*\*\* VCED \*\*\* 93 byte voice edit parameter ( 1 bulk edit format )  
para. cng g=4, h=2

| VCED address (para.cng) | b7 | b6 | b5 | b4 | b3            | b2 | b1 | b0 | Data                | note                         |
|-------------------------|----|----|----|----|---------------|----|----|----|---------------------|------------------------------|
| edit 0                  | 0  | 0  | 0  | 0  | AR            |    |    |    | 0-31                |                              |
| 1                       | 0  | 0  | 0  | 0  | DIR           |    |    |    | 0-31                |                              |
| 2                       | 0  | 0  | 0  | 0  | D2R           |    |    |    | 0-31                |                              |
| 3                       | 0  | 0  | 0  | 0  | RR            |    |    |    | 1-15                |                              |
| 4                       | 0  | 0  | 0  | 0  | DIL           |    |    |    | 0-15                |                              |
| 5##                     | 0  |    |    |    | LS            |    |    |    | 0-99 with LS2(sign) |                              |
| 6                       | 0  | 0  | 0  | 0  | RS            |    |    |    | 0-3                 | OP.4                         |
| 7                       | 0  | 0  | 0  | 0  | EB            |    |    |    | 0-7                 |                              |
| 8                       | 0  | 0  | 0  | 0  | AME           |    |    |    | 0-1                 |                              |
| 9##                     | 0  | 0  | 0  | 0  | KVS           |    |    |    | 0-14                | 0-7(0 - +7)<br>8-14(-7 - -1) |
| 10                      | 0  |    |    |    | OUT           |    |    |    | 0-99                |                              |
| 11                      | 0  | 0  |    |    | CRS           |    |    |    | 0-63                | (RATIO)                      |
|                         | 0  | 0  |    |    | CRS           | x  | x  |    | 0-63                | (FIX)                        |
| 12                      | 0  | 0  | 0  | 0  | DET           |    |    |    | 0-6                 | (center=3)                   |
| 13                      |    |    |    |    |               |    |    |    |                     | OP.2                         |
| 26                      |    |    |    |    |               |    |    |    |                     | OP.3                         |
| 39                      |    |    |    |    |               |    |    |    |                     | OP.1                         |
| 52                      | 0  | 0  | 0  | 0  | ALG           |    |    |    | 0-7                 |                              |
| 53                      | 0  | 0  | 0  | 0  | PBL           |    |    |    | 0-7                 |                              |
| 54                      | 0  |    |    |    | LFS           |    |    |    | 0-99                |                              |
| 55                      | 0  |    |    |    | LFD           |    |    |    | 0-99                |                              |
| 56                      | 0  |    |    |    | PM            |    |    |    | 0-99                |                              |
| 57                      | 0  |    |    |    | AMD           |    |    |    | 0-99                |                              |
| 58                      | 0  | 0  | 0  | 0  | 0             | 0  | 0  | 0  | 0-1                 | LFO SYNC                     |
| 59                      | 0  | 0  | 0  | 0  | 0             | 0  | 0  | 0  | 0-3                 |                              |
| 60                      | 0  | 0  | 0  | 0  | 0             | 0  | 0  | 0  | 0-7                 |                              |
| 61                      | 0  | 0  | 0  | 0  | 0             | 0  | 0  | 0  | 0-3                 |                              |
| 62                      | 0  | 0  |    |    | TRPS          |    |    |    | 0-48                | (center=24)                  |
| function 63             | 0  | 0  | 0  | 0  | 0             | 0  | 0  | 0  | MONO                |                              |
| 64                      | 0  | 0  | 0  | 0  | PER           |    |    |    | 0-12                |                              |
| 65                      | 0  | 0  | 0  | 0  | 0             | 0  | 0  | 0  | FORMOD              |                              |
| 66                      | 0  |    |    |    | PORT          |    |    |    | 0-99                |                              |
| 67                      | 0  |    |    |    | FC VOL        |    |    |    | 0-99                |                              |
| 68                      | 0  | 0  | 0  | 0  | 0             | 0  | 0  | 0  | 0-1                 | sus.(F.SW)                   |
| 69                      |    |    |    |    | reserved      |    |    |    |                     | por.                         |
| 70                      | 0  | 0  | 0  | 0  | 0             | 0  | 0  | 0  | 0-1                 | chorus set 0                 |
| 71                      | 0  |    |    |    | MW PITCH      |    |    |    | 0-99                |                              |
| 72                      | 0  |    |    |    | MW AMPLI      |    |    |    | 0-99                |                              |
| 73                      | 0  |    |    |    | BC PITCH      |    |    |    | 0-99                |                              |
| 74                      | 0  |    |    |    | BC AMPLI      |    |    |    | 0-99                |                              |
| 75                      | 0  |    |    |    | BC P BIAS     |    |    |    | 0-100               | (center=50)                  |
| 76                      | 0  |    |    |    | BC E BIAS     |    |    |    | 0-99                |                              |
| 77                      | 0  |    |    |    | VOICE NAME 1  |    |    |    | 32-127              |                              |
| 78                      | 0  |    |    |    | VOICE NAME 2  |    |    |    |                     |                              |
| 79                      | 0  |    |    |    | VOICE NAME 3  |    |    |    |                     |                              |
| 80                      | 0  |    |    |    | VOICE NAME 4  |    |    |    |                     |                              |
| 81                      | 0  |    |    |    | VOICE NAME 5  |    |    |    |                     |                              |
| 82                      | 0  |    |    |    | VOICE NAME 6  |    |    |    |                     |                              |
| 83                      | 0  |    |    |    | VOICE NAME 7  |    |    |    |                     |                              |
| 84                      | 0  |    |    |    | VOICE NAME 8  |    |    |    |                     |                              |
| 85                      | 0  |    |    |    | VOICE NAME 9  |    |    |    |                     |                              |
| 86                      | 0  |    |    |    | VOICE NAME 10 |    |    |    |                     |                              |
| 87                      | 0  |    |    |    | PR1           |    |    |    | 0-99                | PEG                          |
| 88                      | 0  |    |    |    | PR2           |    |    |    | 0-99                |                              |
| 89                      | 0  |    |    |    | PR3           |    |    |    | 0-99                |                              |
| 90                      | 0  |    |    |    | FL1           |    |    |    | 0-99                | (center=50)                  |
| 91                      | 0  |    |    |    | FL2           |    |    |    | 0-99                |                              |
| 92                      | 0  |    |    |    | FL3           |    |    |    | 0-99                |                              |

\*\*\* parameter change only \*\*\*

| nm (para.no) | b7 | b6 | b5 | b4 | b3  | b2  | b1  | b0  | dd (value) | comment          |
|--------------|----|----|----|----|-----|-----|-----|-----|------------|------------------|
| 93           | 0  | 0  | 0  | 0  | OP1 | OP2 | OP3 | OP4 | 0-1        | op. on(1)/off(0) |

note) S LS  
 LCD -99,,, -1,0,+1,,,+99  
 INT data/VCEDbulk LS2 1 -1,0,0 -0  
 (para. change) LS 99,,, 1,0,1,,,99  
 VMEbulk LS2 1 -1,0,0 -0  
 LS 99,,, 1,0,1,,,99

9 KVS  
 INT data 0,,,6,7,8,,,14  
 LCD -7,,, -1,0,+1,,,+7  
 MIDI 8,,,14,0,1,,,7

\*\*\* ACED \*\*\* 23 byte additional parameters ( 1 bulk edit format )  
para. cng g=4, h=3

| NO.(para) | b7 | b6 | b5 | b4 | b3 | b2 | b1 | b0 | Data          | note                    |
|-----------|----|----|----|----|----|----|----|----|---------------|-------------------------|
| 0         | 0  | 0  | 0  | 0  | 0  | 0  | 0  | 0  | FIX 0-1       | OP.4                    |
| 1         | 0  | 0  | 0  | 0  | 0  |    |    |    | FLXRG 0-7     | 0(255Hz)-7(32KHz)       |
| 2         | 0  | 0  | 0  | 0  | 0  |    |    |    | FINE 0-15     | (7:F=0-3)               |
| 3         | 0  | 0  | 0  | 0  | 0  |    |    |    | OSW 0-7       |                         |
| 4         | 0  | 0  | 0  | 0  | 0  | 0  |    |    | EGSFT- 0-3    | 0(off)-3(12dB)          |
| 5         |    |    |    |    |    |    |    |    |               | OP.2                    |
| 10        |    |    |    |    |    |    |    |    |               | OP.3                    |
| 15        |    |    |    |    |    |    |    |    |               | OP.1                    |
| 19        |    |    |    |    |    |    |    |    |               | 0(off)                  |
| 20        | 0  | 0  | 0  | 0  | 0  | 0  |    |    | REV 0-7       | 0(off),7(first)function |
| 21        | 0  |    |    |    |    |    |    |    | FC PITCH 0-99 | function                |
| 22        | 0  |    |    |    |    |    |    |    | FC AMPLI 0-99 |                         |

\*\*\* ACED2 \*\*\* 10 byte additional parameter 2 for DX11/V50  
para. cng g=4, h=3

| NO. para. Nob7 | b6 | b5 | b4 | b3 | b2 | b1 | b0 | Data                    | note          |
|----------------|----|----|----|----|----|----|----|-------------------------|---------------|
| 0              | 23 | 0  |    |    |    |    |    | AT PITCH 0-99           | function      |
| 1              | 24 | 0  |    |    |    |    |    | AT AMPLI 0-99           |               |
| 2              | 25 | 0  |    |    |    |    |    | AT P.BIAS 0-100         | center 0 = 50 |
| 3              | 26 | 0  |    |    |    |    |    | AT EG BIAS 0-99         |               |
| 4##            | 27 | 0  |    |    |    |    |    | FIX RANGE MODE(OP4) 0-1 | 0(HI),1(LO)   |
| 5##            | 28 | 0  |    |    |    |    |    | FIX RANGE MODE(OP2) 0-1 |               |
| 6##            | 29 | 0  |    |    |    |    |    | FIX RANGE MODE(OP3) 0-1 |               |
| 7##            | 30 | 0  |    |    |    |    |    | FIX RANGE MODE(OP1) 0-1 |               |
| 8##            | 31 | 0  | 0  | 0  | 0  |    |    | LS SIGN 0-15            | OP1,2,3,4     |
| 9              | 32 | 0  |    |    |    |    |    | reserved                |               |

note) 2 AT P.BIAS INT data 0,,,,,49,50,51,,,,,100  
 LCD -50,,,, -1, 0,+1,,,,,+50  
 MIDI 51,,,,,100,0,+1,,,,,+50  
 4-7 FIX RANGE MODE  
 INT data 0, 1 Hi:255-32KHz  
 LCD Hi, Lo Lo:1-100Hz  
 MIDI 0, 1  
 8 LS SIGN  
 b3 b2 b1 b0  
 op1 op2 op3 op4 0: +  
 1: -

\*\*\* ACED3 \*\*\* 20 byte additional parameter 3 for WT11/V50  
para. cng g=4, h=3

| NO. para. Nob7 | b6 | b5 | b4 | b3 | b2 | b1 | b0 | Data             | note                 |
|----------------|----|----|----|----|----|----|----|------------------|----------------------|
| 0              | 33 | 0  | 0  | 0  | 0  |    |    | EFCT SEL 0-32    | 0:off,1-32:EFCT(DSP) |
| 1              | 34 | 0  |    |    |    |    |    | BALANCE 0-100    |                      |
| 2              | 35 | 0  |    |    |    |    |    | CUT LEVEL 0-100  |                      |
| 3              | 36 | 0  |    |    |    |    |    | STEREO MIX 0-1   |                      |
| 4              | 37 | 0  |    |    |    |    |    | EFCT param1 0-75 |                      |
| 5              | 38 | 0  |    |    |    |    |    | EFCT param2 0-99 |                      |
| 6              | 39 | 0  |    |    |    |    |    | EFCT param3 0-99 | function             |
| 7              | 40 | 0  |    |    |    |    |    | reserved         |                      |
| 8              | 41 | 0  |    |    |    |    |    | reserved         |                      |
| 19             | 52 | 0  |    |    |    |    |    | reserved         |                      |

note) COMBINE  
 at COMBINE-off,  
 Function (function at VCED + func at ACED(REV,FCPM/AM)  
 + func at ACED2(AI/PM/AM/PB/EB) + EFCT at ACED3) are not changed  
 when voice/pfm is selected. (except voice name)

\*\*\* ACED \*\*\* 23 byte additional parameters (1 bulk edit format)  
para. cng g=4, h=3

| NO.(para) | b7 | b6 | b5 | b4 | b3  | b2  | b1  | b0  | Data          | note                    |
|-----------|----|----|----|----|-----|-----|-----|-----|---------------|-------------------------|
| 0         | 0  | 0  | 0  | 0  | 0   | 0   | 0   | 0   | FIX 0-1       | OP.4                    |
| 1         | 0  | 0  | 0  | 0  | 0   | --- | --- | --- | FIXRG 0-7     | 0(255Hz)-7(32KHz)       |
| 2         | 0  | 0  | 0  | 0  | --- | --- | --- | --- | FINE 0-15     | (7:F=0-3)               |
| 3         | 0  | 0  | 0  | 0  | 0   | --- | --- | --- | OGW 0-7       |                         |
| 4         | 0  | 0  | 0  | 0  | 0   | --- | --- | --- | EGSPT- 0-3    | 0(off)-3(12dB)          |
| 5         |    |    |    |    |     |     |     |     |               | OP.2                    |
| 10        |    |    |    |    |     |     |     |     |               | OP.3                    |
| 15        |    |    |    |    |     |     |     |     |               | OP.1                    |
| 19        |    |    |    |    |     |     |     |     | 0(off)        |                         |
| 20        | 0  | 0  | 0  | 0  | 0   | --- | --- | --- | REV 0-7       | 0(off),7(first)function |
| 21        | 0  |    |    |    |     |     |     |     | PC PITCH 0-99 | function                |
| 22        | 0  |    |    |    |     |     |     |     | PC AMPLI 0-99 |                         |

\*\*\* ACED2 \*\*\* 10 byte additional parameter 2 for DX11/V50  
para. cng g=4, h=3

| NO.(para) | Nob7 | b6 | b5 | b4 | b3 | b2 | b1 | b0 | Data                    | note          |
|-----------|------|----|----|----|----|----|----|----|-------------------------|---------------|
| 0         | 23   | 0  |    |    |    |    |    |    | AT PITCH 0-99           | function      |
| 1         | 24   | 0  |    |    |    |    |    |    | AT AMPLI 0-99           |               |
| 2         | 25   | 0  |    |    |    |    |    |    | AT P.BIAS 0-100         | center 0 = 50 |
| 3         | 26   | 0  |    |    |    |    |    |    | AT EG BIAS 0-99         |               |
| 4##       | 27   | 0  |    |    |    |    |    |    | FLX RANGE MODE(OP4) 0-1 | 0(HI),1(LO)   |
| 5##       | 28   | 0  |    |    |    |    |    |    | FLX RANGE MODE(OP2) 0-1 |               |
| 6##       | 29   | 0  |    |    |    |    |    |    | FLX RANGE MODE(OP3) 0-1 |               |
| 7##       | 30   | 0  |    |    |    |    |    |    | FLX RANGE MODE(OP1) 0-1 |               |
| 8##       | 31   | 0  | 0  | 0  | 0  |    |    |    | LS SIGN 0-15            | OP1,2,3,4     |
| 9         | 32   | 0  |    |    |    |    |    |    | reserved                |               |

note) 2 AT P.BIAS INT data 0, ..., 49, 50, 51, ..., 100  
LCD -50, ..., -1, 0, +1, ..., +50  
MIDI 51, ..., 100, 0, +1, ..., +50

4-7 FIX RANGE MODE  
INT data 0, 1 Hi:255-32KHz  
LCD Hi, Lo Lo:1-100Hz  
MIDI 0, 1

8 LS SIGN  
b3 b2 b1 b0  
op1 op2 op3 op4 0: +  
1: -

\*\*\* ACED3 \*\*\* 20 byte additional parameter 3 for WT11/V50  
para. cng g=4, h=3

| NO.(para) | Nob7 | b6 | b5 | b4 | b3 | b2 | b1 | b0 | Data             | note                 |
|-----------|------|----|----|----|----|----|----|----|------------------|----------------------|
| 0         | 33   | 0  | 0  | 0  | 0  |    |    |    | EFCT SEL 0-32    | 0:off,1-32:EFCT(DSP) |
| 1         | 34   | 0  |    |    |    |    |    |    | BALANCE 0-100    |                      |
| 2         | 35   | 0  |    |    |    |    |    |    | CUT LEVEL 0-100  |                      |
| 3         | 36   | 0  |    |    |    |    |    |    | STEREO MIX 0-1   |                      |
| 4         | 37   | 0  |    |    |    |    |    |    | EFCT param1 0-75 |                      |
| 5         | 38   | 0  |    |    |    |    |    |    | EFCT param2 0-99 |                      |
| 6         | 39   | 0  |    |    |    |    |    |    | EFCT param3 0-99 | function             |
| 7         | 40   | 0  |    |    |    |    |    |    | reserved         |                      |
| 8         | 41   | 0  |    |    |    |    |    |    | reserved         |                      |
| 19        | 52   | 0  |    |    |    |    |    |    | reserved         |                      |

note) COMBINE  
at COMBINE=off,  
Function (function at VCED + func at ACED(REV,FCPM/AM)  
+ func at ACED2(ATPM/AM/PB/EB) + EFCT at ACED3) are not changed  
when voice/pfm is selected. (except voice name)

\*\*\* PCED \*\*\* 110 byte Performance data (edit format)  
para. cng g=4, h=0

| No.prm# | b7 | b6 | b5 | b4 | b3 | b2 | b1 | b0 | Data              | note                                     |
|---------|----|----|----|----|----|----|----|----|-------------------|------------------------------------------|
| 0       | 0  | 0  | 0  | 0  |    |    |    |    | MAX NOTES 0-16    | INST1                                    |
| 1 ##    | 0  | 0  | 0  | 0  | 0  | 0  | 0  | 0  | VTYPE 0-1         | voice type 0:int/card<br>1:preset        |
| 2 ##    | 0  |    |    |    |    |    |    |    | Voice Number 0-99 |                                          |
| 3       | 0  | 0  | 0  | 0  |    |    |    |    | Recv. ch 0-16     | 16(omni)                                 |
| 4       | 0  |    |    |    |    |    |    |    | LIMIT/L 0-127     | 0(C-2)-127(G8)                           |
| 5       | 0  |    |    |    |    |    |    |    | LIMIT/H 0-127     |                                          |
| 6       | 0  | 0  | 0  | 0  |    |    |    |    | DETUNE 0-14       | 7(center)                                |
| 7       | 0  | 0  |    |    |    |    |    |    | NOTE SHIFT 0-48   | 24 (center)                              |
| 8       | 0  |    |    |    |    |    |    |    | VOLUME 0-99       |                                          |
| 9       | 0  | 0  | 0  | 0  | 0  | 0  | 0  | 0  | CUT_ASGN 0-3      | 0(off),1(L),2(R)<br>3(L+R)               |
| 10      | 0  | 0  | 0  | 0  | 0  | 0  | 0  | 0  | LPOS 0-3          | 0(off),1(1st Inst)<br>2(2nd Inst),3(vib) |
| 11      | 0  | 0  | 0  | 0  | 0  | 0  | 0  | 0  | MTE 0-1           |                                          |
| 12      |    |    |    |    |    |    |    |    |                   | INST2                                    |
| 24      |    |    |    |    |    |    |    |    |                   | INST3                                    |
| 36      |    |    |    |    |    |    |    |    |                   | INST4                                    |
| 48      |    |    |    |    |    |    |    |    |                   | INST5                                    |
| 60      |    |    |    |    |    |    |    |    |                   | INST6                                    |
| 72      |    |    |    |    |    |    |    |    |                   | INST7                                    |
| 84      |    |    |    |    |    |    |    |    |                   | INST8                                    |
| 96      | 0  | 0  | 0  | 0  | 0  |    |    |    | MITBL 0-12        | 0(oct),1(full)                           |
| 97 ##   | 0  | 0  | 0  | 0  | 0  | 0  | 0  | 0  | ASMODE 0-2        | 0(norm),1(alter)<br>2(DVA)               |
| 98 ###  | 0  | 0  | 0  | 0  | 0  |    |    |    | EFSEL 0-12        |                                          |
| 99      | 0  | 0  | 0  | 0  | 0  |    |    |    | KEY 0-11          | 0(C)-11(B)                               |
| 100     | 0  |    |    |    |    |    |    |    | PFM NAME 1 32-127 | ASCII                                    |
| 101     | 0  |    |    |    |    |    |    |    | 2                 |                                          |
| 109     | 0  |    |    |    |    |    |    |    | PFM NAME 10       |                                          |

note) 98 EFSEL=0(off),1(delay1),2(pan1),3(chord1),4(delay2),5(pan2),.....  
.....,11(pan4),12(chord4)

\*\*\* PCED2 \*\*\* 33 byte Performance data 2 (edit format) for V50/WT11  
para. cng g=4, h=0, p=110

| No.prm# | b7 | b6 | b5 | b4 | b3 | b2 | b1 | b0 | Data               | note                   |
|---------|----|----|----|----|----|----|----|----|--------------------|------------------------|
| 0       | 0  | 0  | 0  | 0  |    |    |    |    | RESERVE NOTES 0-17 | 0(off),1-17(0-16)INST1 |
| 1       | 0  | 0  | 0  | 0  | 0  | 0  | 0  | 0  | EFCTE 0-1          | EFCT(DSP) on/off       |
| 2       |    |    |    |    |    |    |    |    |                    | INST2                  |
| 3       |    |    |    |    |    |    |    |    |                    |                        |
| 4       |    |    |    |    |    |    |    |    |                    | INST3                  |
| 5       |    |    |    |    |    |    |    |    |                    |                        |
| 6       |    |    |    |    |    |    |    |    |                    | INST4                  |
| 7       |    |    |    |    |    |    |    |    |                    |                        |
| 8       |    |    |    |    |    |    |    |    |                    | INST5                  |
| 9       |    |    |    |    |    |    |    |    |                    |                        |
| 10      |    |    |    |    |    |    |    |    |                    | INST6                  |
| 11      |    |    |    |    |    |    |    |    |                    |                        |
| 12      |    |    |    |    |    |    |    |    |                    | INST7                  |
| 13      |    |    |    |    |    |    |    |    |                    |                        |
| 14      |    |    |    |    |    |    |    |    |                    | INST8                  |
| 15      |    |    |    |    |    |    |    |    |                    |                        |
| 16      | 0  | 0  | 0  | 0  |    |    |    |    | EFCT SEL 0-32      | 0:off,1-32:EFCT(DSP)   |
| 17      | 0  |    |    |    |    |    |    |    | BALANCE 0-100      |                        |
| 18      | 0  |    |    |    |    |    |    |    | CUT LEVEL 0-100    |                        |
| 19      | 0  |    |    |    |    |    |    |    | STEREO MIX 0-1     |                        |
| 20      | 0  |    |    |    |    |    |    |    | EFCT param1 0-75   |                        |
| 21      | 0  |    |    |    |    |    |    |    | EFCT param2 0-99   |                        |
| 22      | 0  |    |    |    |    |    |    |    | EFCT param3 0-99   |                        |
| 23      | 0  |    |    |    |    |    |    |    | reserved 0-2       | LFO CONTROL for WT11   |
| 24      | 0  |    |    |    |    |    |    |    | reserved           |                        |
| 32      | 0  |    |    |    |    |    |    |    | reserved           |                        |

\*\*\* remote switch \*\*\*  
para. cng g=4, h=0, p=118

| g | h | p   | k  | switch      | k  | switch            |
|---|---|-----|----|-------------|----|-------------------|
| 4 | 0 | 118 | 0  | performance | 31 | tenkey minus      |
|   |   |     | 1  | single      | 32 | increment         |
|   |   |     | 2  | internal    | 33 | decrement         |
|   |   |     | 3  | card        | 34 | tr1               |
|   |   |     | 4  | preset      | 35 | tr2               |
|   |   |     | 5  | sequencer   | 36 | tr3               |
|   |   |     | 6  | rhythm      | 37 | tr4               |
|   |   |     | 7  | record      | 38 | limit/lo          |
|   |   |     | 8  | hwd         | 39 | limit/hi          |
|   |   |     | 9  | stop        | 40 | tr5               |
|   |   |     | 10 | play        | 41 | tr6               |
|   |   |     | 11 | fwd         | 42 | tr7               |
|   |   |     | 12 | seq/rhy job | 43 | tr8               |
|   |   |     | 13 | pf1         | 44 | others            |
|   |   |     | 14 | pf2         | 45 | efct              |
|   |   |     | 15 | pf3         | 46 | ut-card           |
|   |   |     | 16 | pf4         | 47 | ut-midi           |
|   |   |     | 17 | pf5         | 48 | ut-disk           |
|   |   |     | 18 | pf6         | 49 | ut-prot           |
|   |   |     | 19 | pf7         | 50 | ut-setup          |
|   |   |     | 20 | pf8         | 51 | ut-others         |
|   |   |     | 21 | tenkey 0    | 52 | store             |
|   |   |     | 22 | tenkey 1    | 53 | compare           |
|   |   |     | 23 | tenkey 2    | 54 | efct bypass       |
|   |   |     | 24 | tenkey 3    | 55 | demo              |
|   |   |     | 25 | tenkey 4    | 56 | POWER ON(restart) |
|   |   |     | 26 | tenkey 5    |    |                   |
|   |   |     | 27 | tenkey 6    |    |                   |
|   |   |     | 28 | tenkey 7    |    |                   |
|   |   |     | 29 | tenkey 8    |    |                   |
|   |   |     | 30 | tenkey 9    |    |                   |

< Table 2 >

Detail of Bulk Dump Format

```

★ VCED
 f = 3
 data size = 93 ($005D)
 data format = 7bit binary
 total bulk size = 93+8 = 101
 f0,43,0n,03,00,5D,<VCED data>,sum,f7

★ VMEM
block header
f0,43,1n,44,07,<block No 1-4>,f7

 f = 4
 data size = 128x32 = 4096 ($1000)
 data format = 7bit binary
 total bulk size = 4096+8 = 4104
 f0,43,0n,04,20,00,<VMEM data>,sum,f7

★ ACED
 f = 126 LM 8976AE
 data size = 23+10 = 33 ($0021)
 data format = 7bit binary
 total bulk size = 33+8 = 41
 f0,43,0n,7e,00,21,LM_8976AE,<ACED data>,sum,f7

★ ACED2
 f = 126 LM 8023AE
 data size = 10+10 = 20 ($0014)
 data format = 7bit binary
 total bulk size = 20+8 = 28
 f0,43,0n,7e,00,14,LM_8023AE,<ACED2 data>,sum,f7

★ ACED3
 f = 126 LM 8073AE
 data size = 20+10 = 30 ($001e)
 data format = 7bit binary
 total bulk size = 30+8 = 38
 f0,43,0n,7e,00,1e,LM_8073AE,<ACED3 data>,sum,f7

★ PCED
 f = 126 LM 8976PE
 data size = 110+10 = 120 ($0078)
 data format = 7bit binary
 total bulk size = 120+8 = 128
 f0,43,0n,7e,00,78,LM_8976PE,<PCED data>,sum,f7

★ PCED2
 f = 126 LM 8073PE
 data size = 10+33 = 43 ($002B)
 data format = 7bit binary
 total bulk size = 43+8 = 51
 f0,43,0n,7e,00,2b,LM_8073PE,<PCED2 data>,sum,f7

★ PMEM
block header
f0,43,1n,10,75,01,<block No 0-3>,f7

 f = 126 LM 8976PM
 data size = 10+76x32 = 2442 ($098A)
 data format = 7bit binary
 total bulk size = 2442+8 = 2450
 f0,43,0n,7e,13,0a,LM_8976PM,<PMEM data >,sum,f7

★ PMEM2
 f = 126 LM 8073PM
 data size = 10+25x32 = 810 ($032A)
 data format = 7bit binary
 total bulk size = 810+8 = 818
 f0,43,0n,7e,06,2a,LM_8073PM,<PMEM2 data >,sum,f7

★ system setup
 f = 126 LM 8976Sx (x=0,1,2)

X = 0(SYS) data size = 10+27 = 37 ($0025)
 data format = 7bit binary
 total data size = 37+8 = 45
 f0,43,0n,7e,00,25,LM_8976S0,<system data>,sum,f7

X = 1(PC) data size = 10+128x2 = 266 ($010A)
 data format = 7bit binary
 total data size = 266+8 = 274
 f0,43,0n,7e,02,0a,LM_8976S1,<P.CNGTBL data>,sum,f7

X = 2(EFG1) delay1,pan1,chord1
 data size = 10+55 = 65 ($0041)
 data format = 7bit binary
 total data size = 65+8 = 73
 f0,43,0n,7e,00,41,LM_8976S2,<effect group1 data>,sum,f7

X = 3(EFG2) delay2,pan2,chord2
 f0,43,0n,7e,00,41,LM_8976S3,<effect group2 data>,sum,f7

X = 4(EFG3) delay3,pan3,chord3
 f0,43,0n,7e,00,41,LM_8976S4,<effect group3 data>,sum,f7

X = 5(EFG4) delay4,pan4,chord4
 f0,43,0n,7e,00,41,LM_8976S5,<effect group4 data>,sum,f7

★ micro tuning buffer
 f = 126 LM MCRTEX (x=0,1)
X = 0 (OCT) data size = 24+10 = 34 ($0022)
 data format = 7bit binary
 total bulk size = 34+8 = 42
 f0,43,0n,7e,00,22,LM_MCRTEX,<MCR OCT data>,sum,f7

X = 1 (Full) data size = 10+256 = 266 ($010a)
 data format = 7bit binary
 total bulk size = 274
 f0,43,0n,7e,02,0a,LM_MCRTEX,<MCR Full data>,sum,f7

★ system setup 2 for V2
 f = 126 LM 8023Sx (x=0)
X = 0(SYS2) data size = 16+10 = 26 ($001A)
 data format = 7bit binary
 total data size = 26+8 = 34
 f0,43,0n,7e,00,1a,LM_8023S0,<system data>,sum,f7

★ system setup 3 for V50
 f = 126 LM 8073S0
 data size = 32+10 = 42 ($002A)
 data format = 7bit binary
 total data size = 42+8 = 50
 f0,43,0n,7e,00,2a,LM_8073S0,<system data3>,sum,f7

```

```

★ SEQ system setup (SVSQ) for V50
 f = 126 LM 8073SS
 data size = 33*10 = 43 ($002B)
 data format = 7bit binary
 total data size = 43*8 = 51

 f0,43,0n,7e,00,2b,LM_8073SS,<SEQ system data>,sum,F7

★ RHYTHM system setup (SYSR) for V50
 f = 126 LM 8073RS
 data size = 16*10 = 26 ($001a)
 data format = 7bit binary
 total data size = 26*8 = 34

 f0,43,0n,7e,00,1a,LM_8073RS,<RHYTHM system data>,sum,F7

★ RHYTHM inst setup (RINST) for V50
 f = 126 LM 8073RI
 data size = 183*10 = 193 ($0141)
 data format = 7bit binary
 total data size = 193*8 = 201

 f0,43,0n,7e,01,41,LM_8073RI,<RINST data>,sum,F7

★ RHYTHM kbd assign table (RKAT1,2) for V50
 f = 126 LM 8073Kx (x=0:user1,1:user2)
 data size = 61*10 = 71 ($0047)
 data format = 7bit binary
 total data size = 71*8 = 79

 f0,43,0n,7e,00,47,LM_8073K0,<RKAT1 data>,sum,F7
 f0,43,0n,7e,00,47,LM_8073K1,<RKAT2 data>,sum,F7

```

note) KVS,KVS2

| MIDI           |                 | LCD |    |
|----------------|-----------------|-----|----|
| at VCED<br>KVS | at VMEM<br>KVS2 | KVS |    |
| 0              | 0               | 0   | 0  |
| 1              | ^               | 1   | +1 |
| .              | ^               | .   | .  |
| .              | ^               | .   | .  |
| 7              | 0               | 7   | +7 |
| 8              | 1               | 7   | -7 |
| .              | ^               | .   | .  |
| .              | ^               | .   | .  |
| 14             | 1               | 1   | -1 |

5 LS LCD VMEMbulk LS2 LS

-99,,, -1,0,+1,,,+99  
1-1,0,0-0  
99,,,1,0,1,,,99

< Table 3 >

\*\*\* VMEM \*\*\* 128 byte (88 byte is used) voice data ( memory format )

| * | address | b7 | b6  | b5   | b4  | b3    | b2     | b1  | b0 | dd                  | comment | * |
|---|---------|----|-----|------|-----|-------|--------|-----|----|---------------------|---------|---|
| * |         |    |     |      |     |       |        |     |    | (value)             |         | * |
| * | 0       | 0  | 0   | 0    | AR  |       |        |     |    | 0-31                |         | * |
| * | 1       | 0  | 0   | 0    | D1R |       |        |     |    | 0-31                |         | * |
| * | 2       | 0  | 0   | 0    | D2R |       |        |     |    | 0-31                |         | * |
| * | 3       | 0  | 0   | 0    | 0   | RR    |        |     |    | 1-15                |         | * |
| * | 4       | 0  | 0   | 0    | 0   | DLL   |        |     |    | 0-15                | OP.4    | * |
| * | 5       | 0  |     |      | LS  |       |        |     |    | 0-99                |         | * |
| * | 6       | 0  | AME |      | EBS |       |        |     |    | 0-1,0-7,0-7         |         | * |
| * | 7       | 0  |     |      | OUT |       |        |     |    | 0-99                |         | * |
| * | 8       | 0  | 0   |      | CRS |       |        |     |    | 0-63 (RATIO)        |         | * |
| * | 9       | 0  | 0   |      | CRS | x     | x      |     |    | 0-63 (FIX)          |         | * |
| * | ## 9    | 0  | LS2 | KVS2 | RS  |       |        | DET |    | 0-1,0-1,0-3,0-6     |         | * |
| * |         |    |     |      |     |       |        |     |    | LS2,KVS2 (sign)     |         | * |
| * | 10      |    |     |      |     |       |        |     |    |                     | OP.2    | * |
| * | .       |    |     |      |     |       |        |     |    |                     |         | * |
| * | 20      |    |     |      |     |       |        |     |    |                     | OP.3    | * |
| * | .       |    |     |      |     |       |        |     |    |                     |         | * |
| * | 30      |    |     |      |     |       |        |     |    |                     | OP.1    | * |
| * | .       |    |     |      |     |       |        |     |    |                     |         | * |
| * | 40      | 0  | SY  |      | FBL |       |        | ALG |    | 0-1,0-7,0-7         |         | * |
| * | 41      | 0  |     |      | LFS |       |        |     |    | 0-99                |         | * |
| * | 42      | 0  |     |      | LFD |       |        |     |    | 0-99                |         | * |
| * | 43      | 0  |     |      | PMD |       |        |     |    | 0-99                |         | * |
| * | 44      | 0  |     |      | AMD |       |        |     |    | 0-99                |         | * |
| * | 45      | 0  |     | PMS  |     | AMS   |        | LFW |    | 0-7,0-3,0-3         |         | * |
| * | 46      | 0  | 0   |      |     | TRPS  |        |     |    | 0-48                |         | * |
| * | 47      | 0  | 0   | 0    | 0   |       |        | PBR |    | 0-12                |         | * |
| * | 48      | 0  | x   | x    | CH  | MD    | SU     | PO  | PM | 0-1,0-1,0-1,0-1,0-1 |         | * |
| * | 49      | 0  |     |      |     | PORT  |        |     |    | 0-99                |         | * |
| * | 50      | 0  |     |      |     | FC    | VOL    |     |    | 0-99                |         | * |
| * | 51      | 0  |     |      |     | MW    | PITCH  |     |    | 0-99                |         | * |
| * | 52      | 0  |     |      |     | MW    | AMPLI  |     |    | 0-99                |         | * |
| * | 53      | 0  |     |      |     | BC    | PITCH  |     |    | 0-99                |         | * |
| * | 54      | 0  |     |      |     | BC    | AMPLI  |     |    | 0-99                |         | * |
| * | 55      | 0  |     |      |     | BC    | P BIAS |     |    | 0-100               |         | * |
| * | 56      | 0  |     |      |     | BC    | E BIAS |     |    | 0-99                |         | * |
| * | 57      | 0  |     |      |     | VOICE | NAME   | 1   |    | 32-127              |         | * |
| * | 58      | 0  |     |      |     | VOICE | NAME   | 2   |    |                     |         | * |
| * | 59      | 0  |     |      |     | VOICE | NAME   | 3   |    |                     |         | * |
| * | 60      | 0  |     |      |     | VOICE | NAME   | 4   |    |                     |         | * |
| * | 61      | 0  |     |      |     | VOICE | NAME   | 5   |    |                     |         | * |
| * | 62      | 0  |     |      |     | VOICE | NAME   | 6   |    |                     |         | * |
| * | 63      | 0  |     |      |     | VOICE | NAME   | 7   |    |                     |         | * |
| * | 64      | 0  |     |      |     | VOICE | NAME   | 8   |    |                     |         | * |
| * | 65      | 0  |     |      |     | VOICE | NAME   | 9   |    |                     |         | * |
| * | 66      | 0  |     |      |     | VOICE | NAME   | 10  |    |                     |         | * |
| * | ## 67   | 0  |     |      |     | PR1   |        |     |    | 0-99                |         | * |
| * | ## 68   | 0  |     |      |     | PR2   |        |     |    | 0-99                |         | * |
| * | ## 69   | 0  |     |      |     | PR3   |        |     |    | 0-99                |         | * |
| * | ## 70   | 0  |     |      |     | PL1   |        |     |    | 0-99                |         | * |
| * | ## 71   | 0  |     |      |     | PL2   |        |     |    | 0-99                |         | * |
| * | ## 72   | 0  |     |      |     | PL3   |        |     |    | 0-99                |         | * |

\*\*\* VMEM \*\*\*

| No. | b7 | b6 | b5    | b4      | b3  | b2 | b1    | b0  | Data  | note              |
|-----|----|----|-------|---------|-----|----|-------|-----|-------|-------------------|
| 0   |    |    |       |         |     |    |       |     |       | same as DX21 VMEM |
| 67  |    |    |       |         |     |    |       |     |       | PEG PR1           |
| 72  |    |    |       |         |     |    |       |     |       | PEG PL3           |
| 73  | ## | 0  | FIXRM | -EGSFT- | FLX |    | FIXRG |     |       | OP.4              |
| 74  |    | 0  | OSW   |         |     |    | FINE  |     |       |                   |
| 75  |    |    |       |         |     |    |       |     |       | OP.2              |
| 77  |    |    |       |         |     |    |       |     |       | OP.3              |
| 79  |    |    |       |         |     |    |       |     |       | OP.1              |
| 81  | 0  | 0  | 0     | 0       | 0   |    |       | REV |       | FUNCTION          |
| 82  | 0  |    |       |         |     |    |       | FC  | PITCH |                   |
| 83  | 0  |    |       |         |     |    |       | FC  | AMPLI |                   |

\*\*\* VMEM for DX11/V50 \*\*\*

| No.     | b7 | b6 | b5 | b4 | b3 | b2 | b1 | b0 | Data | note               |
|---------|----|----|----|----|----|----|----|----|------|--------------------|
| 84      | 0  |    |    |    |    |    |    |    |      | AT PITCH           |
| 85      | 0  |    |    |    |    |    |    |    |      | AT AMPLI           |
| 86      | 0  |    |    |    |    |    |    |    |      | AT P.BIAS          |
| 87      | 0  |    |    |    |    |    |    |    |      | AT EG BIAS         |
| 88      | 0  |    |    |    |    |    |    |    |      | reserved           |
| 89      | 0  |    |    |    |    |    |    |    |      | reserved           |
| 90      | 0  |    |    |    |    |    |    |    |      | reserved           |
| 91      | 0  | 0  | 0  | 0  | 0  |    |    |    |      | -EFFECT PRESET NO- |
| 92      | 0  | 0  |    |    |    |    |    |    |      | EFFECT TIME        |
| 93      | 0  |    |    |    |    |    |    |    |      | EFFECT BALANCE     |
| 94      | ## | 0  | 0  | 0  |    |    |    |    |      | EFCT SEL           |
| 95      | ## | 0  |    |    |    |    |    |    |      | BALANCE            |
| 96      | ## | 0  |    |    |    |    |    |    |      | OUT LEVEL          |
| 97      | ## | 0  |    |    |    |    |    |    |      | STEREO MIX         |
| 98      | ## | 0  |    |    |    |    |    |    |      | EFCT param1        |
| 99      | ## | 0  |    |    |    |    |    |    |      | EFCT param2        |
| 100     | ## | 0  |    |    |    |    |    |    |      | EFCT param3        |
| 101-127 | 0  | 0  | 0  | 0  | 0  | 0  | 0  | 0  | 0    |                    |

note) AT P.BIAS INT data 0,,,,,49,50,51,,,,,100  
LCD -50,,,,-1,0,+1,,,,,+50  
MIDI 51,,,,,100,0,+1,,,,,+50

FIX RANGE MODE INT data 0, 1  
LCD Hi, Lo  
MIDI 0, 1

VMEM receive block ( parameter change ) g=9,h=0 same as EOS

| paramNo. | b7 | b6 | b5 | b4 | b3 | b2 | b1 | b0 | Data | note                       |
|----------|----|----|----|----|----|----|----|----|------|----------------------------|
| 7        | 0  | 0  | 0  | 0  | 0  |    |    |    |      | 0-4 0:32voice<br>1-4:block |

\*\*\* PMEM \*\*\* 76 byte Performance data (memory format)

| No.      | b7 | b6          | b5      | b4            | b3                | b2 | b1    | b0 | Data  | note  |
|----------|----|-------------|---------|---------------|-------------------|----|-------|----|-------|-------|
| 0 ##     | 0  | OUT         | ASGN    | VTYPE         | -MAX NOTES(MAX1)- |    |       |    | INST1 |       |
| 1 ##     | 0  | VOICE NO    |         |               |                   |    |       |    |       |       |
| 2        | 0  | -LPOS       |         | RCV CH        |                   |    |       |    |       |       |
| 3        | 0  | LIMIT/L     |         |               |                   |    |       |    |       |       |
| 4        | 0  | LIMIT/H     |         |               |                   |    |       |    |       |       |
| 5        | 0  | 0           | 0       | 0             | DETUNE            |    |       |    |       |       |
| 6        | 0  | MIE         |         |               | NOTE              |    | SHIFT |    |       |       |
| 7        | 0  | VOLUME      |         |               |                   |    |       |    |       |       |
| -----    |    |             |         |               |                   |    |       |    |       |       |
| 8        |    |             |         |               |                   |    |       |    |       | INST2 |
| -----    |    |             |         |               |                   |    |       |    |       |       |
| 16       |    |             |         |               |                   |    |       |    |       | INST3 |
| -----    |    |             |         |               |                   |    |       |    |       |       |
| 24       |    |             |         |               |                   |    |       |    |       | INST4 |
| -----    |    |             |         |               |                   |    |       |    |       |       |
| 32       |    |             |         |               |                   |    |       |    |       | INST5 |
| -----    |    |             |         |               |                   |    |       |    |       |       |
| 40       |    |             |         |               |                   |    |       |    |       | INST6 |
| -----    |    |             |         |               |                   |    |       |    |       |       |
| 48       |    |             |         |               |                   |    |       |    |       | INST7 |
| -----    |    |             |         |               |                   |    |       |    |       |       |
| 56       |    |             |         |               |                   |    |       |    |       | INST8 |
| -----    |    |             |         |               |                   |    |       |    |       |       |
| 64 ##### | 0  | EFSEL3      | -EFSEL2 | -MTIBL        |                   |    |       |    |       |       |
| 65       | 0  | KEY         |         | EFSEL1-ASMOD1 |                   |    |       |    |       |       |
| 66       | 0  | PFM NAME 1  |         |               |                   |    |       |    |       |       |
| 67       | 0  | PFM NAME 2  |         |               |                   |    |       |    |       |       |
| -----    |    |             |         |               |                   |    |       |    |       |       |
| 75       | 0  | PFM NAME 10 |         |               |                   |    |       |    |       |       |

note1) effect select

| PCED  | EFSEL  | PMEM | EFSEL2 | EFSEL1 |
|-------|--------|------|--------|--------|
| 0     | off    |      | %00    | %00    |
| 1     | delay1 |      | %01    | %01    |
| 2     | pan1   |      | %10    | %10    |
| 3     | chord1 |      | %11    | %11    |
| ----- |        |      |        |        |
| 4     | d2     |      | %01    | %01    |
| 5     | p2     |      | %10    | %10    |
| 6     | c2     |      | %11    | %11    |
| ----- |        |      |        |        |
| 7     | d3     |      | %10    | %01    |
| 8     | p3     |      | %10    | %10    |
| 9     | c3     |      | %11    | %11    |
| ----- |        |      |        |        |
| 10    | d4     |      | %11    | %01    |
| 11    | p4     |      | %10    | %10    |
| 12    | c4     |      | %11    | %11    |

%01 %00 →off(%00 %00)  
 %10 %00 →off(%00 %00)  
 %11 %00 →off(%00 %00)

EFSEL(PCED) = EFSEL2 x 3 + EFSEL1

note2) Effect select Compatibility (DX11 → TX81Z)

| PMEM bulk                      | DX11 | TX81Z |
|--------------------------------|------|-------|
| delay1, delay2, delay3, delay4 | →    | delay |
| pan1, pan2, pan3, pan4         | →    | pan   |
| chord1, chord2, chord3, chord4 | →    | chord |
| -----                          |      |       |
| PCED bulk                      |      |       |
| delay1                         | →    | delay |
| pan1                           | →    | pan   |
| chord1                         | →    | chord |
| delay2 - chord4                | →    | chord |

\*\*\* PMEM2 \*\*\* 25 byte Performance data 2(memory format) for V50/WT11

| No.   | b7 | b6          | b5 | b4            | b3                   | b2             | b1       | b0                   | Data           | note |
|-------|----|-------------|----|---------------|----------------------|----------------|----------|----------------------|----------------|------|
| 0 ##  | 0  | EFCTE       | 0  | RESERVE NOTES |                      | 0-1,0-17 INST1 |          |                      |                |      |
| 1 ##  | 0  | EFCTE       | 0  | RESERVE NOTES |                      | 0-1,0-17 INST2 |          |                      |                |      |
| 2 ##  | 0  | EFCTE       | 0  | RESERVE NOTES |                      | 0-1,0-17 INST3 |          |                      |                |      |
| 3 ##  | 0  | EFCTE       | 0  | RESERVE NOTES |                      | 0-1,0-17 INST4 |          |                      |                |      |
| 4 ##  | 0  | EFCTE       | 0  | RESERVE NOTES |                      | 0-1,0-17 INST5 |          |                      |                |      |
| 5 ##  | 0  | EFCTE       | 0  | RESERVE NOTES |                      | 0-1,0-17 INST6 |          |                      |                |      |
| 6 ##  | 0  | EFCTE       | 0  | RESERVE NOTES |                      | 0-1,0-17 INST7 |          |                      |                |      |
| 7 ##  | 0  | EFCTE       | 0  | RESERVE NOTES |                      | 0-1,0-17 INST8 |          |                      |                |      |
| ----- |    |             |    |               |                      |                |          |                      |                |      |
| 8 ##  | 0  | 0           | 0  | EFCT SEL      |                      | 0-32           |          | 0:off,1-32:EFCT(DSP) |                |      |
| 9 ##  | 0  | BALANCE     |    |               | 0-100                |                |          |                      |                |      |
| 10 ## | 0  | CUT LEVEL   |    |               | 0-100                |                |          |                      |                |      |
| 11 ## | 0  | STEREO MIX  |    |               | 0-1                  |                |          |                      |                |      |
| 12 ## | 0  | EFCT param1 |    |               | 0-75                 |                |          |                      |                |      |
| 13 ## | 0  | EFCT param2 |    |               | 0-99                 |                |          |                      |                |      |
| 14 ## | 0  | EFCT param3 |    |               | 0-99                 |                |          |                      |                |      |
| 15    | 0  | reserved    |    |               | LFO CONTROL for WT11 |                |          |                      |                |      |
| 16 ## | 0  | x           | x  | x             | x                    | x              | -ASMOD2- |                      | 0-1 (DVA flag) |      |
| 17 ## | 0  | x           | x  | x             | -MAX2-               | -MAX2-         | 0-1,0-1  |                      | INST1, INST2   |      |
| 18 ## | 0  | x           | x  | x             | -MAX2-               | -MAX2-         | 0-1,0-1  |                      | INST3, INST4   |      |
| 19 ## | 0  | x           | x  | x             | -MAX2-               | -MAX2-         | 0-1,0-1  |                      | INST5, INST6   |      |
| 20 ## | 0  | x           | x  | x             | -MAX2-               | -MAX2-         | 0-1,0-1  |                      | INST7, INST8   |      |
| 21    | 0  | reserved    |    |               |                      |                |          |                      |                |      |
| 22    | 0  | reserved    |    |               |                      |                |          |                      |                |      |
| 23    | 0  | reserved    |    |               |                      |                |          |                      |                |      |
| 24    | 0  | reserved    |    |               |                      |                |          |                      |                |      |

note) MAX NOTES= 8 x MAX2 + MAX1 (<=16)

MAX NOTES Compatibility (V50 → DX11) MAX1 only

ASMOD2=2 x ASMOD2 + ASMOD1

PMEM receive block ( parameter change ) g=4,h=0,p=117,

| paramNo. | b7 | b6 | b5 | b4 | b3 | b2 | b1 | b0      | Data | note      |
|----------|----|----|----|----|----|----|----|---------|------|-----------|
| 1        | 0  | 0  | 0  | 0  | 0  | 0  | 0  | -BLOCK- | 0-3  | 0-3:block |

\*\*\*\*\*  
 \* SYSTEM SETUP bulk dump \*  
 \*\*\*\*\*

\*\*\* SYS \*\*\* 27 byte system set up for TX81Z  
 para. cng g=4, h=0, p=123

| No.   | para | b7 | b6   | b5        | b4     | b3                          | b2                                                        | b1            | b0             | Data                                  | note                             |
|-------|------|----|------|-----------|--------|-----------------------------|-----------------------------------------------------------|---------------|----------------|---------------------------------------|----------------------------------|
| 0     | 0    | 0  | TUNE |           |        | 0-127 master tune center=64 |                                                           |               |                |                                       |                                  |
| 1     | 1    | 0  | 0    | 0         | MIDBCH |                             | 0-16 basic rcv ch 16:omni                                 |               |                |                                       |                                  |
| 2     | 2    | 0  | 0    | 0         | 0      | MIDTCH                      |                                                           | 0-15 trans ch |                |                                       |                                  |
| 3 ##3 | 0    | 0  | 0    | 0         | 0      | 0                           | PGMSW                                                     |               | 0-4 pgm cng sw |                                       |                                  |
| 4     | 4    | 0  | 0    | 0         | CONTSW |                             | 0-17 cont.cng sw 1:norm<br>2-17(G1-G16)                   |               |                |                                       |                                  |
| 5     | 5    | 0  | 0    | 0         | PBSW   |                             | 0-17 p.bend sw 1:norm<br>2-17(G1-G16)                     |               |                |                                       |                                  |
| 6     | 6    | 0  | 0    | 0         | 0      | 0                           | 0                                                         | -NOTESW-      |                | 0-2 note on/off 0:all,1:odd<br>2:even |                                  |
| 7 ##7 | 0    | 0  | 0    | DEVICE NO |        |                             | 0-17 device number 0:off,17:all<br>( V2 exclusive on/off) |               |                |                                       |                                  |
| 8     | 8    | 0  | 0    | 0         | 0      | 0                           | 0                                                         | 0             | MLOCK          |                                       | 0-1 mem. protect                 |
| 9     | 9    | 0  | 0    | 0         | 0      | 0                           | 0                                                         | 0             | CMBIN          |                                       | 0-1 combine                      |
| 10    | 10   | 0  | 0    | 0         | 0      | 0                           | 0                                                         | 0             | ATBCSW         |                                       | 0-1 AT to BC sw on/off(not used) |
| ----- |      |    |      |           |        |                             |                                                           |               |                |                                       |                                  |
| 11    | 11   | 0  | ID1  |           |        | 32-127 ID (ascii)           |                                                           |               |                |                                       |                                  |
| 12    | 12   | 0  | ID2  |           |        |                             |                                                           |               |                |                                       |                                  |
| 13    | 13   | 0  | ID3  |           |        |                             |                                                           |               |                |                                       |                                  |
| ----- |      |    |      |           |        |                             |                                                           |               |                |                                       |                                  |
| 26    | 26   | 0  | ID16 |           |        |                             |                                                           |               |                |                                       |                                  |

note) 3 PGMSW  
 0:off, 1:common, 2:individual, 3:direct, 4:TrnsFilter

\*\*\* SYS2 for DX11 \*\*\* 16 bytes system set up 2  
 para. cng g=4, h=0, p=123

| No. | para | b7 | b6       | b5 | b4     | b3                       | b2                                     | b1       | b0     | Data | note             |
|-----|------|----|----------|----|--------|--------------------------|----------------------------------------|----------|--------|------|------------------|
| 0   | 27   | 0  | 0        | 0  | 0      | 0                        | 0                                      | 0        | MIDIE  | 0-1  | midi on/off      |
| 1   | 28   | 0  | 0        | 0  | 0      | 0                        | 0                                      | 0        | LOCALF | 0-1  | local on/off     |
| 2   | 29   | 0  | 0        | 0  | ATSW   |                          | 0-17 After T.SW 1:norm<br>2-17(G1-G16) |          |        |      |                  |
| 3   | 30   | 0  | 0        | 0  | DEASON |                          | 0-31 D.E. asgn                         |          |        |      |                  |
| 4## | 31   | 0  | CRDENK   |    |        | 0-124 card bank(1-32) x4 |                                        |          |        |      |                  |
| 5   | 32   | 0  | 0        | 0  | 0      | 0                        | 0                                      | 0        | CNTRST | 0-1  | controller reset |
| 6   | 33   | 0  | 0        | 0  | 0      | 0                        | 0                                      | 0        | CRDLCK | 0-1  | card prot        |
| 7   | 34   | 0  | FIXTCH   |    |        | 0-127 fixed velocity     |                                        |          |        |      |                  |
| 8   | 35   | 0  | 0        | 0  | 0      | 0                        | 0                                      | -EGFDMP- |        | 0-3  | EG forced damp   |
| 9   | 36   | 0  | reserved |    |        |                          |                                        |          |        |      |                  |
| 10  | 37   | 0  | reserved |    |        |                          |                                        |          |        |      |                  |
| 11  | 38   | 0  | reserved |    |        |                          |                                        |          |        |      |                  |
| 12  | 39   | 0  | reserved |    |        |                          |                                        |          |        |      |                  |
| 13  | 40   | 0  | reserved |    |        |                          |                                        |          |        |      |                  |
| 14  | 41   | 0  | reserved |    |        |                          |                                        |          |        |      |                  |
| 15  | 42   | 0  | reserved |    |        |                          |                                        |          |        |      |                  |

\*\*\* parameter change only (receive only) \*\*\*

|    |   |       |        |       |      |
|----|---|-------|--------|-------|------|
| 43 | 0 | _____ | QEDATK | _____ | 0-99 |
| 44 | 0 | _____ | QEDREL | _____ | 0-99 |
| 45 | 0 | _____ | QEDVOL | _____ | 0-99 |
| 46 | 0 | _____ | QEDBRI | _____ | 0-99 |

\*\*\* SYS3 for V50 \*\*\* 32 byte sytem setup 3  
para. cng g=4, h=0, p=118

| No. para | b7 | b6 | b5    | b4    | b3         | b2    | b1    | b0    | Data   | note              |
|----------|----|----|-------|-------|------------|-------|-------|-------|--------|-------------------|
| 0        | 47 | 0  | _____ | _____ | ID17       | _____ | _____ | _____ | 32-127 | ID2 (ascii)       |
| 1        | 48 | 0  | _____ | _____ | ID18       | _____ | _____ | _____ |        |                   |
| 2        | 49 | 0  | _____ | _____ | ID19       | _____ | _____ | _____ |        |                   |
| .        | .  | .  | .     | .     | .          | .     | .     | .     |        |                   |
| 23       | 70 | 0  | _____ | _____ | ID40       | _____ | _____ | _____ |        |                   |
| 24       | 71 | 0  | _____ | _____ | SYN VOL    | _____ | _____ | _____ | 0-99   | synth volume      |
| 25       | 72 | 0  | _____ | _____ | INTERVAL   | _____ | _____ | _____ | 0-10   | MDR interval time |
| 26       | 73 | 0  | _____ | _____ | VEL CURVE  | _____ | _____ | _____ | 0-7    |                   |
| 27       | 74 | 0  | _____ | _____ | VOICE DAMP | _____ | _____ | _____ | 0-1    |                   |
| 28       | 75 | 0  | _____ | _____ | reserved   | _____ | _____ | _____ |        |                   |
| 29       | 76 | 0  | _____ | _____ | reserved   | _____ | _____ | _____ |        |                   |
| 30       | 77 | 0  | _____ | _____ | reserved   | _____ | _____ | _____ |        |                   |
| 31       | 78 | 0  | _____ | _____ | reserved   | _____ | _____ | _____ |        |                   |

\*\* parameter change only \*\*

| para | b7 | b6 | b5 | b4 | b3 | b2 | b1 | b0 | Data       | note          |
|------|----|----|----|----|----|----|----|----|------------|---------------|
| 79   | 0  | 0  | 0  | 0  | 0  | 0  | 0  | 0  | BYPASS 0-1 | effect bypass |

\*\*\* P.EFFECT \*\*\* 55 byte performance effect data  
para. cng g=4, h=0, p=124,120,121,122

| No. para | b7 | b6 | b5    | b4    | b3    | b2    | b1    | b0    | Data  | note                                             |
|----------|----|----|-------|-------|-------|-------|-------|-------|-------|--------------------------------------------------|
| 0        | 0  | 0  | _____ | _____ | EF1T  | _____ | _____ | _____ | 0-127 | effect 1 time<br>0.01s-1.28s                     |
| 1        | 1  | 0  | _____ | _____ | EF1P  | _____ | _____ | _____ | 0-48  | effect 1 pitch<br>center=24                      |
| 2        | 2  | 0  | 0     | 0     | 0     | 0     | _____ | _____ | 0-7   | effect 1 feed back                               |
| 3        | 3  | 0  | _____ | _____ | EF1L  | _____ | _____ | _____ | 0-99  | effect 1 out level                               |
| 4        | 5  | *1 | 0     | 0     | 0     | 0     | 0     | _____ | 0-2   | effect 2 select<br>0(LFO),1(velocity)<br>2(note) |
| 5        | 4  | *2 | 0     | 0     | 0     | 0     | 0     | 0     | 0-1   | effect 2 direction<br>0(L->R),1(L<-R)            |
| 6        | 6  | 0  | _____ | _____ | EF2R  | _____ | _____ | _____ | 0-99  | effect 2 range                                   |
| 7        | 7  | 0  | _____ | _____ | CHORD | _____ | _____ | _____ | 0-49  | effect 3 chord note<br>center=24 no use=49       |
| 8        | 8  |    |       |       |       |       |       |       |       |                                                  |
| 9        | 9  |    |       |       |       |       |       |       |       |                                                  |
| 10       | 10 |    |       |       |       |       |       |       |       | KEY C3                                           |
| 11       | 11 |    |       |       |       |       |       |       |       |                                                  |
| 12       | 12 |    |       |       |       |       |       |       |       |                                                  |
| 13       | 13 |    |       |       |       |       |       |       |       | KEY C#3                                          |
| 14       | 14 |    |       |       |       |       |       |       |       |                                                  |
| .        | .  |    |       |       |       |       |       |       |       |                                                  |
| .        | .  |    |       |       |       |       |       |       |       |                                                  |
| 51       | 51 |    |       |       |       |       |       |       |       |                                                  |
| 52       | 52 |    |       |       |       |       |       |       |       |                                                  |
| 53       | 53 |    |       |       |       |       |       |       |       |                                                  |
| 54       | 54 |    |       |       |       |       |       |       |       | KEY B3                                           |

note) \*1,\*2  
parameter change No.(4,5) is not same as bulk No.  
\*1 (EF2S) para. change No=5  
\*2 (EF2D) para. change No=4

\*\*\* PGMCHG \*\*\* 256 byte program change table (extend to 2 byte per 1 number)  
para. cng g=4, h=0, p=127

| No. para | b7  | b6 | b5 | b4 | b3 | b2 | b1 | b0 | Data   | note           |
|----------|-----|----|----|----|----|----|----|----|--------|----------------|
| 0        | 0   | 0  | 0  | 0  | 0  | 0  | 0  | 0  | TYPE   | 0-5 voice type |
|          |     |    |    |    |    |    |    |    | NUMBER | 0-99 No PGM1   |
| 1        | 1   |    |    |    |    |    |    |    |        | PGM2           |
| .        | .   |    |    |    |    |    |    |    |        |                |
| .        | .   |    |    |    |    |    |    |    |        |                |
| 127      | 127 |    |    |    |    |    |    |    |        | PGM128         |

| (note) | ## | type | number | display       |
|--------|----|------|--------|---------------|
|        |    | 0    | 0 - 99 | I00 - I99     |
|        |    | 1    | 0 - 99 | C00 - C99     |
|        |    | 2    | 0 - 99 | P00 - P99     |
|        |    | 3    | 0 - 99 | PF100 - PF199 |
|        |    | 4    | 0 - 99 | PFC00 - PFC99 |
|        |    | 5    | 0 - 99 | PPF00 - PPF99 |

\*\*\*\*\*  
\* micro tuning bulk dump  
\*\*\*\*\*

\*\*\* OCTAVE \*\*\* 24 byte micro tuning data (octave)  
para. cng g=4, h=0, p=125

| No. para | b7 | b6 | b5    | b4    | b3             | b2    | b1    | b0    | Data   | note      |
|----------|----|----|-------|-------|----------------|-------|-------|-------|--------|-----------|
| 0        | 0  | 0  | _____ | _____ | MS BYTE of MCT | _____ | _____ | _____ | 13-107 | (C#-1-B6) |
|          |    |    |       |       | LS BYTE of MCT | _____ | _____ | _____ | 0- 63  | C         |
| 1        | 1  |    |       |       |                |       |       |       |        | C#        |
| 2        | 2  |    |       |       |                |       |       |       |        |           |
| .        | .  |    |       |       |                |       |       |       |        |           |
| .        | .  |    |       |       |                |       |       |       |        |           |
| 11       | 11 |    |       |       |                |       |       |       |        | B         |

\*\*\* FULL KBD \*\*\* 256 byte micro tuning data (full keyboard)  
para. cng g=4, h=0, p=126

| No. para | b7  | b6 | b5    | b4    | b3             | b2    | b1    | b0    | Data   | note     |
|----------|-----|----|-------|-------|----------------|-------|-------|-------|--------|----------|
| 0        | 0   | 0  | _____ | _____ | MS BYTE of MCT | _____ | _____ | _____ | 13-107 |          |
|          |     |    |       |       | LS BYTE of MCT | _____ | _____ | _____ | 0- 63  | C-2 (0)  |
| 1        | 1   |    |       |       |                |       |       |       |        | C#-2 (1) |
| 2        | 2   |    |       |       |                |       |       |       |        |          |
| .        | .   |    |       |       |                |       |       |       |        |          |
| .        | .   |    |       |       |                |       |       |       |        |          |
| .        | .   |    |       |       |                |       |       |       |        |          |
| 127      | 127 |    |       |       |                |       |       |       |        | G8 (127) |

\*\*\*\*\*  
\* SEQUENCER bulk dump  
\*\*\*\*\*

\*\*\* SYSQ \*\*\* 33 byte sequencer system setup  
para. cng g=4, h=0, p=111

| No. para | b7 | b6 | b5    | b4    | b3             | b2    | b1    | b0    | Data        | note                                                              |
|----------|----|----|-------|-------|----------------|-------|-------|-------|-------------|-------------------------------------------------------------------|
| 06\$     | 0  | 0  | 0     | 0     | 0              | 0     | 0     | 0     | TEMPO1      | 0-1 tempo data 30-240                                             |
| 16\$     | 1  | 0  | _____ | _____ | TEMPO2         | _____ | _____ | _____ | 0-127       | (7bit)                                                            |
| 2        | 2  | 0  | 0     | 0     | 0              | 0     | 0     | 0     | METRO       | 0-3 metronome<br>0:off,1:rec,2:rec/play<br>3:always               |
| 3        | 3  | 0  | 0     | 0     | 0              | 0     | 0     | 0     | SYNC        | 0-1 sync 0:int,1:midi<br>SEQ/R common                             |
| 4        | 4  | 0  | 0     | 0     | 0              | _____ | _____ | _____ | 0-16        | SEQSRCH receive ch in rec mode<br>0-15:1-16ch,16:omni<br>17:kbd   |
| 5        | 5  | 0  | 0     | 0     | 0              | 0     | 0     | 0     | SEQSATS     | 0-1 after touch record sw                                         |
| 6        | 6  | 0  | 0     | 0     | 0              | 0     | 0     | 0     | SEQSVEL     | 0-1 velocity record switch                                        |
| 7        | 7  | 0  | 0     | 0     | 0              | 0     | 0     | 0     | SEQSSONG_NO | 0-7 sequence song number                                          |
| 86\$     | 8  | 0  | _____ | _____ | SEQSSIG1       | _____ | _____ | _____ | 0-15        | time signature                                                    |
| 96\$     | 9  | 0  | _____ | _____ | SEQSSIG2       | _____ | _____ | _____ | 2-4         | TSIG1/TSIG2<br>TSIG=0:1...15:16<br>TSIG2=2: 1/4 3: 1/8<br>4: 1/16 |
| 106\$    | 10 | 0  | _____ | _____ | SEQSSONG_NAME1 | _____ | _____ | _____ | 32-127      | song name (ASCII)                                                 |
| 116\$    | 11 | 0  | _____ | _____ | SEQSSONG_NAME2 | _____ | _____ | _____ |             |                                                                   |
| .        | .  |    |       |       |                |       |       |       |             |                                                                   |
| .        | .  |    |       |       |                |       |       |       |             |                                                                   |
| 176\$    | 17 | 0  | _____ | _____ | SEQSSONG_NAME8 | _____ | _____ | _____ |             |                                                                   |
| 186\$    | 18 | 0  | 0     | 0     | _____          | _____ | _____ | _____ | 0-16        | transmit channel                                                  |
| 196\$    | 19 | 0  | 0     | 0     | _____          | _____ | _____ | _____ |             | 16:off                                                            |
| .        | .  |    |       |       |                |       |       |       |             |                                                                   |
| .        | .  |    |       |       |                |       |       |       |             |                                                                   |
| 256\$    | 25 | 0  | 0     | 0     | _____          | _____ | _____ | _____ |             | SEQSTCH(TRACK8)                                                   |
| 26       | 26 | 0  | 0     | 0     | 0              | 0     | 0     | 0     | REC_TYPE    | 0-2 recording mode<br>0:real,1:step,2:punch<br>flag of replace    |
| 27       | 27 | 0  | 0     | 0     | 0              | 0     | 0     | 0     | REPLACE     | 0-1 0:over dub,1:replace                                          |
| 28       | 28 | 0  | _____ | _____ | _____          | _____ | _____ | _____ |             | reserved                                                          |
| 29       | 29 | 0  | _____ | _____ | _____          | _____ | _____ | _____ |             | reserved                                                          |
| 30       | 30 | 0  | _____ | _____ | _____          | _____ | _____ | _____ |             | reserved                                                          |
| 31       | 31 | 0  | _____ | _____ | _____          | _____ | _____ | _____ |             | reserved                                                          |
| 32       | 32 | 0  | _____ | _____ | _____          | _____ | _____ | _____ |             | reserved                                                          |

note) 1. &.current edit parameter  
2. all parameter change is not received under playing  
3. \$. ignored when bulk is received

\*\*\*\*\*  
 \* RHYTHM SYSTEM SETUP bulk dump \*  
 \*\*\*\*\*

\*\*\* SYSR \*\*\* 16 byte rhythm system setup  
 para. cng g=4, h=0, k=112

| No. | para | b7 | b6 | b5 | b4 | b3 | b2 | b1 | b0 | Data           | note                                         |
|-----|------|----|----|----|----|----|----|----|----|----------------|----------------------------------------------|
| 0   | 0    | 0  | 0  | 0  | 0  | 0  | 0  | 0  | 0  | RYSVOLUME      | 0-99 rhythm master volume                    |
| 1   | 1    | 0  | 0  | 0  | 0  | 0  | 0  | 0  | 0  | -RYSDSP-       | 0-2 dsp sw 0:off,1:on,2:mix                  |
| 2   | 2    | 0  | 0  | 0  | 0  | 0  | 0  | 0  | 0  | ASGN           | 0-1 kbd asgn sw 0:rhy,1:syn                  |
| 3   | 3    | 0  | 0  | 0  | 0  | 0  | 0  | 0  | 0  | -RYSQUANTIZE-  | 0-7 quantize 1/4 - off                       |
| 4   | 4    | 0  | 0  | 0  | 0  | 0  | 0  | 0  | 0  | RYSRCH         | 0-17 receive ch 1-16,omni                    |
| 5   | 5    | 0  | 0  | 0  | 0  | 0  | 0  | 0  | 0  | -RYSRCH-       | 0-16 transmit ch 1-16,off                    |
| 6   | 6    | 0  | 0  | 0  | 0  | 0  | 0  | 0  | 0  | VEL            | 0-1 velocity sw 0:off,1:on                   |
| 7   | 7    | 0  | 0  | 0  | 0  | 0  | 0  | 0  | 0  | CLICK          | 0-1 click sw 0:rec,1:play                    |
| 8   | 8    | 0  | 0  | 0  | 0  | 0  | 0  | 0  | 0  | -RYSCLICK-     | 0-6 click value 1/4 - 1/32                   |
| 9   | 9    | 0  | 0  | 0  | 0  | 0  | 0  | 0  | 0  | -RYSASGN-      | 0-4 assign table number<br>preset1-3,user1-2 |
| 10  | 10   | 0  | 0  | 0  | 0  | 0  | 0  | 0  | 0  | PITYPE         | 0-1 pattern type 0:int,1:preset              |
| 11  | 11   | 0  | 0  | 0  | 0  | 0  | 0  | 0  | 0  | RYSPIN NUM     | 0-99 pattern number                          |
| 12  | 12   | 0  | 0  | 0  | 0  | 0  | 0  | 0  | 0  | -RYS SONG NUM- | 0-7 song number                              |
| 13  | 13   | 0  | 0  | 0  | 0  | 0  | 0  | 0  | 0  | REC            | 0-1 record type 0:realtime<br>1:step         |
| 14  | 14   | 0  | 0  | 0  | 0  | 0  | 0  | 0  | 0  | SONG           | 0-1 R mode 0:ptn 1:song                      |
| 15  | 15   | 0  | 0  | 0  | 0  | 0  | 0  | 0  | 0  | reserved       |                                              |

note) 1. parameter change(No=12-14) is not received under playing  
 2. parameter change(No=10-11) is received at PIN mode only  
 3. parameter change(No=12) is received at SONG mode only

\*\*\* RINST \*\*\* 183 byte rhythm instrument set up  
 para. cng g=4, h=0, p=113(RINST1) VOL,PAN  
 p=114(RINST2) NOTE

| No. | para | b7 | b6 | b5 | b4 | b3 | b2 | b1 | b0 | Data   | note                       |
|-----|------|----|----|----|----|----|----|----|----|--------|----------------------------|
| 0   | 0    | 0  | 0  | 0  | 0  | 0  | 0  | 0  | 0  | VOLUME | 0-15 inst volume of BD1    |
| 1   | 1    | 0  | 0  | 0  | 0  | 0  | 0  | 0  | 0  | VOLUME | 0-15 inst volume of BD2    |
| 60  | 60   | 0  | 0  | 0  | 0  | 0  | 0  | 0  | 0  | VOLUME | 0-15 inst volume of VBRSLP |
| 61  | 61   | 0  | 0  | 0  | 0  | 0  | 0  | 0  | 0  | PAN    | 0-6 inst pan of BD1        |
| 62  | 62   | 0  | 0  | 0  | 0  | 0  | 0  | 0  | 0  | PAN    | 0-6 inst pan of BD2        |
| 121 | 121  | 0  | 0  | 0  | 0  | 0  | 0  | 0  | 0  | PAN    | 0-6 inst pan of VBRSLP     |
| 122 | 0    | 0  | 0  | 0  | 0  | 0  | 0  | 0  | 0  | NOTE   | 0-127 inst note of BD1     |
| 123 | 1    | 0  | 0  | 0  | 0  | 0  | 0  | 0  | 0  | NOTE   | 0-127 inst note of BD2     |
| 182 | 60   | 0  | 0  | 0  | 0  | 0  | 0  | 0  | 0  | NOTE   | 0-127 inst note of VBRSLP  |

order of instruments is as follow.

|    | x0      | x1      | x2      | x3      | x4      | x5      | x6      | x7      | x8      | x9      |
|----|---------|---------|---------|---------|---------|---------|---------|---------|---------|---------|
| 0x | BD 1    | {BD 2   | {BD 3   | {H.BD   | {GateBD | {E.BD   | {SD 1   | {SD 2   | {PiclSD | {H.SD 1 |
| 1x | H.SD 2  | {GateSD | {E.SD   | {Rim 1  | {Rim 2  | {Tom 1  | {Tom 2  | {Tom 3  | {Tom 4  | {F.Tom1 |
| 2x | F.Tom2  | {F.Tom3 | {F.Tom4 | {E.Tom1 | {E.Tom2 | {E.Tom3 | {E.Tom4 | {HcLos  | {HcPen  | {HcL/4o |
| 3x | {HcPd1  | {Ride   | {Edge   | {Crash  | {Fmrc1  | {Fmrc2  | {Fmrc3  | {GlsCsh | {BellTr | {TimpH  |
| 4x | {TimpL  | {Claps  | {Shaker | {Cowbel | {TimblH | {TimblL | {WhstL  | {WhstH  | {CgaHMT | {CgaHOP |
| 5x | {Cga LO | {Bgo HI | {Bgo LO | {Cuicah | {Cuical | {Ago HI | {Ago LO | {Tambcn | {Claves | {Cstnt  |
| 6x | {VbrSlp |         |         |         |         |         |         |         |         |         |

\*\*\* RKAT \*\*\* 122 byte rhythm keyboard assign data  
 para. cng g=4, h=0, p=115 (user assign 1)  
 p=116 (user assign 2)

| No. | para | b7 | b6 | b5 | b4 | b3 | b2 | b1 | b0 | Data        | note                                       |
|-----|------|----|----|----|----|----|----|----|----|-------------|--------------------------------------------|
| 0   | 0    | 0  | 0  | 0  | 0  | 0  | 0  | 0  | 0  | INST NUMBER | 0-61 inst of C1<br>0-60:inst number,61:off |
| 1   | 1    | 0  | 0  | 0  | 0  | 0  | 0  | 0  | 0  | INST NUMBER | 0-61 inst of C#1                           |
| 2   | 2    | 0  | 0  | 0  | 0  | 0  | 0  | 0  | 0  | INST NUMBER | 0-61 inst of D1                            |
| 60  | 60   | 0  | 0  | 0  | 0  | 0  | 0  | 0  | 0  | INST NUMBER | 0-61 inst of C6                            |

< Table 4 >

Dump Request Messages

|       |                                                    |                                        |
|-------|----------------------------------------------------|----------------------------------------|
| *     | VCEd                                               | f0,43,2n,03,F7                         |
| ##    | * VMEM<br>(V50 100 voice bulk)                     | f0,43,2n,04,F7                         |
| *     | ACED + VCEd [TX812]                                | f0,43,2n,7e,LM_8976AE,F7               |
| %%    | * ACED2 + ACED + VCEd [V2]                         | f0,43,2n,7e,LM_8023AE,F7               |
| ##    | * ACED3 + ACED2 + ACED + VCEd<br>(V50 1voice bulk) | f0,43,2n,7e,LM_8073AE,F7               |
| *     | PCED [V2]                                          | f0,43,2n,7e,LM_8976PE,F7               |
| ##    | * PCED2 + PCED<br>(V50 1 pfm bulk)                 | f0,43,2n,7e,LM_8073PE,F7               |
| *     | PMEM                                               | f0,43,2n,7e,LM_8976PM,F7               |
| ##    | * PMEM2 + PMEM<br>(V50 100 pfm bulk)               | f0,43,2n,7e,LM_8073PM,F7               |
| *     | system setup                                       | f0,43,2n,7e,LM_8976Sx,F7 ( x = 0,1,2 ) |
| %%    | * setup(effect grp2-4)                             | f0,43,2n,7e,LM_8976Sx,F7 ( x = 3,4,5 ) |
| %%    | * system setup 2                                   | f0,43,2n,7e,LM_8023S0,F7<br>EFG2-EFG4  |
| ##    | * system setup 3 + 2 + 1                           | f0,43,2n,7e,LM_8073S0,F7               |
| *     | micro tuning buffer                                | f0,43,2n,7e,LM_MCRTEs,F7 ( x = 0 , 1 ) |
| ##    | * SEQ system (SYSQ)                                | f0,43,2n,7e,LM_8073SS,F7               |
| ##    | * SEQ sequence data(NSEQ)                          | f0,43,2n,0A,LM_NSEQ_,F7                |
| ##    | * SEQ song data(SSONG)                             | f0,43,2n,7e,LM_8073SQ,F7               |
| ##    | * RHYTHM system (SYSR)                             | f0,43,2n,7e,LM_8073RS,F7               |
| ##    | * RHYTHM inst setup (RINST)                        | f0,43,2n,7e,LM_8073RI,F7               |
| ##    | * R kbd assign table (RKAT1)<br>(user1)            | f0,43,2n,7e,LM_8073K0,F7               |
| ##    | * R kbd assign table (RKAT2)<br>(user2)            | f0,43,2n,7e,LM_8073K1,F7               |
| ##    | * R seq data(RSEQ)                                 | f0,43,2n,7e,LM_8073RY,F7               |
| note) | Ascii number                                       | HEX                                    |
| *     | LM_8976AE                                          | 4c,4d,20,20,38,39,37,36,41,45          |
| *     | LM_8023AE                                          | 4c,4d,20,20,38,30,32,33,41,45          |
| *     | LM_8976PE                                          | 4c,4d,20,20,38,39,37,36,50,45          |
| *     | LM_8976PM                                          | 4c,4d,20,20,38,39,37,36,50,4d          |
| *     | LM_8976S0                                          | 4c,4d,20,20,38,39,37,36,53,30          |
| *     | LM_8976S1                                          | 4c,4d,20,20,38,39,37,36,53,31          |
| *     | LM_8976S2                                          | 4c,4d,20,20,38,39,37,36,53,32          |
| *     | LM_8976S3                                          | 4c,4d,20,20,38,39,37,36,53,33          |
| *     | LM_8976S4                                          | 4c,4d,20,20,38,39,37,36,53,34          |
| *     | LM_8976S5                                          | 4c,4d,20,20,38,39,37,36,53,35          |
| *     | LM_8023S0                                          | 4c,4d,20,20,38,30,32,33,53,30          |
| *     | LM_MCRTE0                                          | 4c,4d,20,20,4d,43,52,54,45,30          |
| *     | LM_MCRTE1                                          | 4c,4d,20,20,4d,43,52,54,45,31          |
| *     | LM_8073AE                                          | 4c,4d,20,20,38,30,37,33,41,45          |
| *     | LM_8073PE                                          | 4c,4d,20,20,38,30,37,33,50,45          |
| *     | LM_8073PM                                          | 4c,4d,20,20,38,30,37,33,50,4d          |
| *     | LM_8073S0                                          | 4c,4d,20,20,38,30,37,33,53,30          |
| *     | LM_8073SS                                          | 4c,4d,20,20,38,30,37,33,53,53          |
| *     | LM_NSEQ                                            | 4c,4d,20,20,4e,53,45,51,20,20          |
| *     | LM_8073SQ                                          | 4c,4d,20,20,38,30,37,33,53,51          |
| *     | LM_8073RS                                          | 4c,4d,20,20,38,30,37,33,52,53          |
| *     | LM_8073RI                                          | 4c,4d,20,20,38,30,37,33,52,49          |
| *     | LM_8073K0                                          | 4c,4d,20,20,38,30,37,33,4b,30          |
| *     | LM_8073K1                                          | 4c,4d,20,20,38,30,37,33,4b,31          |
| *     | LM_8073RY                                          | 4c,4d,20,20,38,30,37,33,52,59          |

< Table 5 >

```

<<< $F0,$43,$1n,... >>>

VCED $12(g=4,h=2),p=0-92,93
VCED(DX21) $12(g=4,h=2),p=94-127

ACED $13(g=4,h=3),p=0-22
ACED2(DX11) $13(g=4,h=3),p=23-32
ACED3(V50) $13(g=4,h=3),p=33-52
SYS(81Z remote) $13(g=4,h=3),p=64-75
SYS(DX11 remote) $13(g=4,h=3),p=76-124

PCED $10(g=4,h=0),p=0-109
PCED2 $10(g=4,h=0),p=110 k=0-32

SYSQ(seq system)$10(g=4,h=0),p=111 k=0-32
SYSR(r system) $10(g=4,h=0),p=112 k=0-15
RINST1(vol/pan) $10(g=4,h=0),p=113 k=0-121
RINST2(note) $10(g=4,h=0),p=114 k=0-60
RKAT1(user1) $10(g=4,h=0),p=115 k=0-60
RKAT2(user2) $10(g=4,h=0),p=116 k=0-60

VMEM bulk header$44(g=9,h=0),p=7, (d=1-4)
PMEM bulk header$10(g=4,h=0),p=117, k=1 (d=0-3)
V50RM(V50remote)$10(g=4,h=0),p=118 k=0-56
WT11SYS(system) $10(g=4,h=0),p=119, k=0-15
WT11SYS(remote) $10(g=4,h=0),p=119 k=64-74
SYS(effect gp2) $10(g=4,h=0),p=120, k=0-54
SYS(effect gp3) $10(g=4,h=0),p=121, k=0-54
SYS(effect gp4) $10(g=4,h=0),p=122, k=0-54
SYS(system) $10(g=4,h=0),p=123, k=0-26
SYS2(DX11system)$10(g=4,h=0),p=123, k=27-46
SYS3(V50system)$10(g=4,h=0),p=123, k=47-79
SYS(effect gp1) $10(g=4,h=0),p=124, k=0-54
MCT(oct) $10(g=4,h=0),p=125, k=0-11
MCT(full) $10(g=4,h=0),p=126, k=0-127
SYS(pgmchg) $10(g=4,h=0),p=127, k=0-127

```

## SEQUENCER SECTION

### Reception flow diagram

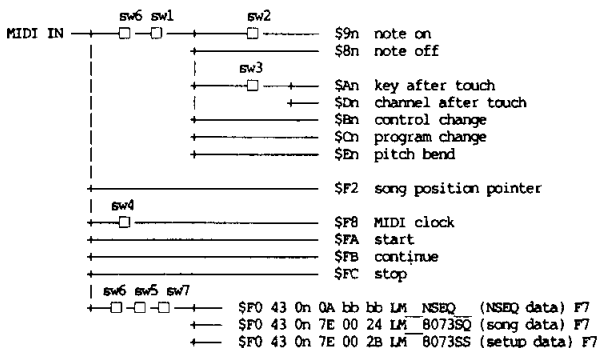

(Note)

- sw1: When in RECORD, the SETUP reception channel
- sw2: When in RECORD, the SETUP velocity on/off
- sw3: When in RECORD, the SETUP aftertouch on/off
- sw4: When in PLAY, this is on when SETUP sync is set to "MIDI"
- sw5: Set by the UTILITY (setup) device number
- sw6: Received only when UTILITY (setup) midi sw = on
- sw7: Received only when UTILITY int memory protect = off

### Transmission flow diagram

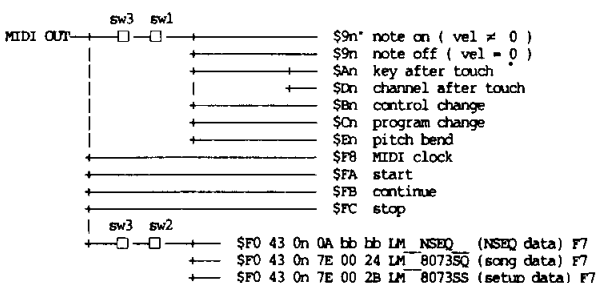

(Note)

- sw1: Set for each track in MIDI TRANSMIT CHANNEL
- sw2: Set in Device No. of utility (setup)
- sw3: Transmitted only when UTILITY (setup) midi sw = on

### Channel messages:

Received only during RECORD. Transmitted only during PLAY and during overdub. For transmission/reception conditions, see the reception flow diagram and the transmission flow diagram.

### Mode messages:

Neither received nor transmitted.

### System common messages:

Only \$F2 (song position pointer) is received. (However not in recording mode, nor during playback.) Other than this, neither received nor transmitted.

### BULK DUMP:

Three types of bulk data are transmitted and received. The transmission/reception channel can be set in synthesizer mode.

- 1) \$F0 43 on 7E 00 2B LM\_8073SS (setup data) F7
- 2) \$F0 43 on 7E 00 24 LM\_8073SQ (song data) F7
- 3) \$F0 43 on 0A bb bb LM\_NSEQ\_(NSEQ data) F7

Reception is possible only when not playing back or recording. When 2.song data and 1.NSEQ data (sequence data) is received, it will be loaded into song memory only if the current song is empty.

Transmission occurs when MIDI exclusive "bulk dump" is executed, or when a dump request is received.

The data format for NSEQ data and seq song data is explained below. For the seq (SYSQ) data format, see the data format table for the synthesizer section (table 4).

Bulk data with a header of "LM—NSEQ1—" can also be received. (However, macros, time signature changes, exclusive, etc. in the data will be ignored.)

### NSEQ DATA FORMAT

NSEQ data for a one song consists of multiple tracks beginning with F0 0n (n=track number) and ending with F2. Empty tracks are not included.

The time/event/control data explained in the supplement are between the F0 0n and the F2.

| hex | description             |
|-----|-------------------------|
| F0  | top of track #1         |
| 00  |                         |
| --- | time/event/control data |
| F2  | end of record           |
| --- |                         |
| --- | track #2 ~ #7 data      |
| F0  | top of track #8         |
| 07  |                         |
| --- | time/event/control data |
| F2  | end of record           |

### Supplement: NSEQ time/event/control data format (expressed in binary)

|              |                                   |                                     |
|--------------|-----------------------------------|-------------------------------------|
| short time   | 0ttttttt                          | (384th note length / bit)           |
| long time    | 0ttttttt 0ttttttt                 | (in the order of MS byte - LS byte) |
| short note   | 10ddddd 0kkkkkkk 0vvvvvvv         |                                     |
| long note    | 110ddddd 0ddddd 0kkkkkkk 0vvvvvvv |                                     |
| short note   | 10ddddd 1kkkkkkk                  | (when velocity = \$40)              |
| long note    | 110ddddd 0ddddd 1kkkkkkk          | (when velocity = \$40)              |
|              | ddd = duration                    | (96th note length / bit)            |
|              | kkk = MIDI note number            |                                     |
|              | vvv = MIDI velocity               |                                     |
| measure mark | 11110101                          | (measure mark)                      |
| no operation | 11111000                          | (does nothing)                      |

(The following are the same as MIDI format except for the MS byte.)

|                 |                            |
|-----------------|----------------------------|
| poly a.touch    | 11111010 0kkkkkkk 0vvvvvvv |
| control change  | 11111011 0ccccccc 0vvvvvvv |
| program change  | 11111100 0ppppppp          |
| channel a.touch | 11111101 0vvvvvvv          |
| pitch bend      | 11111110 0vvvvvvv 0vvvvvvv |



**SEQ SONG DATA FORMAT**

Song data consists of tempo, beat (time signature), and song name. It has the following format.

\*\*\* SSONG \*\*\* 26 byte sequencer song data

| No | b7 | b6             | b5 | b4              | b3 | b2 | b1 | b0 | Data   | note                                                   |
|----|----|----------------|----|-----------------|----|----|----|----|--------|--------------------------------------------------------|
| 0  | 0  | 0              | 0  | 0               | 0  | 0  | 0  | 0  | SETUP  | 0-1 setup store flag                                   |
| 1  | 0  | 0              | 0  | TIME SIG        |    |    |    |    |        | 0-31 packed time signature                             |
| 2  | 0  | 0              | 0  | 0               | 0  | 0  | 0  | 0  | TEMP01 | 0-1 tempo 30-240 (7bit)                                |
| 3  | 0  | TEMP02         |    |                 |    |    |    |    |        | 0-127                                                  |
| 4  | 0  | SONG NAME1     |    |                 |    |    |    |    | 32-127 | song name (ASCII)                                      |
| 5  | 0  | SONG NAME2     |    |                 |    |    |    |    |        |                                                        |
| 11 | 0  | SONG NAME8     |    |                 |    |    |    |    |        |                                                        |
| 12 | 0  | 0              | 0  | SEQ_TCH(TRACK1) |    |    |    |    |        | 0-16 transmit channel 16:off                           |
| 13 | 0  | 0              | 0  | SEQ_TCH(TRACK2) |    |    |    |    |        | 0-16 transmit channel 16:off                           |
| 19 | 0  | 0              | 0  | SEQ_TCH(TRACK8) |    |    |    |    |        | 0-16 transmit channel 16:off                           |
| 20 | 0  | 0              | 0  | 0               | 0  | 0  | 0  | 0  | S.MODE | 0-1 synth node<br>0:SGL,1:PFM mode                     |
| 21 | 0  | 0              | 0  | 0               | 0  | 0  | 0  | 0  | V.TYPE | 0-2 synth voice type<br>0:internal<br>1:card, 2:preset |
| 22 | 0  | VOICE/PPM NO   |    |                 |    |    |    |    | 0-99   | synth voice/ppm No                                     |
| 23 | 0  | 0              | 0  | 0               | 0  | 0  | 0  | 0  | R.MODE | 0-1 Rhythm mode 0:PIN<br>1:SONG                        |
| 24 | 0  | 0              | 0  | 0               | 0  | 0  | 0  | 0  | R_NO1  | 0-1 Rhythm song/ptn No                                 |
| 25 | 0  | R SONG/PIN_NO2 |    |                 |    |    |    |    | 0-127  | 0 - 99:100-199<br>100-199:P00-P99                      |

note) 1 TIME\_SIG

0 - 3 : 1/4 - 4/4  
4 - 11 : 1/8 - 8/8  
12-27 : 1/16 - 16/16

(Table 1) 1. Transmission data

1-1 Channel information

(1) Channel voice information

- (1.1) KEY ON/OFF  
 STATUS 1001nnnn (9n) n = channel number  
 NOTE No. 0kkkkkkk k=0(C-2)~ 111(D#7)  
 VELOCITY 0vvvvvvv (v≠0) KEY ON  
 00000000 (v=0) KEY OFF
- (1.2) POLYPHONIC AFTER TOUCH  
 STATUS 1010nnnn (An) n = channel number  
 NOTE No. 0kkkkkkk k=0(C-2)~ 127(G8)  
 Value 0vvvvvvv v=0~ 127
- (1.3) CONTROL CHANGE  
 STATUS 1011nnnn (Bn) n = channel number  
 CONTROL No. 0ccccccc c=0~ 121  
 CONTROL Value 0vvvvvvv
- (1.4) PROGRAM CHANGE  
 STATUS 1100nnnn (Cn) n = channel number  
 PROGRAM No. 0pppppppp p=0~ 99  
 mode(if pgm cng sw is not TransFilter)  
 p=119:IND int(at PFI)  
 card(at PFC)  
 p=121:IND preset  
 p=122:SGL int  
 p=123:SGL card  
 p=124:SGL preset  
 p=125:PFM int  
 p=126:PFM card  
 p=127:PFM preset
- (1.5) AFTER TOUCH  
 STATUS 1101nnnn (Dn) n = channel number  
 Value 0vvvvvvv v=0~ 127
- (1.6) PITCH BENDER  
 STATUS 1110nnnn (En) n = channel number  
 Value 0uuuuuuu  
 Value 0vvvvvvv

1-2 System information

(1) System realtime messages

|                          |          |      |
|--------------------------|----------|------|
| (1.1)TIMING CLOCK STATUS | 11111000 | (F8) |
| (1.2)START STATUS        | 11111010 | (FA) |
| (1.3)CONTINUE STATUS     | 11111011 | (FB) |
| (1.4)STOP STATUS         | 11111100 | (FC) |

(2) System exclusive messages

(2.1) SEQUENCE DUMP

|                     |          |         |                 |
|---------------------|----------|---------|-----------------|
| STATUS              | 11110000 | (F0)    |                 |
| ID No.              | 01000011 | (43)    |                 |
| SUB STATUS          | 0000ssss | (0s)    | s=device number |
| GROUP NUMBER        | 00001010 | (0A)    |                 |
| BYTE COUNT(MSB)     | 0bbbbbbb |         |                 |
| BYTE COUNT(LSB)     | 0bbbbbbb |         |                 |
| CLASSIFICATION-NAME | 01001100 | ASCII'L |                 |
|                     | 01001101 | ASCII'M |                 |
|                     | 00100000 | ASCII'  |                 |
|                     | 00100000 | ASCII'' |                 |
| DATA FORMAT-NAME    | 01001110 | ASCII'N |                 |
|                     | 01010011 | ASCII'S |                 |
|                     | 01000101 | ASCII'E |                 |
|                     | 01010001 | ASCII'Q |                 |
|                     | 00100000 | ASCII'  |                 |
|                     | 00100000 | ASCII'' |                 |
| DATA                | 0kkkkkkk |         |                 |
| CHECK SUM           | 0eeeeeee |         |                 |
| ECK                 | 11110111 | (F7)    |                 |

(2.2) UNIVERSAL BULK DUMP (Seq song data)

|                     |          |         |                 |
|---------------------|----------|---------|-----------------|
| STATUS              | 11110000 | (F0)    |                 |
| ID No.              | 01000011 | (43)    |                 |
| SUB STATUS          | 0000ssss | (0s)    | s=device number |
| GROUP NUMBER        | 01111110 | (7E)    |                 |
| BYTE COUNT(MSB)     | 00000000 | (00)    |                 |
| BYTE COUNT(LSB)     | 00100100 | (24)    |                 |
| CLASSIFICATION-NAME | 01001100 | ASCII'L |                 |
|                     | 01001101 | ASCII'M |                 |
|                     | 00100000 | ASCII'  |                 |
|                     | 00100000 | ASCII'' |                 |
| DATA FORMAT-NAME    | 00111000 | ASCII'8 |                 |
|                     | 00110000 | ASCII'0 |                 |
|                     | 00110111 | ASCII'7 |                 |
|                     | 00110011 | ASCII'3 |                 |
|                     | 01010011 | ASCII'S |                 |
|                     | 01010001 | ASCII'Q |                 |
| DATA                | 0kkkkkkk |         |                 |
| CHECK SUM           | 0eeeeeee |         | 26 bytes        |
| ECK                 | 11110111 | (F7)    |                 |

(Table 2) 2. Reception data

2-1 Channel information

Same as transmission

2-2 System information

(1) System common messages

(1.1) SONG POSITION POINTER STATUS 11110010 (F2)

(2) System realtime message

Same as transmission

(3) System exclusive message

(3.1) SEQUENCE DUMP

Same as transmission

(3.2) UNIVERSAL BULK DUMP (Seq setup data)

Same as transmission

## RHYTHM SECTION

### Reception flow diagram

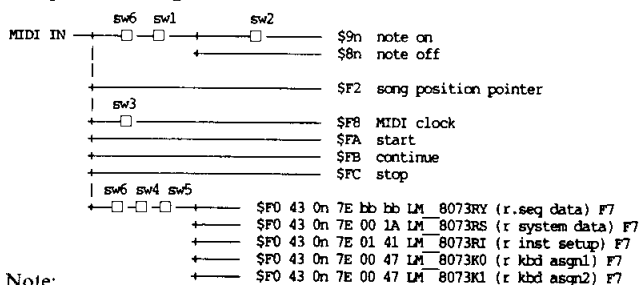

Note:

- sw1: Reception channel in SETUP
- sw2: When in RECORD, the SETUP velocity on/off
- sw3: When in PLAY, this is "on" when the SETUP sync is set to "MIDI"
- sw4: The device number selected in utility (setup)
- sw5: Received only when the utility setting memory protect is "off".
- sw6: Received only when UTILITY (setup) midi sw = on

### Transmission flow diagram

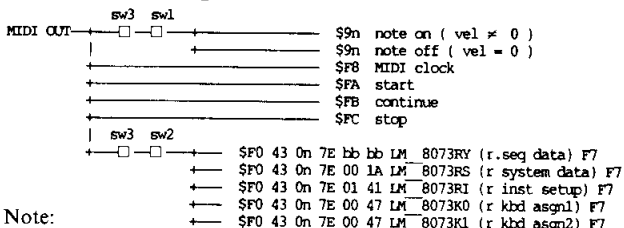

Note:

- sw1: The transmit channel in SETUP.
- sw2: The device number in utility (setup)
- sw3: Transmitted only when UTILITY (setup) midi = on

### Channel messages:

Transmitted only during PLAY and while recording. For the reception and transmission conditions, see the reception flow diagram and the transmission flow diagram.

### Mode messages:

Neither received nor transmitted.

### System common messages:

Only \$F2 (song position pointer) is received (however not when in recording mode nor during playback). Other messages are neither received nor transmitted.

### System Realtime Messages:

\$F8, \$FA, \$FB, and \$FC are transmitted and received. (However when in recording mode, \$FA, \$FB, and \$FC are not received.)

### BULK DUMP:

Five types of bulk data are transmitted and received. The transmission/reception channel can be set in synthesizer mode.

1. \$F0 43 On 7E bb bb LM\_8073RY (r.seq data) F7
2. \$F0 43 On 7E 00 1A LM\_8073RS (r system data) F7
3. \$F0 43 On 7E 01 41 LM\_8073RI (r inst data) F7
4. \$F0 43 On 7E 00 47 LM\_8073K0 (r kbd asgn1) F7
5. \$F0 43 On 7E 00 47 LM\_8073K1 (r kbd asgn2) F7

Reception is possible at any time except while playing or recording. Transmission occurs when MIDI exclusive "bulk dump" has been executed, or when a dump request has been received.

For the data formats of system (SYSR), inst setup (RINST), and kbd assign table (RKAT), see the data format table of the synthesizer section (table 4).

## (Table 1) 1. Transmission data

### 1-1 Channel information

#### (1) Channel voice messages

|                  |          |       |                    |
|------------------|----------|-------|--------------------|
| (1.1) KEY ON/OFF | 1001nnnn | (9n)  | n = channel number |
| STATUS           | 0kkkkkkk |       | k=0(C-2)~127(G8)   |
| NOTE No.         | 0vvvvvvv | (v≠0) | KEY ON             |
| VELOCITY         | 00000000 | (v=0) | KEY OFF            |

### 1-2 System information

#### (1) System realtime messages

|                    |          |      |  |
|--------------------|----------|------|--|
| (1.1) TIMING CLOCK |          |      |  |
| STATUS             | 11111000 | (F8) |  |
| (1.2) START        |          |      |  |
| STATUS             | 11111010 | (FA) |  |
| (1.3) CONTINUE     |          |      |  |
| STATUS             | 11111011 | (FB) |  |
| (1.4) STOP         |          |      |  |
| STATUS             | 11111100 | (FC) |  |

#### (2) System exclusive messages

|                            |          |          |                 |
|----------------------------|----------|----------|-----------------|
| (2.1) RHYTHM SEQUENCE DUMP |          |          |                 |
| STATUS                     | 11110000 | (F0)     |                 |
| ID No.                     | 01000011 | (43)     |                 |
| SUB STATUS                 | 0000ssss | (0s)     | s=device number |
| GROUP NUMBER               | 01111110 | (7E)     |                 |
| BYTE COUNT(MSB)            | 0bbbbbbb |          |                 |
| BYTE COUNT(LSB)            | 0bbbbbbb |          |                 |
| CLASSIFICATION-            | 01001100 | ASCII'L  |                 |
| NAME                       | 01001101 | ASCII'M  |                 |
|                            | 00100000 | ASCII' _ |                 |
|                            | 00100000 | ASCII' ` |                 |
| DATA FORMAT-               | 00111000 | ASCII'8  |                 |
| NAME                       | 00110000 | ASCII'0  |                 |
|                            | 00110111 | ASCII'7  |                 |
|                            | 00110011 | ASCII'3  |                 |
|                            | 01010010 | ASCII'R  |                 |
|                            | 01011001 | ASCII'Y  |                 |
| DATA                       | 0ccccddd |          | ] Note 1)       |
|                            | 0ccccddd |          |                 |
| CHECK SUM                  | 0eeeeeee |          |                 |
| EOX                        | 11110111 | (F7)     |                 |

### Note 1) data format

| count            | size(byte)    | data                          |
|------------------|---------------|-------------------------------|
| 0 - 217          | 218           | pattern/song directory        |
| 218 - 317        | 100           | time signature of 100 pattern |
| 318 - 417        | 100           | bar of 100 pattern            |
| 418 - 481        | 64 (8x8/song) | song name                     |
| 482 - 10239(max) | 9758 (max)    | pattern/song data             |

The above data is divided into MSB4 bits and LSB 4 bits, and each converted into an ASCII code. If the data count exceeds 4K bytes, the data from "BYTE COUNT" to "CHECK SUM" is repeated for every 4K bytes.

**(Table 2) 2. Reception data**

2-1 Channel information  
Same as for reception

2-2 System information

(1) System common messages

(1.1) SONG POSITION POINTER  
STATUS 11110010 (F2)

(2) System realtime messages  
Same as for reception

(3) System exclusive messages

(3.1) RHYTHM SEQUENCE DUMP  
Same as for transmission

| Function ...             | Transmitted                                                                                                                                   | Recognized                                                                                                                  | Remarks                                                                                                                                                                                                                  |
|--------------------------|-----------------------------------------------------------------------------------------------------------------------------------------------|-----------------------------------------------------------------------------------------------------------------------------|--------------------------------------------------------------------------------------------------------------------------------------------------------------------------------------------------------------------------|
| Basic Default            | : 1 - 16                                                                                                                                      | : 1 - 16                                                                                                                    | : memorized                                                                                                                                                                                                              |
| Channel Changed          | : 1 - 16                                                                                                                                      | : 1 - 16                                                                                                                    | :                                                                                                                                                                                                                        |
| Mode Default             | : 3                                                                                                                                           | : 1, 2, 3, 4                                                                                                                | : memorized                                                                                                                                                                                                              |
| Mode Messages            | : POLY, MONO(M=1)                                                                                                                             | : POLY, MONO(M=1)                                                                                                           | : sgl mode only                                                                                                                                                                                                          |
| Mode Altered             | : *****                                                                                                                                       | : x                                                                                                                         | :                                                                                                                                                                                                                        |
| Note Number : True voice | : 36 - 96<br>: *****                                                                                                                          | : 0 - 127<br>: 12 - 107                                                                                                     | :                                                                                                                                                                                                                        |
| Velocity Note ON         | : o 9nH, v=1-127                                                                                                                              | : o v=1-127                                                                                                                 | :                                                                                                                                                                                                                        |
| Velocity Note OFF        | : x 9nH, v=0                                                                                                                                  | : x                                                                                                                         | :                                                                                                                                                                                                                        |
| After Touch              | : x<br>: o *3                                                                                                                                 | : x<br>: o *3                                                                                                               | :                                                                                                                                                                                                                        |
| Pitch Bender             | : o *2                                                                                                                                        | : o 0-12 semi *2                                                                                                            | : 7 bit resolution                                                                                                                                                                                                       |
| Control Change           | 1 : o *1<br>2 : o *1<br>4 : o *1<br>5 : x<br>6 : o *1<br>7 : o *1<br>10 : x<br>64 : o<br>65 : o *1<br>96 : o *1<br>97 : o *1<br>0 - 31 : o *1 | : o *1<br>: o *1<br>: o *1<br>: o (sgl only) *1<br>: x<br>: o *1<br>: o (pfm only) *1<br>: o<br>: o *1<br>: x<br>: x<br>: o | : Modulation wheel<br>: Breath control<br>: Foot control<br>: Portamento time<br>: Data entry knob<br>: Volume<br>: Pan(L,L+R,R)<br>: Sustain<br>: Portamento<br>: Data entry +1<br>: Data entry -1<br>: D. entry (play) |
| Reset All Cntrller       | : x                                                                                                                                           | : o                                                                                                                         | :                                                                                                                                                                                                                        |
| Prog Change : True #     | : o 0 - 127 *4<br>: *****                                                                                                                     | : o 0 - 127<br>: 0 - 599                                                                                                    | : if pgm cng sw is on.(assignable)                                                                                                                                                                                       |
| System Exclusive         | : o *5                                                                                                                                        | : o *5                                                                                                                      | : Voice parameters                                                                                                                                                                                                       |
| System : Song Pos        | : x                                                                                                                                           | : o                                                                                                                         | :                                                                                                                                                                                                                        |
| System : Song Sel        | : x                                                                                                                                           | : x                                                                                                                         | :                                                                                                                                                                                                                        |
| Common : Tune            | : x                                                                                                                                           | : x                                                                                                                         | :                                                                                                                                                                                                                        |
| System : Clock           | : o                                                                                                                                           | : o                                                                                                                         | :                                                                                                                                                                                                                        |
| Real Time : Commands     | : o                                                                                                                                           | : o                                                                                                                         | :                                                                                                                                                                                                                        |
| Aux : Local ON/OFF       | : x                                                                                                                                           | : x                                                                                                                         | :                                                                                                                                                                                                                        |
| Aux : All Notes OFF      | : x                                                                                                                                           | : o (123,126,127)                                                                                                           | : 126,127 sgl only                                                                                                                                                                                                       |
| Mes- : Active Sense      | : o                                                                                                                                           | : o                                                                                                                         | :                                                                                                                                                                                                                        |
| sages:Reset              | : x                                                                                                                                           | : x                                                                                                                         | :                                                                                                                                                                                                                        |
| Notes: *1                | = transmit/receive if control change sw is on.                                                                                                |                                                                                                                             |                                                                                                                                                                                                                          |
| : *2                     | = transmit/receive if pitch bend sw is on.                                                                                                    |                                                                                                                             |                                                                                                                                                                                                                          |
| : *3                     | = transmit/receive if after touch sw is on.                                                                                                   |                                                                                                                             |                                                                                                                                                                                                                          |
| : *4                     | = transmit if pgm change sw is on and device No is off.                                                                                       |                                                                                                                             |                                                                                                                                                                                                                          |
| : *5                     | = transmit/receive if device No is not off.                                                                                                   |                                                                                                                             |                                                                                                                                                                                                                          |

Mode 1 : OMNI ON, POLY      Mode 2 : OMNI ON, MONO      o : Yes  
 Mode 3 : OMNI OFF, POLY    Mode 4 : OMNI OFF, MONO    x : No

| Function ...             | Transmitted                               | Recognized  | Remarks        |
|--------------------------|-------------------------------------------|-------------|----------------|
| Basic Default            | : 1 - 16                                  | : 1 - 16    | : memorized    |
| Channel Changed          | : 1 - 16                                  | : 1 - 16    |                |
| Mode Default             | : x                                       | : x         |                |
| Mode Messages            | : x                                       | : x         |                |
| Mode Altered             | : *****                                   | : x         |                |
| Note Number : True voice | : 0 - 111                                 | : 0 - 111   |                |
| Velocity Note ON         | : o 9nH, v=1-127                          | : o v=1-127 | *1             |
| Velocity Note OFF        | : x 9nH, v=0                              | : x         |                |
| After Key's              | : o                                       | : o         | *2             |
| Touch Ch's               | : o                                       | : o         | *2             |
| Pitch Bender             | : o                                       | : o         |                |
| Control Change           | : 0 - 120                                 | : o         |                |
| Prog Change : True #     | : o 0 - 127                               | : o 0 - 127 |                |
| System Exclusive         | : o                                       | : o         | *3 : Song data |
| System : Song Pos        | : x                                       | : o         | *4             |
| System : Song Sel        | : x                                       | : x         |                |
| Common : Tune            | : x                                       | : x         |                |
| System : Clock           | : o                                       | : o         | *5             |
| Real Time : Commands     | : o                                       | : o         |                |
| Aux : Local ON/OFF       | : x                                       | : x         |                |
| Aux : All Notes OFF      | : x                                       | : x         |                |
| Mes- : Active Sense      | : o                                       | : x         |                |
| sages:Reset              | : x                                       | : x         |                |
| Notes:                   | *1 = receive if velocity switch is on.    |             |                |
|                          | *2 = receive if after touch switch is on. |             |                |
|                          | *3 = receive if current song has no data. |             |                |
|                          | *4 = not receive at recording mode.       |             |                |
|                          | *5 = receive in MIDI sync mode.           |             |                |

Mode 1 : OMNI ON, POLY      Mode 2 : OMNI ON, MONO      o : Yes  
 Mode 3 : OMNI OFF, POLY    Mode 4 : OMNI OFF, MONO    x : No

| Function ...             | Transmitted    | Recognized   | Remarks        |
|--------------------------|----------------|--------------|----------------|
| Basic Default            | 1 - 16 *1      | 1 - 16       | memorized      |
| Channel Changed          | 1 - 16         | 1 - 16       |                |
| Mode Default             | x              | x            |                |
| Mode Messages            | x              | x            |                |
| Mode Altered             | *****          | x            |                |
| Note Number : True voice | 0 - 127 *****  | 0 - 127      |                |
| Velocity Note ON         | o 9nH, v=1-127 | o v=1-127 *2 |                |
| Velocity Note OFF        | x 9nH, v=0     | x            |                |
| After Touch Key's        | x              | x            |                |
| After Touch Ch's         | x              | x            |                |
| Pitch Bender             | x              | x            |                |
| Control Change           | x              | x            |                |
| Prog Change : True #     | x *****        | x            |                |
| System Exclusive         | o *3           | o *3         | Song data etc. |
| System : Song Pos        | x              | o *4         |                |
| System : Song Sel        | x              | x            |                |
| Common : Tune            | x              | x            |                |
| System : Clock           | o              | o *5         |                |
| Real Time : Commands     | o              | o            |                |
| Aux : Local ON/OFF       | x              | x            |                |
| Aux : All Notes OFF      | x              | x            |                |
| Mes- : Active Sense      | o              | x            |                |
| sages: Reset             | x              | x            |                |

Notes: \*1 = transmit under playing.  
 \*2 = receive if velocity switch is on.  
 \*3 = transmit/receive if device No is not off.  
 \*4 = not receive at recording mode.  
 \*5 = receive in MIDI sync mode.

## Performance data blank chart

---

You may copy the following chart as a memo sheet for your performance settings.

| YAMAHA V50 PERFORMANCE DATA |   |   |   |   |   | DATE / / |   |   |
|-----------------------------|---|---|---|---|---|----------|---|---|
| NAME                        |   |   |   |   |   |          |   |   |
| INST NUMBER                 | 1 | 2 | 3 | 4 | 5 | 6        | 7 | 8 |
| ASSIGN MODE                 |   |   |   |   |   |          |   |   |
| NOTES                       |   |   |   |   |   |          |   |   |
| VOICE NUMBER                |   |   |   |   |   |          |   |   |
| MIDI RECEIVE CH             |   |   |   |   |   |          |   |   |
| LIMIT / LOW                 |   |   |   |   |   |          |   |   |
| LIMIT / HIGH                |   |   |   |   |   |          |   |   |
| INST DETUNE                 |   |   |   |   |   |          |   |   |
| NOTE SHIFT                  |   |   |   |   |   |          |   |   |
| VOLUME                      |   |   |   |   |   |          |   |   |
| OUTPUT ASSIGN               |   |   |   |   |   |          |   |   |
| LFO SELECT                  |   |   |   |   |   |          |   |   |
| MICRO TUNING                |   |   |   |   |   |          |   |   |
| SELECT                      |   |   |   |   |   |          |   |   |
| KEY                         |   |   |   |   |   |          |   |   |
| P. EFFECT                   |   |   |   |   |   |          |   |   |
| EFFECT                      |   |   |   |   |   |          |   |   |
| SELECT                      |   |   |   |   |   |          |   |   |
| BALANCE                     |   |   |   |   |   |          |   |   |
| OUT LEVEL                   |   |   |   |   |   |          |   |   |
| STEREO MIX                  |   |   |   |   |   |          |   |   |
| PARAM 1                     |   |   |   |   |   |          |   |   |
| PARAM 2                     |   |   |   |   |   |          |   |   |
| PARAM 3                     |   |   |   |   |   |          |   |   |

## Voice data blank chart

You may copy the following chart as a memo sheet for your voice settings.

| YAMAHA V50 VOICE DATA       |           | DATE / / |   |   |   | VOICE NAME        |            |       |
|-----------------------------|-----------|----------|---|---|---|-------------------|------------|-------|
| OPERATOR                    |           | 1        | 2 | 3 | 4 | POLY / MONO MODE  |            |       |
| ALGORITHM                   |           |          |   |   |   | PITCH BEND RANGE  |            |       |
| FEEDBACK LEVEL              |           |          |   |   |   | FOOT SW           |            |       |
| LFO                         | WAVE      |          |   |   |   | PORTAMENTO        | MODE       |       |
|                             | SPEED     |          |   |   |   |                   | TIME       |       |
|                             | DELAY     |          |   |   |   | FOOT<br>CONTROL   | VOLUME     |       |
|                             | SYNC      |          |   |   |   |                   | PITCH      |       |
|                             | PMD       |          |   |   |   |                   | AMPLITUDE  |       |
|                             | AMD       |          |   |   |   |                   | MODULATION | PITCH |
| SENSITIVITY                 | PMS       |          |   |   |   | WHEEL             | AMPLITUDE  |       |
|                             | AMS       |          |   |   |   | BREATH<br>CONTROL | PITCH      |       |
|                             | AME       |          |   |   |   |                   | AMPLITUDE  |       |
|                             | EBS       |          |   |   |   |                   | PITCH BIAS |       |
|                             | KVS       |          |   |   |   |                   | EG BIAS    |       |
| OSCILLATOR                  | MODE      |          |   |   |   | AFTER<br>TOUCH    | PITCH      |       |
|                             | FIX SHIFT |          |   |   |   |                   | AMPLITUDE  |       |
|                             | FIX RANGE |          |   |   |   |                   | PITCH BIAS |       |
|                             | FREQUENCY |          |   |   |   |                   | EG BIAS    |       |
|                             | WAVE      |          |   |   |   | REVERB            | RATE       |       |
|                             | DETUNE    |          |   |   |   | EFFECT            | SELECT     |       |
| ENVELOPE<br>GENERATOR       | AR        |          |   |   |   |                   | BALANCE    |       |
|                             | D1R       |          |   |   |   |                   | OUT LEVEL  |       |
|                             | D1L       |          |   |   |   |                   | STEREO MIX |       |
|                             | D2R       |          |   |   |   |                   | PARAM 1    |       |
|                             | RR        |          |   |   |   |                   | PARAM 2    |       |
|                             | SHIFT     |          |   |   |   |                   | PARAM 3    |       |
| PITCH ENVELOPE<br>GENERATOR | PR1       |          |   |   |   |                   |            |       |
|                             | PL1       |          |   |   |   |                   |            |       |
|                             | PR2       |          |   |   |   |                   |            |       |
|                             | PL2       |          |   |   |   |                   |            |       |
|                             | PR3       |          |   |   |   |                   |            |       |
|                             | PL3       |          |   |   |   |                   |            |       |
| OUTPUT LEVEL                |           |          |   |   |   |                   |            |       |
| KEYBOARD<br>SCALING         | RATE      |          |   |   |   |                   |            |       |
|                             | LEVEL     |          |   |   |   |                   |            |       |
| TRANSPOSE                   |           |          |   |   |   |                   |            |       |



# IMPORTANT SAFETY AND INSTALLATION INSTRUCTIONS

## INFORMATION RELATING TO POSSIBLE PERSONAL INJURY, ELECTRIC SHOCK AND FIRE HAZARD POSSIBILITIES HAS BEEN INCLUDED IN THIS LIST.

**WARNING** — When using electronic products, basic precautions should always be followed, including the following:

1. Read all Safety and Installation Instructions, Supplemental Marking and Special Message Section data, and any applicable assembly instructions BEFORE using this product.
2. Check unit weight specifications BEFORE you attempt to move this product.
3. Main power supply verification. Yamaha Digital Musical Instrument products are manufactured specifically for use with the main supply voltage used in the area where they are to be sold. The main supply voltage required by those products is printed on the name plate. If any doubt exists please contact the nearest Yamaha Digital Musical Instrument retailer.
4. Some Yamaha Digital Musical Instrument products utilize external power supplies or adapters. Do NOT connect products of this type to any power supply or adapter other than the type described in the owners manual or as marked on the unit.
5. This product may be equipped with a plug having three prongs or a polarized line plug (one blade wider than the other). If you are unable to insert the plug into the outlet, contact an electrician to have the obsolete outlet replaced. Do NOT defeat the safety purpose of the plug. Yamaha products not having three prong or polarized line plugs incorporate construction methods and designs that do not require line plug polarization.
6. **WARNING** — Do NOT place objects on the power cord or place the unit in a position where anyone could walk on, trip over, or roll anything over cords of any kind. An improper installation of this type can create the possibility of a fire hazard and/or personal injury.
7. Environment: Your Yamaha Digital Musical Instrument should be installed away from heat sources such as heat registers and/or other products that produce heat.
8. Ventilation: This product should be installed or positioned in a way that its placement or location does not interfere with proper ventilation.
9. Yamaha Digital Musical Instrument products are frequently incorporated into "Systems" which are assembled on carts, stands or in racks. Utilize only those carts, stands, or racks that have been designed for this purpose and observe all safety precautions supplied with the products. Pay special attention to cautions that relate to proper assembly, heavier units being mounted at the lower levels, load limits, moving instructions, maximum usable height and ventilation.
10. Yamaha Digital Musical Instrument products, either alone or in combination with amplification, headphones, or speakers, may be capable of producing sound levels that could cause permanent hearing loss. Do NOT operate at high volume levels or at a level that is uncomfortable. If you experience any discomfort, ringing in the ears, or suspect any hearing loss, you should consult an audiologist.
11. Do NOT use this product near water or in wet environments. For example, near a swimming pool, spa, in the rain, or in a wet basement.
12. Care should be taken so that objects do not fall, and liquids are not spilled into the enclosure.
13. Yamaha Digital Musical Instrument products should be serviced by a qualified service person when:
  - a. The power supply/power adapter cord or plug has been damaged; or
  - b. Objects have fallen, or liquid has been spilled into the products; or
  - c. The unit has been exposed to rain; or
  - d. The product does not operate, exhibits a marked change in performance; or
  - e. The product has been dropped, or the enclosure of the product has been damaged.
14. When not in use, always turn your Yamaha Digital Musical Instrument equipment "OFF". The power supply cord should be unplugged from the outlet when the equipment is to be left unused for a long period of time. NOTE: In this case, some units may lose some user programmed data. Factory programmed memories will not be affected.
15. Electromagnetic Interference (RFI). Yamaha Digital Musical Instruments utilize digital (high frequency pulse) technology that may adversely affect Radio/TV reception. Please read FCC Information (inside cover) for additional information.
16. Do NOT attempt to service this product beyond that described in the user maintenance section of the owners manual. All other servicing should be referred to qualified service personnel.

## PLEASE KEEP THIS MANUAL FOR FUTURE REFERENCE!

This information on safety is provided to comply with U.S.A. laws, but should be observed by users in all countries.

# SPECIAL MESSAGE SECTION

**ELECTROMAGNETIC INTERFERENCE (RFI):** Your Yamaha Digital Musical Instrument Product has been type tested and found to comply with all applicable regulations. However, if it is installed in the immediate proximity of other electronic devices, some form of interference may occur. For additional RFI information see the FCC information section located in this manual.

**IMPORTANT NOTICE:** This product has been tested and approved by independent safety testing laboratories in order that you may be sure that when it is properly installed and used in its normal and customary manner, all foreseeable risks have been eliminated. **DO NOT** modify this unit or commission others to do so unless specifically authorized by Yamaha. Product performance and/or safety standards may be diminished. Claims filed under the expressed warranty may be denied if the unit is/has been modified. Implied warranties may also be affected.

**SPECIFICATIONS SUBJECT TO CHANGE:** The information contained in this manual is believed to be correct at the time of printing. Yamaha reserves the right to change or modify specifications at any time without notice or obligation to update existing units.

**NOTICE:** Service charges incurred due to a lack of knowledge relating to how a function or effect works (when the unit is operating as designed), are not covered by the manufacturer's warranty. Please study this manual carefully before requesting service.

**STATIC ELECTRICITY CAUTION:** Some Yamaha Digital Musical Instrument products have modules that plug into the unit to perform various functions. The contents of a plug-in module can be altered/damaged by static electricity discharges. Static electricity build-ups are more likely to occur during cold winter months (or in areas with very dry climates) when the natural humidity is low. To avoid possible damage to the plug-in module, touch any metal object ( a metal desk lamp, a door knob, etc.) before handling the module. If static electricity is a problem in your area, you may want to have your carpet treated with a substance that reduces static electricity build-up. See your local carpet retailer for professional advice that relates to your specific situation.

Model \_\_\_\_\_

Serial No. \_\_\_\_\_

Purchase Date \_\_\_\_\_

**This information on safety is provided to comply with U.S.A. laws, but should be observed by users in all countries.**

# INDEX

## A

Aftertouch (pitch, amplitude, pitch bias, EG bias) 53  
Algorithm 37  
Algorithm, feedback 40  
Appendix 122  
Assign mode, performance name 24

## B

Backup 108  
Bar graph 63  
Basic concepts of the V50 15  
Basic operation of the V50 16  
Basics of FM tone generation 36  
Breath controller (pitch, amplitude, pitch bias, EG bias) 52

## C

Card banks 95  
Card format 95  
Card operations 95  
Carrier and modulator 36  
Cartridges 22  
Channel information (MIDI on/off, basic receive channel, transmit channel, local on/off) 99  
Clear 67  
Combinations of operators 36  
Combine 110  
Compare functions 121  
Compatibility with other devices 22  
Condition (note on/off, data entry assign) 101  
Connecting other equipment via MIDI 10  
Connections 10  
Controller reset 110  
Copy 66, 75, 92  
Copy functions 120  
Creating a rhythm song 74  
Creating rhythm patterns 60  
Creating rhythm songs 72

## D

Damp (EG forced damp, volume damp) 116  
Data compatibility with other devices 22  
Data saved and loaded from card 96  
Delete 75, 92, 106  
Demonstration playback 14  
Detune 26  
Directory 108  
Disk 105  
Disk demo 14  
Disk functions 105

## E

Edit functions 91  
Editing a rhythm song 75  
Effect copy 120  
Effect on/off 30  
Effect output level, stereo mix 31, 55  
Effect parameters 32, 56  
Effect select, effect balance 30, 54  
Effects 21  
Envelope generator (AR, D1R, D2L, D2R, RR, shift) 45  
Envelope generator copy 120  
Erase 93  
Exclusive message (bulk dump) 103  
Exclusive message (device number) 103

## F

Factors determining the tone of a voice 37  
Foot controller (volume, pitch, amplitude) 50  
Format 108  
Four play modes 15  
Front and rear panels 6  
Function keys to select operations 16

## H

How to use this manual 5

## I

Initialized performance settings 125  
Initialized voice settings 126  
Inputting characters 17  
Insert 75, 92  
Inst settings 68, 77  
Internal demo 14  
Internal structure of the V50 15  
Introducing the V50 6

## J

Jump 75

## K

Keyboard scaling (rate) 48  
Keyboard scaling (level) 48  
Keyboard transmit channel 99

## L

Load 98, 105  
LFO select 28

LFO (wave, speed, delay, key sync, PMD, AMD) 41

## **M**

Making sound 11  
Master tuning, synthesizer volume 110  
Memory card 95  
Memory protect (internal, card) 109  
Memory protect 109  
Micro tuning on/off 28  
Microtuning 114  
Microtuning (full keyboard edit) 115  
Microtuning (full keyboard initialize) 115  
Microtuning (octave edit) 114  
Microtuning (octave initialize) 114  
Microtuning select 29  
Modulation wheel (pitch, amplitude) 51  
MDR 107  
MIDI data format 128  
MIDI functions 99  
MIDI Implementation Chart 145, 146, 147

## **N**

Notes 24  
Note limit (low) 25  
Note limit (high) 26  
Note shift 27

## **O**

Operator on/off 38  
Operators 36  
Oscillator (mode, coarse, fine, wave, detune, shift, range) 44  
Other functions 117  
Output assign 27  
Output level 48

## **P**

Parts and patterns 72  
Pattern job functions 66  
Performance compare 121  
Performance data blank chart 148  
Performance effect (chord) 113  
Performance effect (delay) 111  
Performance effect (pan) 112  
Performance effect copy 120  
Performance effect select 30  
Performance initialize 117  
Performance play mode and maximum simultaneous notes 18

Performance play mode display 20  
Performance play mode LEDs 20  
Performance recall 117  
Performance store 119  
Performance Edit 23, 24  
Performances 19  
Pitch envelope generator (PR1, PL1, PR2, PL2, PR3, PL3) 47  
Playing a song 87  
Playing rhythm patterns 58  
Playing rhythm songs 71  
Poly/mono mode select, pitch bend wheel range, foot switch 49  
Portamento (mode, time) 50  
Power on 11  
Power-on display 22  
Precautions 4  
Preset load 118  
Preset performances 12, 124  
Preset voices 12, 124  
Program change 101  
Program change table edit 103  
Program change table initialize 102  
Punch-in recording 88

## **Q**

Quantize 91  
Quick edit (attack) 39  
Quick edit (brilliance) 40  
Quick edit (release) 39  
Quick edit (volume) 39  
Quick edit 39

## **R**

Realtime recording 61  
Realtime recording and step recording 60, 78  
Realtime recording procedure 82  
Receive channel 25  
Remove 93  
Rename 107  
Reverb 54  
Rhythm assign 69, 77  
Rhythm machine 57  
Rhythm machine and sequencer 58  
Rhythm machine preparations 81  
Rhythm machine tone generator 57  
Rhythm patterns 58  
Rhythm patterns and rhythm songs 57  
Rhythm songs 58

**S**

Save 97, 105  
Search 75, 77  
Select a song to record 82, 84  
Select realtime recording 82  
Select step recording 84  
Select the sequencer function 82, 84  
Sensitivity (PMS, AMS, AME, EBS, KVS) 43  
Sequencer 78  
Sequencer and the synthesizer 79  
Sequencer data 79  
Set recording conditions 83, 84  
Setting numerical values 17  
Setting recording conditions 94  
Setting transmit channels 90  
Setup 67, 77  
Setup functions 88, 110  
Single amp 10  
Single play mode and maximum simultaneous notes 18  
Single play mode display 18  
Single play mode LEDs 18  
Single play or performance play mode 20  
Song clear 77  
Song copy 76  
Song edit 76  
Song job functions 76, 90  
Song name 76  
Songs 78  
Special non-pattern functions 72  
Specifications 127  
Start and Stop recording 83, 85  
Status 109  
Step recording 62  
Step recording procedure 84  
Store functions 119  
Storing setup data 94  
Switch (MIDI control change, MIDI aftertouch, MIDI pitch bend)100

Switching instruments on/off 20  
Switching modes 16  
Synthesizer preparations 80

**T**

Track mixdown 91  
Tracks 78  
Transmit channel, keyboard 99  
Transpose 49  
Troubleshooting 122  
Two amps 10

**U**

Using the rhythm machine 57  
Using the sequencer 78  
Utility functions 95

**V**

Velocity (fixed velocity, velocity curve) 115  
Voice compare 121  
Voice data blank chart 149  
Voice edit 118  
Voice editing 38, 39  
Voice initialize 117  
Voice name 54  
Voice number 25  
Voice recall 117  
Voice store 119  
Voice store when using voice edit 119  
Voice Edit 36  
Voices 18  
Voices and performances 18  
Volume 27

**W**

What is a sequencer? 78

**YAMAHA**