



EZ-TA



***Owner's Manual
Bedienungsanleitung
Mode d'emploi
Manual de instrucciones***

English

Deutsch

Français

Español

Copyright Notice

The followings are the titles, credits and copyright notices for six (6) of the songs pre-installed in this electronic trumpet:

In The Midnight Hour

Words and Music by Steve Cropper and Wilson Pickett
Copyright © 1965 IRVING MUSIC, INC. and COTILLION MUSIC, INC.
Copyright Renewed
All Rights Reserved Used by Permission

The Lonely Bull

By Sol Lake
Copyright © 1962 ALMO MUSIC CORP.
Copyright Renewed
All Rights Reserved Used by Permission

Respect

Words and Music by Otis Redding
Copyright © 1965 IRVING MUSIC, INC.
Copyright Renewed
All Rights Reserved Used by Permission

Soul Man

Words and Music by Isaac Hayes and David Porter
Copyright © 1967 ALMO MUSIC CORP. and WALDEN MUSIC, INC.
Copyright Renewed
All Rights Reserved Used by Permission

Spanish Flea

Words and Music by Julius Wechter
Copyright © 1965 ALMO MUSIC CORP.
Copyright Renewed
All Rights Reserved Used by Permission

Raiders March

from the Paramount Motion Picture RAIDERS OF THE LOST ARK
Music by John Williams
Copyright © 1981 by Bantha Music and Ensign Music Corporation
All Rights for the World Controlled and Administered by Ensign Music Corporation
International Copyright Secured All Rights Reserved

All Rights Reserved, Unauthorized copying, public performance and broadcasting are strictly prohibited regarding the above six songs pre-installed.

● **COPYRIGHT NOTICE**

This product incorporates and bundles computer programs and contents in which Yamaha owns copyrights or with respect to which it has license to use others' copyrights. Such copyrighted materials include, without limitation, all computer software, styles files, MIDI files, WAVE data and sound recordings. Any unauthorized use of such programs and contents outside of personal use is not permitted under relevant laws. Any violation of copyright has legal consequences. **DON'T MAKE, DISTRIBUTE OR USE ILLEGAL COPIES.**

Copying of the commercially available software is strictly prohibited except for your personal use.

PRECAUTIONS

PLEASE READ CAREFULLY BEFORE PROCEEDING

* Please keep this manual in a safe place for future reference.



WARNING

Always follow the basic precautions listed below to avoid the possibility of serious injury or even death from electrical shock, short-circuiting, damages, fire or other hazards. These precautions include, but are not limited to, the following:

Power supply/AC power adaptor

- Only use the voltage specified as correct for the instrument. The required voltage is printed on the name plate of the instrument.
- Use the specified adaptor (PA-3C or an equivalent recommended by Yamaha) only. Using the wrong adaptor can result in damage to the instrument or overheating.
- Check the electric plug periodically and remove any dirt or dust which may have accumulated on it.
- Do not place the AC adaptor cord near heat sources such as heaters or radiators, and do not excessively bend or otherwise damage the cord, place heavy objects on it, or place it in a position where anyone could walk on, trip over, or roll anything over it.

Do not open

- Do not open the instrument or attempt to disassemble the internal parts or modify them in any way. The instrument contains no user-serviceable parts. If it should appear to be malfunctioning, discontinue use immediately and have it inspected by qualified Yamaha service personnel.



CAUTION

Always follow the basic precautions listed below to avoid the possibility of physical injury to you or others, or damage to the instrument or other property. These precautions include, but are not limited to, the following:

Power supply/AC power adaptor

- When always holding the electric plug from the instrument or an outlet, always hold the plug itself and not the cord.
- Unplug the AC power adaptor when not using the instrument, or during electrical storms.
- Do not connect the instrument to an electrical outlet using a multiple-connector. Doing so can result in lower sound quality, or possibly cause overheating in the outlet.

Battery

- Always make sure all batteries are inserted in conformity with the +/- polarity markings. Failure to do so might result in overheating, fire, or battery fluid leakage.
- Always replace all batteries at the same time. Do not use new batteries together with old ones. Also, do not mix battery types, such as alkaline batteries with manganese batteries, or

Water warning

- Do not expose the instrument to rain, use it near water or in damp or wet conditions, or place containers on it containing liquids which might spill into any openings.
- Never insert or remove an electric plug with wet hands.

Fire warning

- Do not put burning items, such as candles, on the unit. A burning item may fall over and cause a fire.

If you notice any abnormality

- If the AC adaptor cord or plug becomes frayed or damaged, or if there is a sudden loss of sound during use of the instrument, or if any unusual smells or smoke should appear to be caused by it, immediately turn off the power switch, disconnect the adaptor plug from the outlet, and have the instrument inspected by qualified Yamaha service personnel.

batteries from different makers, or different types of batteries from the same maker, since this can cause overheating, fire, or battery fluid leakage.

- Do not dispose of batteries in fire.
- Do not attempt to recharge batteries that are not intended to be charged.
- When the batteries run out, or if the instrument is not to be used for a long time, remove the batteries from the instrument to prevent possible leakage of the battery fluid.
- Keep batteries away from children.
- If the batteries do leak, avoid contact with the leaked fluid. If the battery fluid should come in contact with your eyes, mouth, or skin, wash immediately with water and consult a doctor. Battery fluid is corrosive and may possibly cause loss of sight or chemical burns.

Location

- Do not expose the instrument to excessive dust or vibrations, or extreme cold or heat (such as in direct sunlight, near a heater, or in a car during the day) to prevent the possibility of panel disfiguration or damage to the internal components.
- Do not use the instrument in the vicinity of a TV, radio, stereo equipment, mobile phone, or other electric devices. Otherwise, the instrument, TV, or radio may generate noise.
- Do not place the instrument in an unstable position where it might accidentally fall over.
- Before moving the instrument, remove all connected adaptor and other cables.

Connections

- Before connecting the instrument to other electronic components, turn off the power for all components. Before turning the power on or off for all components, set all volume levels to minimum. Also, be sure to set the volumes of all components at their minimum levels and gradually raise the volume controls while playing the instrument to set the desired listening level.

Yamaha cannot be held responsible for damage caused by improper use or modifications to the instrument, or data that is lost or destroyed.

Always turn the power off when the instrument is not in use.

When using a power adaptor, even when the power switch is in the "STANDBY" position, electricity is still flowing to the instrument at the minimum level. When you are not using the instrument for a long time, make sure you unplug the AC power adaptor from the wall AC outlet.

Make sure to discard used batteries according to local regulations.

The illustrations and LED screens as shown in this owner's manual are for instructional purposes only, and may be different from the ones on your instrument.

Maintenance

- When cleaning the instrument, use a soft, dry cloth. Do not use paint thinners, solvents, cleaning fluids, or chemical-impregnated wiping cloths.

Handling caution

- Do not place vinyl, plastic or rubber objects on the instrument, since this might discolor the panel or keyboard.
- Do not rest your weight on, or place heavy objects on the instrument, and do not use excessive force on the buttons, switches or connectors.
- Do not operate the instrument for a long period of time at a high or uncomfortable volume level, since this can cause permanent hearing loss. If you experience any hearing loss or ringing in the ears, consult a physician.

Saving data

Saving and backing up your data

- Data in the instrument's internal memory can be lost due to operational errors or malfunction. Be sure to save any important data to external media via a computer connected to the instrument. (page 30)

● Trademarks

- Apple and Macintosh are trademarks of Apple Computer, Inc., registered in the U.S. and other countries.
- Windows is the registered trademark of Microsoft® Corporation.
- All other trademarks are the property of their respective holders.

***Congratulations and thank you for purchasing the Yamaha EZ-TP!
Please read this owner's manual carefully before using the instrument,
in order to take full advantage of its various features.
Make sure to keep this manual in a safe and handy place even after
you finish reading, and refer to it often when you need to better
understand an operation or function.***

Contents

Copyright Notice	2	Retained Data & Initialization	26
Setting Up	6	Retained Data	26
Power Requirements	6	Initialization Procedure	26
Connections	7	Connecting to MIDI Devices	27
Supplied Accessories	7	What is MIDI?	27
Controls & Features	8	Some Things You Can Do with MIDI	27
Holding the EZ-TP	10	Connecting To a Computer	28
Playing the EZ-TP	11	Loading Song Data Into the EZ-TP	29
Play by Singing	11	Setting the Transmit Channel	31
Fingering Chart	12	Local Control ON/OFF	31
Setting the EZ-TP To Match Your		Cleaning the EZ-TP	32
Voice	14	Troubleshooting	33
Adjust the Microphone	15	Message List	34
Select Different Sounds	16	Sound List	35
Changing the Pitch (Basic Key) of		MIDI Implementation Chart	36
the EZ-TP	17	MIDI Data Format	38
Tuning	19	Specifications	40
Producing a Thick "Brass Section"			
Sound	19		
Playing Songs	20		
Starting Song Playback	20		
Select and Listen To a Specific Song	20		
Play With Song Accompaniment	22		
Play Mode 1 – Play by Singing	22		
Play Mode 2 – Press the Valves			
Indicated By the Guide Lamps	23		
Play Mode 3 – Sing and Use the			
Valves	23		
Change the Song Tempo	24		
Change the Song Key	24		
Adjust the Song/Performance Volume			
Balance	24		
Velocity Curve	25		

Setting Up

Power Requirements

Although the instrument will run either from the supplied AC adaptor or optional batteries, Yamaha recommends use of an AC adaptor whenever possible. An AC adaptor is more environmentally friendly than batteries and does not deplete resources.

■ Using an AC Power Adaptor

- ① Make sure that the [STANDBY/ON] switch of the instrument is set to STANDBY.

⚠ WARNING

- Use **ONLY** a Yamaha PA-3C AC Power Adaptor (or other adaptor specifically recommended by Yamaha) to power your instrument from the AC mains. The use of other adaptors may result in irreparable damage to both the adaptor and the instrument.
- ② Connect the AC adaptor (PA-3C or other adaptor specifically recommended by Yamaha) to the power supply jack.
 - ③ Plug the AC adaptor into an AC outlet.

⚠ CAUTION

- **Unplug the AC Power Adaptor when not using the instrument, or during electrical storms.**

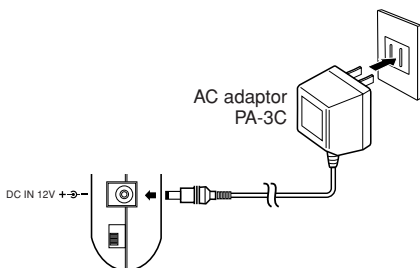

■ Using the Batteries

- ① Using a coin or screwdriver open the battery compartment located on the bottom of the instrument.
- ② Insert four new alkaline batteries, being careful to follow the polarity markings as shown below.
- ③ Replace the compartment cover, making sure that it locks firmly in place.

- NOTE**
- Connecting the AC adaptor automatically supplies from the adaptor and battery even when batteries are installed.

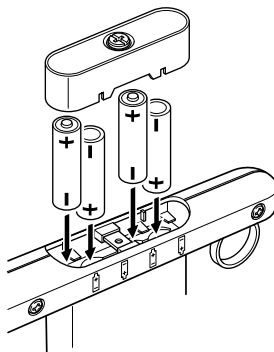

For battery operation the instrument requires four 1.5V “AA” size, LR6 or equivalent batteries. (Alkaline batteries are recommended.) When the batteries run low and the battery voltage drops below a certain level, the instrument may not sound or function properly. As soon as this happens, make sure to replace all batteries, following the precautions listed below.

⚠ CAUTION

- Be sure to observe the +/- polarity markings, and install the batteries with the proper orientation. Improper battery orientation can result in overheating, fluid leakage, and possibly fire.
- When the batteries run down, replace them with a complete set of four new batteries. NEVER mix old and new batteries. Do not use different kinds of batteries (e.g. alkaline and manganese) at the same time.
- If the instrument is not to be in use for a long time, remove the batteries from it, in order to prevent possible fluid leakage from the battery.
- Always use the AC power adaptor when using the Song Filer application to load song data into the EZ-TP. The Song Filer will not function when battery power is used.

Connections

CAUTION

- When connecting the EZ-TP to external equipment make sure that the power to all equipment is turned off to prevent possible electrical shock or equipment damage. Also start with all volume controls turned down to their minimum settings to prevent possible damage to speakers.
- Make sure that the EZ-TP ON/STANDBY switch is in the STANDBY position when connecting or disconnecting the AC adaptor or installing/ changing batteries to prevent possible damage to connected equipment.

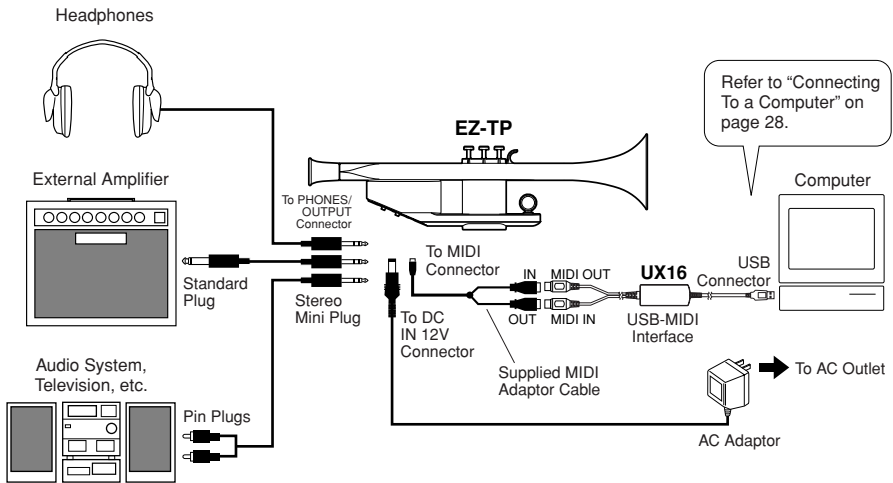

Supplied Accessories

- AC Adaptor
- MIDI Adaptor Cable
- Song Book

Controls & Features

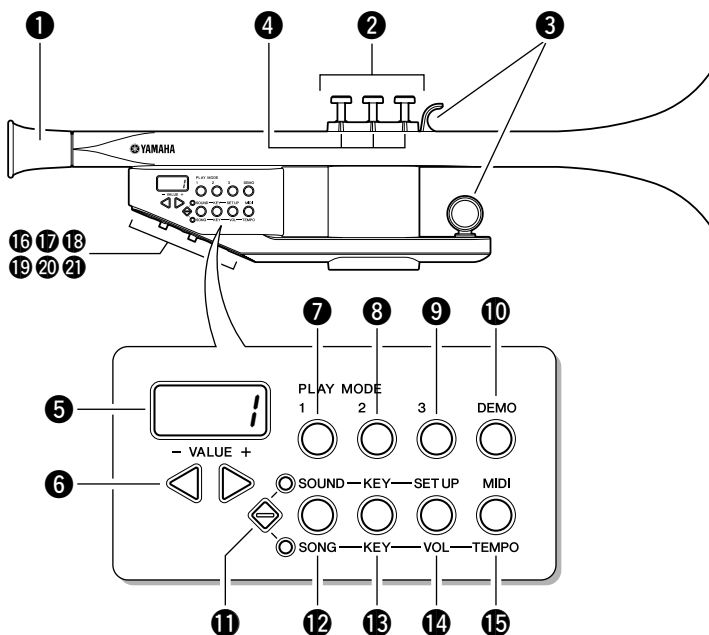

1 Mouthpiece

Place your lips against the mouthpiece and sing when playing the instrument.

2 Valves 1 ~ 3

The combination of valves pressed – i.e., the “fingering” – determines the pitch produced (page 12).

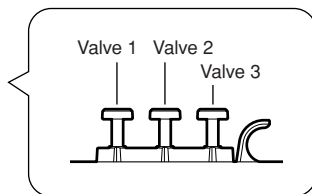

3 Finger Hooks

The little and ring fingers of your right and left hands, respectively, rest here to stabilize the instrument when playing (page 10).

4 Guide Lamps

The guide lamps glow red to indicate which valves you should press. Depending on the selected mode, they may also indicate song tempo or note timing (page 23).

5 Display

The display shows sound and song numbers, as well as parameter values.

6 [-] and [+] Buttons

These buttons are used to select sound and song numbers, as well as to edit parameter values.

When some parameters are selected the [+] and [-] buttons can be pressed simultaneously to recall the default setting.

7 PLAY MODE [1] Button

Sing into the mouthpiece along with the song to produce the appropriate trumpet lines (page 22).

8 PLAY MODE [2] Button

Press the valves indicated by the guide lamps to play the song melody (page 23).

9 PLAY MODE [3] Button

Press the appropriate valves while singing into the mouthpiece (page 23).

10 [DEMO] Button

Starts or stops song playback (page 20).

11  (Function Shift) Button

Alternately selects the functions listed above and below the four function buttons (12 ~ 15). When the upper indicator is lit the function buttons select the functions listed above the buttons, and when the lower indicator is lit the function buttons select the functions listed below the buttons.

Button names separated by a slash (12 ~ 15) indicate the upper and lower functions of the button, respectively.

For example, the [SOUND]/[SONG] button:

Upper indicator lit → [SOUND] button.

Lower indicator lit → [SONG] button.

12 [SOUND]/[SONG] Button

Selects the sound or song you want to play (page 16, 20).

13 [KEY] Button

Use to change the “key” or pitch of the sound.

When the upper indicator is lit this button changes the key of the sound you are playing (page 17). When the lower indicator is lit this button changes the key of song playback (page 24).

14 [SET UP]/[VOL] Button

When the upper indicator is lit this button accesses the instrument’s setup parameters (page 14). When the lower indicator is lit it can be used to adjust the volume of song playback in order to achieve the best balance with the sound you are playing (page 24).

15 [MIDI]/[TEMPO] Button

When the upper indicator is lit this button is used to access a range of MIDI parameters (page 31). When the lower indicator is lit it is used to adjust song playback tempo (page 24).

16 MIC VOL Control

Adjusts the sensitivity of the instrument's mouthpiece microphone to match your voice (page 15).

17 MIDI Connector

The supplied MIDI adaptor cable and an optional USB-MIDI interface and standard MIDI cable can be connected here to connect to other MIDI instruments or a computer running MIDI music software. (page 27).

18 MASTER VOL Control

Adjusts the overall volume (page 11).

19 PHONES/OUTPUT Connector

This connector can be used to feed the instrument's audio output to headphones, a stereo system, or amplifier (page 7).

20 DC IN 12V Connector

The supplied AC adaptor (PA-3C) should be connected here (page 6).

21 STANDBY/ON Switch

This is the instrument's power on/off switch (page 11).

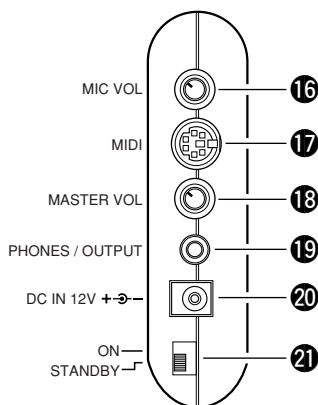

Holding the EZ-TP

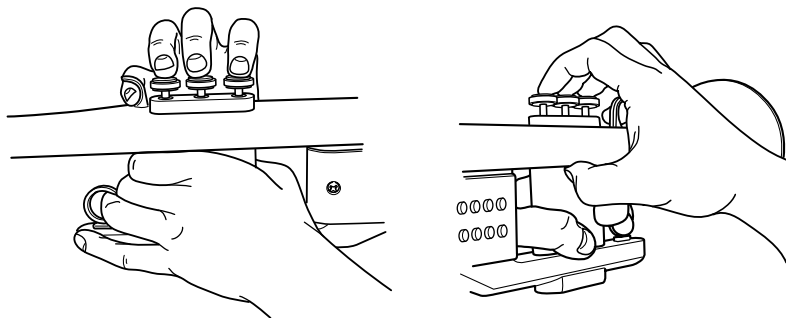

Hold the center of the valve case with the left hand, as shown in the illustration. Your right-hand index finger should rest on valve 1, your middle finger on valve 2, and your ring finger on valve 3. The right-hand thumb should rest comfortably below valves 1 and 2, and the little finger should be placed in the upper finger hook for support.

Playing the EZ-TP

When all preparations have been properly made, turn on the power and try playing the EZ-TP.

Play by Singing

1 Turn on the power.

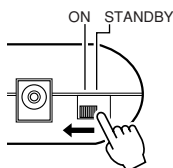

Slide the switch to the "ON" position to turn the power on. Slide the switch to the "STANDBY" position when you want to turn the power off.

2 Place the mouthpiece against your lips and sing a note.

This should produce a trumpet note.

⇒ Refer to "Setting the EZ-TP To Match Your Voice" on page 14.

3 Adjust the overall volume.

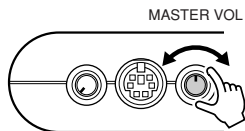

Rotate the control clockwise to increase the volume, or counter-clockwise to decrease the volume.

4 Sing a melody you want to play while fingering the valves to produce the appropriate notes.

A fingering chart is provided on page 12.

NOTE • If you sing without fingering the notes, only certain harmonics of one fingering will sound (page 13).

● About Trumpet Pitch

Like a real trumpet, the EZ-TP is a "B \flat " instrument" (page 17). This means that a "C" note played on the trumpet will normally produce the same pitch as a "B \flat " note on a piano.

The EZ-TP can also be set to other basic pitches – C, E \flat , and F, in addition to the standard B \flat pitch. The EZ-TP includes a function that lets you easily check the base pitch by ear – see "Check the Pitch Of the B \flat , C, E \flat , and F Keys" on page 18.

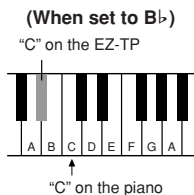

● Harmonics

In the chart on the previous page you can see that the same fingering – valves **1** and **2** – is used to produce two different notes: E and A. Real trumpets function in the same way, allowing you to produce more than one note with each fingering. These are “harmonic” notes, and are produced on a real trumpet by changing your “embouchure,” or the shape of your lips against the instrument’s mouthpiece. In the EZ-TP the harmonic produced is determined by the pitch of the note you sing into the mouthpiece.

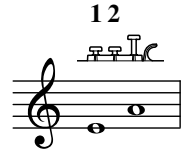

● Pitch

The default key for the EZ-TP is B♭ – the standard key for most trumpets. If you play Example 1 using the default B♭ key setting the actual pitches of the notes produced will be as shown in Example 2 (piano-pitch score).

● Trumpet

Example 1

Valve numbers { 0 1 1 1 0 1 2 0

3 2

The musical staff shows a sequence of eight notes: G4, A4, B4, C5, D5, E5, F5, and G5. The first note (G4) is enclosed in a dotted rectangular box. Below the staff, the valve numbers for each note are listed: 0, 1, 1, 1, 0, 1, 2, 0. The numbers 3 and 2 are positioned below the first and second '1's respectively.

● Piano

Example 2

The musical staff shows the actual pitches of the notes from Example 1: G4, A4, B♭4, C5, D5, E5, F5, and G5. The first note (G4) is enclosed in a dotted rectangular box.

● Singing the Correct Pitch

Since the key of the EZ-TP is B♭, you will also have to sing the notes you want to “play” in the key of B♭. To play the note indicated by the dotted outline in the above score, for example, you will need to sing a note corresponding to B♭ on a piano. Refer to “Check the Pitch Of the B♭, C, E♭, and F Keys” on page 18.

● Fingering

Two modes are provided that lets you play by singing only, without requiring trumpet fingerings. Refer to “Fr1 and Fr2 – Play By Singing Only” on page 18.

Setting the EZ-TP To Match Your Voice

Select the “0” or “1” setting to match the EZ-TP to the pitch of your voice. There is generally a difference of about 1 octave between male and female voices. If the appropriate setting is not made for your voice, the notes you produce may be either too high or too low, so it is important to make the right selection. Most female and adolescent voices are best matched by the “1” setting, while the average male voice is best matched by the “0” setting. The default EZ-TP setting is “0”.

1 Press the  button so that the upper indicator lights.

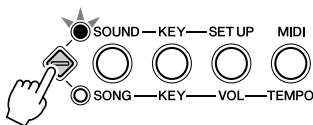

2 Press the [SET UP] button – the button will light.

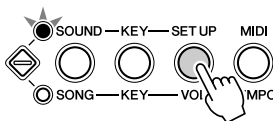

3 Press and hold the [SET UP] button, use the [-]/[+] buttons to select either “1” or “0”.

This setting is retained in memory even when the power is turned off. This setting can be changed during song playback, but in this case the new setting won't be retained in memory when the power is turned off.

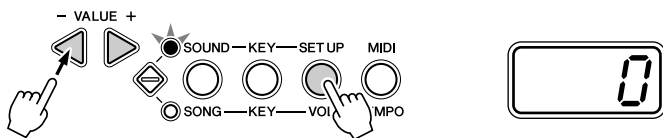

Adjust the Microphone

● Microphone Volume Adjustment

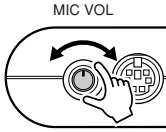

This step matches the sensitivity of the instrument's microphone to your voice.

Rotate the control clockwise to make it easier for quiet voices to produce sound. If you rotate the control counter-clockwise a louder voice will be required to produce sound.

You can turn the knob counter-clockwise when you want to reduce sensitivity so that ambient sounds and noise don't cause the instrument to sound.

● Precise Adjustment Procedure

This procedure can be used to calibrate the MIC VOL control for optimum sensitivity.

- 1** Press the  button so that the lower indicator lights.
- 2** Press the [TEMPO] button – the button will light.
- 3** Press and hold the [TEMPO] button while pressing the [+] button until “L” appears on the display.

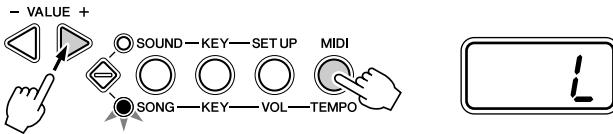

- 4** Set the MIC VOL control to minimum (rotate fully counter-clockwise).
- 5** Place the EZ-TP mouthpiece against your lips and sing the loudest note you will play when actually playing the EZ-TP. While singing a note at the loudest expected volume, rotate the MIC VOL control clockwise just until the valve 3 indicator lights, then stop. That will be the optimum sensitivity setting.

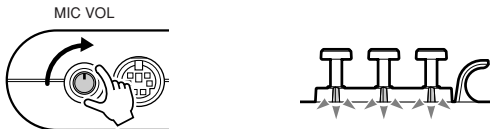

- 6** Once the adjustment has been made, perform steps 1 ~ 3 of the “Changing the Guide Lamp Mode” procedure described on page 23. Select “Aut” in step 3 so that the guide lamps indicate which valves you should play while playing along with a song.

Select Different Sounds

The EZ-TP has a range of 22 different sounds. You can play using trumpet sounds, or a variety of completely different sounds.

1 Press the  button so that the upper indicator lights.

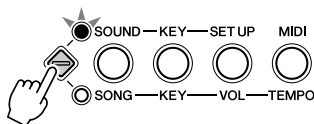

2 Press the [SOUND] button.

The number of the currently selected sound will appear on the display.

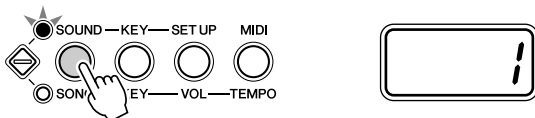

3 Use the [-]/[+] buttons to select the number of the sound you want to play.

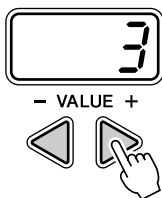

You can instantly recall the default “Sweet Trumpet” sound by pressing the [-] and [+] buttons simultaneously.

● Sound List

Sound Number	Sound Name	Sound Number	Sound Name
1	Sweet Trumpet	12	Trombone
2	Hard Trumpet	13	Horn
3	Soft Trumpet	14	Tuba
4	Trumpet	15	Sweet Soprano Sax
5	Sweet Muted Trumpet	16	Flute
6	Muted Trumpet	17	Clarinet
7	Synth Trumpet	18	PanFlute
8	Brass Section	19	Shakuhachi
9	Trumpet Brass	20	Human Voice
10	Trumpet w/Sax Ensemble	21	Strings
11	Mute Trumpet Ensemble	22	Oboe

Changing the Pitch (Basic Key) of the EZ-TP

The default pitch of the EZ-TP is B♭ – the same as most trumpets. This means that if you play a “C” on a piano-pitch score using the EZ-TP, the note produced will be different from the same note played on the piano. If you set the pitch of the EZ-TP to “C,” however, the notes produced by the EZ-TP and a piano or other “C” instrument will be the same.

The EZ-TP can be set to the following keys: B♭, C, E♭, F, Fr1, and Fr2.

NOTE • To change the key of song playback, see page 24.

1 Press the  button so that the upper indicator lights.

2 Press the [KEY] button.

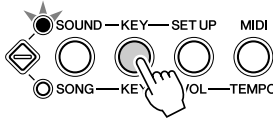

3 Use the [-]/[+] buttons to select a key.

Since the base pitch of the instrument changes when you change the key, you will have to change the notes you sing accordingly.

If you change the key to “F,” for example, in order to play a piano “C” like the one shown here, you’ll need to sing an “F” into the EZ-TP.



To check the base pitch refer to “Check the Pitch Of the B♭, C, E♭, and F Keys” on page 18.

The EZ-TP base pitch will be as follows for the various key settings:

- B♭: “C” on the EZ-TP will correspond to “B♭” on the piano.
- C: “C” on the EZ-TP will correspond to “C” on the piano.
- E♭: “C” on the EZ-TP will correspond to “E♭” on the piano.
- F: “C” on the EZ-TP will correspond to “F” on the piano.

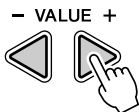
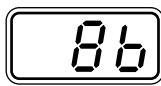
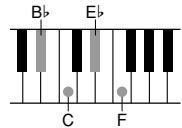

→ B♭, C, E♭, F, Fr1, Fr2

Select when you want to set a specific key (page 18).

Select when you want to play using only your voice (page 18).

Press the [-] and [+] keys simultaneously to revert to the default B♭ setting.

The B \flat , C, E \flat , or F key setting will be retained even when the power is turned off. This setting can be changed during song playback, but in this case the new setting won't be retained in memory when the power is turned off.

● Check the Pitch Of the B \flat , C, E \flat , and F Keys

The base pitch of the EZ-TP will change according to the selected key.

Before playing the EZ-TP by singing into the mouthpiece, you can check the pitch as follows:

- 1** Press the  button so that the upper indicator lights.
- 2** Press the [KEY] button – the button will light.
- 3** To play the base “C” pitch: Press the PLAY MODE [1] button while holding the [KEY] button.
To play a scale beginning on “C”: Press the [DEMO] button while holding the [KEY] button.

● Fr1 and Fr2 – Play By Singing Only

Use these modes when you want to play the EZ-TP by singing into the mouthpiece without fingering the valves.

Fr1 : The pitch of your voice will be followed in semitone-steps.

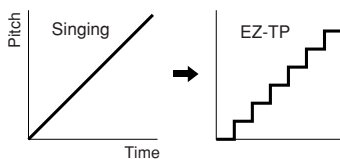

Fr2 : The pitch of your voice will be followed precisely. This mode allows you to produce delicate pitch nuances that are not possible on a keyboard, for example. Use this mode when you want to play with pitch slides.

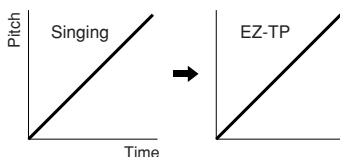

When the Fr1 or Fr2 mode is selected, the EZ-TP will revert to the default B \flat key setting when the power is turned off.

Adjusting the Tracking

In some cases the proper pitch may not be produced. In such cases you might need to adjust the tracking so that more time is allowed for pitch detection, thus minimizing the problem. This function applies to all key settings.

- 1** Press the  button so that the upper indicator lights.
- 2** Press the [KEY] button – the button will light.
- 3** Press and hold the [KEY] button use the [-]/[+] buttons to set the tracking as required.

The available tracking values are 1 ~ 3.

The most accurate pitch detection will be achieved with a setting of “3,” but because of the longer detection time you might notice a delay between the time you start singing into the mouthpiece and the time the trumpet sound begins.

Tuning

The tuning of the sound you play on the EZ-TP can be adjusted from A = 425 Hz to 453 Hz in 1-Hz increments.

Use this feature when you want to tune the EZ-TP to other instruments.

- 1** Press the  button so that the lower indicator lights.
- 2** Press the [KEY] button – the button will light.
- 3** Press and hold the [KEY] button use the [-]/[+] buttons to set the tuning as required.

The initial default setting is A = 440 Hz.

Producing a Thick “Brass Section” Sound

This function automatically adds a note one octave above or below the notes you play, producing a thicker “brass section” type sound.

- 1** Press the  button so that the upper indicator lights.
- 2** Press the [SOUND] button – the button will light.
- 3** Press and hold the [SOUND] button use the [-]/[+] buttons to select “-1”, “off”, or “1”.

The “-1” setting produced a note an octave below notes you play, and the “1” setting produces an note an octave above notes you play.

Playing Songs

The EZ-TP features a selection of 10 songs that are ideal for trumpet performance. You can use the songs as accompaniment for your own performance, as described on page 22, but here we'll describe how to select and play the songs.

In addition to the internal songs, songs downloaded from the internet can be loaded into the EZ-TP and played. Refer to page 27 for information on downloading song data – “Connecting to MIDI Devices.”

Starting Song Playback

1 Press the [DEMO] button.

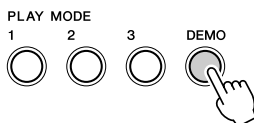

Playback of the currently selected song will begin and repeat until song playback is stopped.

To hear all the internal songs in sequence, press the [DEMO] button while holding the [SOUND/SONG] button.

2 Press the [DEMO] button a second time to stop song playback.

Select and Listen To a Specific Song

1 Press the  button so that the lower indicator lights.

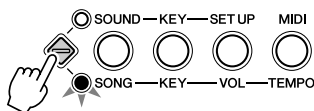

2 Press the [SONG] button.

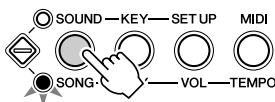

3 Use the [-]/[+] buttons to select the song you want to listen to.

Select a song from the song list provided below.

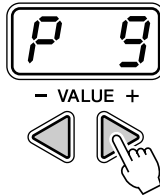

NOTE • "P" appears before the internal "Preset" song numbers. Songs downloaded from a computer are loaded preceding the "P 1" song, and appear on the display as "F 1," "F 2," ... etc. Downloaded songs are selected by using the [-]/[+] buttons in the same way as the preset songs.

4 Press the [DEMO] button.

Playback of the selected song will begin.

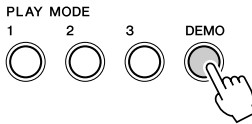

5 Press the [DEMO] button again to stop playback.

● Song List

Song Number	Song Name
P 1	Soul Man
P 2	Raiders March (from the Paramount Motion Picture RAIDERS OF THE LOST ARK)
P 3	In the Midnight Hour
P 4	Respect
P 5	The Lonely Bull

Song Number	Song Name
P 6	Spanish Flea
P 7	When the Saints Go Marching In
P 8	O Come All Ye Faithful
P 9	Gloria all'Egitto (from "Aida")
P10	Symphony No.9 "From the New World" Fourth Movement

Some parts of the preset songs cannot be reproduced by playing only the EZ-TP.

Play With Song Accompaniment

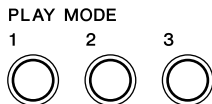

Select a song and then press one of the **PLAY MODE** buttons to select the play mode.

The song will play without the melody (accompaniment only) so that you can play the melody yourself. There's even a mode in which the guide lamps show you which valves to press!

SMF Format 0 songs downloaded from the internet can be used for accompaniment in the same way.

● Listen To an Example

When you play a song for the first time it might be a good idea to listen to the entire song first by selecting the song and then pressing the [DEMO] button.

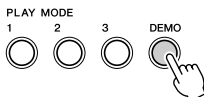

Listen carefully to the melody!

Play Mode 1 – Play by Singing

Play the song melody by simply singing in time with the guide lamps. There's no need to play the valves in this mode.

I Select a song and press the **PLAY MODE [1]** button.

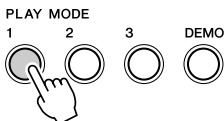

Keeping time with the guide lamps, sing each note of the melody into the EZ-TP mouthpiece with clear breaks between each note. If you don't leave clear breaks between each note the EZ-TP pitch may not always change as desired. If this happens press and release any valve in time with the guide lamps to ensure that the correct pitches are played.

Press the **PLAY MODE [1]** button when you want to stop song playback.

Play Mode 2 – Press the Valves Indicated by the Guide Lamps

In this mode you can play the melody by playing the appropriate valve fingerings in time with the song. There is no need to sing the melody in this mode.

The guide lamps will show you which valves to press to finger each note.

1 Select a song and press the PLAY MODE [2] button.

Press the valves indicated by the guide lamps that light red. Song playback will stop and wait until you play the correct fingering for each note.

Press the PLAY MODE [2] button when you want to stop song playback.

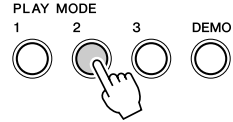

Play Mode 3 – Sing and Use the Valves

Play by singing and using the fingerings learned in Play Mode 2.

1 Select a song and press the PLAY MODE [3] button.

The accompaniment will play through without stopping. Sing the melody while playing the correct fingerings for each note.

Press the PLAY MODE [3] button when you want to stop song playback.

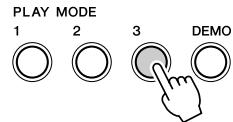

● Changing the Guide Lamp Mode

The guide lamps normally light during song playback.

With the default “Aut” setting the guide lamps flash to indicate melody note timing in Play Mode 1, while indicating valve fingerings in all other modes. the guide lamp mode can be changed as follows:

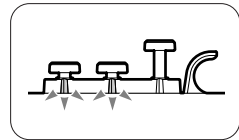

- 1 Press the  button so that the lower indicator lights.
- 2 Press the [TEMPO] button – the button will light.
- 3 Press and hold the [TEMPO] button, use the [-]/[+] buttons to select the desired guide lamp mode:

Ruε The guide lamps indicate melody note timing in Play Mode 1, and valve fingering in all other modes.

F The guide lamps always indicate valve fingering.

ε The guide lamps always indicate melody note timing.

b The guide lamps flash to indicate the tempo and beat of the song.

ε Used for precise adjustment of the MIC VOL control (page 15).

αFF The guide lamps will not light.

Change the Song Tempo

If the tempo of a song is too fast to play comfortably, you can slow it down (or speed it up if you like) as follows.

- 1** Press the  button so that the lower indicator lights.
- 2** Press the [TEMPO] button.
- 3** Use the [-]/[+] buttons to set the tempo as required.
Press the [-] button to incrementally decrease the tempo, or the [+] button to incrementally increase the tempo.
Press the [-] and [+] buttons simultaneously to recall the song's default tempo.

Change the Song Key

The key of EZ-TP song playback can be adjusted in semitone steps.

If, for example, the key of a song you have downloaded is too high to sing comfortably, you can adjust the key as follows.

- 1** Press the  button so that the lower indicator lights.
- 2** Press the [KEY] button.
- 3** Use the [-]/[+] buttons to set the key as required.
The song key can be adjusted over a -12 ~ +12 range in semitone increments.
Press the [-] and [+] buttons simultaneously to recall the song's default key.

NOTE • See page 17 for information changing the key of the sound you play yourself.

Adjust the Song/Performance Volume Balance

This procedure allows you to adjust the balance between song playback and the notes you play on the EZ-TP by setting the volume of the playback sound. The adjustable range is from 0 ~ 150% in 5% increments. The default setting is 100%.

- 1** Press the  button so that the lower indicator lights.
- 2** Press the [VOL] button.
- 3** Use the [-]/[+] buttons to set the song playback volume as required.

Velocity Curve

The optimum sensitivity adjustment makes it easier to play with the broadest dynamic range in response to how loudly you sing into the mouthpiece. Sensitivity can be adjusted in five steps: a setting of “-1” or “-2” would suit a player with a louder voice, while a setting of “1” or “2” would be more appropriate for a player with a softer voice.

1 Press the  button so that the upper indicator lights.

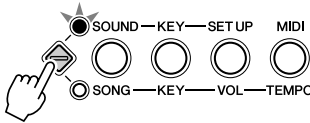

2 Press the [SET UP] button.

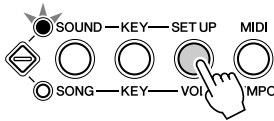

3 Use the [-]/[+] buttons to set the sensitivity as required.

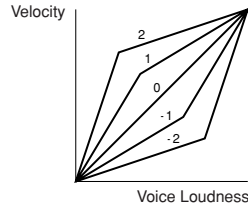
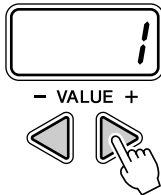

Retained Data & Initialization

Retained Data

Although most settings revert to their default values when the EZ-TP power is turned off and then on again, the following data are retained:

- Instrument Key Settings (B, C, E, F)page 17
- Player's Voice Matchingpage 14
- Song Data Loaded from a computerpage 29

Initialization Procedure

This procedure completely erases all user settings, including the retained data listed above, and restores the initial factory settings.

CAUTION • This procedure completely erases all user settings and song data loaded from a computer, and restores the initial factory settings.

1 Turn the power on while simultaneously holding the [SOUND]/[SONG] and [DEMO] buttons.

Press the [-] button if you want to cancel the initialization operation.

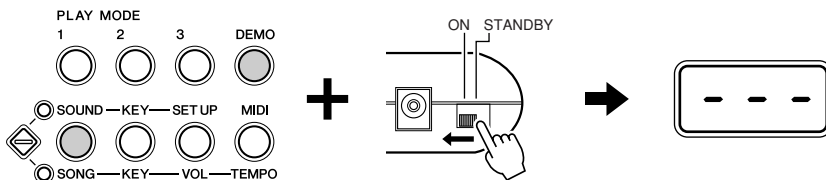

2 Press the [+] button.

This executes the initialization.

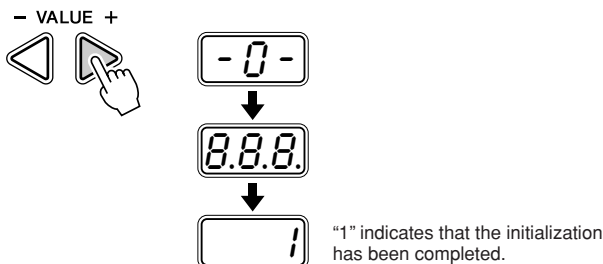

Connecting to MIDI Devices

The EZ-TP features a MIDI connector that can be connected to other MIDI instruments and devices for expanded musical functionality.

NOTE • Song data cannot be transmitted from the EZ-TP.

What is MIDI?

MIDI (Musical Instrument Digital Interface) is a world-standard interface for communication between electronic musical instruments and music devices. When MIDI-equipped instruments are connected via a MIDI cable, it becomes possible to transfer performance and setting data between them for significantly enhanced performance and production potential.

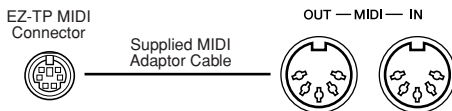

MIDI Connector: This connector transmits and receives MIDI data to and from other MIDI devices. The EZ-TP MIDI connector is a special type that combines transmit and receive functions in one connector. Always use the supplied MIDI adaptor cable when connecting the EZ-TP to other MIDI devices.

NOTE • Standard MIDI cables, sold separately at most music stores, are required to connect the EZ-TP to other MIDI devices.
• Use MIDI cables no longer than 15 meters. Cables longer than this can cause transmit/receive errors.

CAUTION • Make sure that the EZ-TP power is OFF when connecting to other MIDI devices. Once the required connections have been made, turn on the external devices first, then the EZ-TP.

Some Things You Can Do with MIDI

By using the EZ-TP MIDI functions you can transfer performance data between the EZ-TP and other MIDI instruments, or load song data into the EZ-TP from a computer (song data cannot be transmitted from the EZ-TP).

● Transfer Performance Data To and From Another Instrument

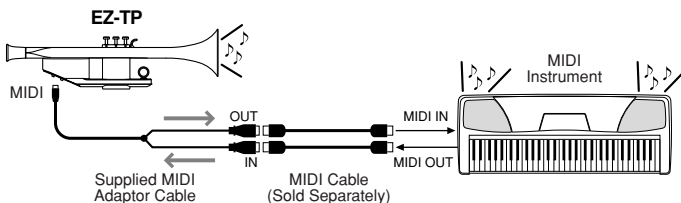

● Transfer Song Data to the EZ-TP

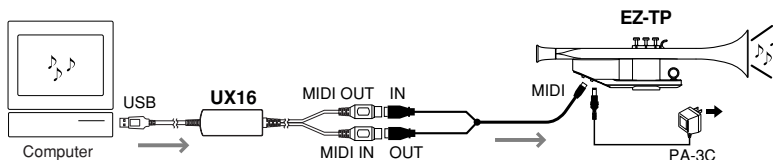

NOTE • Always use the AC Adaptor to power the EZ-TP when using the Song Filer application to transfer song data.

Connecting To a Computer

When the EZ-TP is properly connected to a computer it becomes possible to use the computer to record or manipulate performance data played on the EZ-TP, or to send performance data from the computer that will play the EZ-TP.

A Yamaha UX16 or similar USB-MIDI interface and MIDI cables will be necessary for MIDI connection between the EZ-TP and a USB-equipped computer.

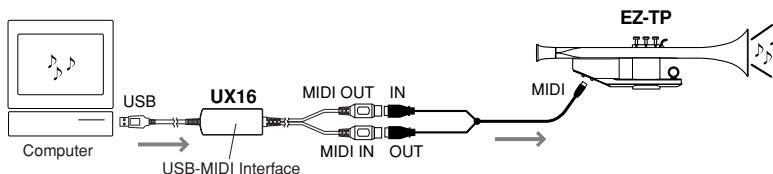

NOTE • A USB-MIDI interface (such as the Yamaha UX16) is required for MIDI connection to a computer.
• If you use the UX16 interface, install the driver supplied with the interface on your computer.

Loading Song Data Into the EZ-TP

The EZ-TP includes preset songs P 1 ~ P10, but you can load other songs from your computer and use them in the same way as the preset songs.

Song data can be transferred from your computer to the EZ-TP using the free Song Filer application that can be downloaded from the URL below. Download the application, and install it on your computer.

● Data That Can Be Loaded Into the EZ-TP from a Computer

- Songs : 99 songs max (song numbers F 1 ~)
- Data : 992 kilobytes
- Data Format : SMF Format 0

For example, you could load up to 9 songs containing 100 kilobytes of data each.

■ Installing the Song Filer Application

First use your computer to connect to the internet and download the Song Filer from the following URL:

Yamaha Home Page Address

<http://music.yamaha.com/homekeyboard>

● The minimum computer requirements form Song Filer operation are as follows:

[Windows]

OS	: Windows® 95/98/Me/2000/XP
CPU	: Pentium®/100 MHz or faster
Memory	: More than 8 MB
Available Hard Disk Space	: More than 2 MB
Display	: 800 x 600, 256 colors or more

[Macintosh]

OS	: Mac OS 7.5 ~ 9.22 (OS X not supported)
CPU	: Power PC or better
Memory	: More than 8 MB
Available Hard Disk Space	: More than 2 MB
Display	: 800 x 600, 256 colors or more

NOTE • The latest version of the Song Filer application is available from the URL listed above. Installation instructions are provided on the website. Be sure to use version 2.0.0 or later.

■ Using the Song Filer

After installing the Song Filer application on your computer, connect the EZ-TP as described below.

Instructions for operating the Song Filer application are provided in the pdf file included with the Song Filer download package.

● Loading Data from your Computer

This setup allows you to load song data into the EZ-TP from your computer. The song data is loaded before preset song number 1. Only song data in SMF Format 0 can be loaded.

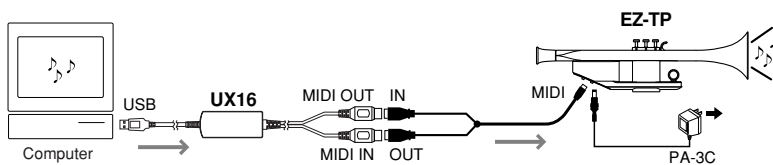

Song data cannot be transferred from the EZ-TP to a computer.

- ⚠ CAUTION** • *The Song Filer cannot be used while the EZ-TP is being powered by batteries. Always power the EZ-TP from the supplied AC adaptor when using the Song Filer to transfer song data from a computer to the EZ-TP.*
 - ⚠ CAUTION** • *Don't turn off the power during a data transfer. Not only will the data being transferred not be saved, memory operation may become unstable and all memory contents may be lost when the power is turned on/off.*
 - ⚠ CAUTION** • *Data loaded into the EZ-TP can be lost due to malfunction or mis-operation. Be sure to save a copy of data you want to keep on your computer.*
- NOTE** • *The channel-1 part of loaded songs will be played by the currently selected EZ-TP sound. Also, the guide lamps will normally light in response to the channel-1 data.*

● Erasing Loaded Song Data from the EZ-TP Memory

The procedure for erasing loaded song data from the EZ-TP memory is described in the pdf file included with the Song Filer download package.

Setting the Transmit Channel

This procedure sets the MIDI channel via which the EZ-TP data will be transmitted. The possible settings are: off, 1 ~ 16.

- 1** Press the  button so that the upper indicator lights.
- 2** Press the [MIDI] button.

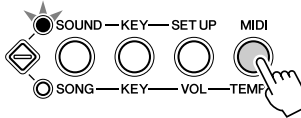

- 3** Use the [-]/[+] buttons to select “off,” or MIDI channel 1 ~ 16. When “off” is selected no data will be transmitted by the EZ-TP.

Local Control ON/OFF

This setting determines whether the EZ-TP plays its own internal tone generator or not.

- on (ON) : This is the normal setting, in which notes you play on the EZ-TP are sounded by the EZ-TP itself. Also, all performance data (not including song playback) is transmitted via the MIDI connector.
- off (OFF) : Notes played on the EZ-TP are not sounded by the EZ-TP itself, but will be sounded by an external MIDI tone module if the appropriate MIDI connections are made.
- EZC (EZC) : Notes played on the EZ-TP are not sounded by the EZ-TP. This setting is provided for future expansion.

The initial default setting is “on.”

- 1** Press the  button so that the upper indicator lights.
- 2** Press the [MIDI] button – the button will light.
- 3** Press and hold the [MIDI] button use the [-]/[+] buttons to select “on” or “off.”

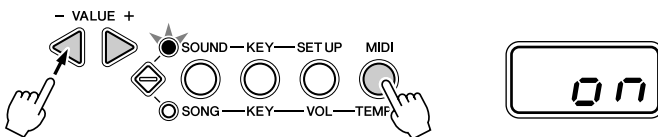

NOTE • No sound will be produced by the EZ-TP when Local Control is set to either “off” or “EZC.” The internal EZ-TP tone generator will only sound when Local Control is turned “on.”

Cleaning the EZ-TP

It is important to keep wind-type instruments like the EZ-TP clean at all times. Refer to the instructions below.

● Mouthpiece

When the mouthpiece requires cleaning, remove it from the instrument and wash it in clean water. After washing dry the mouthpiece carefully with either a soft dry cloth, or a soft damp cloth that has been wrung almost dry.

CAUTION • Always remove the mouthpiece from the instrument for washing and cleaning.

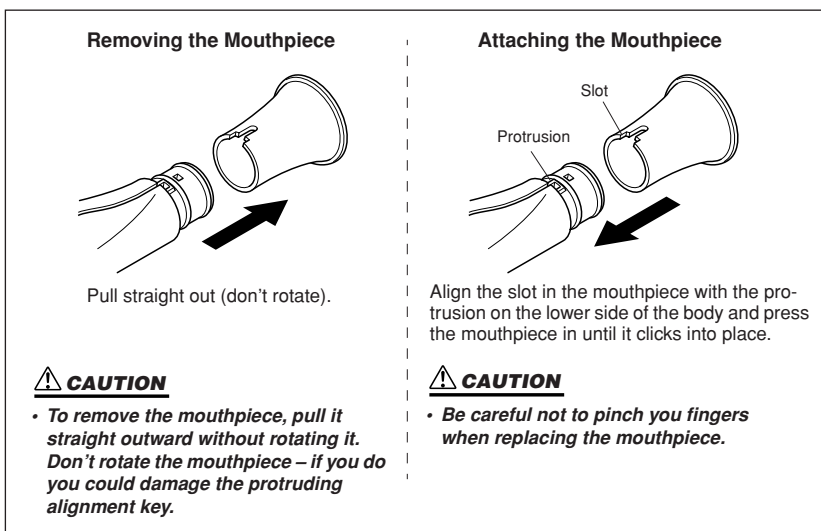

● Body

When the body of the instrument requires cleaning wipe it carefully with either a soft dry cloth, or a soft damp cloth that has been wrung almost dry.

CAUTION • Only the mouthpiece, removed from the instrument, should be washed in water. The body of the instrument contains electronics that could suffer permanent damage if exposed to water.

Troubleshooting

Problem	Possible Cause & Solution
No Sound.	<ul style="list-style-type: none">• Are the batteries depleted? (Page 6)• Is the overall volume turned up to an appropriate level? (Page 11)• Is a pair of headphones or cable plugged into the PHONES/OUTPUT jack? (Page 7)• Is the Local Control parameter set to “off” or “EZC”? This parameter should be turned “on.” (Page 31)
The desired pitch is not produced.	<ul style="list-style-type: none">• Have you set the instrument’s voice octave setting to match your voice? (Page 14)
The EZ-TP doesn’t respond properly to notes I’m singing.	<ul style="list-style-type: none">• Make sure that the mouthpiece is in proper contact with your lips, with no gaps or leakage.• Try singing using a variety of vowels or percussive sounds (“ta,” for example). The EZ-TP responds to different sounds in different ways, and you may need experiment to find the ideal match.• Try adjusting the MIC VOL control (Page 15).
Sound is produce even when I’m not singing into the mouthpiece.	<ul style="list-style-type: none">• The instrument may be responding to other sound and noise. Try turning the microphone volume control down a bit. (Page 15)
Noise or hum is produced.	Is there a cell (mobile) phone operating near the EZ-TP? You may need to turn nearby cell (mobile) phones off, or move them farther away from the EZ-TP.
Distorted sound.	Is the overall volume turned up too high? In some cases – particularly when playing downloaded songs – the sound may become distorted if the volume is turned up too high. Try lowering the volume a little.
Data cannot be loaded from a computer using the Song Filer application.	The AC adaptor may not be connected to the EZ-TP. Make sure that the AC adaptor is connected when loading data from a computer.

Message List

Display	Message
<i>E 1</i>	MIDI data receive error.
<i>E 2</i>	MIDI buffer full.
<i>E 3</i>	MIDI checksum error.
<i>E 4</i>	MIDI device number error.
<i>E 10</i>	File open error.
<i>E 11</i>	The specified file is not SMF.
<i>E 12</i>	SMF header length error.
<i>E 13</i>	The specified file is not SMF format 0.
<i>E 14</i>	Type resolution of specified file not supported.
<i>E 15</i>	Value resolution of specified file not supported.
<i>E 16</i>	The specified file has no track data.
<i>E 17</i>	SMF data error – data byte received when running status has not been read, etc.
<i>E 18</i>	Data read failure during playback.



● Maximum Polyphony (Simultaneous Notes)

The maximum number of notes that can be simultaneously produced by this instrument is 32. This includes song playback and notes being played on the EZ-TP.

- NOTE**
- When using MIDI data from an external MIDI device to play the EZ-TP, use MIDI program change numbers to select the desired sound.
 - Program change numbers are often specified as numbers "0 ~ 127." Since the EZ-TP uses a "1 ~ 128" numbering system, in such cases it is necessary to subtract 1 from the transmitted program change numbers to select the appropriate sound: e.g. to select No. 57 in the list below, transmit program change number 56.

● Maximale Polyphonie (Gleichzeitige Noten)

Die maximale Anzahl der Noten, die von diesem Instrument gleichzeitig erzeugt werden können, beträgt 32. Dazu zählen die Songwiedergabe und die auf der EZ-TP gespielten Noten.

- HINWEIS**
- Wenn Sie zum Spielen der EZ-TP die MIDI-Daten eines externen Geräts verwenden, verwenden Sie die MIDI-Programmwechselnummern, um den gewünschten Sound zu wählen.
 - Die Programmwechselnummern werden häufig als Nummern „0 ~ 127“ angegeben. Da die EZ-TP das Nummerierungssystem „1 ~ 128“ verwendet, muss in diesen Fällen von den gesendeten Programmwechselnummern eine 1 abgezogen werden, um den entsprechenden Sound auszuwählen: wenn Sie z.B. in der nachstehenden Liste Nr. 57 auswählen möchten, dann senden Sie die Programmwechselnummer 56.

● Polyphonie maximale (notes simultanées)

Le nombre maximal de notes pouvant être produites simultanément par cet instrument est de 32 notes. Cela inclut la reproduction de morceau et les notes jouées sur l'EZ-TP.

- NOTE**
- Lors de l'utilisation de données MIDI à partir d'un périphérique MIDI externe pour jouer sur l'EZ-TP, servez-vous des numéros de changement de programme MIDI pour sélectionner le son souhaité.
 - Les numéros de changement de programme sont souvent spécifiés comme étant de « 0 à 127 ». Etant donné que l'EZ-TP utilise un système de numérotation allant de « 1 à 128 », il est nécessaire, dans ces cas-là, de soustraire 1 des numéros de changement de programme afin de sélectionner le son approprié : par exemple, pour sélectionner le n° 57 dans la liste ci-dessous, il faut transmettre le numéro de changement de programme 56.

● Polifonía máxima (notas simultáneas)

El número máximo de notas que este instrumento puede reproducir simultáneamente es 32, incluida la reproducción de canciones y las notas que se tocan en el EZ-TP.

- NOTA**
- Cuando utilice datos MIDI de un dispositivo MIDI externo para tocar el EZ-TP, utilice los números de cambio de programa de MIDI para seleccionar el sonido deseado.
 - Los números de cambio de programa se especifican a menudo como "0 a 127". Puesto que el EZ-TP utiliza un sistema de numeración de "1 a 128", en tales casos será necesario restar 1 de los números de cambio de programa transmitidos para seleccionar el sonido adecuado: p. ej., para seleccionar el número 57 de la lista siguiente, transmita el número de cambio de programa 56.

Sound No.	MSB (0~127)	LSB (0~127)	MIDI Program Change # (1~128)	Sound
1	0	112	57	Sweet Trumpet
2	0	114	57	Hard Trumpet
3	0	113	57	Soft Trumpet
4	0	0	57	Trumpet
5	0	112	60	Sweet Muted Trumpet
6	0	113	60	Muted Trumpet
7	0	112	82	Synth Trumpet
8	0	112	62	Brass Section
9	0	113	62	Trumpet Brass
10	0	113	67	Trumpet w/Sax Ensemble
11	0	114	60	Mute Trumpet Ensemble

Sound No.	MSB (0~127)	LSB (0~127)	MIDI Program Change # (1~128)	Sound
12	0	0	58	Trombone
13	0	112	61	Horn
14	0	0	59	Tuba
15	0	112	65	Sweet Soprano Sax
16	0	0	74	Flute
17	0	0	72	Clarinet
18	0	0	76	PanFlute
19	0	112	78	Shakuhachi
20	0	0	53	Human Voice
21	0	0	49	Strings
22	0	0	69	Oboe

MIDI Implementation Chart / MIDI-Implementierungstabelle /

YAMAHA [EZ-TP] Date : 11-MAY-2004
 Model EZ-TP MIDI Implementation Chart Version : 1.0

Function...	Transmitted	Recognized	Remarks
Basic Channel	1 1 - 16	1 - 16 1 - 16	
Mode	x x *****	x 3, 4 (m=1) x	*2
Note Number : True voice	0 - 127 *****	0 - 127 0 - 127	
Velocity Note ON Velocity Note OFF	o 9nH, v=1-127 o 8nH, v=1-127	o 9nH, v=1-127 x	
After Touch	x x	o o	*1 *1
Pitch Bend	o	o 0-24 semi	*1
0, 32	o	o	*1
1, 5, 7, 10, 11	o (7)	o	*1
6, 38	x	o	*1
64-67	o (64, 66)	o	*1
71-74	x	o	*1
			Bank Select
			Data Entry
			Sound Controller

Feuille d'implémentation MIDI / Gráfica de implementación MIDI

Control	84 91, 93, 94 96-97 98-99 100-101	x x x x x					o o o o o	*1 *1 *1 *1 *1	Portamento Cntrl Effect Depth RPN Inc, Dec NRPN LSB, MSB RPN LSB, MSB
Prog Change	: True #	o *****	o *****	o 0 - 127	o 0 - 127				
System Exclusive		x							
Common	: Song Pos. : Song Sel. : Tune	x x x					x x x		
System Real Time	: Clock : Commands	x x					x o		
Aux	: All Sound OFF : Reset All Cntrls : Local ON/OFF : All Notes OFF : Active Sense : Reset	o x x o o x	o x x o o x	o x x o o x	o x x o o x	o x o o o x	o o o o o o	o o o o o o	o o o o o o

*1 receive if switch is on.

*2 m is always treated as "1" regardless of its value.

Mode 1 : OMNI ON , POLY

Mode 3 : OMNI OFF, POLY

Mode 2 : OMNI ON , MONO

Mode 4 : OMNI OFF, MONO

o : Yes

x : No

MIDI Data Format / MIDI-Datenformat /



1. EZ-TP functions as a 16-channel multi-timbral tone generator, and incoming data does not affect the selected sound or panel settings. However, the MIDI messages listed below do affect the selected sound and songs.
 - MIDI Master Tuning
 - MIDI Master Volume
2. Exclusive
 - <GM System ON>
F0H, 7EH, 7FH, 09H, 01H, F7H
 - This message automatically restores all default settings for the instrument, with the exception of MIDI Master Tuning.
 - <MIDI Master Volume>
F0H, 7FH, 7FH, 04H, 01H, 11H, mmH, F7H
 - This message simultaneously changes the volume value of all channels (Universal System Exclusive.)
 - The values of mm is used for MIDI Master Volume (Values for 11 are ignored.)
 - <MIDI Master Tuning>
F0H, 43H, 1nH, 27H, 30H, 00H, 00H, mmH, 11H, ccH, F7H
 - This message simultaneously changes the tuning value of all channels.
 - The values of mm and 11 are used for MIDI Master Tuning.
 - The default value of mm and 11 are 08H and 00H, respectively. Any values can be used for cc.
 - <XG System ON>
F0H, 43H, 1nH, 4CH, 00H, 00H, 7EH. 00H, F7H
3. Song data is not transmitted.

1. EZ-TP funktioniert als multi-timbraler 16-Kanal-Klangerzeuger, und eingehende Daten haben keinen Einfluss auf den ausgewählten Sound oder die Bedienfeld-Einstellungen. Die im folgenden aufgeführten MIDI-Befehle verändern jedoch den ausgewählten Sound, die automatische Begleitung und die Songs.
 - MIDI Master Tuning
 - MIDI Master Volume
2. Exclusive
 - <GM System ON>
F0H, 7EH, 7FH, 09H, 01H, F7H
 - Durch diese Meldung werden automatisch alle Werksvorgaben des Instruments, mit Ausnahme des „MIDI Master Tuning“ (der Gesamtstimmung), wieder hergestellt.
 - <MIDI Master Volume> (MIDI-Gesamtlautstärke)
F0H, 7FH, 7FH, 04H, 01H, 11H, mmH, F7H
 - Mit diesem Befehl kann die Lautstärke aller Kanäle gleichzeitig geändert werden (Universal System Exclusive).
 - Die Werte für „mm“ werden für MIDI Master Volume verwendet. (Werte für „11“ werden ignoriert.)
 - <MIDI Master Tuning>
F0H, 43H, 1nH, 27H, 30H, 00H, 00H, mmH, 11H, ccH, F7H
 - Durch diesen Befehl wird die Stimmung für alle Kanäle gleichzeitig geändert.
 - Die Werte von „mm“ und „11“ werden für das MIDI Master Tuning verwendet.
 - Der Standardwert beträgt für „mm“ 08H und für „11“ 00H. Für „cc“ können beliebige Werte verwendet werden.
 - <XG System ON>
F0H, 43H, 1nH, 4CH, 00H, 00H, 7EH. 00H, F7H
3. Es werden keine Songdaten gesendet.

Format des données MIDI / Formato de datos MIDI

1. L'EZ-TP fonctionne comme un générateur de sons multi-timbre à 16 canaux. De ce fait, la réception de données n'affecte ni le son sélectionné, ni les réglages de panneau. Cependant, les messages MIDI répertoriés ci-dessous affectent le son sélectionné et les morceaux.

- MIDI Master Tuning (Accord général MIDI)
- MIDI Master Volume

2. Exclusifs

<GM System ON>

F0H, 7EH, 7FH, 09H, 01H, F7H

- Ce message rétablit automatiquement tous les réglages par défaut de l'instrument, à l'exception de la commande MIDI Master Tuning.

<MIDI Master Volume> (Volume principal MIDI)

F0H, 7FH, 7FH, 04H, 01H, 11H, mmH, F7H

- Ce message autorise la modification simultanée du volume de tous les canaux (Universal System Exclusive).
- Les valeurs « mm » sont utilisées pour MIDI Master Volume. (Les valeurs « ll » sont ignorées.)

<MIDI Master Tuning>

F0H, 43H, 1nH, 27H, 30H, 00H, 00H, mmH, 11H, ccH, F7H

- Ce message modifie simultanément la valeur de l'accordage de tous les canaux.
- Les valeurs « mm » et « ll » sont utilisées pour MIDI Master Tuning.
- Les valeurs par défaut de « mm » et « ll » sont 08H et 00H, respectivement. N'importe quelle valeur peut être utilisée pour « cc ».

<XG System ON>

F0H, 43H, 1nH, 4CH, 00H, 00H, 7EH, 00H, F7H

3. Les données du morceau ne sont pas transmises.

1. El EZ-TP funciona como un generador de tonos de varios timbres de 16 canales y los datos de entrada no afectan al sonido seleccionado ni a los ajustes del panel. Sin embargo, los mensajes MIDI enumerados a continuación sí afectan al sonido seleccionado y a las canciones.

- MIDI Master Tuning (Afinación principal MIDI)
- MIDI Master Volume

2. Exclusivo

<GM System ON> (Sistema GM activado)

F0H, 7EH, 7FH, 09H, 01H, F7H

- Este mensaje restituye automáticamente todos los ajustes iniciales del instrumento, a excepción de la afinación principal MIDI.

<MIDI Master Volume> (Volumen principal MIDI)

F0H, 7FH, 7FH, 04H, 01H, 11H, mmH, F7H

- Este mensaje permite cambiar simultáneamente el volumen de todos los canales [Universal System Exclusive] (Exclusivo del Sistema Universal).
- Los valores de “mm” se usan para la volumen principal MIDI. (Los valores para “ll” se omiten).

<MIDI Master Tuning> (Afinación principal MIDI)

F0H, 43H, 1nH, 27H, 30H, 00H, 00H, mmH, 11H, ccH, F7H

- Este mensaje cambia simultáneamente el valor de afinación de todos los canales.
- Los valores de “mm” y “ll” se usan para la afinación principal MIDI.
- Los valores iniciales de “mm” y “ll” son 08H y 00H, respectivamente. Puede usarse cualquier valor para “cc”.

<XG System ON> (Sistema XG activado)

F0H, 43H, 1nH, 4CH, 00H, 00H, 7EH, 00H, F7H

3. Los datos de canciones no se transmiten.

**Playing method:**

Sing / operate valves.

Sounds:

22

Songs:

10 songs (other songs can be loaded into memory from a computer using an optional USB interface, 992 kilobyte memory capacity).

Polyphony:

32

Displays:

LED display, valve LEDs

Controls:

PLAY MODE [1], [2], [3] buttons, [DEMO] button, [SOUND]/[SONG] button, [KEY] button, [SET UP]/[VOL] button, [MIDI]/[TEMPO] button, [FUNCTION] button, VALUE [-], [+] buttons, MASTER VOL, MIC VOL

Play Modes:

Sing, Press the valves indicated by the guide lamps, Sing and use the valves

Base Pitch:

B \flat , C, E \flat , F, Fr1, Fr2

Functions:

Song Transpose, Beat Lamp, Tuning, MIC Vol, Tracking, Song/Performance Vol, Octave, MIDI Local Control on/off, Tempo

Connectors:

PHONES/OUTPUT, MIDI, DC IN 12V

Maximum Output Power:

2.5W

PHONES/OUTPUT:

Output impedance 68 Ω

Speaker:

8 cm X1

Power Supply:

PA-3C AC Power Adaptor
Four 1.5V "AA" size, LR6 or equivalent batteries

Power Consumption:

5.2W

Dimensions (W X D X H):

556 X 125 X 159 mm
(21"-7/8 X 5" X 6"-1/4)

Weight:

0.8 Kg (1 lbs., 12 oz.) (w/o batteries)

Optional Accessories:

USB-MIDI interface: UX16

* Specifications and descriptions in this owner's manual are for information purposes only. Yamaha Corp. reserves the right to change or modify products or specifications at any time without prior notice. Since specifications, equipment or options may not be the same in every locale, please check with your Yamaha dealer.

* Die technischen Daten und Beschreibungen in dieser Bedienungsanleitung dienen nur der Information. Yamaha Corp. behält sich das Recht vor, Produkte oder deren technische Daten jederzeit ohne vorherige Ankündigung zu verändern oder zu modifizieren. Da die technischen Daten, das Gerät selbst oder Sonderzubehör nicht in jedem Land gleich sind, setzen Sie sich im Zweifel bitte mit Ihrem Yamaha-Händler in Verbindung.

* Les caractéristiques techniques et les descriptions du mode d'emploi ne sont données que pour information. Yamaha Corp. se réserve le droit de changer ou modifier les produits et leurs caractéristiques techniques à tout moment sans aucun avis. Du fait que les caractéristiques techniques, les équipements et les options peuvent différer d'un pays à l'autre, adressez-vous au distributeur Yamaha le plus proche.

* Las especificaciones y descripciones de este manual del propietario tienen sólo el propósito de servir como información. Yamaha Corp. se reserva el derecho a efectuar cambios o modificaciones en los productos o especificaciones en cualquier momento sin previo aviso. Puesto que las especificaciones, equipos u opciones pueden no ser las mismas en todos los mercados, solicite información a su distribuidor Yamaha.

Limited Warranty

90 DAYS LABOR

1 YEAR PARTS

Yamaha Corporation of America, hereafter referred to as Yamaha, warrants to the original consumer of a product included in the categories listed below, that the product will be free of defects in materials and/or workmanship for the periods indicated. This warranty is applicable to all models included in the following series of products:

EZ-TP

If during the first 90 days that immediately follows the purchase date, your new Yamaha product covered by this warranty is found to have a defect in material and/or workmanship, Yamaha and/or its authorized representative will repair such defect without charge for parts or labor.

If parts should be required after this 90 day period but within the one year period that immediately follows the purchase date, Yamaha will, subject to the terms of this warranty, supply these parts without charge. However, charges for labor, and/or any miscellaneous expenses incurred are the consumers responsibility. Yamaha reserves the right to utilize reconditioned parts in repairing these products and/or to use reconditioned units as warranty replacements.

THIS WARRANTY IS THE ONLY EXPRESS WARRANTY WHICH YAMAHA MAKES IN CONNECTION WITH THESE PRODUCTS. ANY IMPLIED WARRANTY APPLICABLE TO THE PRODUCT, INCLUDING THE WARRANTY OF MERCHANTABILITY IS LIMITED TO THE DURATION OF THE EXPRESS WARRANTY. YAMAHA EXCLUDES AND SHALL NOT BE LIABLE IN ANY EVENT FOR INCIDENTAL OR CONSEQUENTIAL DAMAGES.

Some states do not allow limitations that relate to implied warranties and/or the exclusion of incidental or consequential damages. Therefore, these limitations and exclusions may not apply to you.

This warranty gives you specific legal rights. You may also have other rights which vary from state to state.

CONSUMERS RESPONSIBILITIES

If warranty service should be required, it is necessary that the consumer assume certain responsibilities:

1. Contact the Customer Service Department of the retailer selling the product, or any retail outlet authorized by Yamaha to sell the product for assistance. You may also contact Yamaha directly at the address provided below.
2. Deliver the unit to be serviced under warranty to: the retailer selling the product, an authorized service center, or to Yamaha with an explanation of the problem. Please be prepared to provide proof purchase date (sales receipt, credit card copy, etc.) when requesting service and/or parts under warranty.
3. Shipping and/or insurance costs are the consumers responsibility.* Units shipped for service should be packed securely.

*Repaired units will be returned PREPAID if warranty service is required within the first 90 days.

IMPORTANT: Do NOT ship anything to ANY location without prior authorization. A Return Authorization (RA) will be issued that has a tracking number assigned that will expedite the servicing of your unit and provide a tracking system if needed.

4. Your owners manual contains important safety and operating instructions. It is your responsibility to be aware of the contents of this manual and to follow all safety precautions.

EXCLUSIONS

This warranty does not apply to units whose trade name, trademark, and/or ID numbers have been altered, defaced, exchanged removed, or to failures and/or damages that may occur as a result of:

1. Neglect, abuse, abnormal strain, modification or exposure to extremes in temperature or humidity.
2. Improper repair or maintenance by any person who is not a service representative of a retail outlet authorized by Yamaha to sell the product, an authorized service center, or an authorized service representative of Yamaha.
3. This warranty is applicable only to units sold by retailers authorized by Yamaha to sell these products in the U.S.A., the District of Columbia, and Puerto Rico. This warranty is not applicable in other possessions or territories of the U.S.A. or in any other country.

Please record the model and serial number of the product you have purchased in the spaces provided below.

Model _____ Serial # _____ Sales Slip # _____

Purchased from _____ Date _____
(Retailer)

YAMAHA CORPORATION OF AMERICA
Electronic Service Division
6600 Orangethorpe Avenue
Buena Park, CA 90620

KEEP THIS DOCUMENT FOR YOUR RECORDS. DO NOT MAIL!

SPECIAL MESSAGE SECTION

This product utilizes batteries or an external power supply (adapter). DO NOT connect this product to any power supply or adapter other than one described in the manual, on the name plate, or specifically recommended by Yamaha.

This product should be used only with the components supplied or: a cart, rack, or stand that is recommended by Yamaha. If a cart, etc., is used, please observe all safety markings and instructions that accompany the accessory product.

SPECIFICATIONS SUBJECT TO CHANGE:

The information contained in this manual is believed to be correct at the time of printing. However, Yamaha reserves the right to change or modify any of the specifications without notice or obligation to update existing units.

This product, either alone or in combination with an amplifier and headphones or speaker/s, may be capable of producing sound levels that could cause permanent hearing loss. DO NOT operate for long periods of time at a high volume level or at a level that is uncomfortable. If you experience any hearing loss or ringing in the ears, you should consult an audiologist. **IMPORTANT:** The louder the sound, the shorter the time period before damage occurs.

NOTICE:

Service charges incurred due to a lack of knowledge relating to how a function or effect works (when the unit is operating as designed) are not covered by the manufacturer's warranty, and are therefore the owners responsibility. Please study this manual carefully and consult your dealer before requesting service.

ENVIRONMENTAL ISSUES:

Yamaha strives to produce products that are both user safe and environmentally friendly. We sincerely believe that our products and the production methods used to produce them, meet these goals. In keeping with both the letter and the spirit of the law, we want you to be aware of the following:

Battery Notice:

This product MAY contain a small non-rechargeable battery which (if applicable) is soldered in place. The average life span of this type of battery is approximately five years. When replacement becomes necessary, contact a qualified service representative to perform the replacement.

This product may also use "household" type batteries. Some of these may be rechargeable. Make sure that the battery being charged is a rechargeable type and that the charger is intended for the battery being charged.

When installing batteries, do not mix batteries with new, or with batteries of a different type. Batteries MUST be installed correctly. Mismatches or incorrect installation may result in overheating and battery case rupture.

Warning:

Do not attempt to disassemble, or incinerate any battery. Keep all batteries away from children. Dispose of used batteries promptly and as regulated by the laws in your area. Note: Check with any retailer of household type batteries in your area for battery disposal information.

Disposal Notice:

Should this product become damaged beyond repair, or for some reason its useful life is considered to be at an end, please observe all local, state, and federal regulations that relate to the disposal of products that contain lead, batteries, plastics, etc. If your dealer is unable to assist you, please contact Yamaha directly.

NAME PLATE LOCATION:

The name plate is located on the panel of the product. The model number, serial number, power requirements, etc., are located on this plate. You should record the model number, serial number, and the date of purchase in the spaces provided below and retain this manual as a permanent record of your purchase.

Model _____

Serial No. _____

Purchase Date _____

PLEASE KEEP THIS MANUAL

92-BP (others)

FCC INFORMATION (U.S.A.)

1. IMPORTANT NOTICE: DO NOT MODIFY THIS UNIT!

This product, when installed as indicated in the instructions contained in this manual, meets FCC requirements. Modifications not expressly approved by Yamaha may void your authority, granted by the FCC, to use the product.

2. IMPORTANT: When connecting this product to accessories and/or another product use only high quality shielded cables. Cable/s supplied with this product MUST be used. Follow all installation instructions. Failure to follow instructions could void your FCC authorization to use this product in the USA.

3. NOTE: This product has been tested and found to comply with the requirements listed in FCC Regulations, Part 15 for Class "B" digital devices. Compliance with these requirements provides a reasonable level of assurance that your use of this product in a residential environment will not result in harmful interference with other electronic devices. This equipment generates/uses radio frequencies and, if not installed and used according to the instructions found in the users manual, may cause interference harmful to the operation of other electronic devices. Compliance with FCC regulations does not guarantee that interference

will not occur in all installations. If this product is found to be the source of interference, which can be determined by turning the unit "OFF" and "ON", please try to eliminate the problem by using one of the following measures:

Relocate either this product or the device that is being affected by the interference.

Utilize power outlets that are on different branch (circuit breaker or fuse) circuits or install AC line filter/s.

In the case of radio or TV interference, relocate/reorient the antenna. If the antenna lead-in is 300 ohm ribbon lead, change the lead-in to coaxial type cable.

If these corrective measures do not produce satisfactory results, please contact the local retailer authorized to distribute this type of product. If you can not locate the appropriate retailer, please contact Yamaha Corporation of America, Electronic Service Division, 6600 Orangethorpe Ave, Buena Park, CA90620

The above statements apply ONLY to those products distributed by Yamaha Corporation of America or its subsidiaries.

* This applies only to products distributed by YAMAHA CORPORATION OF AMERICA.

(class B)

OBSERVERA!

Apparaten kopplas inte ur växelströmskällan (nätet) så länge som den är ansluten till vägguttaget, även om själva apparaten har stängts av.

ADVARSSEL: Netspændingen til dette apparat er IKKE afbrudt, så længe netledningen sidder i en stikkontakt, som er t endt — også selvom der er slukket på apparatets afbryder.

VAROITUS: Laitteen toisiopiiriin kytketty käyttökytkin ei irrota koko laitetta verkosta.

(standby)

Entsorgung leerer Batterien (nur innerhalb Deutschlands)

Leisten Sie einen Beitrag zum Umweltschutz. Verbrauchte Batterien oder Akkumulatoren dürfen nicht in den Hausmüll. Sie können bei einer Sammelstelle für Altbatterien bzw. Sondermüll abgegeben werden. Informieren Sie sich bei Ihrer Kommune.

(battery)

For details of products, please contact your nearest Yamaha representative or the authorized distributor listed below.

Pour plus de détails sur les produits, veuillez-vous adresser à Yamaha ou au distributeur le plus proche de vous figurant dans la liste suivante.

Die Einzelheiten zu Produkten sind bei Ihrer unten aufgeführten Niederlassung und bei Yamaha Vertragshändlern in den jeweiligen Bestimmungsländern erhältlich.

Para detalles sobre productos, contacte su tienda Yamaha más cercana o el distribuidor autorizado que se lista debajo.

NORTH AMERICA

CANADA

Yamaha Canada Music Ltd.
135 Milner Avenue, Scarborough, Ontario,
M1S 3R1, Canada
Tel: 416-298-1311

U.S.A.

Yamaha Corporation of America
6600 Orangethorpe Ave., Buena Park, Calif. 90620,
U.S.A.
Tel: 714-522-9011

CENTRAL & SOUTH AMERICA

MEXICO

Yamaha de México S.A. de C.V.
Calz. Javier Rojo Gómez #1149,
Col. Guadalupe del Moral
C.P. 09300, México, D.F., México
Tel: 55-5804-0600

BRAZIL

Yamaha Musical do Brasil Ltda.
Av. Rebouças 2636-Pinheiros CEP: 05402-400
Sao Paulo-SP, Brasil
Tel: 011-3085-1377

ARGENTINA

Yamaha Music Latin America, S.A.
Sucursal de Argentina
Viamonte 1145 Piso-2-B 1053,
Buenos Aires, Argentina
Tel: 1-4371-7021

PANAMA AND OTHER LATIN

AMERICAN COUNTRIES/ CARIBBEAN COUNTRIES

Yamaha Music Latin America, S.A.
Torre Banco General, Piso 7, Urbanización Marbella,
Calle 47 y Aquilino de la Guardia,
Ciudad de Panamá, Panamá
Tel: +507-269-5311

EUROPE

THE UNITED KINGDOM

Yamaha-Kemble Music (U.K.) Ltd.
Sherbourne Drive, Tilbrook, Milton Keynes,
MK7 8BL, England
Tel: 01908-366700

IRELAND

Danfay Ltd.
61D, Sallynoggin Road, Dun Laoghaire, Co. Dublin
Tel: 01-2859177

GERMANY

Yamaha Music Central Europe GmbH
Siemensstraße 22-34, 25462 Rellingen, Germany
Tel: 04101-3030

SWITZERLAND/LIECHTENSTEIN

**Yamaha Music Central Europe GmbH,
Branch Switzerland**
Seefeldstrasse 94, 8008 Zürich, Switzerland
Tel: 01-383 3990

AUSTRIA

**Yamaha Music Central Europe GmbH,
Branch Austria**
Schleiergasse 20, A-1100 Wien, Austria
Tel: 01-60203900

THE NETHERLANDS

**Yamaha Music Central Europe,
Branch Nederland**
Clarissenhof 5-b, 4133 AB Vianen, The Netherlands
Tel: 0347-358 040

BELGIUM/LUXEMBOURG

**Yamaha Music Central Europe GmbH,
Branch Belgium**
Rue de Geneve (Genevestraat) 10, 1140 - Brussels,
Belgium
Tel: 02-726 6032

FRANCE

Yamaha Musique France
BP 70-77312 Marne-la-Vallée Cedex 2, France
Tel: 01-64-61-4000

ITALY

Yamaha Musica Italia S.P.A.
Viale Italia 88, 20020 Lainate (Milano), Italy
Tel: 02-935-771

SPAIN/PORTUGAL

Yamaha-Hazen Música, S.A.
Ctra. de la Coruna km. 17, 200, 28230
Las Rozas (Madrid), Spain
Tel: 91-639-8888

GREECE

Philippou Nakas S.A. The Music House
147 Skiathou Street, 112-55 Athens, Greece
Tel: 01-228 2160

SWEDEN

Yamaha Scandinavia AB
J. A. Wettergrens Gata 1
Box 30053
S-400 43 Göteborg, Sweden
Tel: 031 89 34 00

DENMARK

YS Copenhagen Liaison Office
Generatorvej 6A
DK-2730 Herlev, Denmark
Tel: 44 92 49 00

FINLAND

F-Musikkii Oy
Kluuvikatu 6, P.O. Box 260,
SF-00101 Helsinki, Finland
Tel: 09 618511

NORWAY

Norsk filial av Yamaha Scandinavia AB
Grini Næringspark 1
N-1345 Østerås, Norway
Tel: 67 16 77 70

ICELAND

Skifan HF
Skeifan 17 P.O. Box 8120
IS-128 Reykjavik, Iceland
Tel: 525 5000

OTHER EUROPEAN COUNTRIES

Yamaha Music Central Europe GmbH
Siemensstraße 22-34, 25462 Rellingen, Germany
Tel: +49-4101-3030

AFRICA

**Yamaha Corporation,
Asia-Pacific Music Marketing Group**
Nakazawa-cho 10-1, Hamamatsu, Japan 430-8650
Tel: +81-53-460-2312

MIDDLE EAST

TURKEY/CYPRUS

Yamaha Music Central Europe GmbH
Siemensstraße 22-34, 25462 Rellingen, Germany
Tel: 04101-3030

OTHER COUNTRIES

Yamaha Music Gulf FZE
LB21-128 Jebel Ali Freezone
P.O.Box 17328, Dubai, U.A.E.
Tel: +971-4-881-5868

ASIA

THE PEOPLE'S REPUBLIC OF CHINA

Yamaha Music & Electronics (China) Co.,Ltd.
25/F., United Plaza, 1468 Nanjing Road (West),
Jingan, Shanghai, China
Tel: 021-6247-2211

HONG KONG

Tom Lee Music Co., Ltd.
11/F., Silvercord Tower 1, 30 Canton Road,
Tsimshatsui, Kowloon, Hong Kong
Tel: 2737-7688

INDONESIA

PT. Yamaha Music Indonesia (Distributor)
PT. Nusantik
Gedung Yamaha Music Center, Jalan Jend. Gatot
Subroto Kav. 4, Jakarta 12930, Indonesia
Tel: 21-520-2577

KOREA

Yamaha Music Korea Ltd.
Tong-Yang Securities Bldg. 16F 23-8 Yoido-dong,
Youngdungpo-ku, Seoul, Korea
Tel: 02-3770-0660

MALAYSIA

Yamaha Music Malaysia, Sdn., Bhd.
Lot 8, Jalan Perbandaran, 47301 Kelana Jaya,
Petaling Jaya, Selangor, Malaysia
Tel: 3-7803090

PHILIPPINES

Yupangco Music Corporation
339 Gil J. Puyat Avenue, P.O. Box 885 MCPO,
Makati, Metro Manila, Philippines
Tel: 819-7551

SINGAPORE

Yamaha Music Asia Pte., Ltd.
#03-11 A-Z Building
140 Paya Lebar Road, Singapore 409015
Tel: 747-3474

TAIWAN

Yamaha KHS Music Co., Ltd.
3F, #6, Sec.2, Nan Jing E. Rd. Taipei,
Taiwan 104, R.O.C.
Tel: 02-2511-8688

THAILAND

Siam Music Yamaha Co., Ltd.
891/1 Siam Motors Building, 15-16 floor
Rama 1 road, Wangmai, Pathumwan
Bangkok 10330, Thailand
Tel: 02-215-2626

OTHER ASIAN COUNTRIES

**Yamaha Corporation,
Asia-Pacific Music Marketing Group**
Nakazawa-cho 10-1, Hamamatsu, Japan 430-8650
Tel: +81-53-460-2317

OCEANIA

AUSTRALIA

Yamaha Music Australia Pty. Ltd.
Level 1, 99 Queensbridge Street, Southbank,
Victoria 3006, Australia
Tel: 3-9693-5111

NEW ZEALAND

Music Houses of N.Z. Ltd.
146/148 Captain Springs Road, Te Papapa,
Auckland, New Zealand
Tel: 9-634-0099

COUNTRIES AND TRUST

TERRITORIES IN PACIFIC OCEAN

**Yamaha Corporation,
Asia-Pacific Music Marketing Group**
Nakazawa-cho 10-1, Hamamatsu, Japan 430-8650
Tel: +81-53-460-2312

HEAD OFFICE Yamaha Corporation, Pro Audio & Digital Musical Instrument Division
Nakazawa-cho 10-1, Hamamatsu, Japan 430-8650
Tel: +81-53-460-3273



Yamaha PK CLUB (Portable Keyboard Home Page, English Only)
<http://www.yamahaPKclub.com/>

Yamaha Manual Library
<http://www2.yamaha.co.jp/manual/english/>

U.R.G., Pro Audio & Digital Musical Instrument Division, Yamaha Corporation
© 2004 Yamaha Corporation

A0

??PO???.?-01

WD41120 | Printed in Malaysia