

D I S K   R E C O R D E R

# EMQ-1

USER'S GUIDE

BEDIENUNGSANLEITUNG

MANUEL DE L'UTILISATEUR

MANUAL DE INSTRUCCIONES

Thank you for purchasing a Yamaha Disk Recorder EMQ-1.

The Disk Recorder EMQ-1 is a totally new type of performance recording device, utilizing the very latest in Yamaha's exclusive digital technology. Capable of recording and playback of MIDI-compatible SINGLE KEYBOARD instruments, this EMQ-1 lets you save the recorded data onto a 2.8" Quick Disk.

#### Main Features of EMQ-1

- Realtime recording of performances
- Changing the playback speed
- Overdubbing
- Bulk Data Dump

This User's Guide has been designed to help you make proper use of the outstanding features of the EMQ-1. Be sure to read it carefully before using your EMQ-1.

## Contents

	Page		Page
1 The Power Supply .....	1	6 Saving/Loading Data .....	9
2 Description of Parts.....	2	7 MIDI Control .....	10
3 EMQ-1 Quick Reference.....	3	■ Error Messages and Specifications .....	12
4 Recording .....	5	■ Possible Operating Errors .....	13
5 Playback .....	7		

## Before Playing

To be sure you are using your EMQ-1 under optimum conditions, pay attention to the following precautions.



### ••• Choosing a Place for Your EMQ-1

Your EMQ-1 will be damaged if used in any of the places below, so be sure to avoid doing so:

- Places exposed to direct sunlight, such as near a window, or extremely hot places near a source of heat.
- Places of particularly low temperatures.
- Places exposed to excessive humidity or dust.
- Places exposed to vibrations.
- Make sure to install EMQ-1 on a level surface, and never use it in a tilted status (it may result in disk errors).



### ••• Never Apply Unnecessary Force

Strong impact or unnecessary force will damage the unit, so take care never to drop the unit nor place heavy objects on top of it.



### ••• The Power Supply

After you are finished using the unit, always turn OFF its POWER switch and disconnect the power adaptor.



### ••• Cleaning the Outer Case

If the unit requires cleaning, wipe it off with a soft, dry cloth. Never use thinners, benzines, or other similar solvents; their use will damage the outer case of the unit.



### ••• Connection with Other Devices

Before connecting the unit with another device such as a SINGLE KEYBOARD instrument, make sure to turn OFF the POWER switches of both devices.



### ••• The Protective Card

This unit comes with a protective card inserted in its disk insertion slot to protect the unit's interior. Before using the unit, remove the protective card.

If you do not plan to use the unit for an extended period or wish to transport it, be sure to re-insert the protective card.

**CAUTION:** Do not place the power adaptor on top of EMQ-1.

# 1 The Power Supply

The EMQ-1 is designed to use a separately available Yamaha Power Adaptor as its power supply. Be sure to read the following precautions carefully to ensure proper connection of the power supply.

## Using EMQ-1 alone

Always use the Yamaha Power Adaptor PA-4 (in the U.S., PA-40) or PA-5. The use of another adaptor will damage the EMQ-1 and is thus extremely dangerous.

## Using EMQ-1 concurrently with another EM-Series unit

When using EMQ-1 together with another EM-Series unit (such as an AWM Sound Expander EMT-10), always use the Yamaha Power Adaptor PA-5. If the total maximum current of both EM-Series units is within the range of the adaptor's rated power (2 A), the units can be supplied with power by one PA-5.

Perform connection as shown on the right. Use the DC cord provided to connect the DC OUT jack of one unit to the DC IN jack of the other unit.

(Rear Panel)

(Other EM-Series unit)

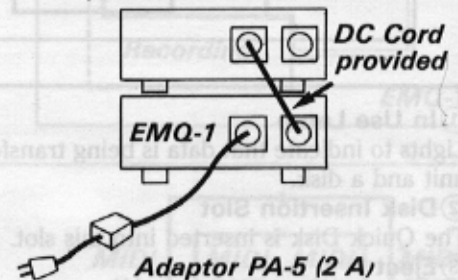

## Concurrent use of 3 or more units

One PA-5 can be used to supply power to three EM-Series units, depending on the types of units involved. (Power cannot be supplied if the combination results in a total maximum current that exceeds the 2 A rated current of PA-5.) If you wish to use a single PA-5 adaptor, make sure to choose a combination of units for which the total maximum current does not exceed 2 A (2000 mA).

### [Combination Example 1]

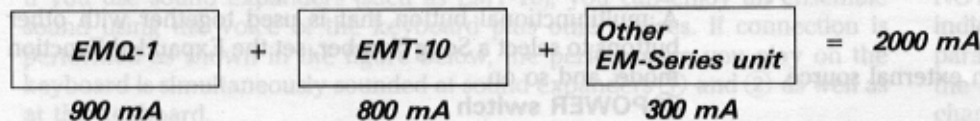

In the above case, 2 A (2000 mA) is not exceeded so three units can be used with a single PA-5.

### [Combination Example 2]

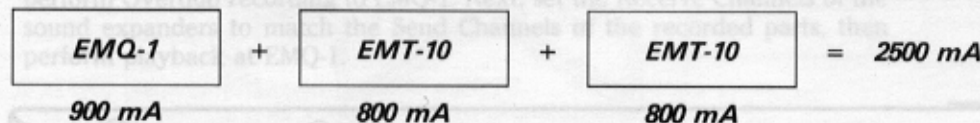

In this case, 2A (2000 mA) is exceeded, so you will need to use two adaptors.

**NOTE:** DC OUT→DC IN jack connections should be made only between EM-series Expander Modules. Do not use an EM-series DC OUT jack to power other equipment.

## Installing the Holders and Mounting Plates

- The EMQ-1 comes supplied with two holders and two mounting plates. If you will be placing the EMQ-1 on top of a Clavinova or other keyboard with top-mounted speakers, the holders and mounting plates raise the EMQ-1 to prevent obstruction of the speaker. Attach one of the mounting plates to the five grooves on one of the holders. Then attach the mounting plate to the grooves on one side of the EMQ-1. For added stability, secure the bottom panel of EMQ-1 to the holder by inserting the three screws provided through the holes in the holder and tightening them. There is no corresponding hole in the bottom panel for one of the holder's four holes. Because a screw cannot be inserted in that hole, mount the EMQ-1 by inserting screws into only three holes and leave the fourth hole open.
- To mount an EM-series device on top of another, use only the mounting plates to connect the grooves of the upper and lower units.

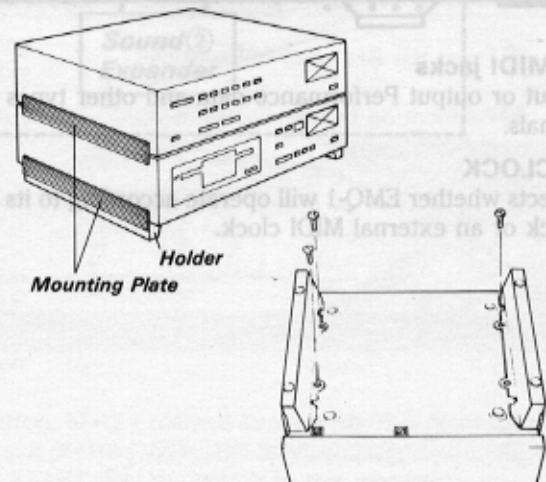

## 2 Description of Parts

### ■ Front Panel

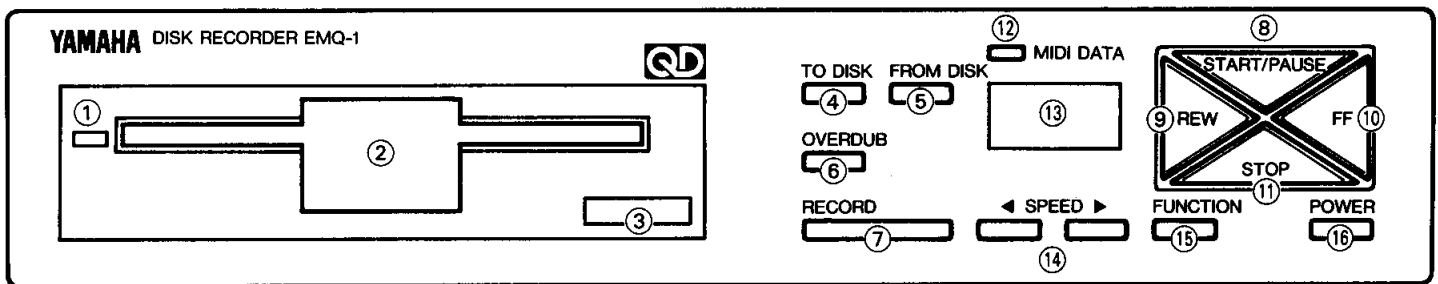

#### ① In Use Lamp

Lights to indicate that data is being transferred between the unit and a disk.

#### ② Disk Insertion Slot

The Quick Disk is inserted into this slot.

#### ③ Eject

Press this button to eject the disk.

#### ④ TO DISK

Press this button to transfer data from the unit to a disk.

#### ⑤ FROM DISK

Press this button to recall data from a disk to the unit.

#### ⑥ OVERDUB

Press this button to dub new data onto the data already recorded at the unit.

#### ⑦ RECORD

Press this button to record data from an external source.

#### ⑧ START/PAUSE

Press this button to start recording or playback, or to temporarily stop playback.

#### ⑨ REW

During Play or Pause mode, press this button to return quickly through previous data.

#### ⑩ FF

During Play or Pause mode, press this button to advance quickly through the data.

#### ⑪ STOP

Press this button to stop recording or playback.

#### ⑫ MIDI DATA Lamp

Lights when MIDI signals have been received.

#### ⑬ Display

Shows the Song Number, amount of vacant memory, Playback Position, and so on.

#### ⑭ SPEED

Control the playback speed.

#### ⑮ FUNCTION

A multifunctional button that is used together with other buttons to select a Song Number, set the Expanded Function mode, and so on.

#### ⑯ POWER switch

Turns the power to ON or OFF.

### ■ Rear Panel

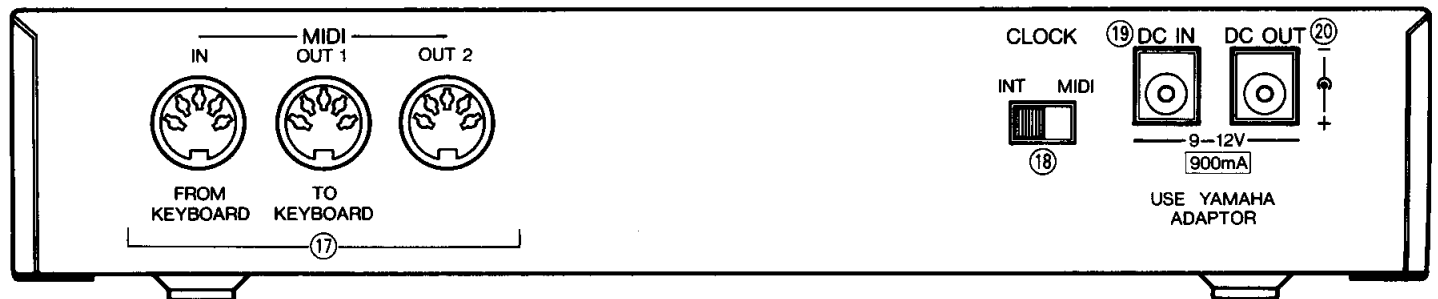

#### ⑰ MIDI jacks

Input or output Performance data and other types of MIDI signals.

#### ⑱ CLOCK

Selects whether EMQ-1 will operate according to its internal clock or an external MIDI clock.

#### ⑲ DC IN jack

Connect the power adaptor (PA-4/PA-40/PA-5) to this jack.

#### ⑳ DC OUT jack

Supplies power to another device.

# 3 EMQ-1 Quick Reference

## ■ The MIDI Jacks

EMQ-1 is provided with three MIDI jacks.

- ① **MIDI IN** : Inputs the MIDI signals from a keyboard.  
(FROM KEYBOARD)
- ② **MIDI OUT 1**: Outputs the MIDI signals recorded at EMQ-1.  
(TO KEYBOARD)
- ③ **MIDI OUT 2**: Simultaneously outputs the recorded data and the MIDI signals that were input to MIDI IN to a peripheral device (such as a Sound Expander).

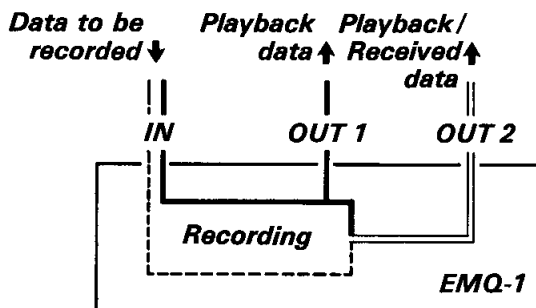

## ■ Sample Connection with a Keyboard

Basically, any SINGLE KEYBOARD provided with MIDI jacks can be connected.

For details, carefully read the description on keyboards to confirm which data can be transmitted and received.

- You can record a keyboard performance, then play back that performance while playing along on the keyboard.

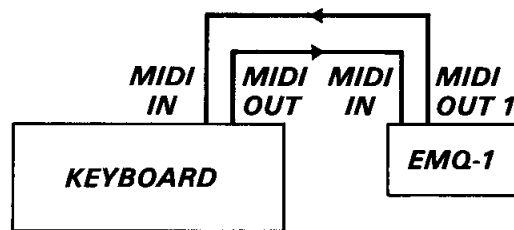

## ■ Using a Sound Expander, Etc.

If you use sound expanders (such as EMT-10), you can enjoy an ensemble sound using the voice of the keyboard plus other voices. If connection is performed as shown in the figure below, the performance you play on the keyboard is simultaneously sounded at sound expanders ① and ② as well as at the keyboard.

With this connection, you can also use the Overdub function of EMQ-1 to sound separate parts from individual sound expanders. First, set the Send Channel of the keyboard to a different Channel Number for each part, then perform Overdub recording to EMQ-1. Next, set the Receive Channels of the sound expanders to match the Send Channels of the recorded parts, then perform playback at EMQ-1.

**NOTE:** For the connections within the box indicated by a broken line, you can use a parallel box as shown on the right to connect the units so that the data is grouped by channel.

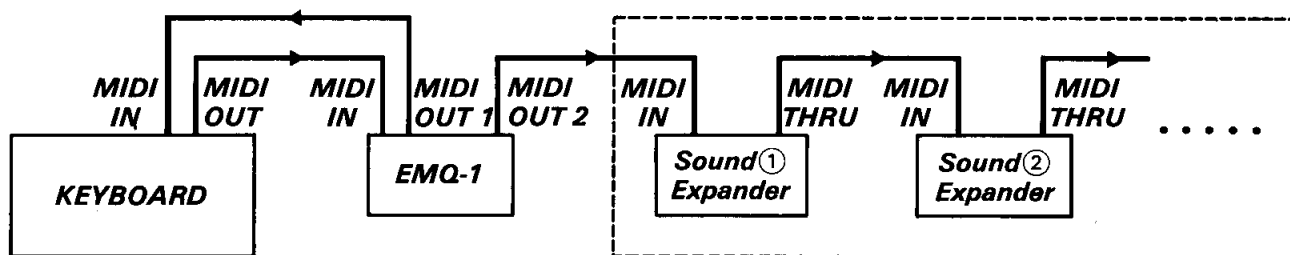
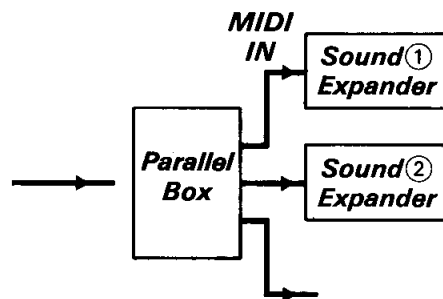

## Now, Let's Record a Performance to EMQ-1

### STEP 1 Getting Ready to Perform

- 1 First, use the two MIDI cables to perform connection according to the "Sample Connection with a Keyboard" on the previous page.
- 2 Connect the power adaptor (PA-4/PA-40/PA-5) to DC IN of EMQ-1.
- 3 Next, turn ON the POWER switch of the keyboard and EMQ-1.
- 4 Set the keyboard to the status in which it can produce sounds.

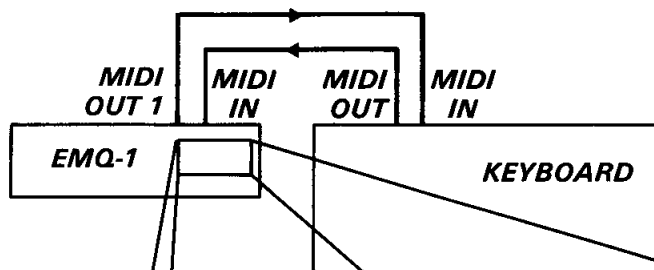

Power Adaptor  
(PA-4/PA-40/PA-5)

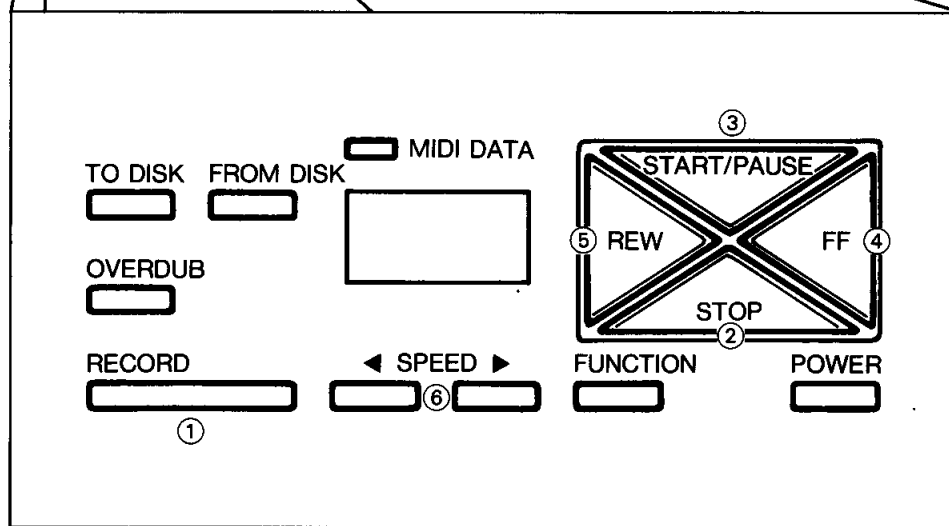
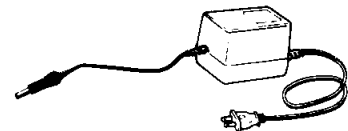

### STEP 2 Recording

- 1 Press the RECORD button ①.
- 2 Perform on the keyboard. Recording is started automatically.
- 3 Press the STOP button ② to stop the recording.

### STEP 3 Playback

- 1 Press the START button ③ to start the playback.
- 2 Try pressing the FF button ④.
- 3 Next, try pressing the REW button ⑤.
- 4 Try pressing the SPEED buttons ⑥ to speed up or slow down the playback.

# 4 Recording

- Up to nine songs can be internally recorded to EMQ-1 (the data of approximately 6000 notes). Each song is referred to by a "Song Number" which can be specified for recording or playback.
- If you record onto a previously recorded Song, the new data will replace the former data. If you wish to dub new data onto previously recorded data, use the Overdub function.
- EMQ-1 receives the MIDI signals of all Channels from 1 to 16 (in OMNI ON/POLY mode). And it directly sends the received MIDI signals without change.

## How to Record

### ① Press the START/PAUSE button while holding down the FUNCTION button to select a Song Number.

Each operation increments the Song Number by one. You can also decrease the Song Number by pressing the STOP button while holding down the FUNCTION button.

#### [Sample Display]



Specify the starting position for recording in this manner.

- When the POWER switch is turned ON, Song Number 1 is automatically specified.
- The "-" in the [n - ] display indicates that Song Number n was previously recorded. The "--" in the [n -- ] display indicates that the previously recorded Song also contains Overdub data and can be used in a Merge operation as described on the next page.
- To prevent the loss of your previously recorded data, be sure to select a Song Number that does not appear as [n - ] or [n -- ].

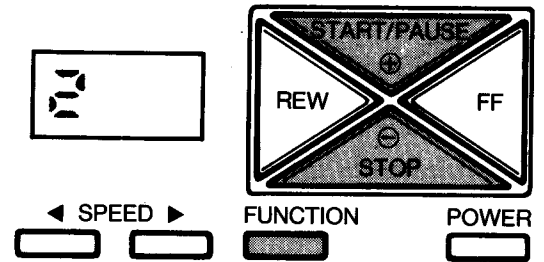

### ② Press the RECORD button.

When the RECORD button is pressed, the unit enters Record Standby mode, and the display alternately shows [r E C ] and [r x x ]. [r x x ] indicates the percentage of the EMQ-1 internal memory which is vacant. (xx = percentage)

- At this time, you can also receive the panel settings of the keyboard.
- The bulk data of a PortaTone or similar instrument can also be received and recorded. The display at this time shows [r ]. For details on performing a Bulk Data Dump operation, refer to the User's Guide for the keyboard you are using.
- If the STOP button is pressed in Record Standby mode, the Standby mode is cancelled. In case you unintentionally select a previously recorded Song Number, you can use the STOP button to prevent that data from being overwritten.

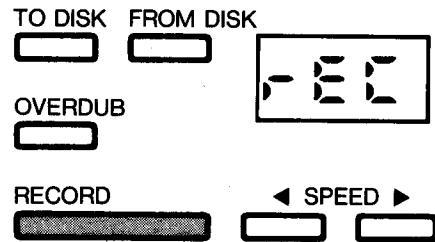

### ③ Start recording by playing the keyboard or pressing the START/PAUSE button.

When you play the keyboard or press the START/PAUSE button, recording is started, the flashing [r E C ] remains lit, then changes to display the percentage of the EMQ-1 internal memory that is vacant.

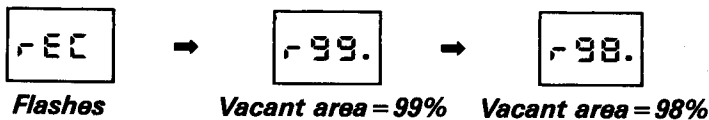

Lights when a MIDI signal is received

MIDI DATA

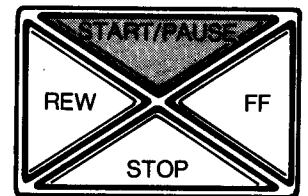
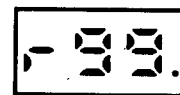

- Even after unintentionally pressing the START/PAUSE button, if you press the STOP button without recording any data, you can prevent the previously recorded data from being erased.
- The "." appearing in the [r 99.] display flashes in quarter-note units according to the tempo set by the SPEED buttons.
- Once recording is started, the first time you press the START/PAUSE button, EMQ-1 records its own Rhythm Start data and simultaneously outputs it from MIDI OUT. When the START/PAUSE button is pressed again, the Rhythm Stop data is recorded and output. The Rhythm Start/Stop data is alternately output using the START/PAUSE button in this manner.

**1 Press the STOP button to stop recording.**

When the STOP button is pressed, recording is stopped and the display shows [ n - ] to indicate that recording has been performed for the specified Song Number.

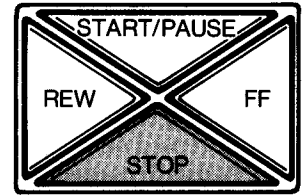

- If you press the Rhythm STOP button at the keyboard panel before pressing the EMQ-1 STOP button, that Rhythm STOP data is recorded. When external MIDI Clock is selected, this operation can also be used to stop recording.

**How to Overdub**

**1 Select a Song Number.**

Select a previously recorded Song Number [ n - ].

- If you wish to sound the dubbed parts from separate sound expanders, change the Send Channels of the keyboard accordingly before overdubbing the parts.

**2 Press the OVERDUB button.**

When the OVERDUB button is pressed, the display alternately shows [ d U b ] and [ d x x ]. [ d x x ] indicates the percentage of the memory that is vacant. (xx = percentage)

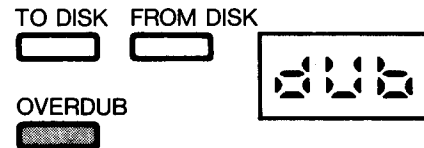

**3 Start overdubbing by playing the keyboard or pressing the START/PAUSE button.**

The previously recorded data is played back (because the recorded data is sent from MIDI OUT 1 to the keyboard), and the data of your current performance is recorded.

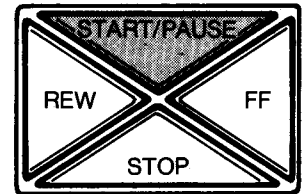
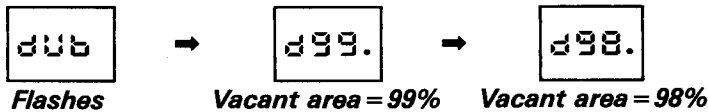

**4 Press the STOP button to stop the overdubbing.**

**MERGE**

When Overdub is completed, the previously recorded data and the recently recorded data are recorded onto separate tracks. If you wish to perform further overdubbing for these data, you must combine these two data onto one track and leave the other track empty. This is called a "Merge" operation."

**[Merge Operation]**

Press OVERDUB while holding down FUNCTION.

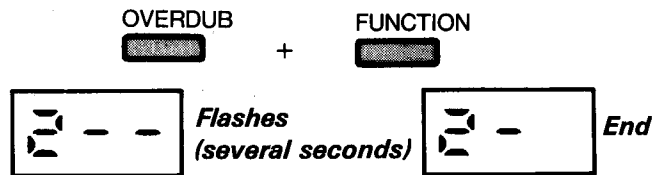

- As shown on the right, perform a multi-part recording by repeating the Overdub and Merge operations.
- When the amount of vacant memory drops to 6% or less, you will be unable to perform further Merge operations.

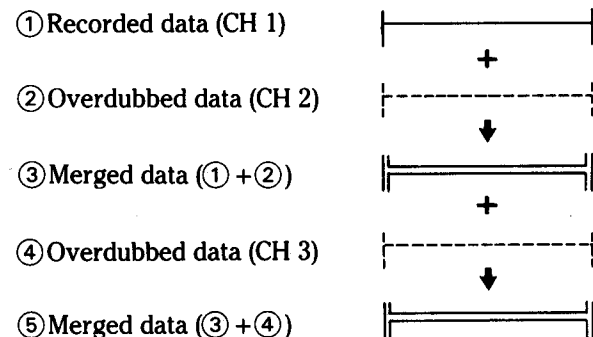



# 5 Playback

- During the playback of a recorded song, the display shows the current position within that song and shows [ P 9 9 ] at the end of the song.

## How to Play Back

### 1 Select a Song Number.

Select a Song Number using the same procedure for recording. The display will show the recorded Song Number as [ n - ] or [ n - - ].

### 2 If necessary, specify the Playback Start position.

- When the FF button is pressed, you are advanced quickly through the data of one song, and the fast forward speed quickens about one second after you begin to press the FF button. The display shows the current position as a percentage, and the fast forward operation stops at [ P 9 9 ].

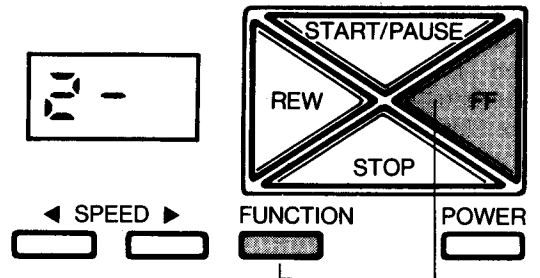

*Fast forward operation in 20% increments*

- If you press FF button while holding down FUNCTION, you can advance in increment of 20%.
- When the REW button is pressed, the Song position is moved back quickly through the data of one song, and the reverse speed quickens about one second after you begin to press the REW button. The display shows the current position as a percentage, and the reverse operation stops at [ P 0 0 ]. The REW button cannot operate from the [ n - ] status.
- When you press the REW and START buttons simultaneously, EMQ-1 enters Play Standby mode. You can start playback from this mode by receiving a MIDI signal (Note Number, etc.). In Play Standby mode, the display flashes [ P L y ] and you can perform any operations possible in Stop mode.

### 3 Press the START/PAUSE button. (In Play Standby mode, playback can also be started by playing the keys of the keyboard.)

Playback is started from the specified position, and the display shows the position currently being played back.

- While sending an Exclusive Message, such as bulk data, the display shows [ P L y ] in a continuously lit status.
- During playback, you can also perform the fast forward and reverse operations.  
[Procedure]
- While the FF button is being pressed, the data is fast forwarded while being played back. When you release the button, normal playback is resumed from that position.
- While the REW button is being pressed, you are quickly moved back through the data. When the button is released, playback is resumed from that position.

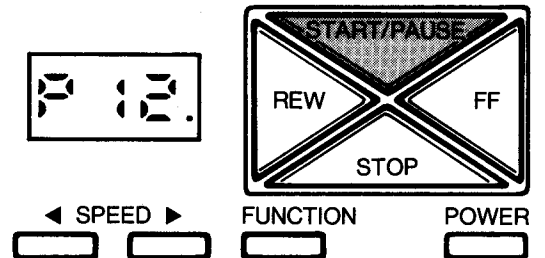

### 4 Try changing the playback speed during playback.

Pressing the ► button speeds up the playback speed, and pressing the ◀ slows it down. The first time you press either button, the current speed is displayed. After that, pressing these buttons allows you to change the speed and the displayed speed changes accordingly. Several seconds after the button is released, the display resumes its usual status. The minimum speed is [ 3 2 ] and the maximum speed is [ 2 8 0 ]. If both ◀ and ► are pressed simultaneously, the speed is set to [ 1 2 0 ].

- The playback speed can be changed in Stop mode, Play Standby mode or Pause mode.

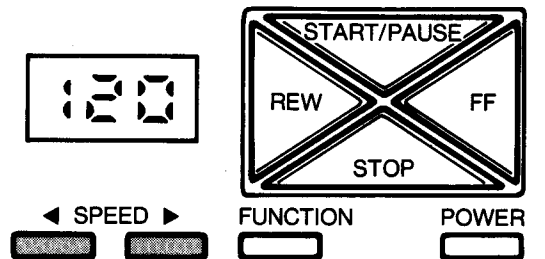

### 5 Press the STOP button to stop playback.

When the STOP button is pressed, the display automatically returns to [ n - ] or [ n - - ]. When the playback of all the data of one song is completed, the display similarly returns automatically to [ n - ] or [ n - - ].

## Recording or Overdubbing During Playback

• If you enter Pause mode during playback, you can perform recording or overdubbing.

### 1 During playback, press the START/PAUSE button.

When you press the START/PAUSE button during playback, playback is temporarily stopped, and the display alternately shows [ PAU ] and [ P x x ]. [ P x x ] indicates the Playback position. From this position, you can perform a Record or Overdub operation. (xx = Playback Position)

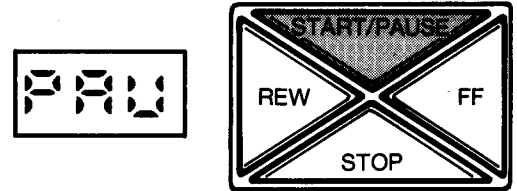

### 2 Press the RECORD (or OVERDUB) button.

When the RECORD button is pressed, the display alternately flashes [ r E C ] and [ r x x ]. When the OVERDUB button is pressed instead, the display alternately flashes [ d U b ] and [ d x x ]. [ x x ] indicates the percentage of the EMQ-1 internal memory that is vacant. If you next play the keyboard or press the START button, the new data will either replace (RECORD) or be dubbed onto (OVERDUB) the original data.

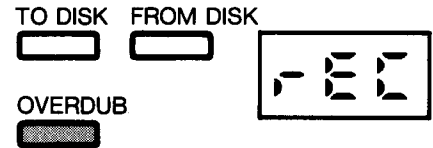
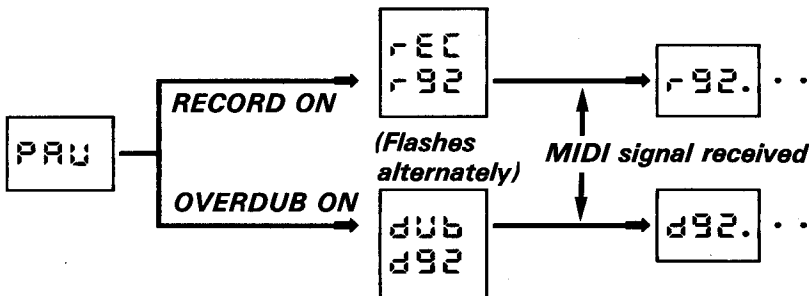

When the RECORD button is pressed.



### 3 If necessary, re-do the recording (or overdubbing).

If you wish to re-do your recording or overdubbing from the position where you pressed the PAUSE button in Step 1, press the RECORD or OVERDUB button before pressing the STOP button. When you next play the keyboard or press the START button, recording or overdubbing is started.

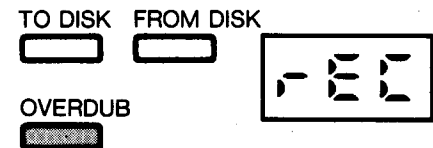
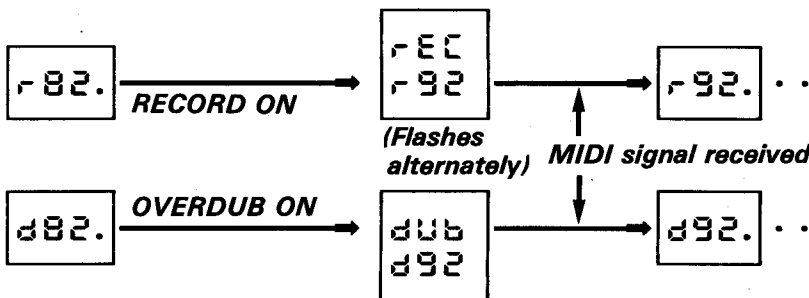

When the RECORD button is pressed.



**NOTE:** This procedure can also be used to re-do recording or overdubbing from the very beginning.

### 4 Press the STOP button to stop recording (or overdubbing).

The display returns to show the specified Song Number as [ n - ] or [ n - - ].

**NOTE:** If you wish to perform recording or overdubbing from a specific position during playback without entering Pause mode, it is also possible to switch to Record or Overdub mode during playback. In this case, press RECORD or OVERDUB button after playback has started, then play the keyboard from the point you wish to start recording or overdubbing. EMQ-1 will automatically be switched to RECORD or OVERDUB mode, and the new data will replace the original data from that position.

# 6 Saving/Loading Data

- The data internally recorded at EMQ-1 can be transferred in bulk to a Quick Disk, then can be recalled to EMQ-1 at any time.
- The To Disk, From Disk and Verify operations each take about eight seconds. During that interval, make sure never to attempt to remove the Quick Disk.

## To Disk (EMQ-1 → Quick Disk)

### 1 Insert a Quick Disk in the disk insertion slot.

The disk has two sides: Side A and Side B. Carefully insert the disk so that the side to which data is to be memorized faces upward. When you need to remove a disk, press the Eject button.

**NOTE:** Only 64K byte Quick Disks can be used.

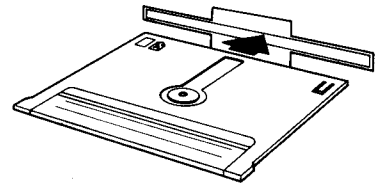

### 2 Press the TO DISK button, then check the display.

When the display flashes [ S ], press the TO DISK button again. The data recorded at EMQ-1 is sent to the Quick Disk, and the In Use lamp at the left of the disk insertion slot lights up. The display returns to its usual status when the To Disk operation is completed.

- If you press the STOP button while the display is flashing, the To Disk operation is cancelled.

- When the above step is performed, the Overdub data which has not yet been merged will be separately recorded. To merge the Overdub data during the saving process, perform the Merge Save operation described on the right.

- To verify that the data memorized onto the disk is identical to the data recorded at EMQ-1, perform the Verify operation described on the right. The display will change to [ V ]. If both sets of data are not identical, the display will show the [ E d 3 ] error message.

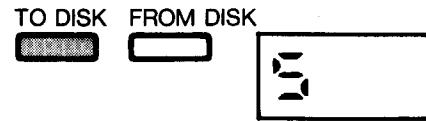

#### [Merge Save Operation]

Press TO DISK while holding down FUNCTION

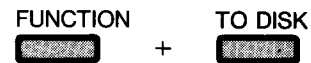

#### [Verify Operation]

Press FROM DISK while holding down FUNCTION

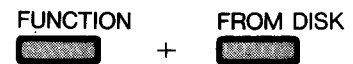

## From Disk (Quick Disk → EMQ-1)

### 1 Insert a Quick Disk in the disk insertion slot.

- If a disk is inserted before turning on EMQ-1, the data of the disk is automatically loaded to EMQ-1 when its power is turned ON, then you can repeat the playback of all songs from Song 1.

### 2 Press the FROM DISK button, then check the display.

When the display flashes [ L ], press the FROM DISK button again. The data memorized onto the Quick Disk is sent to EMQ-1, and the In Use lamp at the left of the disk insertion slot lights up. The display returns to the Song Number when the From Disk operation is completed.

- If you press the STOP button while the display is flashing, the From Disk operation is cancelled.

- When the From Disk operation is performed, the data recorded at EMQ-1 is replaced by the Quick Disk's data.



## The Quick Disk

### • The Protect Tab

Similar to a cassette tape, both Sides A and B of the Quick Disk are provided with a Protect Tab. If you wish to protect the data memorized onto one side of the Quick Disk from accidental erasure, break off its Protect Tab. Even if you unintentionally try to perform a To Disk operation to this side, its data will be protected without being overwritten.

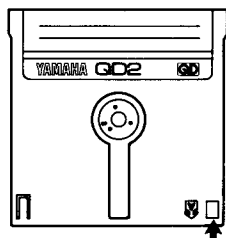

Tab on Side A

### • Disk Storage

Never leave your disks near magnetic objects or in places exposed to a strong magnetic field. Also avoid leaving your disks in places exposed to direct sunlight, high temperature, or excessive humidity.

# 7 MIDI Control

## The Panel Data Send Request Message

- During recording, if you wish to record the panel settings of the keyboard at the beginning of your recorded data, perform the procedure described below. Note that this operation can only be used with Yamaha's MIDI-compatible devices that are provided with a Panel Data Send function.
- This procedure can be performed for either the Record or Overdub operation.

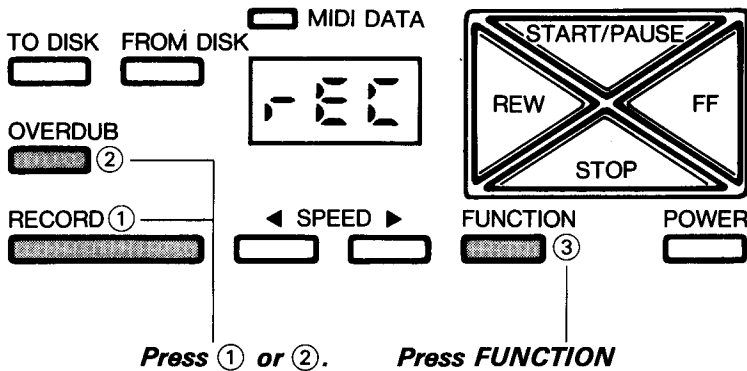

### [Procedure]

When you press RECORD (1) or OVERDUB (2) then press FUNCTION (3) while the display is alternately flashing either between [r E C] and [r x x] or between [d U b] and [d x x], the Panel Data Send Request message is transmitted to the other device. When EMQ-1 receives the Panel Data, its display stops flashing and remains lit.

## The Expanded Functions

- You can select the modes for three different functions: (1) Sending of a Panel Data Send Request message, (2) Recording of After Touch data and (3) Sending START/STOP data.

### 1 Select the desired function.

There are three functions. While holding down the FUNCTION button (1), press the ◀ SPEED button (2) to select a function. The display shows the currently set value, for example, [F 1 0]. The second digit "1" indicates the selected function, and the third digit "0" indicates the mode setting.

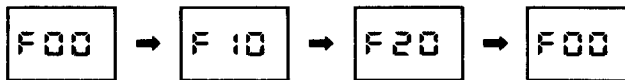

### 2 Select the mode.

While holding down the FUNCTION button (1), press the ▶ SPEED button (3) to select the mode.

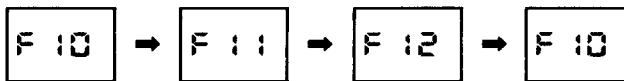

- When you release the FUNCTION button (1) or select another function, the mode selected becomes set.

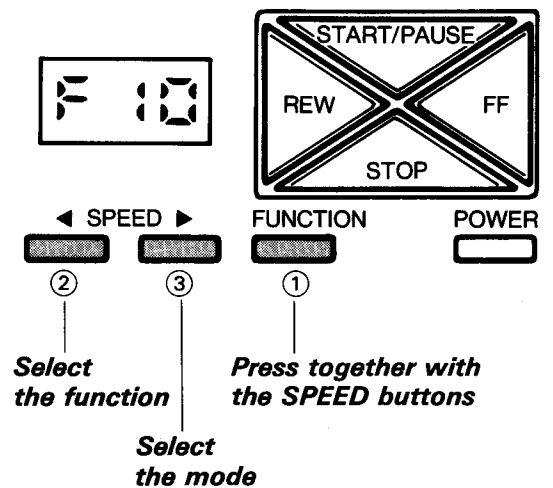

## Description of the Expanded Functions

Function	Description
F 0	■ Selects whether or not to automatically send a Panel Data Send Request message whenever the RECORD or OVERDUB button is pressed.
F 0 0	Not automatically sent.
F 0 1	Automatically sent.
F 1	■ Selects whether or not to record After Touch data [After Touch by key (Polyphonic Key Pressure), After Touch by Channel (Channel Pressure)].
F 1 0	Records neither Polyphonic Key Pressure nor Channel Pressure.
F 1 1	Records only Channel Pressure.
F 1 2	Records both Polyphonic Key Pressure and Channel Pressure.
F 2	■ Selects whether or not to send START/STOP data during playback.
F 2 0	Sends the recorded START/STOP data.
F 2 1	Sends the START/STOP data resulting from pressing the EMQ-1 panel's START/PAUSE button, without sending the recorded START/STOP data.
F 2 2	Sends the START/STOP data of both F 2 0 and F 2 1.
<p><b>NOTE:</b> During Stop mode or Pause mode, STOP data is always sent. When START data is sent by the pressing of the START/PAUSE button, it is always preceded by the sending of CONTINUE data.</p>	

## Switching the Timing Clock

By switching the CLOCK switch at the EMQ-1 rear panel, you can change the way that the Quantize and START/STOP functions operate, as described in the table below.

Function/Mode	In INT (Internal) CLOCK mode	In MIDI CLOCK mode
Quantize	Recording and playback is done with Quantize set to 192	Recording and playback is done with Quantize set to 96
START/STOP		
● In Record Standby mode	Recording is started at either an external device by pressing a key or the Rhythm START button, or at EMQ-1 by the START button.	Recording is started by pressing Rhythm START at an external device; otherwise, the [E 0 2] error message is displayed. If [F 2 1] or [F 2 2] is set as an expanded function mode, however, recording can also be started by pressing a key of the external device or the EMQ-1 START button.
● In Record mode	Recording is stopped by the EMQ-1 STOP button.	Recording is stopped by the Rhythm STOP button of an external device or the EMQ-1 STOP button.
● In Stop mode	Playback is started by the EMQ-1 START button.	Playback is started by the EMQ-1 START button.
● In Play Standby mode	Playback is started by receiving MIDI data or by the EMQ-1 START button.	Playback is started by the external device's Rhythm START button or the EMQ-1 START button.
● In Play mode	Playback is stopped by the EMQ-1 STOP button.	Playback is stopped by the external device's Rhythm STOP button or the EMQ-1 STOP button.

# Error Messages and Specifications

## Error Messages

If you perform an operation incorrectly, the display flashes one of the error messages listed below. In such case, remedy the error as described in the table. To cancel the flashing error message and return the display to its usual status, press the STOP button.

Display	Description of Error	Solution
ED1	A disk is not inserted.	Insert a disk. If a disk is already inserted, make sure it is securely installed.
ED2	A To Disk operation cannot be performed because the disk's Protect Tab is broken.	Use a disk that still has a Protect Tab.
ED3	A disk error occurred during a To Disk, From Disk, or Verify operation.	The disk is probably internally damaged, so use another disk. Never perform playback using a damaged disk.
EO1	Abnormal MIDI data. The Active Sensing data was not received due to a disconnected wire, etc.	If the MIDI cable is disconnected, re-insert the MIDI cable securely.
EO2	EMQ-1 is set to MIDI CLOCK, but no external clock signals are received.	Set the CLOCK of the transmitting device to Internal.
EO3	You are trying to record or overdub with an insufficient amount of vacant memory.	Recording is impossible. To increase the amount of vacant memory, erase any songs you no longer need. <b>[To Erase Unnecessary Songs]</b> 1. Select the Song Number to be erased. 2. Press the RECORD button. 3. Press one voice selector switch at the keyboard to send a few MIDI signals. 4. Next, immediately press the STOP button of EMQ-1.
EP1	You are trying to perform a To Disk operation to save recorded data which also contains copy-protected data.	Copy-protected data cannot be saved to disk.
FUL	During recording or overdubbing, the available memory capacity has been exceeded. Or there is insufficient memory to perform a Merge operation.	To increase the amount of vacant memory, either erase any songs you no longer need, or perform a To Disk operation then erase the songs you have memorized to disk. Then, try recording again.
ERR	A defect has occurred in the EMQ-1 memory (RAM).	Contact the Yamaha Music Dealer where you purchased the unit.

## Specifications

- **Memory Capacity** : 60K bytes (User area)/Max. 9 songs
- **Recording Medium**: 2.8" Quick Disk
- **Modes** : Record, Overdub, Playback
- **Controls** : START/PAUSE, REW, FF, STOP, FUNCTION, POWER switch, SPEED ◀/▶, TO DISK, FROM DISK, OVERDUB, RECORD, CLOCK
- **Display** : Song Number, Play, Record, Overdub, Speed, To Disk, From Disk, Verify, Function, Error Messages
- **Miscellaneous** : Eject, In Use Lamp, MIDI DATA Lamp
- **Accessory Jacks** : MIDI (IN, OUT1, OUT2)
- **Rated Power Supply**: DC IN (9-12V)  
Power Adaptor (PA-4/PA-40/PA-5)
- **Maximum current** : 900 mA
- **External Dimensions**: Width 218 mm (8<sup>3</sup>/<sub>4</sub>"  
Depth 215 mm (8<sup>3</sup>/<sub>5</sub>"  
Height 44 mm (1<sup>3</sup>/<sub>4</sub>"
- **Weight** : 1.5 kg (3.3 lbs)
- **Accessories** : Quick Disk × 1  
MIDI Cable × 2  
DC Cord × 1  
Holder × 2  
Mounting Plate × 2

# Possible Operating Errors

- The phenomena listed below are easily misjudged as being mechanical failures. Before you conclude that your unit is defective, make sure to check each of the phenomenon below.
- The EMQ-1 is a peripheral device and is never used alone. Consequently, the MIDI functions of any device to be connected greatly influences the use of EMQ-1. Carefully read the MIDI-related sections in the manual provided with the target device, and thoroughly check its compatibility with this EMQ-1.

Phenomenon	Cause and Solution
The maximum nine songs cannot be recorded.	If any songs contain a large amount of recorded data, the memory capacity (60K bytes) may be exceeded before you have recorded all nine songs.
There is still sufficient vacant memory, but the 10th song cannot be recorded.	A maximum of nine songs can be recorded.
Previously recorded data has been erased.	You have accidentally recorded onto a previously recorded Song data. To record new Song data without erasing previously recorded Song data, always select an unrecorded Song Number to perform recording.
Vacant memory still exists but recording cannot be performed.	When vacant memory is no longer available during recording, the display shows the [E 0 3] error message and further recording becomes impossible. To increase the amount of vacant memory, erase any songs you no longer need.
After performing two Overdub operations, you find that the first Overdub data has been erased.	You forgot to perform a Merge operation. If you wish to perform a second Overdub operation, always make sure to perform a Merge operation after the first Overdub operation.
The recorded voice is played back as a different voice.	You forgot to record the panel status at the beginning of recording. First, send a Panel Data Send Request message as described on page 9 to record the panel settings, then record the performance data. Or, the keyboard may be set to Program Change OFF mode.
The Rhythm pattern was changed during recording, but does not change during playback.	Certain models cannot send changes in the Rhythm patterns during recording. Or, the keyboard may be set to Program Change OFF mode.
The SPEED buttons were pressed but the speed does not change.	The CLOCK setting of EMQ-1 and the receiving device do not match. Set EMQ-1 to INT., and set the receiving device to MIDI (External).
After Touch data is not recorded.	After Touch data cannot be recorded in the normal status of EMQ-1. To record After Touch data, use the expanded function to select the mode which enables the recording of After Touch data.

## MODEL EMQ-1

## MIDI Implementation Chart

Function...		Transmitted	Recognized	Remarks
Basic Channel	Default Channel	1-16 ×	1-16 ×	
Mode	Default Messages Altered	Mode 1 OMNI ON *****	Mode 1 OMNI ON ×	
Note Number	True Voice	0-127 *****	0-127	
Velocity	Note ON Note OFF	9nH, v = 1-127 9nH, v = 0, 8nH	9nH, v = 1-127 ○	
After Touch	Key's Ch's	○ ○	○ ○	
Pitch Bender		○	○	
Control Change	0-121	○	○	
Prog Change	True #	○ 0-127 *****	○ 0-127	
System Exclusive		○	○	
System Common	: Song Pos : Song Sel : Tune	× × ×	× × ×	
System Real Time	: Clock : Commands	○ ○	○ ○	
Aux Messages	: Local ON/OFF : All Notes Off : Active Sense : Reset	○ ○ ○ ○	○ ○ ○ ○	
Notes				

Mode 1: OMNI ON, POLY  
Mode 3: OMNI OFF, POLY

Mode 2: OMNI ON, MONO  
MODE 4: OMNI OFF, MONO

○: Yes  
×: No



## FCC INFORMATION

### Attention users in the U.S.A.

This equipment generates and uses radio frequency energy and if not installed and used properly, that is, in strict accordance with the manufacturer's instructions, may cause interference to radio and television reception. It has been type tested and found to comply with the limits for a Class B computing device in accordance with the specifications in Subpart J of Part 15 of FCC Rules, which are designed to provide reasonable protection against such interference in a residential installation. However, there is no guarantee that interference will not occur in a particular installation. If this equipment does cause interference to radio or television reception which can be determined by turning the equipment off and on, the user is encouraged to try to correct the interference by one or more of the following measures.

Reorient the receiver antenna

Relocate the equipment with respect to the receiver

Move the equipment away from the receiver

Plug the equipment into a different outlet so that equipment and receiver are on different branch circuits.

If necessary, the user should consult the dealer or an experienced radio/television technician for additional suggestions. The user may find the following booklet prepared by the Federal Communications Commission helpful:

"How to Identify and Resolve Radio-TV Interference Problems."

This booklet is available from the U.S. Government Printing Office, Washington D.C. 20402. Stock No. 004-000-00345-4.

- This applies only to products distributed by Yamaha Corporation of America.

### Wichtiger Hinweis für die Benutzung in der Bundesrepublik Deutschland.

#### Bescheinigung des Importeurs

Hiermit wird bescheinigt, daß der/die/des

**Musikinstrument Typ: EMQ-1**

(Gerät, Typ, Bezeichnung)

in Übereinstimmung mit den Bestimmungen der

**VERFÜGUNG 1046/84**

(Amtsblattverfügung)

funk-entstört ist.

Der Deutschen Bundespost wurde das Inverkehrbringen dieses Gerätes angezeigt und die Berechtigung zur Überprüfung der Serie auf Einhaltung der Bestimmungen eingeräumt.

**Yamaha Europa GmbH**

Name des Importeurs

#### CANADA

THIS DIGITAL APPARATUS DOES NOT EXCEED THE "CLASS B" LIMITS FOR RADIO NOISE EMISSIONS FROM DIGITAL APPARATUS SET OUT IN THE RADIO INTERFERENCE REGULATION OF THE CANADIAN DEPARTMENT OF COMMUNICATIONS.

LE PRESENT APPAREIL NUMERIQUE N'EMET PAS DE BRUITS RADIOELECTRIQUES DEPASSANT LES LIMITES APPLICABLES AUX APPAREILS NUMERIQUES DE LA "CLASSE B" PRESCRITES DANS LE REGLEMENT SUR LE BROUILLAGE RADIOELECTRIQUE EDICTE PAR LE MINISTERE DES COMMUNICATIONS DU CANADA.

- This applies only to products distributed by YAMAHA Canada Music Ltd.
- Ceci ne s'applique qu'aux produits distribués par Yamaha Canada Music Ltd.

- Dies bezieht sich nur auf die von der YAMAHA EUROPA GmbH vertriebenen Produkte.

**YAMAHA**

YAMAHA CORPORATION  
P.O.Box 1, Hamamatsu, Japan