



Electone® *STAGEA*®

ELB-01

Owner's Manual

STAGEA



PRECAUTIONS

PLEASE READ CAREFULLY BEFORE PROCEEDING

* Please keep this manual in a safe place for future reference.



WARNING

Always follow the basic precautions listed below to avoid the possibility of serious injury or even death from electrical shock, short-circuiting, damages, fire or other hazards. These precautions include, but are not limited to, the following:

Power supply/Power cord

- Only use the voltage specified as correct for the instrument. The required voltage is printed on the name plate of the instrument.
- Check the electric plug periodically and remove any dirt or dust which may have accumulated on it.
- Do not place the power cord near heat sources such as heaters or radiators, and do not excessively bend or otherwise damage the cord, place heavy objects on it, or place it in a position where anyone could walk on, trip over, or roll anything over it.

Do not open

- Do not open the instrument or attempt to disassemble the internal parts or modify them in any way. The instrument contains no user-serviceable parts. If it should appear to be malfunctioning, discontinue use immediately and have it inspected by qualified Yamaha service personnel.

Water warning

- Do not expose the instrument to rain, use it near water or in damp or wet conditions, or place containers on it containing liquids which might spill into any openings.
- Never insert or remove an electric plug with wet hands.

Fire warning

- Do not put burning items, such as candles, on the unit. A burning item may fall over and cause a fire.

If you notice any abnormality

- If the power cord or plug becomes frayed or damaged, or if there is a sudden loss of sound during use of the instrument, or if any unusual smells or smoke should appear to be caused by it, immediately turn off the power switch, disconnect the electric plug from the outlet, and have the instrument inspected by qualified Yamaha service personnel.



CAUTION

Always follow the basic precautions listed below to avoid the possibility of physical injury to you or others, or damage to the instrument or other property. These precautions include, but are not limited to, the following:

Power supply/Power cord

- When removing the electric plug from the instrument or an outlet, always hold the plug itself and not the cord. Pulling by the cord can damage it.
- Remove the electric plug from the outlet when the instrument is not to be used for extended periods of time, or during electrical storms.
- Do not connect the instrument to an electrical outlet using a multiple-connector. Doing so can result in lower sound quality, or possibly cause overheating in the outlet.

Assembly

- Read carefully the attached documentation explaining the assembly process. Failure to assemble the instrument in the proper sequence might result in damage to the instrument or even injury.

Location

- Do not expose the instrument to excessive dust or vibrations, or extreme cold or heat (such as in direct sunlight, near a heater, or in a car during the day) to prevent the possibility of panel disfiguration or damage to the internal components.
- Do not use the instrument in the vicinity of a TV, radio, stereo equipment, mobile phone, or other electric devices. Otherwise, the instrument, TV, or radio may generate noise.
- Do not place the instrument in an unstable position where it might accidentally fall over.
- Before moving the instrument, remove all connected cables.
- When setting up the instrument, make sure that the AC outlet you are using is easily accessible. If some trouble or malfunction occurs, immediately turn off the power switch and disconnect the plug from the outlet.
- Do not place the instrument against a wall (allow at least 3 cm/one-inch from the wall), since this can cause inadequate air circulation, and possibly result in the instrument overheating.

Connections

- Before connecting the instrument to other electronic components, turn off the power for all components. Before turning the power on or off for all components, set all volume levels to minimum. Also, be sure to set the volumes of all components at their minimum levels and gradually raise the volume controls while playing the instrument to set the desired listening level.

Maintenance

- When cleaning the instrument, use a soft, dry cloth. Do not use paint thinners, solvents, cleaning fluids, or chemical-impregnated wiping cloths.

Handling caution

- Do not insert a finger or hand in any gaps on the instrument.
- Never insert or drop paper, metallic, or other objects into the gaps on the panel or keyboard. If this happens, turn off the power immediately and unplug the power cord from the AC outlet. Then have the instrument inspected by qualified Yamaha service personnel.
- Do not place vinyl, plastic or rubber objects on the instrument, since this might discolor the panel or keyboard.
- Do not rest your weight on, or place heavy objects on the instrument, and do not use excessive force on the buttons, switches or connectors.
- Do not operate the instrument for a long period of time at a high or uncomfortable volume level, since this can cause permanent hearing loss. If you experience any hearing loss or ringing in the ears, consult a physician.

Using the bench (If included)

- Do not place the bench in an unstable position where it might accidentally fall over.
- Do not play carelessly with or stand on the bench. Using it as a tool or step-ladder or for any other purpose might result in accident or injury.
- Only one person should sit on the bench at a time, in order to prevent the possibility of accident or injury.
- If the bench screws become loose due to extensive long-term use, tighten them periodically using the included tool.

Saving data

Saving and backing up your data

- Always save data to a USB Flash Memory, in order to help prevent the loss of important data due to a malfunction or user operating error.

Backing up the USB storage device

- To protect against data loss through media damage, we recommend that you save your important data onto two external media.

Yamaha cannot be held responsible for damage caused by improper use or modifications to the instrument, or data that is lost or destroyed.

Always turn the power off when the instrument is not in use.

The serial number of this product may be found on the bottom of the unit. You should note this serial number in the space provided below and retain this manual as a permanent record of your purchase to aid identification in the event of theft.

Model No. ELB-01 _____

Serial No. _____

(bottom)

Congratulations!

You are the proud owner of a fine electronic organ, the Electone STAGEA ELB-01.

The Yamaha Electone combines the most advanced tone generation technology with state-of-the-art digital electronics and features to give you stunning sound quality with maximum musical versatility.

In order to make the most of your Electone and its extensive performance potential, we urge you to read the manual thoroughly while trying out the various features described. Keep the manual in a safe place for later reference.

Accessories

- Bench
- Dust Cover
- Music Rest
- Owner's Manual
- Playing the ELB-01 — Tutorial Guidebook
- Assembly Instructions

The ELB-01 is compatible with the following formats.



“GM (General MIDI)” is one of the most common Voice allocation formats. “GM System Level 2” is a standard specification that enhances the original “GM” and improves Song data compatibility. It provides for increased polyphony, greater Voice selection, expanded Voice parameters, and integrated effect processing.



XG is a major enhancement of the GM System Level 1 format, and was developed by Yamaha specifically to provide more Voices and variations, as well as greater expressive control over Voices and effects, and to ensure compatibility of data well into the future.



GS was developed by the Roland Corporation. In the same way as Yamaha XG, GS is a major enhancement of the GM specifically to provide more Voices and Drum kits and their variations, as well as greater expressive control over Voices and effects.



The Style File Format combines all of Yamaha’s auto accompaniment know-how into a single unified format.

AVE-TCP™ AVE-TCP™, a TCP/IP protocol stack by ACCESS Co., Ltd., is installed in this product. Copyright © 1986-2008 ACCESS CO., LTD.

AVE™-SSL AVE™-SSL, an encryption module technology by ACCESS Co., Ltd., is installed in this product. Copyright © 1997-2008 ACCESS CO., LTD.



- This product incorporates and bundles computer programs and contents in which Yamaha owns copyrights or with respect to which it has license to use others’ copyrights. Such copyrighted materials include, without limitation, all computer software, styles files, MIDI files, WAVE data and sound recordings. Any unauthorized use of such programs and contents outside of personal use is not permitted under relevant laws. Any violation of copyright has legal consequences. DON’T MAKE, DISTRIBUTE OR USE ILLEGAL COPIES.
- Copying of the commercially available music sequence data and/or digital audio files is strictly prohibited except for your personal use.
- Electone and STAGEA are the trademarks of Yamaha Corporation.
- The company names and product names in this Owner’s Manual are the trademarks or registered trademarks of their respective companies.
- The illustrations and LCD screens as shown in this owner’s manual are for instructional purposes only, and may appear somewhat different from those on your instrument.

Contents

Congratulations!	4
Accessories	4
Main Features	8
Panel Layout	9
Overview	9
Front Panel.....	10
1 Quick Introductory Guide	12
Getting Started.....	12
Registration Menu.....	14
Selecting Registrations from the Registration Menu	14
Registration Menu List.....	15
Using the LCD display.....	17
LCD Display and LCD Buttons.....	17
Changing the Display Page	18
Selecting a Voice or Rhythm	18
Basic Operation.....	19
Selecting the Display Language	19
Factory Set (Initializing the Electone).....	20
Confirming the Version of Your Electone	20
2 Voices	21
Voices for each keyboard.....	21
Voice Display	23
Selecting Voices with the Voice buttons.....	25
Selecting Voices for Voice section 1	25
Adjusting the Voice volume.....	26
On/Off status of Voices	28
Selecting a Voice for Voice section 2	29
Switching between Voice section 1 and Voice section 2.....	29
Selecting Voices for Voice Section 2	30
Selecting Voices from the User buttons	32
Voice List	34
3 Voice Controls and Effects	40
Selecting from the Voice Condition display.....	41
Selecting from the panel.....	48
Reverb.....	48
Sustain.....	49
Rotary Speaker.....	50
Effect List	52
4 Rhythm/Keyboard Percussion	56
Selecting rhythms with the Rhythm buttons.....	56
To select and play a rhythm.....	56
Operating the rhythm from the panel	59
Adjusting the tempo.....	61
Changing the rhythm volume/reverb.....	62
Selecting rhythms from the User buttons	63
To call up a User rhythm	64
Selecting Rhythm from an External Media	65
Rhythm List.....	67
Accompaniment.....	68
Automatic Accompaniment	
—Auto Bass Chord (A.B.C.).....	71
Melody On Chord (M.O.C.).....	74
Keyboard Percussion.....	77
Using the Preset Keyboard Percussion.....	77
Changing the Keyboard Percussion volume/reverb	78
Preset Keyboard Percussion List	80
Assigning sounds to the User Keyboard Percussion.....	88
Recalling the User Keyboard Percussion.....	92
Kit Assign List.....	93
5 Registration Memory	97
Storing Registrations.....	97
Selecting Registrations	99
Saving the Registration data to USB flash memory.....	100
Initializing Registration Memory	100
Registration Shift	102
6 Music Data Recorder (MDR).....	107
Using the M.D.R. Function	108
Formatting External Media	109
Selecting a Song.....	111
Recording.....	117
Recording	117
Re-recording (Retry).....	118
Recording Each Part Separately	118
Punch-in Recording.....	121
Changing the Song/Folder Name	122
Saving Registrations as Registration Data (File).....	124
Saving Two or More Registration Banks to One Song.....	126
Replacing Registrations	127
Deleting Registrations	128
Next Regist Settings (Using more than 16 Registrations in one song).....	129
Recalling Recorded Registrations	131
Loading Registrations.....	131
Playing Back a Song.....	132
Playing Back the Selected Part(s)	133
Fast Forward, Rewind and Pause.....	134
Changing the Tempo.....	134
Repeat Playback	135
Playing Back XG Songs.....	136
Song Copy/Delete/Convert, Folder Create/Delete ..	137
Song Copy.....	137
Song Delete/Folder Delete	139
Creating folders	140
Converting ELB format songs to EL	141
Converting EL format songs to ELB	142
Converting to XG format.....	144
Checking the Remaining Memory	145

7	Footswitches.....	146
	Left Footswitch.....	146
8	Transpose and Pitch Controls....	150
9	Connections	151
	Accessory Jacks and Controls	151
	Connection Examples — External Devices	153
	Using Headphones	153
	Playing the Sounds of the Electone Through an External Audio System.....	153
	Recording the Sounds of the Electone to an External Recorder	154
	Controlling External MIDI Devices from the Electone	154
	Controlling the Electone from an External Device	155
	Connecting USB storage devices.....	155
	Connection with Computer	156
	Using the USB terminal.....	156
	Using the MIDI IN/OUT terminals.....	157
	MIDI	157
	What is MIDI?	157
	MIDI Messages of the Electone	159
	MIDI Channels.....	160
	MIDI Control.....	161
10	Appendix	163
	Assembly Instructions.....	163
	Installing Optional Hardware	167
	Installing the Floppy Disk Drive.....	167
	MIDI Data Format.....	168
	MIDI Implementation Chart	178
	Troubleshooting	180
	Specifications	182
	Index.....	183

1	Quick Introductory Guide
2	Voices
3	Voice Controls and Effects
4	Rhythm/ Keyboard Percussion
5	Registration Memory
6	Music Data Recorder (MDR)
7	Footswitches
8	Transpose and Pitch Controls
9	Connections
10	Appendix

Main Features

Wide Variety of Registration Menus

page 14

The Registration Menu buttons feature a total of 330 Registrations, allowing you to instantly set up the Electone for playing your favorite type of music. The Registrations in Registration Menu are divided into six basic categories for ease of selection. Moreover, you can edit any of the Registrations and customize them to fit your own performance needs.

Richly textured, AWM Voices and High Quality Digital Effects

pages 21, 52

The ELB-01 contains a huge amount of exceptionally high-quality Voices—245 altogether—created with the AWM (Advanced Wave Memory) tone generation system. The authentic touch response keyboard lets you play these Voices with all the expressiveness and control of an actual acoustic instrument. What's more, there are wide variety of the effect types that you can apply to each Voice section—letting you enhance and even completely change the character of the Voices.

Dynamic, Contemporary Rhythms and Auto Accompaniment

page 56

The exceptionally wide selection of 133 rhythms lets you choose exactly the rhythm you need in your performance. Each rhythm contains 15 variations (sections)—such as Main, Fill In, Intro, Ending, and Break—that you can easily switch while you play, to make your performance even more dynamic and professional. Each rhythm has its own matching accompaniment divided into five instrument parts, providing basic backing as well as embellishments.

Keyboard Percussion

page 77

This powerful feature allows you to play drum and percussion sounds from the keyboard. A wide range of sounds and drum/percussion kits are available, for performing rhythms in real time. Each sound is assigned to its own key, and the sounds include everything from conventional kicks and snares to a wide variety of ethnic and Latin instruments, as well as special sound effects, such as thunder, laughing, animal cries and more.

Versatile Functions of the Music Data Recorder

page 107

The Electone also features a Music Data Recorder (MDR) for recording your Registrations and performances to USB flash memory, and playing back those performances using the sounds of the Electone. In addition, the MDR allows you to copy a song from one USB flash memory device to another, letting you archive your important recordings and Registration data. The Electone also allows you to convert the data format, letting you play back songs that were recorded on other model Electones.

Panel Layout

Overview

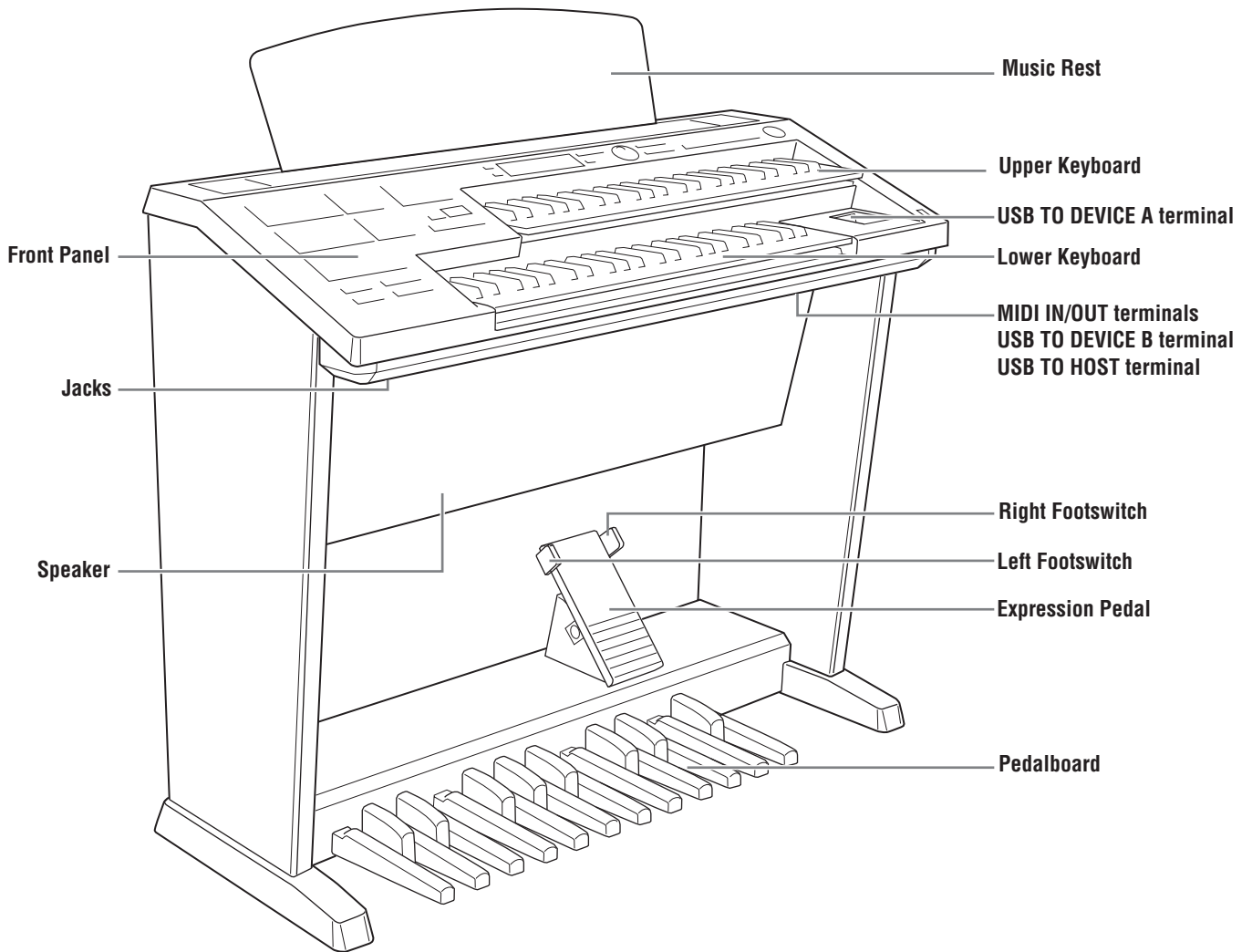

Front Panel

MUSIC DATA RECORDER (page 107)
Allows recording and playback of your keyboard performances, and lets you store Registration data for future recall

LCD display (page 17)
Shows the current settings of the Electone

LEAD VOICE (page 21)
Selects the Lead Voices for Upper Keyboard

PEDAL VOICE 1/2 (page 22)
Selects the Voices for Pedalboard

Data Control [A] – [D] buttons (page 17)
Selects the setting in the display

[VOICE SECTION] button (page 25)
Switches between Voice sections 1 and 2

UPPER KEYBOARD VOICE 1/2 (page 21)
Selects the Voices for Upper Keyboard

LOWER KEYBOARD VOICE 1/2 (page 22)
Selects the Voices for Lower Keyboard

KEYBOARD PERCUSSION (page 77)
Turns Keyboard Percussion On or Off

RHYTHM CONTROL (page 59)
Starts and stops the rhythm, and adds changes to the rhythm

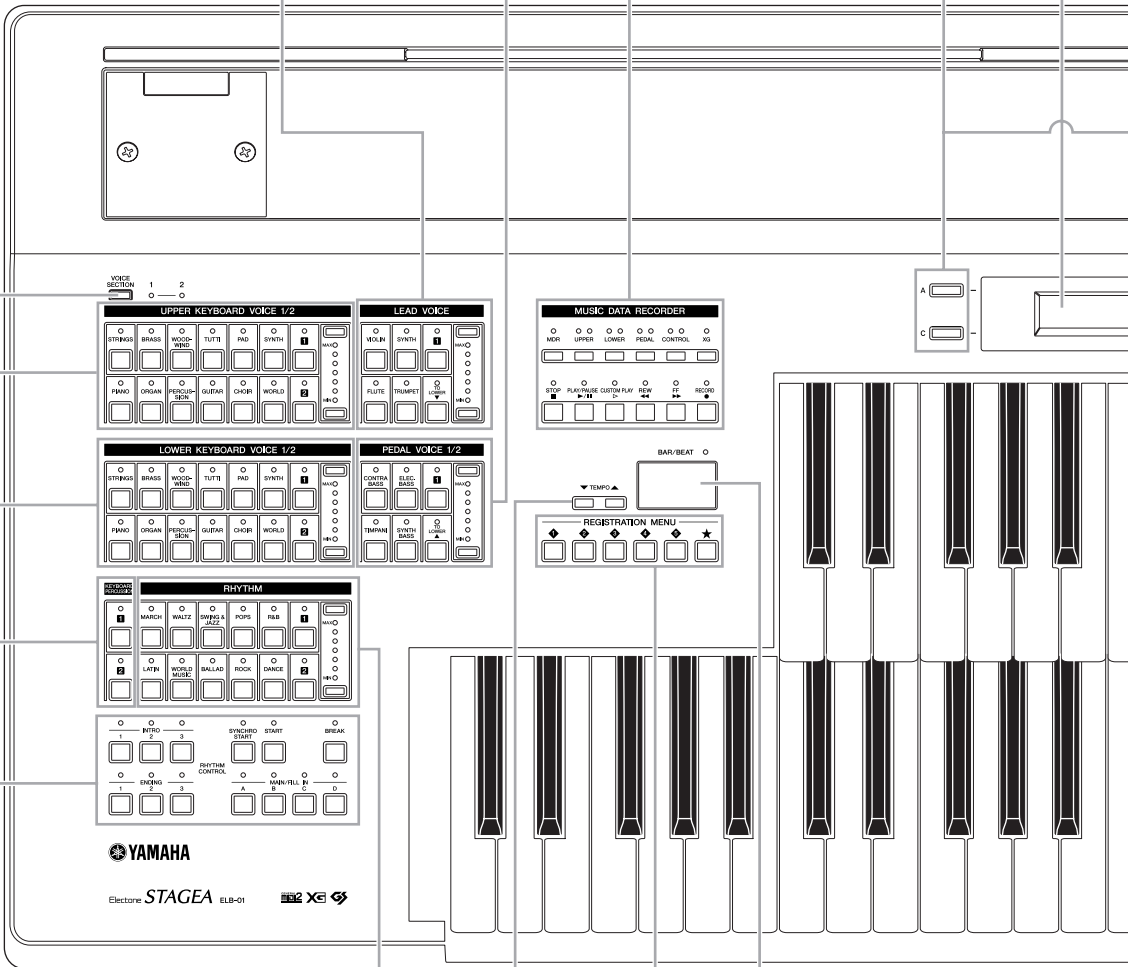

RHYTHM (page 56)
Sets the rhythm

TEMPO buttons (page 61)
Adjusts the speed of the rhythm

BAR/BEAT display (page 61)
Shows the current tempo or position in the measure

REGISTRATION MENU (page 14)
Set the registration

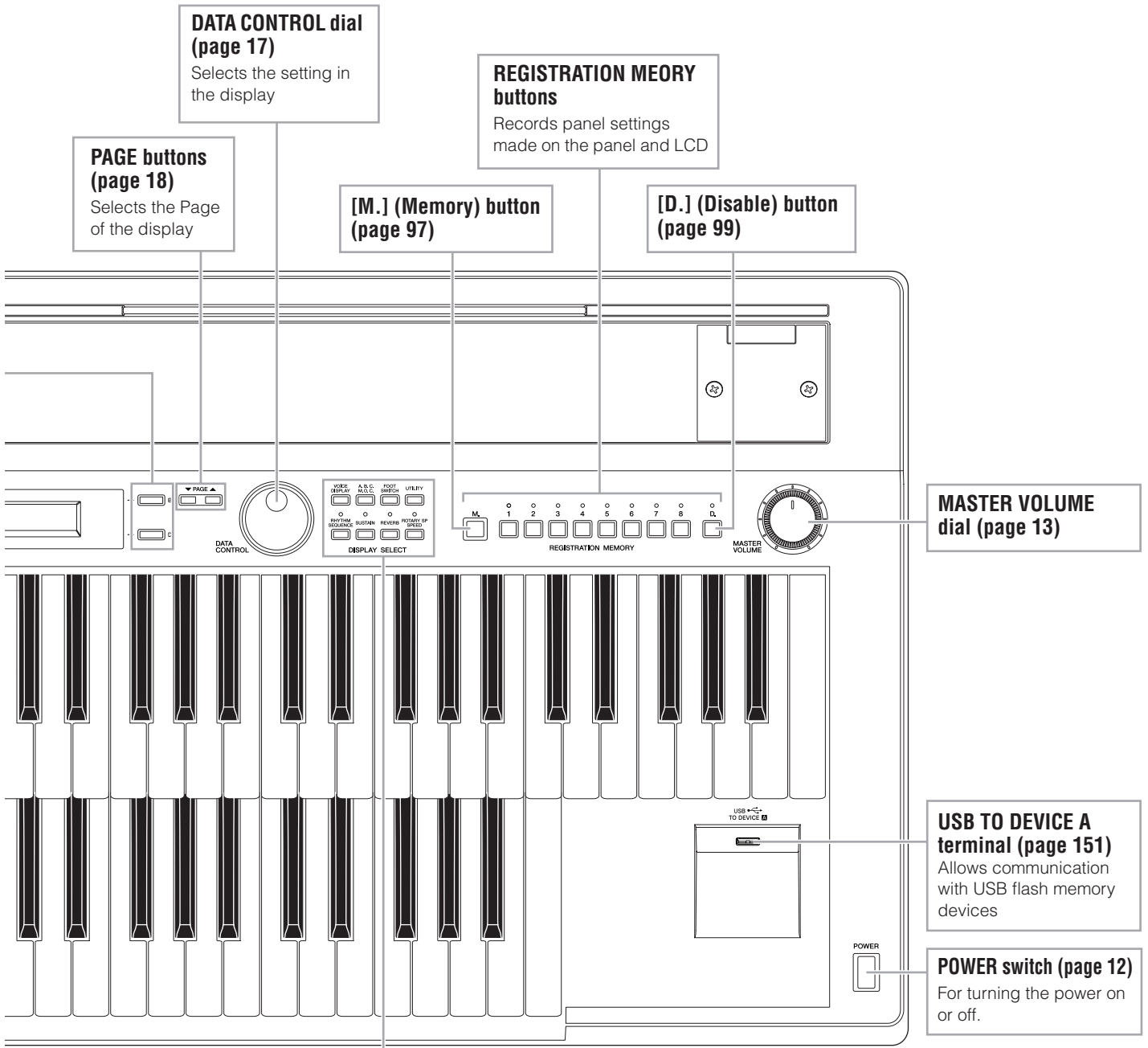

Display Select

[VOICE DISPLAY] button (page 23)	VOICE DISPLAY	A. B. C. M. O. C.	FOOT SWITCH	UTILITY	[UTILITY] button (page 19)
[A. B. C./M. O. C.] button (page 71)					[FOOTSWITCH] button (page 146)
[RHYTHM SEQUENCE] button (page 75)	RHYTHM SEQUENCE	SUSTAIN	REVERB	ROTARY SP SPEED	[ROTARY SP SPEED] button (page 50)
[SUSTAIN] button (page 49)					[REVERB] button (page 48)
DISPLAY SELECT					

Quick Introductory Guide

Whether you are an advanced performer or have never touched an electronic keyboard in your life, we recommend that you take the time to go through this basic section. It shows you in the simplest possible manner how to start playing your Electone.

1 Getting Started

1 Plug the power cord into an appropriate electrical outlet.



Only use the voltage specified as correct for the Electone. The required voltage is printed on the name plate of the Electone. Yamaha products are manufactured specifically for the supply voltage in the area where they are to be sold. If you intend to use the instrument in another location, or if any doubt exists about the supply voltage, please consult with a qualified technician.

2 Turn on the Electone by pressing the POWER switch.

POWER

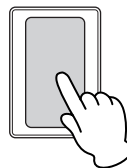

When you turn on the Electone, the following displays will appear one after the other on the LCD display:

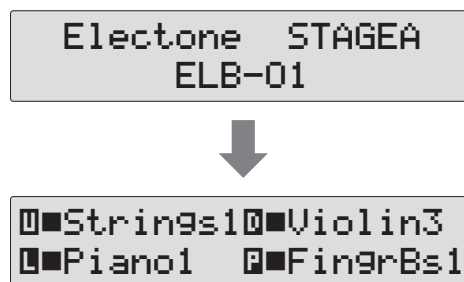

This last display, Voice Display, shows you the currently assigned voice settings for each Voice section (page 23).

3 Set the **MASTER VOLUME** control.

The **MASTER VOLUME** control is an overall control that affects the volume of the entire instrument.

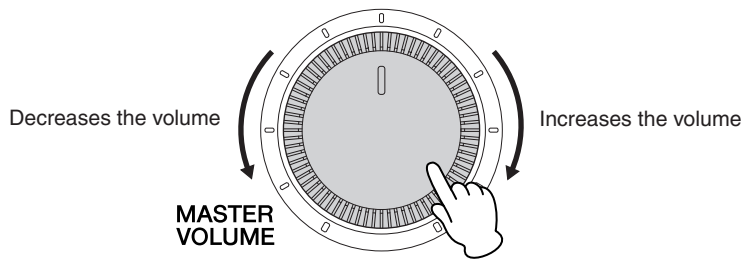

4 Press the **Expression pedal** down with your foot.

Once you have set the **MASTER VOLUME** control to a suitable level, you can use the **Expression pedal** to change the volume with your foot as you play.

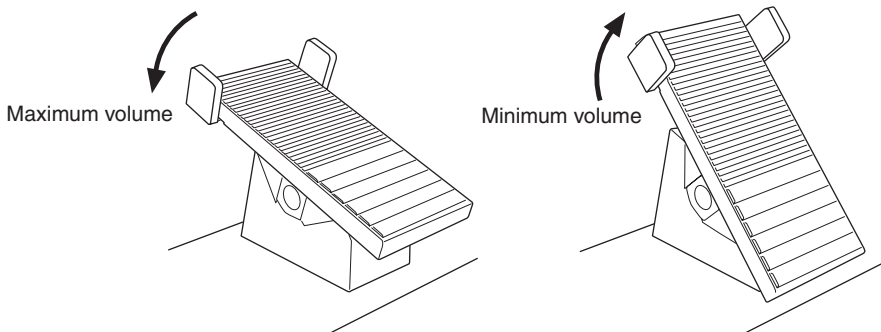

2 Registration Menu

The Registration Menu is a simple, highly convenient way to instantly change all the Electone settings for playing in specific music styles. A Registration consists of panel settings including the selected Upper Keyboard Voices, Lower Keyboard Voices, Pedal Voices, the assigned rhythm and so on. Each Registration Menu button (1 – 5) includes 48 “hidden” Registrations (90 Registrations for the [★] button), with each Registration specially suited for playing in a different music style.



NOTE
Additional basic Registrations are preset on the Registration Memory locations from 1 to 16. See page 97 for details.

Selecting Registrations from the Registration Menu

1 Press one of the REGISTRATION MENU buttons.

Each button has different Registrations for different music genres. For example, if you want to play Jazz, press the [4] button. For details on the Registration Menu, see page 15.

REGISTRATION MENU	
1	Kids
2	Pops & Rock
3	Dance & Ballad
4	Jazz & Latin
5	Symphony & World
★	Lesson

2 From this main category, select the specific Registration you want to use.

Each Registration Menu button actually contains many hidden Registrations, and only the currently selected Registration is shown in the display. Select the hidden Registrations in sequence by turning the DATA CONTROL dial clockwise. Turning the DATA CONTROL dial counter-clockwise selects in the reverse order.

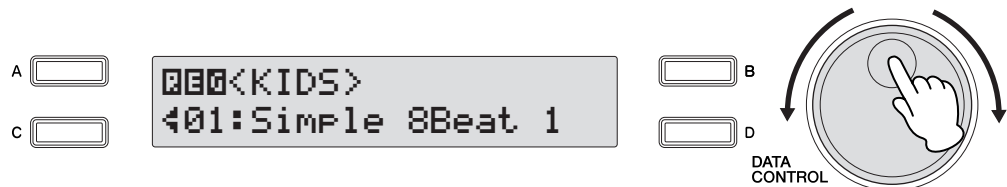

3 Play your favorite song with the selected Registration.

Registration Menu List

[1] KIDS

No.	Regist. Name
01	Simple 8Beat 1
02	Simple 8Beat 2
03	Light Step
04	Sunny Pop
05	Kids March 1
06	Kids March 2
07	Kids March 3
08	Synth. Rock
09	Symphon.March 1
10	Symphon.March 2
11	Bluegrass
12	Sea Carnival
13	Basic Waltz
14	Brass Ensemble
15	Pure Waltz
16	Rococo Ensemble
17	Pop Cha Cha
18	Comical Rumba
19	Comical Samba
20	Toy Orchestra
21	Charleston
22	Winter Swing
23	Snow Waltz 1
24	Snow Waltz 2
25	Alpine Polka *A
26	Alpine Polka *B
27	Alpine Polka *C
28	Alpine Polka *D
29	Dream Ballad *A
30	Dream Ballad *B
31	Dream Ballad *C
32	Dream Ballad *D
33	Pops Orches. *A
34	Pops Orches. *B
35	Pops Orches. *C
36	Pops Orches. *D
37	Kids On Stage*A
38	Kids On Stage*B
39	Kids On Stage*C
40	Kids On Stage*D
41	Galaxy March *A
42	Galaxy March *B
43	Galaxy March *C
44	Galaxy March *D
45	SE *A
46	SE *B
47	SE *C
48	SE *D

[2] POPS & ROCK

No.	Regist. Name
01	Dynamic 8Beat
02	NY Ballad
03	British Pop
04	8Beat Modern
05	Rock Band
06	Detroit Pop
07	Techno Pop
08	Sheriff Reggae
09	Rock&Roll
10	Power Rock
11	60's GuitarRock
12	Unplugged
13	Motor City
14	Lovely Shuffle
15	Gospel Shuffle
16	Joyful Gospel
17	Frankly Soul
18	Soul
19	Gospel
20	6/8 Soul
21	Hit Pop
22	New Country
23	Eternal Pop
24	Ground Beat
25	Bounce Pop *A
26	Bounce Pop *B
27	Bounce Pop *C
28	Bounce Pop *D
29	Blues Jam *A
30	Blues Jam *B
31	Blues Jam *C
32	Blues Jam *D
33	Evergre.Waltz*A
34	Evergre.Waltz*B
35	Evergre.Waltz*C
36	Evergre.Waltz*D
37	16Beat Pop *A
38	16Beat Pop *B
39	16Beat Pop *C
40	16Beat Pop *D
41	Top Gear Rock*A
42	Top Gear Rock*B
43	Top Gear Rock*C
44	Top Gear Rock*D
45	Southern Pop *A
46	Southern Pop *B
47	Southern Pop *C
48	Southern Pop *D

[3] DANCE & BALLAD

No.	Regist. Name
01	Organ Ballad
02	Dramatic Ballad
03	Love Ballad
04	Smooth Lead
05	Pop Ballad
06	Guitar Ballad
07	Acoustic Ballad
08	Healing Guitar
09	Chillout
10	Sweetheart 1
11	Sweetheart 2
12	Slow & Easy
13	Euro Trance
14	6/8 Trance
15	Cool Hip Hop
16	Latin House
17	Dance Beat
18	Euro Dance Pop
19	UK Pop
20	Jive
21	Disco Queen
22	Disco Soul
23	Pop Disco
24	Hot Disco
25	Ibiza *A
26	Ibiza *B
27	Ibiza *C
28	Ibiza *D
29	Power House *A
30	Power House *B
31	Power House *C
32	Power House *D
33	Dance Latino *A
34	Dance Latino *B
35	Dance Latino *C
36	Dance Latino *D
37	TwilightDisco*A
38	TwilightDisco*B
39	TwilightDisco*C
40	TwilightDisco*D
41	Love Song *A
42	Love Song *B
43	Love Song *C
44	Love Song *D
45	Movie Ballad *A
46	Movie Ballad *B
47	Movie Ballad *C
48	Movie Ballad *D

[4] JAZZ & LATIN

No.	Regist. Name
01	Blow On Sax
02	Sax Ensemble
03	Moonlight
04	Big Band
05	Clarinet Swing
06	Jazz Combo
07	Medium Jazz
08	Organ Session
09	Guitar Combo
10	Tender Ballad
11	Jazz Waltz
12	Five-Four
13	Big Band Samba
14	Mambo Brass
15	Mambo Tenor
16	Montuno
17	Bossa Nova
18	Pop Bossa
19	Sweet Rumba
20	Beguine
21	Cha Cha Cha
22	Mellow Groove
23	Modern R&B
24	Dixieland Jazz
25	Jungle Drum *A
26	Jungle Drum *B
27	Jungle Drum *C
28	Jungle Drum *D
29	Jazz Club *A
30	Jazz Club *B
31	Jazz Club *C
32	Jazz Club *D
33	Afro Session *A
34	Afro Session *B
35	Afro Session *C
36	Afro Session *D
37	ChaChaGrandee*A
38	ChaChaGrandee*B
39	ChaChaGrandee*C
40	ChaChaGrandee*D
41	3/4 FastJazz *A
42	3/4 FastJazz *B
43	3/4 FastJazz *C
44	3/4 FastJazz *D
45	Twilight Sax *A
46	Twilight Sax *B
47	Twilight Sax *C
48	Twilight Sax *D

[5] SYMPHONY & WORLD

No.	Regist. Name
01	Fanfare
02	StringOrchestra
03	Romantic Violin
04	Baroque
05	Flute&Harp
06	Serenade
07	Fast March
08	Wild West
09	Vienna Waltz
10	Polka
11	Chanson Club
12	Theatre Organ
13	Flamenco
14	Pop Flamenco
15	Mexican Dance
16	Mariachi
17	Celtic Dance
18	Folk Step
19	Italiano
20	Musette
21	Country
22	Hawaiian
23	ChineseNocturne
24	Japanese Sound
25	Orches.March *A
26	Orches.March *B
27	Orches.March *C
28	Orches.March *D
29	Pasodoble *A
30	Pasodoble *B
31	Pasodoble *C
32	Pasodoble *D
33	Tango *A
34	Tango *B
35	Tango *C
36	Tango *D
37	Show Time *A
38	Show Time *B
39	Show Time *C
40	Show Time *D
41	Majes. Sound *A
42	Majes. Sound *B
43	Majes. Sound *C
44	Majes. Sound *D
45	Orches.Swing *A
46	Orches.Swing *B
47	Orches.Swing *C
48	Orches.Swing *D

[★] LESSON

No.	Regist. Name
01	Simple 1 St/St
02	Simple 2 St/Hr
03	Simple 3 Cl/St
04	Simple 4 Cl/Hr
05	Simple 5 Tp/St
06	Simple 6 Tp/Hr
07	Simple 7 Ob/St
08	Simple 8 Ob/Bsn
09	Simple 9 Fl/St
10	Simple 10 Fl/Cl
11	Simple 11 Cl/Cl
12	Simple 12 Pf/Pf
13	Sound Effect 1
14	Sound Effect 2
15	Sound Effect 3
16	Sound Effect 4
17	Sound Effect 5
18	Sound Effect 6
19	Sound Effect 7
20	Sound Effect 8
21	Sound Effect 9
22	Sound Effect 10
23	Sound Effect 11
24	Sound Effect 12
25	Sound Effect 13
26	Sound Effect 14
27	Sound Effect 15
28	Sound Effect 16
29	Strings Combi.1
30	Strings Combi.2
31	Strings Combi.3
32	Strings Combi.4
33	Strings Combi.5
34	Strings Combi.6
35	Strings Combi.7
36	Strings Combi.8
37	Strings Combi.9
38	StringsCombi.10
39	StringsCombi.11
40	StringsCombi.12
41	StringsCombi.13
42	StringsCombi.14
43	StringsCombi.15
44	Brass Combi. 1
45	Brass Combi. 2
46	Brass Combi. 3
47	Brass Combi. 4
48	Brass Combi. 5

No.	Regist. Name
49	Brass Combi. 6
50	Brass Combi. 7
51	Brass Combi. 8
52	W.Wind Combi. 1
53	W.Wind Combi. 2
54	W.Wind Combi. 3
55	W.Wind Combi. 4
56	W.Wind Combi. 5
57	W.Wind Combi. 6
58	W.Wind Combi. 7
59	W.Wind Combi. 8
60	W.Wind Combi. 9
61	W.Wind Combi.10
62	W.Wind Combi.11
63	W.Wind Combi.12
64	W.Wind Combi.13
65	W.Wind Combi.14
66	W.Wind Combi.15
67	W.Wind Combi.16
68	W.Wind Combi.17
69	Decay 1
70	Decay 2
71	Decay 3
72	Decay 4
73	Decay 5
74	Decay 6
75	Decay 7
76	Sustained 1
77	Sustained 2
78	Sustained 3
79	Sustained 4
80	Synth. 1
81	Synth. 2
82	Synth. 3
83	Synth. 4
84	Synth. 5
85	Comping 1
86	Comping 2
87	Comping 3
88	Comping 4
89	Comping 5
90	Comping 6

3 Using the LCD display

Many of the Electone's operations are done from the LCD display. Pressing a button on the panel automatically calls up the relevant function for the corresponding button in the display. Depending on the display that appears, you can conveniently perform various functions and change values/settings by using the [A] – [D] buttons (located at either side of the LCD) and the DATA CONTROL dial (at the right of the LCD).

LCD Display and LCD Buttons

The functions of the [A] – [D] buttons differ depending on the selected display. Keep in mind that three types of indicators are used with the functions and parameters: a flashing indicator (◀ or ▶) a continuously lit indicator (◀ or ▶) and a square on/off indicator (■ or □).

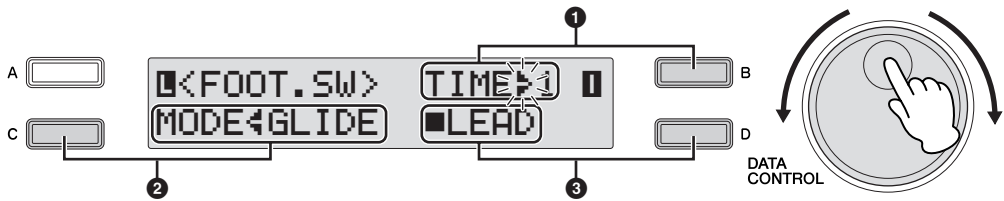

1 Flashing indicator (◀ or ▶)

When the indicator at an item is flashing, you can directly select the item or parameter (in this case, “Time”) by turning the DATA CONTROL dial clockwise. (When the final item is reached, turning the DATA CONTROL dial clockwise does not “wrap around” to the first item.) Turning the DATA CONTROL dial counter-clockwise selects in the reverse order. (Similarly, when the first item is reached, turning the DATA CONTROL dial clockwise does not “wrap around” to the last item.) Also, you can change the desired value/setting by successively pressing the corresponding [A] –[D] button (in this case, the [B] button). The value or setting changes (in steps) each time the button is pressed.

2 Continuously lit indicator (◀ or ▶)

This indicates that the corresponding item/parameter is not currently selected for change. When the ◀/▶ indicator at an item is continuously lit, pressing the corresponding [A] – [D] button (in this case, the [C] button, corresponding to the Mode setting) switches to a flashing indicator, letting you change value/setting with the DATA CONTROL dial. Also, you can change the desired value/setting by successively pressing the corresponding [A] – [D] button (in this case, the [C] button).

3 On/off indicator (■ or □)

A solid square (■) next to an item indicates that the corresponding function (in this case, “Lead”) is on.
 A hollow square (□) indicates that the function is off. Pressing the [A] – [D] button corresponding to the desired item or parameter (in this case, the [D] button) alternates between On and Off.

Changing the Display Page

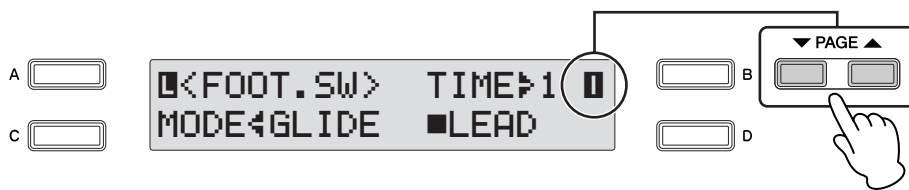

PAGE buttons are used to select the various ‘pages’ of the display (when available), with the currently selected page number appearing in highlight at the top right of the LCD. Use the PAGE [▲] button to select the next page, and PAGE [▼] to select the previous page.

Simultaneously pressing both buttons selects Page 1.

Selecting a Voice or Rhythm

- 1 Press the desired Voice/Rhythm button on the panel (in this example, the [STRINGS] button in Upper Keyboard Voice 1).

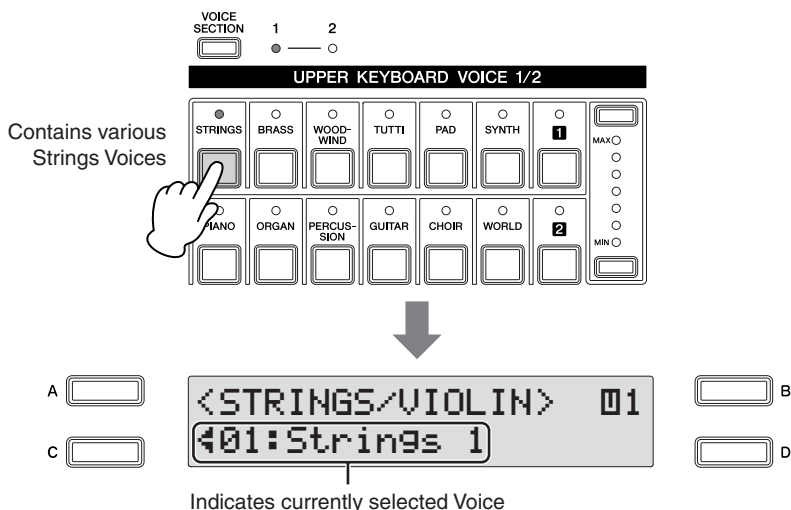

The selected Voice/Rhythm is shown in the display.

- 2 Select the desired Voice/Rhythm by turning the DATA CONTROL dial.



When the final item is reached, turning the DATA CONTROL dial clockwise does not “wrap around” to the first item. Similarly, when the first item is reached, turning the DATA CONTROL dial clockwise does not “wrap around” to the last item.

Selecting from a recommended set of Voices/Rhythms

The Electone has a huge amount of available Voices and Rhythms—so many that it may be difficult to find the ones you want. To help you find the best Voice/Rhythm for the selected instrument category, we've prepared some “recommended” or popular selections in that category. Simply press the [A], [B] or [D] button while the Voice/Rhythm menu is displayed to call up one of the recommended selections.

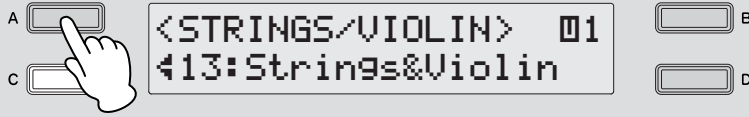

4 Basic Operation

Selecting the Display Language

The LCD display can be shown in two languages, English and Japanese. The default setting is English.

1 Press the [UTILITY] button on the panel.

The Utility display appears. The language can be set in the Utility display Page 1.

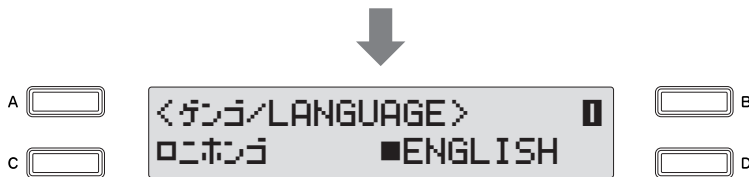
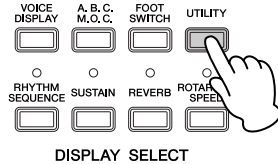

2 Press the [C] or [D] button to select the corresponding language: [C] for Japanese, or [D] for English.

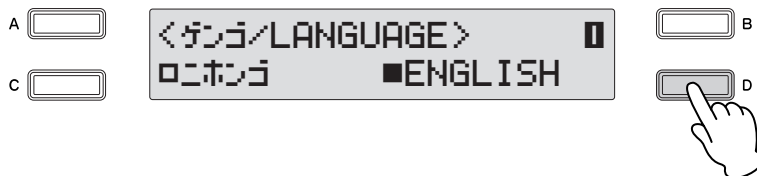

NOTE

The Language setting is not actually set for the instrument until you switch to another display. Make sure to switch to another display before turning the power off.

**Reference Page**Storing Registrations
(page 97)

Factory Set (Initializing the Electone)

All current settings including Registration Memory and LCD Display settings can be deleted at once by the following procedure. Be careful when executing Factory Set, since it erases all your existing data. Always save your important data to external media, such as a USB flash memory.

- 1 Turn off the power.
- 2 While holding down the ENDING [1] button, turn the power back on.

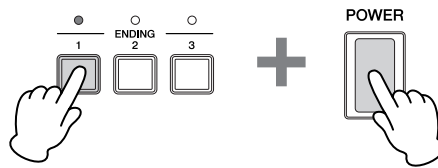

- 3 Release the ENDING [1] button after the Voice Display appears.

Confirming the Version of Your Electone

You can confirm the version of your Electone by the following procedure.

- 1 Press the [UTILITY] button.

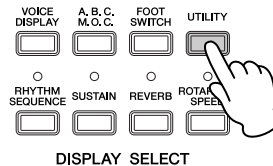

The Utility display appears.

- 2 Select Page 7 by using the PAGE buttons.
The Version appears in the display.

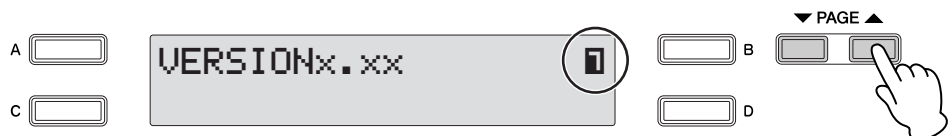

This Electone features hundreds of high quality Voices. Any of these Voices can be used on the Upper Keyboard, Lower Keyboard and Pedalboard. Up to three Voice sections are available on the Upper Keyboard for playing together in a layer, while the Lower Keyboard and Pedalboard each have two Voice sections.

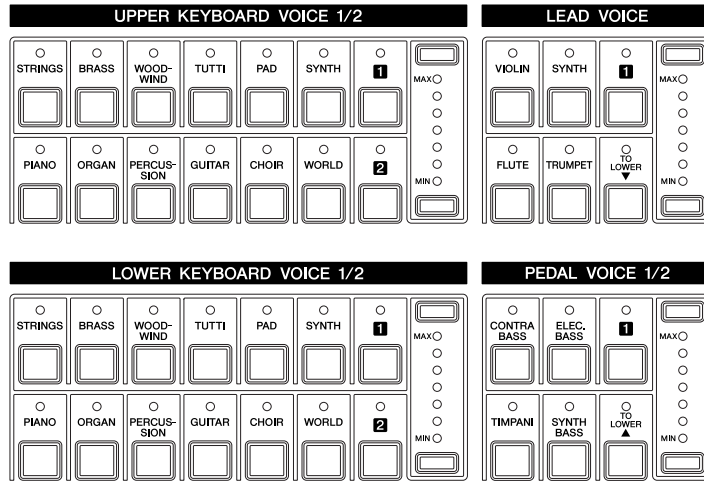

1 Voices for each keyboard

Voices for the Upper Keyboard

Up to three different Voice sections are available on the Upper Keyboard for playing together: Upper Keyboard Voice 1, Upper Keyboard Voice 2 and Lead Voice. Upper Keyboard Voice 1 and Upper Keyboard Voice 2 can be selected from the panel's Upper Keyboard Voice 1/2 section, while the Lead Voice is selected from the Lead Voice section.

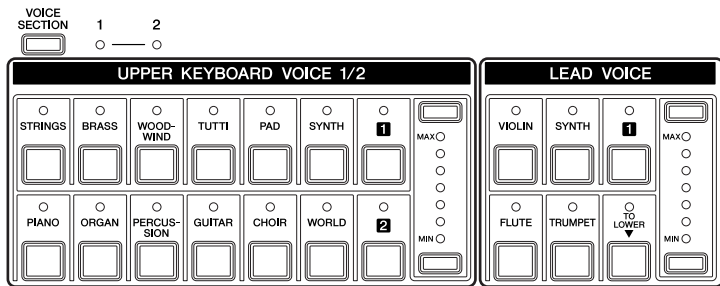

Voices for the Upper Keyboard 1 and Upper Keyboard 2

Voices for the Lead Voice



Reference Page

Switching between Voice section 1 and Voice section 2 (page 29)



Reference Page

Selecting Voices for Voice Section 2 (page 30)

The Lead Voice sounds only the highest note (or last note played) if two or more keys are played together. This makes the Lead Voices ideal for solo instruments such as Trumpet and Saxophone—instruments that play the “leading” or highest part in an orchestra or band.

Voices for the Lower Keyboard

Up to two different Voice sections are available on the Lower Keyboard for playing together: Lower Keyboard Voice 1 and Lower Keyboard Voice 2. Voices for each section can be selected from the panel's Lower Keyboard Voice 1/2 section.

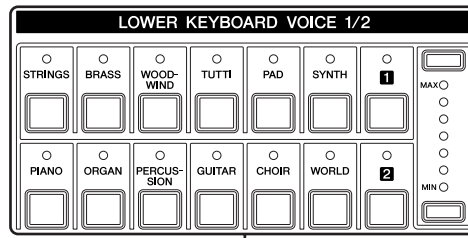

Voices for the Lower Keyboard 1 and Lower Keyboard 2

Voices for Pedalboard

Up to two different Voice sections are available on the Pedalboard for playing together: Pedal Voice 1 and Pedal Voice 2. Voices for each section can be selected from the panel's Pedal Voice 1/2 section. The Pedal Voice sounds one note at a time; when you simultaneously press two or more keys, only the highest note will sound.

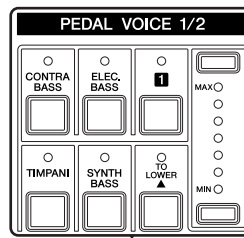

Voices for the Pedal Voice 1 and Pedal Voice 2

2 Voice Display

The Voice Display allows you to easily check which Voices are being used for each keyboard. It also allows you to set whether the Voice for each section sounds or not by changing the On/Off status in the display.



Reference Page

On/Off status of Voices
(page 28)

How to call up the Voice Display:

Pressing the [VOICE DISPLAY] button in the Display Select section selects the Voice Display. (The Voice Display always appears when the Electone is turned on.)

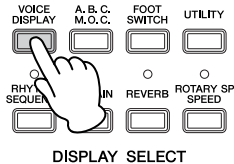

DISPLAY SELECT

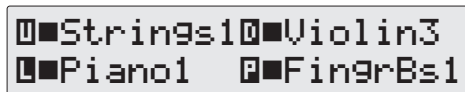

Each of the keyboards and Pedalboard have two basic Voice sections: Voice section 1 and Voice section 2. To select a Voice, you need to first select the desired Voice section. For this reason, the Voice Display actually has two separate displays: one for checking the Voice selected in Voice section 1, and the other for Voice section 2. To switch between the Voice sections, press the [VOICE SECTION] button at the top left on the panel.



Reference Page

Voices for each keyboard
(page 21)



Reference Page

Switching between Voice section 1 and Voice section 2
(page 29)

Successive presses of the [VOICE SECTION] button at the top left on the panel alternate between the two displays.

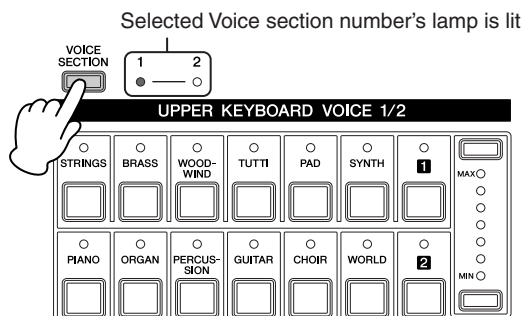

When the Voice section [1] lights up

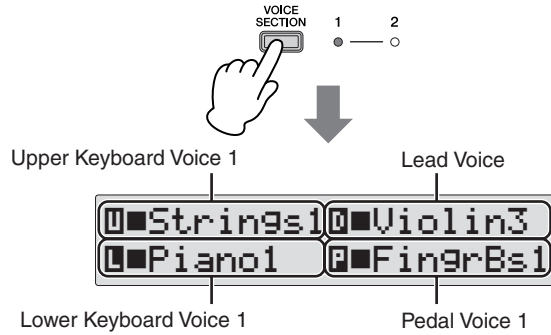

From this display, you can check which Voices have been selected for Voice section 1 on each keyboard (Upper Keyboard Voice 1, Lower Keyboard Voice 1 and Pedal Voice 1). The Lead Voice, which only has one section, is shown only in the Voice section 1 display.

When the Voice section [2] lights up

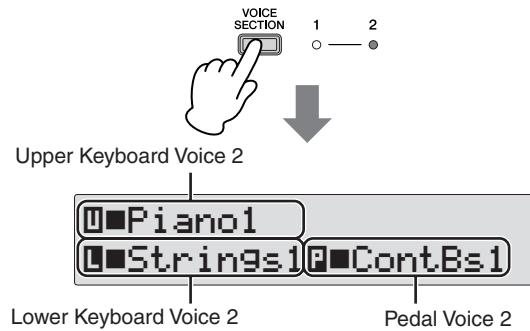

From this display, you can check which Voices have been selected for Voice section 2 on each keyboard (Upper Keyboard Voice 2, Lower Keyboard Voice 2 and Pedal Voice 2). The Lead Voice is not shown in this display.

3 Selecting Voices with the Voice buttons

Selecting Voices for Voice section 1

Since selection of Voices follows the same procedure throughout all Voice sections (except Lead Voice), instructions for only the Upper Keyboard Voice 1 of the Voice section 1 are given here. For details on how to select a Voice of Voice section 2, see page 30.

1 Make sure that the lamp of the Voice section [1] is lit.

If the Voice section [2] lamp is lit instead, press the [VOICE SECTION] button so that Voice section [1] lights.

Indicates that you can select a Voice for Voice section 1
(in this case, Upper Keyboard Voice 1)

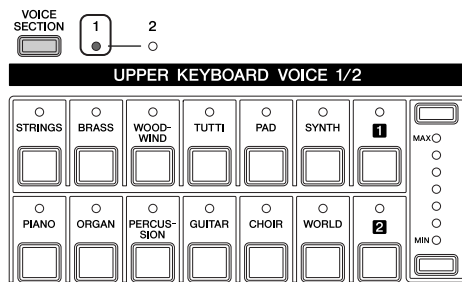

When the Voice section [1] lamp is lit, you can select a Voice for Voice section 1 (in this case, the Upper Keyboard Voice 1), from the panel's Upper Keyboard Voice 1/2 section.

The Lead Voice can be selected regardless of whether Voice section [1] or Voice section [2] is lit.



Reference Page

Switching between Voice section 1 and Voice section 2 (page 29)

2 Press one of the Voice buttons in the Upper Keyboard Voice 1/2 section.

For example, if you have pressed the [ORGAN] button, the following display (Voice Menu) will appear.

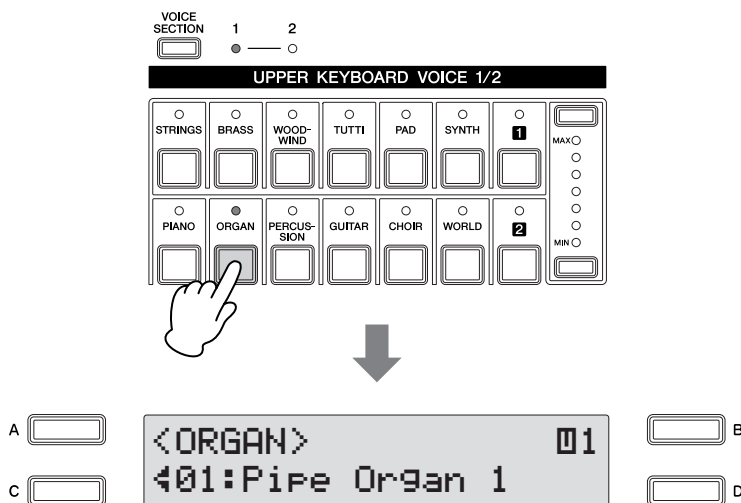

HINT

You can select the ideal Voice by simply pressing the [A]/ [B]/ [D] buttons when the Voice menu is displayed. Each Voice button has so many Voices that this function helps you selecting the Voices.

The Voice menu contains many Organ Voices, and only the currently selected Organ Voice appears in the display.

3 Select the Voice in the Voice Menu display.

You can select other “hidden” Organ Voices in sequence by turning the DATA CONTROL dial clockwise. Turning the DATA CONTROL dial counter-clockwise selects in the reverse order.

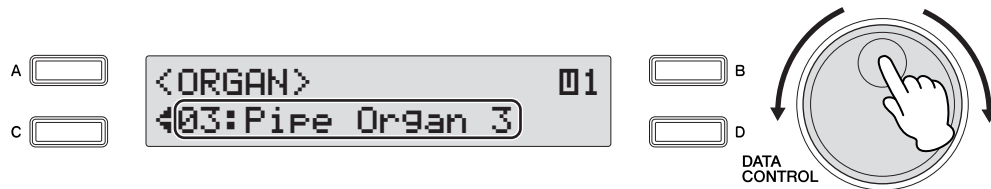

Here we’ve selected Pipe Organ 3 for Upper Keyboard Voice 1.

You can also select other Voices in the Voice Menu display by pressing the [C] button (once or repeatedly). Each press of the [C] button selects another hidden Voice. If you press the [C] button when the last voice is shown, selection “wraps around” back to the first voice.

Now go on to select voices for the Lower keyboard and Pedalboard as you did for the Upper keyboard above.

Adjusting the Voice volume

There are two ways to set the Voice volume: using the Volume buttons on the panel and setting the volume in the display. The Volume buttons let you make coarse adjustments to the volume while the setting in the display gives you fine control.

Using the VOLUME buttons on the panel (coarse)

Press one of the Volume buttons of each Voice section on the panel to set the desired level for each Voice. The controls have seven volume settings, from a minimum of 0, or no sound, to a maximum of full volume.

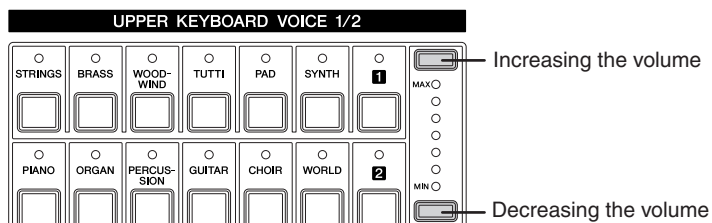

Setting the Volume in the display (fine)

Pressing the same Voice button on the panel again after selecting the Voice calls up the Voice Condition display. The Volume is displayed in the top left of the Voice Condition display Page 1. You can change the Volume by using the DATA CONTROL dial when the arrow indicator (“←” or “→”) next to the Volume value is flashing. If the arrow indicator is not flashing, press one of the [A] – [D] buttons corresponding to the item or parameter you want to change to make the indicator flash, then use the DATA CONTROL dial to select the desired control setting. The range of the Fine volume control is 0 – 24.



NOTE

Depending on the volume value (set in the display), two adjacent Volume button lamps may be lit at the same time, indicating an intermediate position.



Reference Page

Selecting from the Voice Condition display (page 41)

Voice Condition Display



Pressing a Voice button once calls up the Voice Menu display for the selected button. Pressing it a second time calls up the Voice Condition display. Successive presses alternate between the two displays.

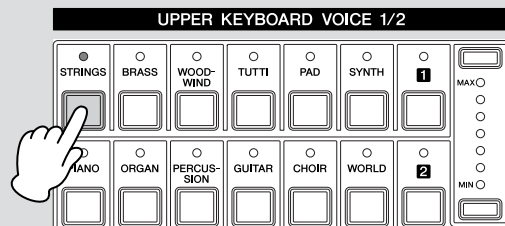

From the Voice Condition display, you can control Voice-related parameters such as Pan, Effect, Volume, and so on. For more information on the Voice Condition display, see page 41.

 **Reference Page**
Voice Display (page 23)

On/Off status of Voices

You can set the whether the Voice sounds or not by setting the On/Off status in the Voice display. To call up the Voice display, press the [VOICE DISPLAY] button.

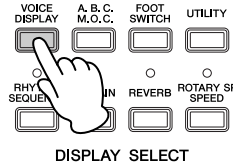

Voice Display (Voice section [1] lit)

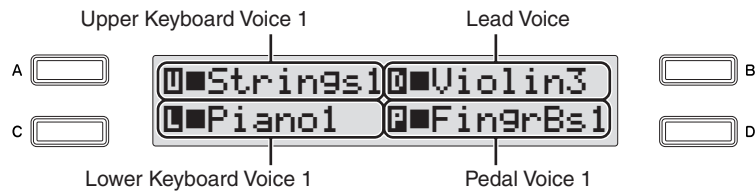

Two different displays are available, depending on whether Voice section 1 or Voice section 2 is lit. The instructions below use Voice section 1 as an example; however, the method for changing the On/Off setting is same in both Voice section 1 and Voice section 2.

On/Off settings:

Press the [A] – [D] buttons corresponding to the items or parameters you want to change to alternate between On and Off. Selecting Off effectively mutes the sound of the corresponding Voice, even when the keys are played.

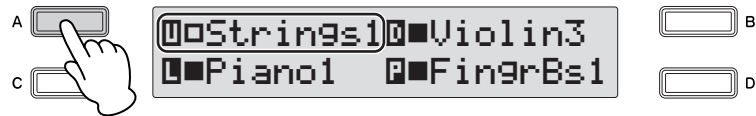

Setting this to Off results in a Volume value of 0. If you increase the Volume by using the Volume buttons, the On/Off status here changes to On.

The On/Off status for other Voices can be set in the other Voice Displays.

3 Selecting a Voice for Voice section 2

This feature lets you blend two Voices together—Voice section 1 with a different Voice in Voice section 2. This is useful for creating rich textures in the sound, playing the two Voices in a layer. For details on how to select a Voice for Voice section 1, see page 25. The instructions below explain how to selecting a Voice (Upper Keyboard Voice 2) for Voice section 2.

Switching between Voice section 1 and Voice section 2

To switch between Voice section 1 and Voice section 2, press the [VOICE SECTION] button on the panel.

For the Voice section which is indicated as “xxx Voice 1/2” (Voice section name is written in xxx) on the panel, you can select the Voice from each section by switching between sections 1 and 2 by pressing the [VOICE SECTION] button.



NOTE

Switching between Voice sections 1 and 2 has no effect on which Voice is sounded by the keyboard.

[VOICE SECTION] button

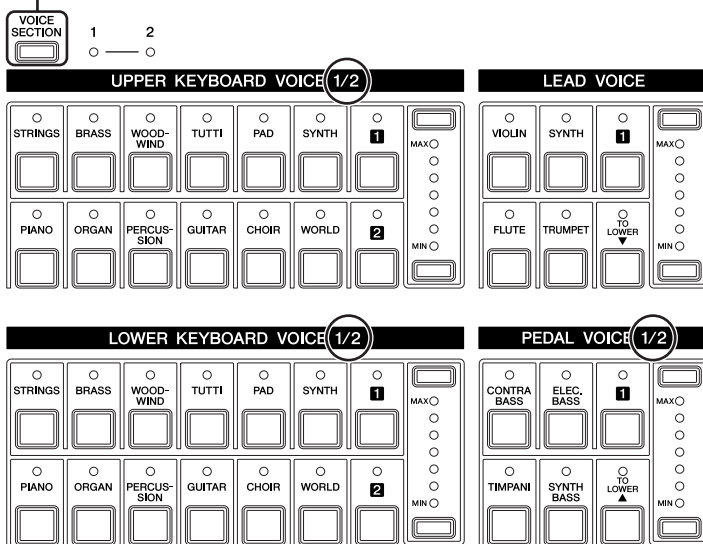

Each press of the [VOICE SECTION] button alternates between the available Voice sections 1 and 2. The lamp of the selected (available) Voice section number lights up.

When Voice section [1] is lit

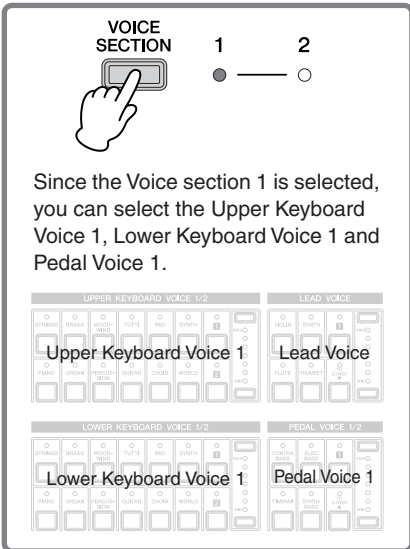

When Voice section [2] is lit

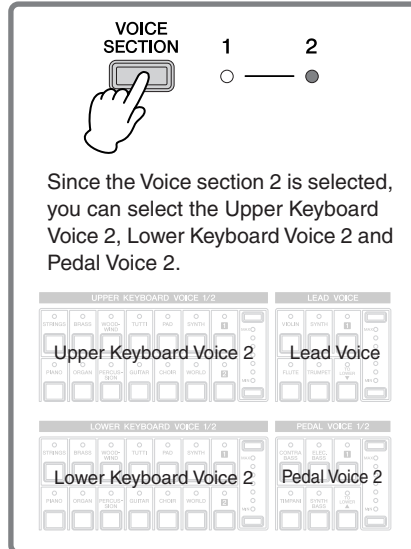

Selecting Voices for Voice Section 2

Since selection of Voices for Voice section 2 follows the same procedure throughout all Keyboard sections, instructions for only the Upper Keyboard, Upper Keyboard Voice 2, are given here.

1 Make sure that the lamp of Voice section [2] is lit.

If the Voice section [1] lamp is lit instead, press the [VOICE SECTION] button so that Voice section [2] lights.

Indicates that you can select a Voice for Voice section 2 (in this case, Upper Keyboard Voice 2)

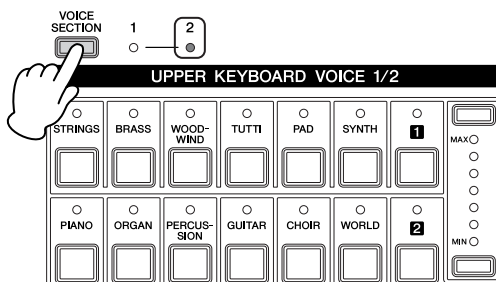

2 Press one of the Voice buttons in the Upper Keyboard Voice 1/2 section.

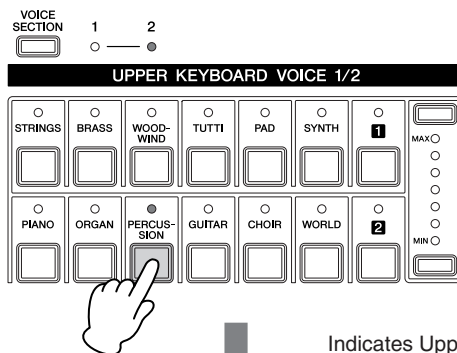

Indicates Upper Keyboard Voice 2 is selected.

NOTE

Once calling up the Voice Menu display, it has no change even when you switch the Voice section 1 or 2.

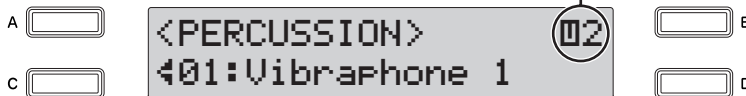

3 Select the Voices you want to play by using the DATA CONTROL dial.

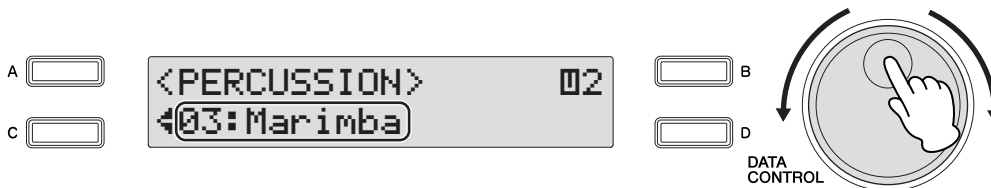

4 Press one of the Volume buttons of the Upper Keyboard Voice 1/2 section on the panel to increase the Volume level for the Upper Keyboard Voice 2.

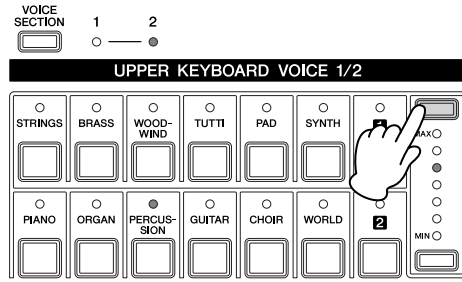

Since the default Volume level for Voice section 2 is set to minimum, the Upper Keyboard Voice 2, Lower Keyboard Voice 2 and Pedal Voice 2 will produce no sound even after you select the Voices for Voice section 2. To play the Voices for Voice section 2, make sure to press the Volume buttons of the selected Voice 1/2 section on the panel to increase the Volume level. When the lamp of the Voice section [2] is lit, the Volume buttons of the Voice sections (except the Lead Voice) can be used to set the Volume level specifically for Voice section 2.

Now set the Voices for Lower keyboard Voice 2 and Pedal Voice 2 as you did for Upper keyboard Voice 2 above.

If you want to turn off the Voices of Voice section 2, set the volume level to minimum by using the Volume buttons of the selected Voice sections on the panel, or select the Off status in the Voice Display when the lamp of the Voice section [2] is lit.

 **Reference Page**
On/Off status of Voices (page 28)

About the To Lower function

Voices selected for the Lead Voice, Pedal Voice 1, and Pedal Voice 2 sections can also be played on the Lower Keyboard when the [TO LOWER] button in each section is on.

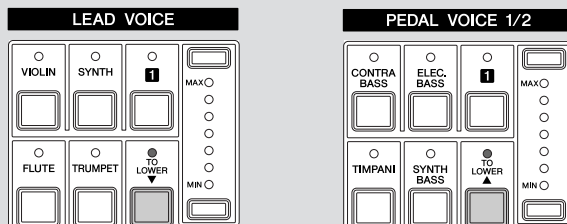

Keep in mind that when [TO LOWER] is on, the Lead Voice and Pedal Voice cannot be played on the Upper Keyboard and Pedalboard, respectively. Also, Initial Touch is not effective on Pedal Voices played on the Lower Keyboard.

4 Selecting Voices from the User buttons

This Electone has a variety of Voices from which you can choose—greater than what is immediately apparent from the front panel controls. You’ve already learned (in “Selecting Voices with the Voice buttons” above) how to select different Voices that are available in the Voice Menu display of each panel voice.

The Electone also has User buttons in each voice section, giving you access to even more voices. These User buttons function as ‘wild card’ Voice Menu selectors; any internal voices can be selected from these buttons.

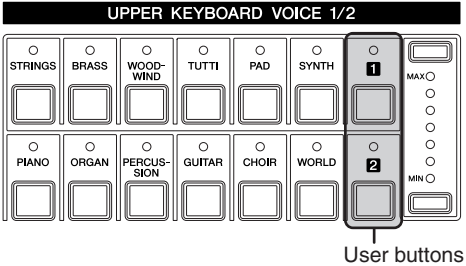

The User buttons have two basic uses:

- For playing any Voice of the Voice Menus from any of the keyboards or Pedalboard. You can play on the Upper Keyboard, for example, Voices from the sixteen Voice Menu pages (including the four Voice Menu pages of the Pedal Voice section), and not be limited to only the twelve buttons (equivalent to twelve Voice Menu pages) that make up the Upper Voice section.
- For having two different Voices from the same Voice Menu page available for selection in the same song. For example, you can assign one of the Voices to a User button in the Upper Keyboard Voice 1/2 section, the second Voice to the other User button in the same section.

For example, select Bell Pad 3 for User button [1] in Upper Keyboard Voice 1.

1 Make sure that the lamp of Voice section [1] is lit.

If the Voice section [2] lamp is lit instead, press the [VOICE SECTION] button so that Voice section [1] lights.

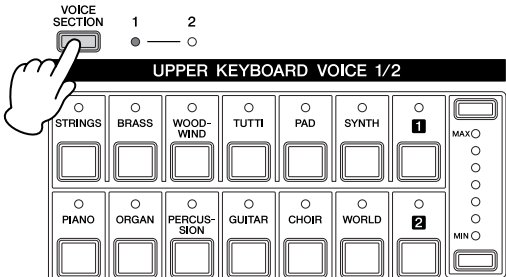

- 2 Press one of the User buttons in any of the Voice sections.**
The name of the selected category (Woodwind/Flute) is displayed.

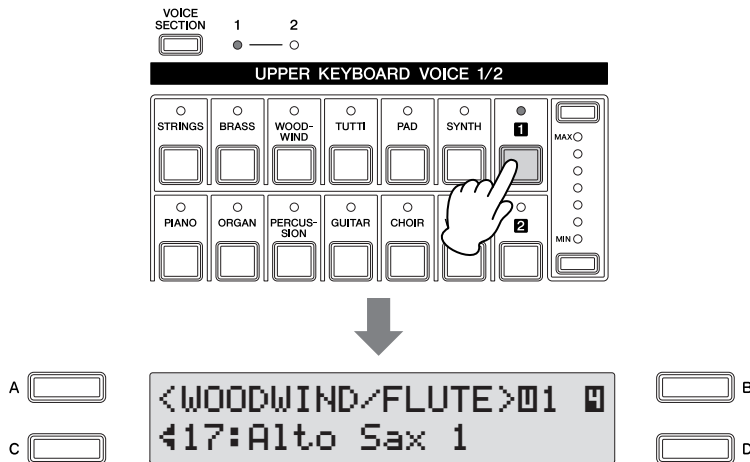

- 3 Select one of the sixteen Pages (categories) with the PAGE buttons (in this case, “Pad,” Page 7).**

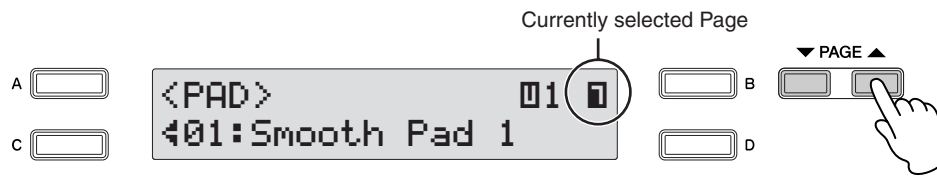

Directly selecting the category

To directly select the desired category, hold down one of the User buttons and simultaneously press the desired Voice button.

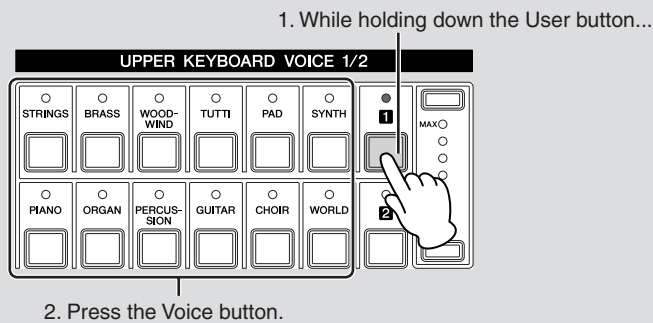

- 4 Select Bell Pad 3 by using the DATA CONTROL dial.**
Now you’ve assigned Bell Pad 3 to be called up by User button [1] in Upper Keyboard Voice 1. You can set voices to the User buttons in any other Voice sections just as you did for Upper keyboard Voice 1 above.

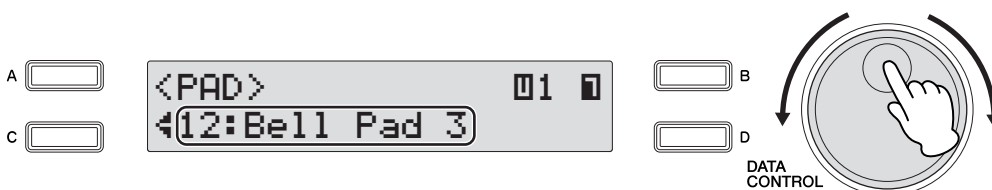

6 Voice List

The letters A, B and D printed at the right side of each Voice name in this list indicate the corresponding DATA CONTROL button's name. Pressing that button selects the corresponding Voice.

Category	Voice Name			Description	
STRINGS/VIOLIN	01	Strings 1		These voices feature string ensemble sounds, with accurate simulation of all string instruments, including contrabass, cello, viola and violin. Variations include light plucking sounds, bow scratching noises and deep resonant sounds.	
	02	Strings 2			
	03	Strings 3			
	04	Strings 4			
	05	Strings 5			
	06	Chamber Strs 1		Strings ensemble for chamber music.	
	07	Chamber Strs 2			
	08	Pizzicato Strs 1	A	The sound of stringed instruments being plucked instead of bowed.	
	09	Pizzicato Strs 2			
	10	Tremolo Strings		Tremolo strings.	
	11	Strings1&5		Combination of Strings 1 and Strings 5.	
	12	Strings&Viola		Combination of Strings 2 and Viola.	
	13	Strings&Violin	B	Combination of Strings 5 and Violin 3 with deep vibrato.	
	14	Violin&Cello		String ensemble consisting of Violin 3 and Cello.	
	15	Octave Strings		Strings ensemble sound with octave unison voices playable from a single key.	
	16	Violin 1	D	Deeply expressive sounds, suitable not only for classical music but also jazz and country & western. Tonal variations include bright voices and soft ones.	
	17	Violin 2			
	18	Violin 3			
		19	Viola		Slightly larger (and deeper) than a violin. Used for mid-range parts.
		20	Cello		Warm and deep sounds.
		21	Pizzicato Violin		Violin sound played by plucking.
CONTRABASS	01	Contrabass 1	A	Used for the lowest pitched parts. Variations range from deep to solo-type sounds.	
	02	Contrabass 2			
	03	Contrabass 3			
	04	Acoustic Bass	B	Acoustic bass sound ideal for jazz. This instrument goes by many different names, including "standup bass" and "upright bass."	
	05	Pizzicato Bass	D	Contrabass sound played by plucking.	
BRASS/TRUMPET	01	Brass Section 1		Trumpet-based brass section. Variations include sounds for classical, big band and other music.	
	02	Brass Section 2	A		
	03	Brass Section 3			
	04	Brass Section 4			
	05	Trombone Sec 1		Trombone brass section. Variations include a deep sound for classical music and a sweet, smooth sound for jazz ballads.	
	06	Trombone Sec 2			
	07	Brass&Trp 1		Combination of Brass Section 1 and Trumpet 4.	
	08	Brass&Trp 2		Combination of Brass Section 2 and Trumpet 4.	
	09	Horn 1&3		Combination of Horn 1 and Horn 3.	
	10	Octave Brass 1		Octave brass with variations. Features rich variations from strong, dynamic impact voices with quick attack, to soft, warm voices that enrich the overall sound.	
	11	Octave Brass 2			
	12	Octave Brass 3			
	13	Octave Brass 4			
	14	Trumpet 1	B	Bright, multi-purpose trumpet sounds.	
	15	Trumpet 2			
	16	Trumpet 3			
	17	Trumpet 4			

Category	Voice Name		Description	
BRASS/TRUMPET	18	Muted Trumpet	This recreates the distinctive sound that results when a mute is inserted in the bell of trumpet. The normal "blasting" sound of the trumpet is suppressed, and the resulting sound is thin and metallic.	
	19	Flugel Horn	A brass instrument with a characteristically warm and soft sound.	
	20	Trombone 1	The slide trombone has a distinctive "stretching" and "shrinking" sound and features a wide range of expressional power, from brilliant and strong to soft and sweet.	
	21	Trombone 2		
	22	Trombone 3		
	23	Muted Trombone	A mute effect makes the volume softer and alters the characteristics of this trombone voice.	
	24	Horn 1	D	These voices are all recreations of horns with coiled tubing, and feature a soft, mellow sound. The voices are indispensable for orchestra and brass band since they blend well with virtually any instrument sound, woodwind or brass.
	25	Horn 2		
	26	Horn 3		
	27	Horn 4		
	28	Muted Horn	This horn has a sound that is made sharp and metallic by using a mute, and is even capable of mimicking the sound of a human voice.	
	29	Tuba	This instrument is meant to be played in the lower octaves and has a rich, stable sound that supports brass band and orchestra. It has a wide expressive range, and is often used in playing humorous phrases.	
	30	Euphonium	Features a characteristically broad and deep—even noble—sound, and is frequently used as a solo instrument.	
	31	Brass Bass 1	Brass ensemble for playing in the lower octaves. Brass Bass 2 also has a timpani sound in unison.	
32	Brass Bass 2			
WOODWIND/ FLUTE	01	Flute 1	A	A light and transparent instrument voice that sounds like a bird singing. This instrument is equally good for both fast, quickly executed passages and smooth melodies.
	02	Flute 2		
	03	Flute 3		
	04	Piccolo	This instrument is one octave higher than flute and is meant to be played in the higher octaves.	
	05	Recorder	This basic flute instrument is used in grade school music classes, and can be heard in some medieval and baroque music. It has a relatively hard and round sound.	
	06	Ocarina	This instrument has a long history and features a simple, warm sound. The pitch and the sound quality are changed by the strength of the breath.	
	07	Whistle	Recreation of a human whistling sound.	
	08	Clarinet 1	B	This instrument has a wide sound range and distinctive character—with rich sound in the low end and crisp, bright tones in the high. It is used extensively in a variety of music styles including classical chamber music and swing jazz.
	09	Clarinet 2		
	10	Clarinet 3		
	11	Bass Clarinet	This instrument has a thick, deep voice and is played one octave lower than the normal clarinet.	
	12	Oboe 1	D	An instrument of the woodwind double reed family, this has a high, reedy, sometimes nasal tone—yet it is also rich and warm, and can handle a wide range of expression and emotion.
	13	Oboe 2		
	14	English Horn	Also known as "cor anglais," this is larger than the oboe, and its timbre is well-suited to performance of expressive, melancholic solos in slow orchestral pieces.	
	15	Bassoon 1	This belongs to the double reed family and is used in the lower range. It is known for its humorous, expressive character as well as its wide range and agility, and can also be used as a solo instrument. It is also called "fagott," from the German word meaning "bundle of sticks."	
	16	Bassoon 2		
	17	Alto Sax 1	Among the woodwind instruments, this is capable of the loudest sound, and plays a highly prominent role. Its wide expressional power makes it ideal for both classical music and jazz.	
	18	Alto Sax 2		
	19	Tenor Sax 1	This voice is active in a wide range of genres, including classical and jazz. It is often used in soul and R&B music, or in slow, moody pieces.	
	20	Tenor Sax 2		
	21	Soprano Sax 1	Features a characteristic high, 'stretching' sound, perfect for legato phrasing and sweet, emotional passages.	
	22	Baritone Sax	Soft and low baritone sax sound, also used in R&B music.	
	23	Sax Ens 1	Saxophone ensemble with variations, such as mellow sounds for classical and sax section for big band.	
	24	Sax Ens 2		
	25	Woodwind Ens 1	Woodwind ensemble sound that varies the instrument depending on the register played.	
	26	Woodwind Ens 2		

Category	Voice Name			Description
TUTTI	01	Strings&Winds	A	Unison strings and woodwind ensemble.
	02	Strings&Brass	B	Unison strings and brass ensemble.
	03	Strings&Horn	D	Strings and horn ensemble.
	04	Brass&Sax 1		Brass and sax tutti.
	05	Brass&Sax 2		
	06	Brass&Winds		Brass and woodwind tutti.
	07	Orchestra Hit		A popular, widely used sampled sound in which the many instruments of the orchestra play together on one chord or note. Used for dramatic hits and accents.
CHOIR	01	Choir 1		Vocal chorus sound. Variations include a male "ooh" sound, female "ahh," and mixed choirs.
	02	Choir 2		
	03	Choir 3	A	
	04	Choir 4	B	
	05	Choir 5	D	
	06	Choir 6		
	07	Vocal		Solo human voice singing "ahh."
PAD	01	Smooth Pad 1	A	These continuous, sustained synth sounds feature a smooth, warm character that help support the other voices in a passage, and often serve as transition sounds.
	02	Smooth Pad 2		
	03	Smooth Pad 3		
	04	Smooth Pad 4		
	05	Resonance Pad 1		These voices have more of unique character and distinctiveness than the other synth pads, and feature sweeping filter effects and other dynamic sound variations when held.
	06	Resonance Pad 2		
	07	Resonance Pad 3		
	08	Resonance Pad 4	B	
	09	Resonance Pad 5		
	10	Bell Pad 1	D	These continuous pad voices feature gentle, bell sounds. There are several types of voices here—including an initial bell sound, as a bright bell that pulses softly and continuously.
	11	Bell Pad 2		
	12	Bell Pad 3		
	13	Bell Pad 4		
	14	Bell Pad 5		
	15	Space Pad 1		This pad features a mysterious, spacey sound.
	16	Space Pad 2		
	17	Space Pad 3		
	18	Space Pad 4		
	19	Noisy Pad 1		Bright, buzzy continuous synth sound with soft pad.
	20	Noisy Pad 2		
	21	Noisy Pad 3		
	22	Noisy Pad 4		
SYNTH	01	Synth Lead 1	A	These special synth sounds are designed for solo parts and lead lines. Included is a synth voice that has a strong layered fourth interval below the main pitch.
	02	Synth Lead 2		
	03	Synth Lead 3		
	04	Synth Lead 4		
	05	Synth Lead 5		
	06	Synth Lead 6		
	07	Pop Lead 1		A light and round synth sound, appropriate for solos and leads.
	08	Pop Lead 2		
	09	Pop Lead 3		
	10	Pop Lead 4		
	11	Pop Lead 5		

Category	Voice Name		Description	
SYNTH	12	Synth Cla 1	A bright, round and fresh synth sound, reminiscent of the clarinet.	
	13	Synth Cla 2		
	14	Synth Cla 3		
	15	Synth Cla 4		
	16	Synth Brass 1	B	An abundant variety of synth brass voices, from conventional sounds and octave unisons to unique, comical sounds.
	17	Synth Brass 2		
	18	Synth Brass 3		
	19	Synth Brass 4		
	20	Synth Brass 5		
	21	Synth Brass 6		
	22	Synth Strs 1		Spacious synth strings sound.
	23	Synth Strs 2		
	24	Synth Strs 3		
	25	Synth Strs 4		
	26	Synth Bell 1		Synth sounds with variations including crisp, clangorous bright bell and soft, glassy sounds.
	27	Synth Bell 2	D	
	28	Synth Bell 3		
	29	Synth Bell 4		
30	Synth Decay		Unique decaying synth sound.	
ORGAN	01	Pipe Organ 1	A	The pipe organ has its roots in churches and cathedrals, and features a solemn, rich, majestic sound. The voices here range from soft to powerful.
	02	Pipe Organ 2		
	03	Pipe Organ 3		
	04	Harmonica 1	B	This instrument has a wide expressive range, and can be used for emotional, soft ballads and solos.
	05	Harmonica 2		
	06	Theatre Organ 1		This instrument evokes feelings of nostalgia, having been used extensively in silent movie theaters, skating rinks, restaurants (especially pizzerias) and baseball stadiums.
	07	Theatre Organ 2		
	08	Accordion 1	D	A versatile, multi-purpose instrument that has a home in a wide variety of genres, including French chanson, Argentinian tango, polka and Tex-Mex music.
	09	Accordion 2		
	10	Bandoneon		This musical instrument is often used for tango, and features a characteristic initial attack.
	11	Reed Organ		This is a small organ without pipes and features a warm sound.
	12	Jazz Organ 1		These electric organ sounds—great for jazz and R&B—are designed to be used with the rich rotary speaker effect.
	13	Jazz Organ 2		
	14	Jazz Organ 3		
	15	Pop Organ 1		Multi-purpose organ sounds.
	16	Pop Organ 2		
	17	Pop Organ 3		
	18	Rock Organ 1		Hard, overdriven, distorted organ sound, ideal for rock.
	19	Rock Organ 2		
	20	Organ Bass 1		Pipe organ bass and jazz organ bass sounds for lower register parts.
	21	Organ Bass 2		
	22	Organ Bass 3		
	23	Organ Bass 4		
PIANO	01	Piano 1	A	Multi-purpose piano sounds.
	02	Piano 2		
	03	Honkytonk Piano		Purposely out-of-tune piano sound, used in ragtime, older jazz and blues and country rock music.
	04	Harpsichord	B	The definitive instrument for baroque music. Since harpsichord uses plucked strings, there is no touch response. There is, however, a characteristic additional sound when the keys are released.

Category	Voice Name			Description	
PIANO	05	Clavichord		Soft keyboard instrument for classical music, with unique sound when keys are released.	
	06	DX E.Piano 1	D	Electric piano sounds from the popular DX-7 synthesizer.	
	07	DX E.Piano 2			
	08	Stage E.Piano 1		These electric piano voices feature the characteristic hammer and tine sound, with a bright yet warm feel. The #2 sound also has a tremolo effect.	
	09	Stage E.Piano 2			
	10	Stage E.Piano 3			
	11	Stage E.Piano 4			
		12	Stack E.Piano		This bright electric piano is characterized by its sharp attack sound.
		13	Clavi 1		Funky clavi.
		14	Clavi 2		
	GUITAR	01	Nylon Guitar	A	Acoustic guitar. Nylon string.
		02	Steel Guitar		Acoustic guitar. Steel string.
		03	12Str Guitar		12-string classic guitar with gorgeous sounds.
		04	Jazz Guitar		This soft electric guitar is good for jazz solo passages.
05		Harp 1	B	The gentle, beautiful sound of this instrument makes it ideal for soft passages, and is often played glissando for dramatic effect.	
06		Harp 2			
07		Elec Guitar 1	D	These electric guitar sounds include distortion and overdrive effects, as well as a clean electric guitar with realistic decay.	
08		Elec Guitar 2			
09		Elec Guitar 3			
		10	Muted Guitar		Muted guitar.
		11	Distortion Gtr 1		Distorted guitar.
		12	Distortion Gtr 2		
		13	Banjo		For country and dixieland jazz.
		14	Mandolin		This instrument is used in much Italian music and features a realistic plucked sound.
		15	Pedal Steel Gtr		Hawaiian guitar. Effective when used with the glide function.
PERCUSSION	01	Vibraphone 1	A	This percussion instrument utilizes resonators fitted with metal discs, which in turn are connected by rod to a motor—which produces the distinctive, warm tremolo effect heard in some jazz music.	
	02	Vibraphone 2			
	03	Marimba	B	This instrument is similar to the xylophone and has resonant tubes under the sound plates. However, the wooden keys give it a soft, more organic sound, and it has an especially rich lower register-giving it a wide expressive range and making it useful as a solo instrument.	
	04	Xylophone		Dry and tight sounds.	
	05	Glockenspiel 1		This is the sound of a small glockenspiel, and features a soft, shining sound.	
	06	Glockenspiel 2	D		
	07	Celesta		The celesta is similar in structure to the piano. Hammers move and hit metal bars (similar to the glockenspiel) when the keys are played, producing a pretty, somewhat fragile bell sound.	
	08	Music Box		Music box	
	09	Chime 1		Chime	
		10	Chime 2		
TIMPANI	01	Timpani	A	This dramatic sounding percussion instrument is unlike most drums in that it produces a definite pitch. It adds extra power and dynamic impact when played in unison with other instruments and plays a very important role in orchestral music.	
	02	Timpani Roll	B/D	Timpani played with a drum roll technique.	
ELECTRIC BASS	01	Fingered Bass 1	A	Electric bass played with fingers.	
	02	Fingered Bass 2			
	03	Fingered Bass 3			
	04	Slap Bass 1	B	Percussive, slapped bass sounds. These slap bass voices feature variations in the 'thickness' of the sounds and differences in how the strings are played.	
	05	Slap Bass 2			
	06	Slap Bass 3			
	07	Picked Bass 1		These electric bass voices feature the bright attack of playing with a pick, and have variations in the 'thickness' of the sounds.	
	08	Picked Bass 2	D		
	09	Fretless Bass		Smooth fretless bass. This fretless bass voice has a unique sound, and is best used with subtle, sliding pitch changes.	

Category	Voice Name			Description
SYNTH BASS	01	Funk Bass 1	A	Synth bass suitable for rock and blues.
	02	Funk Bass 2		
	03	Funk Bass 3		
	04	Dance Bass 1	B	Synth bass suitable for dance music.
	05	Dance Bass 2		
	06	Smooth Bass 1		Contemporary, "cool" synth bass sounds.
	07	Smooth Bass 2	D	
	08	Smooth Bass 3		
WORLD	01	Pan Flute	A	The panflute (also known as "pan pipes") is a simple instrument used in folk music of various countries, and consists of several stopped pipes of increasing length bound together in one line. It is a beautiful instrument that evokes the sound of wind in nature and is named after the Greek mythological god Pan.
	02	Bagpipe		A traditional Scottish instrument, usually played with a continuous, low drone. The sound can be melancholy as well dramatic and inspiring.
	03	Dulcimer		A characteristically clear and beautiful voice.
	04	Shakuhachi		Traditional Japanese recorder made of bamboo.
	05	Yokobue		Traditional Japanese flute.
	06	Shamisen	B	This traditional Japanese instrument features three strings and a small body covered with animal skin. The bright, slightly buzzy sound is similar to the banjo, yet has a very strong Oriental flavor.
	07	Koto		Japanese Koto.
	08	Taishokoto		Japanese Taisho Koto.
	09	Erhu	D	Also known as the "Chinese violin," this is a two-stringed bowed instrument, capable of producing sad, mysterious, or joyful melodies.
	10	Sheng		The Chinese sheng is a mouth-blown free reed instrument consisting of vertical tubes, and apparently inspired the invention of the harmonica, accordion and reed organ.
	11	Pipa		A Chinese lute with a pear-shaped body, it is used often for solo parts as well as accompaniment and ensemble.
	12	Sitar		Indian (or Hindustani) classical instrument with different resonances in the lower and mid/high ranges.
	13	Steel Drum		This pitched percussion instrument, originating in Trinidad in the West Indies, is made from 55-gallon oil drums and is apparently the only acoustic instrument invented in the 20th century. It has a bright and joyful tropical sound that belies its industrial source.
	14	Kalimba		African instrument.

Voice Controls and Effects

The Electone is equipped with two general kinds of functions that can be used to change the sound of the Voices: Voice Controls and Effects.

Each Voice has been given certain factory-preset effect settings to best enhance its sound. However, if you wish, you can change the sound to suit your preferences by using the controls and effects described in this section. All built-in effects are digital.

The chart below shows the various Voice controls and effects for the individual Voice sections. Available functions are indicated by circles. The controls and effects are applied differently according to the different types: independently for each Voice section, independently for each keyboard or globally for the entire system.

Controls and Effects			Reference page for changing the settings	Voice sections to which the controls/effects are applied			
				Upper Keyboard	Lead Voice	Lower Keyboard	Pedal board
				Upper Keyboard Voice 1, 2	Lead Voice	Lower Keyboard Voice 1, 2	Pedal board Voice 1, 2
Selecting from the Voice Condition display, Pages 1-6	Page 1	Volume	page 42	○	○	○	○
		Reverb (send level)	page 42	○	○	○	○
		Initial Touch	page 42	○	○	○	–
		Feet	page 42	○	○	○	○
	Page 2	Pan	page 43	○	○	○	○
		Tune	page 43	○	○	○	○
		Transpose	page 43	○	○	○	○
	Page 3	Vibrato	page 44	○	○	○	○
	Page 4/5	Reverb	page 45	○	○	○	○
		Delay	page 45	○	○	○	○
		Karaoke	page 45	○	○	○	○
		Chorus	page 45	○	○	○	○
		Flanger	page 45	○	○	○	○
		Phaser	page 45	○	○	○	○
		Tremolo/Auto Pan	page 45	○	○	○	○
		Rotary Speaker	page 45	○	○	○	○
		Distortion	page 45	○	○	○	○
		Wah	page 45	○	○	○	○
		Dynamic	page 45	○	○	○	○
		EQ/Enhancer	page 45	○	○	○	○
Page 6	Slide	page 47	–	○	–	–	
Selecting from the panel	Reverb	page 48	○				
	Sustain	page 49	○	–	○	○	
	Rotary Speaker	page 50	○	○	○	○	

1 Selecting from the Voice Condition display

To call up the Voice Condition display:

Choose a Voice on the panel, then press the same button on the panel again. The Voice Condition display appears.

Voice Condition Display

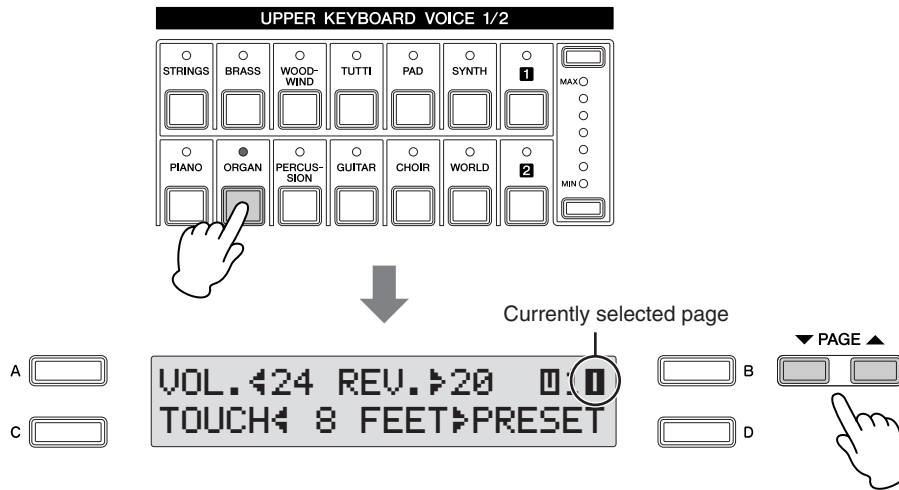

Each voice group's Voice Condition (except for Lead Voice) consists of five display pages. Voice Condition of the Lead Voice consists of six pages.

Setting and adjusting the parameters

You can change the items or parameters when the arrow indicator “<(>)” in the display is flashing. Press the [A] – [D] buttons corresponding to the items or parameters you want to change to make the indicator flash, then use the DATA CONTROL dial to select the desired control setting.

With the indicator flashing, you can also directly change the items or parameters by using the DATA CONTROL dial. For details, see “Using the LCD display” on page 17.



NOTE

After pressing one of the [A] – [D] buttons (to make the indicator flash), you can continue pressing the same button to change the item or parameter.

Voice Condition [Page 1]

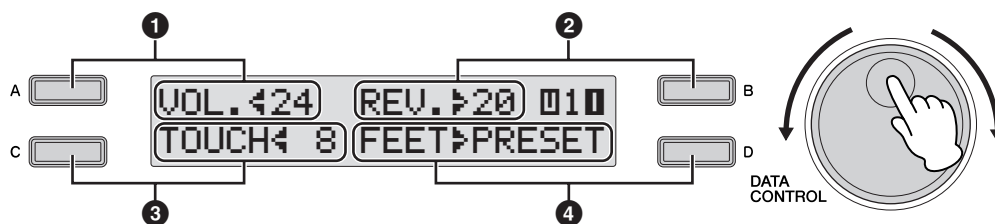

In this display, you can adjust the basic Voice controls, including panning, touch sensitivity and volume.

The items included in this page differ between the Pedal Voice sections and the other sections. Initial Touch is not applied to the Pedal Voices.

1 Volume

Fine adjustment of the Voice volume. See page 26 for more information.

2 Reverb

Determines the amount of reverb applied to each Voice section.

When the Reverb Depth setting in the Reverb display is set to the minimum, the setting here will have no effect. See page 48 for details.

Press the [B] button to make the “” indicator flash, then use the DATA CONTROL dial to change the setting.

3 Touch

Controls volume and timbre according to the velocity at which you play the keys. The harder you play the keys, the greater the volume and the brighter the timbre will become.

Higher settings make the change wider. The minimum setting produces no effect. This function is not applied to the Pedal Voices.

Press the [C] button to make the “” indicator flash, then use the DATA CONTROL dial to change the setting.

Range: 0 – 14

4 Feet

Determines the octave setting of the Voice, letting you use the Voice over a wide register. There are three settings: 4', 8' and 16' (4' is highest and 16' is lowest). A 2' setting is added to the Pedal Voice sections. Preset is the original (factory) setting.

Press the [D] button to make the “” indicator flash, then use the DATA CONTROL dial to change the setting.



Reference Page

Reverb (page 48)



NOTE

Initial Touch may not be effective on some Voices, such as Organ Voices.

Press the PAGE buttons to select Page 2.

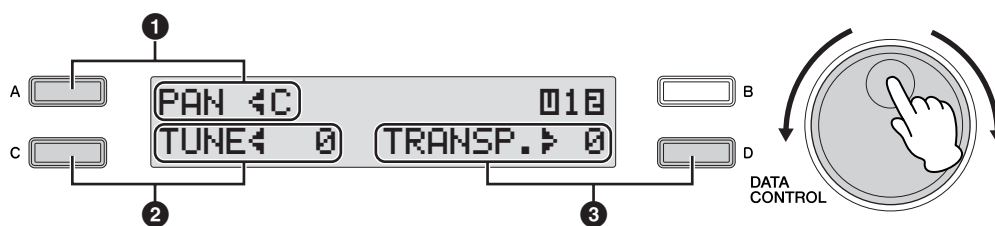

1 Panning

Determines the position of the Voice in the stereo image. Seven pan positions are available.

Press the [A] button to make the “” indicator flash, then use the DATA CONTROL dial to change the setting.

Range: L3 – C – R3

2 Tune

Determines the fine pitch settings for each Voice section, letting you create a warmer, richer sound by slightly detuning one Voice relative to another.

Press the [C] button to make the “” indicator flash, then use the DATA CONTROL dial to change the setting.

Range: -64 – +63



Reference Page

Pitch (for entire instrument); (page 150)

3 Transpose

Changes the pitch in semitones for each Voice section.

Press the [D] button to make the “” indicator flash, then use the DATA CONTROL dial to change the setting.

Range: -6 – +6



Reference Page

Transpose (for entire instrument); (page 150)

Press the PAGE buttons to select Page 3.



Vibrato

The Vibrato function varies the level of the Voices, making them sound warmer and more animated. This effect is applied independently to each Voice section. For some Voices, vibrato may not be effective at all or the effect may not sound as expected.

1 Preset/User

Each press of the [A] button toggles between Preset and User.

Selecting Preset calls up the original (factory) vibrato settings for the Voice.

When Preset is selected, the Delay, Depth and Speed parameters cannot be edited.

Selecting User lets you adjust the vibrato settings for yourself.

Vibrato Control

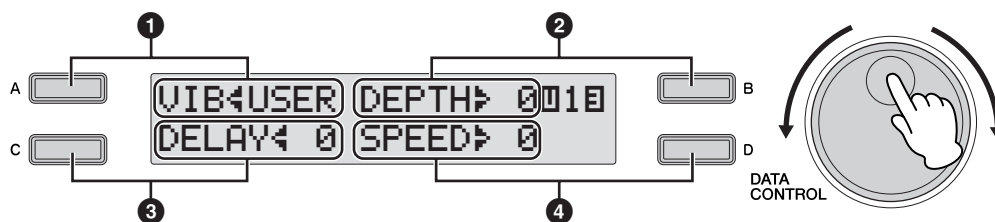
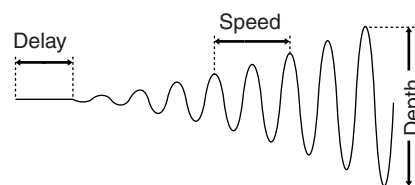

2 Depth

Determines the intensity of the vibrato effect. Higher settings result in a more pronounced vibrato. The minimum setting cancels the vibrato effect.

Press the [B] button to make the “▶” indicator flash, then use the DATA CONTROL dial to change the setting.

Range: 0 – 14

3 Delay

Determines the amount of time that elapses between the playing of a key and the start of the vibrato effect. Higher settings increase the delay of the vibrato onset.

Press the [C] button to make the “◀” indicator flash, then use the DATA CONTROL dial to change the setting.

Range: 0 – 14

4 Speed

Determines the speed of the vibrato effect. Higher settings increase the speed of the vibrato.

Press the [D] button to make the “▶” indicator flash, then use the DATA CONTROL dial to change the setting.

Range: 0 – 14

Press the PAGE buttons to select Page 4.

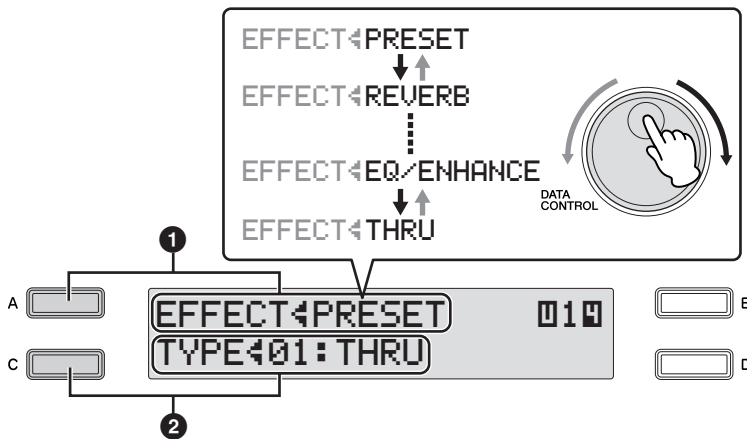

Effect

You can select the effects applied to each Voice section.

1 Effect Category

You can select the Effect Category applied to each Voice section.

Press the [A] button to make the “4” indicator flash, then you can select the Effect Categories in sequence: Preset → Reverb → Delay → ... → Dynamic → EQ/Enhancer → Thru by turning the DATA CONTROL dial clockwise. Turning the DATA CONTROL dial counter-clockwise selects in the reverse order.

PRESET	The effect type that best matches and is most suited to the currently selected sound is automatically selected.
REVERB	Produces a gentle “wash” of aftertones in the sound, recreating the subtle ambience and depth of actual performance spaces and rooms.
DELAY	Produces delayed distinct repeats of the sound, or echoes. This is also useful for creating rhythmic repeats in the sound.
KARAOKE	Produces a deep echo effect like that used in Karaoke sing-along applications.
CHORUS	Creates a warm effect as if several of the same sound were playing at once. Makes the overall sound richer, “fatter” and more animated.
FLANGER	This creates a metallic periodic “sweeping” effect, similar to Chorus but with a brighter more resonant sound.
PHASER	Similar to Flanger, this produces rolling timbre changes and a pronounced up/down filter sweep effect.
TREMOLO/ AUTO PAN	This periodically changes the volume and has the effect of moving the sound image both front and back, and left and right.
ROTARY SPEAKER	This popular effect (used mainly for electronic organ sounds) recreates the rich, animated pulsing sound of a rotating speaker horn.
DISTORTION	This effect adds distortion to the sound.
WAH	This uses an automatic up/down filter sweep to change the timbre of the sound, producing a “wah-wah” sound.
DYNAMIC	This effect (also called compression) “squeezes” the overall dynamic range of the sound, and has a gain control—letting you make soft sounds louder, and thus give more “punch” to the sound.
EQ/ENHANCER	EQ: This processing tool lets you change the level for specific frequency ranges in the sound, and affects the overall sound quality. Enhancer: This effect emphasizes and enhances the overtones in the high frequency sound range overtone—not merely making the sound brighter, but giving it more clarity and presence.
THRU	Bypass control. This cancels the effect processing.



Reference Page

Effect List (page 52)

When Preset is selected, the original (factory) effect category for the selected Voice is automatically set. Selecting Thru bypasses the effect (no effect is added to the selected Voice).

② Effect Type

Effect types are displayed corresponding to the selected effect category. Press the [C] button to make the “←” indicator flash, then use the DATA CONTROL dial to change the setting.

Voice Condition [Page 5]

Press the PAGE buttons to select Page 5.

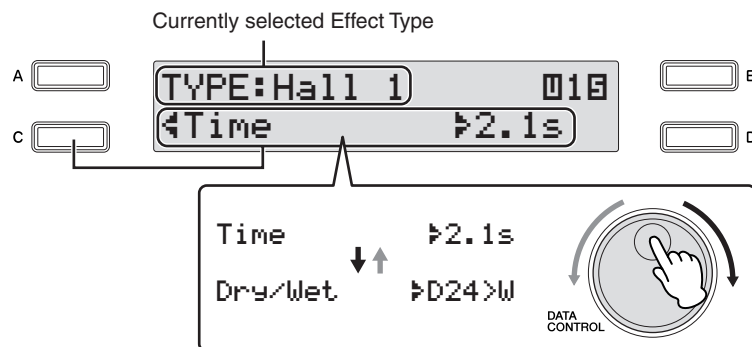

Effect Parameters

You can set the parameters of effect type selected in the Voice Condition display, Page 4. Generally, the effect parameters settings are automatically well-balanced to the selected effect type, so there is no need to follow the steps below unless you want to change the setting.

If you want to change the setting, select the parameter, then change the value. Since selection of Parameters and setting of value follow the same procedure throughout all Effect Type, instructions for only “Hall 1” of Reverb are given here. For details, see page 52.

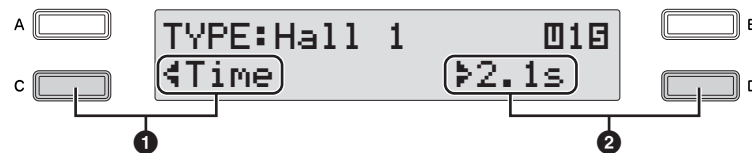

① Parameters

Effect parameters are displayed corresponding to the selected effect type. Press the [C] button to make the “←” indicator flash, then use the DATA CONTROL dial to select the parameters. In this case, the Time parameter is selected.

② Value setting

Press the [D] button to make the “▷” indicator flash, then use the DATA CONTROL dial to change the setting.

Voice Condition [Page 6] (only for Lead Voice)

Press the PAGE buttons to select Page 6.

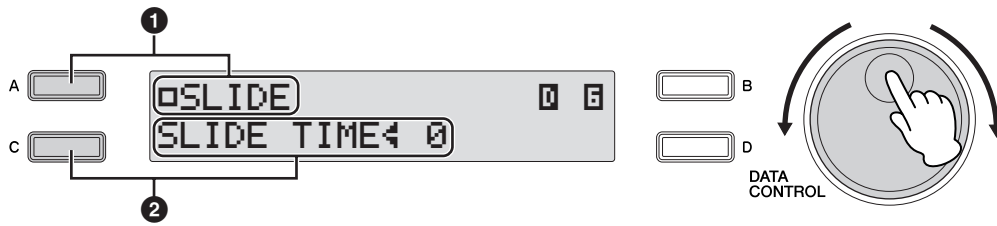

In this Page, determines whether or not the Slide function is applied to the Lead Voice.

Slide

Applies a portamento effect to notes played in legato. The Slide function is effective within a one-octave range for the Lead Voice.

① Slide On/Off

Determines the on/off status of the Slide effect.

Each press of the [A] button toggles between On and Off.

② Slide Time

Determines the speed of the slide or portamento effect. The higher the value, the slower the speed.

Press the [C] button to make the “4” indicator flash, then use the DATA CONTROL dial to change the setting.

Range: 0 – 14

2 Selecting from the panel

The Reverb, Sustain and Rotary Speaker displays are called up by pressing the respective buttons on the panel.

Reverb

Reverb adds an echo-like effect to the sound, giving the impression of a performance in a large room or concert hall. You can adjust the reverb volume for each Voice section or the entire system. Also, you can adjust the reverb volume for rhythm and accompaniment separately.

Call up the Reverb display to set the Reverb effect by pressing the [REVERB] button on the panel.



Reference Pages

Changing the rhythm volume/reverb (page 62)
Reverb (page 42)

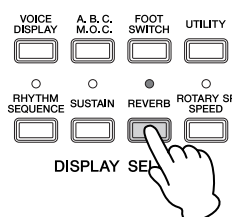

Each press of the [REVERB] button toggles between On and Off. When set to On, the lamp of the button lights up to indicate that Reverb is on.

Reverb Display

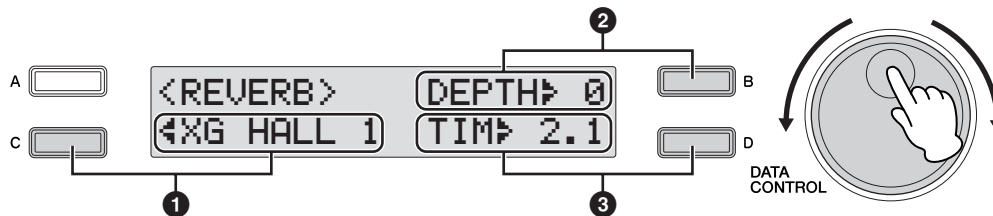

1 Type

Selects the Reverb Type.

Press the [C] button to make the “4” indicator flash, then use the DATA CONTROL dial to change the setting.

2 Depth

Determines the depth of reverberation or the level of the reflected sounds. This allows fine control over the depth. When this parameter is set to the minimum, the settings in Voice Condition display, Page 2 (page 43) have no effect.

Press the [B] button to make the “B” indicator flash, then use the DATA CONTROL dial to change the setting.

Range: 0 - 24

3 Time

Determines the reverb length for each of the Voice sections.

Higher settings result in a longer reverb sound.

Press the [D] button to make the “B” indicator flash, then use the DATA CONTROL dial to change the setting.

Range: 0.3s – 30.0s

Sustain

The sustain effect, selectable for the Upper, Lower and Pedal Voices, causes Voices to gradually fade out when the keys are released. The sustain on/off and sustain length settings are independent for each keyboard, providing maximum expressive control. Call up the Sustain display to set the Sustain effect by pressing the [SUSTAIN] button on the panel.

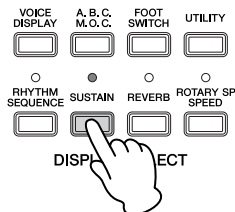

Sustain Display



Sustain On/Off

For Upper Voices, press the corresponding [B] button to toggle between On and Off. For Lower Voices, press the corresponding [C] button to toggle between On and Off. For Pedal Voices, press the corresponding [D] button to toggle between On and Off. Sustain cannot be applied to the Lead Voices.

The lamp of the [SUSTAIN] button lights up when you turn on the Sustain effect for one of the Upper, Lower and Pedal Voices in the Sustain display. When you turn off the Sustain effect for all Voices in the Sustain display, the lamp turns off. Remember to check whether the sustain effects are on or off in the Sustain display before you start to play.

Sustain Length

The display shows the current sustain length values for each keyboard. Press the appropriate button to make the “” indicator flash (Upper Keyboard: [B] button; Lower Keyboard: [C] button; Pedal Keyboard: [D] button), then use the DATA CONTROL dial to change the setting.

Rotary Speaker

Rotary Speaker recreates the rich, swirling sound of the popular rotating speaker effect. The Rotary Speaker effect can be switched in real time as you play, with either the front panel button or the Left Footswitch (when properly set for Footswitch operation). Keep in mind that the Rotary Speaker effect CANNOT be turned on only by turning on the [ROTARY SP SPEED] button. To use the Rotary Speaker effect, follow the steps below.

1 Select the Rotary Speaker effect from the desired Voice.

When you want to set Rotary Speaker for one of the Voice sections, you can select the effect category of Rotary Speaker in the Voice Condition display, Page 4. See page 45 for details.



2 Adjust the rotating speed and mode of the Rotary Speaker.

Press the [ROTARY SP SPEED] button to call up the Rotary Speaker display. The settings in this display are common to all Voice sections.

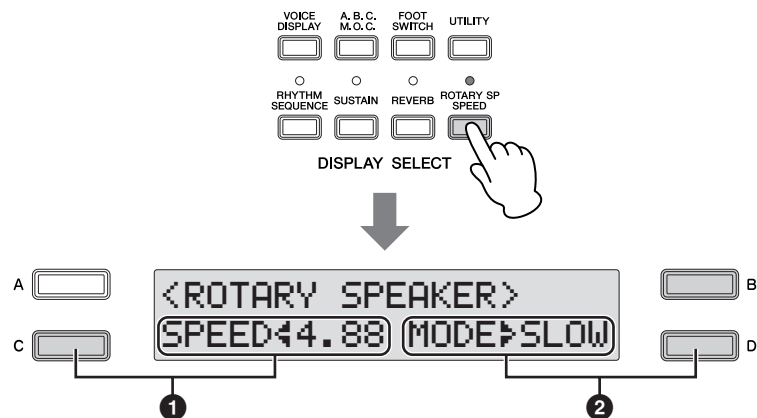

1 Speed

Determines the speed of the speaker rotation.

Press the [C] button to make the “◀” indicator flash, then use the DATA CONTROL dial to change the setting.

Range: 2.69Hz – 39.7Hz

2 Mode

Determines the slow/stop mode when the [ROTARY SP SPEED] button is off. If Slow is selected, a slow chorus effect is applied when you turn off the button on the panel. If Stop is selected, the Rotary Speaker effect turns off (stops completely) when you turn off the button on the panel.

Press the [D] button to make the “▶” indicator flash, then use the DATA CONTROL dial to change the setting.

Once the Rotary Speaker effect has been turned on and set, you can control the effect in real time from the panel or from the Left Footswitch.

3 Control the Rotary Speaker effect from the panel or from the Left Footswitch.

You can control Rotary Speaker on/off not only from the panel but also by using the Left Footswitch, if the Footswitch has been properly assigned.

See “4 Rotary Speaker” on page 149 for details.

3 Effect List

PRESET

The effect type that best matches and is most suited to the currently selected sound is automatically selected.

REVERB

Produces a gentle “wash” of aftertones in the sound, recreating the subtle ambience and depth of actual performance spaces and rooms.

No.	Type	No.	Type
01	HALL 1	14	STAGE 2
02	HALL 2	15	PLATE 1
03	HALL 3	16	PLATE 2
04	HALL M	17	XG HALL 1
05	HALL L	18	XG HALL 2
06	ROOM 1	19	XG ROOM 1
07	ROOM 2	20	XG ROOM 2
08	ROOM 3	21	XG ROOM 3
09	ROOM 4	22	XG STAGE 1
10	ROOM S	23	XG STAGE 2
11	ROOM M	24	XG PLATE
12	ROOM L	25	GM PLATE
13	STAGE 1		

Parameter	Range	Description
Time	0.3 – 30.0 s	Determines the decay time of the reverb.
Dry/Wet	D63>W – D<W63	Determines the balance of the original sound (dry) and the effect sound (wet).

DELAY

Produces delayed distinct repeats of the sound, or echoes. This is also useful for creating rhythmic repeats in the sound.

No.	Type
01	DELAY LCR
02	XG DLY LCR
03	DELAY LR
04	ECHO
05	CROSS DELAY
06	TEMPO DELAY

Parameter	Range	Description
L DelayTime	0.1 – 743.0 msec Echo: 0.1 – 371.5 msec	Determines the time that elapses between the original sound and the delayed repeat in the left channel.

Parameter	Range	Description
R DelayTime	0.1 – 743.0 msec Echo: 0.1 – 371.5 msec	Determines the time that elapses between the original sound and the delayed repeat in the right channel.
C DelayTime	0.1 – 743.0 msec	Determines the time that elapses between the original sound and the delayed repeat in the center of the stereo image.
L>R Delay	0.1 – 371.5 msec	Determines the time for the sound to move from left to right (when using Cross Delay).
R>L Delay	0.1 – 371.5 msec	Determines the time for the sound to move from right to left (when using Cross Delay).
DelayTime	16th – 8th.	When using Tempo Delay, this sets the time between delayed repeats to match the tempo of the rhythm/song.
InputSelect	L, R, L/R	Determines the input configuration.
FB Delay	0.1 – 743.0 msec	Determines the feedback time of the delayed repeats. The larger the value, the longer the time between delayed repeats. (For Delay LR, the left and right channels can be set independently.)
FB Level	-63 – +63	Determines the amount of delayed repeats in the sound. When this is set to 0%, the delayed repeat from the second time will not sound.
Dry/Wet	D63>W – D<W63	Determines the balance of original sound and the effect sound.

KARAOKE

Produces a deep echo effect like that used in Karaoke sing-along applications.

No.	Type
01	KARAOKE 1
02	KARAOKE 2
03	KARAOKE 3

Parameter	Range	Description
DelayTime	0.1 – 400 msec	Determines the time that elapses between the original sound and the delayed repeat.
FB Level	-63 – +63	Determines the amount of delayed repeats in the sound. When this is set to 0%, the delayed repeat from the second time will not sound.
Dry/Wet	D63>W – D<W63	Determines the balance of the original sound and effect sound.

CHORUS

Creates a warm effect as if several of the same sound were playing at once. Makes the overall sound richer, “fatter” and more animated.

No.	Type
01	CHORUS 1
02	CHORUS 2
03	XG CHORUS 1
04	XG CHORUS 2
05	XG CHORUS 3
06	XG CHORUS 4
07	GM CHORUS 1
08	GM CHORUS 2
09	GM CHORUS 3

No.	Type
10	GM CHORUS 4
11	FB CHORUS
12	CELESTE 1
13	CELESTE 2
14	CELESTE 3
15	CELESTE 4
16	SYMPHONIC
17	XG SYMPHONIC

Parameter	Value	Description
LFO Freq.	0.00 – 39.7 Hz	Determines the frequency of oscillation, or the speed of the wavering effect.
LFO Depth	0 – 127	Determines the depth of oscillation, or the amount of the wavering effect.
Dry/Wet	D63>W – D<W63	Determines the balance of the original sound and the effect sound.
Input Mode	Mono/Stereo	Determines the input configuration.

No.	Type
18	ENS DETUNE

Parameter	Value	Description
Detune	-50 – +50 cent	Determines the amount of detuning (or pitch shifting) is applied to the delayed repeats.
L DelayTime	0.0 – 50.0 msec	Determines the time that elapses between the original sound and the delayed repeat in the left channel.
R DelayTime	0.0 – 50.0 msec	Determines the time that elapses between the original sound and the delayed repeat in the right channel.
Dry/Wet	D63>W – D<W63	Determines the balance of the original sound and the effect sound.

FLANGER

This creates a metallic periodic “sweeping” effect, similar to Chorus but with a brighter more resonant sound.

No.	Type
01	FLANGER 1
02	FLANGER 2
03	XG FLANGER 1
04	XG FLANGER 2
05	XG FLANGER 3
06	GM FLANGER

Parameter	Value	Description
LFO Freq.	0.00 – 39.7 Hz	Determines the frequency of oscillation, or the speed of the wavering effect.
LFO Depth	0 – 127	Determines the depth of oscillation, or the amount of the wavering effect.
FB Level	-63 – +63	Determines the amount of output sound (with the flanging effect) that is returned to the input. The larger the value, the more complex and pronounced the flanging effect becomes.
Dry/Wet	D63>W – D<W63	Determines the original sound and the effect sound.

PHASER

Similar to Flanger, this produces rolling timbre changes and a pronounced up/down filter sweep effect.

No.	Type
01	PHASER
02	EP PHASER 1
03	EP PHASER 2
04	EP PHASER 3

Parameter	Value	Description
LFO Freq.	0.00 – 39.7 Hz	Determines the frequency of oscillation, or the speed of the wavering effect.
L/R Depth	0 – 127	Determines the depth of oscillation, or the amount of the wavering effect.
Phase Shift	0 – 127	Determines the phase relationship between the processed signal and the original. This changes the sound characteristics of the Phaser effect.
FB Level	-63 – +63	Determines the amount of output sound (with the phasing effect) that is returned to the input. The larger the value, the more complex and pronounced the phasing effect becomes.
Dry/Wet	D63>W – D<W63	Determines the balance of the original sound and the effect sound.

TREMOLO/AUTO PAN

This periodically changes the volume and has the effect of moving the sound image both front and back, and left and right.

No.	Type
01	TREMOLO 1
02	TREMOLO 2
03	XG TREMOLO
04	EP TREMOLO
05	GT TREMOLO 1
06	GT TREMOLO 2
07	ORGAN TREM.

Parameter	Range	Description
LFO Freq.	0.00 – 39.7 Hz	Determines the tremolo speed.
AM Depth	0 – 127	Determines the amount of volume change.
PM Depth	0 – 127	Determines the amount of pitch change in the sound.
Input Mode	Mono/Stereo	Determines the input configuration.
LFO Depth	0 – 127	Determines the depth of the Tremolo effect.
L/R Depth	0 – 127	Determines the depth of panning between the left and right channels.
F/R Depth	0 – 127	Front/rear. Determines the depth of the front and rear panning effect. This controls both level and pitch at the same time.

No.	Type
08	AUTO PAN
09	XG AT PAN
10	EP AUTO PAN

Parameter	Value	Description
LFO Freq.	0.00 – 39.7 Hz	Determines the frequency of the Auto Pan effect, or how fast the sound shifts between the left and right channels.
L/R Depth	0 – 127	Determines the depth of the left/right panning effect.
F/R Depth	0 – 127	Determines the depth of the front/rear panning effect. This controls both level and pitch at the same time.
Pan	L<->R L->R L<-R Lturn Rturn L/R	Determines the Auto Pan type. ("L<->R" is a sine wave and "L/R" is a sawtooth wave.)

ROTARY SPEAKER

This popular effect (used mainly for electronic organ sounds) recreates the rich, animated pulsing sound of a rotating speaker horn.

No.	Type
01	XG ROTARY SP
02	ROTARY SP 1
03	ROTARY SP 2
04	ROTARY SP 3
05	ROTARY SP 4

Parameter	Value	Description
EQ LowFreq.	32 – 2.0k Hz	Determines the central frequency of the low frequency range that is boosted or cut.
EQ Low Gain	-12 – +12 dB	Determines the amount over which the low frequency range is boosted or cut.
EQ Hi.Freq.	500 – 16k Hz	Determines the central frequency of the high frequency range that is boosted or cut.

Parameter	Value	Description
EQ Hi.Gain	-12 – +12 dB	Determines the amount over which the high frequency range is boosted or cut.

DISTORTION

This effect adds distortion to the sound.

No.	Type
01	DIST HARD
02	DIST SOFT
03	OVERDRIVE
04	XG DIST
05	XG AMP SIM

Parameter	Value	Description
Drive	0 – 127	Determines the amount or degree of distortion in the sound.
Amp. Type	Off Stack Combo Tube	Determines the type of amplifier that is simulated.
LPF Cutoff	1.0 – 18k Hz Thru	Determines the cutoff frequency of the low pass filter. Frequencies above this value are cut or filtered out.
OutputLevel	0 – 127	Determines the level or volume of the processed sound.
EQ Low Gain	-12 – +12 dB	Determines the amount of EQ boost or cut in the low frequency range.
EQ Mid.Gain	-12 – +12 dB	Determines the amount of EQ boost or cut in the mid frequency range.
Dry/Wet	D63>W – D<W63	Determines the balance of the original sound and the effect sound.

WAH

This uses an automatic up/down filter sweep to change the timbre of the sound, producing a “wah-wah” sound.

No.	Type
01	AUTO WAH
02	XG AUTO WAH
03	TOUCH WAH 1
04	TOUCH WAH 2
05	CLAVI TC WAH
06	EP TOUCH WAH

Parameter	Value	Description
LFO Freq.	0.00 – 39.7 Hz	Determines the speed of the Wah effect.
LFO Depth	0 – 127	Determines the depth of the Wah effect.
Cutoff	0 – 127	Determines the central frequency that the wah filter acts upon.
Resonance	1.0 – 12.0	Determines the frequency bandwidth (around the central frequency set in Cutoff above) that the wah filter affects.

Parameter	Value	Description
Sensitivity	0 – 127	Determines the degree to which the wah filter is affected by your playing touch.
Dry/Wet	D63>W – D<W63	Determines the balance of the original sound and the effect sound.

DYNAMIC

This effect (also called compression) “squeezes” the overall dynamic range of the sound, and has a gain control—letting you make soft sounds louder, and thus give more “punch” to the sound.

No.	Type
01	COMPRESSOR
02	NOISE GATE

Parameter	Value	Description
Attack	1 – 40 msec	Determines how soon the compression effect is applied, once the compressor has been triggered (as a result of Threshold below).
Release	10 – 680 msec	Determines how soon the compressor returns to its normal gain, once the trigger signal drops below the Threshold point.
Threshold	Compressor: -48 – -6 dB Noise Gate: -72 – -30 dB	Determines the level of the input signal required to trigger the compressor. Signals at a level below the Threshold pass through unaffected; signals at and above the Threshold are compressed.
Ratio	1.0 – 20.0	Determines the amount of compression of the sound (for signals passing the Threshold). This is expressed as a ratio—the change in output signal relative to the change in input. The range here is 1/1 (no change in output signal, hence no compression) to 20/1. Higher ratios result in greater compression.
OutputLevel	0 – 127	Determines the overall output of the compressed signal. Use this to bring up the overall level after you’ve reduced the dynamic range with compression.

EQ/ENHANCER

EQ

This processing tool lets you change the level for specific frequency ranges in the sound, and affects the overall sound quality.

No.	Type
01	ST 2BAND EQ
02	ST 3BAND EQ
03	XG 3BAND EQ
04	EQ DISCO
05	EQ TEL

Parameter	Value	Description
EQ LowFreq.	50 – 2.0k Hz ST 2Band EQ: 32 – 2.0k Hz	Determines the central frequency of the low frequency range that is to be boosted or cut.
EQ Low Gain	-12 – +12 dB	Determines the amount over which the low frequency range is boosted or cut.
EQ Mid.Freq	100 – 16k Hz	Determines the central frequency of the middle frequency range that is to be boosted or cut.
EQ Mid.Gain	-12 – +12 dB	Determines the amount over which the middle frequency range is boosted or cut.
EQ M Width	0.1 – 12.0	Determines the bandwidth or the range of frequencies around the specific middle frequency that is to be boosted or cut. Lower values let you narrow in on a specific frequency, while higher values select a broader range of frequencies to be affected.
EQ Hi.Freq	500 Hz – 16k Hz	Determines the central frequency of the high frequency range that is to be boosted or cut.
EQ Hi.Gain	-12 – +12 dB	Determines how much increase/decrease the wave frequency point of EQ high frequency.

ENHANCER

This effect emphasizes and enhances the overtones in the high frequency sound range overtone—**not** merely making the sound brighter, but giving it more clarity and presence.

No.	Type
06	HM ENHANCER
07	XG HM ENHNCE

Parameter	Value	Description
HPF Cutoff	500 Hz – 16k Hz	Determines the cutoff frequency of the low pass filter. Frequencies above this value are cut or filtered out.
Drive	0 – 127	Determines the amount or depth of the Enhancer effect.
Mix Level	0 – 127	Determines how much of the processed enhanced sound is mixed together with the original sound.

THRU

Bypass control. This cancels the effect processing.

No.	Type
01	Thru

Rhythm/Keyboard Percussion

This Electone features 133 different real rhythms featuring actual drum and percussion sampled sounds. Automatic Accompaniment functions are used with the rhythms, providing appropriate and completely automatic accompaniment to match the style of the selected rhythm. Moreover, the Electone has a Keyboard Percussion feature that allows you to directly play drum and percussion sounds from the Upper/Lower keyboards and Pedalboard.

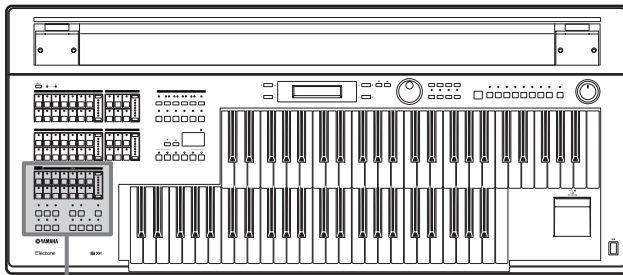

Rhythm/Keyboard Percussion

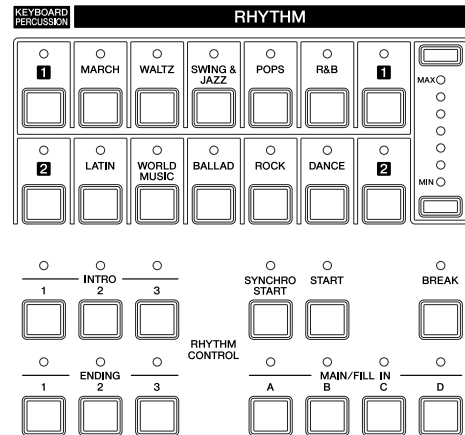

1 Selecting rhythms with the Rhythm buttons

A total of 133 rhythms can be instantly selected with the ten rhythm buttons on the front panel.

To select and play a rhythm

- 1 Press one of the Rhythm buttons in the RHYTHM section on the front panel.

For example, if you have pressed the [DANCE] button, the following display (Rhythm Menu) will appear.

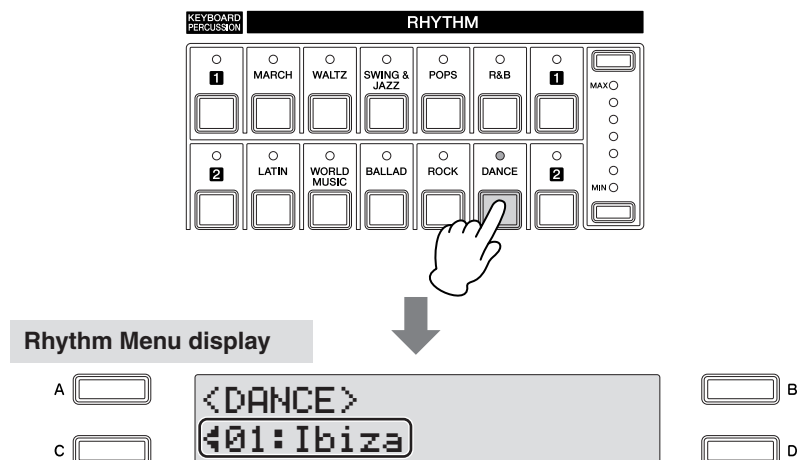

The Rhythm Menu contains many Dance rhythms, and the currently selected Dance rhythm is shown in the display.

2 Select the Rhythm in the Rhythm Menu display.

You can select the hidden dance rhythms in sequence (forward or reverse) by using the DATA CONTROL dial.



Here, we've selected "UK Pop."

You can select the rhythm in the Rhythm Menu display by pressing the [C] button one or more times. Each press of the [C] button selects subsequent hidden rhythms. When the final item is reached, pressing the [C] button "wraps around" to the first item.

3 Press the [START] button to immediately start the rhythm.

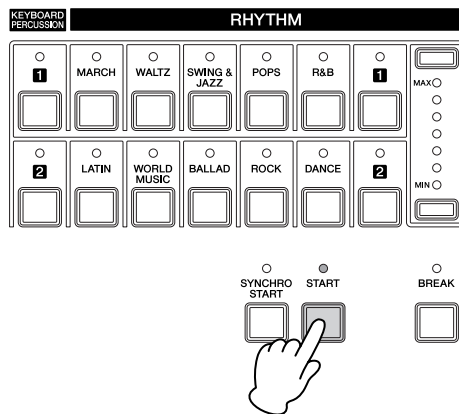

To stop the rhythm, press this button again.

You can turn the rhythm on/off and switch the sections as desired by pressing the buttons on the panel—and add the accompaniment to the rhythm.

4 Set the volume using the panel rhythm volume buttons.

The buttons have seven volume settings, from a minimum of 0, or no sound, to a maximum of full volume.

Fine adjustments in the volume of the rhythm can also be made from the Rhythm Condition display (page 62).

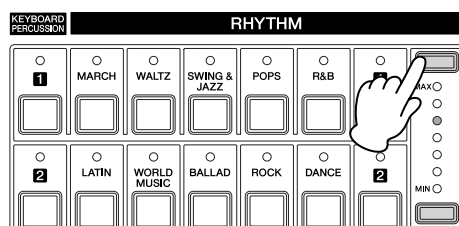

 **Reference Page**

Operating the rhythm from the panel (page 59)

 **Reference Page**

Accompaniment (page 68)

 **Reference Page**

Changing the rhythm volume/reverb (page 62)

Rhythm Structure

Each rhythm is made up of “sections.” Since each section is a variation of the basic rhythm, you can use them to add “spice” to your performance and mix up the beats while you are playing. You can freely change the section while the rhythm is played back.

INTRO

This is used for the beginning of the song. There are three Intro sections that can be selected with INTRO [1] – [3] buttons. When the Intro finishes playing, the rhythm automatically shifts to the Main section.

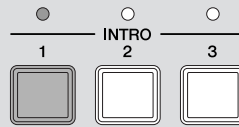

Selected Intro section's lamp is lit

MAIN

This is used for playing the main part of the song. There are four Main sections that can be selected with MAIN/FILL IN [A] – [D] buttons. The rhythm pattern of several measures repeats indefinitely.

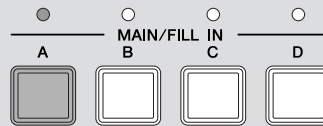

Selected Main section's lamp is lit

FILL IN

This is designed for use as a temporary and regular rhythmic pattern to spice up a repeating rhythm. There are four Fill In sections that can be played by pressing the selected (lit) MAIN/FILL IN [A] – [D] buttons as desired. When one measure pattern of Fill In finishes playing, the rhythm is automatically shifts to the Main section.

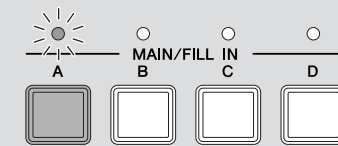

Selected Fill In section's lamp flashes

BREAK

This lets you add dynamic variations and breaks in the rhythm pattern. The Break section is selected by pressing the [BREAK] button. When the one-measure Break pattern finishes playing, the rhythm automatically shifts to the Main section.

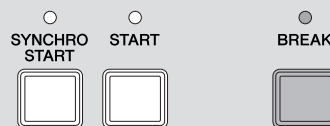

The lamp is lit when the Break section is selected

ENDING

This is used for the ending of the song. When the ending is finished, the rhythm automatically stops. There are three Ending sections that can be selected with the ENDING [1] – [3] buttons.

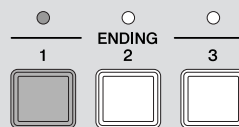

Selected Ending section's lamp is lit

Operating the rhythm from the panel

You can turn the rhythm on/off and switch the sections as desired by pressing the buttons on the panel. Using the Fill Ins and Break patterns let you add dynamic interest and “spice” to your performance.

To start/stop the rhythm:

START

The rhythm begins as soon as the [START] button is pressed. To stop the rhythm, press the button again.

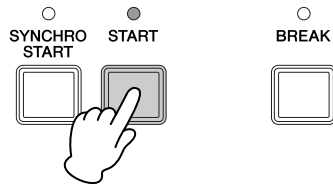

SYNCHRO START

The [SYNCHRO START] button puts the rhythm in “standby.” The rhythm starts when you press a note on the Lower keyboard or Pedalboard. When you start the rhythm with the [SYNCHRO START] button, pressing this button again stops the rhythm.

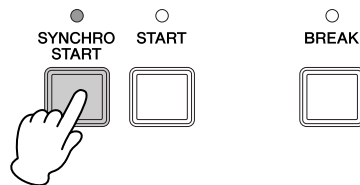

NOTE

When you start the rhythm with [SYNCHRO START] button, set the Lower/Pedal Memory to on. When Memory is off, releasing your fingers from Lower keyboard stops the rhythm. For details on Memory and the A.B.C. function, see page 71.

INTRO

Pressing one of the INTRO [1] – [3] buttons automatically adds a short introduction before starting the actual (Main) rhythm. First press one of the INTRO [1] – [3] buttons, then press the [START] or [SYNCHRO START] button to actually start the rhythm.

While the introduction is playing, the BAR/BEAT display shows the countdown to the first measure of the pattern. For example, if there is a four-measure lead-in for a pattern in 4/4 time, the display at right appears:

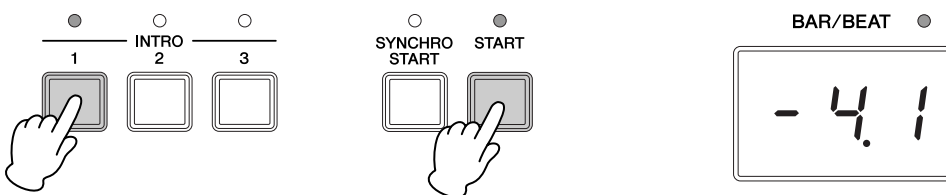

ENDING

Pressing one of the ENDING [1] – [3] buttons automatically adds an ending phrase before stopping the rhythm. When you press the Ending button while rhythm is playing back, the rhythm will automatically stop after the ending phrase is played. You can have the ending gradually slow down (ritardando) by pressing the ENDING button once again, while the ending is playing.

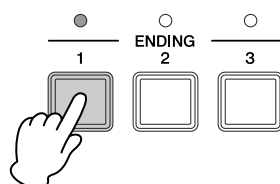

NOTE

Pressing the ENDING [1] button during playback of the Main section will first call up the Fill In pattern, then the Ending 1 pattern.

To switch the rhythm sections:

You can change the rhythm section of the Main phrase by pressing the desired MAIN/FILL IN [A] – [D] button. The selected section's lamp (above the button) lights.

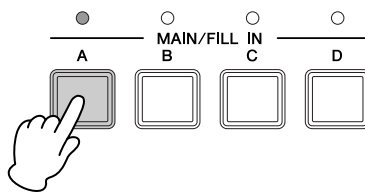

To use the Fill In patterns:

As you play the Electone along with the rhythm, occasionally press the selected MAIN/FILL button as desired. The Fill In pattern (one measure) will be played and the selected Fill In section's lamp (above the button) flashes.

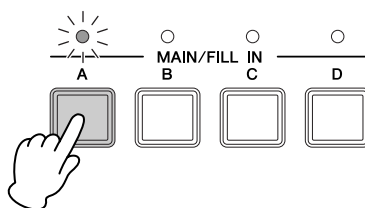

Reference Page

To select and play a rhythm (page 56)

When you use the Auto Fill In function, Fill Ins will be played automatically. The Auto Fill In function is set in the Page 1 of the Rhythm Condition display. To call up the Rhythm Condition display, select the desired rhythm and press the same rhythm button again.



When Auto Fill is set to On (■) in the right side of the display, the Fill In pattern is automatically played whenever you switch the Main sections. Each press of the [B] button toggles between On (■) and Off (□).

To use the Break patterns:

As you play the Electone along with the rhythm, occasionally press the [BREAK] button. This lets you vary a repeating rhythm with dynamic breaks.

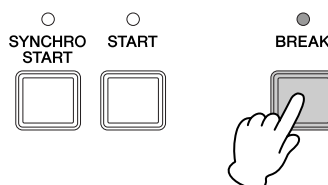

Adjusting the tempo

You can adjust the rhythm tempo by pressing the TEMPO buttons.

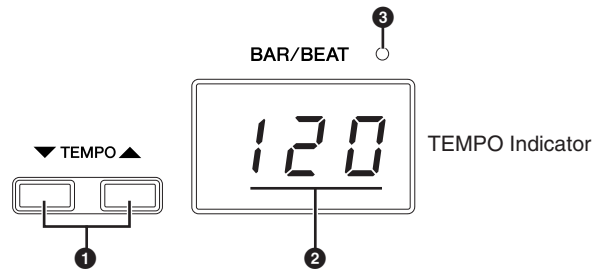

1 TEMPO buttons

For adjusting the speed of the rhythm. Pressing the right button increases the tempo and pressing the left button decreases it.

Each rhythm has its original (preset) tempo. Press the TEMPO buttons simultaneously to restore the tempo to the original setting.

2 TEMPO Display (BAR/BEAT Indicator)

TEMPO display shows the current tempo. Displayed values are given in beats per minute.

The tempo range is 40 to 240 beats per minute.

When the rhythm begins playing, the TEMPO indicator changes function to a BAR/BEAT indicator.

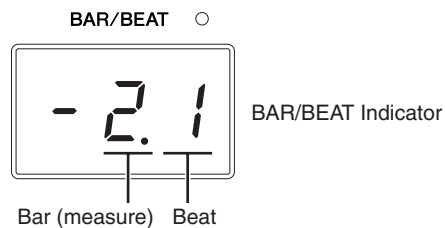

The number on the left in the BAR/BEAT indicator indicates the current bar or measure and the one on the right indicates the current beat in the bar.

3 BAR/BEAT indicator

The beat indicator lamp above the TEMPO display also indicates the beats.

Changing the rhythm volume/reverb

You can adjust the rhythm volume or amount of reverb applied to the rhythms and the percussion sounds used in the rhythms in the Rhythm Condition display. You can also have a Fill In play automatically by setting the Auto Fill function to ON.

To call up the Rhythm Condition display, select the desired rhythm and press the same rhythm button again.

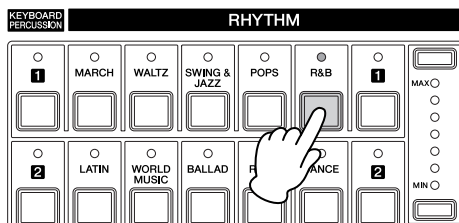

[Page 1] Rhythm Condition Display

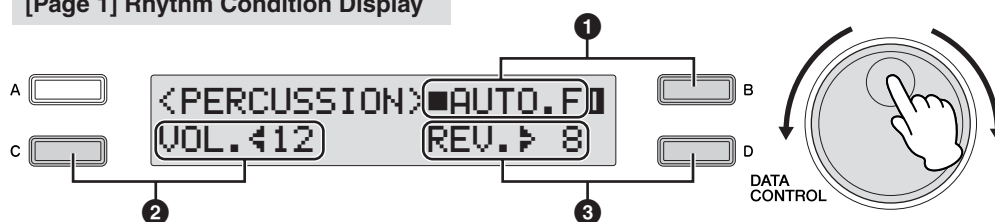

The buttons at the right and left side of the display and DATA CONTROL dial can control the rhythm volume and reverb.

1 Auto Fill

When Auto Fill is set to On (■) in the display, the Fill In pattern is automatically played whenever you switch the Main sections.
For details on how to set to On, see page 17.

NOTE

Depending on the volume value (set in the display), two adjacent Volume button lamps may be lit at the same time, indicating an intermediate position.

2 Volume

Fine Adjustment of rhythm volume.

Press the [C] button to make the “” indicator flash, then use the DATA CONTROL dial to change the setting.

Range: 0 – 24

3 Reverb

Determines the amount of reverb applied to the rhythm.

Press the [D] button to make the “” indicator flash, then use the DATA CONTROL dial to change the setting.

When the Reverb Depth (for entire instrument) is set to the minimum, the setting here will have no effect.

Range: 0 – 24

Reference Page

Reverb Depth (page 48)

2 Selecting rhythms from the User buttons

As with the Voice sections, the Rhythm section also has User buttons (numbered 1 or 2) from which rhythms can be selected. You can select original User rhythms that have been created with this Electone or other models equipped with the Rhythm Pattern Program function (such as the ELS-01/01C/01X). For details on selecting original User rhythms, see next page.

This also allows you to assign two or three rhythms from the same category to be selected from different buttons; one from the original Rhythm button, and the others from the User buttons.

For example, to call up “Modern R&B,” select the R&B category.

1 Press one of the User buttons at the right of the Rhythm buttons.

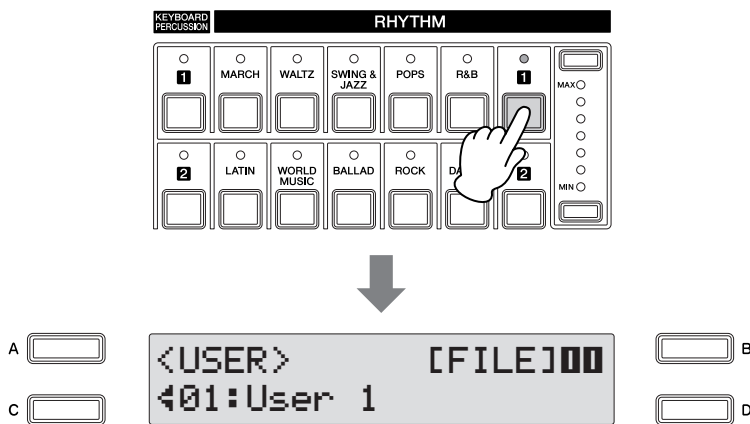

2 Select one of the pages with the Page buttons.

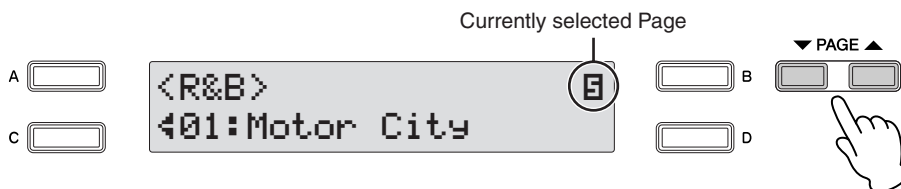

In this case, select Page 5 “R&B.”

3 Select the “Modern R&B” rhythm with the DATA CONTROL dial.

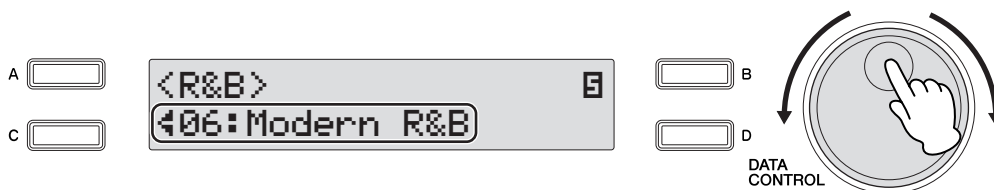

This step assigns “Modern R&B” to the User button [1]. You can call up the “Modern R&B” the next time you press the [1] button.

To call up a User rhythm

User rhythms created on other Electones that have Rhythm Pattern Programming functions, such as the ELS-01/01C/01X, can be selected and played from the User buttons in the panel Rhythm section.

To call up the User rhythm, load back the registration containing the User rhythm to Electone in advance.

For details on loading back the Registration, see “Playing Back a Song” on page 132. This procedure assigns the User rhythms to the User numbers 1 – 48.

1 Press one of the User buttons at the right of the Rhythm buttons.

2 Use the PAGE buttons to select Page 11 (User Page).



3 Select the User rhythm number by turning the DATA CONTROL dial.



Selecting Rhythm from an External Media

You can load rhythms from a USB storage device, and select them as User Rhythms. Style File Format files (extension: STY or ST2) can also be loaded.

- 1 Insert the media into the USB TO DEVICE terminal.
- 2 Press one of the User buttons at the right of the Rhythm buttons.

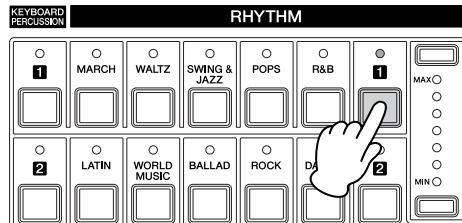

- 3 Use the PAGE buttons to select Page 11 (User Page).



- 4 Select the User number to which you want to load back the pattern file.



- 5 Press the [B] button corresponding to [FILE] in the display to turn on the file loading function.

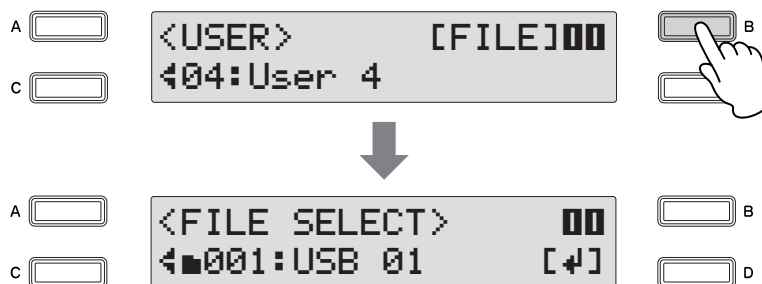

The File Select display appears.



NOTE

File loading cannot be done while the M.D.R. function is used or sequence data is playing back. The rhythm stops automatically if the File Select display is called up while the rhythm is being played.

6 Select the pattern file you want to load to the Electone.

File selection is done in the same way as song selection on page 111.



7 Press the [D] button corresponding to the [EXE] in the display to load the file back to the Electone.

This step assigns the pattern file to the User number selected in the step 4.



NOTE

To play back the User rhythm, first quit the File Select display.

8 For details on playing back the User rhythm, see “To call up a User rhythm” on page 64.

Rhythm List

This list shows all available rhythms on the Electone. Numbers written at the left side of each column in this list indicate the numbered buttons displayed in the Rhythm Menu.

The letters A, B and D printed at the right side of each column in this list indicate the corresponding DATA CONTROL button's name. Pressing that button selects the corresponding rhythm.

MARCH		
01	Marching Band 1	A
02	Marching Band 2	
03	Marching Band 3	
04	6/8 March	B
05	6/8 Kids	
06	6/8 Organ March	
07	Broadway	
08	SF March	
09	Wild West	
10	Baroque	
11	Metronome 2/4	D
WALTZ		
01	Gentle Waltz	
02	Guitar Serenade	
03	Snow Waltz	
04	Classic Waltz	A
05	Mariachi	
06	Musette	
07	Jazz Waltz 1	B
08	Jazz Waltz 2	
09	Metronome 3/4	D
SWING&JAZZ		
01	Big Band 1	A
02	Big Band 2	
03	Big Band Bop	
04	Orch. Big Band	
05	Orchestra Swing	
06	Jungle Drum	
07	Medium Jazz	B
08	Afro Cuban	
09	Five-Four	
10	Jazz Ballad	
11	Moonlight	
12	Winter Song	
13	Dixieland	
14	Dixieland Jazz	
15	Charleston	D
POPS		
01	8Beat Light 1	A
02	8Beat Light 2	
03	Folk Rock	
04	Asian Pops	
05	Unplugged	
06	Bubblegum Pop	
07	Guitar Pop	
08	British 16Beat	B
09	Fusion Shuffle	
10	Jazz Pop	
11	Pop Shuffle	
12	British Pop	
13	Metronome 4/4	D

R&B		
01	Motor City	
02	Soul	A
03	Frankly Soul	
04	Jazz Funk	
05	Detroit Pop	
06	Modern R&B	B
07	New Gospel	
08	Gospel Shuffle	
09	Gospel Sisters	
10	6/8 Soul	
11	Blues Shuffle	D
LATIN		
01	Big Band Samba	A
02	Light Samba	
03	Bossa Nova	
04	Pop Bossa	B
05	Mambo 1	
06	Mambo 2	
07	Montuno	
08	Calypso	
09	Cha Cha Cha	
10	Big Band Cha Cha	
11	Pop Cha Cha	
12	Rumba	
13	Beguine	
14	Tango 1	D
15	Tango 2	
WORLD MUSIC		
01	Bolero	
02	Flamenco	
03	Pop Flamenco	
04	Pasodoble	
05	Polka 1	A
06	Polka 2	
07	Banda Polka	
08	Irish Dance	B
09	Tarantella	
10	Enka	
11	Sheriff Reggae	
12	Bluegrass	
13	Hoedown	
14	Hawaiian	D
15	Mexican Dance	
BALLAD		
01	Power Ballad	
02	Dramatic Ballad	
03	Movie Ballad	
04	Carpenters Pop	
05	Love Song	
06	16Beat Ballad 1	A
07	16Beat Ballad 2	

08	Easy Ballad	
09	Guitar Ballad	
10	Organ Ballad	
11	Chart Ballad	
12	Analog Ballad	
13	8Beat Modern	B
14	Chillout	
15	Slow&Easy	
16	6/8 Slow Rock	D
ROCK		
01	Power Rock	A
02	Southern Rock	
03	60's Rock	
04	Hard Rock	B
05	Rock Shuffle	D
06	Tears Rock 1	
07	Tears Rock 2	
08	British Rock	
09	New Country	
10	Rock&Roll	
11	Jive	

DANCE		
01	Ibiza	A
02	Euro Trance	
03	Techno Party	
04	UK Pop	
05	Swing House	
06	US Hip Hop	B
07	Ground Beat	
08	Hip Hop Pop	
09	Club Latin	
10	Latin Disco	D
11	Garage	
12	6/8 Trance	
13	80's Dance	
14	Pop Beat	
15	Disco Philly	
16	70's Disco	
17	Disco Chocolate	

Certain rhythms that have been created for use with slow, soft songs or for songs that do not use a bass part at the beginning, may not have drum sections. To use these rhythms, refer to the following information.

The following rhythms/sections do not contain a drum part. To play back these rhythms/sections, make sure to turn the accompaniment parts on.

Category	Rhythm	Sections
MARCH	6/8 Organ March	Main A, Main B
	Baroque	All sections except Intro 1
WALTZ	Guitar Serenade	All sections except Intro 1
WORLD MUSIC	Banda Polka	Main A, Fill In A
	Mexican Dance	Main A, Fill In A
BALLAD	Dramatic Ballad	Main A

Some sections of the following three rhythms do not contain an Auto Bass part. This means that even though the Auto Bass Chord is turned on, the bass part will not sound.

- WALTZ: Guitar Serenade
- WORLD MUSIC: Pop Flamenco
- ROCK: New Country
- Metronome 2/4
- Metronome 3/4
- Metronome 4/4

3 Accompaniment

The Accompaniment function provides arpeggiated chords and other instrumental embellishments when rhythms are used. This control is selected from Page 3 and Page 4 of the Rhythm Condition display.

- 1 Select the desired rhythm and press the same button on the panel again.

The Rhythm Condition display appears.

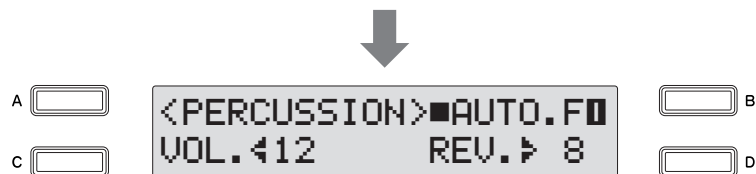
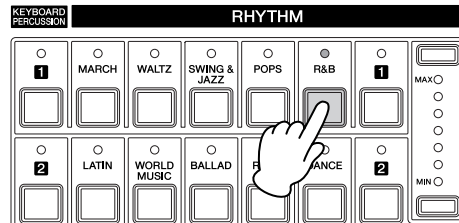

- 2 Use the PAGE buttons to select Page 3 or Page 4.



[Page 3] Rhythm Condition Display

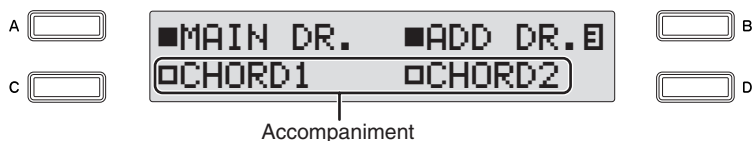

[Page 4] Rhythm Condition Display

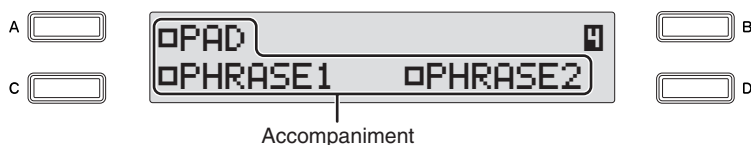

Each rhythm consists of seven parts, and you can visually confirm the On/Off status for all parts in Page 3 and Page 4 of the Rhythm Condition display. These parts, with the exception of the Main Drum and Add Drum, are Accompaniment parts.

The Accompaniment consists of five parts, Chord 1, Chord 2, Pad, Phrase 1, and Phrase 2, and each of them can be set to on or off by pressing corresponding button. If you turn all the parts off, the Accompaniment does not sound.

3 Turn the desired parts on.

Successive presses of the [A] – [D] buttons corresponding to the desired accompaniment parts alternates between On and Off.

[Page 3] Rhythm Condition Display

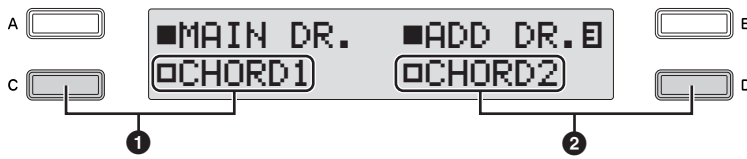

[Page 4] Rhythm Condition Display

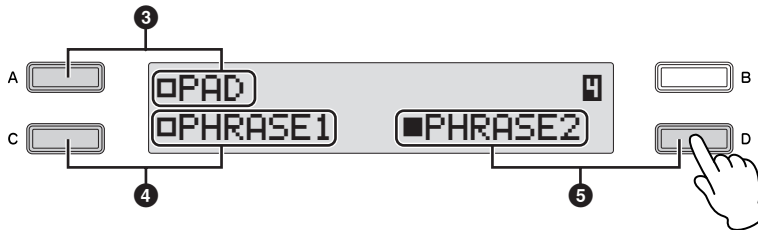

1 Chord 1

2 Chord 2

These are the rhythmic chord backing parts.

To set the On/Off status for Chord 1, use the [C] button in Page 3 of the Rhythm Condition display; for Chord 2, use the [D] button.

3 Pad

This part features sustained chords and commonly uses lush sounds, such as strings and organ.

To set the On/Off status for Pad, use the [A] button in Page 4 of the Rhythm Condition display.

4 Phrase 1

5 Phrase 2

These parts are used for various embellishments and riffs that enhance the song, such as brass section accents and chord arpeggios.

To set the On/Off status for Phrase 1, use the [C] button in Page 4 of the Rhythm Condition display; for Phrase 2, use the [D] button.

Not all parts contain accompaniment data. Some parts may be empty depending on the selected rhythm and rhythm section.

Main Drum and Add Drum contains the drum and percussion rhythm patterns. When you turn both Main Drum and Add Drum off, the drum and percussion do not sound.

Generally, Main Drum contains the main part of the rhythm and Add Drum has additional percussion sounds, such as tambourine.

4 Press the [START] button to start the rhythm, and then play the Lower Keyboard.

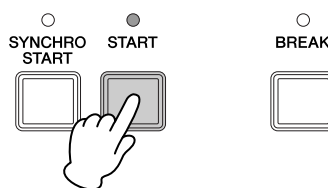

To adjust the volume and amount of reverb applied to the Accompaniment:

Make settings in Page 2 of the Rhythm Condition display.



Reference Page

Rhythm Condition display (page 62)

1 Select the desired rhythm and then press the same rhythm button on the panel again.

The Rhythm Condition display appears.

2 Use the PAGE buttons to select Page 2.

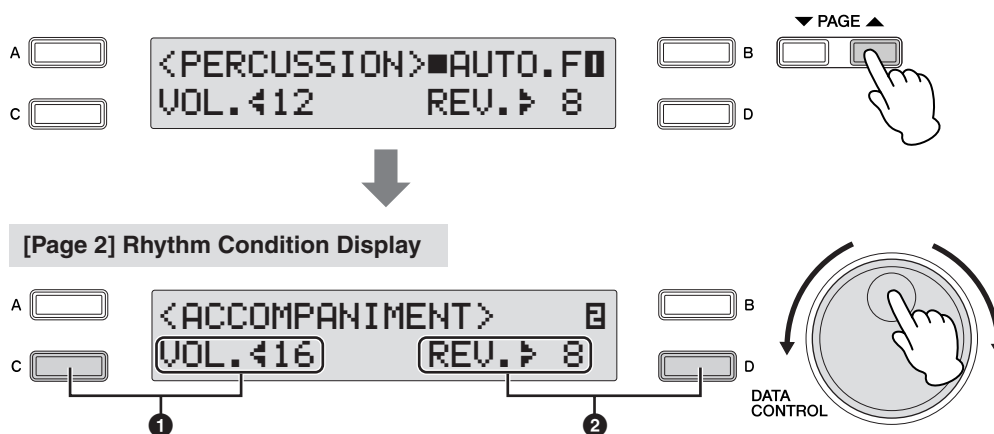

Determine the reverb and volume settings.

1 Volume

Determines the accompaniment volume.

Press the [C] button to make the “◀” indicator flash, then use the DATA CONTROL dial to change the setting.

Range: 0 – 24

2 Reverb

Determines the amount of reverb applied to accompaniment. When the Reverb Depth (for entire instrument) is set to the minimum, the setting here will have no effect.

Press the [D] button to make the “▶” indicator flash, then use the DATA CONTROL dial to change the setting.

Range: 0 – 24



Reference Page

Reverb Depth (page 48)

Automatic Accompaniment—Auto Bass Chord (A.B.C.)

The Auto Bass Chord (A.B.C.) function works with the Rhythm section of the Electone to automatically produce bass accompaniment as you play. It adds an entirely new dimension to your performance by effectively putting a full backing band at your disposal. There are three modes used for producing Automatic Accompaniment patterns. You can select the desired mode in Page 1 of the A.B.C. display.

To set the A.B.C. function:

Press the [A.B.C./M.O.C.] button.

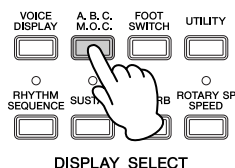

The A.B.C. display appears.

[Page 1] A.B.C. Display

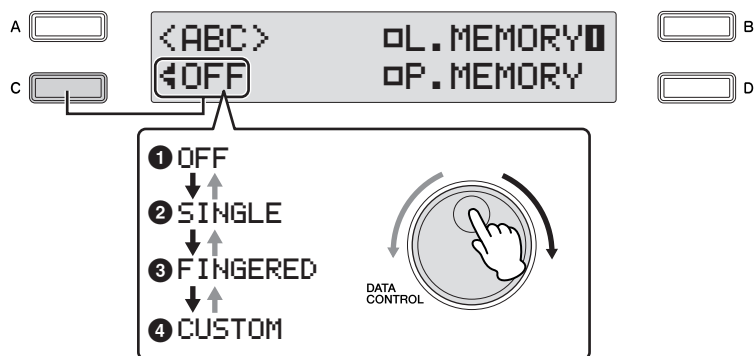

Select the desired mode by turning the DATA CONTROL dial.

A.B.C. Mode

You can select modes in sequence: Off → Single Finger → Fingered Chord → Custom A.B.C. by turning the DATA CONTROL dial clockwise. Turning the DATA CONTROL dial counter-clockwise selects in the reverse order.

When you start the rhythm with the [SYNCHRO START] button, set the Lower/Pedal Memory to on. When Memory is off, releasing your fingers from Lower keyboard stops the rhythm. For details, see “Memory” on page 73.

1 Off

Cancels the Auto Bass Chord function.



NOTE

When the A.B.C. function mode is set to Single or Fingered Chord, the bass part will not sound even if you play the pedals of the Pedalboard.

2 Single

You can produce major, minor, 7th, and minor 7th chords by simply using one, or at most, two or three fingers to play the chords. The Single Finger mode provides the fastest and easiest means to obtain many different chord/bass combinations. The chord produced will sound in the same octave regardless of where it is played on the Lower keyboard.

Key of C

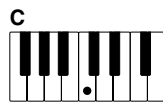

Major chords:

Press the root of the chord (the note that corresponds to the chord's name).

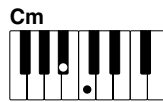

Minor chords:

Simultaneously press the root and any one black key to the left of it.

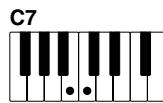

7th chords:

Simultaneously press the root and any one white key to the left of it.

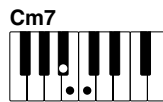

Minor 7th chords:

Simultaneously press the root as well as any black key and any white key to the left of it.

Playing single finger chords without the use of the rhythm lets you add full continuous chords to your performance.

3 Fingered Chord

The Fingered Chord mode automatically produces bass accompaniment for chords played in the Lower keyboard. It allows you to use a wider range of chord types than in the Single Finger mode. In the Fingered Chord mode, you play full chords while the Auto Bass Chord function automatically selects the appropriate bass pattern. If you play only one or two notes in the Lower keyboard, the appropriate chord will sound on the basis of the previously played chord.



NOTE

When playing certain chords (aug, dim7, sus4, 6, and m6), make sure that the lowest note you play is the root of the chord.

Key of C

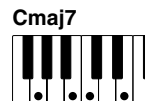
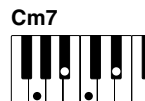

Playing fingered chords without the use of the rhythm lets you add full continuous chords to your performance.

4 Custom A.B.C.

The Custom A.B.C. mode is a slight variation on the Fingered Chord mode.

It allows you to determine what bass notes will be played in the accompaniment by playing notes on the Pedalboard along with the chords you play in the Lower keyboard.

Memory

The Memory function is a convenient performance tool in the A.B.C. features that makes playing with the accompaniment even smoother and more fluid. It is available separately for both the Lower keyboard and Pedalboard. To use it, turn Memory on, start the rhythm and play chords and bass notes according to the selected A.B.C. mode. With Memory on, the accompaniment continues to play, even when you release your fingers (and foot). When you want to change to the next chord, simply play it and release it, and the auto accompaniment keeps playing with the new chord and bass note. This means that you can play a chord/bass note briefly, release it, and take your time before playing the next—you don't have to hold a chord down to keep the accompaniment going.

When A.B.C. is turned off (but Memory is on), the auto accompaniment of the rhythmic chords and bass pattern do not sound, but the sound of the Lower keyboard and/or Pedalboard continues until you play the next chord/bass note.



❶ Lower Memory

When this is set to on, the Lower keyboard Voices and chord accompaniment keep playing even after you release your fingers from the Lower keyboard, while the rhythm plays.

Successive pressing of the [B] button alternates between On and Off.

❷ Pedal Memory

When this is set to on, the Pedalboard Voices and bass accompaniment keep playing even after you release your foot from the Pedalboard, while the rhythm plays.

Successive pressing of the [D] button alternates between On and Off.

(In the Single Finger and Fingered modes:) When this is set to on, the bass accompaniment of the Pedalboard Voices keeps playing even after you release your fingers from the Lower keyboard.

5 Melody On Chord (M.O.C.)

The Melody On Chord (M.O.C.) feature automatically adds a harmony part to the melodies you play on the Upper keyboard. The harmony is derived from the chords you play on the Lower keyboard—or from the chords that are played for you, if you use Automatic Accompaniment.

To set the M.O.C. function:

1 Press the [A.B.C./M.O.C.] button.

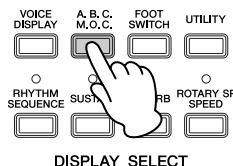

The A.B.C. display appears.

2 Use the PAGE buttons to select Page 2.



[Page 2] M.O.C. Display

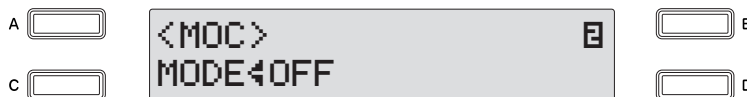

M.O.C. display appears.

3 Turn the M.O.C. on.

Successive pressing of the [C] button alternates between On and Off.

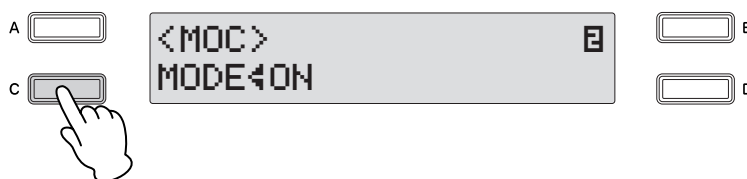

On:

Produces harmonies of up to two notes in a range close to the melody played.

Off:

Cancels the Melody On Chord function.

Melody On Chord can be heard only when the Upper Keyboard Voice section's volume is set to the appropriate value.

Melody On Chord does not apply to the Lead Voice.

Rhythm Sequence

Rhythm Sequence lets you create your own rhythm compositions, connecting together any of the Electone's existing rhythms as well as original rhythms created on other Electones that have the Rhythm Sequence Program function (such as ELS-01).

Although the ELB-01 does not have the full Rhythm Sequence Program function, you can load four rhythm compositions to Sequence numbers 1 – 4 in the display for future recall, using the steps below.

When the rhythm sequence contains Registration Sequence data or Next Registration data, these data also can be loaded and played on the ELB-01.

While a rhythm is playing, sequence data in the Registration data cannot be loaded.

1 Insert the media that contains the desired rhythm sequence data into the USB TO DEVICE terminal.

2 Press the [MDR] button and select the desired song you want to load back to Electone.

This is necessary because the rhythm sequence data is stored as part of the registration data in the song.



Reference Pages

- Songs (page 116)
- Selecting a Song (page 111)

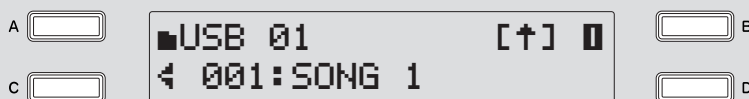
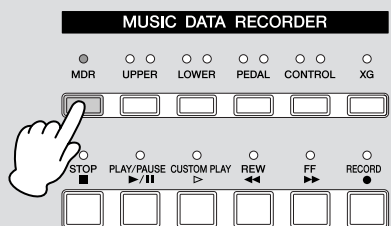

3 Press the [PLAY/PAUSE] button in the MDR section to load back the desired registration.

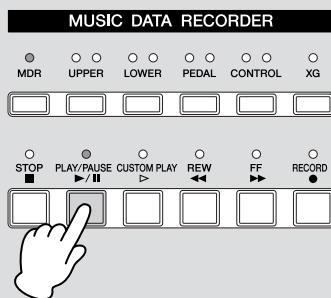

Now the rhythm sequence data has been loaded to Sequence numbers 1—4.

4 Press the [RHYTHM SEQUENCE] button to call up the Rhythm Sequence display.

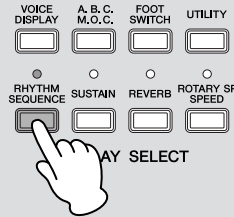

NOTE

Sequence numbers 1 – 4 can be turned on at the same time.

5 Select the sequence by pressing the [A] – [D] buttons corresponding to the desired sequence number in the display to be played back.

Successive pressing of the [A] – [D] buttons alternates between On and Off. Use the [A] button for Sequence 1, [B] for Sequence 2, [C] for Sequence 3 and [D] for Sequence 4.

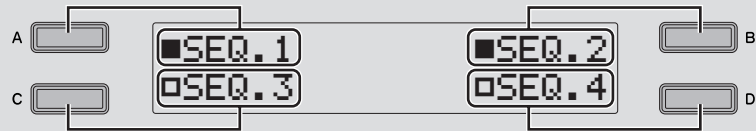

6 Press the [START] button in the Rhythm section to play back the rhythm sequence.

Only those sequences set to On can be played. Two or more rhythm sequences can be played back in succession in numeric order. After playing back, the solid square indication turns to a hollow square in the display.

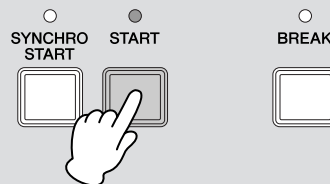

6 Keyboard Percussion

The Keyboard Percussion function provides many different drum and percussion sounds, playable from the keyboards and Pedalboard. Keyboard Percussion has two different modes, Preset and User. Preset Keyboard Percussion lets you play the preset drum kit sounds from the keyboards (assigned beforehand to the keys), while the User Keyboard Percussion lets you freely assign the drum sounds to any key or pedal you wish.

Using the Preset Keyboard Percussion

- 1 Turn off the Upper, Lower and/or Pedal Voices by setting each Voice's volume to MIN.
- 2 Turn on the Keyboard Percussion function by pressing the Keyboard Percussion [1] or [2] button. Press the [1] button to play Percussion sounds on the Upper/Lower keyboards, and press the [2] button for the Pedalboard.



Reference Page

On/Off status of Voices
(page 28)

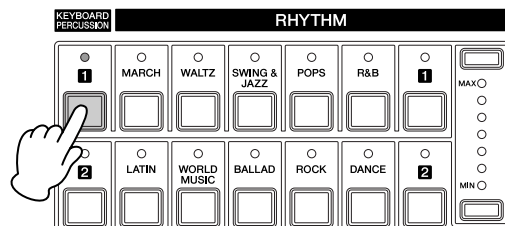

[Page 1] Keyboard Percussion Display

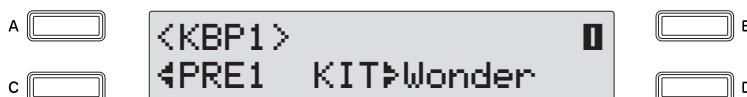

Select the desired percussion kit.

You can select a kit from a total of 15 different kits.

Press the [D] button to make the “▶” indicator flash, then use the DATA CONTROL dial to select the kit.



NOTE

Two Keyboard Percussion sets, [1] and [2], can be played at the same time by setting both buttons to on.

3 Select the desired percussion kit.

You can select a kit from a total of 15 different kits.
Press the [D] button to make the “▶” indicator flash, then use the DATA CONTROL dial to select the kit.



4 Play some notes on the keyboards and/or Pedalboard.

For details of percussion assignments for each kit, see the “Preset Keyboard Percussion List” on page 80.

Changing the Keyboard Percussion volume/reverb

You can make settings in Page 2 of the Keyboard Percussion display.



Reference Page

On/Off status of Voices
(page 28)

1 Turn off the Upper, Lower and/or Pedal Voices by setting each Voice's volume to MIN.

2 Press the Keyboard Percussion button.

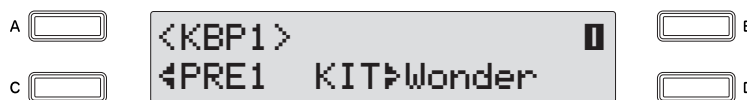

3 Use the PAGE buttons to select Page 2 of the Keyboard Percussion display.



Reference Pages

Using the Preset Keyboard Percussion (page 77)
Recalling the User Keyboard Percussion (page 92)

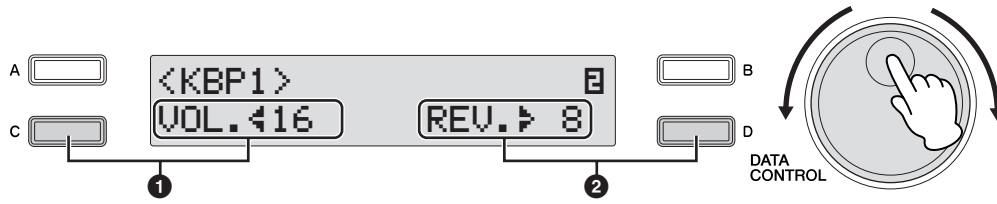

You can adjust the Keyboard Percussion volume/reverb in the display.

1 Volume

Determine the Keyboard Percussion volume.

Press the [C] button to make the “” indicator flash, then use the DATA CONTROL dial to select the kit.

Range: 0 – 24

2 Reverb

Determines the amount of reverb applied to the Keyboard Percussion.

When the Reverb depth (for entire instrument) is set to the minimum, the setting here will have no effect.

Press the [D] button to make the “” indicator flash, then use the DATA CONTROL dial to select the kit.

Range: 0 – 24



Reference Page

Reverb Depth (page 48)

Preset Keyboard Percussion List

Indicates the drum/percussion sounds and their key assignments.

	Wonderland Kit			EL Drum Kit		
	Presets 2 (PK)	Presets 1 (LK)	Presets 1 (UK)	Presets 2 (PK)	Presets 1 (LK)	Presets 1 (UK)
C1	Thunder	Laser Beam		BD Heavy		
C#1	Horse	Laser Shot		SD BrRoll		
D1	Bass Drum	Water Phone		SD Heavy		
D#1	Footsteps	Bubble		SD BrShot 1	Claves	
E1	Snare	Puddle		SD Reverb 1		
F1	Snare Roll	Thunder		SD Light		
F#1	Footsteps	Shower		Tom 3	Synth Tom 3	
G1	Lion	Beach		SD Rim 1	Concert BD	
G#1	Footsteps	Stream		Tom 2	Synth Tom 2	
A1	Oxen	Footsteps		HH Close	BD Heavy	
A#1	Footsteps	Door Squeak		Tom 1	Synth Tom 1	
B1	Door Slam	Door Slam		HH Open	BD Light	
C2	Big Clock	Bass Drum	Bass Drum	Ride Cym 1	SD Heavy	-
C#2	Footsteps	Gran Cassa	Gran Cassa	Synth Tom 3	SD BrRoll	-
D2	Starship	Tom 2	Tom 2	Crash Cym 1	SD Heavy	-
D#2	Footsteps	Tom 1	Tom 1	Synth Tom 2	SD BrShot 1	-
E2	Train	Snare	Snare	Orch Cym	SD Reverb 1	-
F2	Car Crash	Snare Roll	Snare Roll		SD Light	-
F#2	Footsteps	HH Closed	HH Closed	Synth Tom 1	Tom 3	-
G2	Puddle	Cymbal	Cymbal		SD Rim 1	-
G#2		HH Open	HH Open		Tom 2	-
A2		Tambourine	Tambourine		HH Close	-
A#2		FingerSnaps	FingerSnaps		Tom 1	-
B2		Castanet	Castanet		HH Open	-
C3		Triangle M	Triangle M		Ride Cym 1	-
C#3		Woodblock L	Woodblock L		Orch SD	-
D3		Triangle O	Triangle O		Crash Cym 1	-
D#3		Woodblock H	Woodblock H		SD Roll	-
E3		Handclap	Handclap		Orch Cym	-
F3		Jingle Bell	Jingle Bell		OrchCymRoll	-
F#3		Bell Tree	Bell Tree		Triangle M	-
G3		Alarm Bell	Alarm Bell		Tambourine	-
G#3		Train	Train		Triangle O	-
A3		Horn 1	Horn 1		Castanet	-
A#3		Horn 2	Horn 2		Cowbell 1	-
B3		Siren	Siren		Timbale 1 L	-
C4		Car Engine	Car Engine		Timbale 1 H	-
C#4		Car Crash	Car Crash		WoodBlock L	-
D4		Helicopter	Helicopter		Conga L	-
D#4		Starship	Starship		WoodBlock H	-
E4		Sheep	Sheep		Conga H	-
F4		Goat	Goat		Bongo L	-
F#4		Oxen	Oxen		Agogo L	-
G4		Whinny	Whinny		Bongo H	-
G#4		Horse	Horse		Agogo H	-
A4		Lion	Lion		Cuica L	-
A#4		Dog	Dog		Hand Claps	-
B4		Cat	Cat		Cuica H	-
C5		Rooster	Rooster		Shaker	-
C#5			Owl			-
D5			Insects			-
D#5			Frog			-
E5			Tweet 1			-
F5			Tweet 2			-
F#5			CuckooClock			-
G5			Big Clock			-
G#5			Bell			-
A5			Telephone			-
A#5			Camera			-
B5			Gnaw			-
C6			Applause			-

 : Indicates the keys of the keyboard.

	Standard Kit 1			Standard Kit 2		
	Preset 2 (PK)	Preset 1 (LK)	Preset 1 (UK)	Preset 2 (PK)	Preset 1 (LK)	Preset 1 (UK)
C1	Kick	–		Kick Short	–	
C#1	Side Stick	Surdo Mute		SideStick L	Surdo Mute	
D1	Snare	Surdo Open		Snare Short	Surdo Open	
D#1	Hand Clap	Hi Q		Hand Clap	Hi Q	
E1	Snare Tight	Whip Slap		SnareTightH	Whip Slap	
F1	Floor Tom L	Scratch H		Floor Tom L	Scratch H	
F#1	HH Closed	Scratch L		HH Closed	Scratch L	
G1	Floor Tom H	Finger Snap		Floor Tom H	Finger Snap	
G#1	HH Pedal	Click Noise		HH Pedal	Click Noise	
A1	Low Tom	Metro.Click		Low Tom	Metro.Click	
A#1	HH Open	Metro.Bell		HH Open	Metro.Bell	
B1	Mid Tom L	Seq Click L		Mid Tom L	Seq Click L	
C2	Mid Tom H	Seq Click H	–	Mid Tom H	Seq Click H	–
C#2	Crash Cym 1	Brush Tap	–	Crash Cym 1	Brush Tap	–
D2	High Tom	Brush Swirl	–	High Tom	Brush Swirl	–
D#2	Ride Cym 1	Brush Slap	–	Ride Cym 1	Brush Slap	–
E2	Chinese Cym	Br TapSwirl	–	Chinese Cym	Br TapSwirl	–
F2	RideCym Cup	Snare Roll	–	RideCym Cup	Snare Roll	–
F#2	Tambourine	Castanet	–	Tambourine	Castanet	–
G2	Splash Cym	Snare Soft	–	Splash Cym	SnareSoft 2	–
G#2		Sticks	–		Sticks	–
A2		Kick Soft	–		Kick Soft	–
A#2		OpenRimShot	–		OpRimShot H	–
B2		Kick Tight	–		Kick Tight	–
C3		Kick	Bongo H		Kick Short	Bongo H
C#3		Side Stick	Bongo L		SideStick L	Bongo L
D3		Snare	CongaH Mute		Snare Short	CongaH Mute
D#3		Hand Clap	CongaH Open		Hand Clap	CongaH Open
E3		Snare Tight	Conga L		SnareTightH	Conga L
F3		Floor Tom L	Timbale H		Floor Tom L	Timbale H
F#3		HH Closed	Timbale L		HH Closed	Timbale L
G3		Floor Tom H	Agogo H		Floor Tom H	Agogo H
G#3		HH Pedal	Agogo L		HH Pedal	Agogo L
A3		Low Tom	Cabasa		Low Tom	Cabasa
A#3		HH Open	Maracas		HH Open	Maracas
B3		Mid Tom L	SambaWhis.H		Mid Tom L	SambaWhis.H
C4		Mid Tom H	SambaWhis.L		Mid Tom H	SambaWhis.L
C#4		Crash Cym 1	Guiro Short		Crash Cym 1	Guiro Short
D4		High Tom	Guiro Long		High Tom	Guiro Long
D#4		Ride Cym 1	Claves		Ride Cym 1	Claves
E4		Chinese Cym	WoodBlock H		Chinese Cym	WoodBlock H
F4		RideCym Cup	WoodBlock L		RideCym Cup	WoodBlock L
F#4		Tambourine	Cuica Mute		Tambourine	Cuica Mute
G4		Splash Cym	Cuica Open		Splash Cym	Cuica Open
G#4		Cowbell	Triangle M		Cowbell	Triangle M
A4		Crash Cym 2	Triangle O		Crash Cym 2	Triangle O
A#4		Vibraslap	Shaker		Vibraslap	Shaker
B4		Ride Cym 2	JingleBells		Ride Cym 2	JingleBells
C5		–	Bell Tree		–	Bell Tree
C#5			–			–
D5			–			–
D#5			–			–
E5			–			–
F5			–			–
F#5			–			–
G5			–			–
G#5			–			–
A5			–			–
A#5			–			–
B5			–			–
C6			–			–

		Hit Kit			Room Kit		
		Preset 2 (PK)	Preset 1 (LK)	Preset 1 (UK)	Preset 2 (PK)	Preset 1 (LK)	Preset 1 (UK)
C1	CH1	KickTight H	–		Kick	–	
D1	D#1	StickAmbien	Surdo Mute		Side Stick	Surdo Mute	
E1	E#1	SnareAmbien	Surdo Open		SnareSnappy	Surdo Open	
F1	F#1	Hand Clap	Hi Q		Hand Clap	Hi Q	
G1	G#1	SnareTight2	Whip Slap		SnrTightSnp	Whip Slap	
A1	A#1	HybridTom 1	Scratch H		Tom Room 1	Scratch H	
B1	B#1	HybridTom 2	Scratch L		HH Closed	Scratch L	
C2	C#2	HybridTom 3	Finger Snap		Tom Room 2	Finger Snap	
D2	D#2	HybridTom 4	HH Pedal 2		HH Pedal	Click Noise	
E2	E#2	HybridTom 5	Click Noise		Tom Room 3	Metro.Click	
F2	F#2	HybridTom 6	Metro.Click		HH Open	Metro.Bell	
G2	G#2	Ride Cym 1	Metro.Bell		Tom Room 4	Seq Click L	
A2	A#2	Crash Cym 1	Seq Click L	–	Tom Room 5	Seq Click H	–
B2	B#2	HybridTom 6	Seq Click H	–	Crash Cym 1	Brush Tap	–
C3	C#3	Ride Cym 1	Brush Tap	–	Tom Room 6	Brush Swirl	–
D3	D#3	Ride Cym 1	Brush Slap	–	Ride Cym 1	Brush Slap	–
E3	E#3	Chinese Cym	Br TapSwirl	–	Chinese Cym	Br TapSwirl	–
F3	F#3	RideCym Cup	Snare Roll	–	RideCym Cup	Snare Roll	–
G3	G#3	TambourineL	Castanet	–	Tambourine	Castanet	–
A3	A#3	Splash Cym	Snr Electro	–	Splash Cym	Snare Soft	–
B3	B#3		Sticks	–		Sticks	–
C4	C#4		KickTight L	–		Kick Soft	–
D4	D#4		Snare Pitch	–		OpenRimShot	–
E4	E#4		Kick Wet	–		Kick Tight	–
F4	F#4		KickTight H	Bongo H		Kick	Bongo H
G4	G#4		StickAmbien	Bongo L		Side Stick	Bongo L
A4	A#4		SnareAmbien	CongaH Mute		SnareSnappy	CongaH Mute
B4	B#4		Hand Clap	CongaH Open		Hand Clap	CongaH Open
C5	C#5		SnareTight2	Conga L		SnrTightSnp	Conga L
D5	D#5		HybridTom 1	Timbale H		Tom Room 1	Timbale H
E5	E#5		HH Closed 2	Timbale L		HH Closed	Timbale L
F5	F#5		HybridTom 2	Agogo H		Tom Room 2	Agogo H
G5	G#5		HH Pedal 2	Agogo L		HH Pedal	Agogo L
A5	A#5		HybridTom 3	Cabasa		Tom Room 3	Cabasa
B5	B#5		HH Open 2	Maracas		HH Open	Maracas
C6	C#6		HybridTom 4	SambaWhis.H		Tom Room 4	SambaWhis.H
D6	D#6		HybridTom 5	SambaWhis.L		Tom Room 5	SambaWhis.L
E6	E#6		Crash Cym 1	Guiro Short		Crash Cym 1	Guiro Short
F6	F#6		HybridTom 6	Guiro Long		Tom Room 6	Guiro Long
G6	G#6		Ride Cym 1	Claves		Ride Cym 1	Claves
A6	A#6		Chinese Cym	WoodBlock H		Chinese Cym	WoodBlock H
B6	B#6		RideCym Cup	WoodBlock L		RideCym Cup	WoodBlock L
C7	C#7		TambourineL	Cuica Mute		Tambourine	Cuica Mute
D7	D#7		Splash Cym	Cuica Open		Splash Cym	Cuica Open
E7	E#7		Cowbell	Triangle M		Cowbell	Triangle M
F7	F#7		Crash Cym 2	Triangle O		Crash Cym 2	Triangle O
G7	G#7		Vibraslap	Shaker		Vibraslap	Shaker
A7	A#7		Ride Cym 2	JingleBells		Ride Cym 2	JingleBells
B7	B#7		–	Bell Tree		–	Bell Tree
C8	C#8			–			–
D8	D#8			–			–
E8	E#8			–			–
F8	F#8			–			–
G8	G#8			–			–
A8	A#8			–			–
B8	B#8			–			–
C9	C#9			–			–
D9	D#9			–			–
E9	E#9			–			–
F9	F#9			–			–
G9	G#9			–			–
A9	A#9			–			–
B9	B#9			–			–
C10	C#10			–			–

	Rock Kit			Electro Kit		
	Preset 2 (PK)	Preset 1 (LK)	Preset 1 (UK)	Preset 2 (PK)	Preset 1 (LK)	Preset 1 (UK)
C1	Kick Gate	–		KickGateHvy	–	
D1	Side Stick	Surdo Mute		Side Stick	Surdo Mute	
E1	Snare Rock	Surdo Open		SnareNoisy2	Surdo Open	
F1	Hand Clap	Hi Q		Hand Clap	Hi Q	
G1	SnRockTight	Whip Slap		SnareNoisy3	Whip Slap	
A1	Tom Rock 1	Scratch H		TomElectro1	Scratch H	
B1	HH Closed	Scratch L		HH Closed	Scratch L	
C2	Tom Rock 2	Finger Snap		TomElectro2	Finger Snap	
D2	HH Pedal	Click Noise		HH Pedal	Click Noise	
E2	Tom Rock 3	Metro.Click		TomElectro3	Metro.Click	
F2	HH Open	Metro.Bell		HH Open	Metro.Bell	
G2	Tom Rock 4	Seq Click L		TomElectro4	Seq Click L	
A2	Tom Rock 5	Seq Click H	–	TomElectro5	Seq Click H	–
B2	Crash Cym 1	Brush Tap	–	Crash Cym 1	Brush Tap	–
C3	Tom Rock 6	Brush Swirl	–	TomElectro6	Brush Swirl	–
D3	Ride Cym 1	Brush Slap	–	Ride Cym 1	Brush Slap	–
E3	Chinese Cym	Br TapSwirl	–	Chinese Cym	Reverse Cym	–
F3	RideCym Cup	Snare Roll	–	RideCym Cup	Snare Roll	–
G3	Tambourine	Castanet	–	Tambourine	Hi Q 2	–
A3	Splash Cym	Snare Noisy	–	Splash Cym	SnrSnapElec	–
B3		Sticks	–		Sticks	–
C4		Kick Soft	–		Kick 3	–
D4		OpenRimShot	–		OpenRimShot	–
E4		Kick 2	–		Kick Gate	–
F4		Kick Gate	Bongo H		KickGateHvy	Bongo H
G4		Side Stick	Bongo L		Side Stick	Bongo L
A4		Snare Rock	CongaH Mute		SnareNoisy2	CongaH Mute
B4		Hand Clap	CongaH Open		Hand Clap	CongaH Open
C5		SnRockTight	Conga L		SnareNoisy3	Conga L
D5		Tom Rock 1	Timbale H		TomElectro1	Timbale H
E5		HH Closed	Timbale L		HH Closed	Timbale L
F5		Tom Rock 2	Agogo H		TomElectro2	Agogo H
G5		HH Pedal	Agogo L		HH Pedal	Agogo L
A5		Tom Rock 3	Cabasa		TomElectro3	Cabasa
B5		HH Open	Maracas		HH Open	Maracas
C6		Tom Rock 4	SambaWhis.H		TomElectro4	SambaWhis.H
D6		Tom Rock 5	SambaWhis.L		TomElectro5	SambaWhis.L
E6		Crash Cym 1	Guiro Short		Crash Cym 1	Guiro Short
F6		Tom Rock 6	Guiro Long		TomElectro6	Guiro Long
G6		Ride Cym 1	Claves		Ride Cym 1	Claves
A6		Chinese Cym	WoodBlock H		Chinese Cym	WoodBlock H
B6		RideCym Cup	WoodBlock L		RideCym Cup	WoodBlock L
C7		Tambourine	Cuica Mute		Tambourine	Scratch H 2
D7		Splash Cym	Cuica Open		Splash Cym	Scratch L 2
E7		Cowbell	Triangle M		Cowbell	Triangle M
F7		Crash Cym 2	Triangle O		Crash Cym 2	Triangle O
G7		Vibraslap	Shaker		Vibraslap	Shaker
A7		Ride Cym 2	JingleBells		Ride Cym 2	JingleBells
B7		–	Bell Tree		–	Bell Tree
C8			–			–
D8			–			–
E8			–			–
F8			–			–
G8			–			–
A8			–			–
B8			–			–
C9			–			–
D9			–			–
E9			–			–
F9			–			–
G9			–			–
A9			–			–
B9			–			–
C10			–			–

		Analog Kit			Jazz Kit		
		Preset 2 (PK)	Preset 1 (LK)	Preset 1 (UK)	Preset 2 (PK)	Preset 1 (LK)	Preset 1 (UK)
C1		Kick Analog	–		Kick Jazz	–	
	C#1	SideStickAn	Surdo Mute		SideStick L	Surdo Mute	
D1		SnareAnalog	Surdo Open		SnareJazz L	Surdo Open	
	D#1	Hand Clap	Hi Q		Hand Clap	Hi Q	
E1		SnareAnlg 2	Whip Slap		SnareJazz M	Whip Slap	
	F#1	TomAnalog 1	Scratch H		Floor Tom L	Scratch H	
G1		Hat CloseAn	Scratch L		HH Closed	Scratch L	
	G#1	TomAnalog 2	Finger Snap		Floor Tom H	Finger Snap	
A1		HatCloseAn2	Click Noise		HH Pedal	Click Noise	
	A#1	TomAnalog 3	Metro.Click		Low Tom	Metro.Click	
B1		Hat Open An	Metro.Bell		HH Open	Metro.Bell	
	C#2	TomAnalog 4	Seq Click L		Mid Tom L	Seq Click L	
C2		TomAnalog 5	Seq Click H	–	Mid Tom H	Seq Click H	–
	D#2	CrashAnalog	Brush Tap	–	Crash Cym 1	Brush Tap	–
D2		TomAnalog 6	Brush Swirl	–	High Tom	Brush Swirl	–
	E#2	Ride Cym 1	Brush Slap	–	Ride Cym 1	Brush Slap	–
E2		Chinese Cym	Reverse Cym	–	Chinese Cym	Br TapSwirl	–
	F#2	RideCym Cup	Snare Roll	–	RideCym Cup	Snare Roll	–
G2		Tambourine	Hi Q 2	–	Tambourine	Castanet	–
	G#2	Splash Cym	SnareNoisy4	–	Splash Cym	SnareJazz H	–
A2			Sticks	–		Sticks	–
	A#2		Kick 3	–		Kick Soft	–
B2			OpenRimShot	–		OpenRimShot	–
	C#3		KickAnlgSht	–		Kick Tight	–
C3			Kick Analog	Bongo H		Kick Jazz	Bongo H
	D#3		SideStickAn	Bongo L		SideStick L	Bongo L
D3			SnareAnalog	CongaAnlg H		SnareJazz L	CongaH Mute
	E#3		Hand Clap	CongaAnlg M		Hand Clap	CongaH Open
E3			SnareAnlg 2	CongaAnlg L		SnareJazz M	Conga L
	F#3		TomAnalog 1	Timbale H		Floor Tom L	Timbale H
G3			Hat CloseAn	Timbale L		HH Closed	Timbale L
	G#3		TomAnalog 2	Agogo H		Floor Tom H	Agogo H
A3			HatCloseAn2	Agogo L		HH Pedal	Agogo L
	A#3		TomAnalog 3	Cabasa		Low Tom	Cabasa
B3			Hat Open An	Maracas 2		HH Open	Maracas
	C#4		TomAnalog 4	SambaWhis.H		Mid Tom L	SambaWhis.H
C4			TomAnalog 5	SambaWhis.L		Mid Tom H	SambaWhis.L
	D#4		CrashAnalog	Guiro Short		Crash Cym 1	Guiro Short
D4			TomAnalog 6	Guiro Long		High Tom	Guiro Long
	E#4		Ride Cym 1	Claves 2		Ride Cym 1	Claves
E4			Chinese Cym	WoodBlock H		Chinese Cym	WoodBlock H
	F#4		RideCym Cup	WoodBlock L		RideCym Cup	WoodBlock L
G4			Tambourine	Scratch H 2		Tambourine	Cuica Mute
	G#4		Splash Cym	Scratch L 2		Splash Cym	Cuica Open
A4			CowbellAnlg	Triangle M		Cowbell	Triangle M
	A#4		Crash Cym 2	Triangle O		Crash Cym 2	Triangle O
B4			Vibraslap	Shaker		Vibraslap	Shaker
	C#5		Ride Cym 2	JingleBells		Ride Cym 2	JingleBells
C5			–	Bell Tree		–	Bell Tree
	D#5			–			–
D5				–			–
	E#5			–			–
E5				–			–
	F#5			–			–
F5				–			–
	G#5			–			–
G5				–			–
	A#5			–			–
A5				–			–
	B#5			–			–
B5				–			–
	C#6			–			–
C6				–			–

	Brush Kit			Symphony Kit		
	Preset 2 (PK)	Preset 1 (LK)	Preset 1 (UK)	Preset 2 (PK)	Preset 1 (LK)	Preset 1 (UK)
C1	Kick Jazz	–		GranCassa M	–	
D1	SideStick L	Surdo Mute		Side Stick	Surdo Mute	
E1	BrushSlap 3	Surdo Open		Band Snare	Surdo Open	
F1	Hand Clap	Hi Q		Hand Clap	Hi Q	
G1	Brush Tap 2	Whip Slap		BandSnare 2	Whip Slap	
A1	Tom Brush 1	Scratch H		Floor Tom L	Scratch H	
B1	HH Closed	Scratch L		HH Closed	Scratch L	
C2	Tom Brush 2	Finger Snap		Floor Tom H	Finger Snap	
D2	HH Pedal	Click Noise		HH Pedal	Click Noise	
E2	Tom Brush 3	Metro.Click		Low Tom	Metro.Click	
F2	HH Open	Metro.Bell		HH Open	Metro.Bell	
G2	Tom Brush 4	Seq Click L		Mid Tom L	Seq Click L	
A2	Tom Brush 5	Seq Click H	–	Mid Tom H	Seq Click H	–
B2	Crash Cym 1	Brush Tap	–	Hand Cymbal	Brush Tap	–
C3	Tom Brush 6	Brush Swirl	–	High Tom	Brush Swirl	–
D3	Ride Cym 1	Brush Slap	–	Hand Cym S	Brush Slap	–
E3	Chinese Cym	Br TapSwirl	–	Chinese Cym	Br TapSwirl	–
F3	RideCym Cup	Snare Roll	–	RideCym Cup	Snare Roll	–
G3	Tambourine	Castanet	–	Tambourine	Castanet	–
A3	Splash Cym	BrushSlap 2	–	Splash Cym	Snare Soft	–
B3		Sticks	–		Sticks	–
C4		Kick Soft	–		Kick Soft 2	–
D4		OpenRimShot	–		OpenRimShot	–
E4		Kick Tight	–		Gran Cassa	–
F4		Kick Jazz	Bongo H		GranCassa M	Bongo H
G4		SideStick L	Bongo L		Side Stick	Bongo L
A4		BrushSlap 3	CongaH Mute		Band Snare	CongaH Mute
B4		Hand Clap	CongaH Open		Hand Clap	CongaH Open
C5		Brush Tap 2	Conga L		BandSnare 2	Conga L
D5		Tom Brush 1	Timbale H		Floor Tom L	Timbale H
E5		HH Closed	Timbale L		HH Closed	Timbale L
F5		Tom Brush 2	Agogo H		Floor Tom H	Agogo H
G5		HH Pedal	Agogo L		HH Pedal	Agogo L
A5		Tom Brush 3	Cabasa		Low Tom	Cabasa
B5		HH Open	Maracas		HH Open	Maracas
C6		Tom Brush 4	SambaWhis.H		Mid Tom L	SambaWhis.H
D6		Tom Brush 5	SambaWhis.L		Mid Tom H	SambaWhis.L
E6		Crash Cym 1	Guiro Short		Hand Cymbal	Guiro Short
F6		Tom Brush 6	Guiro Long		High Tom	Guiro Long
G6		Ride Cym 1	Claves		Hand Cym S	Claves
A6		Chinese Cym	WoodBlock H		Chinese Cym	WoodBlock H
B6		RideCym Cup	WoodBlock L		RideCym Cup	WoodBlock L
C7		Tambourine	Cuica Mute		Tambourine	Cuica Mute
D7		Splash Cym	Cuica Open		Splash Cym	Cuica Open
E7		Cowbell	Triangle M		Cowbell	Triangle M
F7		Crash Cym 2	Triangle O		Hand Cym 2	Triangle O
G7		Vibraslap	Shaker		Vibraslap	Shaker
A7		Ride Cym 2	JingleBells		HandCym 2 S	JingleBells
B7		–	Bell Tree		–	Bell Tree
C8			–			–
D8			–			–
E8			–			–
F8			–			–
G8			–			–
A8			–			–
B8			–			–
C9			–			–
D9			–			–
E9			–			–
F9			–			–
G9			–			–
A9			–			–
B9			–			–
C10			–			–

		SFX1			SFX2		
		Preset 2 (PK)	Preset 1 (LK)	Preset 1 (UK)	Preset 2 (PK)	Preset 1 (LK)	Preset 1 (UK)
C1		CutingNoiz1	-		Phone Call	-	
	C#1	CutingNoiz2	-		Door Squeak	-	
D1		-	-		Door Slam	-	
	D#1	String Slap	-		Scratch Cut	-	
E1		-	-		Scratch H 3	-	
	F#1	-	-		Wind Chime	-	
F1		-	-		Phone Ring	-	
	G#1	-	-		-	-	
G1		-	-		-	-	
	A#1	-	-		-	-	
A1		-	-		-	-	
	B#1	-	-		-	-	
B1		-	-		-	-	
	C#2	-	-	-	-	-	-
C2		-	-	-	-	-	-
	D#2	-	-	-	-	-	-
D2		-	-	-	-	-	-
	E#2	Fl.KeyClick	-	-	CarEngnIgni	-	-
E2		-	-	-	CarTiresSql	-	-
	F#2	-	-	-	Car Passing	-	-
F2		-	-	-	Car Crash	-	-
	G#2	-	-	-	-	-	-
G2		-	-	-	-	-	-
	A#2	-	-	-	-	-	-
A2		-	-	-	-	-	-
	B#2	-	-	-	-	-	-
B2		-	-	-	-	-	-
	C#3	CutingNoiz1	-	-	Phone Call	-	Burst
C3		CutingNoiz2	-	-	Door Squeak	-	Coaster
	D#3	-	-	-	Door Slam	-	Submarine
D3		String Slap	-	-	Scratch Cut	-	-
	E#3	-	-	-	Scratch H 3	-	-
E3		-	-	-	Wind Chime	-	-
	F#3	-	-	-	Phone Ring	-	-
F3		-	-	-	-	-	-
	G#3	-	-	Shower	-	-	Laugh
G3		-	-	Thunder	-	-	Scream
	A#3	-	-	Wind	-	-	Punch
A3		-	-	Stream	-	-	Heart Beat
	B#3	-	-	Bubble	-	-	Foot Steps
B3		-	-	Feed	-	-	-
	C#4	-	-	-	-	-	-
C4		-	-	-	-	-	-
	D#4	-	-	-	-	-	-
D4		-	-	-	-	-	-
	E#4	Fl.KeyClick	-	-	CarEngnIgni	-	-
E4		-	-	-	CarTiresSql	-	-
	F#4	-	-	-	Car Passing	-	-
F4		-	-	-	Car Crash	-	-
	G#4	-	-	-	Siren	-	-
G4		-	-	-	Train	-	-
	A#4	-	-	-	Jet Plane	-	-
A4		-	-	-	Starship	-	-
	B#4	-	-	-	-	-	-
B4		-	-	Dog	-	-	Machine Gun
	C#5	-	-	Horse	-	-	Laser Gun
C5		-	-	Bird Tweet	-	-	Explosion
	D#5	-	-	-	-	-	Firework
D5		-	-	-	-	-	-
	E#5	-	-	-	-	-	-
E5		-	-	-	-	-	-
	F#5	-	-	Ghost	-	-	-
F5		-	-	Maou	-	-	-
	G#5	-	-	-	-	-	-
G5		-	-	-	-	-	-
	A#5	-	-	-	-	-	-
A5		-	-	-	-	-	-
	B#5	-	-	-	-	-	-
B5		-	-	-	-	-	-
	C#6	-	-	-	-	-	-
C6		-	-	-	-	-	-

Assigning sounds to the User Keyboard Percussion

You can assign any desired drum and percussion sound to any key or pedal, and your original setups can be saved to eight memory locations: User 1 through User 8. The User setting saved in the User memory location can be called up by using the Keyboard Percussion [1] or [2] buttons.

In the instructions below, drum sounds are assigned to User 1 and called up with Keyboard Percussion [1] button.

1 Turn on the Keyboard Percussion function by pressing the Keyboard Percussion [1] button.

The Keyboard Percussion display appears.

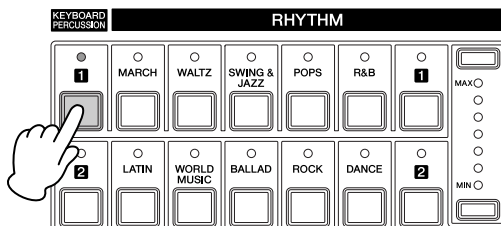

[Page 1] Keyboard Percussion Display

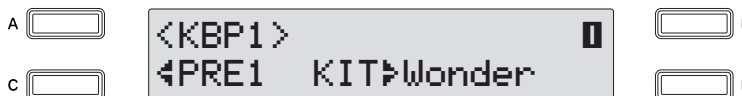

2 Select “User 1” here.

Press the [C] button to make the “⚡” indicator flash, then use the DATA CONTROL dial to select “User 1.”

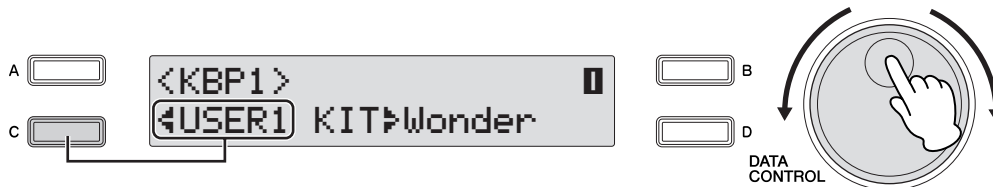

3 Select the desired percussion kit.

Press the [D] button to make the “⚡” indicator flash, then use the DATA CONTROL dial to select the kit.

Refer to the “Kit Assign List” on page 93.



4 Use the PAGE buttons to select Page 3.

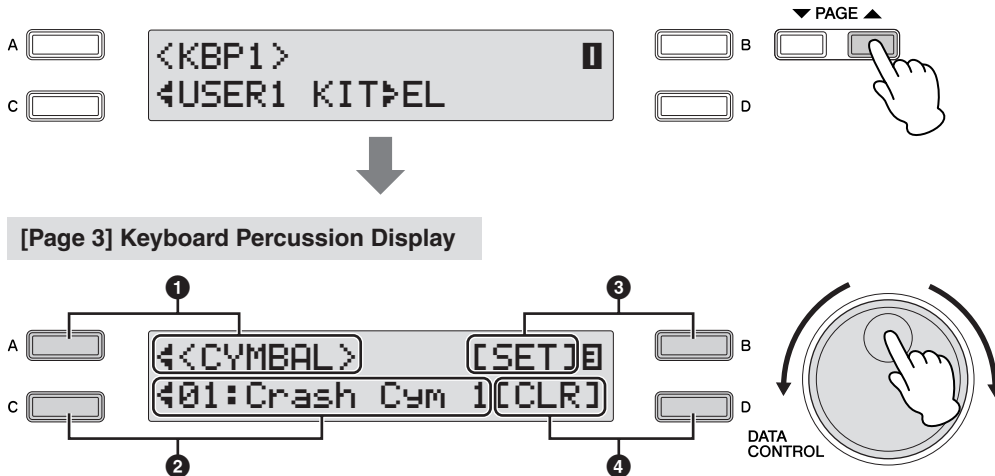

In this Page, you can assign specific drum sounds to any of the keys.

1 Category

This allows you to select the desired percussion category using the [A] buttons. Refer to the “Kit Assign List” on page 93.

2 Instrument Names

The individual instruments are shown in the display and can be selected with the appropriate [A] – [D] buttons. Refer to the “Kit Assign List” on page 93.

3 Set

Assigns the selected instrument to the desired key. (See the following explanation in step 7.)

4 Clear

This function is used to erase the User assignment for User 1. Clear works in two ways: either to erase a single instrument, or to erase all instruments. (See the following explanation on page 91.)

5 Select the desired percussion group.

Press the [A] button to make the “4” indicator flash, then use the DATA CONTROL dial to select the category.



6 Select the desired instruments.

Press the [C] button to make the “◀” indicator flash, then use the DATA CONTROL dial to select instrument.



NOTE

Though eight User Keyboard Percussion setups can be created, they cannot be memorized to Registration Memory. Only on/off data and the Keyboard Percussion Menu are memorized to Registration Memory.

7 To assign an instrument to a particular key or pedal.

Simultaneously hold down the Data Control button corresponding to [Set] and press the key (or pedal) to which the instrument is to be assigned. The currently displayed instrument will be assigned to the key you press down as a part of User 1.



1. While holding down [B] button...



2. Press the key.

8 Repeat the operation steps above as necessary to construct your own User Keyboard Percussion set.

To erase one instrument:

Simultaneously hold down the [D] button corresponding to the [Clear] in the display and press the key (or pedal) corresponding to the instrument you wish to erase. (A short 'beep' sound indicates that the instrument has been erased.)

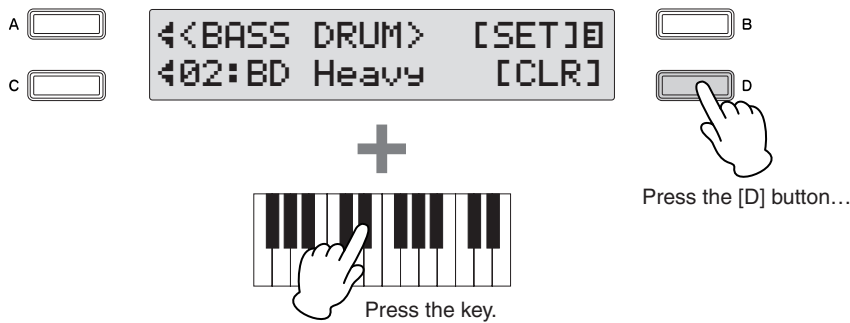

Do not turn the power off while the Keyboard Percussion settings are being saved.

To erase all instruments:

You can clear all assignments in Page 3 of the Keyboard Percussion display.

1 Press, then release the [D] button corresponding to [CLEAR] in the display.

The following display appears, prompting confirmation of the operation. You can cancel the operation at this point by pressing the [D] button corresponding to [Cancel].

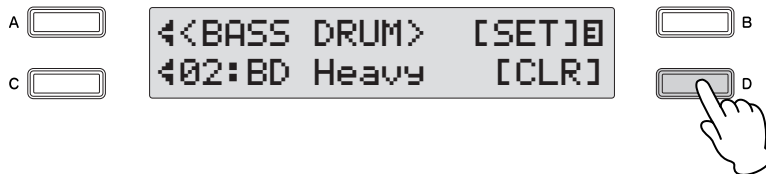

2 Press the [C] button to erase all data. When the [C] button is pressed, a "Completed" message momentarily appears on the display.

The Keyboard Percussion setting you have created is automatically saved when you switch to another display.



Recalling the User Keyboard Percussion

- 1 Press the Keyboard Percussion button.

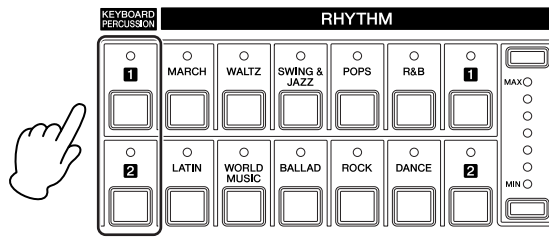

- 2 Select the desired User Keyboard percussion kit.

Press the [C] button to make the “4” indicator flash, then use the DATA CONTROL dial to select the desired User number.

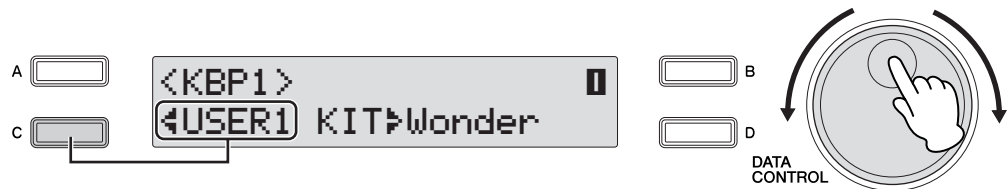

Play some notes on the keyboards and/or Pedalboard.

Kit Assign List

Wonderland Kit

SFX
Laser Beam
Laser Shot
Water Phone
Bubble
Puddle
NATURE
Thunder
Shower
Beach
Stream
DAILY
Footsteps
Door Squeak
Door Slam
Alarm Bell
CuckooClock
Big Clock
Bell
Telephone
Camera
Gnaw
Applause
PERCUSSION
Bass Drum
Gran Cassa
Tom 1
Tom 2
Snare
Snare Roll
HH Closed
HH Open
Cymbal
Tambourine
FingerSnaps
Castanet
Triangle M
Triangle O
Woodblock L
Woodblock H
Handclap
Jingle Bell
Bell Tree
VEHICLE
Train
Horn 1
Horn 2
Siren
Car Engine
Car Crash
Helicopter
Starship
ANIMAL
Sheep
Goat
Oxen
Whinny
Horse
Lion
Dog
Cat
Rooster
Owl
Insects
Frog
Tweet 1
Tweet 2

EL Drum Kit

CYMBAL
Crash Cym 1

Crash Cym 2
Crash Cym M
Ride Cym 1
Ride Cym 2
RideCym Cup
Orch Cym
OrchCymRoll
Orch Cym M
Cym March
Cym BrShot
Tam-Tam
HIHAT
HH Open
HH Close
HH Pedal 1
HH Pedal 2
Analog HH O
Analog HH C
SNARE DRUM
SD Light
SD Heavy
SD Rim 1
SD Rim 2
SD Accent 1
SD Accent 2
SD Reverb 1
SD Reverb 2
Synth SD
Orch SD
SD Roll
Analog SD
SNARE BRUSH
SD BrShot 1
SD BrShot 2
SD BrRoll
TOM
Tom 1
Tom 2
Tom 3
Tom 4
TomBrShot 1
TomBrShot 2
TomBrShot 3
TomBrShot 4
Synth Tom 1
Synth Tom 2
Synth Tom 3
BASS DRUM
BD Light
BD Heavy
BD Attack
Synth BD
BD March
Concert BD
Analog BD S
Analog BD L
CONGA/BONGO
Conga H
Conga L
Conga Slap
Conga Muff
Conga Slide
Bongo H
Bongo L
Bongo Slap
Bongo Mute
CUICA/SURDO
Cuica H
Cuica M
Cuica L
Tamborim O
Tamborim M
Surdo Open

Surdo Mute
Surdo Rim
Surdo Muff
TIMBALE/COWBELL
Timbale 1 H
Timbale 1 L
Timbale 2 H
Timbale 2 L
Timbale 3 H
Timbale 3 L
Timbale 4 H
Timbale 4 L
Cowbell 1
Cowbell 2
Cowbell 3
Cowbell 4
PERCUSSION 1
Cabasa
Shaker
Maracas H
Maracas L
Guiro Short
Guiro Long
WoodBlock H
WoodBlock M
WoodBlock L
Claves
Castanet
Vibraslap
PERCUSSION 2
Agogo H
Agogo L
Triangle O
Triangle M
WindbellDwn
Windbell Up
Tambourine
Pandeiro
Bells
Hand Claps
Finger Snap
Scratch
Noise Perc.
PERCUSSION 3
Kotsuzumi 1
Kotsuzumi 2
Kotsuzumi 3
Kotsuzumi 4
Ohtsuzumi 1
Ohtsuzumi 2
Taiko 1
Taiko 2
Ohdaiko 1
Ohdaiko 2
Kakegoe 1
Kakegoe 2
Kakegoe 3

Standard Kit 1

CYMBAL
Crash Cym 1
Crash Cym 2
Splash Cym
Chinese Cym
Ride Cym 1
Ride Cym 2
RideCym Cup
HH Open
HH Closed
HH Pedal
SNARE DRUM
Snare

Snare Tight
Snare Soft
Snare Roll
Side Stick
OpenRimShot
Brush Tap
Brush Slap
Brush Swirl
Br TapSwirl
TOM
Floor Tom L
Floor Tom H
Low Tom
Mid Tom L
Mid Tom H
High Tom
BASS DRUM
Kick
Kick Tight
Kick Soft
PERCUSSION 1
CongaH Open
Conga L
CongaH Mute
Bongo H
Bongo L
Timbale H
Timbale L
Cowbell
Claves
Guiro Long
Guiro Short
Maracas
Vibraslap
PERCUSSION 2
Surdo Mute
Surdo Open
Cuica Mute
Cuica Open
Cabasa
Shaker
Agogo H
Agogo L
SambaWhis.H
SambaWhis.L
PERCUSSION 3
Tambourine
Castanet
JingleBells
Bell Tree
Triangle O
Triangle M
WoodBlock H
WoodBlock L
Sticks
Whip Slap
Finger Snap
Hand Clap
PERCUSSION 4
Hi Q
Click Noise
Scratch H
Scratch L
Seq Click L
Seq Click H
Metro.Click
Metro.Bell

Standard Kit 2

CYMBAL
Crash Cym 1
Crash Cym 2

Splash Cym
Chinese Cym
Ride Cym 1
Ride Cym 2
RideCym Cup
HH Open
HH Closed
HH Pedal
SNARE DRUM
Snare Short
SnareTightH
SnareSoft 2
Snare Roll
SideStick L
OpRimShot H
Brush Tap
Brush Slap
Brush Swirl
Br TapSwirl
TOM
Floor Tom L
Floor Tom H
Low Tom
Mid Tom L
Mid Tom H
High Tom
BASS DRUM
Kick Short
Kick Tight
Kick Soft
PERCUSSION 1
CongaH Open
Conga L
CongaH Mute
Bongo H
Bongo L
Timbale H
Timbale L
Cowbell
Claves
Guiro Long
Guiro Short
Maracas
Vibraslap
PERCUSSION 2
Surdo Mute
Surdo Open
Cuica Mute
Cuica Open
Cabasa
Shaker
Agogo H
Agogo L
SambaWhis.H
SambaWhis.L
PERCUSSION 3
Tambourine
Castanet
JingleBells
Bell Tree
Triangle O
Triangle M
WoodBlock H
WoodBlock L
Sticks
Whip Slap
Finger Snap
Hand Clap
PERCUSSION 4
Hi Q
Click Noise
Scratch H
Scratch L
Seq Click L
Seq Click H
Metro.Click

Metro.Bell
Hit Kit
CYMBAL
Crash Cym 1
Crash Cym 2
Splash Cym
Chinese Cym
Ride Cym 1
Ride Cym 2
RideCym Cup
HH Open 2
HH Closed 2
HH Pedal 2
SNARE DRUM
SnareAmbien
SnareTight2
Snr Electro
Snare Roll
StickAmbien
Snare Pitch
Brush Tap
Brush Slap
Brush Swirl
Br TapSwirl
TOM
HybridTom 1
HybridTom 2
HybridTom 3
HybridTom 4
HybridTom 5
HybridTom 6
BASS DRUM
KickTight H
Kick Wet
KickTight L
PERCUSSION 1
CongaH Open
Conga L
CongaH Mute
Bongo H
Bongo L
Timbale H
Timbale L
Cowbell
Claves
Guiro Long
Guiro Short
Maracas
Vibraslap
PERCUSSION 2
Surdo Mute
Surdo Open
Cuica Mute
Cuica Open
Cabasa
Shaker
Agogo H
Agogo L
SambaWhis.H
SambaWhis.L
PERCUSSION 3
TambourineL
Castanet
JingleBells
Bell Tree
Triangle O
Triangle M
WoodBlock H
WoodBlock L
Sticks
Whip Slap
Finger Snap
Hand Clap
PERCUSSION 4

Hi Q
Click Noise
Scratch H
Scratch L
Seq Click L
Seq Click H
Metro.Click
Metro.Bell

Room Kit
CYMBAL
Crash Cym 1
Crash Cym 2
Splash Cym
Chinese Cym
Ride Cym 1
Ride Cym 2
RideCym Cup
HH Open
HH Closed
HH Pedal
SNARE DRUM
SnareSnappy
SnrTightSnp
Snare Soft
Snare Roll
Side Stick
OpenRimShot
Brush Tap
Brush Slap
Brush Swirl
Br TapSwirl
TOM
Tom Room 1
Tom Room 2
Tom Room 3
Tom Room 4
Tom Room 5
Tom Room 6
BASS DRUM
Kick
Kick Tight
Kick Soft
PERCUSSION 1
CongaH Open
Conga L
CongaH Mute
Bongo H
Bongo L
Timbale H
Timbale L
Cowbell
Claves
Guiro Long
Guiro Short
Maracas
Vibraslap
PERCUSSION 2
Surdo Mute
Surdo Open
Cuica Mute
Cuica Open
Cabasa
Shaker
Agogo H
Agogo L
SambaWhis.H
SambaWhis.L
PERCUSSION 3
Tambourine
Castanet
JingleBells
Bell Tree
Triangle O
Triangle M

WoodBlock H
WoodBlock L
Sticks
Whip Slap
Finger Snap
Hand Clap
PERCUSSION 4
Hi Q
Click Noise
Scratch H
Scratch L
Seq Click L
Seq Click H
Metro.Click
Metro.Bell

Rock Kit
CYMBAL
Crash Cym 1
Crash Cym 2
Splash Cym
Chinese Cym
Ride Cym 1
Ride Cym 2
RideCym Cup
HH Open
HH Closed
HH Pedal
SNARE DRUM
Snare Rock
SnRockTight
Snare Noisy
Snare Roll
Side Stick
OpenRimShot
Brush Tap
Brush Slap
Brush Swirl
Br TapSwirl
TOM
Tom Rock 1
Tom Rock 2
Tom Rock 3
Tom Rock 4
Tom Rock 5
Tom Rock 6
BASS DRUM
Kick Gate
Kick 2
Kick Soft
PERCUSSION 1
CongaH Open
Conga L
CongaH Mute
Bongo H
Bongo L
Timbale H
Timbale L
Cowbell
Claves
Guiro Long
Guiro Short
Maracas
Vibraslap
PERCUSSION 2
Surdo Mute
Surdo Open
Cuica Mute
Cuica Open
Cabasa
Shaker
Agogo H
Agogo L
SambaWhis.H
SambaWhis.L

PERCUSSION 3
Tambourine
Castanet
JingleBells
Bell Tree
Triangle O
Triangle M
WoodBlock H
WoodBlock L
Sticks
Whip Slap
Finger Snap
Hand Clap
PERCUSSION 4
Hi Q
Click Noise
Scratch H
Scratch L
Seq Click L
Seq Click H
Metro.Click
Metro.Bell

Electro Kit

CYMBAL
Crash Cym 1
Crash Cym 2
Splash Cym
Chinese Cym
Ride Cym 1
Ride Cym 2
RideCym Cup
HH Open
HH Closed
HH Pedal
SNARE DRUM
SnareNoisy2
SnareNoisy3
SnrSnapElec
Snare Roll
Side Stick
OpenRimShot
Brush Tap
Brush Slap
Brush Swirl
Reverse Cym
TOM
TomElectro1
TomElectro2
TomElectro3
TomElectro4
TomElectro5
TomElectro6
BASS DRUM
KickGateHvy
Kick Gate
Kick 3
PERCUSSION1
CongaH Open
Conga L
CongaH Mute
Bongo H
Bongo L
Timbale H
Timbale L
Cowbell
Claves
Guiro Long
Guiro Short
Maracas
Vibraslap
PERCUSSION 2
Surdo Mute
Surdo Open
Scratch H 2

Scratch L 2
Cabasa
Shaker
Agogo H
Agogo L
SambaWhis.H
SambaWhis.L
PERCUSSION 3
Tambourine
Hi Q 2
JingleBells
Bell Tree
Triangle O
Triangle M
WoodBlock H
WoodBlock L
Sticks
Whip Slap
Finger Snap
Hand Clap
PERCUSSION 4
Hi Q
Click Noise
Scratch H
Scratch L
Seq Click L
Seq Click H
Metro.Click
Metro.Bell

Analog Kit

CYMBAL
CrashAnalog
Crash Cym 2
Splash Cym
Chinese Cym
Ride Cym 1
Ride Cym 2
RideCym Cup
Hat Open An
Hat CloseAn
HatCloseAn2
SNARE DRUM
SnareAnalog
SnareAnlg 2
SnareNoisy4
Snare Roll
SideStickAn
OpenRimShot
Brush Tap
Brush Slap
Brush Swirl
Reverse Cym
TOM
TomAnalog 1
TomAnalog 2
TomAnalog 3
TomAnalog 4
TomAnalog 5
TomAnalog 6
BASS DRUM
Kick Analog
KickAnlgSht
Kick 3
PERCUSSION 1
CongaAnlg M
CongaAnlg L
CongaAnlg H
Bongo H
Bongo L
Timbale H
Timbale L
CowbellAnlg
Claves 2
Guiro Long

Guiro Short
Maracas 2
Vibraslap
PERCUSSION 2
Surdo Mute
Surdo Open
Scratch H 2
Scratch L 2
Cabasa
Shaker
Agogo H
Agogo L
SambaWhis.H
SambaWhis.L
PERCUSSION 3
Tambourine
Hi Q 2
JingleBells
Bell Tree
Triangle O
Triangle M
WoodBlock H
WoodBlock L
Sticks
Whip Slap
Finger Snap
Hand Clap
PERCUSSION 4
Hi Q
Click Noise
Scratch H
Scratch L
Seq Click L
Seq Click H
Metro.Click
Metro.Bell

Jazz Kit

CYMBAL
Crash Cym 1
Crash Cym 2
Splash Cym
Chinese Cym
Ride Cym 1
Ride Cym 2
RideCym Cup
HH Open
HH Closed
HH Pedal
SNARE DRUM
SnareJazz L
SnareJazz M
SnareJazz H
Snare Roll
SideStick L
OpenRimShot
Brush Tap
Brush Slap
Brush Swirl
Br TapSwirl
TOM
Floor Tom L
Floor Tom H
Low Tom
Mid Tom L
Mid Tom H
High Tom
BASS DRUM
Kick Jazz
Kick Tight
Kick Soft
PERCUSSION 1
CongaH Open
Conga L
CongaH Mute

Bongo H
Bongo L
Timbale H
Timbale L
Cowbell
Claves
Guiro Long
Guiro Short
Maracas
Vibraslap
PERCUSSION 2
Surdo Mute
Surdo Open
Cuica Mute
Cuica Open
Cabasa
Shaker
Agogo H
Agogo L
SambaWhis.H
SambaWhis.L
PERCUSSION 3
Tambourine
Castanet
JingleBells
Bell Tree
Triangle O
Triangle M
WoodBlock H
WoodBlock L
Sticks
Whip Slap
Finger Snap
Hand Clap
PERCUSSION 4
Hi Q
Click Noise
Scratch H
Scratch L
Seq Click L
Seq Click H
Metro.Click
Metro.Bell

Brush Kit

CYMBAL
Crash Cym 1
Crash Cym 2
Splash Cym
Chinese Cym
Ride Cym 1
Ride Cym 2
RideCym Cup
HH Open
HH Closed
HH Pedal
SNARE DRUM
BrushSlap 3
Brush Tap 2
BrushSlap 2
Snare Roll
SideStick L
OpenRimShot
Brush Tap
Brush Slap
Brush Swirl
Br TapSwirl
TOM
Tom Brush 1
Tom Brush 2
Tom Brush 3
Tom Brush 4
Tom Brush 5
Tom Brush 6
BASS DRUM

Kick Jazz
Kick Tight
Kick Soft
PERCUSSION 1
CongaH Open
Conga L
CongaH Mute
Bongo H
Bongo L
Timbale H
Timbale L
Cowbell
Claves
Guiro Long
Guiro Short
Maracas
Vibraslap
PERCUSSION 2
Surdo Mute
Surdo Open
Cuica Mute
Cuica Open
Cabasa
Shaker
Agogo H
Agogo L
SambaWhis.H
SambaWhis.L
PERCUSSION 3
Tambourine
Castanet
JingleBells
Bell Tree
Triangle O
Triangle M
WoodBlock H
WoodBlock L
Sticks
Whip Slap
Finger Snap
Hand Clap
PERCUSSION 4
Hi Q
Click Noise
Scratch H
Scratch L
Seq Click L
Seq Click H
Metro.Click
Metro.Bell

Symphony Kit

CYMBAL
Hand Cymbal
Hand Cym 2
Splash Cym
Chinese Cym
Hand Cym S
HandCym 2 S
RideCym Cup
HH Open
HH Closed
HH Pedal
SNARE DRUM
Band Snare
BandSnare 2
Snare Soft
Snare Roll
Side Stick
OpenRimShot
Brush Tap
Brush Slap
Brush Swirl
Br TapSwirl
TOM

Floor Tom L
Floor Tom H
Low Tom
Mid Tom L
Mid Tom H
High Tom
BASS DRUM
GranCassa M
Gran Cassa
Kick Soft 2
PERCUSSION 1
CongaH Open
Conga L
CongaH Mute
Bongo H
Bongo L
Timbale H
Timbale L
Cowbell
Claves
Guiro Long
Guiro Short
Maracas
Vibraslap
PERCUSSION 2
Surdo Mute
Surdo Open
Cuica Mute
Cuica Open
Cabasa
Shaker
Agogo H
Agogo L
SambaWhis.H
SambaWhis.L
PERCUSSION 3
Tambourine
Castanet
JingleBells
Bell Tree
Triangle O
Triangle M
WoodBlock H
WoodBlock L
Sticks
Whip Slap
Finger Snap
Hand Clap
PERCUSSION 4
Hi Q
Click Noise
Scratch H
Scratch L
Seq Click L
Seq Click H
Metro.Click
Metro.Bell

SFX1

SFX
CutingNoiz1
CutingNoiz2
String Slap
Fl.KeyClick
Shower
Thunder
Wind
Stream
Bubble
Feed
Ghost
Maou
Dog
Horse
Bird Tweet

SFX2

SFX 1
Phone Call
Phone Ring
Wind Chime
Door Squeak
Door Slam
Scratch Cut
Scratch H 3
Laugh
Scream
Punch
Heart Beat
Foot Steps
SFX 2
CarEngrlgni
CarTiresSql
Car Passing
Car Crash
Siren
Train
Jet Plane
Starship
Burst
Coaster
Submarine
Machine Gun
Laser Gun
Explosion
Firework

Arabic Kit

ARABIC 1
Nakarazan D
Nakarazan E
Hager Dom
Hager Edge
Zagrouda H
Zagrouda L
Arabic Clap
Duhulla Dom
Duhulla Tak
Duhulla Sak
Doff Dom
Doff Tak
ARABIC 2
Katem Dom
Katem Tak
Katem Sak
Tabla Dom
Tabla Tak 1
Tabla Tak 2
Tabla Sak
Tabla Tik
Tabla Roll
Tabla Flam
Tabel Dom
Tabel Tak
ARABIC 3
Sagat 1
Sagat 2
Sagat 3
Rik Dom
Rik Tak 1
Rik Tak 2
Rik Sak
Rik Tik
Rik Finger1
Rik Finger2
Rik Tremolo
CYMBAL/SNARE DRUM
Crash Cym 1
Crash Cym 2
Ride Cym 1
HH Open

HH Closed
HH Pedal
Snare Drum
Snare Soft
Side Stick
TOM/BASS DRUM
Floor Tom L
Floor Tom H
Low Tom
Mid Tom L
Mid Tom H
High Tom
Kick Soft
PERCUSSION
CongaH Open
Conga L
CongaH Mute
Bongo H
Bongo L
Cowbell
Claves
Cabasa
Tambourine

Registration Memory

Registration Memory is a powerful performance tool that helps you sound like a professional. It lets you store virtually all the settings you make on the panel and LCD, conveniently allowing you to instantly change all Voice settings and rhythms while you're playing—simply by pressing a single Registration Memory button. The buttons are conveniently located at the top right on the panel for easy access while playing. Just press the numbered button that corresponds to the Registration you wish to select. Moreover, you can also recall the settings using the right footswitch. All Registrations in Registration Memory can also be saved to USB flash memory.

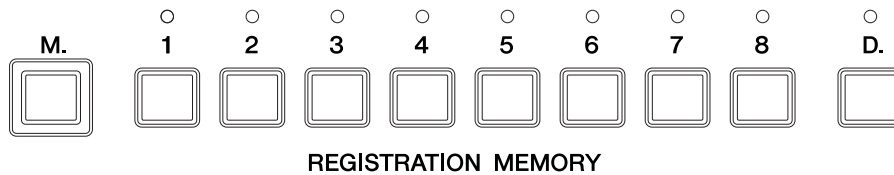

Various types of basic Registrations have been programmed to the numbered Registration Memory buttons [1] – [8], with additional Registration Memory presets 9 – 16 which can also be called up easily. You can of course record your own Registration settings to a numbered button, but keep in mind that the preset Registration for that button will be overwritten and erased. You can recall the original factory preset settings (and delete your own) by initializing the Registration Memory.

Basic Registration

No.	Image
1	Strings ensemble
2	Brass ensemble
3	Woodwind ensemble
4	Orchestra
5	Flute combo
6	Piano ballad
7	Jazz combo
8	Pop ballad

No.	Image
9	Big band jazz
10	Rock band
11	Fun time
12	Synth pop
13	Pop organ
14	Cathedral
15	Synth bell
16	Music box

1 Storing Registrations

Your newly created Registrations you make can be stored to the Registration Memory panel buttons. All Registrations in Registration Memory can also be saved to USB flash memory.

- 1 **Create your original Registration by making all desired panel settings.**



Reference Pages

Selecting a Voice (page 25)
 Selecting a Rhythm (page 56)
 Voice Controls and Effects (page 40)

2 While holding down the [M.] (Memory) button in the Registration Memory section, press the numbered button to which you wish to save your Registration.

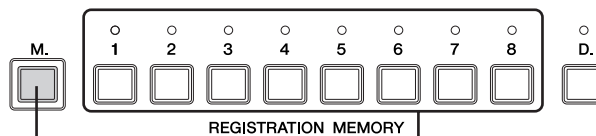

1. While holding down [M.] button...

2. Press desired numbered button.

When the Registration is stored, the LED above the numbered the numbered button flashes momentarily.

Although the ELB-01 has just eight Registration Memory buttons, up to sixteen Registrations can be stored. To store Registrations 9 – 16, simultaneously hold down both the [VOICE DISPLAY] button in the Display Select section and the [M.] (Memory) button in the Registration Memory, and press the desired numbered button (in this case, indicated as [1] – [8]) to which you wish to save your Registration. When the Registration is stored, the numbered button's LED flashes momentarily.



Do not turn the power off while the Registration is being saved.

Functions and settings that cannot be memorized:

- Pitch (page 150)
- MIDI Control settings (page 161)
- LCD related settings (page 19)

The following settings are common to all Registration Memory numbers 1 – 16 and cannot be stored individually for each number.

- Transpose (page 150)
- Registration Shift (page 102)
- Auto Fill setting (page 60)
- Reverb type (page 48)
- User rhythms (page 64)
- User Keyboard Percussion (page 92)
- Rhythm Sequences (page 75)
- Disable setting (page 99)



Reference Page

Saving Registrations as Registration Data (File); (page 124)

2 Selecting Registrations

Simply press the numbered button ([1] – [8]) that corresponds to the Registration you wish to select. (The selected button's LED lights.)

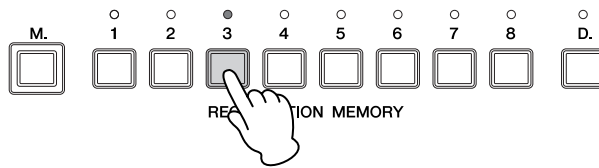

To call up one of the Registrations 9 – 16, simultaneously hold down the [VOICE DISPLAY] button in the Display Select section and press the appropriate numbered button. (For Registrations 9 – 16, the LEDs do not light.)

Example: Calling up Registration Number 11

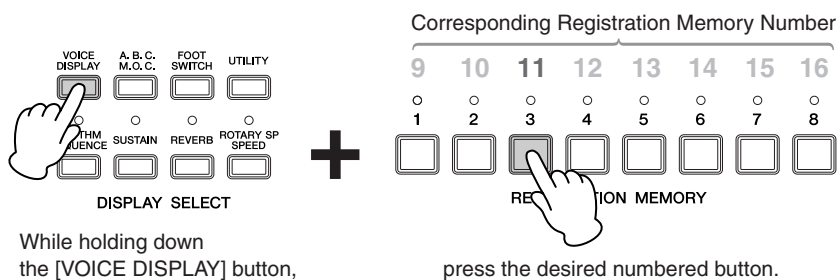

You can also recall Registrations in a pre-programmed order by using the right footswitch. This function is called “Registration Shift” (page 102).

Using the [D.] (Disable) button:

Keep in mind that rhythm and automatic accompaniment patterns also change when you select different Registration Memory buttons. There may be times during your performance when you want to keep the same rhythm going, even when you make Registration Memory changes. Pressing the [D.] (Disable) button allows you to keep the same rhythm, accompaniment patterns, tempo, and so on throughout all your Registration changes, or make your own rhythm selections if you want to. When the [D.] button is on, the following functions will not change, even when you change the Registration Memory number.

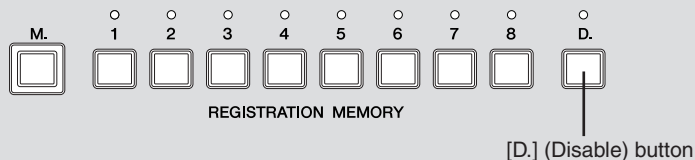

- Rhythm menu, Rhythm section, Rhythm tempo, Rhythm volume, Rhythm reverb
- Accompaniment volume, Accompaniment reverb, On/Off status of Accompaniment parts
- A.B.C. mode, A.B.C. memory
- M.O.C. mode

3 Initializing Registration Memory

If you want to restore the original factory-programmed Registration Memory presets, you can initialize the Electone settings. Keep in mind that this deletes any of your custom Registration Memory and LCD Display settings. Always save your important data to external media, such as USB flash memory.

When turning the power on after initializing the Electone, the preset settings will be recalled and your own Registration setting(s) will be erased and replaced with the factory defaults.

For details on how to initialize the Electone, refer to “Factory Set (Initializing the Electone)” on page 20.

4 Saving the Registration data to USB flash memory

You can save your Registration Memory settings to an external storage device, such as USB flash memory, with sixteen Registrations stored to a single file.

For details about using other external storage devices, see Chapter 6, Music Data Recorder (M.D.R.). The instructions below explain how to save the Registration data to a USB flash memory.



Reference Page

Songs (page 116)



Reference Page

USB TO DEVICE terminal (page 151)

1 Insert the USB flash memory into the USB TO DEVICE terminal.

2 Press the [MDR] button.

The MDR display appears.

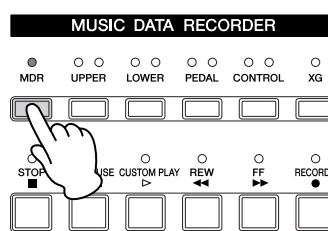

<SONG SELECT> [M] [4]
001:USB 01

3 Select the song to which you want to save the Registration data (page 124).

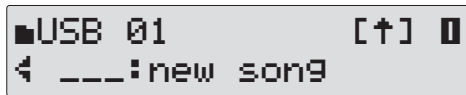

4 Press the PAGE buttons to select Page 9.
 The Registration Save Page is displayed.

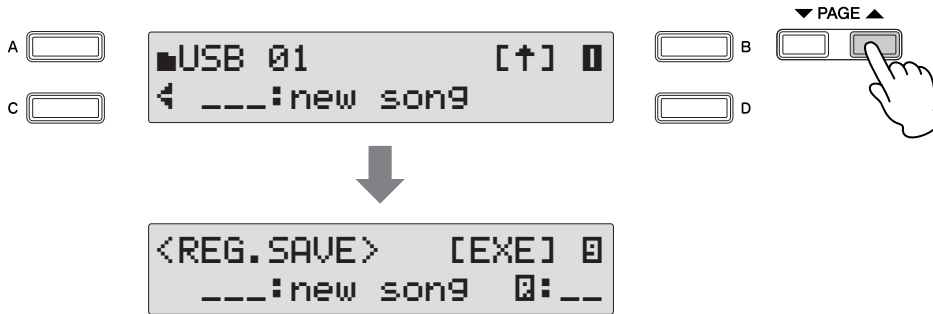

5 Press the [B] button corresponding to the [EXE] (Execute) in the display.

A message appears, indicating the Registration data is currently being saved. When the operation is completed, the message closes. Your Registration Memory settings are saved to the external storage device, with sixteen Registrations stored to a single file.

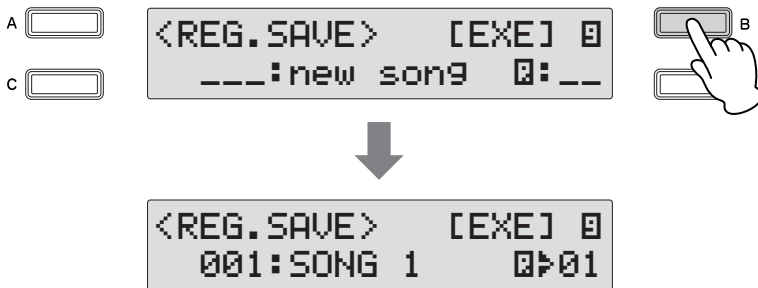

Reference Pages

Recalling Recorded Registrations (page 131)

Changing the Song/Folder Name (page 122)

5 Registration Shift

The Registration Shift function conveniently allows you to change Registrations without taking your hands from the keyboards.

By using the Right Footswitch on the expression pedal, you can “jump” to a specified Registration or step through the panel Registrations in sequence, either in numeric order or in any order you specify.

You can set the Registration Shift order in the Registration Shift display.

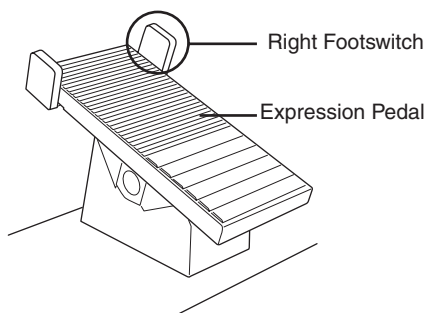

NOTE

Pressing the [FOOTSWITCH] button calls up one of two different displays, the Registration Shift Display or Footswitch Display. These displays can be switched by pressing the A button. When you press the [FOOTSWITCH] button, the previously selected display will appear.

1 Press the [FOOTSWITCH] button.

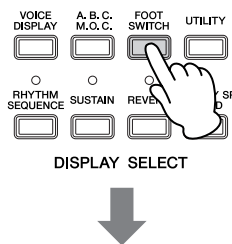

If the Footswitch Page is displayed, press the [A] button to switch to the Registration Shift Page.

2 Registration Shift has three modes: Shift, Jump and User. These are set in the Regist Shift display by turning the DATA CONTROL dial.

Select each in order (Shift → Jump → User) by turning the DATA CONTROL dial clockwise. Turning the DATA CONTROL dial counter-clockwise selects in the reverse order. The [C] button can also be used to select the modes.

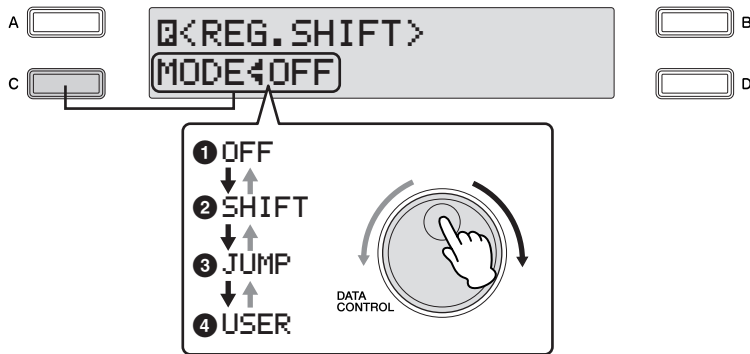

1 Off

Turns off the Registration Shift assignment. When Off is selected, Registrations cannot be changed by using the Right Footswitch.



2 Shift

In the Shift mode, each press of the Right Footswitch selects the Registration Memory presets in their numerical order. After the last Registration is reached, the function ‘wraps around’ to select the first preset again. The LEDs of numbered buttons ([1] – [8]) light up as they are selected. Keep in mind that the numbered buttons’ LEDs do not light up if Registrations 9 – 16 are selected.



3 Jump

Pressing the Right Footswitch jumps to select the designated panel Registration. Press the [D] button to make the “▶” indicator flash, then select the Jump “destination” with the DATA CONTROL dial or [D] button.

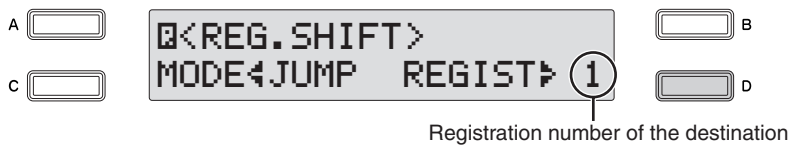

4 User

In the User mode, each press of the Right Footswitch selects Registrations according to the order you’ve specified. You can also specify an end point for the Registration Shift function. User Shift can be set in Page 2, and Shift End can be set in Page 1 of the Registration Shift display.



To set the User Registration order:

- 1 Press the PAGE buttons to select Page 2.

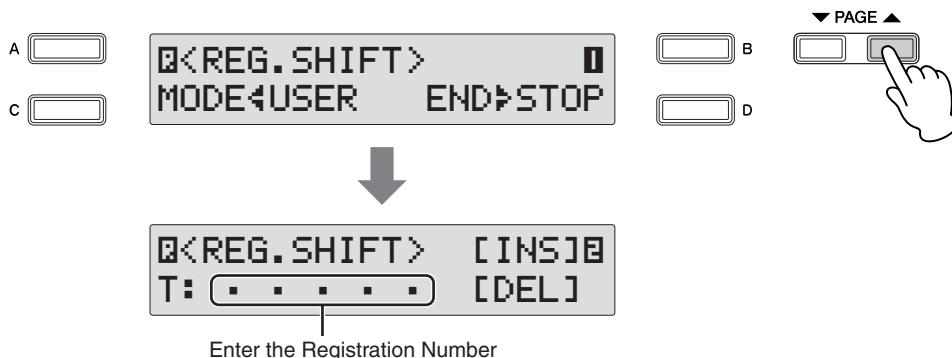

NOTE

When you want to set Registration Memory 9 – 16, press the desired numbered button while holding down the [VOICE DISPLAY] button. (The Voice display appears.) Press the [FOOTSWITCH] button to call up Page 2 of the Registration Shift display.

- 2 Press the desired numbered button in the Registration Memory section.

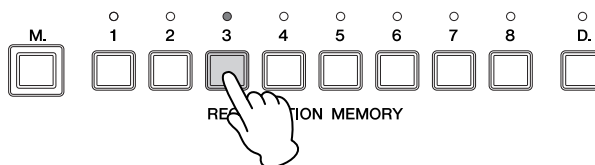

- 3 Press the [B] button corresponding to the [INS] (Insert) in the display.

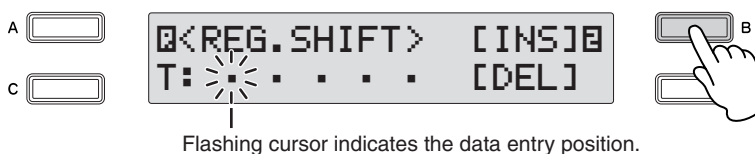

- 4 The Registration number appears in the display, indicating that the Registration is entered.



- 5 Repeat steps 2 through 4 above to set additional numbers in the Registration order.

Up to 80 steps (Registrations) can be memorized.

Move the cursor to the desired point with the [C] button or DATA CONTROL dial, then insert or delete the desired number by using the [B] and [D] buttons.

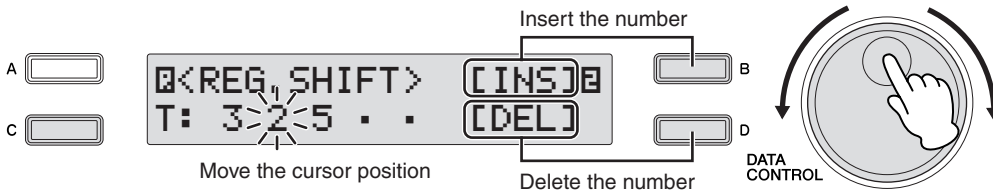

Data Entry Position: Flashing cursor indicates the current data entry position.

If you want to move the cursor to the left, press the [C] button or turn the DATA CONTROL dial counter-clockwise. If you want to move the cursor to the right, turn the DATA CONTROL dial clockwise.

Insert: Use the [B] button.

This is for initially entering a Registration number to a blank space in the Registration row, or for replacing a number at the current cursor position. To enter a number, press the desired Registration Memory button, then press the [B] button corresponding to [INS] (Insert) in the display. The entered Registration number will appear in the Registration row. After using [INS] to enter Registrations, the cursor can be moved among the numbers.

Insert can also be used to insert a Registration number just before the current cursor position. To perform the operation, first move the data entry position to a numbered position. Then, press the desired Registration Memory button, and press the [B] button corresponding to [INS] (Insert) in the display. The new Registration number is inserted at the cursor position and all other numbers to the right of the cursor are moved to accommodate the new numbers. Registration numbers cannot be entered beyond the Registration Shift function's capacity of 80. If the insert operation exceeds this capacity, a "Cannot insert additional data" message appears and the operation cannot be executed.

Delete: Use the [D] button.

To delete the unnecessary number, move the cursor to a numbered position and press the [D] button corresponding to [DEL] (Delete) in the display.



NOTE

Registration data cannot be added or deleted when the cursor position is at the "T" (found at the lower left of the screen) after inputting the number. Add or delete the data after moving the cursor by rotating the DATA CONTROL dial clockwise.



NOTE

Up to six Registration numbers can be displayed at once in the LCD; however, screen scrolling is enabled when five or more Registration numbers are input. Turn the DATA CONTROL dial counter-clockwise to scroll back toward the beginning.

Shift End:

Determines the end point for the Registration Shift function.

Press the PAGE buttons to select Page 1.

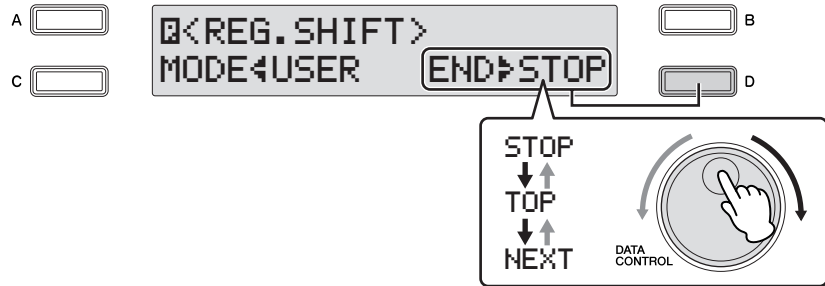

Press the [D] button to make the “” indicator flash, then use the DATA CONTROL dial to change the setting.



Stop: Selects the last Registration and quits the operation.

Top: After the last preset is reached, the first preset is called up again, starting the sequence over again from the beginning.

Next Regist: After the last preset is reached, the next Registration data in the Song is called up. This function is available only when two or more Registration data sets are saved in one Song. This function is handy when you need to play a song with more than sixteen Registrations.

The Shift End mark (: Top, : Next) will automatically be put at the end of the Registrations you entered when Top or Next Regist is selected as the Shift End.



Reference Page

Saving Two or More Registration Banks to One Song (page 126)



NOTE

In order to playback a song on the MDR used by the next Registration, press the [PLAY/PAUSE] button (not the [CUSTOM PLAY] button), then start the MDR.

Music Data Recorder (MDR)

The Music Data Recorder (M.D.R.) is a sophisticated recording system built into the Electone that lets you record your performances and Registration settings to a USB flash memory device or other external media. Moreover, the M.D.R. allows you to perform various other operations to your song data (such as copy, delete and convert).

Before purchasing any USB storage device, you should check with your Yamaha dealer or an authorized Yamaha distributor for advice on compatibility.

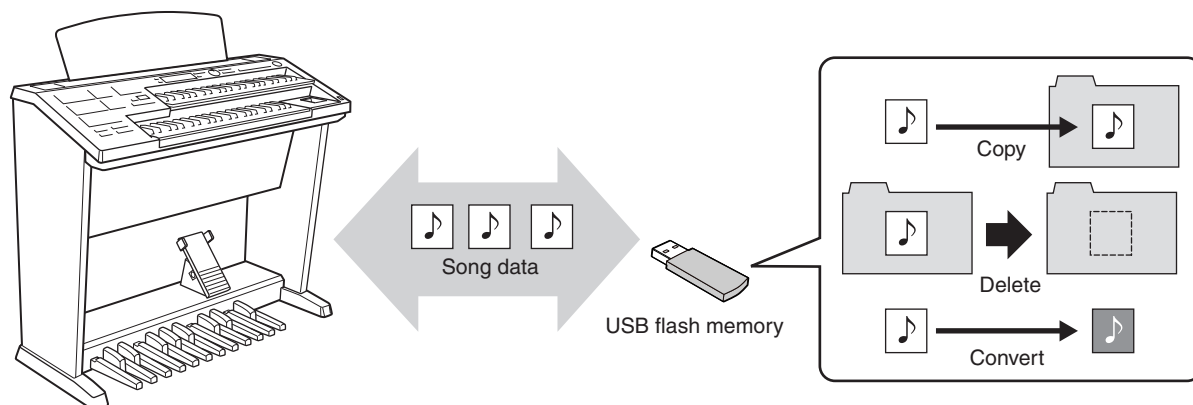

By installing the optional UD-FD01 floppy disk drive to the ELB-01, you can play songs stored to floppy disks. For information on how to install the UD-FD01, see page 167. Keep in mind, however, that you cannot save special Protected Original Songs or the Protected Edit Songs to floppy disks. For details about these protected songs, see page 139.

Before using a USB device, read through the important section “Precautions when using the USB TO DEVICE terminals” on page 155. About USB devices compatible with the Electone, see “Compatible USB devices” on page 155.

To protect your data (write-protect switch):

Some USB flash memory devices are equipped with a write-protect switch. To prevent accidental erasure of important data saved in USB flash memory, slide the write-protect switch on the device to the “protect” position. When saving data, make sure that the write-protect switch is set to the “overwrite” position.

1 Using the M.D.R. Function

Press the [MDR] button in the panel to call up the M.D.R. display. All operations related to the M.D.R., such as recording and playing your performances, can be done in the M.D.R. display.



NOTE

If you press the [MDR] button even when no media is inserted into the USB TO DEVICE terminal, the selection “Internet” appears at the bottom of the display. However, the Internet function is not available.

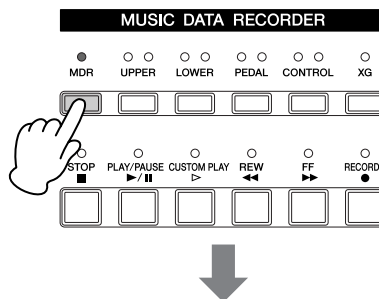

MDR Display



The M.D.R. display consists of thirteen display Pages. Each Page is devoted to a specific function, and you can call up the desired function or operation by selecting the appropriate Page. (For example, select Page 4 to change the name of the recorded song, or Page 8 to recall the recorded registrations.)

Pressing any button other than the [MDR] button while the M.D.R. display is open exits from the M.D.R. display. If you exit from the function inadvertently, simply press the [MDR] button again to recall the M.D.R. display.

After executing operations such as deleting or converting songs, make sure to return to Page 1 (Song Select display).

Display		Page Function
Page 1	Song Select	Select a song.
Page 2	Playback Setting	Set the playback tempo or order.
Page 3	Part	Set the recording status for Lead or KBP.
Page 4	Rename	Change the name of a song/folder.
Page 5	Copy	Copy a song.
Page 6	Delete	Delete a song/folder.
Page 7	Convert	Convert the data format.
Page 8	Registration Load	Load Registration data back to the ELB-01.
Page 9	Registration Save	Save Registration data to external media.
Page 10	Registration Delete	Delete Registrations from a song.
Page 11	Create Folder	Create a folder.
Page 12	Format	Format the media.
Page 13	Remain	Check the remaining memory.

2 Formatting External Media

If you find that you are unable to use new, blank USB flash memory/floppy disks or old ones that have been used with other devices, you may need to format them. Formatting erases all the data in the media and makes it ready to record. The data erased by formatting will be lost permanently. Check whether or not the media contains any important data you wish to keep before executing the operation

1 Insert the media into the USB TO DEVICE terminal.

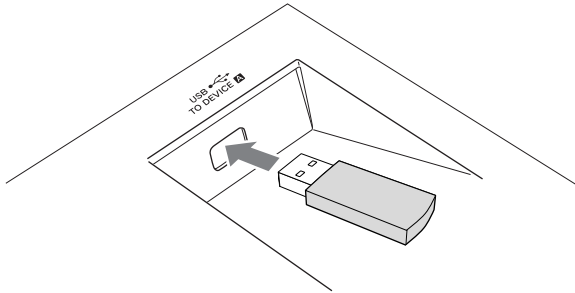

2 Press the [MDR] button on the panel to call up the M.D.R. display.

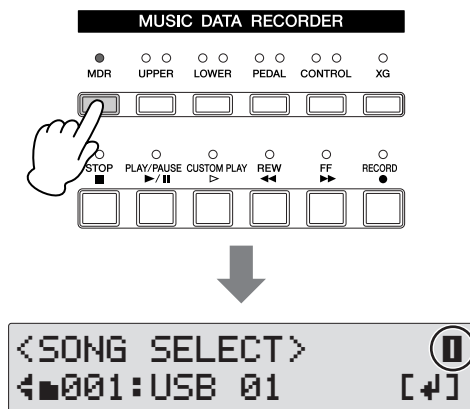

3 Select the desired media you want to format.



To format a USB flash memory device, select “USB xx” (xx indicates the number of the device). If you insert two media/devices, the media inserted first will be shown as “USB 01” and the latter one will be shown as “USB 02.”

Select the desired media by turning the DATA CONTROL dial or by successive pressing of the [C] button when the desired media is not displayed



NOTE

By installing the optional UD-FD01 floppy disk drive to the ELB-01, you can format floppy disks. Floppy disks will be shown in the display as “USB-FDxx” (xx indicates the number of the disk).

4 Press the PAGE buttons to select Page 12.

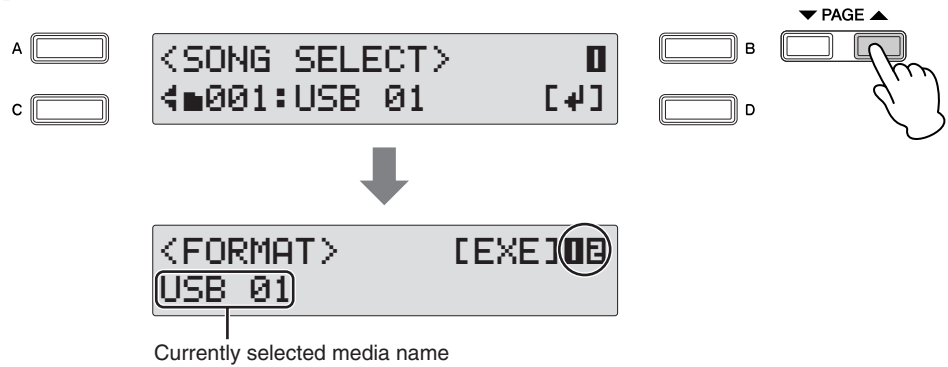

The Format display appears.

5 Press the [B] button corresponding to [EXE] (Execute) in the display.

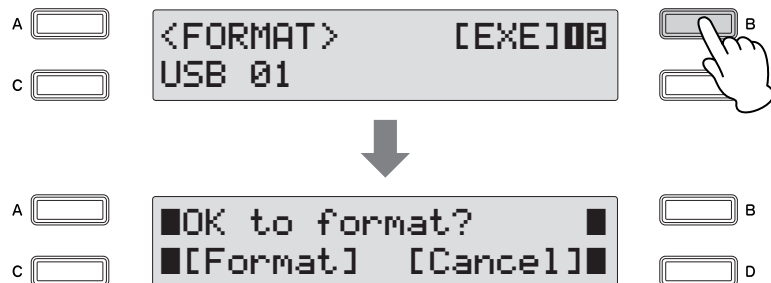

A message appears prompting confirmation of operation. You can cancel the operation at this point by pressing the [D] button corresponding to [Cancel].

6 Press the [C] button, corresponding to [Format] in the display, to format the media.



CAUTION

Do not remove the media while the formatting operation is in process.

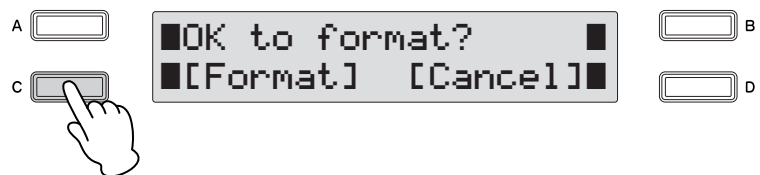

When the operation is completed, the LCD returns to Page 12 (Format display). Simultaneously press the PAGE buttons to return to Page 1 (Song Select display).

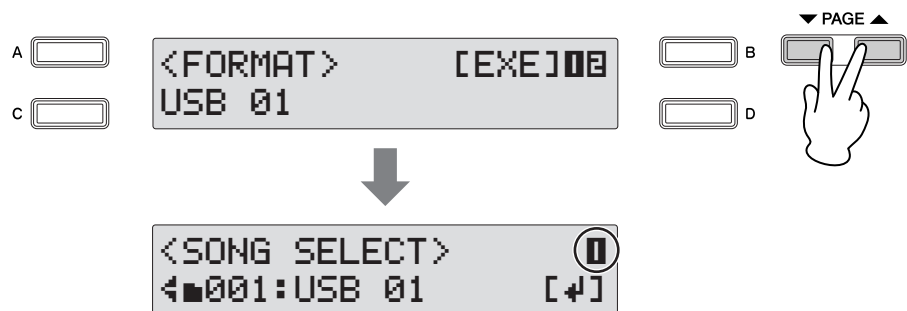

3 Selecting a Song

In order to record your performance to the media or to load Registrations in the media back to the Electone, you will need to select a song, as described below.

What is a Song?

You can think of a song as a “container” for storing the Electone data for a piece of music, recorded to external media. A single song can contain both the recorded performance and Registrations.

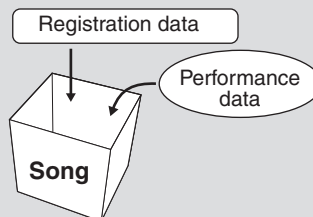

Reference Page

Media Contents: Folders, Songs, and Files (page 116)

To record your performance, you will need to specify a Song for recording. To copy or convert songs, you will need to specify not only the song to be copied or converted but also the song to which you want to save the newly created data.

To select the desired song:

- 1 Insert the media into the USB TO DEVICE terminal, then press the [MDR] button.

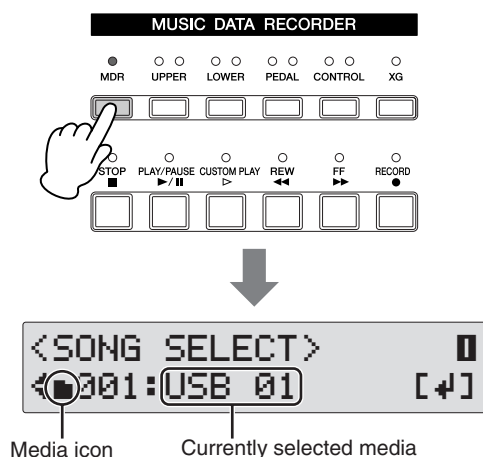

CAUTION

While the instrument is accessing data, do NOT remove the media. (Some USB flash memory devices are equipped with an LED. The LED will flash while the media is being accessed.)

The Song Select display (Page 1) appears.

In the Song Select display, you can select a blank song for recording your performance or saving the Registration settings, or you can select a desired song for playback.

2 Select the desired media.

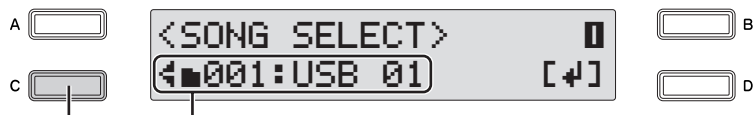

To use a USB flash memory device, select “USB xx” (xx indicates the number of the device). If you insert two USB flash memory devices, the device inserted first will be shown as “USB 01” and the latter one will be shown as “USB 02.” To use a floppy disk, select “USB-FD xx” (xx indicates the number of the disk). Select the desired media by turning the DATA CONTROL dial or by successive pressing of the [C] button when the desired media is not displayed.

When selecting the media, the selection “Internet” will appear at the bottom of the display. However, the Internet function is not available.

3 Select a Song

Press the [D] button corresponding to the [+] in the display, to call up the desired song or folder in the selected media.

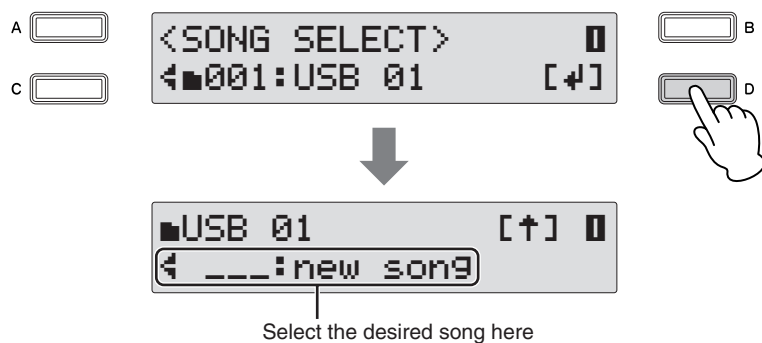

If the selected media has no data, “new song” (blank song) will be selected automatically. If the selected media contains both folders and songs, the folder will be selected first, and you can use the DATA CONTROL dial to select the following items in sequence: folders → new song → songs (containing data) by turning the DATA CONTROL dial clockwise. You can also select the song (folder) by successively pressing the [C] button.

For details about how to select songs in a folder, see “Selecting a Song in a Folder” on page 113.

Select a “new song” (blank song) if you want to make a new recording or save data.



The new song is a blank song which is automatically created in the media/folder, if the number of the songs in the media/folder is less than 100.

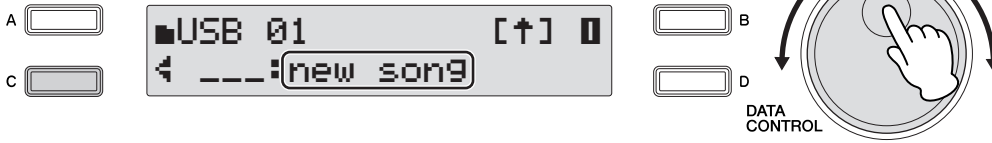

Recording (page 117)

To simply play an existing song, select the desired song (containing data), referring to the song name and icons



Changing the Song/Folder Name (page 122)
Song Icons (page 116)

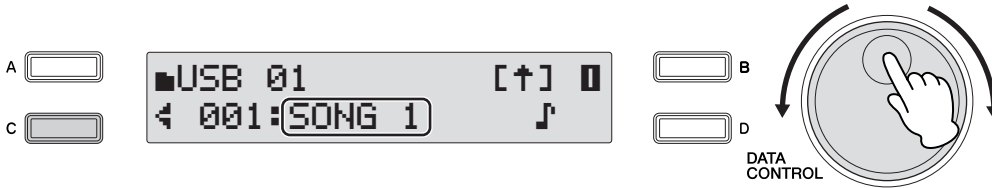

Playing Back a Song (page 132)

Selecting the Song in the Folder:

Keep in mind that, depending on much data stored in your device and how many folders have been created, the song you want to use may be easily located in the media’s root directory, or it may be buried deep in the folder hierarchy with other songs. The illustrations below shows you how to use the display to access a specific song in a folder of a storage device (in this case, calling up the song “Twinkle Twinkle Little Star”).

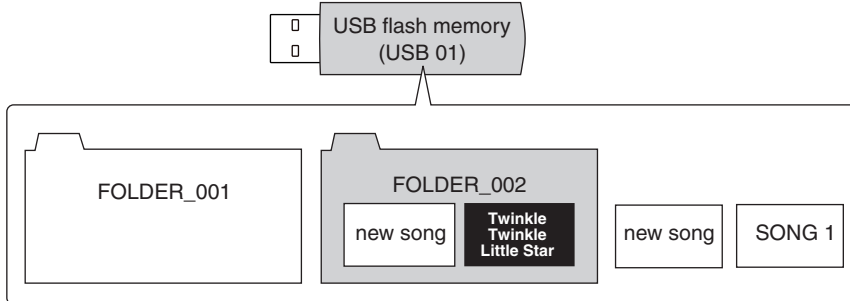

The new song is a blank song which is automatically created in the media/folder unless the number of the songs in the media/folder is under 100.

The illustration below shows the levels of folders and songs in the device. Follow the dark arrows and the accompanying instruction steps to select the desired song, “Twinkle Twinkle Little Star.”

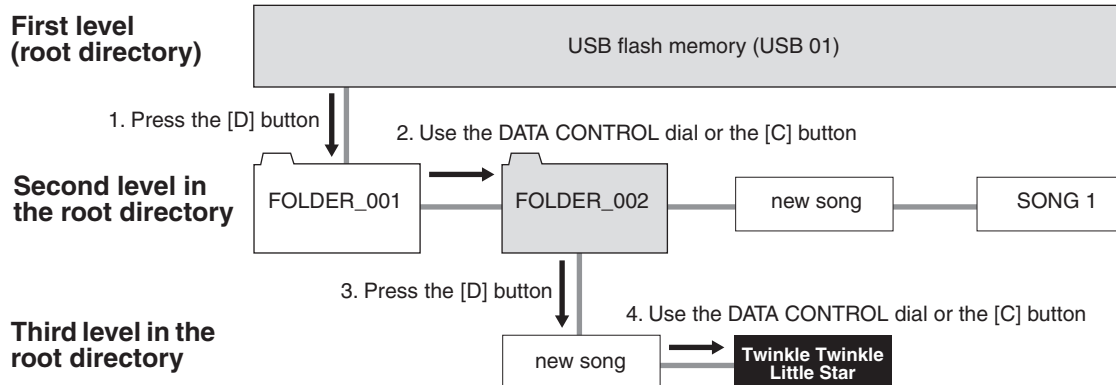

Songs or folders in the same level can be selected in sequence by turning the DATA CONTROL dial or by successively pressing the [C] button.

Here is the actual procedure again, in linear form:

- 1 Press the [D] button to call up the folder in the selected media at the bottom of the display.

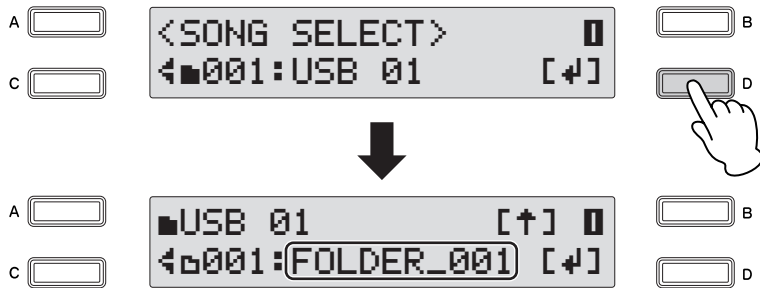

FOLDER_001 is displayed.

- 2 Select the FOLDER_002 by turning the DATA CONTROL dial or successively pressing the [C] button.

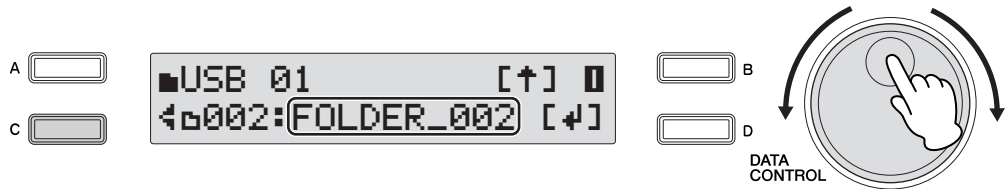

- 3 Press the [D] button to call up the song in the FOLDER_002 at the bottom of the display.

In this case, "new song" is displayed.

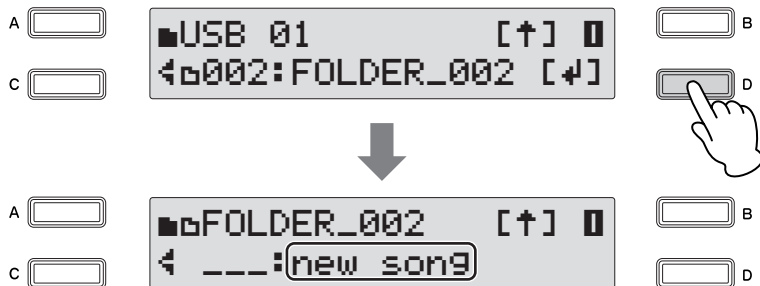

- 4 Select the desired song, "Twinkle Twinkle Little Star," by turning the DATA CONTROL dial or by successively pressing the [C] button.

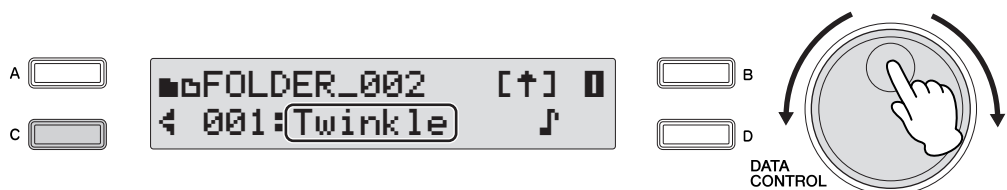

To change the Media/Folder:

Make sure to select Song Select display (Page 1) when you want to change the media/folder/song.

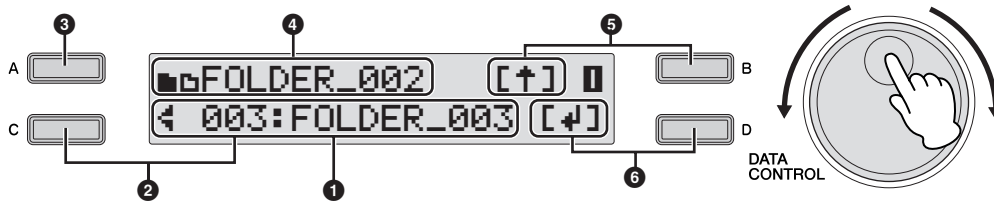

1 Current media/folder/song

Displays the currently selected media/folder/song. In this case, the folder named “FOLDER_003” is shown.

2 Changing the current media/folder/song

The current media/folder/song can be selected by turning the DATA CONTROL dial or by successively pressing the [C] button.

3 Display the entire song name

To show the entire name of the currently selected folder/song (up to 36 characters) in the display, hold down the [A] button.

4 Upper level folder or media

This shows the upper level folder/media which contains the currently selected folder/song. The media icon (■) and the folder icon (▣) shown at the top left of the display indicates the current location in the media. For example, “■▣FOLDER_002” indicates that the folder named “FOLDER_002” in the root directory of the media. For folders deeper in the hierarchy (lower than the third level), the folder icon “■. . . ▣” is shown.

5 Move to upper level

Select the upper level by pressing the [B] button.

If you are at a level lower than the second level, you can instantly jump back to the first level by holding down the [B] button (for more than two seconds).







6 Move to lower level

Select the lower level by pressing the [D] button.

If a song is selected, [▶] is not shown in the display.

Song Icons

These icons are shown when you select a media, folder, and song.

Icons	Description
	Indicates media such as a USB flash memory or a floppy disk.
	Indicates a folder.
	Indicates a Protected Song unavailable for editing. See page 139 for details.
	Indicates a Protected Song available for editing.
	Indicates a song that has been converted from a song in media for which write-protect or copy-protect is effective. For details, see “Converting EL format to ELB” on page 142.
	Indicates that the performance data is contained in the song.
<code>E001:SONG 1</code>	Indicates a song that has been created with an EL-series Electone, such as the EL-900 or EL-100.
<code>X001:XGSONG001</code>	Indicates an XG song.

Media Contents: Folders, Songs, and Files

Folders:

A folder is a storage location in the media, used to organize multiple songs in groups.

If you've saved hundreds of songs to a USB flash memory device, it may be difficult to find the desired song quickly. Organizing your songs in folders, with similar songs grouped together (for example, according to genre or tempo), makes it easier to find the songs you want.

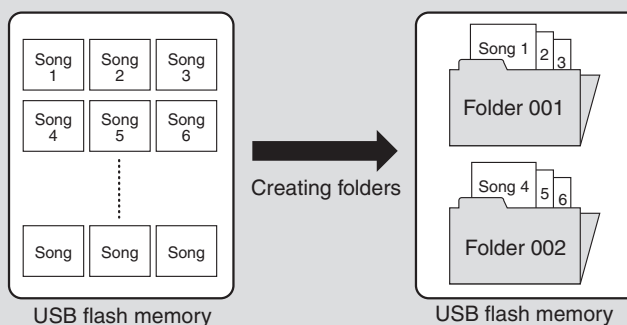

Songs:

A song is a “container” for storing the Electone data for a piece of music, recorded to external media. A single song can contain both the recorded performance and Registrations. A blank song containing no data is displayed as a “new song.”

When a song containing the performance data is selected, a note icon () appears in the display.

Files:

A file is an element of data in a song. For example, a single song consists of various files, such as Registration files and performance files. The file types listed below are created with the M.D.R. (The extension will not appear in the Electone display. They will, however, be displayed on a computer.)

Files in the song

File	Explanation	Extension
Performance data	This file contains performance data, played on the keyboards and pedals of the Electone.	.mid
Registration data	This file contains Registration settings, User Voices, User rhythms, and Rhythm Sequences.	.b00
XG-converted data	This file contains XG song data, for which Electone performance data is converted to XG-compatible format.	.mid

4 Recording

Recording

Before recording, set up the Electone just as you'll need it for the entire recording. Set the desired Registrations you'll use throughout the performance/recording in Registration Memory and make sure also to select the Registration that you will use at the beginning of the song

1 Insert the media into the **USB TO DEVICE** terminal.

2 Select the blank song (new song) for recording your performance.

For details on selecting a song, see steps 2 and 3 on page 112.



3 Press the **[RECORD]** button.

The lamp above the **[RECORD]** button lights, indicating that the Electone is ready to record.

You can cancel the operation at this point by pressing the **[STOP]** button.

4 Press the **[PLAY/PAUSE]** button.

The lamp above the **[PLAY/PAUSE]** button lights up and a small arrow indicator flashes across from left to right at the top right of the LCD display. This indicates that the M.D.R. is reading the registrations.

5 After "REC · ·" appears at the top right of the LCD display, begin playing.



NOTE

When you record the song using the Next Regist function, make sure to press the **[PLAY/PAUSE]** button before pressing the **[RECORD]** button. For details, see page 129.



CAUTION

Do not remove the media from the instrument during recording (while the message is shown).

6 When you finish playing, press the [STOP] button.

Recording stops and your performance is written to the song. The song to which your performance is recorded is automatically named “SONG xx” (xx indicates the number). You can change the song name as desired. (For details, see page 122.)

7 To hear your newly recorded performance, press the [PLAY/PAUSE] button.

Playback will begin after a couple of seconds, as the Electone reads the Registration. For more information on playback and other playback-related functions, see page 132.

Re-recording (Retry)

If you make a mistake during recording, you can re-record the song from the beginning.

1 Press the [PLAY/PAUSE] button while the song is still running.

This automatically stops recording and returns you to the starting point of the song. The lamp above the [PLAY/PAUSE] button starts flashing, indicating that you can re-record the song.

2 Press the [PLAY/PAUSE] button again.

Re-recording starts from the beginning of the song and replaces the previously recorded performance with the newly recorded performance.

Recording Each Part Separately

You can also record the parts of your performance independently. This function lets you record Keyboard Percussion and performance control data, such as Registration changes and expression pedal operation, separately from the other parts of the song. Even Keyboard Percussion and Lead Voice can be recorded separately. The following instruction is an example: First, record the chords and bass to the song using the Lower and Pedalboard, and then record the melody using the Upper Keyboard.

1 Follow steps 1 through 3 on page 117 to call up the Rec Standby display.

2 Select the parts for recording.

Each press of a part button switches the status: Play (green LED), Off (LED is off) and Rec (red LED). Press each part button to turn off the parts you don't want to record, and make sure the green LED is lit for the parts you want to play and the red lit for the part you want to record.

 **Play (green LED):**
Playback of parts that have been recorded.

 **Off (LED is off):**
Recording or playback is not active.

 **Record (red LED):**
Recording of the part.

To record the performances on the Lower Keyboard and Pedalboard, turn off the LED above the [UPPER] button, and make sure that the red LEDs above the [LOWER] button and the [PEDAL] button are lit, as shown in the lower illustration above.

3 Press the [PLAY/PAUSE] button. After “REC - -” appears at the top right of the LCD display, begin playing.

4 Press the [Stop] button when you are finished with your performance to stop recording.

Now you've recorded the first parts of your performance.

Setting up recording of the next part—Upper part in this case.

5 Press the [RECORD] button.

A message appears prompting confirmation of operation. To overwrite, press the [C] button corresponding to [OK] in the display.

6 Select the parts for recording.

Set the parts you want to record next (in this case, the Upper part) to “Rec” (red LED). Also set the part already recorded (in this case, the Lower and Pedal parts) to “Play” (green LED), so that you can hear the previously recorded parts as you record new ones.

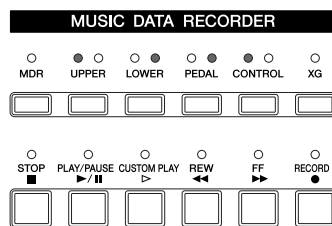

7 Press the [CUSTOM PLAY] button to start recording of the new part or parts.

Playback of the previously recorded parts starts immediately. The [CUSTOM PLAY] button is used here to record only the parts that have been selected for recording, and plays back only those parts that have been selected for playback. While you listen to the parts being played back, start playing the melody on the Upper Keyboard.

When the end of the recorded performance is reached, playback is automatically stopped. The length of a subsequently recorded part cannot exceed the length of the previously recorded parts.



NOTE

When you record the Keyboard Percussion, make sure that the KEYBOARD PERCUSSION [1] and/or [2] button is set to on.

Separately recording for Lead Voice and/or Keyboard Percussion parts:

The Lead voice and the Keyboard Percussion can be recorded/played back separately although there are no buttons for these parts. Set these in the display shown in step 2 on page 119.

Press the PAGE buttons to select Page 3.

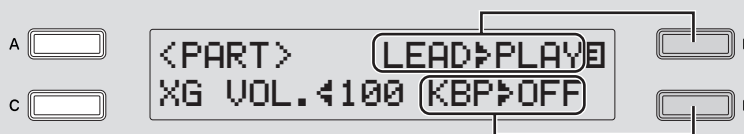

Press the [B] button to make the “▶” indicator flash, then use the DATA CONTROL dial to select the status for the Lead Voice.

Press the [D] button to make the “▶” indicator flash, then use the DATA CONTROL dial to select the status for Keyboard Percussion.

You cannot set both Upper and Lead to “Rec” at the same time; neither can the Lower and Keyboard Percussion parts be recorded at the same time.

Punch-in Recording

This lets you re-record over a specific phrase or section—either that of a specific part(s) or all parts.

- 1 Insert the media into the USB TO DEVICE terminal.**
- 2 Select the song which contains the phrase you want to change.**
For details on selecting a song, see steps 2 and 3 on page 112.
- 3 Press the [PLAY/PAUSE] button to start playback of the song.**
- 4 Press the [PLAY/PAUSE] button at the point you want to execute punch-in recording.**
The current song is stopped momentarily.
- 5 Press the [RECORD] button.**
The lamp above the [RECORD] button lights, indicating that the M.D.R. is ready to record.
- 6 Set the parts which you want to change to “Rec” status and other parts to “Play.”**
- 7 Press the [PLAY/PAUSE] button to start punch-in recording. Play the new phrase, as you want it to be changed.**
- 8 Press the [STOP] button to quit the punch-in recording as soon as you reach the end of the phrase.**



NOTE

This function is best used when the phrase to be re-recorded has definite beginning and end points, with slight pauses before and after.

5 Changing the Song/Folder Name

Even though the Electone automatically assigns a generic name to each recorded song, it's best to give each song a "meaningful" name, such as an original title or even a date indicating when it was recorded.

1 Insert the media into the USB TO DEVICE terminal.

2 Select the song/folder whose name you want to change.
For details on selecting a song or a folder, see steps 2 and 3 on page 112.

3 Use the PAGE buttons to select the Rename display (Page 4).
The Rename display appears.



NOTE

A blank song cannot be named. Once a song contains data, it can be named.

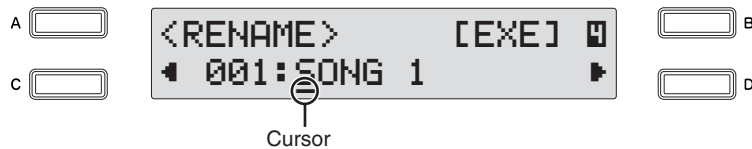

4 Move the cursor to the desired point by using the [C] [D] buttons.
Pressing the [D] button moves the cursor one step to the right, while pressing the [C] button moves it to the left

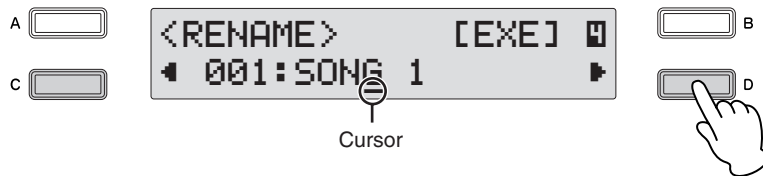

5 Change the character at the cursor position.
Replace the current character at the cursor by using the DATA CONTROL dial. Turn it clockwise to select the characters in order, and counter-clockwise for reverse order.



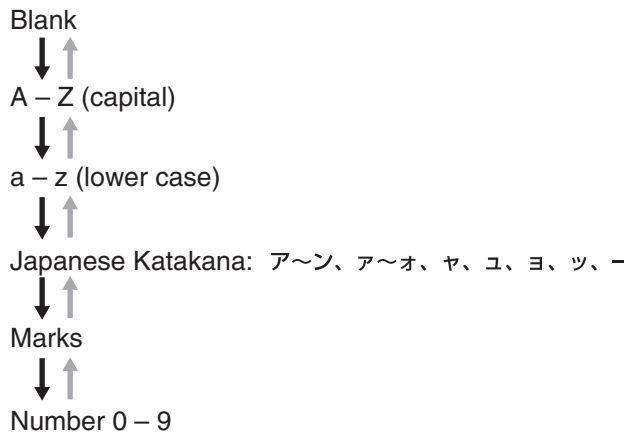
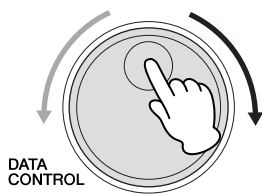

NOTE

If “English” is selected as the Language in the Utility display (page 19), Japanese katakana characters are unavailable.

To delete a character:

Move the cursor to the character you want to delete, and press the [C] button while holding down the [A] button.

When the character is deleted, all other numbers to the right of the cursor are moved one step to the left.

To insert a space:

Move the cursor to the position at which you want to enter the space, and press the [D] button while holding down the [A] button.

6 Repeat steps 4 through step 5 above to finish entering the song name.

Up to 36 characters can be entered.

7 After finishing, press the [B] button corresponding to [EXE] (Execute) in the display.

A message appears prompting confirmation of operation. You can cancel the operation at this point by pressing the [D] button.

8 To actually enter the change, press the [C] button corresponding to [Rename] in the display.

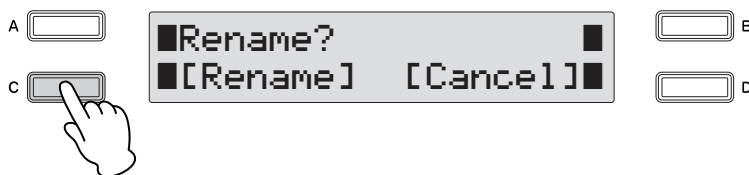

The renamed song/folder is displayed.

An error message (“This name is not available”) may appear when pressing the [C] button to finish entering the name. If this message appears, the name is invalid and you’ll need to enter a different name. The following names cannot be used. (The letters “xx” indicate numbers.)

MDR_xx.EVT	ELS_SONG.NAM	MDR_xxx.TMP	TMP
MDR_xx.MID	MDR_xxx.MID	REG_xxx.TMP	TMPE02
MDR_xx.Bxx	REG_xxx.B00	ELS_SONG.TMP	
MDR_xx.Vxx	SONG_xxx.C02		
SONG.NAM			

6 Saving Registrations as Registration Data (File)



Reference Page

Functions and settings that cannot be memorized (page 98)

You can also record Registrations by themselves to a song, without having to record them along with a performance. All Registrations 1 – 16 stored to the Registration Memory buttons as well as the Registration Shift settings and so on can be saved to the song. Even if you’ve only created a couple of Registrations yourself, 16 separate Registration Memory settings are always stored when saving to a song—the factory preset Registrations being stored if no new settings have been made to the numbers.

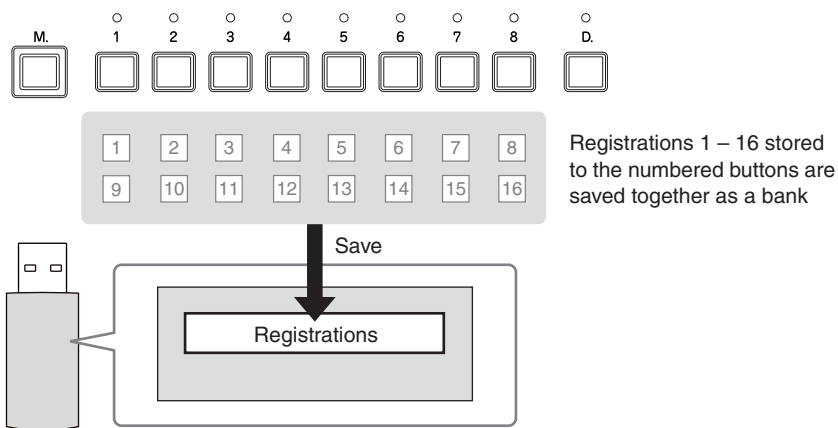

There are two ways to save the Registrations.

Method 1

- 1 Insert the media into the USB TO DEVICE terminal.
- 2 First make all the desired Electone settings to create your original Registration.

- 3 Press the [MDR] button, and select the destination (blank song).**
 Select the blank song. For details on selecting a song, see steps 2 and 3 on page 112.

- 4 Use the PAGE buttons to select Page 9.**



- 5 Press the [B] button corresponding to [EXE] (Execute) in the display.**

A message appears, indicating that the Registration data is currently being saved. After the message disappears, the song to which the Registration is recorded is automatically named “SONG xx” (“xx” indicates the number).



Reference Page

Changing the Song/Folder Name (page 122)

Method 2

- 1 First make all the desired settings you want to save, then select the destination (blank song) as you did in steps 1 and 3 above.**
- 2 Press the [RECORD] button to enable recording on the M.D.R.**

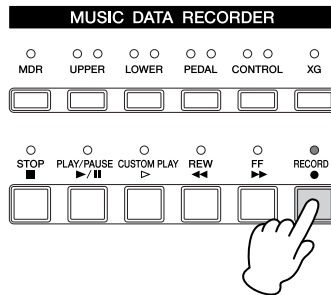

- 3 Press the [PLAY/PAUSE] button to record the Registrations, then press the [STOP] button before the “REC· ·” indication is shown at the top right of the display.**

This is the same procedure as the one shown when you start recording. The “REC· ·” at the top right of the display indicates that the M.D.R. is recording the Registrations and being set up for normal recording; pressing the [STOP] button interrupts this process.

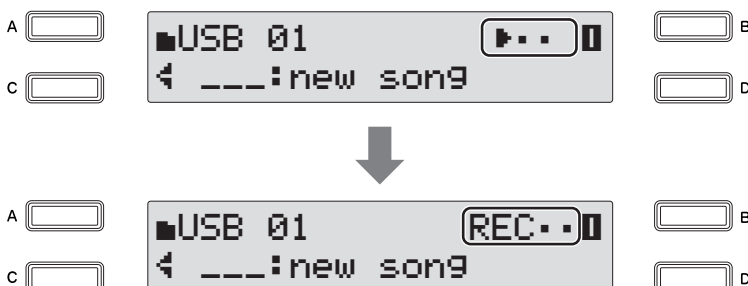

Saving Two or More Registration Banks to One Song

When you save the Registrations, Registrations 1 – 16 will be saved as a Registration bank. When you want to use more than 16 Registration numbers in a song, you can save additional Registration banks—up to a maximum of 50 in a single song—with the following procedure.

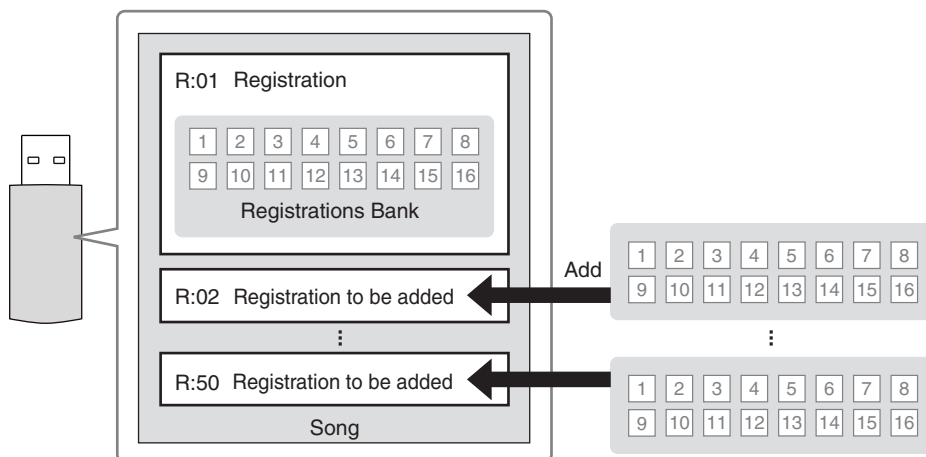

- 1 First make all the desired settings you want to save.
- 2 Insert the media into the **USB TO DEVICE** terminal.
- 3 Press the **[MDR]** button, and select the destination song (the one that already contains the previous Registrations).
For details on selecting a song, see steps 2 and 3 on page 112.
- 4 Use the **PAGE** buttons to select Page 9.



Any Registration banks previously been saved to the song are indicated in the display (as “01” or similar).

- 5 Select the blank Registration bank “01” to which you want to save the additional Registration bank, by using the **DATA CONTROL** dial.

You can also select the blank bank by successively pressing the **[D]** button.

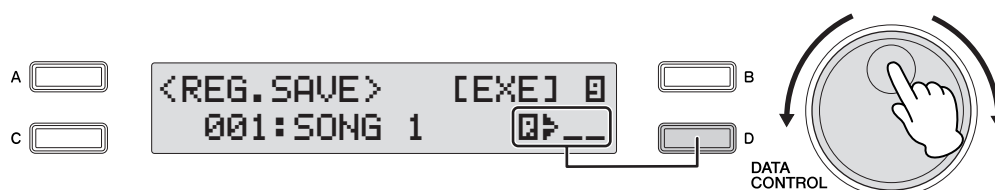

If you select a numbered bank, such as “01” instead of “_ _”, this procedure will overwrite the numbered bank. For details, see step 6 of “Replacing Registrations” on page 128.



Reference Page

Files (page 116)

6 Press the [B] button corresponding to [EXE] (Execute) in the display.

The Registration bank will be added and follows previously contained banks. When you play back this song, the top Registration in this display will be loaded to the Electone.

Replacing Registrations

The M.D.R. also lets you change the Registrations of an existing song without changing the performance data.

1 First make all the desired settings you want to save to the new Registration.

2 Insert the media into the USB TO DEVICE terminal.

3 Press the [MDR] button, and then select the desired song containing the Registration you wish to replace.

For details on selecting a song, see steps 2 and 3 on page 112.



Reference Page

Song Icons (page 116)

4 Use the PAGE buttons to select Page 9.

The Registration bank number will be shown at the bottom right of the display.

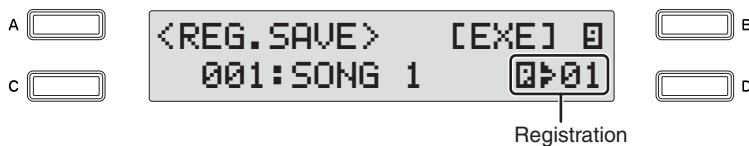

5 Select the Registration bank number you wish to overwrite by using the DATA CONTROL dial.

- 6** Press the [B] button corresponding to [EXE] (Execute) in the display.



A message appears prompting confirmation of operation.
You can cancel the operation at this point by pressing the [D] button.

- 7** Press the [C] button corresponding to [OK] in the display to overwrite (replace).

Deleting Registrations

This function lets you delete the Registration banks saved to a song.

- 1** Insert the media into the USB TO DEVICE terminal.
- 2** Press the [MDR] button, and then select the song containing the Registrations you wish to delete.
For details on selecting a song, see steps 2 and 3 on page 112.
- 3** Use the PAGE buttons to select the Registration Delete display (Page 10).

The Registration Delete display appears.

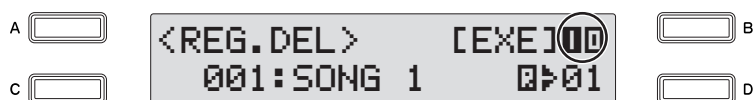

- 4** Select the Registration bank number you want to delete by using the DATA CONTROL dial.

You can also select the Registration bank number by successively pressing the [D] button.

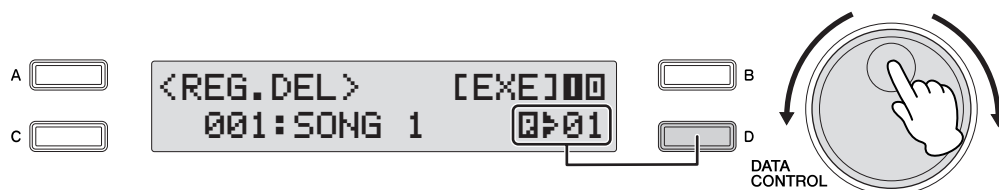

5 Press the [B] button corresponding to [EXE] (Execute) in the display.

A message appears prompting confirmation of operation.

You can cancel the operation at this point by pressing the [D] button.

6 Press the [C] button corresponding to [Delete] in the display to delete the Registration.

When several Registrations are stored to a song, the Registrations following the deleted one are moved back to replace it in the order

Next Regist Settings (Using more than 16 Registrations in one song)

You've learned in an earlier section that by using a bank of 16 Registrations, you can program a maximum of 80 settings to be recalled in a specified order, with the Regist Shift function described on page 106.

When playing back a song which uses more than 16 Registration numbers, you can have two or more Registration banks saved to a single song and recall them one by one as you play the song. This function that makes this possible is called Next Regist.

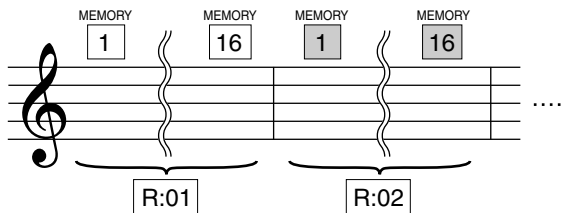

1 Insert the media into the USB TO DEVICE terminal.

2 Set the Registration Shift mode to User, and select Next as the Shift End in Page 1 of the Registration Shift display. In Page 2, set the Use Registration order.

For details, see "Registration Shift" on page 103.

3 Press the [MDR] button, and select the destination song.

For details on selecting a song, see steps 2 and 3 on page 112.

4 Save the Registrations.

Press the PAGE buttons to select Page 9.



Press the [B] button corresponding to [EXE] (Execute) in the display.

A message appears, indicating that the Registration data is currently being saved.

After the message disappears, the song to which the Registration is recorded is automatically named "SONG xx" ("xx" indicates the number).

5 Repeat steps 2 through 4 above to save the Registration banks in the order you want to recall them in the same song. When making new Registration Shift setting, delete the previous settings, then continue.

For details, see “Saving Two or More Registration Banks to One Song” on page 126.

Once the Next Regist function has been turned on and set, you can use the function, following the steps below.

6 Press the [MDR] button, and select the song for which the Next Regist function has been set.

See steps 2 and 3 on page 112 for instructions on selecting Songs.

7 Press the [PLAY/PAUSE] button.

If the song contains more than two Registration banks, the first one (R:01) will be loaded. You can check the Registration order in Page 2 of the Registration Shift display.

8 As you play the Electone, press the Right Footswitch.

Each press of the Right Footswitch selects Registrations according to the order you've specified.

After finishing the play back of the “R:01,” the next Registration bank “R:02” begins loading automatically, and can be selected by pressing the Right Footswitch.



NOTE

While a rhythm is playing, sequence data and User rhythm in the Registration data created on the Electone such as ELS-01/01C/01X cannot be loaded.

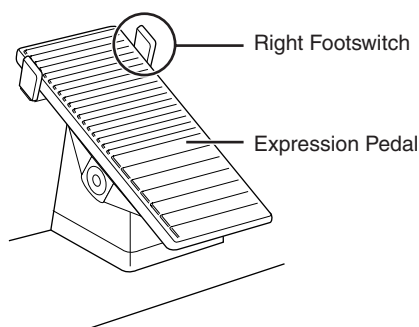

When you record or play the song using the Next Regist function, make sure to load the top Registration bank (R:01) to the Electone by pressing the [PLAY/PAUSE] button after selecting the desired song. If you begin the recording procedure instead by pressing the [RECORD] button, even as another bank (R:02, etc.) is loading, R:01 is overwritten by the current panel settings and will be lost.

7 Recalling Recorded Registrations

Registrations (and bulk data) recorded to song numbers can be easily loaded back to the Electone. Use this function if you want to recall a specific Registration bank (R:02-) from a song which contains more than two Registration banks

Loading Registrations

- 1 Insert the media into the **USB TO DEVICE** terminal.
- 2 Press the **[MDR]** button and select the song containing the Registrations you want to load back to the Electone.
For details on selecting a song, see steps 2 and 3 on page 112.
- 3 Use the **PAGE** buttons to select the Registration Load display (Page 8).



- 4 Select the Registration bank you want to load to the Electone.
Select the desired Registration bank number by turning the **DATA CONTROL** dial.



- 5 Press the **[B]** button corresponding to **[EXE]** (Execute) in the display.

A message appears, indicating the Registration data is currently being loaded. After the Registration data is loaded, the LCD returns to the Registration Load display.



NOTE

If you load a Registration while a rhythm is playing, User rhythms in the Registration data cannot be loaded.

8 Playing Back a Song

This operation lets you automatically load the Registration data saved to a song when playing back your recorded performances.

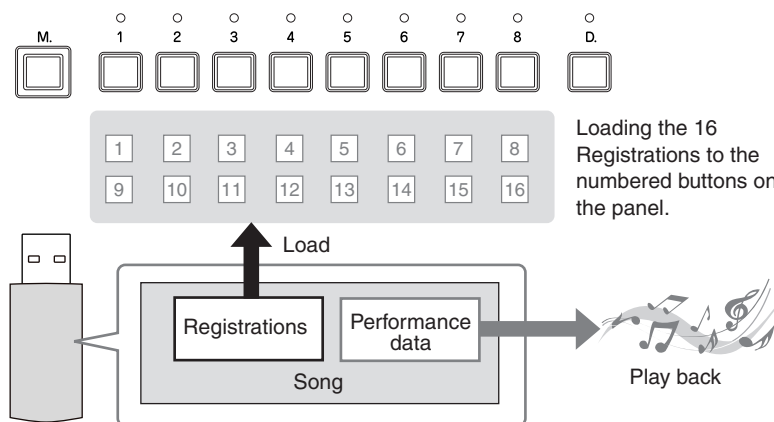

1 Insert the media into the **USB TO DEVICE** terminal.

2 Press the **[MDR]** button, then select the desired song for playback.

For details on selecting a song, see steps 2 and 3 on page 112.

3 Press the **[PLAY/PAUSE]** button to load the Registration data. “■■■” appears at the top right of the display, indicating the Registration data is currently being loaded.

If the song contains more than two Registration banks, the first one will be loaded.

4 Playback starts automatically after reading the Registration data.

The elapsed time will be showed on the display, and song playback starts (if the song contains performance data). In general, all parts recorded to the song are played back; however, you can mute specific parts and playback only selected parts (page 133). When the end of the recorded performance is reached, playback automatically stops. You can, however, stop playback in the middle of the song by pressing the **[STOP]** button. If the song contains no performance data, after loading the Registration data, the LCD returns to the Song Select display.



Reference Page

Saving Two or More Registration Banks to One Song (page 126)

Custom Play

If you want to play back the song without resetting the Registrations, press the [CUSTOM PLAY] button instead of the [PLAY/PAUSE] button. This displays the song time and starts playback immediately.

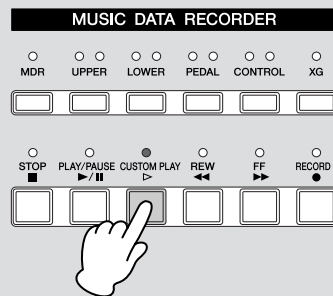

When you play the song using the Next Regist function, make sure to press the [PLAY/PAUSE] button to start the song, not the [CUSTOM PLAY] button.

Playing Back the Selected Part(s)

You can also play back selected parts of your recorded performance, while other parts are temporarily turned off. This function is especially useful for playing a single part, such as the melody, over previously recorded accompaniment parts.

To play back the selected part(s):

Before or during playback, press each part button to turn the part you want to playback to “Play” and the part you want to mute to “Off.”

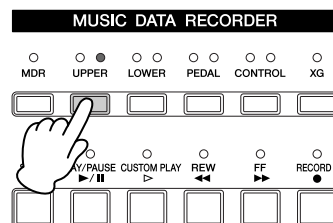

Reference Page

Recording Each Part Separately (page 118)

Fast Forward, Rewind and Pause

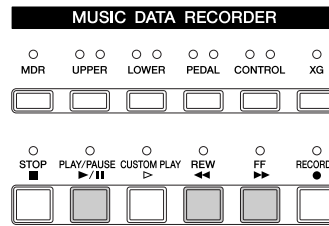

Fast Forward and Rewind:

During playback, press the [FF] (Fast forward) button or [REW] (Rewind) button and hold it down until the time reaches the desired position. When the button is released, playback is paused at the desired position. To resume playback from the point you've advanced or reversed to, press the [PLAY/PAUSE] button or [CUSTOM PLAY] button.

Pause:

If you want to temporarily stop playback of the song or songs, press the [PLAY/PAUSE] button. To resume playback from the point at which the song was paused, press the [PLAY/PAUSE] button again or press the [CUSTOM PLAY] button.

Changing the Tempo

You can change the tempo of the song as the song is playing in the M.D.R. display, either while the song is stopped or while it is playing. The TEMPO buttons on the panel cannot be used to change the tempo for the Music Data Recorder.)

To Change the Tempo:

- 1 **Press the [MDR] button.**
The Song Select display appears.
- 2 **Select the song to be played back.**
See steps 2 and 3 on page 112 for instructions on selecting songs.
- 3 **Use the PAGE buttons to select the Playback Setting display (Page 2).**

The tempo value is shown at the bottom left of the display



4 Changing the Tempo.

Press the [C] button to make the “◀” indicator flash, then use the DATA CONTROL dial to change the setting. The range is 50 – 200%. The original recorded tempo is 100%; values less than 100% result in a slower tempo, while values greater than 100% result in a faster tempo.

Repeat Playback

This feature allows you to repeatedly play back either all songs on a folder or only one specific song.

1 Select the song you wish to repeatedly play back.

If you wish to play back all songs on a folder, select the first song that will be played back. See steps 2 and 3 on page 112 for instructions on selecting songs.

2 Use the PAGE buttons to select the Playback Setting display (Page 2).

The Repeat mode is shown at the bottom right of the display.

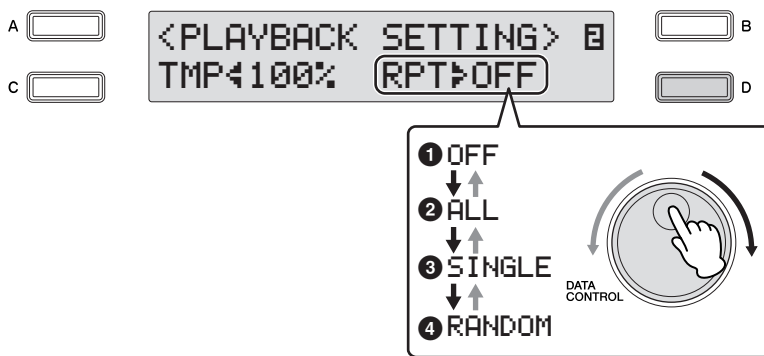

Select the repeat mode.

Press the [D] button to make the “▶” indicator flash, then use the DATA CONTROL dial to select the setting.

1 Off

Cancels repeat playback.

2 All

Repeats all songs in the currently selected folder in order.

3 Single

Repeats the currently selected song indefinitely.

4 Random

Repeats all songs in the currently selected folder randomly.

3 Press the [PLAY/PAUSE] button to begin playback.

When you stop playback, the repeat setting is automatically cancelled.

Playing Back XG Songs



Reference Page

Converting to XG format
(page 144)

The Electone allows you to playback XG song data, created on the computer or converted from Electone song format to XG format. Naturally, you can use the fast forward, rewind and pause controls, just as with songs (performances) recorded on the Electone.

- 1 **Insert the media containing the XG song data, then press the [MDR] button.**
- 2 **Select the media that contains the desired XG song in the Song Select display, and then select the desired song for playback.**
See steps 2 and 3 on page 112 for instructions on selecting songs.
- 3 **Use the PAGE buttons to select Page 3.**
You can set the volume or mute settings for each part.

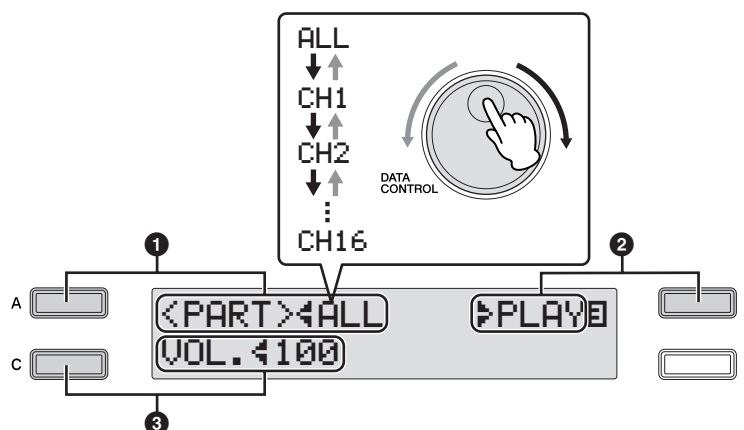

1 Part

Select the desired channel “CH1” through “CH16” or “ALL” to specify the part to mute/play or to change the volume.

Press the [A] button to make the “4” indicator flash, then use the DATA CONTROL dial to select the setting.

2 Playback/Off

Sets the selected part for playback or mute (off). Select “Play” for the part you want to play back and select “Off” for the part you want to mute. Press the [B] button to make the “▶” indicator flash, then use the DATA CONTROL dial to select the setting.

3 Volume

You can adjust the volume for the selected part within a range of 0 – 100. Press the [C] button to make the “4” indicator flash, then use the DATA CONTROL dial to select the setting.

The item “Volume” will be changed to “XG Volume” when the selected song contains an XG part, even when the song has been created on the ELB-01 or EL-900. You can adjust the XG part volume from Page 3, in the same way as you did with the XG songs.

9

Song Copy/Delete/Convert, Folder Create/Delete

These operations let you copy, delete or convert song data, as well as create or delete folders.

Song Copy

This function lets you copy recorded data from one song to another song. Songs created with the ELS-01/01C/01X or XG songs can be copied. (Only songs created with the EL-series, such as the EL-900, cannot be copied.) This function also lets you copy and exchange data between two different media.

Make sure to check the remaining memory of the destination media in advance. If memory space is insufficient, or if the folder already contains 100 songs, Song Copy is not available.

1

Insert the media into the USB TO DEVICE terminal.

If you want to copy the song between two different media, you will need to insert the appropriate destination media.

2

Press the [MDR] button, then select the song to be copied.

See steps 2 and 3 on page 112 for instructions on selecting songs.

3

Use the PAGE buttons to select the Copy display (Page 5).

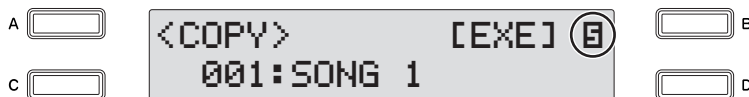

4

Press the [B] button corresponding to [EXE] (Execute) in the display.



The Copy Destination display appears.

6

5 Select the destination song.

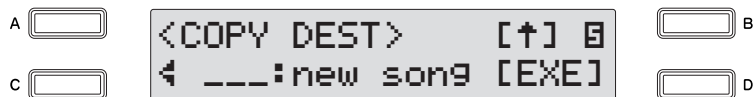

The new song or the folder that contains the source song will be automatically displayed at the bottom of the display as the destination. If the folder is displayed, select the new song. See steps 2 and 3 on page 112 for instructions on selecting songs.

If you want to copy an XG song, you'll need to select another folder as the destination, since the same folder containing the source XG song cannot be selected as the destination. If the remaining memory of the destination media is insufficient, XG Song Copy cannot be executed. (An error message will appear and the operation is cancelled.) Up to 120 XG songs can be saved in one folder



Reference Page

About Protected Songs
(page 139)

About Copying Protected Songs

Protected Original songs or Protected Edit songs can be copied as long as you select the same folder that contains the source Protected Song as the destination. If you select another folder/media, the message "Move?" will be displayed. If you select [OK] by pressing the [C] button, the currently selected Protected Original song and Protected Edit song created from a Protected Original song are all moved to another folder/media you have specified. In this case, the data is not copied, but moved.

6 Press the [D] button to execute Song Copy.

When the operation is completed, the LCD returns to the Copy display. The name of the destination song is the same as the one of the source song, except that "*" is attached at the beginning (not including XG songs). For instructions on changing the song name, see page 122.

About Protected Songs

If you buy or download song data, it may be protected from being deleted (to prevent accidental erasure) or from being copied (to protect copyright ownership). These are called “Protected songs.” A Protected song can be played back in the same way as songs you’ve created, but it cannot be converted to XG format or EL format. Registration data in the Protected song cannot be edited, nor can the performance data be overwritten. If you want to edit a Protected song, first copy it within one media/folder, then edit the copy. (You cannot copy to another media/folder.) The copied song (called “Protected Edit song”) is available only when the original song (called “Protected Original song”) exists in the same folder. Be careful not to delete the Protected Original song.

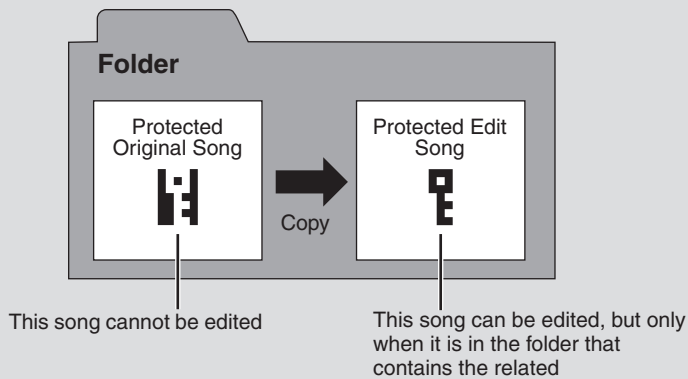

If you move or copy the protected song data on the computer without the Musicsoft Downloader application, the song cannot be played back. Always use the Musicsoft Downloader when moving or copying protected songs on the computer.

Musicsoft Downloader can be obtained at the following Internet address:
<http://music.yamaha.com/download/>



CAUTION

When you want to edit a protected song, turn the power to the instrument off and back on again, then select the song to be edited. (The Registration data of the previous protected song will be initialized.) Otherwise the edited protected song may not be saved.

Song Delete/Folder Delete

These operations let you delete songs and folders.
 (Only songs created with the EL-series, such as the EL-900, cannot be deleted.)

- 1 Insert the media, then press the [MDR] button.
- 2 Select the song/folder you want to delete.
 See steps 2 and 3 on page 112 for instructions on selecting songs/folders.
- 3 Use the PAGE buttons to select the Delete display (Page 6).
 Confirm that the desired song/folder to be deleted is shown at the bottom of the display.
 If you want to change the song, return to Page 1 by pressing both PAGE buttons simultaneously, and then select the desired song.

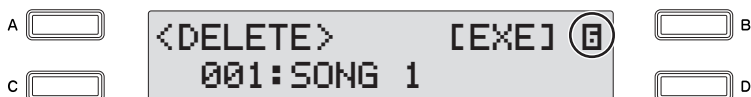

4 Press the [B] button corresponding to [EXE] (Execute) in the display.

A message appears prompting confirmation of operation.
You can cancel the operation at this point by pressing the [D] button.

5 Press the [C] button to execute the operation.

When the operation is completed, the LCD returns to the Delete display.

To prevent inadvertent erasure of important data, make sure to return to the Page 1 by pressing both PAGE buttons simultaneously.

Creating folders

1 Insert the media, then press the [MDR] button.

2 Select the media/folder in which you want to create the folder, then press the [D] button.

3 Use the PAGE buttons to select the Create Folder display (Page 11).

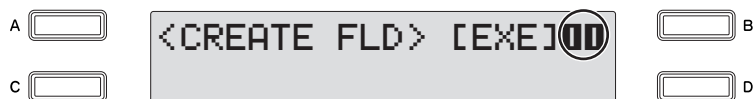

4 Press the [B] button corresponding to [EXE] (Execute) in the display.

To see the newly created folder, first return to Page 1 by pressing both PAGE buttons simultaneously, then select the newly created folder.

The newly created folder is automatically named "FOLDER_xxx" (xxx indicates the number). For instructions on changing the folder name, see page 122.

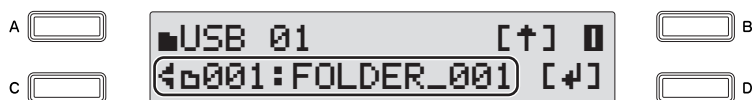

Converting ELB format songs to EL

You can convert songs created on the ELB-01 to the EL-series format, and save them to a floppy disk. The converted data can be used with EL-series Electones, such as the EL-900. This function is not available for Protected songs. To use floppy disks with the Electone, install the optional UD-FD01 floppy disk drive. Make sure to check the remaining memory of the destination media in advance. If memory space is insufficient, the Convert operation is not available.



Reference Page

About Protected Songs (page 139)
Installing the Floppy Disk Drive (page 167)

1 Insert the media containing the song created with the Electone, and the floppy disk as the destination.

2 Press the [MDR] button, then select the song to be converted to the EL-series format.

See steps 2 and 3 on page 112 for instructions on selecting songs.

3 Use the PAGE buttons to select the Convert display (Page 7).

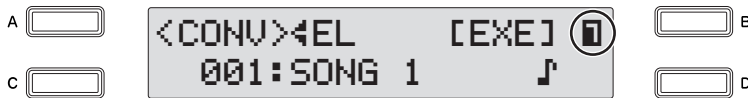

4 Select the conversion format.

Select “EL” by using the DATA CONTROL dial or by successively pressing the [A] button.

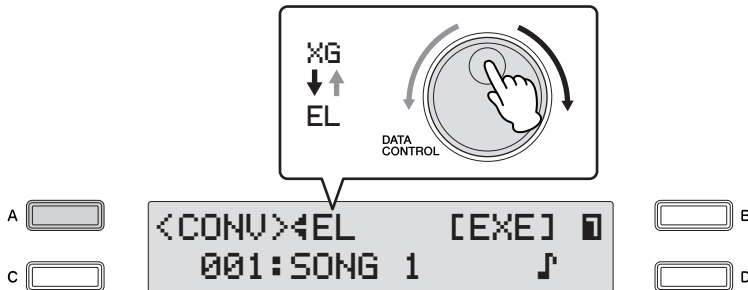

NOTE

ELB songs can be used on Electone models such as the ELS-01/01C/01X with no need for conversion.

5 Press the [B] button corresponding to [EXE] (Execute) in the display.



The new song is displayed as the destination in the floppy disk. When a new song is not displayed, select a new song by turning the DATA CONTROL dial or successively pressing the [C] button.

6 Press the [D] button corresponding to [EXE] (Execute) in the display.

A message appears prompting confirmation of operation. You can cancel the operation at this point by pressing the [D] button.

7 Press the [C] button corresponding to [Convert] in the display to start conversion.

After conversion is finished, the LCD returns to the Convert display. The song converted to EL format is automatically named “EXXX: SONG x” (x indicates the number).

Converting EL format songs to ELB

You can convert the songs in a floppy disk created with an EL-series Electone, such as the EL-900, to the ELB-01 format, and save it to a USB flash memory device. The songs in write-protected or copy-protected media for the EL series can be converted only one time. To use a floppy disk, you'll need to install the optional UD-FD01 floppy disk drive. Depending on the original song data, the sound or tempo of the converted song may differ from the original, and/or the Next Song function of the original song may not be effective.

Make sure to check the remaining memory of the destination media in advance. If memory space is insufficient, the Convert operation is not available.



Reference Page

Installing the Floppy Disk Drive (page 167)



NOTE

When converting protected EL data to the ELB format, make sure to set the write-protect tab of the EL disk to the “overwrite” position (tab closed).

- 1 Insert the floppy disk that containing the song you want to convert to the ELB format, and insert the USB flash memory device for use as the destination.
- 2 Press the [MDR] button, then select the song you want to convert to ELB format.
See steps 2 and 3 on page 112 for instructions on selecting songs.
- 3 Use the PAGE buttons to select the Convert display (Page 7).

- 4 Press the [B] button corresponding to [EXE] (Execute) in the display.



The Convert Destination display appears.

- 5 Select the blank song as the destination in the USB flash memory device.
- 6 Press the [D] button corresponding to [EXE] (Execute) in the display.
A message appears prompting confirmation of operation. You can cancel the operation at this point by pressing the [D] button.
- 7 Press the [C] button corresponding to [Convert] in the display to start conversion.

After conversion is finished, the LCD returns to the Convert display.

Converting to XG format

This function allows you to convert ELB-01 song data to XG format data. You can play back the data using XG devices. The converted XG song data may not sound the same as the original data.

Make sure to check the remaining memory of the destination media in advance. If memory space is insufficient, the Convert operation is not available. Protected songs cannot be converted to XG format.

1 Select the song to be converted to the XG format.

See steps 2 and 3 on page 112 for instructions on selecting songs.

2 Use the PAGE buttons to select the Convert display (Page 7).

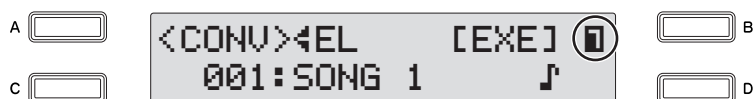

3 Select the conversion format.

Select "XG" by using the DATA CONTROL dial or successively pressing the [A] button.

4 Press the [B] button corresponding to [EXE] (Execute) in the display.

The Convert Destination display appears.

5 Select the blank song as destination.

6 Press the [D] button corresponding to [EXE] (Execute) in the display.

7 A message will appear, prompting confirmation of the converted data. Press the [C] button to play back the data.

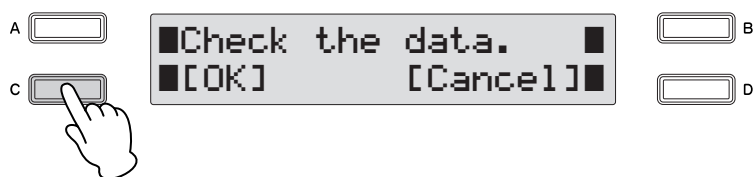

After playback is finished, the LCD return to the Convert display. The song converted to XG format is automatically named "XGSONGxxx" (xxx indicates the number). For instructions on changing the song name, see page 122.

Checking the Remaining Memory

You can check the remaining memory in the media.

- 1 Insert the media, and press the [MDR] button.
- 2 Select the desired media by using the DATA CONTROL dial or by successively pressing the [C] button.
- 3 Use the PAGE buttons to select Page 13.
The remaining memory is displayed.



These leg- and foot-operated controls allow you to execute various performance functions and switch the effects on/off, without taking your hands from the keyboard.

Left Footswitch

The Electone has two Footswitches on the expression pedal. The Right Footswitch is used for the Registration Shift function, while the Left Footswitch can be set to control one of three functions: Rhythm, Glide, or Rotary Speaker. Instructions for setting the Left Footswitch (in the Footswitch Page) are given here. For details on the Registration Shift function and Right Footswitch, see “Registration Shift” on page 102.

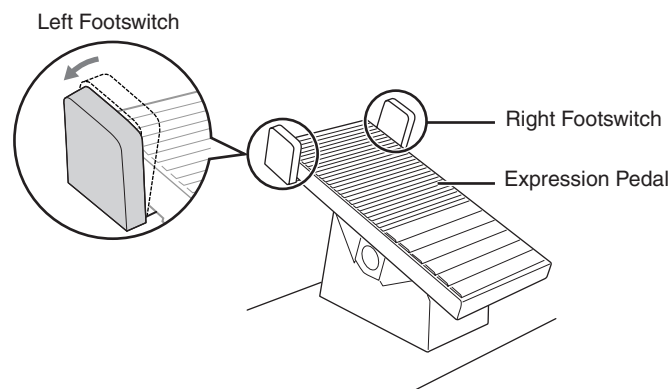

1 Press the [FOOTSWITCH] button.



NOTE

Pressing the [FOOTSWITCH] button calls up one of two different display pages: the Footswitch Page or the Regist Shift Page. Press the [A] button to alternate between the two pages.

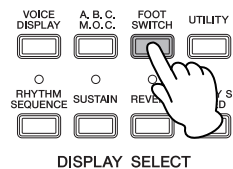

◻<REG. SHIFT>
MODE◀OFF

2 Calls up the Footswitch display.

Pressing the [A] button alternates between the Footswitch Page and Regist Shift Page.

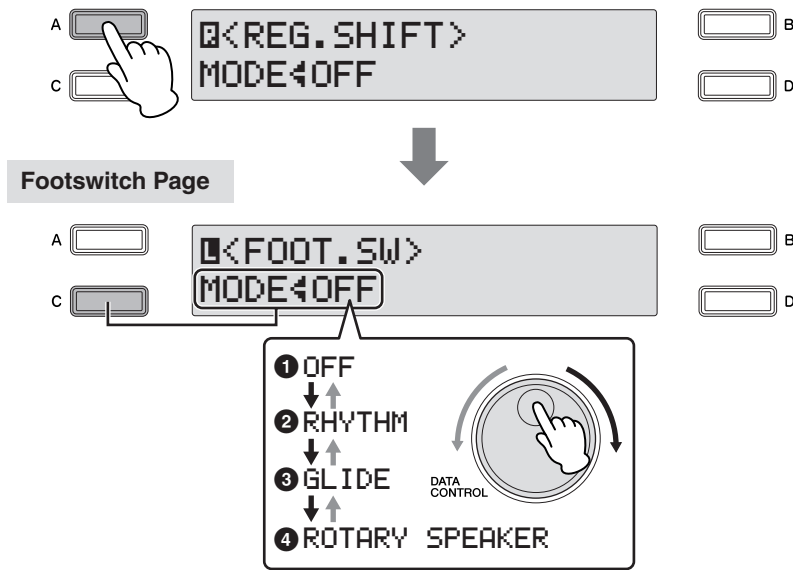

In this page, you can assign which function the Left Footswitch will control: Rhythm, Glide, or Rotary speaker. Turning the DATA CONTROL Dial to the right selects the functions in sequence: Off → Rhythm → Glide → Rotary speaker. Turning the DATA CONTROL Dial to the left selects in the reverse order. When Off is selected here, the Left Footswitch is inactive.

1 Off

The Left Footswitch will not control any function.

2 Rhythm

When this is selected, one of the control settings appears at the right bottom of the display. Press the [D] button to make the “▶” indicator flash, then use the DATA CONTROL Dial to select the desired control setting.



Reference page

Rhythm Structure (page 58)

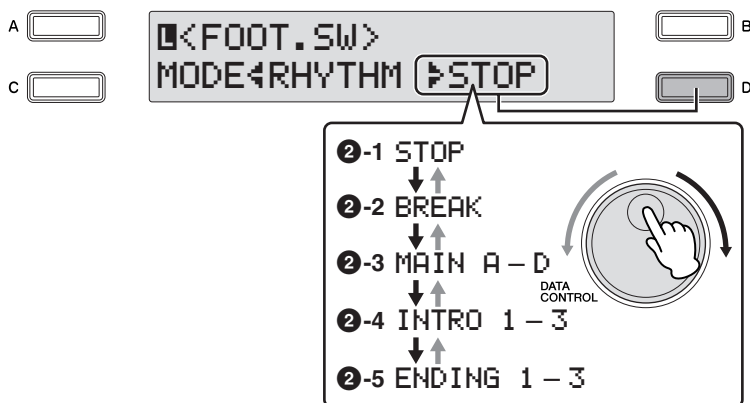

2-1 Stop

Switches the rhythm on/off whenever you press the Left Footswitch.

2-2 Break

This function corresponds to the [BREAK] button on the panel. When you press the Left Footswitch, the Break section turns on.

2-3 Main A – Main D

These functions correspond to the MAIN/FILL IN [A] – [D] buttons on the panel. For example, when “MAIN A” is selected in this display and you press the Left Footswitch, the rhythm section is switched to Main A or Fill In A.

2-4 Intro 1 – Intro 3

These functions correspond to the INTRO [1] – [3] buttons on the panel. For example, when “INTRO1” is selected in this display and you press the Left Footswitch, the rhythm section is switched to Intro 1.

2-5 Ending 1 – Ending 3

These functions correspond to the ENDING [1] – [3] buttons on the panel. For example, when “ENDING1” is selected in this display and you press the Left Footswitch, the rhythm section is switched to Ending 1. After the ending pattern is played, the rhythm stops.

3 Glide

This lets you control the Glide effect by using the Left Footswitch. Pressing the Left Footswitch immediately lowers the pitch of the selected Voice or Voices by a half-step and releasing it slowly returns the pitch to the original.

When the Glide setting is chosen, three separate Glide pages are available, with the current page number shown at the top right side of the display.

You can select the pages by using the PAGE buttons.

Footswitch – Glide Page 1

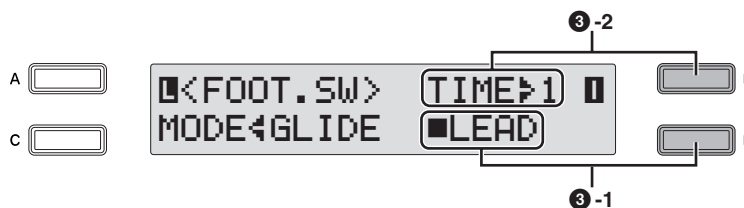

Footswitch – Glide Page 2



Footswitch – Glide Page 3

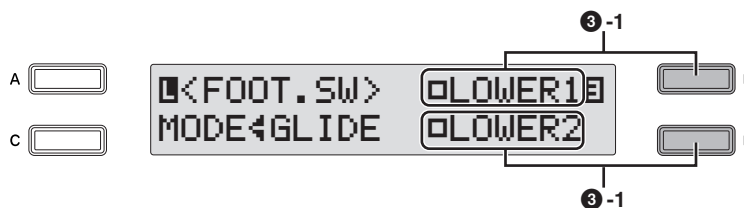

3-1 Upper 1, 2, Lower 1, 2, Lead

Select the desired Voice section(s) for which the Glide function is to be applied by pressing the corresponding [A] – [D] buttons.

3-2 Time

Determines the speed of the Glide function, or how gradually the pitch returns when the Left Footswitch is released. Higher settings produce slower pitch changes. Press the [B] button to make the “” indicator flash, then use the DATA CONTROL dial to change the setting.

Range: 1-5

4 Rotary Speaker

You can control the Rotary Speaker effect (on/off) by using the Left Footswitch. When the “ROTARY SPEAKER” is selected in this display and you press the Footswitch, the Rotary Speaker effect is switched on or off. This function corresponds to the [ROTARY SP SPEED] button on the panel. To use this function, you’ll need to make the appropriate Rotary Speaker settings for each Voice section. For details, see page 50.

```
◀FOOT.SW>  
MODE◀ROTARY SPEAKER
```



Reference page

Rotary Speaker (page 50)

Transpose and Pitch Controls

There are two pitch-related controls on the Electone: Transpose and Pitch.

Transpose allows you to change the key of the instrument and Pitch lets you finely adjust the tuning. Transpose and Pitch can be adjusted in the Utility display.

1 Press the [UTILITY] button.

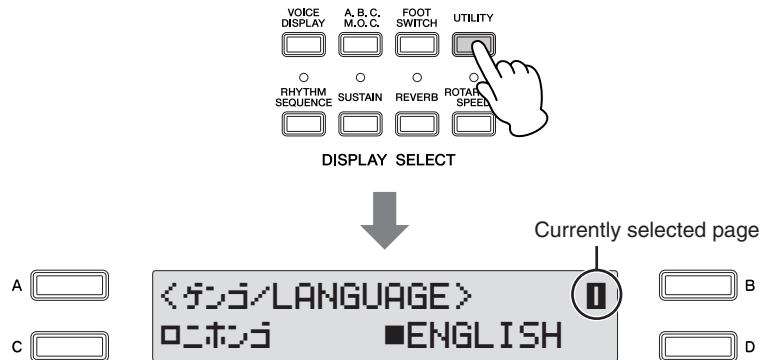

The Utility display appears.

2 Select Page 2 of the Utility display by pressing the PAGE buttons.

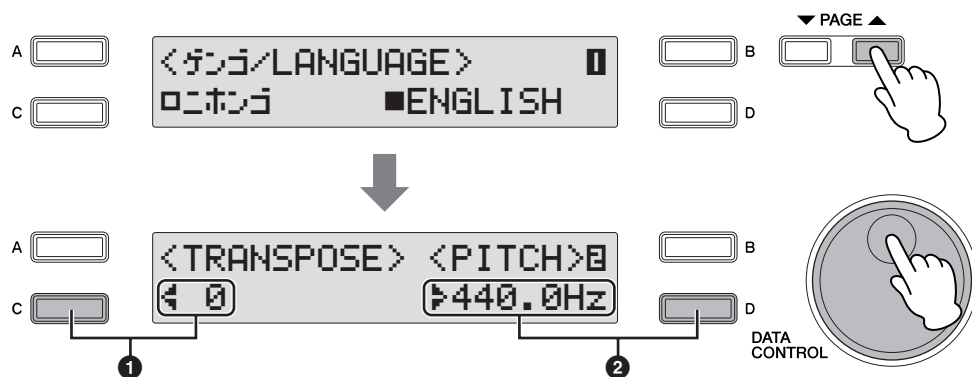

In this page, you can change the Transpose and Pitch settings by using the [C] [D] buttons and the DATA CONTROL Dial.



NOTE

The Transpose setting here is not applicable for XG songs (page 136).

1 Transpose

Determines the coarse pitch setting of all the Voices, and is adjustable in half steps (semitones). Press the [C] button to make the “4” indicator flash, then use the DATA CONTROL Dial to change the setting

Range: -6 – +6

2 Pitch

Determines the fine pitch setting of all the Voices. Each step changes the pitch by 0.2 Hz. The default Pitch setting is 440.0 Hz (corresponding to key A3). Press the [D] button to make the “Hz” indicator flash, then use the DATA CONTROL Dial to change the setting

Range: 427.2 Hz – 452.6 Hz

You can also change the Transpose and Pitch for each Voice section, in the Voice Condition display. (See page 43 for details.)

On the underside and right side of the Electone keyboard is a separate panel equipped with various input/output terminals and miscellaneous controls, the functions of which are described below.

1 Accessory Jacks and Controls

This section provides brief explanations for each jack/control on the Electone. For details on connecting to external devices, see page 153.

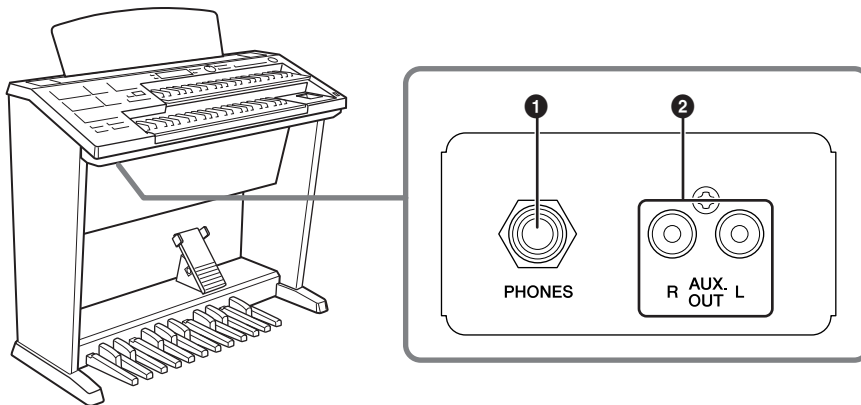

1 AUX OUT (L/R) jacks

This set of stereo outputs is for connection to an external amplifier/speaker. The output level is fixed and cannot be controlled.

2 PHONES jack

For connection of a stereo headphone set. When headphones are connected to this jack, sound to the Electone's built-in speaker system is automatically cut off, allowing you to play without disturbing others.



Reference Pages

Playing the Sounds of the Electone Through an External Audio System (page 153)

Recording the Sounds of the Electone to an External Recorder (page 154)



Reference Page

Using Headphones (page 153)

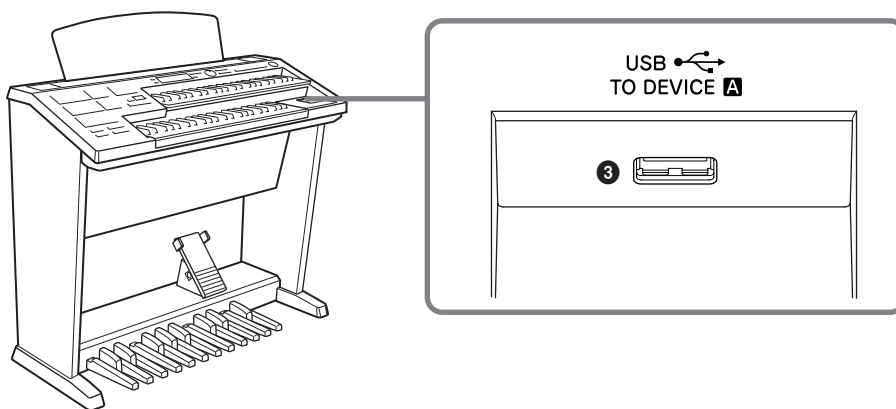

3 USB TO DEVICE A terminal

For connecting USB storage devices (such as Flash Memory).



Reference Pages

Connecting USB storage devices (page 155)



Reference Pages

Controlling External MIDI Devices from the Electone (page 154)

Controlling the Electone from an External Device (page 155)

Connection with Computer (page 156)

What is MIDI (page 157)



Reference Page

Connection with Computer (page 156)

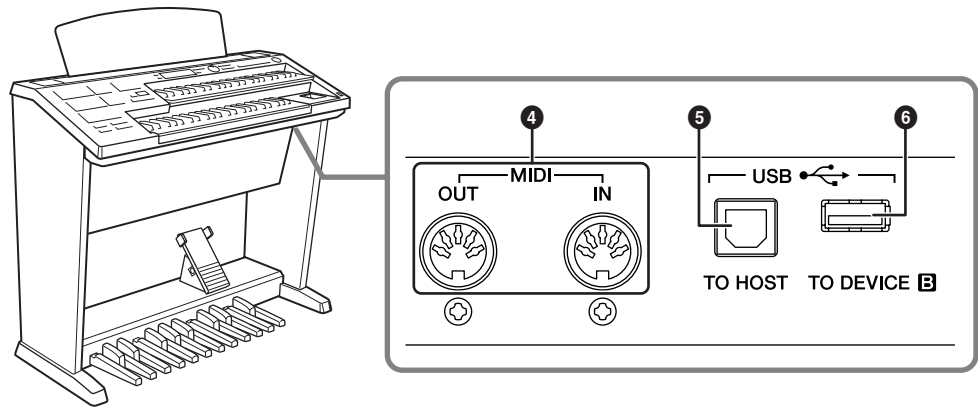

4 MIDI IN/OUT terminals

For connecting external MIDI devices such as a synthesizer or sequencer. You can also use these to connect with a computer that has a MIDI Interface.

5 USB TO HOST terminal

For connecting to a computer with a USB cable. To connect to a computer, make sure that an appropriate USB-MIDI driver is installed to the computer.

6 USB TO DEVICE B terminal

For connecting USB storage devices (such as Flash Memory).

USB

USB is an abbreviation for Universal Serial Bus. It is a serial interface for connecting a computer with peripheral devices.

2 Connection Examples — External Devices



Before connecting the Electone to other electronic components, turn off the power to all the components. Before turning the power of the components on or off, set all volume levels to minimum (0). Otherwise, electrical shock or damage to the components may occur.

Using Headphones

To use headphones, connect them to the PHONES jack (standard 1/4" phone jack).

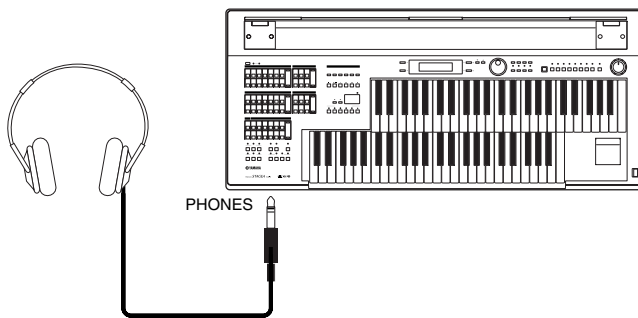

Playing the Sounds of the Electone Through an External Audio System

By using the AUX OUT jacks (RCA), you can connect your Electone to external speakers.

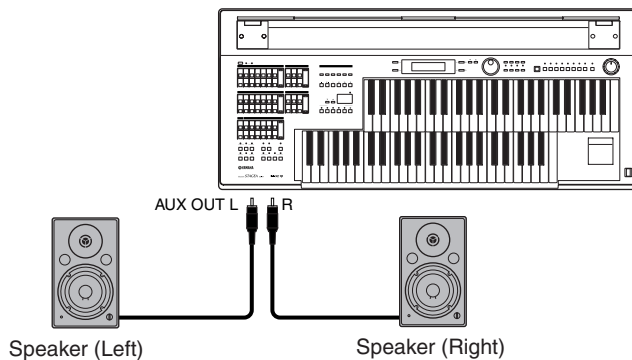

Recording the Sounds of the Electone to an External Recorder

You can record your Electone performance to an external recorder, such as an MD recorder or cassette tape recorder, using the AUX OUT jacks.

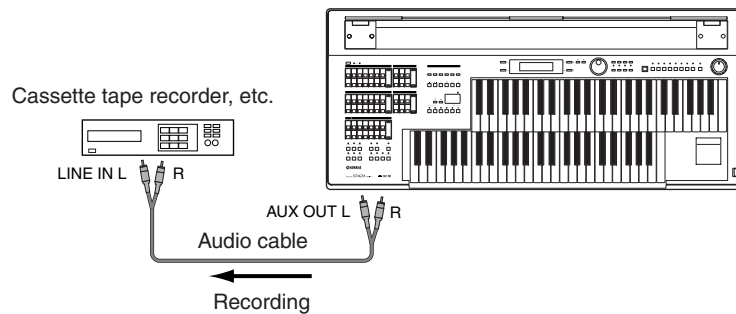

Controlling External MIDI Devices from the Electone

You can use the Electone to remotely play the Voices of a MIDI keyboard (or tone generator), combining them with the Electone and letting you create even richer, more multi-layered sound textures. (The MIDI receive channels of the MIDI keyboard must match the transmit channels on your Electone.)

The Electone transmits a variety of performance messages along with note information as digital data, including values that indicate how far the expression pedal is pressed down and how hard you play the keyboard. How the connected external device responds to these messages depends on the particular device.

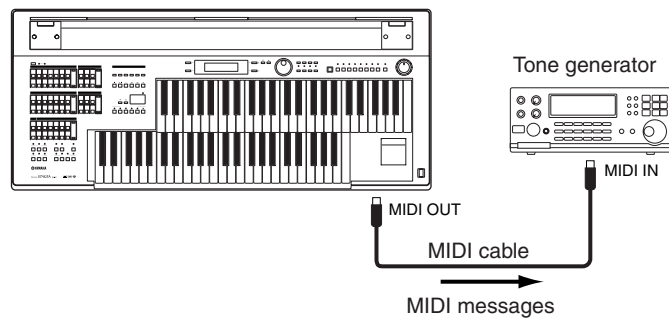

Reference Page

What is MIDI (page 157)



NOTE

When you are using the M.D.R., MIDI data cannot be transmitted.

MIDI terminals are automatically disabled when the USB TO HOST terminal is used.

Controlling the Electone from an External Device

You can use an external MIDI keyboard or sequencer to remotely play the sounds of your Electone and change its Registrations. (You will need to set the MIDI transmit channels of the MIDI keyboard to match the fixed receive channels on your Electone.)

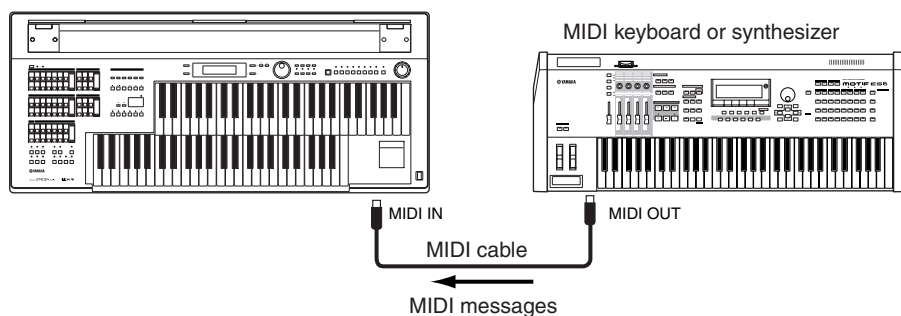

NOTE

When you are using the M.D.R., MIDI data cannot be received.

MIDI terminals are automatically disabled when the USB TO HOST terminal is used.

Connecting USB storage devices

Using the USB TO DEVICE terminal(s), you can connect USB storage devices (such as the USB flash memory) for saving your Electone data.

Compatible USB devices

You can connect up to two USB storage devices (such as a USB flash memory device, floppy disk, Card-R/RW drive, hard disk and other drives) to the USB TO DEVICE terminal(s). Before purchasing a USB storage device, please consult your Yamaha dealer, or an authorized Yamaha distributor for advice.



Reference Pages

Installing the Floppy Disk Drive (page 167)

Formatting External Media (page 109)

Precautions when using the USB TO DEVICE terminals



- Never turn the USB device's power on/off and never plug/unplug the USB cable when the connected USB storage device is of the self-powered type. Doing so may result in the operation of the Electone "freezing" or hanging up.
- While the instrument is accessing data (such as Save, Load, and Delete operations), do NOT unplug the USB cable, do NOT remove the media from the device, and do NOT turn the power off to either device. Doing so may corrupt the data on either or both devices.
- Be careful not to turn the write-protect switch on or off while the USB device is still connected to the terminal. Doing so may cause a malfunction in the M.D.R. operation since the on/off status may not be recognized correctly.



NOTE

If necessary, use a USB hub. Only self-powered (battery or external power supply) types can be used. USB hubs of up to two levels can be used.

3 Connection with Computer

By using the USB TO HOST terminal or MIDI IN/OUT terminals, you can connect your Electone to a computer and receive/transmit MIDI data (for more information about MIDI, see page 157).



Before you can actually transfer data between the Electone and a computer via the USB connection, you will need to install an appropriate MIDI driver. Download the latest MIDI driver software from the Yamaha web site at “<http://music.yamaha.com/download/>.”



NOTE

When you are using the M.D.R., MIDI data cannot be transferred to/from the computer.

Connecting your Electone to a computer opens up a whole new world of musical possibilities. You can save your original songs to computer and create notation (score writing application or sequencing software is needed), and even upload your original Electone song data to your own website, to promote your talents or share songs with your friends. You can also control the Electone from the computer, for example, by playing a MIDI file on the computer to play back the sounds of your Electone.

Using the USB terminal

Using the Electone's USB TO HOST terminal and a standard USB cable, connect the Electone and the computer.

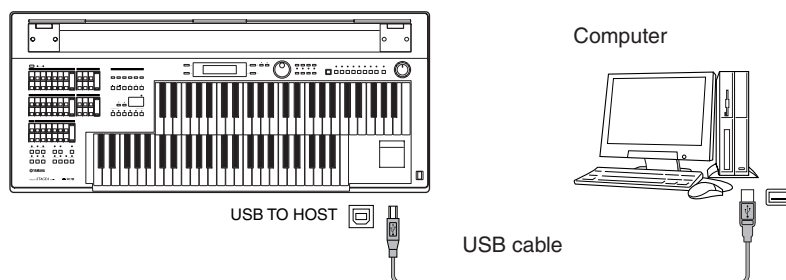

MIDI terminals are automatically disabled when the USB TO HOST terminal is used.

Precautions when using the USB TO HOST terminals

When connecting the computer to the USB TO HOST terminal, make sure to observe the following points. Failing to do so may result in freezing of the computer, corrupting data, and even losing data.

If the computer or the instrument freezes, turn the power to the instrument off or restart the computer.



- Before connecting the computer to the USB TO HOST terminal, exit from any power-saving mode (such as suspended, sleep, standby) of the computer.
- Before turning on the power to the instrument, connect the computer to the USB TO HOST terminal.
- Execute the following before turning the power to the instrument on/off or plugging/unplugging the USB cable to/from the USB TO HOST terminal.
 - Quit any open applications.
 - Make sure that data is not being transmitted from the instrument. (Data is transmitted only by playing notes on the keyboard or playing back a Song.)
- While a USB device is connected to the instrument, you should wait for six seconds or more between these operations: When turning the power of the instrument off then on again, or when alternately connecting/disconnecting the USB cable.

Using the MIDI IN/OUT terminals

By using an optional MIDI interface such as the UX16, you can connect the Electone to the computer, with the MIDI IN/OUT terminals on the instrument. Connect the Electone and the MIDI Interface with two standard MIDI cables (one connecting the OUT terminal on the Electone to the MIDI IN terminal on the interface, and the other connecting the IN terminal on the Electone to the MIDI OUT terminal on the interface). Connect the MIDI interface to the computer with a USB cable.



NOTE

Depending on your particular MIDI interface, you may have to connect the MIDI Interface and the computer with a serial cable.

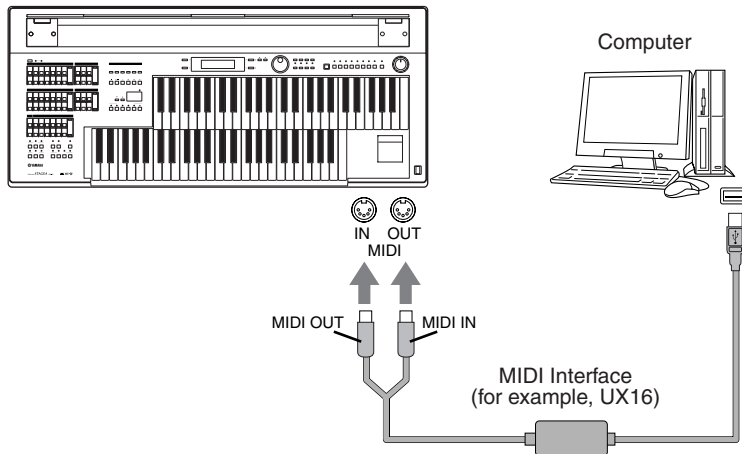

4 MIDI

This section explains what MIDI is, and what it can do, as well as how you can use MIDI on your Electone.

What is MIDI?

No doubt you have heard the terms “acoustic instrument” and “digital instrument.” In the world today, these are the two main categories of instruments. Let’s consider a grand piano and a classical guitar as representative acoustic instruments. They are easy to understand. With the piano, you strike a key, and a hammer inside hits some strings and plays a note. With the guitar, you directly pluck a string and the note sounds. But how does a digital instrument go about playing a note?

Acoustic guitar note production

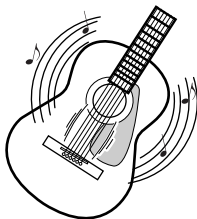

Pluck a string and the body resonates the sound.

Digital instrument note production

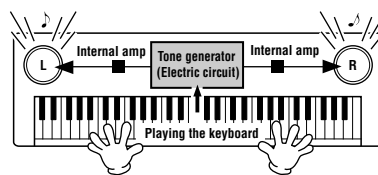

Based on playing information from the keyboard, a sampled note stored in the tone generator is played through the speakers.

As shown in the illustration above, in an electronic instrument the sampled note (previously recorded note) stored in the tone generator section (electronic circuit) is played based on information received from the keyboard, and output through the speakers. So then what is the information from the keyboard that becomes the basis for note production?

For example, let's say you play a "C" quarter note using the grand piano sound on the Electone keyboard. Unlike an acoustic instrument that puts out a resonated note, the electronic instrument puts out information from the keyboard such as "with what Voice," "with which key," "about how strong," "when was it pressed" and "when was it released." Then each piece of information is changed into a number value and sent to the tone generator. Using these numbers as a basis, the tone generator plays the stored sampled note.

Example of Keyboard Information

Voice number (with what Voice)	01 (grand piano)
Note number (with which key)	60 (C3)
Note on (when was it pressed)	Timing expressed numerically (quarter note)
Velocity (about how strong)	120 (strong)

As described above, your keyboard performance and panel operations such as Voice selection are handled as MIDI events. All rhythm-related data—including rhythm patterns, auto accompaniment patterns, Rhythm Sequences, etc.—also consist of MIDI messages.

MIDI (Musical Instrument Digital Interface) allows electronic musical instruments to communicate with each other, by sending and receiving compatible Note, Control Change, Program Change and various other types of MIDI data, or messages.

MIDI Messages of the Electone

MIDI messages can be divided into two groups: the Channel Messages and System Messages. Channel Messages consist of data related to the performance on the keyboard for a specific channel. System Messages consist of data that allows several MIDI devices to communicate with each other.

Channel Messages

Each time you play the keyboard on the Electone, channel messages (indicating which keys are played and how strongly) are transmitted via a specific channel. Similarly, the Electone can be played remotely when receiving this data from an external keyboard.

Note On: Indicates which keys are played with the note numbers 0 through 127. The reception note range is C-2 (0) – G8 (127), C3 = 60.

Note Off: Generated when a key is released.

Velocity: Indicates how strongly the key is played. The range is 1 – 127.

For more detailed information, see “MIDI Data Format” on page 168 and “MIDI Implementation Chart” on page 178.

- **Program Change**

Program Change messages allow you to change Voices in the middle of a song. With these messages you can change the Registrations of the Electone. For more detailed information, see “MIDI Data Format” on page 168 and “MIDI Implementation Chart” on page 178.

- **Control Change**

Control Change Messages let you select Voice banks, control the volume, panning, modulation, portamento time, brightness and various other sound parameters, through specific Control Change numbers.

For more detailed information on the Control Change messages available on the Electone, see “MIDI Data Format” on page 168 and “MIDI Implementation Chart” on page 178.

System Messages

- **System Exclusive Messages**

System Exclusive messages are used to exchange the system and Voice/Registration data.

MIDI Channels

MIDI data is assigned to one of sixteen MIDI channels. Using these channels, 1 – 16, the performance data for sixteen different instrument parts can be simultaneously sent over one MIDI cable.

Think of the MIDI channels as TV channels. Each TV station transmits its broadcasts over a specific channel. Your home TV set receives many different programs simultaneously from several TV stations and you select the appropriate channel to watch the desired program.

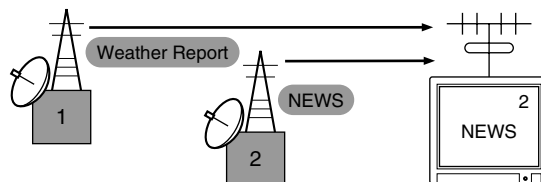

MIDI operates on the same basic principle. The transmitting instrument sends MIDI data on a specific MIDI channel (MIDI Transmit Channel) via a single MIDI cable to the receiving instrument. If the receiving instrument's MIDI channel (MIDI Receive Channel) matches the Transmit Channel, the receiving instrument will sound according to the data sent by the transmitting instrument.

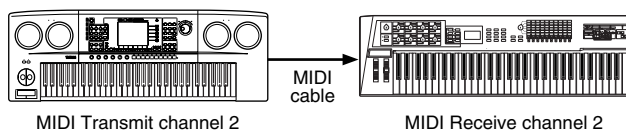

The receive channel of the Electone is fixed at channel 1 for the Upper Keyboard, channel 2 for the Lower Keyboard, and channel 3 for the Pedalboard. This means that when you are using another MIDI device to play the Electone's Voices, you must set the MIDI transmit channel(s) of the connected device to match the receive channel(s) of the Electone. You can select the transmit channel for each keyboard (Upper, Lower and Pedal) from channels 1 – 16. See page 161 for more information.

5 MIDI Control

When you connect your Electone with a second MIDI device (such as a synthesizer or computer), you can determine how the Electone controls that MIDI device, or how the Electone is controlled.

To select the MIDI page:

1 Press the [UTILITY] button.

The Utility display appears. The MIDI Pages are found on Pages 3 – 5.



2 Use the PAGE buttons to select Pages 3 – 5.

Internal/External Display



Internal/External

Switches control over the displayed items between the Electone (Internal) or the connected device (External).

1 Lead

Determines Internal or External control of the Lead Voice.

Press the [B] button to make the indicator flash, then use the DATA CONTROL dial to select the setting.

Internal: The Lead Voice is played from the Upper Keyboard of the Electone. (If the To Lower function is on, it is played from Lower Keyboard.)

External: The Lead Voice is played from the connected instrument via MIDI channel 4.

2 Synchrono

Determines the source of the timing control, for rhythm synchronization purposes.

Press the [C] button to make the indicator flash, then use the DATA CONTROL dial to select the setting.

Internal: Pressing the Rhythm [START] or [SYNCHRO START] button on the panel controls and synchronizes to any connected devices (e.g., sequencer, etc.).

External: Starting the rhythm of a connected rhythm machine also starts the rhythm of the Electone.

③ Expression

Determines the control of the expression pedal functions. Ordinarily, this control is set to Auto. Press the [D] button to make the indicator flash, then use the DATA CONTROL dial to select the setting.

Auto: Internal and External is automatically switched.

Internal: You can manually control the expression pedal even during M.D.R. playback.

External: While playing the M.D.R. or receiving MIDI messages, the expression pedal is invalid. (The volume is controlled by the recorded data in a USB flash memory or received MIDI data.)

MIDI Out Channel Display

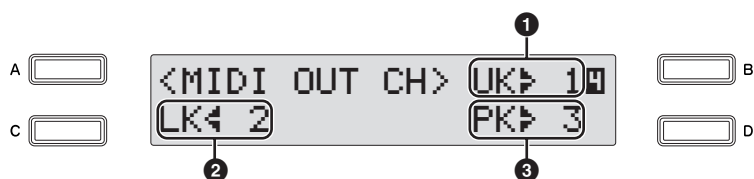

For setting the channels over which MIDI information will be transmitted. Any channel from 1 through 16 can be assigned to each keyboard, the Upper Keyboard, the Lower Keyboard and the Pedalboard. The MIDI messages on each keyboard will be sent on the channels set here. You must set the transmit channel here to match the receive channel of the connected device.

① Upper Keyboard

You can select the channel for the Upper Keyboard.

Press the [B] button to make the indicator flash, then use the DATA CONTROL dial to select the setting.

② Lower Keyboard

You can select the channel for the Lower Keyboard.

Press the [C] button to make the indicator flash, then use the DATA CONTROL dial to select the setting.

③ Pedalboard

You can select the channel for the Pedalboard.

Press the [D] button to make the indicator flash, then use the DATA CONTROL dial to select the setting.







MIDI Out Filter Display



Deletes unnecessary MIDI data and keeps it from being transmitted from the Electone. Rhythm start/stop messages can be filtered on the Electone. Successive presses [C] button alternates between being transmitted (Off) and not transmitted (On).

Assembly Instructions

Carefully read these instructions BEFORE assembling the Electone.

-  Be careful not to confuse any of the parts, and be sure to install all parts in the correct direction by following the procedures given below.
 -  Be sure to assemble the Electone with two or more people.
 -  Don't use any screws other than the ones specified and included in this package. Use of incorrect screws can cause damage and malfunction.
 -  Be sure to tighten all screws upon completing assembly.
 -  Make sure to perform all assembly operations on a flat surface.
 -  To disassemble, reverse the procedures.
- You need a Phillips (+) screwdriver to assemble the Electone.

- 1** Open the package, take out the two styrofoam pads from the both sides of the package, and carefully place the main unit on top of the pads as shown.

Take care not to pinch AC power cord plug between the pads and Main unit.

- 2** Take out all parts from the package.

Please confirm that all parts shown in the illustration are provided.

When you take out the Speaker Unit, always hold the bottom of the Speaker Unit, not holding the Grill Net.

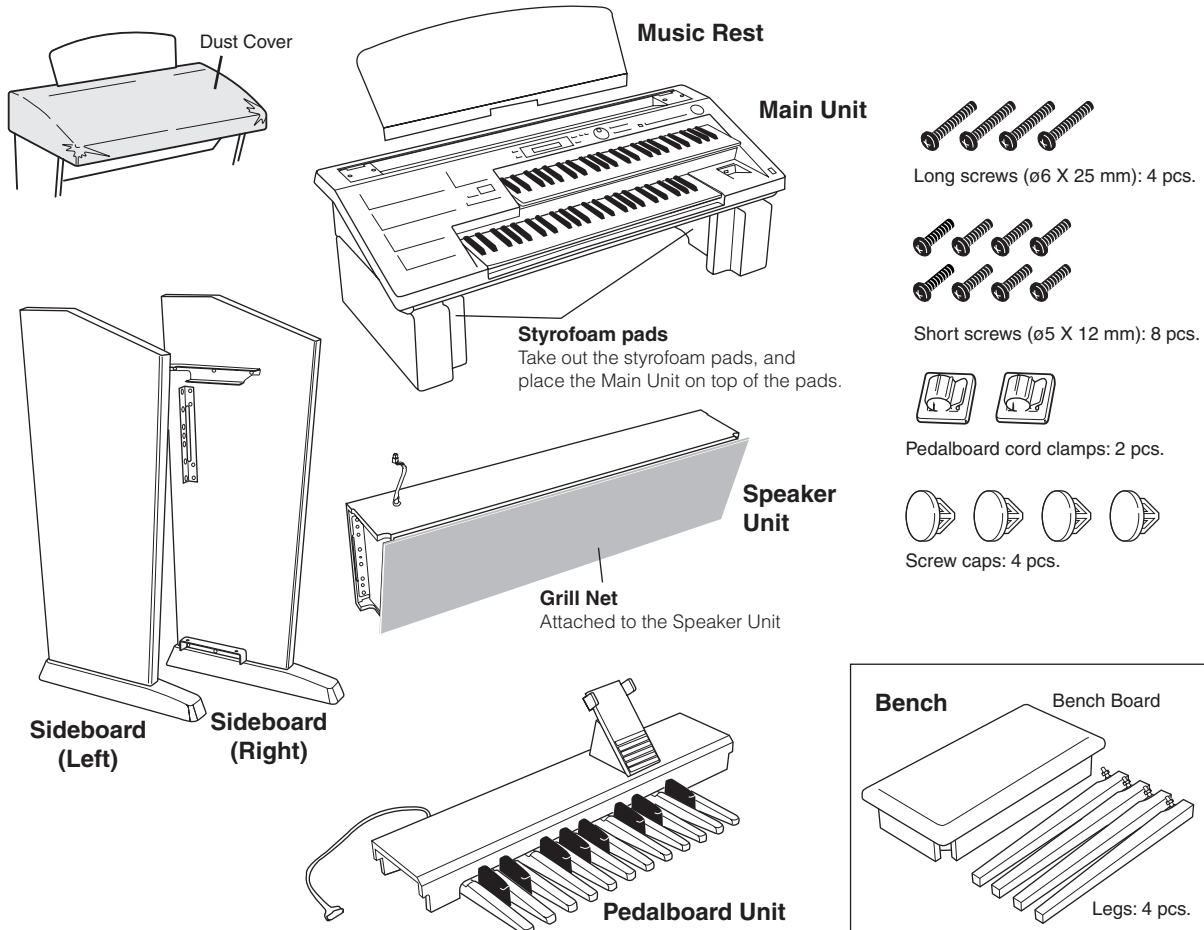

3 Mount the Sideboards onto the Pedalboard unit.

Be sure not to confuse the Right and Left Sideboards.

3-1 Raise the Pedalboard as shown in the illustration below.

3-2 Position each screw hole on both the Pedalboard and Sideboards as shown in the illustration and mount the Sideboards onto the Pedalboard using the 4 short screws (2 screws on each Sideboard).

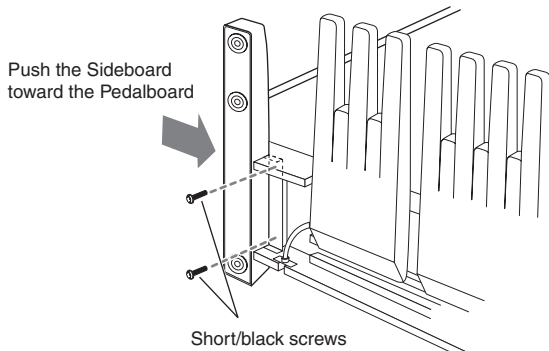

3-3 Stand the Pedalboard after securing the screws.

4 Mount the Speaker Unit onto the Sideboards.

4-1 Remove the Grill Net from the Speaker Unit.

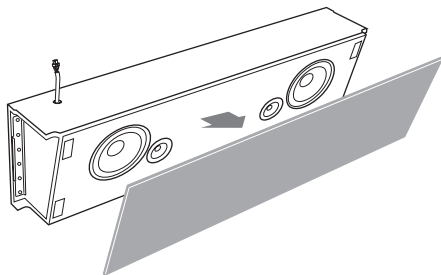

4-2 With the help of another person, hold the Speaker unit horizontally, and slide it from the rear into place along the brackets.

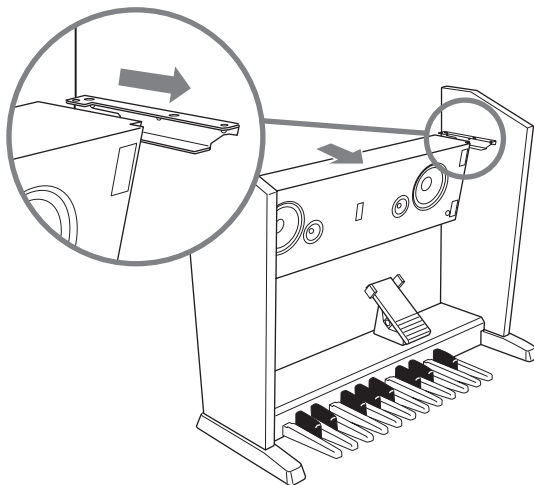

! Take care not to drop the Speaker unit or to pinch your finger(s) between the Speaker unit and Sideboard.

4-3 While holding the Sideboard(s) to the Speaker unit, fasten the four short screws from the rear, to secure the Speaker unit to the Sideboards. Cover the four screw holes on the rear side with the corresponding screw caps.

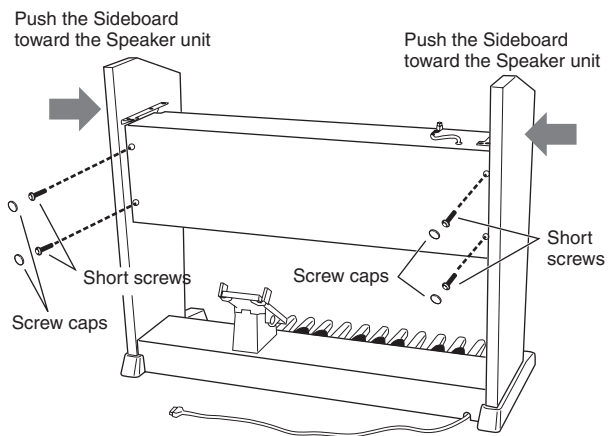

5 Mount the Main Unit.

5-1 As shown in the illustration, hold the Main unit horizontally (with two people), and place it on the front side of the Speaker unit so that the arm at the bottom of the Main unit comes in front of the Sideboards, then slide it to the rear side.

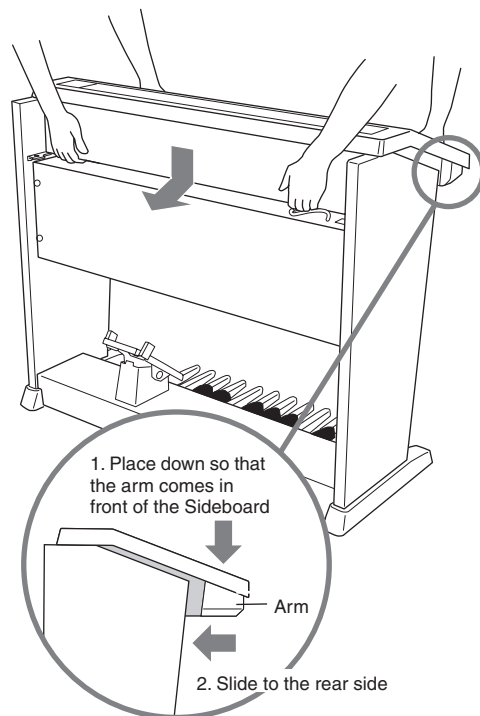

! Take care not to drop the Main unit or to pinch your finger(s) between the Speaker unit and Main unit.

- 5-2** Use the four long screws to fasten the Main unit to the Sideboards as shown in the illustration.

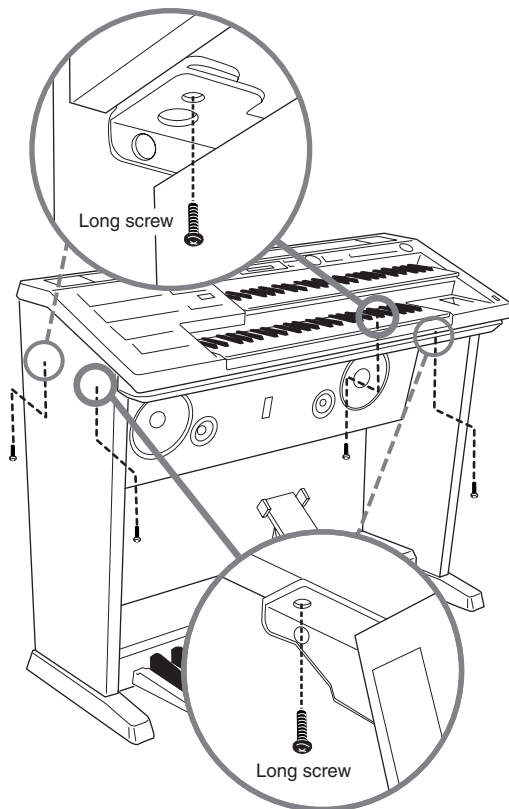

- 6** **Fit the Grill Net onto the Speaker.**
First, align the net with the bottom line, then secure it to the speaker assembly.

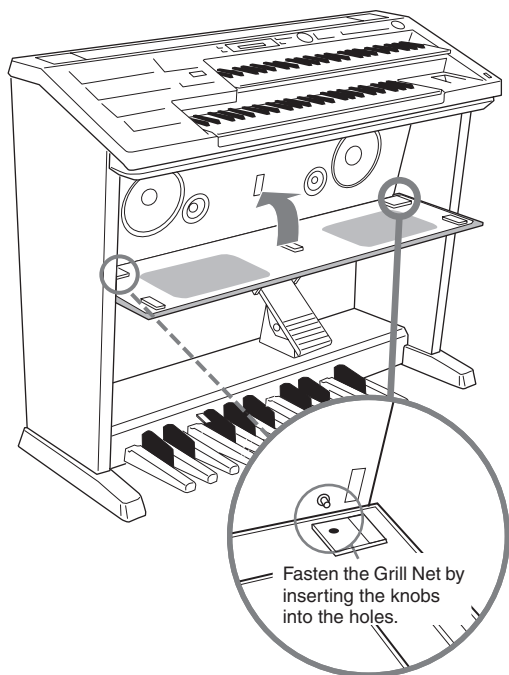

- 7** **Connect the Pedalboard cord and Speaker cord to the Main Unit.**

Make sure that the latches on each plug of the cords face toward you, and connect them to each socket securely.

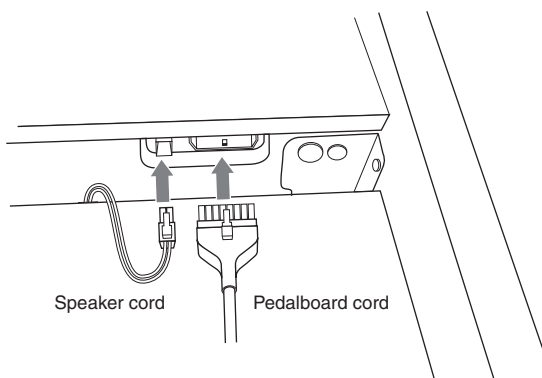

- 8** **Fix the Pedalboard cord to the Sideboard using the Pedalboard cord clamps.**

- 8-1** Affix the two Pedalboard cord clamps to the rear side of the Speaker unit and the lower inside of the Left Sideboard as shown in the illustration.

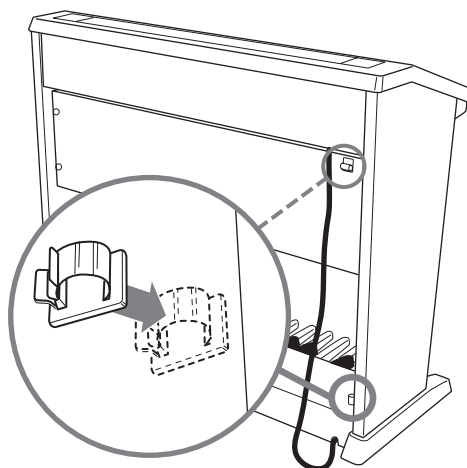

- 8-2** Insert the Pedalboard cord in the clamps.

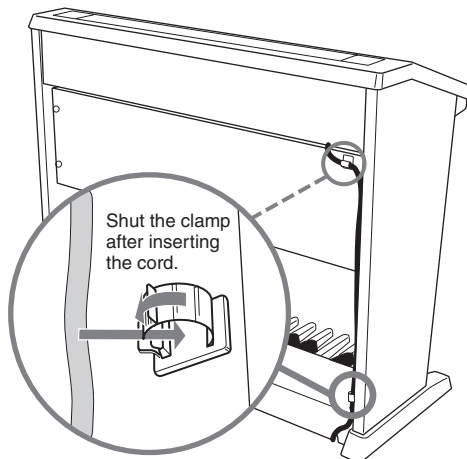

9 Place the music rest on the Electone.

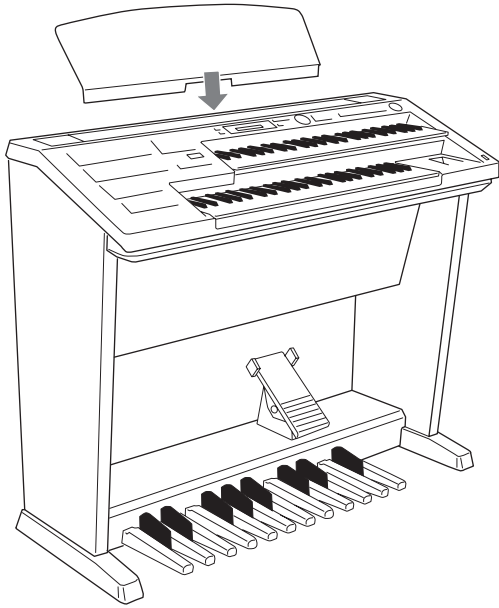

10 Turn on the Electone's power switch and confirm that the Electone can be played, and that the assembly is successful.

BENCH ASSEMBLY

Turn the bench board over and put the legs in place, one by one, at the corners of the bench board, then tighten each nut using the included wrench. Be sure to put the washer between each leg and nut as shown.

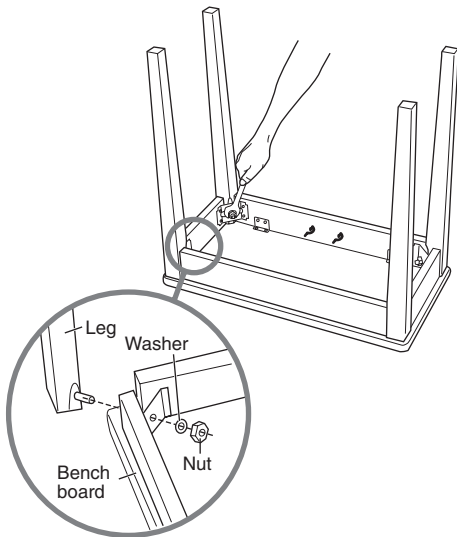

After completing the assembly, please check the following items.

- **Are there any parts left over?**

→ Review all assembly procedures.

- **Is the Electone clear of doors and other movable fixtures?**

→ Move the Electone to an appropriate location.

- **Does the Electone make a rattling noise when you shake it?**

→ Tighten all screws.

- **Can the Electone be turned on?**

→ Confirm that the AC power cord plug is securely connected to an appropriate power outlet.

- **Does the Electone produce sounds?**

→ Confirm that the Speaker cord plug and the Pedalboard cord plug are securely connected to each socket on the Main unit.

If the Electone creaks or is otherwise unsteady when you play on the keyboard, refer to the assembly instructions and tighten all screws again.

Installing Optional Hardware

Installing the Floppy Disk Drive

The optional UD-FD01 floppy disk drive can be installed to the bottom of the instrument by using the included floppy disk drive case and screws. Have a Phillips-head (+) screwdriver ready.

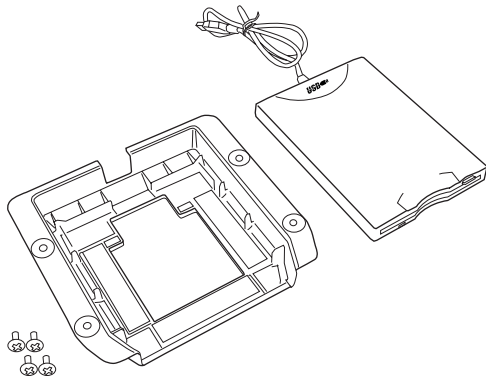

- 1** Remove the three backing papers from the adhesive tape in the case, and fit the floppy disk drive into the case.

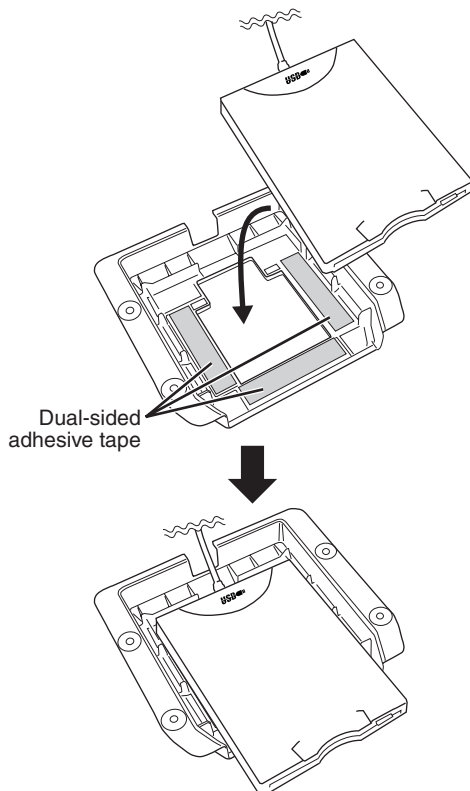

- 2** Fold the USB cable inside the case as shown.

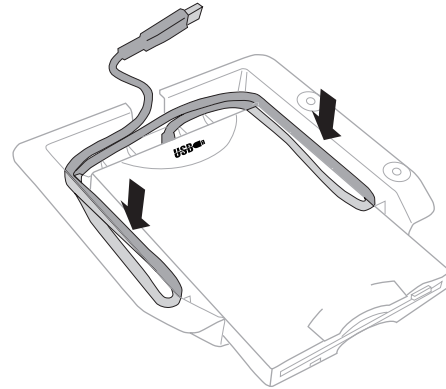

- 3** Attach the drive and case assembly to the right underside of the instrument, using the included four screws (4 mm x 10 mm).

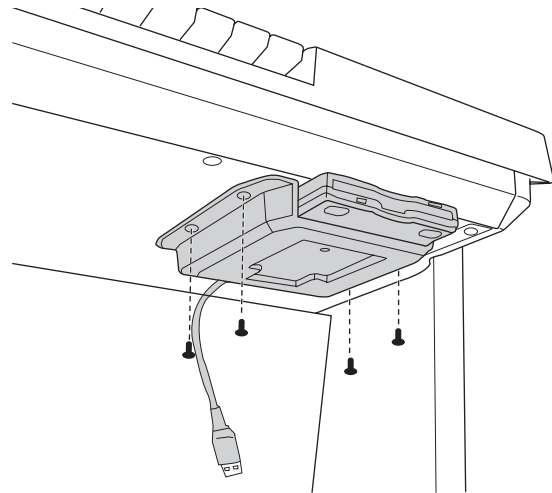

- 4** Connect the USB cable to the [USB TO DEVICE B] terminal.

MIDI Data Format

1. Channel Messages

1.1 EL Mode

"X" indicates "Not available."
"O" indicates "Available."

Code (Hexadecimal)	Function	Receive	Transmit	Remarks
8n, nn, 00-7F	Note Off	1ch 2ch 3ch (4ch)* 5-14ch 15ch	X X X X X X	UK LK PEDAL LEAD 1 XG Keyboard Percussion
9n, nn, 00 9n, nn, 01-7F	Note Off Note On	1ch 2ch 3ch (4ch)* 5-14ch 15ch	(1ch)* (2ch)* (3ch)* X X X	UK LK PEDAL LEAD 1 XG Keyboard Percussion
An, nn, 00-7F	Polyphonic After Touch	5-14ch	X	XG
Bn, 00, 00-7F Bn, 20, 00-7F	Bank select	5-14ch	X	XG
Bn, 01, 00-7F	Modulation	5-14ch	X	XG
Bn, 04, 00-7F	2nd Expression	16ch (4ch)*	X X	Control LEAD 1
Bn, 05, 00-7F	Portamento Time	5-14ch	X	XG
Bn, 06, 00-7F Bn, 26, 00-7F	Data Entry	5-14ch	X	XG
Bn, 07, 00-7F	Volume	5-14ch	X	XG
Bn, 0A, 00-7F	Pan	5-14ch	X	XG
Bn, 0B, 00-7F	Expression	16ch 5-14ch	16ch	Control XG
Bn, 40, 00-7F	Hold	5-14ch	X	XG
Bn, 41, 00-7F	Portamento	5-14ch	X	XG
Bn, 42, 00-7F	Sostenuto	5-14ch	X	XG
Bn, 43, 00-7F	Soft Pedal	5-14ch	X	XG
Bn, 47, 00-7F	Resonance	5-14ch	X	XG
Bn, 48, 00-7F	Release Time	5-14ch	X	XG
Bn, 49, 00-7F	Attack Time	5-14ch	X	XG
Bn, 4A, 00-7F	Brightness	5-14ch	X	XG
Bn, 4B, 00-7F	Decay Time	5-14ch	X	XG
Bn, 4C, 00-7F	Vibrato Rate	5-14ch	X	XG
Bn, 4D, 00-7F	Vibrato Depth	5-14ch	X	XG
Bn, 4E, 00-7F	Vibrato Delay	5-14ch	X	XG
Bn, 54, 00-7F	Portamento Control	5-14ch	X	XG
Bn, 5B, 00-7F	Reverb Send Level	5-14ch	X	XG
Bn, 5D, 00-7F	Chorus Send Level	5-14ch	X	XG
Bn, 5E, 00-7F	Variation Effect Send Level	5-14ch	X	XG
Bn, 60, 00-7F Bn, 61, 00-7F	Data Increment Data Decrement	5-14ch	X	XG
Bn, 62, 00-7F Bn, 63, 00-7F	NRPN LSB NRPN MSB	5-14ch	X	XG
Bn, 64, 00-7F Bn, 65, 00-7F	RPN LSB RPN MSB	5-14ch	X	XG

Code (Hexadecimal)	Function	Receive	Transmit	Remarks
Bn, 78, 00 Bn, 79, 00 Bn, 7B, 00 Bn, 7C, 00 Bn, 7D, 00 Bn, 7E, 00 Bn, 7F, 00	All Sound Off Reset All Controllers All Note Off Omni Off Omni On Mono Poly	5-14ch	×	XG
Cn, nn	Program Change	5-14ch 16ch	×	XG Control
Dn, 00-7F	After Touch	1ch 2ch 3ch (4ch)* 5-14ch	(1ch)* (2ch)* (3ch)*	UK LK PEDAL LEAD 1 XG
En, 00-7F, 00-7F	Pitch Bend	5-14ch		XG

* Can be changed in the MIDI settings (page 161).

** Can be output when assigned to channel 4.

1.2 XG Mode

Code (Hexadecimal)	Function	Receive	Transmit	Remarks
8n, nn, 00-7F	Note Off	1-16ch	×	
9n, nn, 00 9n, nn, 01-7F	Note On Note Off	1-16ch	(1ch)* (2ch)* (3ch)*	UK LK PEDAL
An, nn, 00-7F	Polyphonic After Touch	1-16ch	×	
Bn, 00, 00-7F Bn, 20, 00-7F	Bank select	1-16ch	×	
Bn, 01, 00-7F	Modulation	1-16ch	×	
Bn, 04, 00-7F	2nd Expression	×	×	
Bn, 05, 00-7F	Portamento Time	1-16ch	×	
Bn, 06, 00-7F Bn, 26, 00-7F	Data Entry	1-16ch	×	
Bn, 07, 00-7F	Volume	1-16ch	×	
Bn, 0A, 00-7F	Pan	1-16ch	×	
Bn, 0B, 00-7F	Expression	1-16ch	16ch	Control
Bn, 40, 00-7F	Hold	1-16ch	×	
Bn, 41, 00-7F	Portamento	1-16ch	×	
Bn, 42, 00-7F	Sostenuto	1-16ch	×	
Bn, 43, 00-7F	Soft Pedal	1-16ch	×	
Bn, 47, 00-7F	Resonance	1-16ch	×	
Bn, 48, 00-7F	Release Time	1-16ch	×	
Bn, 49, 00-7F	Attack Time	1-16ch	×	
Bn, 4A, 00-7F	Brightness	1-16ch	×	
Bn, 4B, 00-7F	Decay Time	1-16ch	×	
Bn, 4C, 00-7F	Vibrato Rate	1-16ch	×	
Bn, 4D, 00-7F	Vibrato Depth	1-16ch	×	
Bn, 4E, 00-7F	Vibrato Delay	1-16ch	×	
Bn, 54, 00-7F	Portamento Control	1-16ch	×	
Bn, 5B, 00-7F	Reverb Send Level	1-16ch	×	
Bn, 5D, 00-7F	Chorus Send Level	1-16ch	×	
Bn, 5E, 00-7F	Variation Effect Send Level	1-16ch	×	

Code (Hexadecimal)	Function	Receive	Transmit	Remarks
Bn, 60, 00-7F Bn, 61, 00-7F	Data Increment Data Decrement	1-16ch	×	
Bn, 62, 00-7F Bn, 63, 00-7F	NRPN LSB NRPN MSB	1-16ch	×	
Bn, 64, 00-7F Bn, 65, 00-7F	RPN LSB RPN MSB	1-16ch	×	
Bn, 78, 00 Bn, 79, 00 Bn, 7B, 00 Bn, 7C, 00 Bn, 7D, 00 Bn, 7E, 00 Bn, 7F, 00	All Sound Off Reset All Controllers All Note Off Omni Off Omni On Mono Poly	1-16ch	×	
Cn, 00-7F	Program Change	1-16ch	16ch	Control
Dn, 00-7F	After Touch	1-16ch	(1ch)* (2ch)* (3ch)*	UK LK PEDAL
En, 00-7F, 00-7F	Pitch Bend	1-16ch	×	

* Can be changed in the MIDI settings (page 161).

** Can be output when assigned to channel 4.

2. Realtime Messages

Code (Hexadecimal)	Function	Receive		Transmit	Remarks
		EL mode	XG mode		
F8	Clock	○*	×	○	
FA	Start	○	×	○	
FC	Stop	○	×	○	
FE	Active Sensing	○	○	○	
FF	Reset	×	×	×	

* Received only when in the Ext. mode

3. System Exclusive Messages

3.1 Format

Universal Realtime Messages

Code (Hexadecimal)	Message	Receive	Transmit
F0, 7F, 7F, 04, 01, SS, TT, F7 XN	GM2 Master Volume	○	×
F0, 7F, 7F, 04, 03, SS, TT, F7 XN	GM2 Master Fine Tuning	○	×
F0, 7F, 7F, 04, 04, 00, TT, F7 XN	GM2 Master Coarse Tuning	○	×
F0, 7F, 7F, 04, 05, 01, 01, 01, 01, 01, PP, VV, ..., F7 XN	GM2 Reverb Parameter	○	×
F0, 7F, 7F, 04, 05, 01, 01, 01, 01, 02, PP, VV, ..., F7 XN	GM2 Chorus Parameter	○	×
F0, 7F, 7F, 09, 01, 0n, PP, VV, ..., F7 XN	GM2 After Touch Parameter	○	×
F0, 7F, 7F, 09, 03, 0n, CC, PP, VV, ..., F7 XN	GM2 Control Change Parameter	○	×
F0, 7F, 7F, 0A, 01, 0n, KK, CC, PP, VV, ..., F7 XN	GM2 Key-Based Controller	○	×

Universal Non-Realtime Messages

Code (Hexadecimal)	Message	Receive	Transmit
F0, 7E, 7F, 09, 01, F7 XN	GM ON	○	×
F0, 7E, 7F, 09, 03, F7 XN	GM2 ON	○	×
F0, 7E, 7F, 09, 02, F7 XN	GM OFF	○	×
F0, 7E, 7F, 08, 08, JJ, GG, MM, ..data..., F7 XN	GM2 Scale/Octave Tuning	○	×

XG Native

Code (Hexadecimal)	Message	Receive	Transmit
F0, 43, 1N, 4C, AH, AM, AL, ..data..., F7	XG Parameter Change	○	×
F0, 43, 0N, 4C, BH, BL, AH, AM, AL, ..data..., cc, F7	XG Bulk Dump	○	×
F0, 43, 1N, 27, 30, 00, 00, MM, LL, cc, F7	XG Master Tuning	○	×

Clavinova Exclusive

Code (Hexadecimal)	Message	Receive	Transmit
F0, 43, 73, 01, 02, F7 03	Request for Internal Synch. Mode Request for External Synch. Mode	○ ○	×

Message Exclusive

Code (Hexadecimal)	Message	Receive	Transmit
F0, 43, 60, 7A, F7	Rhythm Start	○	×
F0, 43, 60, 7D, F7	Rhythm Stop	○	×

Electone Exclusive

Code (Hexadecimal)	Message	Receive	Transmit
F0, 43, 70, 70, 00, ..data..., F7 78 ID	Bulk Dump Data	○ ○ ○	×
F0, 43, 70, ID, 00, F7	Model ID Data	×	○
F0, 43, 70, 70, 30, F7	Request-to-Send Model ID Data	○	×
F0, 43, 70, 70, 38, 7F, F7 00	Bulk Dump Acknowledged Bulk Dump Unacknowledged	×	×
F0, 43, 70, 70, 40, nn(*1), 7F, F7 00	Switch ON Switch OFF	○ ○	○
F0, 43, 70, 70, 40, 50, TL, TH, F7	Tempo	○	○
F0, 43, 70, 78, 41, cc, dd, F7(*2)	Panel Switch Events	○	○
F0, 43, 70, 78, 42, 3C, ..data..., F7	Current Registration Data	○	○
F0, 43, 70, 78, 44, ..data..(*3), F7	MIDI Parameters	○	○
F0, 43, 70, 70, 70, nn(*4), F7	MDR	○	×
F0, 43, 70, 70, 73, F7	EL ON	○	×
F0, 43, 70, 70, 78, 00, 00, F7	Bar Signal	×	○

X: don't care N: Device Number (only "0") ID: Model ID (ELB-01=4FH)

*1. Switches

nn	Switch	Receive	Transmit
45H	Left Footswitch	○	○
47H	Knee Lever	○	○
4DH	Solo Bar	○	○

*2. Panel Switch Events

MIDI Exclusive Format
F0, 43, 70, 78, 41, cc, dd, F7

Selectors

cc Code	Switch	dd				Remarks
		Receive	Rx Range	Transmit	Tx Range	
0F	Registration Memory [1-16]	○	[00-0F]	×	-	

Volume

cc Code	Switch	dd				Remarks
		Receive	Rx Range	Transmit	Tx Range	
12	Upper Keyboard Voice 1 Volume	○	[00-7F]	○	[00-7F]	Volume Data 00:MAX, 7F:MIN
13	Lower Keyboard Voice 1 Volume	○	[00-7F]	○	[00-7F]	Volume Data 00:MAX, 7F:MIN
14	Upper Keyboard Voice 2 Volume	○	[00-7F]	○	[00-7F]	Volume Data 00:MAX, 7F:MIN
15	Lower Keyboard Voice 2 Volume	○	[00-7F]	○	[00-7F]	Volume Data 00:MAX, 7F:MIN
16	Lead Voice 1 Volume	○	[00-7F]	○	[00-7F]	Volume Data 00:MAX, 7F:MIN
17	Pedal Voice 1 Volume	○	[00-7F]	○	[00-7F]	Volume Data 00:MAX, 7F:MIN
18	Pedal Voice 2 Volume	○	[00-7F]	○	[00-7F]	Volume Data 00:MAX, 7F:MIN
1A	Percussion Volume	○	[00-7F]	○	[00-7F]	Volume Data 00:MAX, 7F:MIN
1B	Reverb Depth	○	[00-7F]	○	[00-7F]	Depth Data 00:MAX, 7F:MIN

To Lower

cc Code	Switch	dd				Remarks
		Receive	Rx Range	Transmit	Tx Range	
36	Lead Voice 1 To Lower [TO LOWER ▼]	○	[00-01]	○	[00-01]	00:OFF, 01:ON
37	Pedal Voice 1 To Lower [TO LOWER ▲]	○	[00-01]	○	[00-01]	00:OFF, 01:ON
38	Pedal Voice 2 To Lower [TO LOWER ▲]	○	[00-01]	○	[00-01]	00:OFF, 01:ON

Sustain

cc Code	Switch	dd				Remarks
		Receive	Rx Range	Transmit	Tx Range	
50	Upper Sustain [UPPER (KNEE)]	○	[00-01]	○	[00-01]	00:OFF, 01:ON
51	Lower Sustain [LOWER (KNEE)]	○	[00-01]	○	[00-01]	00:OFF, 01:ON
52	Pedal Sustain [PEDAL]	○	[00-01]	○	[00-01]	00:OFF, 01:ON

Keyboard Percussion

cc Code	Switch	dd				Remarks
		Receive	Rx Range	Transmit	Tx Range	
5B	Keyboard Percussion [1]	○	[00-01]	○	[00-01]	00:OFF, 01:ON
5C	Keyboard Percussion [2]	○	[00-01]	○	[00-01]	00:OFF, 01:ON

Disable

cc Code	Switch	dd				Remarks
		Receive	Rx Range	Transmit	Tx Range	
5F	Disable [D.]	○	[00-01]	○	[00-01]	00:OFF, 01:ON

Rotary Speaker

cc	Switch	dd				Remarks
		Receive	Rx Range	Transmit	Tx Range	
60	Rotary Speaker Speed [ROTARY SP SPEED]	○	[00-01]	○	[00-01]	00:OFF, 01:ON

Rhythm Sequence

cc	Switch	dd				Remarks
		Receive	Rx Range	Transmit	Tx Range	
61	Sequence 1 [SEQ.1]	○	[00-01]	○	[00-01]	00:OFF, 01:ON
62	Sequence 2 [SEQ.2]	○	[00-01]	○	[00-01]	00:OFF, 01:ON
63	Sequence 3 [SEQ.3]	○	[00-01]	○	[00-01]	00:OFF, 01:ON
64	Sequence 4 [SEQ.4]	○	[00-01]	○	[00-01]	00:OFF, 01:ON

*3. MIDI Parameter

Voice Section Parameters

Panel Voice Parameters

(Address mm: 0 – 4, 6 – 7 = UK1, UK2, LK1, LK2, LEAD 1, PEDAL 1, PEDAL 2)

MIDI Exclusive Format

F0, 43, 70, 78, 44, hh, mm, ll, ..., F7

hh	Address		Size	Data	Parameter	Data	Receive	Rx Range	Transmit	Tx Range
	mm	ll								
10	00-07	00-0D	5	00-7F 00-7F 00 00 00	Voice Assign Number	00-7F 00-7F 00 00 00	○	00-7F 00-7F 00 00 00	○	00-7F 00-7F 00 00 00
10	00-07	10	1	00-0D	Voice Selector Number	00-0D	○	00-0D	○	00-0D
10	00-07	11	1	00-7F	Volume	00:MIN 7F:MAX	○	00-7F	×	-
10	00-07	12	1	00-7F	Reverb (Send Level)	00:MIN 7F:MAX	○	00-7F	○	00-7F
10	00-07	14	1	00-04	Feet	00:PRESET 01:16' 02:8' 03:4' 04:2'	○	00-7F	○	00-04
10	00-07	15	1	00-7F	Pan	00:LEFT 40:CENTER 7F:RIGHT	○	00-7F	○	08-78
10	00-07	16	1	00-7F	Touch Tone Initial Touch	00:MIN 7F:MAX	○	00-7F	○	00-7F
10	00-07	19	1	00-7F	User Vibrato	00:PRESET 01:USER	○	00-7F	○	00-01
10	00-07	1A	1	00-7F	Vibrato Delay	00:SHORT 7F:LONG	○	00-7F	○	02-1A
10	00-07	1B	1	00-7F	Vibrato Depth	00:MIN 7F:MAX	○	00-7F	○	00-54
10	00-07	1C	1	00-7F	Vibrato Speed	00:SLOW 7F:FAST	○	00-7F	○	3C-6C
10	04-07	1F	1	00-7F	TO LOWER▼/▲	00:OFF 01:ON	○	00-7F	×	-
10	04-05	20	1	00-02	Slide (On/Knee Lever/Off)	00:OFF 01:ON 02:Knee Lever	○	00-02	○	00-01
10	04-05	21	1	00-7F	Slide Time	00:FAST 7F:SLOW	○	00-7F	○	02-7F
10	00-07	22	1	00-7F	Tune/Detune	00:Down 40:Center 7F:Up	○	00-7F	○	00-7F
10	00-01/ 04-07	23	1	00-7F	2nd Expression Pitch Bend	00:OFF 01:ON	○	00-7F	×	00-01
10	00-05	24	1	00-7F	Footswitch Glide Control	00:OFF 01:ON	○	00-7F	○	00-01

Address			Size	Data	Parameter	Data	Receive	Rx Range	Transmit	Tx Range
hh	mm	ll								
10	00-07	25	1	3A-46	Transpose	3A:KeyDown 40:Normal 46:KeyUp	○	3A-46	○	3A-46
10	00-07	2A	1	00-7F	Volume Mute	00:Mute OFF 01:Mute ON	○	00-7F	○	00-01
10	00-07	40	3	00 00-7F 00-7F	Effect 1 Type MSB/LSB	00 00-7F 00-7F	○	00 00-7F 00-7F	○	00 00-7F 00-7F
10	00-07	41	2	0000-7F7F	Effect 1 Parameter 1 MSB/LSB	0000-7F7F	○	0000-7F7F	○	0000-7F7F
10	00-07	42	2	0000-7F7F	Effect 1 Parameter 2 MSB/LSB	0000-7F7F		0000-7F7F		0000-7F7F
10	00-07	43	2	0000-7F7F	Effect 1 Parameter 3 MSB/LSB	0000-7F7F		0000-7F7F		0000-7F7F
10	00-07	44	2	0000-7F7F	Effect 1 Parameter 4 MSB/LSB	0000-7F7F		0000-7F7F		0000-7F7F
10	00-07	45	2	0000-7F7F	Effect 1 Parameter 5 MSB/LSB	0000-7F7F		0000-7F7F		0000-7F7F
10	00-07	46	2	0000-7F7F	Effect 1 Parameter 6 MSB/LSB	0000-7F7F		0000-7F7F		0000-7F7F
10	00-07	47	2	0000-7F7F	Effect 1 Parameter 7 MSB/LSB	0000-7F7F		0000-7F7F		0000-7F7F
10	00-07	48	2	0000-7F7F	Effect 1 Parameter 8 MSB/LSB	0000-7F7F		0000-7F7F		0000-7F7F
10	00-07	49	2	0000-7F7F	Effect 1 Parameter 9 MSB/LSB	0000-7F7F		0000-7F7F		0000-7F7F
10	00-07	4A	2	0000-7F7F	Effect 1 Parameter 10 MSB/LSB	0000-7F7F		0000-7F7F		0000-7F7F
10	00-07	4B	2	0000-7F7F	Effect 1 Parameter 11	0000-7F7F		0000-7F7F		0000-7F7F
10	00-07	4C	2	0000-7F7F	Effect 1 Parameter 12	0000-7F7F		0000-7F7F		0000-7F7F
10	00-07	4D	2	0000-7F7F	Effect 1 Parameter 13	0000-7F7F		0000-7F7F		0000-7F7F
10	00-07	4E	2	0000-7F7F	Effect 1 Parameter 14	0000-7F7F		0000-7F7F		0000-7F7F
10	00-07	4F	2	0000-7F7F	Effect 1 Parameter 15	0000-7F7F		0000-7F7F		0000-7F7F
10	00-07	50	2	0000-7F7F	Effect 1 Parameter 16	0000-7F7F		0000-7F7F		0000-7F7F

Keyboard Parameters

Sustain Parameters (Address mm: 0 – 2 = UK, LK, PEDAL)

Address			Size	Data	Parameter	Data	Receive	Rx Range	Transmit	Tx Range
hh	mm	ll								
12	00-02	00	1	00-7F	Sustain (On/Off)	00:OFF 01:ON	○	00-7F	×	-
12	00-02	01	1	00-7F	Length	00:Short 7F:Long	○	00-7F	○	15-3D

Keyboard Percussion Parameters (Address mm: 1 – 2 = K.B.P. [1], K.B.P. [2])

Address			Size	Data	Parameter	Data	Receive	Rx Range	Transmit	Tx Range
hh	mm	ll								
12	01-02	10	1	00-7F	Keyboard Percussion (On/Off)	00:OFF 01:ON	○	00-7F	×	-
12	01-02	11	1	00-08	Keyboard Percussion Menu	00:PRESET 01:USER 1 02:USER 2 03:USER 3 04:USER 4 05:USER 5 06:USER 6 07:USER 7 08:USER 8	○	00-08	○	00-08

Rhythm

Rhythm Parameters

Address			Size	Data	Parameter	Data	Receive	Rx Range	Transmit	Tx Range
hh	mm	ll								
13	00	00-0B	2	0000-7F7F	Rhythm Assign Number	0000-7F7F	○	00-7F 00-7F	○	00-7F 00-7F
13	00	10	1	00-0B	Rhythm Selector Number	00-0B	○	00-0B	○	00-0B
13	00	11	1	00-7F	Percussion Volume	00:MIN 7F:MAX	○	00-7F	×	-
13	00	12	1	00-7F	Percussion Reverb (Send Level)	00:MIN 7F:MAX	○	00-7F	○	00-7F
13	00	13	1	00-7F	2nd Expression Tempo Control (On/Off)	00:OFF 01:ON	○	00-7F	×	00-01
13	00	14	1	00-7F	Footswitch Rhythm Control	00:INTRO 1 01:INTRO 2 02:INTRO 3 08:MAIN A 09:MAIN B 0A:MAIN C 0B:MAIN D 18:BREAK 20:ENDING 1 21:ENDING 2 22:ENDING 3 7E:STOP 7F:OFF (INTRO 1 – STOP)	○	00-7F	○	00-7F
13	00	15	1	00-7F	Add Drum (On/Off)	00:OFF 01:ON	○	00-7F	○	00-01
13	00	16	1	00-7F	Main Drum (On/Off)	00:OFF 01:ON	○	00-7F	○	00-01
13	00	17	1	00-7F	Chord 1 (On/Off)	00:OFF 01:ON	○	00-7F	○	00-01
13	00	18	1	00-7F	Chord 2 (On/Off)	00:OFF 01:ON	○	00-7F	○	00-01
13	00	19	1	00-7F	Pad (On/Off)	00:OFF 01:ON	○	00-7F	○	00-01
13	00	1A	1	00-7F	Phrase 1 (On/Off)	00:OFF 01:ON	○	00-7F	○	00-01
13	00	1B	1	00-7F	Phrase 2 (On/Off)	00:OFF 01:ON	○	00-7F	○	00-01
13	00	1C	1	00-7F	Auto Fill (On/Off)	00:OFF 01:ON	○	00-7F	○	00-01

Rhythm Sequence Parameters

Address			Size	Data	Parameter	Data	Receive	Rx Range	Transmit	Tx Range
hh	mm	ll								
13	01	00-03	1	00-7F	Sequence [SEQ.1] – [SEQ.4]	00:OFF 01:ON	○	00-7F	×	-

Accompaniment Parameters

Address			Size	Data	Parameter	Data	Receive	Rx Range	Transmit	Tx Range
hh	mm	ll								
13	02	11	1	00-7F	Accompaniment Volume	00:MIN 7F:MAX	○	00-7F	○	00-7F
13	02	12	1	00-7F	Accompaniment Reverb (Send Level)	00:MIN 7F:MAX	○	00-7F	○	00-7F

A.B.C. Function Parameters

Address			Size	Data	Parameter	Data	Receive	Rx Range	Transmit	Tx Range
hh	mm	ll								
13	03	00	1	00-7F	Auto Bass Chord Mode	00:OFF 01:Single Finger 02:Fingered 03:Custom A.B.C.	○	00-7F	○	00-03
13	03	01	1	00-7F	Lower Memory (On/Off)	00:OFF 01:ON	○	00-7F	○	00-01
13	03	02	1	00-7F	Pedal Memory (On/Off)	00:OFF 01:ON	○	00-7F	○	00-01

M.O.C. Function Parameters

Address			Size	Data	Parameter	Data	Receive	Rx Range	Transmit	Tx Range
hh	mm	ll								
13	04	00	1	00-7F	Melody On Chord Mode	00:OFF 01:ON	○	00-7F	○	00-01
13	04	01	1	00-7F	M.O.C. Knee Lever Control (On/Off)	00:OFF 01:ON	○	00-7F	×	00-01

Section Parameters

Address			Size	Data	Parameter	Data	Receive	Rx Range	Transmit	Tx Range
hh	mm	ll								
13	05	00	1	00-7F	Intro 1 (On/Off)	00:OFF 01:ON	○	00-7F	○	00-01
13	05	01	1	00-7F	Intro 2 (On/Off)	00:OFF 01:ON	○	00-7F	○	00-01
13	05	02	1	00-7F	Intro 3 (On/Off)	00:OFF 01:ON	○	00-7F	○	00-01
13	05	08	1	00-7F	Main A (On/Off)	00:OFF 01:ON	○	00-7F	○	00-01
13	05	09	1	00-7F	Main B (On/Off)	00:OFF 01:ON	○	00-7F	○	00-01
13	05	0A	1	00-7F	Main C (On/Off)	00:OFF 01:ON	○	00-7F	○	00-01
13	05	0B	1	00-7F	Main D (On/Off)	00:OFF 01:ON	○	00-7F	○	00-01
13	05	18	1	00-7F	Break (On/Off)	00:OFF 01:ON	○	00-7F	○	00-01
13	05	20	1	00-7F	Ending 1 (On/Off)	00:OFF 01:ON	○	00-7F	○	00-01
13	05	21	1	00-7F	Ending 2 (On/Off)	00:OFF 01:ON	○	00-7F	○	00-01
13	05	22	1	00-7F	Ending 3 (On/Off)	00:OFF 01:ON	○	00-7F	○	00-01

Keyboard Percussion Parameters

Address			Size	Data	Parameter	Data	Receive	Rx Range	Transmit	Tx Range
hh	mm	ll								
13	10	11	1	00-7F	Volume	00:MIN 7F:MAX	○	00-7F	○	00-7F
13	10	12	1	00-7F	Reverb (Send Level)	00:MIN 7F:MAX	○	00-7F	○	00-7F

Overall

System Parameters

Address			Size	Data	Parameter	Data	Receive	Rx Range	Transmit	Tx Range
hh	mm	ll								
14	00	00	1	00-7F	Disable (On/Off)	00:OFF 01:ON	○	00-7F	×	-
14	00	02	1	3A-46	Transpose	3A:KeyDown 40:Normal 46:KeyUp	○	3A-46	○	3A-46
14	00	03	1	01-0C	2nd Expression Range	01:100 C 0C:1200 C	○	01-0C	×	01-0C
14	00	04	1	00-7F	Footswitch Mode	00:OFF 01:Rhythm 02:Glide 03:Rotary Speaker	○	00-7F	○	00-03
14	00	05	1	00-7F	Pitch	00:PitchDown 40:Normal 7F:PitchUp	○	00-7F	○	00-7F
14	00	06	1	00-7F	Footswitch Glide Time	00:FAST 7F:SLOW	○	00-7F	○	04-1C
14	00	08	1	00-7F	MIDI Control Expression (INT/EXT)	00:Internal 01:External	○	00-7F	×	-

Address			Size	Data	Parameter	Data	Receive	Rx Range	Transmit	Tx Range
hh	mm	ll								
14	00	09	1	00-7F	MIDI Control Lead 1 (INT/EXT)	00:Internal 01:External	○	00-7F	×	-
14	00	0A	3	00-05 00-07 00-0B	Registration Menu	00-05 00-07 00-0B	○	00-05 00-07 00-0B	○	00-05 00-07 00-0B

Effect Parameters (Overall): Reverb

Address			Size	Data	Parameter	Data	Receive	Rx Range	Transmit	Tx Range
hh	mm	ll								
14	01	00	1	00-7F	Reverb Depth	00:MIN 7F:MAX	○	00-7F	×	-
14	01	01	1	00-7F	Reverb Time (Panel)	00:FAST 7F:SLOW	○	00-7F	○	00-45
14	01	02	3	00 00-7F 00-7F	Reverb Type (Panel)	00 00-7F 00-7F	○	00 00-7F 00-7F	○	00 00-7F 00-7F

Effect Parameters (Overall): Rotary Speaker

Address			Size	Data	Parameter	Data	Receive	Rx Range	Transmit	Tx Range
hh	mm	ll								
14	03	00	1	00-7F	Rotary Speaker Speed (On/Off)	00:OFF 01:ON	○	00-7F	×	-
14	03	01	1	00-7F	Rotary Speaker Speed Control Mode	00:STOP 01:SLOW	○	00-7F	○	00-01
14	03	02	2	0000- 007F	Rotary Speaker Speed Control Speed	0000:SLOW 007F:FAST	○	0000-007F	○	0040-007F

*4. MDR

nn	Command	Receive	Transmit
01H	Play Start	○	×
02H	Play Stop	○	×
03H	Record Start	○	×
04H	Record Stop	○	×
05H	Fast Forward Start	○	×
06H	Fast Forward Stop	○	×
09H	Rhythm Pointer Reset	○	×

MIDI Implementation Chart

YAMAHA [Electone-EL mode] / Model: ELB-01

Date: 03-Mar-2005
Version: 1.00

Function	Transmitted	Recognized	Remarks
Basic Channel Default Changed	1, 2, 3, 16 (*1) 1-16	1-3, 5-16 (*2) 4	
Mode Default Messages Altered	Mode 3 × *****	Mode 3 × ×	
Note Number :True Voice	36-96 (*3) *****	0-127 (*4)	
Velocity Note on Note off	○ 9nH, v=1-127 × 9nH, v=0	○ 9nH, v=1-127 × 9nH, v=0 or 8nH	
After Touch Key's Ch's	× ○	○ (*5) ○	
Pitch Bend	○	○ (*5)	
Control Change 0, 32 1, 5, 7, 10 4 6, 38 11 96, 97 64-67 71-78 84, 91, 93, 94 98-99, 100-101	× × × × ○ (*6) × × × × × ×	○ (*5) ○ (*5) ○ (*6) ○ (*5) ○ (*5, 6) ○ (*5) ○ (*5) ○ (*5) ○ (*5) ○ (*5) ○ (*5)	Bank Select 2nd Expression Data Entry Expression Data Entry SW Sound Controller NRPN, RPN
Program Change :True number	○ (*9) *****	○ (*10)	
System Exclusive	○	○	
System Common :Song Position :Song Select :Tune	× × ×	× × ×	
System Real Time :Clock :Commands	○ ○	○ (*8) ○	(FAH, FCH)
Aux Messages :All Sound Off :Reset All Cntrls :Local On/Off :All Notes Off :Active Sense :Reset	× × × × ○ ×	○ (120) (*5) ○ (121) (*5) × ○ (123-127) (*5) ○ ×	
Notes	*1: 1ch: UK, 2ch: LK, 3ch: PEDAL, 16ch: CONTROL *2: 1ch: UK, 2ch: LK, 3ch: PEDAL, 4ch: LEAD1, 5-14ch: XG, 15ch: KEYBOARD PERCUSSION, 16ch: CONTROL *3: UK: 36-96, LK: 36-96, PEDAL: 36-60 *4: UK, LK, PEDAL, LEAD1: 36-96, XG: 0-127, PERCUSSION: 3-127 *5: XG only *6: CONTROL only *7: UK only *8: External Mode only *9: CONTROL: 0-15 *10: UK, LK, PEDAL, CONTROL: 0-15 XG: 0-127		

Mode 1 : OMNI ON, POLY
Mode 3 : OMNI OFF, POLY

Mode 2 : OMNI ON, MONO
Mode 4 : OMNI OFF, MONO

○ : Yes
× : No

10

Appendix

Function		Transmitted (*1)	Recognized	Remarks
Basic Channel	Default Changed	1, 2, 3, 16 1-16	1-16 1-16	
Mode	Default Messages Altered	Mode3 × *****	Mode 3 × ×	
Note Number	:True Voice	36-96 *****	0-127	
Velocity	Note on Note off	○ 9nH, v=1-127 × 9nH, v=0	○ 9nH, v=1-127 × 9nH, v=0 or 8nH	
After Touch	Key's Ch's	× ○	○ ○	
Pitch Bend		×	○	
Control Change	0, 32 1, 5, 7, 10 4 6, 38 11 96, 97 64-67 71-78 84, 91, 93, 94 98-99, 100-101	× × × × ○ × × × × × ×	○ ○ × ○ ○ ○ ○ ○ ○ ○ ○	Bank Select 2nd Expression Data Entry Expression Data Entry SW Sound Controller NRPN, RPN
Program Change	:True number	○ 0-15 *****	○	
System Exclusive		○	○	
System Common	:Song Position :Song Select :Tune	× × ×	× × ×	
System Real Time	:Clock :Commands	○ ○	× ×	
Aux Messages	:All Sound Off :Reset All Cntrls :Local On/Off :All Notes Off :Active Sense :Reset	× × × × ○ ×	○ (120) ○ (121) × ○ (123-127) ○ ×	
Notes	*1; Same as that in the EL mode			

Mode 1 : OMNI ON, POLY
Mode 3 : OMNI OFF, POLY

Mode 2 : OMNI ON, MONO
Mode 4 : OMNI OFF, MONO

○ : Yes
× : No

Troubleshooting

Problem	Possible Cause and Solution
GENERAL OPERATION	
The sound is not heard for about 10 seconds after turning the power on.	This is normal; the Electone takes a while to start up.
A cracking noise is sometimes heard.	Noise may be produced when either an electrical appliance is turned on or an electric power tool (such as drill) is used in the proximity of the Electone. If this occurs, plug the Electone into an electrical outlet located as far as possible from the device that seems to be the source of the problem.
Interference from radio, TV, or other sources occurs.	This is caused by the proximity of a high-power broadcasting station, an amateur ham radio setup or a mobile phone.
The sound of the Electone causes surrounding objects to resonate.	Because the Electone is capable of producing powerful bass sounds, resonance may be caused in surrounding objects, such as cabinets or glass windows. To avoid this, relocate the objects or lower the Electone's volume.
Some of the LEDs in the DISPLAY SELECT section do not light.	The lamps above the [RHYTHM SEQUENCE] button and the [SUSTAIN] button will light up when the function is turned on in the display.
The sound is too small even when the volume is set to its maximum.	<ul style="list-style-type: none"> The MASTER VOLUME dial may be set around the minimum position. Turn it clockwise. The Expression Pedal may not be pressed down. Press it down with your toe.
The Electone panel does not function normally or the content of the memorized data has changed.	This happens very rarely. Occasionally, power surges and spikes due to electrical storms or other reasons may cause the Electone to malfunction and/or alter the contents of memorized data. If this happens, perform the Factory Set operation to reset the Electone (page 20).
VOICES/RHYTHMS	
When a key is pressed, two or more Voices sound.	Perhaps the Voice of the Voice section 2 sounds as for the Lower Keyboard or Pedalboard. Turn off the Voice of the Voice section 2 in the Voice display, or set the volume setting to minimum after switching to the Voice section 2 (page 29). As for the Upper Keyboard, the Lead Voice may sound in addition to the Voice of the Voice section 2. Turn off the Lead Voice in the Voice display after switching to the Voice section 2.
The pitch may sound excessively high on the Pedalboard and low in the higher registers of the Lower and Upper keyboards.	This may occur when you compare the Electone's sounds with that of a piano. Because of the difference of the harmonics structure, the tuning system of the Electone is different from the piano in the higher and lower ranges.
Some of the Voices may contain cracking and/or noisy sounds.	You may find these mainly in the wind instrument Voices. These are purposely added effects to the Voices to reproduce the characteristics of the wind instruments such as the pipe vibrations, breath noises and squeaks.
When too many keys are pressed, not all of the notes sound.	Total polyphonic capacity (notes sounding for both Upper and Lower Keyboards) is 10 notes.
Only one sound is heard when two notes of the Lead or Pedal Voices are simultaneously played.	For practical performance reasons, the Electone has been designed so that only one note of the Lead or Pedal Voices can be played at a time.
The Pedal Voices do not sound, even though the volume is properly set.	<ul style="list-style-type: none"> The Single Finger or Fingered Chord mode of Auto Bass Chord is on. Turn off the mode in the display (page 71). TO LOWER buttons in the Pedal Voice sections are turned on. Turn the function off (page 31).
When keys are pressed, the sounds of percussion instruments are also heard.	The Keyboard Percussion function has been turned on. When not using the function, be sure to turn it off (page 77).
Even though a User button's rhythm has been selected and started, the pattern does not sound.	Since the User buttons contain User rhythms, no rhythm will sound if a pattern has not been saved to the selected User button.

Problem	Possible Cause and Solution
EFFECTS	
The Initial Touch function does not operate.	Adjust the Initial Touch settings in the Voice Condition display (page 42).
The Reverb effect is not applied to the desired Voice sections, even when the Reverb setting in the Voice Condition display Page 1 set to maximum.	Increase the Reverb depth for the desired Voice sections in Reverb display.
The Rotary Speaker effect cannot be heard, even when the [ROTARY SP SPEED] button in the DISPLAY SELECT section is on.	Rotary Speaker must be selected first in Voice Condition display.
ACCOMPANIMENT	
The pitch in the Single Finger mode does not change, even when pressing different keys of the keyboard.	Single Finger mode will only produce notes when played within a fixed octave interval on the Lower keyboard. If notes with the same letter name are pressed outside of that range, the chords that are sounded will share the same pitch.
While an Intro/Ending pattern is automatically playing, the Lower keyboard does not produce any sound, even when the keys are played.	Since the Accompaniment chords play automatically one after another, the Lower keyboard is designed not to produce any sound during the playback of an Intro/Ending pattern.
The Accompaniment cannot be heard even when an appropriate Accompaniment type is selected and the rhythm has been started.	<ul style="list-style-type: none"> • The Accompaniment volume may have been set to 0. Be sure to raise the Accompaniment volume in the Rhythm Condition display (page 70). • All Accompaniment parts may be set to off (mute). Set the desired part on (page 68).
The harmony notes of the Melody On Chord function cannot be heard.	The Upper keyboard has been set to sound only Lead Voices. Increase the volume of the Upper Keyboard Voices.
REGISTRATION MEMORY	
Certain functions have not been memorized to Registration Memory.	Some functions cannot be memorized. Refer to page 98.
MUSIC DATA RECORDER	
Recording or playback cannot be performed.	<ul style="list-style-type: none"> • The part buttons may have been turned off. Turn the desired part to REC or PLAY. • The performance data is too large. The maximum limit for recording performance data is 1 MB. • The media is write-protected. Cancel the write-protect. • The media/folder may contain EL-format songs. You cannot record to the media/folder that contains EL-format songs. Create a new folder and record the song to it.
Recording is stopped before the performance is finished.	<ul style="list-style-type: none"> • The amount of recorded data on the media is close to the maximum limit. Either use another media or delete the data of unnecessary songs. • When you overwrite the song, the length of a subsequently recorded part cannot exceed the length of the previously recorded parts. Delete the previously recorded song, then record again (page 121). • The performance data is too large. The maximum limit for recording performance data is 1 MB.
An error message appears while entering a folder name or song name.	<ul style="list-style-type: none"> • The song/folder name is too long. The capacity is 50 characters. • The song/folder name may be an invalid name. Refer to page 124. • The path name is too long. The capacity of the path name is 234 characters. Reduce the layer or shorten the song/folder name to shorten the path.
The rhythm does not start at the beginning of a recording, or stops in the middle of the performance.	The M.D.R. is designed so that the rhythm cannot be started at the very beginning of a recording. If you wish to use the rhythm, start it after the time indicator appears in the display.
The floppy disk cannot be formatted when you want to format an unformatted disk.	Recognizing an unformatted disk takes a few seconds after it is inserted. Wait about 30 seconds, then try to format again.
The notes of the recording are “stuck” and sound continuously.	During playback, you may have removed the USB flash memory or floppy disk. Whenever you wish to stop playback, always press the [STOP] button before removing the media.

Specifications

		Electone STAGEA ELB-01	
TONE GENERATION		AWM (2)	
KEYBOARD		Upper: 49 (C – C)/Lower: 49 (C – C)/Pedal: 20 (C – G)	
	Keyboard Type	Basic	
	Initial Touch	Upper, Lower	
REGISTRATION	Registration Memory	M. (Memory) 1 – 8 (9 – 16), D. (Disable)	
	Basic Registration	16	
	Registration Menu	240 + 90	
VOICE	Voice Sections	Upper: 2, Lead: 1, Lower: 2, Pedal: 2	
	Voice Buttons	Upper/Lower	STRINGS, BRASS, WOODWIND, TUTTI, PAD, SYNTH, PIANO, ORGAN, PERCUSSION, GUITAR, CHOIR, WORLD, USER 1, USER 2
		Lead	VIOLIN, SYNTH, FLUTE, TRUMPET, USER 1, TO LOWER
		Pedal	CONTRABASS, ELEC. BASS, TIMPANI, SYNTH BASS, USER 1, TO LOWER
	Preset Voice	245	
EFFECT/CONDITION	Sustain	Upper, Lower, Pedal	
	Reverb	25	
	Effects	Reverb, Delay, Karaoke, Chorus, Flanger, Phaser, Tremolo/Auto Pan, Rotary Speaker, Distortion, Wah, Dynamic, EQ/Enhancer, Thru	
RHYTHM	Preset Rhythm Pattern	133	
	Rhythm Buttons	MARCH, WALTZ, SWING & JAZZ, POPS, R&B, LATIN, WORLD MUSIC, BALLAD, ROCK, DANCE, USER 1, USER 2	
	Parts	Main Drum, Add Drum	
	Sections	Intro 1 – 3, Ending 1 – 3, Main/Fill In A – D, Break, Auto Fill	
ACCOMPANIMENT	Accompaniment Parts	Chord 1, Chord 2, Pad, Phrase1, Phrase 2	
	Auto Bass Chord	OFF, Single Finger, Fingered Chord, Custom A.B.C. Memory: Lower, Pedal	
	Melody On Chord	✓	
KEYBOARD PERCUSSION	Settings	Preset 1, 2, User 1 – 8	
	Kits	Wonderland Kit, EL, Standard Kit 1, 2, Hit, Room, Rock, Electro, Analog, Jazz, Brush, Symphony, SFX1, 2, Arabic	
	Assign	✓	
CONTROLS	Footswitch Left	Rhythm: Stop, Break, Main A – D, Intro 1 – 3, Ending 1 – 3 Glide: Upper 1, 2, Lower 1, 2, Lead 1, Glide Time Rotary Speaker Speed	
	Registration Shift	Shift, Jump, User (80)	
	Expression Pedal	✓	
	Transpose	-6 – +6	
	Pitch	A = 427.2 – 452.6 Hz	
	MIDI Control	✓	
	Main Controls	POWER on/off, MASTER VOLUME	
	M.D.R.	<ul style="list-style-type: none"> • Stop, Play, Custom Play, Rec, Pause, Fast Forward, Rewind • Tempo (50 – 200%), Repeat Setting, Change Song Name, Remaining Memory, Format, Song Copy, Song/folder Delete, Convert ELB→EL, Convert EL→ELB, Convert To XG, Registration Load/Save/Delete, Create folder 	
	Utility	Language (English/Japanese), Version	
	Display Select	VOICE DISPLAY, A.B.C./M.O.C., FOOTSWITCH, UTILITY, RHYTHM SEQUENCE, SUSTAIN, REVERB, ROTARY SP SPEED	
SOUND SYSTEM	Power Amplifiers	60 W (Stereo)	
	Speakers	16 cm x 2, 5 cm x 2	
OTHERS	LCD Display	20 x 2 Character	
	Storage	USB x 2	
	Connectors	PHONES, AUX OUT: L/R, MIDI IN/OUT, USB TO HOST, USB TO DEVICE: A, B	
	Power Consumption	64 W	
	Dimensions, Weight	1112.3 (W) x 485.8 (D) x 936 (H) mm, 1123.9 (W) mm (with Music Rest), 55 kg	
	Bench	596 (W) x 296 (D) x 580 (H) mm, 6.2 kg	

Specifications and descriptions in this owner's manual are for information purposes only. Yamaha Corp. reserves the right to change or modify products or specifications at any time without prior notice. Since specifications, equipment or options may not be the same in every locale, please check with your Yamaha dealer.

Index

A

[A] – [D] buttons	17
A.B.C.....	71
A.B.C./M.O.C.....	71
Accompaniment.....	68
Add Drum	68
Auto Bass Chord.....	71
Auto Fill	60
AUX OUT (L/R).....	151
AWM Voice	8

B

BAR/BEAT	61
BREAK	58

C

Changing the Song/Folder Name	122
Channel Messages	159
Chord 1	69
Chord 2	69
CHORUS (Effect)	45, 53
Control Change.....	159
Convert EL -> ELB	142
Convert ELB -> EL	141
Convert to XG	144
Custom A.B.C.	72

D

[D.] (Disable)	99
DATA CONTROL dial.....	11, 17
DELAY (Effect).....	45, 52
Delay (Vibrato).....	44
Delete (Registration Shift).....	105
Delete (Song/Folder).....	139
Depth (Reverb).....	48
Depth (Vibrato).....	44
Display Select (Panel).....	11
DISTORTION.....	45, 54
DYNAMIC.....	45, 55

E

Effect.....	45
Effect Category (Voice).....	45
Effect List	52
Effect Parameters	46, 52
Effect Type (Voice)	46
ENDING	58
EQ/ENHANCER	45, 55
Expression Pedal	162
Expression pedal	13

F

Factory Set.....	20
Fast Forward	134

Feet.....	42
File.....	116
FILL IN	58
Fingered Chord	72
FLANGER	45, 53
floppy disk	107
Folder	113, 116
Folder Delete	139
Folder Name	122
FOOTSWITCH	102, 146
Footswitch (Left).....	146
Footswitch (Right).....	102
Format (M.D.R.)	109

G

Glide.....	148
------------	-----

H

Headphones.....	153
-----------------	-----

I

Icons.....	116
Index.....	183
indicator.....	17
Initial Touch	42
Initialize (Factory set)	20
Initialize (Registration Memory)	100
Internal/External (MIDI).....	161
INTRO.....	58

J

Jacks and Controls.....	151
Jump.....	103

K

KARAOKE.....	45, 52
Keyboard Percussion	77

L

Language	19
LCD display	17
Lead Voice	21
LEAD VOICE (Panel)	10
Lower Keyboard Voice	22
LOWER KEYBOARD VOICE 1/2 (Panel)	10

M

[M.] (Memory).....	98
M.D.R.....	107
M.O.C.	74
MAIN.....	58
Main Drum	68
MAIN/FILL IN	60
MASTER VOLUME.....	13

Melody On Chord	74
Memory (A.B.C.)	73
Metronome	67
MIDI	157
MIDI Control	161
MIDI IN/OUT	152, 157
MIDI Out	162
Mode (Rotary Speaker)	50
Music Data Recorder (MDR)	107

N

Next (Shift End)	106
Next Regist	129

P

Pad	69
PAGE buttons	18
PAGE Buttons (Panel)	11
Panning	43
Part (M.D.R.)	119
Part (Rhythm)	68
Pause	134
Pedal Voice	22
PEDAL VOICE 1/2 (Panel)	10
PHASER	45, 53
PHONES	151
Phrase 1	69
Phrase 2	69
Pitch	150
Pitch (Voice section)	43
Playback	133
POWER	12
PRESET (Effect)	45
Preset (Vibrato)	44
Preset Keyboard Percussion	77
Program Change	159
Protected Song	139
Punch-in Recording	121

R

Recording	117
Recording (Each Part)	118
Registration Memory	97
Registration Menu	14
Registration Menu List	15
Registration Shift	102
Rename	122
Repeat	135
REVERB	48
Reverb	42
Reverb (Accompaniment)	70
REVERB (Effect)	52
Reverb (Rhythm)	62
Reverb (Voice condition)	45
Rewind	134
Rhythm	56
Rhythm buttons	56
Rhythm Condition	62
RHYTHM CONTROL (Panel)	10
Rhythm List	67

Rhythm Menu	56
Rhythm Sequence	75
ROTARY SP SPEED	50
ROTARY SPEAKER	45, 54
Rotary Speaker	50

S

section	58
Shift (Registration Shift)	103
Shift End	106
Single Finger	72
Slide	47
Song	111, 116
Song Copy	137
Song Delete	139
Song Name	122
Specifications	182
Speed (Rotary Speaker)	50
Speed (Vibrato)	44
START	57
Stop (Shift End)	106
Style File Format	5
Sustain	49
SYNCHRO START	59
System Exclusive Messages	159

T

Tempo (Rhythm)	61
THRU	45, 55
To Lower	31
Top (Shift End)	106
Touch (Initial touch)	42
Transpose	150
Transpose (Voice section)	43
TREMOLO/AUTO PAN	45, 53
Tune (Voice section)	43

U

UD-FD01	167
Upper Keyboard Voice	21
UPPER KEYBOARD VOICE 1/2 (Panel)	10
USB TO DEVICE A	151
USB TO DEVICE B	152
USB TO HOST	152
User (Registration Shift)	103
User (Vibrato)	44
User button (Rhythm)	63
User button (Voice)	32
User Keyboard Percussion	88
UTILITY	150

V

Version	20
Vibrato	44
Voice (Voice section 2)	29
Voice buttons	25
Voice Condition display	27, 41
Voice Display	23
Voice Menu	25

VOICE SECTION.....	25
Voice section 1	25
Voices	21
Volume (Accompaniment)	70
Volume (Keyboard Percussion)	78
Volume (Rhythm)	57, 62
Volume (Voice).....	26, 42
Volume (XG).....	136

W

WAH.....	45, 54
----------	--------

X

XG	5
----------	---

Memo

For details of products, please contact your nearest Yamaha representative or the authorized distributor listed below.

Pour plus de détails sur les produits, veuillez-vous adresser à Yamaha ou au distributeur le plus proche de vous figurant dans la liste suivante.

Die Einzelheiten zu Produkten sind bei Ihrer unten aufgeführten Niederlassung und bei Yamaha Vertragshändlern in den jeweiligen Bestimmungsländern erhältlich.

Para detalles sobre productos, contacte su tienda Yamaha más cercana o el distribuidor autorizado que se lista debajo.

NORTH AMERICA

CANADA

Yamaha Canada Music Ltd.
135 Milner Avenue, Scarborough, Ontario,
M1S 3R1, Canada
Tel: 416-298-1311

U.S.A.

Yamaha Corporation of America
6600 Orangethorpe Ave., Buena Park, Calif. 90620,
U.S.A.
Tel: 714-522-9011

CENTRAL & SOUTH AMERICA

MEXICO

Yamaha de México S.A. de C.V.
Calz. Javier Rojo Gómez #1149,
Col. Guadalupe del Moral
C.P. 09300, México, D.F., México
Tel: 55-5804-0600

BRAZIL

Yamaha Musical do Brasil Ltda.
Rua Joaquim Floriano, 913 - 4º andar, Itaim Bibi,
CEP 04534-013 Sao Paulo, SP. BRAZIL
Tel: 011-3704-1377

ARGENTINA

Yamaha Music Latin America, S.A.
Sucursal de Argentina
Olga Cossetini 1553, Piso 4 Norte
Madero Este-C1107CEK
Buenos Aires, Argentina
Tel: 011-4119-7000

PANAMA AND OTHER LATIN AMERICAN COUNTRIES/ CARIBBEAN COUNTRIES

Yamaha Music Latin America, S.A.
Torre Banco General, Piso 7, Urbanización Marbella,
Calle 47 y Aquilino de la Guardia,
Ciudad de Panamá, Panamá
Tel: +507-269-5311

EUROPE

THE UNITED KINGDOM

Yamaha Music U.K. Ltd.
Sherbourne Drive, Tilbrook, Milton Keynes,
MK7 8BL, England
Tel: 01908-366700

IRELAND

Danfay Ltd.
61D, Sallynoggin Road, Dun Laoghaire, Co. Dublin
Tel: 01-2859177

GERMANY

Yamaha Music Central Europe GmbH
Siemensstraße 22-34, 25462 Rellingen, Germany
Tel: 04101-3030

SWITZERLAND/LIECHTENSTEIN

Yamaha Music Central Europe GmbH,
Branch Switzerland
Seefeldstrasse 94, 8008 Zürich, Switzerland
Tel: 01-383 3990

AUSTRIA

Yamaha Music Central Europe GmbH,
Branch Austria
Schleiergasse 20, A-1100 Wien, Austria
Tel: 01-60203900

CZECH REPUBLIC/SLOVAKIA/ HUNGARY/SLOVENIA

Yamaha Music Central Europe GmbH,
Branch Austria, CEE Department
Schleiergasse 20, A-1100 Wien, Austria
Tel: 01-602039025

POLAND

Yamaha Music Central Europe GmbH
Sp.z o.o. Oddział w Polsce
ul. 17 Stycznia 56, PL-02-146 Warszawa, Poland
Tel: 022-868-07-57

THE NETHERLANDS/ BELGIUM/LUXEMBOURG

Yamaha Music Central Europe GmbH,
Branch Benelux
Clarissenhof 5-b, 4133 AB Vianen, The Netherlands
Tel: 0347-358 040

FRANCE

Yamaha Musique France
BP 70-77312 Marne-la-Vallée Cedex 2, France
Tel: 01-64-61-4000

ITALY

Yamaha Musica Italia S.P.A.
Viale Italia 88, 20020 Lainate (Milano), Italy
Tel: 02-935-771

SPAIN/PORTUGAL

Yamaha Música Ibérica, S.A.
Ctra. de la Coruna km. 17, 200, 28230
Las Rozas (Madrid), Spain
Tel: 91-639-8888

GREECE

Philippos Nakas S.A. The Music House
147 Skiathou Street, 112-55 Athens, Greece
Tel: 01-228 2160

SWEDEN

Yamaha Scandinavia AB
J. A. Wettergrens Gata 1, Box 30053
S-400 43 Göteborg, Sweden
Tel: 031 89 34 00

DENMARK

YS Copenhagen Liaison Office
Generatorvej 6A, DK-2730 Herlev, Denmark
Tel: 44 92 49 00

FINLAND

F-Musiikki Oy
Kluuvikatu 6, P.O. Box 260,
SF-00101 Helsinki, Finland
Tel: 09 618511

NORWAY

Norsk filial av Yamaha Scandinavia AB
Grini Næringspark 1, N-1345 Østerås, Norway
Tel: 67 16 77 70

ICELAND

Skifan HF
Skeifan 17 P.O. Box 8120, IS-128 Reykjavik, Iceland
Tel: 525 5000

RUSSIA

Yamaha Music (Russia)
Office 4015, entrance 2, 21/5 Kuznetskii
Most street, Moscow, 107996, Russia
Tel: 495 626 0660

OTHER EUROPEAN COUNTRIES

Yamaha Music Central Europe GmbH
Siemensstraße 22-34, 25462 Rellingen, Germany
Tel: +49-4101-3030

AFRICA

Yamaha Corporation,
Asia-Pacific Music Marketing Group
Nakazawa-cho 10-1, Naka-ku, Hamamatsu,
Japan 430-8650
Tel: +81-53-460-2312

MIDDLE EAST

TURKEY/CYPRUS

Yamaha Music Central Europe GmbH
Siemensstraße 22-34, 25462 Rellingen, Germany
Tel: 04101-3030

OTHER COUNTRIES

Yamaha Music Gulf FZE
LOB 16-513, P.O.Box 17328, Jubel Ali,
Dubai, United Arab Emirates
Tel: +971-4-881-5868

ASIA

THE PEOPLE'S REPUBLIC OF CHINA

Yamaha Music & Electronics (China) Co.,Ltd.
25/F., United Plaza, 1468 Nanjing Road (West),
Jingan, Shanghai, China
Tel: 021-6247-2211

HONG KONG

Tom Lee Music Co., Ltd.
11/F., Silvercord Tower 1, 30 Canton Road,
Tsimshatsui, Kowloon, Hong Kong
Tel: 2737-7688

INDONESIA

PT. Yamaha Music Indonesia (Distributor)
PT. Nusantik
Gedung Yamaha Music Center, Jalan Jend. Gatot
Subroto Kav. 4, Jakarta 12930, Indonesia
Tel: 21-520-2577

KOREA

Yamaha Music Korea Ltd.
8F, 9F, Dongsung Bldg. 158-9 Samsung-Dong,
Kangnam-Gu, Seoul, Korea
Tel: 080-004-0022

MALAYSIA

Yamaha Music Malaysia, Sdn., Bhd.
Lot 8, Jalan Perbandaran, 47301 Kelana Jaya,
Petaling Jaya, Selangor, Malaysia
Tel: 3-78030900

PHILIPPINES

Yupangco Music Corporation
339 Gil J. Puyat Avenue, P.O. Box 885 MCPO,
Makati, Metro Manila, Philippines
Tel: 819-7551

SINGAPORE

Yamaha Music Asia Pte., Ltd.
#03-11 A-Z Building
140 Paya Lebar Road, Singapore 409015
Tel: 747-4374

TAIWAN

Yamaha KHS Music Co., Ltd.
3F, #6, Sec.2, Nan Jing E. Rd. Taipei.
Taiwan 104, R.O.C.
Tel: 02-2511-8688

THAILAND

Siam Music Yamaha Co., Ltd.
89/1 Siam Motors Building, 15-16 floor
Rama 1 road, Wangmai, Pathumwan
Bangkok 10330, Thailand
Tel: 02-215-2626

OTHER ASIAN COUNTRIES

Yamaha Corporation,
Asia-Pacific Music Marketing Group
Nakazawa-cho 10-1, Naka-ku, Hamamatsu,
Japan 430-8650
Tel: +81-53-460-2317

OCEANIA

AUSTRALIA

Yamaha Music Australia Pty. Ltd.
Level 1, 99 Queensbridge Street, Southbank,
Victoria 3006, Australia
Tel: 3-9693-5111

NEW ZEALAND

Music Houses of N.Z. Ltd.
146/148 Captain Springs Road, Te Papapa,
Auckland, New Zealand
Tel: 9-634-0099

COUNTRIES AND TRUST TERRITORIES IN PACIFIC OCEAN

Yamaha Corporation,
Asia-Pacific Music Marketing Group
Nakazawa-cho 10-1, Naka-ku, Hamamatsu,
Japan 430-8650
Tel: +81-53-460-2312

HEAD OFFICE Yamaha Corporation, Pro Audio & Digital Musical Instrument Division
Nakazawa-cho 10-1, Naka-ku, Hamamatsu, Japan 430-8650
Tel: +81-53-460-3273



Yamaha Manual Library
<http://www.yamaha.co.jp/manual/>

U.R.G., Pro Audio & Digital Musical Instrument Division, Yamaha Corporation
© 2005 Yamaha Corporation
WF12580 804MWAP3.3-03C0
Printed in China