



YAMAHA

Clavinova

CVP-98
CVP-96
CVP-600

Reference Manual
Referenzanleitung
Manuel de référence
Manual de referencia

Table of Contents (English)

| | |
|-----------------------------------|----|
| Messages | 2 |
| Troubleshooting | 6 |
| MIDI and Data Compatibility | 8 |
| MIDI Data Format | 9 |
| MIDI Implementation Chart | 25 |
| Voice List | 26 |
| Drum/key Assignment List | 32 |
| Style List | 34 |
| Parameter Chart | 35 |
| Fingering Chart | 36 |
| Specifications | 37 |
| CVP-600: Assembly | 38 |
| CVP-98/96: Assembly | 46 |

Inhalt (Deutsch)

| | |
|--|----|
| Displaymeldungen | 2 |
| Fehlersuche | 6 |
| MIDI und Datenkompatibilität | 8 |
| MIDI-Datenformat | 9 |
| MIDI-Implementierungstabelle | 25 |
| Stimmenverzeichnis | 26 |
| Verzeichnis der Schlagzeugklänge | 32 |
| Style-Verzeichnis | 34 |
| Parameterübersicht | 35 |
| Akkordliste | 36 |
| Technische Daten | 37 |
| CVP-600: Zusammenbau | 38 |
| CVP-98/96: Zusammenbau | 46 |

Table des matières (Français)











| | |
|---|----|
| Messages | 2 |
| Dépistage des pannes | 6 |
| MIDI et la compatibilité des données | 8 |
| Format des données MIDI | 9 |
| Feuille d'implantation MIDI | 25 |
| Liste des voix | 26 |
| Liste d'assignation instrument de batterie/touche du clavier | 32 |
| Liste des styles | 34 |
| Tableau des paramètres | 35 |
| Tablature | 36 |
| Spécifications | 37 |
| CVP-600: Montage | 38 |
| CVP-98/96: Montage | 46 |

Índice (Español)









| | |
|---|----|
| Mensajes | 2 |
| Localización y reparación de averías | 6 |
| MIDI y compatibilidad de datos | 8 |
| Formato de datos MIDI | 9 |
| Gráfico de puesta en práctica de MIDI | 25 |
| Lista de voces | 26 |
| Lista de asignaciones de teclas/batería | 32 |
| Lista de estilos | 34 |
| Gráfica de parámetros | 35 |
| Gráfica de digitado | 36 |
| Especificaciones | 37 |
| CVP-600: Montaje | 38 |
| CVP-98/96: Montaje | 46 |

Messages



● Common Messages



| | |
|---|--|
|  No disk ! | <p>This prompt appears when there is no disk in the disk drive.</p> <p>➤ Put the proper disk in the drive and attempt the operation again.</p> |
|  No songs ! | <p>When renaming the original song or converting the data this prompt will warn you in the event that there is no song data.</p> <p>➤ Select a data-containing song, or insert a disk with song data into the floppy disk drive.</p> |
|  No file ! | <p>This message appears if there is no Registration Memory, Micro Tuning, or related data on the currently inserted disk when you attempt a file-related operation.</p> <p>➤ Create a file or insert a disk with a proper file.</p> |
|  Start disk format ? <input type="button" value="OK"/> <input type="button" value="CANCEL"/> | <p>This message appears when a new disk or a non-Clavinova formatted disk has been inserted into the disk drive. (See page 106 in the Owner's Manual.)</p> <p>➤ Press OK if you want to format the disk. Press CANCEL if you want to abort the formatting process.</p> |
|  Protected disk ! | <p>This message appears when you attempt to record or perform other file operations to a disk whose write-protect tab is set to "write protect."</p> <p>➤ Set the write-protect tab to the recordable position (page 7 in the Owner's Manual) then try the operation again. If the operation still cannot be performed, the disk itself has internal write protection, making it impossible to perform recording or file operations on the disk.</p> |
|  Protected songs ! | <p>This message appears when you attempt to record over parts or perform other operations on files that are incompatible or do not allow such operations. Depending on the file type, operations such as additional recording, copying, deleting, etc. may not be possible on the CVP-98/96/600.</p> |
|  Disk read/write error ! <input type="button" value="OK"/> | <p>An error occurred while writing to (as in recording or storing files) or reading from the disk.</p> <p>➤ Try the operation again after pressing the OK button. If the error occurs a second time, the disk or the disk drive unit may be faulty. If you suspect the drive to be at fault, refer the problem to your Yamaha dealer.</p> |
|  Completed ! | <p>This appears for a few seconds when a time consuming operation such as format, song copy, etc. is finished.</p> |
|  Don't remove the disk ! | <p>This message appears when data is being transferred between the Clavinova and the disk.</p> <p>➤ The message disappears automatically when the operation is finished.</p> |
|  Are you sure ? <input type="button" value="YES"/> <input type="button" value="NO"/> | <p>When operations such as Song Delete or Format are selected, this prompts you to confirm whether you want to go ahead with the operation or not.</p> <p>➤ Press YES to execute the operation. Press NO to return to the previous display.</p> |
|  Disk full ! <input type="button" value="OK"/> | <p>The currently loaded disk is full and cannot hold any more data.</p> <p>➤ Press the OK button, then delete any unnecessary data in the disk (page 138 in the Owner's Manual), or use a disk that has more available space. If this appears during song recording, recording will stop and recorded data up to that point will be saved automatically.</p> |

Messages











| | |
|---|--|
|  Too many files ! <input type="button" value="OK"/> | <p>A 2DD and a 2HD disk can hold up to 60 song files each. A 2DD disk can hold about 110 files (of various types), and a 2HD disk can hold up to about 220 files. This message appears when you try to produce more files than the disk is capable of storing.</p> <p>➤ Press the OK button, then delete any unnecessary files in the disk (page 138 in the Owner's Manual), or use a disk that has more available space.</p> |
|  Same name ! Overwrite ? <input type="button" value="OK"/> <input type="button" value="CANCEL"/> | <p>A file with the same name exists.</p> <p>➤ Press the OK button if you wish to overwrite the original file with new data, or press CANCEL to abort the operation.</p> |
|  This button can't be used during recording or playback ! | <p>This message appears when you try to perform operations which cannot be done during recording or playback, such as data conversion, etc.</p> <p>➤ Stop song recording or playback, or exit from the recording/playback mode, then perform the operation again.</p> |
|  This button can't be used during playback ! | <p>This appears when you try to execute operations that cannot be performed during playback, such as changing the number of repeats of the Guide function.</p> <p>➤ Stop song playback, or exit from the playback mode, then perform the operation again.</p> |
|  Button not valid ! | <p>A button that does not have a function in the current mode has been pressed.</p> |
|  Disk read/write operation in process ! | <p>This message appears when you try to execute other operations while reading data from the disk or saving data.</p> <p>➤ Wait until the data read/write operation is completed, then perform the operation again.</p> |
|  Memory write operation in process ! | <p>This message appears when you attempt to execute another operation while writing edited data of a song recorded to internal RAM.</p> <p>➤ Complete the data write operation, then perform the other operation.</p> |
|  Delete CVP MEMORY ? <input type="button" value="YES"/> <input type="button" value="NO"/> | <p>This message appears when executing an operation that results in deleting data recorded to the internal RAM, such as playback of disk software.</p> <p>➤ Press YES to delete the data recorded to the internal RAM, then perform the desired operation. Press the NO button if you want to keep the data.</p> |
|  Convert to CVP songs ? <input type="button" value="YES"/> <input type="button" value="NO"/> | <p>This message appears when you attempt to record over or edit data of commercially available software or data recorded on Clavinovas other than the CVP-94/92/98/96/600.</p> <p>➤ Press YES to convert the data for recording/editing on the CVP-94/92/98/96/600. Press NO if you don't want to convert the data.</p> |

● Song Copy Related Messages

| | |
|---|--|
|  Number of disk exchange (1) <input type="button" value="OK"/> <input type="button" value="CANCEL"/> | <p>This message informs you of the number of times the disks must be exchanged when copying a song to a different disk before starting the song copy operation. (See page 137 in the Owner's Manual.)</p> |
|  Insert Disk 2. (1 / 3) <input type="button" value="CANCEL"/> | <p>Insert the destination disk to be copied. (See page 137 in the Owner's Manual.)</p> |
|  Please select destination song number. SONG 1 [v] <input type="button" value="OK"/> <input type="button" value="CANCEL"/> | <p>When copying a song from the source disk to another disk, this message prompts you to specify the song number in the destination disk to which the song is to be copied, when the disk is first inserted. (See page 137 in the Owner's Manual.)</p> |

| | |
|--|--|
|  Insert Disk 1. (2/ 3) <div style="text-align: right;"><input type="button" value="CANCEL"/></div> | <p>This message prompts you to insert the source disk when copying songs to a second disk. (See page 137 in the Owner's Manual.)</p> |
|  Select a different number ! | <p>This appears when the same song number is selected for both source and destination in the song copy operation.</p> <p>➤ Change the destination song number.</p> |

● Custom Style Related Messages

| | |
|--|---|
|  CUSTOM STYLE Please select a source style. | <p>This message appears for a few seconds when the Custom Style mode is engaged. (See page 68 in the Owner's Manual.)</p> |
|  Clear style ? <div style="text-align: right;"><input type="button" value="OK"/> <input type="button" value="CANCEL"/></div> | <p>This confirmation prompt appears when you attempt to change the beat parameter in the Custom Style mode. (See page 70 in the Owner's Manual.)</p> |
|  Clear section ? <div style="text-align: right;"><input type="button" value="OK"/> <input type="button" value="CANCEL"/></div> | <p>This confirmation prompt appears when you attempt to change the number of measures in the Custom Style mode. (See page 70 in the Owner's Manual.)</p> |
|  Clear part ? <div style="text-align: right;"><input type="button" value="OK"/> <input type="button" value="CANCEL"/></div> | <p>This confirmation prompt appears when you attempt to perform operations which can only be done after deleting the part of the original style in the Custom Style mode. (See page 71 in the Owner's Manual.)</p> |
|  Store Bossa NovaX ? <div style="border: 1px solid black; padding: 2px; margin-bottom: 5px;"> MEMORY No. 1 (TEMP. STYLE) </div> <div style="text-align: right;"><input type="button" value="OK"/> <input type="button" value="CANCEL"/></div> | <p>This confirmation prompt appears when you attempt a store operation in the Custom Style mode. (See page 74 in the Owner's Manual.)</p> <p>This also appears when you attempt to change styles before storing. (See page 79 in the Owner's Manual.)</p> |
|  Store Bossa NovaX ? <div style="border: 1px solid black; padding: 2px; margin-bottom: 5px;"> MEMORY No. 1 (TEMP. STYLE) </div> <div style="text-align: right;"><input type="button" value="YES"/> <input type="button" value="NO"/> <input type="button" value="CANCEL"/></div> | <p>This confirmation prompt appears when you attempt to exit from the Custom Style mode before storing data. (See page 79 in the Owner's Manual.)</p> <p>➤ Select YES to store. Press NO to exit without storing data. Press CANCEL to return to the previous display without storing data. (See page 79 in the Owner's Manual.)</p> |
|  Can't recall ! <div style="text-align: right;"><input type="button" value="OK"/></div> | <p>This message appears when the Recall Section operation in the Custom Style mode cannot be performed, due to changes in the time signature (beat). (See page 74 in the Owner's Manual.)</p> |
|  Please store to memory before saving to disk <div style="text-align: right;"><input type="button" value="OK"/></div> | <p>If the data has not been stored to memory before saving to disk in the Custom Style mode, this message prompts you to store the data before proceeding. (See page 76 in the Owner's Manual.)</p> |
|  Not enough memory ! Please delete an unneeded style or simplify the current style. <div style="text-align: right;"><input type="button" value="DELETE"/> <input type="button" value="CANCEL"/></div> | <p>This message appears if there is not enough internal memory space left when storing data in the Custom Style mode. (See page 78 in the Owner's Manual.)</p> |
|  Delete style ? <div style="border: 1px solid black; padding: 2px; margin-bottom: 5px;"> MEMORY No. 1 (Beat Pop1) (17KB) </div> <div style="text-align: right;"><input type="button" value="OK"/> <input type="button" value="CANCEL"/></div> | <p>This message appears when DELETE is selected from the display shown above.</p> <p>➤ Select the style to be deleted and press the OK button. Press CANCEL if you do not want to delete the style.</p> |
|  Not enough memory ! <div style="text-align: right;"><input type="button" value="OK"/></div> | <p>This message appears when memory capacity has become full during recording in the Custom Style mode (page 78 in the Owner's Manual). This also appears when memory has become full during recording of a song to internal RAM. In this case, recording will stop and data recorded up to that point will be saved automatically.</p> |

Troubleshooting

| Problem | Cause | Solution |
|---|---|---|
| The power of the Clavinova does not turn on. | The power cable plugs are not inserted either in the Clavinova or a proper AC outlet. | Securely insert one of the cable plugs into the instrument itself, and the other plug into a proper AC outlet. |
| A click or pop sound is produced when turning on/off the power. | Electrical current is flowing into the instrument. | This is normal, and is no cause for concern. |
| The LCD display is too bright or too dark to read. | The brightness may be changed by the surrounding temperature. | Adjust the contrast of the display by using the [CONTRAST] control. (See page 15 in the Owner's Manual.) |
| The pop-up display does not open. | The [DISPLAY HOLD] lamp is lit. | Press the [DISPLAY HOLD] button so that the lamp goes out. (See page 15 in the Owner's Manual.) |
| The keyboard sound volume is low compared to that of the Auto Accompaniment or disk playback. | The independent volume level of the keyboard performance sound is too low. | Raise the volume of the keyboard performance in the Mixer display. (See page 94 in the Owner's Manual.) |
| The sound of the Auto Accompaniment or disk playback is low compared to that of the keyboard. | The [ACMP/SONG VOLUME] is low. | Raise the [ACMP/SONG VOLUME] level. |
| The entire sound is low or no sound comes out. | The [MASTER VOLUME] is low. | Raise the [MASTER VOLUME]. |
| | Headphones are connected. | Unplug the headphones. |
| | Local Control is set to off. | Set Local Control to on. (See page 144 in the Owner's Manual.) |
| The damper pedal has no effect, or the sound continuously sustains even when the damper pedal is not pressed. | The pedal cord plug is not connected. | Securely insert the pedal cord plug into the proper jack. (See page 40 in this manual for the CVP-600 and page 48 for the CVP-98/96.) |
| Auto Accompaniment or disk playback does not start. | MIDI Sync is set to "EXT." | Set MIDI Sync to "INT.". (See page 144 in the Owner's Manual.) |
| When the keyboard is played, not all of the notes sound. | Notes have been played beyond the total simultaneous polyphonic capacity (maximum number of notes). | The tone generation system is configured such that later notes have priority, occasionally resulting in previous notes being cut off. See the "Specifications" section on page 37 in this Manual for information on the simultaneous polyphonic capacity. |
| Auto Accompaniment does not play back. | Auto Accompaniment is not turned on. | Press the [ACMP ON] button to turn on Auto Accompaniment. |

Troubleshooting

| Problem | Cause | Solution |
|---|---|---|
| The desired chord cannot be recognized or output by the Auto Accompaniment. | The keys are not being played correctly. | Refer to the “Fingering Chart” (page 36 in this Manual). |
| | The keys are not being played according to the selected Auto Accompaniment type. | Check the Auto Accompaniment type, and play the keys according to the selected type. (See page 56 in the Owner’s Manual.) |
| The maximum of 60 songs cannot be recorded. | The memory capacity is full because the playing time of one or more songs is long, or many functions were used. | Delete unnecessary songs (page 138 in the Owner’s Manual) or record to a new disk. |
| Some tracks do not played back when playing back data. | Playback of the track(s) is set to off. | Set playback for the non-sounding tracks to on. (See pages 91 and 94 in the Owner’s Manual.) |



*** If a “Hardware Error!” message appears in the display when turning on the power, contact your local Yamaha dealer immediately, since this indicates some sort of internal damage to the instrument.**

MIDI and Data Compatibility

■ MIDI

MIDI (Musical Instrument Digital Interface) is a worldwide standard communication interface that allows MIDI-compatible musical instruments and equipment to share musical information and control one another.

- Depending on the MIDI device, the transmittable/receivable data differs, and only data which is commonly recognized among the connected MIDI devices can be transmitted or received. You can check whether your instrument supports certain data types by referring to the MIDI Implementation Chart in the owner's manual for that instrument. The MIDI Implementation Chart for the CVP-98/96/600 is found on page 25 in this Manual.

MIDI Terminals

Data received via the MIDI IN terminal is re-transmitted unchanged through this terminal.

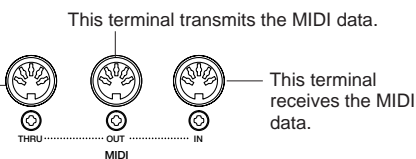

MIDI Cable

Connect MIDI devices with special MIDI cables.

- The various MIDI settings can be made from the Function section's MIDI 1 - 3 pages.
- Further information on MIDI and its applications is available in various music books and magazines.

■ Data Compatibility

This section covers basic information on data compatibility: whether or not other MIDI devices can playback the data recorded by CVP-98/96/600, and whether or not the CVP-98/96/600 can playback commercially available song data or song data created for other instruments or on a computer.

Depending on the MIDI device or data characteristics, you may be able to play back the data without any problem, or you may have to perform some special operations before the data can be played back. If you run into problems playing back data, please refer to the information below.

● Basic Check Points

The data and the MIDI device must match in regards to the items below.

- Disk Format
- Sequence format
- Voice allocation format

● Disk format

Floppy disks are the main storage medium for data used with various devices, including computers. Different devices have different systems of storing data, therefore it is necessary to first configure the floppy disk to the system of the device being used. This operation is called "formatting."

- There are two types of floppy disks: MF2DD (double sided, double density) and MF2HD (double sided, high density), and each type has different formatting systems.
- CVP-98/96/600 can record and playback with both types of floppy disks.
- When formatted by the CVP-98/96/600, a 2DD disk stores up to 720 KB (kilobytes) and a 2HD disk stores up to 1.44 MB (megabytes). (The figures "720 KB" and "1.44 MB" indicate the data memory capacity. They are also used to indicate the format type of disk.)
- Playback is only possible when the MIDI device to be used is compatible with the format of the disk.

● Sequence Format

The system which records song data is called "sequence format."

- Playback is only possible when the sequence format of the disk matches that of the MIDI device.

[Common Sequence Formats]

SMF (Standard MIDI File)

This is the most common sequence format.

- Standard MIDI Files are generally available as one of two types: Format 0 or Format 1.
- Many MIDI devices are compatible with Format 0, and most commercially available software is recorded as Format 0.
- The CVP-98/96/600 is compatible with both Format 0 and Format 1 (for Format 1, up to a maximum of 17 chunks).
- Song data recorded on the CVP-98/96/600 is automatically recorded as SMF Format 0.

ESEQ

This sequence format is compatible with many of Yamaha's MIDI devices, including the Clavinova series instruments.

This is a common format used with various Yamaha software.

- The CVP-98/96/600 is compatible with ESEQ.

● Voice Allocation Format

With MIDI, voices are assigned to specific numbers, called "program numbers." The numbering standard (order of voice allocation) is referred to as the "voice allocation format."

- Voices may not play back as expected unless the voice allocation format of the song data matches that of the compatible MIDI device used for playback.

[Main Voice Allocation Formats]

GM System Level 1

This is one of the most common voice allocation formats.

- Many MIDI devices are compatible with GM System Level 1, as is most commercially available software.
- The CVP-98/96/600 is compatible with GM System Level 1.

XG

XG is a major enhancement of the GM System Level 1 format, and was developed by Yamaha specifically to provide more voices and variations, as well as greater expressive control over voices and effects, and to ensure compatibility of data well into the future.

- The CVP-98/96/600 is compatible with XG.
- Song data recorded on the CVP-98/96/600 is automatically given XG voice allocation.

DOC

This voice allocation format is compatible with many of Yamaha's MIDI devices, including the Clavinova series instruments.











This is also a common format used with various Yamaha software.









- The CVP-98/96/600 is compatible with DOC.

Even if the devices and data used satisfy all the conditions above, the data may still not be completely compatible, depending on the specifications of the devices and particular data recording methods.



Displaymeldungen

● Allgemeine Meldungen













| | |
|---|--|
|  No disk ! | <p>Diese Meldung weist darauf hin, daß keine Diskette im Laufwerk eingelegt ist.</p> <p>➤ Legen Sie die richtige Diskette ein, und wiederholen Sie den Bedienvorgang.</p> |
|  No songs ! | <p>Diese Warnmeldung weist beim Benennen bzw. Kopieren eigener Songdaten darauf hin, daß bei der gewählten Songnummer bzw. auf der Diskette keine Songdaten gespeichert sind.</p> <p>➤ Wählen Sie die richtige (Daten enthaltene) Songnummer, oder legen Sie eine Diskette mit Songdateien ein.</p> |
|  No file ! | <p>Diese Warnmeldung weist beim versuchten Ausführen einer dateispezifischen Operation darauf hin, daß auf der eingelegten Diskette keine entsprechende Datei (z.B. Registration- oder Stimmungsdatei) gespeichert ist.</p> <p>➤ Legen Sie eine Datei an, oder legen Sie die richtige Diskette ein, und wiederholen Sie den Bedienvorgang.</p> |
|  Start disk format ? <input type="button" value="OK"/> <input type="button" value="CANCEL"/> | <p>Diese Meldung erscheint, wenn Sie eine neue (unformatierte) Diskette oder eine mit einem anderen Gerät formatierte Diskette einlegen. (Siehe Seite 106 in der Bedienungsanleitung.)</p> <p>➤ Drücken Sie OK, um die Diskette zu formatieren, oder aber CANCEL, um den Vorgang ohne Formatierung abzubrechen.</p> |
|  Protected disk ! | <p>Diese Meldung wird angezeigt, wenn Sie versuchen, mit einer Diskette aufzunehmen oder Daten zu speichern, deren Schreibschutzknopf auf "schreibgeschützt" steht.</p> <p>➤ Stellen Sie den Schreibschutzknopf auf "schreibfähig" (Seite 7 in der Bedienungsanleitung), um den Bedienvorgang dann noch einmal auszuführen. Sollte die Bedienung erneut verweigert werden, sind die Dateien der Diskette selbst schreibgeschützt, so daß die Diskette nicht zum Aufnehmen oder Speichern verwendet werden kann.</p> |
|  Protected songs ! | <p>Diese Meldung erscheint, wenn Sie versuchen, einen Song zu bearbeiten, der mit einem anderen System erstellt wurde oder schreibgeschützt ist. Songdaten anderer Systeme können unter Umständen nicht mit dem CVP-98/96/600 nachbearbeitet, kopiert oder gelöscht werden.</p> |
|  Disk read/write error ! <input type="button" value="OK"/> | <p>Beim Beschreiben (Aufnehmen oder Speichern von Daten) bzw. Lesen der Diskette ist ein Fehler aufgetreten.</p> <p>➤ Drücken Sie die OK-Displaytaste, und wiederholen Sie den Bedienvorgang. Sollte der Fehler ein zweites Mal auftreten, ist die Diskette oder das Laufwerk unter Umständen verschmutzt bzw. defekt. Wenn Sie einen Laufwerkdefekt annehmen, wenden Sie sich an Ihren Yamaha-Fachhändler.</p> |
|  Completed ! | <p>Diese Meldung erscheint, wenn eine länger dauernde Diskettenoperation (Formatierung, Kopieren eines Songs u. dgl.) abgeschlossen ist.</p> |
|  Don't remove the disk ! | <p>Diese Meldung wird angezeigt, während Daten zwischen dem Clavinova und dem Laufwerk transferiert werden.</p> <p>➤ Die Meldung verschwindet automatisch, sobald der Schreib-/Lesevorgang abgeschlossen ist.</p> |
|  Are you sure ? <input type="button" value="YES"/> <input type="button" value="NO"/> | <p>Diese Meldung fordert Sie vor einer Operation wie Löschen eines Songs oder Formatierung einer Diskette auf, die Ausführung des Vorgangs zu bestätigen.</p> <p>➤ Drücken Sie YES, um den Vorgang auszuführen. Drücken Sie NO, um ohne Ausführung des Vorgangs zur früheren Anzeige zurückzugehen.</p> |
|  Disk full ! <input type="button" value="OK"/> | <p>Die eingelegte Diskette ist voll und kann keine weiteren Daten speichern.</p> <p>➤ Drücken Sie die OK-Displaytaste, und löschen Sie dann nicht mehr gebrauchte Daten von der Diskette (Seite 138 in der Bedienungsanleitung), oder verwenden Sie eine andere Diskette, auf der noch ausreichend Speicherraum frei ist. Wenn diese Meldung beim Aufnehmen eines Songs angezeigt wird (OK wird in diesem Fall nicht angeboten), stoppt die Aufnahme, wobei die Daten bis zu diesem Punkt automatisch gespeichert werden.</p> |

| | |
|---|--|
|  Too many files ! <input type="button" value="OK"/> | <p>Auf einer 2DD- oder 2HD-Diskette können jeweils bis zu 60 Song-Dateien gespeichert werden. Eine 2DD-Diskette kann etwa 110 Dateien (unterschiedlichen Typs) speichern, und eine 2HD-Diskette etwa 220.</p> <p>Diese Meldung wird angezeigt, wenn Sie versuchen, mehr als die zulässige Anzahl an Dateien auf einer Diskette zu speichern.</p> <ul style="list-style-type: none"> ➤ Drücken Sie die OK-Displaytaste, und löschen Sie dann nicht mehr gebrauchte Dateien von der Diskette (Seite 138 in der Bedienungsanleitung), oder verwenden Sie eine Diskette mit ausreichend freiem Speicherraum. |
|  Same name ! Overwrite ? <input type="button" value="OK"/> <input type="button" value="CANCEL"/> | <p>Eine Datei mit demselben Namen existiert bereits.</p> <ul style="list-style-type: none"> ➤ Drücken Sie die OK-Displaytaste, um die ältere Datei zu löschen und durch die neue zu ersetzen, oder aber CANCEL, um den Vorgang abzubrechen. |
|  This button can't be used during recordings or playback ! | <p>Diese Meldung wird angezeigt, wenn Sie versuchen, während der Aufnahme oder Wiedergabe eines Songs einen unzulässigen Vorgang auszuführen (Dateikonversion, Formatierung o. dgl.).</p> <ul style="list-style-type: none"> ➤ Stoppen Sie den Aufnahme- oder Wiedergabebetrieb, oder verlassen Sie den Aufnahme- bzw. Wiedergabemodus, um den Vorgang danach auszuführen. |
|  This button can't be used during playback ! | <p>Diese Meldung wird angezeigt, wenn Sie versuchen, während der Song-Wiedergabe einen unzulässigen Vorgang auszuführen (Ändern der Anzahl an Wiederholungen für Guide-Übungsfunktion u. dgl.).</p> <ul style="list-style-type: none"> ➤ Stoppen Sie den Wiedergabebetrieb, oder verlassen Sie den Wiedergabemodus, um den Vorgang danach auszuführen. |
|  Button not valid ! | <p>Sie haben eine Taste betätigt, die im aktuellen Modus keine Funktion hat.</p> |
|  Disk read/write operation in process ! | <p>Diese Meldung erscheint, wenn Sie versuchen, einen anderen Vorgang auszuführen, während Daten auf die Diskette geschrieben oder von der Diskette gelesen werden.</p> <ul style="list-style-type: none"> ➤ Warten Sie, bis der Schreib-/Lesevorgang beendet ist, und führen Sie den Vorgang danach aus. |
|  Memory write operation in process ! | <p>Diese Meldung erscheint, wenn Sie versuchen, einen anderen Vorgang auszuführen, während bei der Bearbeitung eines im internen RAM aufgenommenen Songs Daten gespeichert werden.</p> <ul style="list-style-type: none"> ➤ Warten Sie, bis die Daten gespeichert sind, und führen Sie den Vorgang danach aus. |
|  Delete CVP MEMORY ? <input type="button" value="YES"/> <input type="button" value="NO"/> | <p>Diese Meldung erscheint, wenn ein Vorgang ausgeführt wird, der ein Löschen der im internen RAM gespeicherten Daten zur Folge hat (z. B. Abspielen von Disketten-Software).</p> <ul style="list-style-type: none"> ➤ Drücken Sie YES, um die Daten im internen RAM zu löschen und den Vorgang auszuführen. Wenn die Daten nicht gelöscht werden sollen, drücken Sie NO, um den Vorgang abzubrechen. |
|  Convert to CVP songs ? <input type="button" value="YES"/> <input type="button" value="NO"/> | <p>Diese Meldung erscheint, wenn Sie versuchen, einen auf Diskette erworbenen Song oder Daten, die mit einem anderen Clavinova-Modell als dem CVP-94/92/98/96/600 aufgezeichnet wurden, durch eine Neuaufnahme zu ergänzen oder anderweitig zu bearbeiten.</p> <ul style="list-style-type: none"> ➤ Drücken Sie YES, um die Daten zur Bearbeitung auf dem CVP-94/92/98/96/600 zu konvertieren. Drücken Sie NO, wenn die Daten nicht konvertiert werden sollen. |

● Beim Kopieren von Songs angezeigte Meldungen

| | |
|--|--|
|  Number of disk exchange (1) <input type="button" value="OK"/> <input type="button" value="CANCEL"/> | <p>Diese Meldung gibt beim Kopieren einer Song-Datei auf eine andere Diskette vor dem Starten des Kopiervorgangs darüber Auskunft, wie oft Quellen- und Zieldiskette gegeneinander ausgetauscht werden müssen. (Siehe Seite 137 in der Bedienungsanleitung.)</p> |
|  Insert Disk 2. (1 / 3) <input type="button" value="CANCEL"/> | <p>Diese Meldung weist Sie an, die Zieldiskette einzulegen. (Siehe Seite 137 in der Bedienungsanleitung.)</p> |
|  Please select destination song number. <input type="text" value="SONG 1"/> <input type="button" value="OK"/> <input type="button" value="CANCEL"/> | <p>Wenn Sie beim Kopieren einer Song-Datei auf eine andere Diskette die Zieldiskette das erste Mal einlegen, fordert Sie diese Meldung auf, die Songnummer zu wählen, an der die Kopie abgelegt werden soll. (Siehe Seite 137 in der Bedienungsanleitung.)</p> |

Displaymeldungen

| | |
|---|---|
|  Insert Disk 1. (2/ 3) <input type="button" value="CANCEL"/> | <p>Diese Meldung weist Sie beim Kopieren einer Song-Datei auf eine andere Diskette an, die Quellediskette einzulegen. (Siehe Seite 137 in der Bedienungsanleitung.)</p> |
|  Select a different number ! | <p>Diese Meldung wird angezeigt, wenn als Quelle und Ziel dieselbe Songnummer gewählt wurde. > Ändern Sie die Ziel-Songnummer.</p> |
| <h2>● Beim Programmieren von Styles angezeigte Meldungen</h2> | |
|  CUSTOM STYLE Please select a source style. | <p>Diese Meldung wird beim Aufrufen des CUSTOM STYLE-Modus einige Sekunden lang angezeigt. (Siehe Seite 68 in der Bedienungsanleitung.)</p> |
|  Clear style ? <input type="button" value="OK"/> <input type="button" value="CANCEL"/> | <p>Diese Bestätigungsaufforderung erscheint, wenn Sie versuchen, im CUSTOM STYLE-Modus die Taktart zu ändern. (Siehe Seite 70 in der Bedienungsanleitung.)</p> |
|  Clear section ? <input type="button" value="OK"/> <input type="button" value="CANCEL"/> | <p>Diese Bestätigungsaufforderung erscheint, wenn Sie versuchen, im CUSTOM STYLE-Modus die Taktzahl zu ändern. (Siehe Seite 70 in der Bedienungsanleitung.)</p> |
|  Clear part ? <input type="button" value="OK"/> <input type="button" value="CANCEL"/> | <p>Diese Bestätigungsaufforderung erscheint, wenn Sie versuchen, im CUSTOM STYLE-Modus einen Vorgang auszuführen, der nur nach Löschen der Part-Daten des Original-Styles möglich ist. (Siehe Seite 71 in der Bedienungsanleitung.)</p> |
|  Store Bossa NovaX ? MEMORY No. 1 (TEMP.STYLE) <input type="button" value="OK"/> <input type="button" value="CANCEL"/> | <p>Diese Bestätigungsaufforderung erscheint, wenn Sie versuchen, im CUSTOM STYLE-Modus einen Speichervorgang auszuführen. (Siehe Seite 74 in der Bedienungsanleitung.) Die Meldung wird auch angezeigt, wenn Sie versuchen, einen anderen Style zu wählen, ohne die Custom-Style-Daten zu speichern. (Siehe Seite 79 in der Bedienungsanleitung.)</p> |
|  Store Bossa NovaX ? MEMORY No. 1 (TEMP.STYLE) <input type="button" value="YES"/> <input type="button" value="NO"/> <input type="button" value="CANCEL"/> | <p>Diese Meldung wird angezeigt, wenn Sie versuchen, den CUSTOM STYLE-Modus zu verlassen, ohne die Daten zu speichern. (Siehe Seite 79 in der Bedienungsanleitung.) > Drücken Sie OK, um die Daten zu speichern. Drücken Sie NO, um den Modus zu verlassen, ohne die Daten zu speichern. Drücken Sie CANCEL, wenn Sie die Daten noch nicht speichern und wieder zur früheren Anzeige gelangen wollen. (Siehe Seite 79 in der Bedienungsanleitung.)</p> |
|  Can't recall ! <input type="button" value="OK"/> | <p>Diese Meldung wird angezeigt, wenn die RECALL SECTION-Funktion des Custom STYLE-Modus nicht ausgeführt werden kann (z.B. nach Ändern der Taktart). (Siehe Seite 74 in der Bedienungsanleitung.)</p> |
|  Please store to memory before saving to disk <input type="button" value="OK"/> | <p>Diese Bestätigungsaufforderung erscheint im CUSTOM STYLE-Modus, wenn Sie versuchen, den programmierten Style auf Diskette sicherzustellen, ohne ihn zuvor intern gespeichert zu haben. (Siehe Seite 76 in der Bedienungsanleitung.)</p> |
|  Not enough memory ! Please delete an unneeded style or simplify the current style. <input type="button" value="DELETE"/> <input type="button" value="CANCEL"/> | <p>Diese Meldung erscheint, wenn der Platz im internen RAM zum Speichern des Custom-Styles nicht ausreicht. (Siehe Seite 78 in der Bedienungsanleitung.)</p> |
|  Delete style ? MEMORY No. 1 (8Beat Pop1 (17KB)) <input type="button" value="OK"/> <input type="button" value="CANCEL"/> | <p>Diese Meldung erscheint, wenn auf der vorangehend beschriebenen Anzeige DELETE gewählt wird. > Wählen Sie den zu löschenden Style, und drücken Sie die OK-Displaytaste. Wenn keine Daten gelöscht werden sollen, drücken Sie CANCEL.</p> |
|  Not enough memory ! <input type="button" value="OK"/> | <p>Diese Meldung wird angezeigt, wenn der Speicher beim Programmieren im CUSTOM STYLE-Modus voll wird (Seite 78 in der Bedienungsanleitung). Die Meldung wird auch angezeigt, wenn der Speicher beim Aufnehmen eines Songs im internen RAM voll wird. In diesem Fall stoppt die Aufnahme (OK wird nicht angeboten), und alle Daten bis zu diesem Punkt werden automatisch gespeichert.</p> |

● Beim Konvertieren von Daten angezeigte Meldungen

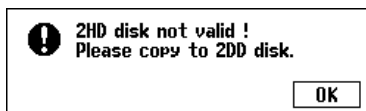

Diese Meldung erscheint, wenn versucht wird, eine Datei auf einer 2HD-Diskette zu konvertieren.

- > Drücken Sie **OK**, um den zu konvertierenden Song auf eine 2DD-Diskette zu kopieren, mit der die Konvertierung dann möglich ist.

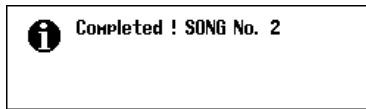

Diese Meldung zeigt nach der erfolgreichen Konvertierung an, unter welcher Nummer die konvertierte Datei gespeichert wurde.

● Beim Ändern von Anfangsdaten angezeigte Meldungen

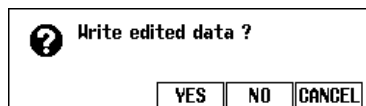

Diese Bestätigungsaufforderung erscheint, wenn Sie versuchen, die INITIAL EDIT-Anzeige zu verlassen, ohne die bearbeiteten Anfangsdaten zu speichern.

- > Drücken Sie **YES**, um die geänderten Daten zu speichern. Drücken Sie **NO**, um die Funktion ohne Speichern der Daten zu verlassen. Drücken Sie **CANCEL**, um ohne Speichern der Daten wieder zur INITIAL EDIT-Anzeige zurückzugehen.

● Beim Aufnehmen von Akkordsequenzen angezeigte Meldungen

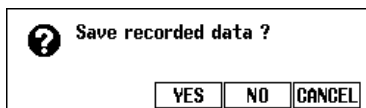

Diese Bestätigungsaufforderung erscheint, wenn Sie versuchen, die CHORD SEQUENCE-Funktion während der Aufnahme zu verlassen.

- > Drücken Sie **YES**, um die aufgenommenen Daten zu speichern. Drücken Sie **NO**, um die Funktion ohne Speichern der Daten zu verlassen. Drücken Sie **CANCEL**, um ohne Speichern der Daten wieder zur CHORD SEQUENCE-Anzeige zurückzugehen.

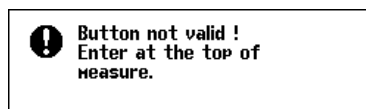

Diese Meldung erscheint bei der CHORD SEQUENCE-Aufnahme, wenn Sie versuchen, eine Style- oder Sektionsänderung an einem anderen Punkt als dem Anfang eines Taktes einzugeben.

- > Setzen Sie Style- oder Sektionsänderungen stets am Taktanfang. (Siehe Seite 118 in der Bedienungsanleitung.)

● Beim Laden von Style-Dateien angezeigte Meldungen

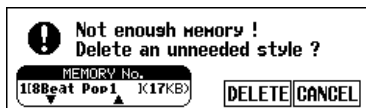

Diese Meldung erscheint, wenn der freie Platz im internen Speicher beim versuchten Laden einer Style-Datei nicht ausreicht. (Siehe Seite 82 in der Bedienungsanleitung.)

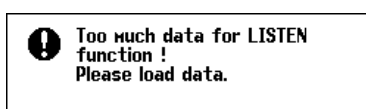

Manche Style-Dateien sind zu umfangreich für die **LISTEN**-Funktion auf der STYLE FILE LOAD-Anzeige. (Siehe Seite 81 in der Bedienungsanleitung.)

● Andere Meldungen

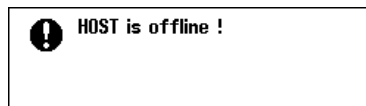

Diese Nachricht erscheint, wenn der Hostcomputer nicht eingeschaltet, das Verbindungskabel nicht korrekt angeschlossen, der HOST SELECT-Schalter nicht richtig eingestellt oder der MIDI-Treiber bzw. das MIDI-Anwendungsprogramm nicht aktiv ist. In diesem Fall schalten Sie sowohl das Clavinova als auch den Computer aus, um dann die Kabelverbindungen sowie die Einstellung des HOST SELECT-Schalters zu überprüfen. Wenn die Verbindungen stimmen und der HOST SELECT-Schalter richtig eingestellt ist, schalten Sie zunächst den Computer und erst danach das Clavinova ein, um dann den MIDI-Treiber und das MIDI-Anwendungsprogramm auf ordnungsgemäße Funktion zu prüfen.

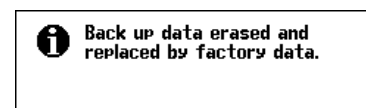

Solange das Clavinova regelmäßig benutzt wird, bleiben die Daten (Einstellungen) im Speicher erhalten. Wenn das Instrument jedoch eine Woche oder länger ausgeschaltet war, weist diese Meldung darauf hin, daß die Daten gelöscht wurden. Diese Meldung wird auch angezeigt, wenn Sie das Instrument auf die werkseitigen Vorgabeeinstellungen rücksetzen. (Siehe Seite 147 in der Bedienungsanleitung.)

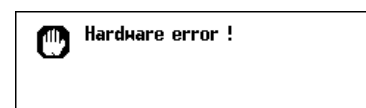

Beim Einschalten wurde ein Hardware-Fehler festgestellt.

- > Wenden Sie sich an Ihren Yamaha-Fachhändler.

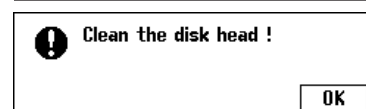

Der Schreib/Lese-Kopf des Diskettenlaufwerks ist schmutzig. Reinigen Sie ihn mit einer im Fachhandel erhältlichen Reinigungsdiskette.

Fehlersuche

| Problem | Ursache | Abhilfe |
|--|---|--|
| Das Clavinova kann nicht eingeschaltet werden. | Das Netzkabel ist nicht (fest) angeschlossen. | Schließen Sie den kleinen Stecker des Netzkabels fest an die Buchse des Instruments an und den Netzstecker an eine Steckdose. |
| Beim Einschalten ist ein Klick- oder Ploppgeräusch zu hören. | In das Instrument fließender Stromstoß. | Dies ist normal und kein Grund zur Besorgnis. |
| Das Display ist zu hell oder zu dunkel. | Die Helligkeit kann sich mit der Umgebungstemperatur ändern. | Stellen Sie das Display mit dem [CONTRAST] -Regler ein. (Siehe Seite 15 in der Bedienungsanleitung.) |
| Die Pop-up Anzeige wird nicht eingeblendet. | Die [DISPLAY HOLD] -Anzeigelampe leuchtet. | Drücken Sie die [DISPLAY HOLD] -Taste, so daß die Anzeigelampe erlischt. (Siehe Seite 15 in der Bedienungsanleitung.) |
| Die Tastatur-Tonlautstärke ist im Vergleich zur Begleitungs- bzw. Disketten-Wiedergabelautstärke zu niedrig. | Die Tastatur-Lautstärke ist zu niedrig eingestellt. | Stellen Sie auf der MIXER-Anzeige einen höheren Tastatur-Lautstärkewert ein. (Siehe Seite 94 in der Bedienungsanleitung.) |
| Die Begleitungs- bzw. Disketten-Wiedergabelautstärke ist im Vergleich zur Tastatur-Lautstärke zu niedrig. | Der [ACMP/SONG VOLUME] -Regler ist zu niedrig eingestellt. | Stellen Sie den [ACMP/SONG VOLUME] -Regler höher ein. |
| Die Lautstärke insgesamt ist zu niedrig, oder es ist gar kein Ton zu hören. | Der [MASTER VOLUME] -Regler ist zu niedrig eingestellt. | Stellen Sie den [MASTER VOLUME] -Regler höher ein. |
| | Kopfhörer sind angeschlossen. | Trennen Sie die Kopfhörer ab. |
| | Local-Steuerung ist ausgeschaltet. | Schalten Sie die Local-Steuerung wieder ein. (Siehe Seite 144 in der Bedienungsanleitung.) |
| Das Dämpferpedal arbeitet nicht, oder Noten werden ausgehalten, obwohl das Dämpferpedal nicht betätigt wird. | Das Pedalkabel ist nicht angeschlossen. | Schließen Sie das Pedalkabel fest an die entsprechende Buchse an. (CVP-600 siehe Seite 40 und CVP-98/96 Seite 48 in dieser Anleitung.) |
| Die Begleitungs- oder Disketten-Wiedergabe kann nicht gestartet werden. | Die MIDI-Taktsteuerung (SYNC) ist auf "EXT" eingestellt. | Stellen Sie die MIDI-Taktsteuerung auf "INT". (Siehe Seite 144 in der Bedienungsanleitung.) |
| Beim Spielen auf der Tastatur bleiben manche Noten stumm. | Die Polyphoniekapazität (Zahl der gleichzeitig in Ton umsetzbaren Noten) wurde überschritten. | Das Tonerzeugungssystem ist so konfiguriert, daß bei einer Überschreitung der Kapazität später gespielte Noten Priorität haben und die jeweils ältesten verstummen. Mehr über die Polyphoniekapazität erfahren Sie im Abschnitt "Technische Daten" auf Seite 37 in dieser Anleitung. |
| Die automatische Baß/Akkord-Begleitung wird nicht gespielt. | AUTO ACCOMPANIMENT ist ausgeschaltet. | Drücken Sie die [ACMP ON] -Taste, um die automatische Baß/Akkord-Begleitung einzuschalten. |

| Problem | Ursache | Abhilfe |
|---|--|---|
| Akkorde werden von der AUTO AC-COMPANIMENT-Funktion nicht richtig erkannt oder umgesetzt. | Die falschen Tasten wurden angeschlagen. | Siehe "Akkordliste" (Seite 36 in dieser Anleitung). |
| | Es wurden nicht die zum gewählten Akkordgriff-Modus passenden Tasten angeschlagen. | Sehen Sie nach, welcher Akkordgriff-Modus gewählt ist, und schlagen Sie dazu passende Tasten an. (Siehe Seite 56 in der Bedienungsanleitung.) |
| Die Disketten-Speicherkapazität von 60 Songs wird nicht erreicht. | Wenn manche der Songs extrem lang sind und mit vielen Funktionen aufgenommen wurden, können nicht so viele Songs gespeichert werden. | Löschen Sie nicht mehr gebrauchte Dateien (Seite 138 in der Bedienungsanleitung) oder verwenden Sie eine neue Diskette. |
| Einige Spuren werden bei der Wiedergabe von Daten nicht gespielt. | Die Spuren sind ausgeschaltet. | Schalten Sie die "stummen" Spuren ein. (Siehe Seiten 91 und 94 in der Bedienungsanleitung.) |



* **Wenn die Meldung "Hardware Error!" nach dem Einschalten angezeigt wird, wenden Sie sich bitte sofort an Ihren Yamaha-Händler, da dies auf einen internen Defekt schließen lässt.**

MIDI und Datenkompatibilität

■ MIDI

MIDI (Musical Instrument Digital Interface) ist ein weltweiter Kommunikationsschnittstellenstandard, der es MIDI-kompatiblen Musikinstrumenten und Geräten ermöglicht, musikalische Information auszutauschen und sich gegenseitig zu steuern.

- Die übertragbaren/empfangbaren MIDI-Daten sind je nach MIDI-Gerät unterschiedlich, wobei die Gesamtheit aller MIDI-Daten jedoch standardisiert ist, so daß eine eindeutige Kommunikation gewährleistet wird. Welche Daten vom jeweiligen Gerät gesendet bzw. empfangen werden, können Sie der MIDI-Implementierungstabelle entnehmen, die in der Dokumentation jedes MIDI-Instruments enthalten ist. Die MIDI-Implementierungstabelle des CVP-98/96/600 ist auf Seite 25 in dieser Anleitung abgedruckt.

MIDI-Buchsen

Über die MIDI IN-Buchse empfangene Daten werden unverändert an dieser Buchse wieder ausgegeben.

Über diese Buchse werden MIDI-Daten gesendet.

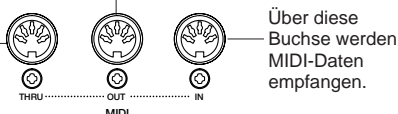

MIDI-Kabel

Verbinden Sie die MIDI-Geräte mit speziell hierfür vorgesehenen MIDI-Kabeln.

- Die verschiedenen MIDI-Einstellungen können auf den FUNCTION-Anzeigen MIDI 1 bis MIDI 3 vorgenommen werden.
- Einschlägige Bücher und Zeitschriften über MIDI und seine Anwendungen sind im Fachhandel erhältlich.

■ Datenkompatibilität

Dieser Abschnitt gibt eine kurze Übersicht über die Datenkompatibilität: welche MIDI-Geräte die mit dem CVP-98/96/600 aufgezeichneten Daten abspielen können, und welche der im Fachhandel für andere Instrumente erhältlichen oder auf einem anderen Instrument bzw. Computer erstellten Song-Daten das CVP-98/96/600 abspielen kann.

Die Dateien gewisser MIDI-Geräte können problemlos abgespielt werden, während für andere unter Umständen ein besonderes Verfahren erforderlich ist. Sollten Sie beim Abspielen von Daten Probleme haben, beachten Sie bitte die im folgenden erläuterten Punkte.

● Grundlegende Prüfpunkte

Die Daten und das MIDI-Gerät müssen hinsichtlich der folgenden Formate kompatibel sein:

- Diskettenformat
- Sequenzformat
- Stimmenzuordnungsformat

● Diskettenformat

Das weitverbreitetste Medium zum Speichern von Daten ist wohl die Floppy-Diskette, die früher nur Computern vorbehalten war. Bei Disketten ist zu beachten, daß es gerätespezifische Unterschiede in der Einteilung des Speicherplatzes und beim Aufzeichnungsverfahren gibt, weshalb Disketten vor Gebrauch "initialisiert" (systemkompatibel gemacht) werden müssen. Dies erreicht man durch das "Formatieren" der Disketten.

- Es gibt zwei Arten von Disketten: MF2DD (doppelseitig, doppelte Schreibdichte) und MF2HD (doppelseitig, hohe Schreibdichte). Beide Arten werden unterschiedlich formatiert.
- Beim CVP-98/96/600 können beide Diskettenarten für Aufnahme und Wiedergabe verwendet werden.
- Das CVP-98/96/600 formatiert 2DD-Disketten auf 720 KB (Kilobyte) und 2HD-Disketten auf 1,44 MB. (Die Werte "720 KB" und "1,44 MB" entsprechen der Speicherkapazität, werden jedoch oft auch zur Identifizierung der Diskettenart herangezogen.)

- Die Wiedergabe ("Lesen") der gespeicherten Daten ist nur möglich, wenn das MIDI-Gerät mit dem Format der Diskette kompatibel ist.

● Sequenzformat

Unter "Sequenzformat" wird das System verstanden, nach dem Songdaten aufgezeichnet werden.

- Eine Wiedergabe der Songdaten ist nur möglich, wenn das MIDI-Gerät mit dem Sequenzformat der Diskettendaten kompatibel ist.

[Allgemeine Sequenzformate]

SMF (Standard MIDI File)

Dies ist das verbreitetste Sequenzformat.

- Standard MIDI-Dateien haben eines von zwei Formaten: Format 0 oder Format 1.
- Viele MIDI-Geräte sind mit Format 0 kompatibel, und der Großteil der im Handel erhältliche Software ist im Format 0 aufgezeichnet.
- Das CVP-98/96/600 ist sowohl mit Format 0 als auch mit Format 1 kompatibel (bei Format 1 max. 17 Stücke).
- Auf dem CVP-98/96/600 aufgenommene Songs werden automatisch im Format 0 aufgezeichnet.

ESEQ

Viele MIDI-Geräte von Yamaha, unter anderem auch die Clavinova-Modelle, sind auch mit diesem Format kompatibel. Dies ist ein oft für Yamaha-Software verwendetes Format.

- Das CVP-98/96/600 ist mit ESEQ kompatibel.

● Stimmenzuordnungsformat

Bei MIDI sind die Stimmen (Voices) spezifischen Nummern zugeordnet, die "Programmnummern" genannt werden. Diese Nummernzuordnung wird "Stimmenzuordnungsformat" genannt.

- Beim Abspielen eines Songs auf einem anderen MIDI-Gerät kann dieses die Daten nur dann originalgetreu wiedergeben, wenn es mit derselben Stimmenzuordnungsformat arbeitet wie das Aufnahmegerät.

[Wichtigste Stimmenzuordnungsformate]

GM System Level 1

Dies ist das gebräuchlichste Stimmenzuordnungsformat.

- Viele MIDI-Geräte sind mit GM System Level 1 kompatibel, und ein Großteil der im Handel erhältlichen Software ist entsprechend programmiert.
- Das CVP-98/96/600 ist mit GM System Level 1 kompatibel.

XG

XG ist eine Bereicherung des GM System Level 1-Formats und wurde von Yamaha speziell zu dem Zweck entwickelt, mehr Stimmen- und Variationsvielfalt sowie eine bessere expressive Steuerung von Stimmen und Effekten zu bieten, wobei auch die langfristige Kompatibilität von Daten berücksichtigt wurde.

- Das CVP-98/96/600 ist mit XG kompatibel.
- Songdaten werden vom CVP-98/96/600 mit XG-Stimmenzuordnung aufgezeichnet.

DOC

Viele MIDI-Geräte von Yamaha, unter anderem auch die Clavinova-Modelle, sind auch mit diesem Stimmenzuordnungsformat kompatibel.











Ein Großteil der Yamaha-Software ist im DOC-Format erhältlich.









- Das CVP-98/96/600 ist mit DOC kompatibel.

Auch wenn die Geräte und Daten alle obengenannten Voraussetzungen erfüllen, sind die Daten je nach Gerätespezifikation und Aufzeichnungsverfahren unter Umständen nur bedingt kompatibel.



Messages

● Messages communs

| | |
|---|---|
|  No disk ! | <p>Ce message apparaît quand il n'y a pas de disquette dans le lecteur.</p> <p>➤ Introduisez une disquette dans le lecteur et recommencez la procédure.</p> |
|  No songs ! | <p>Lorsque vous changez le nom des données personnelles, ou que vous convertissez des données, ce message vous avertit dans le cas où il n'y a pas de données de morceau.</p> <p>➤ Sélectionnez un morceau contenant des données ou insérez une disquette avec des données dans le lecteur de disquette.</p> |
|  No file ! | <p>Ce message apparaît quand il n'y a pas de mémoire de registration, de micro-accord ou de données concernées dans la disquette actuellement insérée lorsque vous essayez d'exécuter une opération de disquette.</p> <p>➤ Créez un fichier ou insérez une disquette avec le bon fichier.</p> |
|  Start disk format ? <input type="button" value="OK"/> <input type="button" value="CANCEL"/> | <p>Ce message apparaît quand vous introduisez une disquette neuve ou une disquette formatée pour un autre système que le Clavinova dans le lecteur de disquette. (Voir page 106 dans le mode d'emploi).</p> <p>➤ Appuyez sur OK si vous désirez formater la disquette. Appuyez sur CANCEL si vous voulez abandonner le processus de formatage.</p> |
|  Protected disk ! | <p>Ce message apparaît quand vous essayez d'enregistrer ou d'exécuter d'autres opérations de fichier sur une disquette dont la languette de protection contre l'écriture est positionnée sur "write protect" (écriture protégée).</p> <p>➤ Placez la languette de protection contre l'écriture sur la position destinée à l'enregistrement (page 7 dans le mode d'emploi), puis recommencez la procédure. Si vous ne pouvez toujours pas réaliser cette opération, c'est que la disquette elle-même est pourvue d'une protection interne contre l'écriture qui ne vous permet pas d'enregistrer ou de procéder à des opérations de fichier.</p> |
|  Protected songs ! | <p>Ce message apparaît quand vous essayez d'enregistrer sur des parties ou d'exécuter d'autres opérations de fichier qui sont incompatibles ou ne permettent pas de telles opérations. Selon le type de fichier, les opérations telles que les enregistrements supplémentaires, la copie, l'effacement, etc., peuvent s'avérer impossibles sur le CVP-98/96/600.</p> |
|  Disk read/write error ! <input type="button" value="OK"/> | <p>Une erreur s'est produite pendant l'écriture sur la disquette (comme dans un enregistrement ou la sauvegarde des fichiers) ou la lecture à partir de la disquette.</p> <p>➤ Recommencez la procédure après avoir appuyé sur la touche OK. Si l'erreur se produit une seconde fois, la disquette ou le lecteur est peut-être défectueux. Si vous pensez que le lecteur est à l'origine du problème, consultez votre revendeur Yamaha.</p> |
|  Completed ! | <p>Ce message apparaît pendant quelques secondes, quand une opération demandant un certain temps, telle que le formatage, la copie d'un morceau, est terminée.</p> |
|  Don't remove the disk ! | <p>Ce message apparaît quand les données sont en cours de transfert entre le Clavinova et la disquette.</p> <p>➤ Le message disparaît automatiquement quand l'opération est terminée.</p> |
|  Are you sure ? <input type="button" value="YES"/> <input type="button" value="NO"/> | <p>Lorsque vous sélectionnez des opérations telles que l'effacement d'un morceau ou le formatage, ce message vous demande de confirmer si vous voulez continuer l'opération ou non.</p> <p>➤ Appuyez sur YES pour exécuter l'opération ou sur NO pour revenir à l'afficheur précédent.</p> |
|  Disk full ! <input type="button" value="OK"/> | <p>La disquette actuellement chargée est pleine et ne peut plus accepter de données.</p> <p>➤ Appuyez sur la touche OK, puis effacez toutes les données inutiles sur la disquette (page 138 dans le mode d'emploi), ou utilisez une disquette avec suffisamment d'espace disponible. Si ce message apparaît pendant l'enregistrement d'un morceau, (dans ce cas OK n'apparaît pas), l'enregistrement s'arrête et les données enregistrées jusqu'à ce point sont automatiquement sauvegardées.</p> |

| | |
|--|---|
|  Too many files ! <input type="button" value="OK"/> | <p>Les disquettes 2DD et 2HD peuvent contenir chacune 60 fichiers de morceau. Une disquette 2DD peut accepter environ 100 fichiers (de diverses sortes) tandis que la disquette 2HD en accepte 220 environ.</p> <p>Ce message apparaît quand vous essayez de produire plus de fichiers que la disquette n'est capable d'en sauvegarder.</p> <ul style="list-style-type: none"> > Appuyez sur OK, puis effacez les fichiers inutiles sur la disquette (page 138 dans le mode d'emploi) ou utilisez une disquette qui comprend plus d'espace disponible. |
|  Same name ! Overwrite ? <input type="button" value="OK"/> <input type="button" value="CANCEL"/> | <p>Un fichier portant le même nom existe.</p> <ul style="list-style-type: none"> > Appuyez sur OK si vous désirez remplacer le fichier d'origine avec les nouvelles données ou appuyez sur CANCEL pour abandonner l'opération. |
|  This button can't be used during recordings or playback ! | <p>Ce message apparaît quand vous essayez de réaliser des opérations qui sont impossibles pendant l'enregistrement ou la reproduction, telles que la conversion, le formatage, etc.</p> <ul style="list-style-type: none"> > Arrêtez l'enregistrement ou la reproduction du morceau, ou sortez du mode enregistrement/reproduction, puis recommencez l'opération. |
|  This button can't be used during playback ! | <p>Ce message apparaît quand vous essayez de réaliser des opérations qui ne peuvent pas être exécutées pendant la reproduction, telles que le changement du nombre de répétitions de la fonction guide.</p> <ul style="list-style-type: none"> > Arrêtez la reproduction du morceau, ou sortez du mode de reproduction, puis recommencez l'opération. |
|  Button not valid ! | <p>Vous avez appuyé sur une touche qui n'a aucune fonction dans le mode actuel.</p> |
|  Disk read/write operation in process ! | <p>Ce message apparaît quand vous essayez de lire des données de la disquette ou de sauvegarder des données.</p> <ul style="list-style-type: none"> > Attendez jusqu'à ce que l'opération de lecture/écriture soit terminée, puis recommencez l'opération. |
|  Memory write operation in process ! | <p>Ce message apparaît quand vous voulez exécuter une autre opération pendant l'écriture des données éditées d'un morceau enregistré dans la RAM interne.</p> <ul style="list-style-type: none"> > Terminez d'abord l'opération d'écriture des données, puis réalisez l'autre opération. |
|  Delete CVP MEMORY ? <input type="button" value="YES"/> <input type="button" value="NO"/> | <p>Ce message apparaît lors de l'exécution d'une opération qui résulte dans l'effacement des données enregistrées dans la RAM interne, telle que la reproduction du logiciel de disquette.</p> <ul style="list-style-type: none"> > Appuyez sur YES pour effacer les données enregistrées sur la RAM interne, puis procédez à l'opération désirée. Appuyez sur la touche NO si vous voulez conserver les données. |
|  Convert to CVP songs ? <input type="button" value="YES"/> <input type="button" value="NO"/> | <p>Ce message apparaît quand vous essayez d'éditer les données ou d'enregistrer sur un logiciel disponible dans le commerce, ou des données enregistrées sur des Clavinova autres que le CVP-94/92/98/96/600.</p> <ul style="list-style-type: none"> > Appuyez sur YES pour convertir les données pour l'enregistrement/l'édition sur le CVP-94/92/98/96/600. Appuyez sur NO lorsque vous ne souhaitez pas convertir les données. |

● Messages se rapportant à la copie de morceau

| | |
|---|--|
|  Number of disk exchange (1) <input type="button" value="OK"/> <input type="button" value="CANCEL"/> | <p>Ce message vous informe du nombre de fois que vous devez changer de disquette pendant la copie d'un morceau sur une disquette différente avant de commencer l'opération de copie de morceau. (Voir page 137 dans le mode d'emploi).</p> |
|  Insert Disk 2. (1 / 3) <input type="button" value="CANCEL"/> | <p>Introduisez la disquette de destination à copier. (Voir page 137 dans le mode d'emploi).</p> |
|  Please select destination songs number. SONG <input type="text" value="1"/> <input type="button" value="OK"/> <input type="button" value="CANCEL"/> | <p>Lorsque vous copiez un morceau d'une disquette source sur une autre disquette, ce message vous invite à spécifier le numéro du morceau sur la disquette de destination sur laquelle le morceau est copié lors de l'insertion de disquette. (Voir page 137 dans le mode d'emploi).</p> |

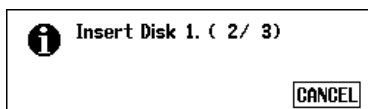

Ce message vous invite à insérer la disquette source lorsque vous copiez des morceaux sur une seconde disquette. (Voir page 137 dans le mode d'emploi).

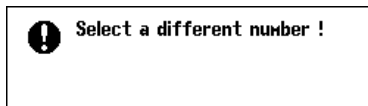

Ce message apparaît quand le même numéro de morceau est sélectionné pour la source comme pour la destination dans l'opération de copie de morceau.

> Changez le numéro de morceau de destination.

● Messages se rapportant au style personnel

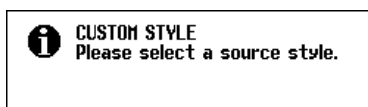

Ce message apparaît pendant quelques secondes lorsque vous appelez le mode de style personnel. (Voir page 68 dans le mode d'emploi).

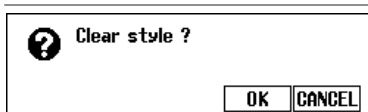

Ce message de confirmation apparaît quand vous essayez de changer le paramètre de temps dans le mode de style personnel. (Voir page 70 dans le mode d'emploi).

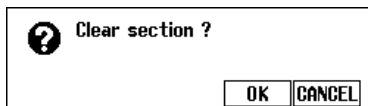

Ce message de confirmation apparaît quand vous essayez de modifier le nombre de mesures dans le mode de style personnel. (Voir page 70 dans le mode d'emploi).

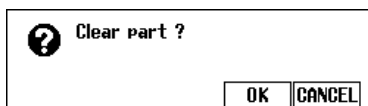

Ce message de confirmation apparaît quand vous essayez de réaliser des opérations qui ne peuvent l'être qu'après l'effacement de la partie de style d'origine dans le mode de style personnel. (Voir page 71 dans le mode d'emploi).

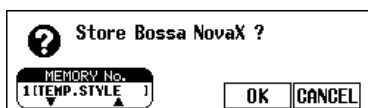

Ce message de confirmation apparaît quand vous essayez de faire une opération de sauvegarde dans le mode de style personnel. (Voir page 74 dans le mode d'emploi). Il apparaît également lorsque vous essayez de changer de style avant de sauvegarder. (Voir page 79 dans le mode d'emploi).

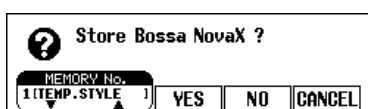

Ce message de confirmation apparaît quand vous essayez de sortir du mode de style personnel avant la sauvegarde des données. (Voir page 79 dans le mode d'emploi).

> Sélectionnez **YES** pour sauvegarder. Appuyez sur **NO** pour sortir sans sauvegarder de données, Appuyez sur **CANCEL** pour revenir à l'afficheur précédent sans sauvegarder de données. (Voir page 79 dans le mode d'emploi).

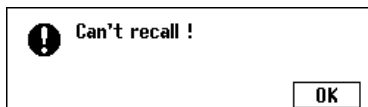

Ce message apparaît quand vous ne pouvez réaliser une opération de rappel de section dans le mode de style personnel parce que la mesure a été modifiée. (Voir page 74 dans le mode d'emploi).

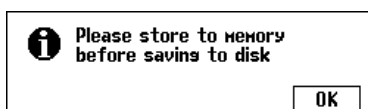

Si les données n'ont pas été sauvegardées dans la mémoire avant d'être sauvegardées sur disquette dans le mode de style personnel, ce message vous invite à sauvegarder avant de continuer. (Voir page 76 dans le mode d'emploi).

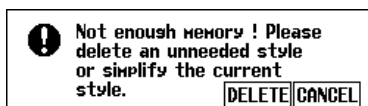

Ce message apparaît quand la capacité de la mémoire interne est insuffisante lors de la sauvegarde des données dans le mode de style personnel. (Voir page 78 dans le mode d'emploi).



Ce message apparaît quand vous sélectionnez DELETE à partir de l'afficheur mentionné ci-dessus.

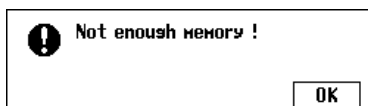

> Sélectionnez le style à effacer et appuyez sur la touche **OK**. Appuyez sur **CANCEL** si vous ne souhaitez pas effacer le style.



Ce message apparaît quand la mémoire devient pleine pendant un enregistrement dans le mode de style personnel. (Voir page 78 dans le mode d'emploi). Il apparaît également quand la mémoire devient pleine pendant l'enregistrement d'un morceau dans la RAM interne. Dans ce cas (OK n'apparaît pas), l'enregistrement s'arrête et les données enregistrées jusqu'à ce point sont automatiquement sauvegardées.

Messages



● Messages se rapportant aux conversions des données enregistrées

| | |
|---|---|
|  2HD disk not valid ! Please copy to 2DD disk. <input type="button" value="OK"/> | Ce message apparaît quand vous utilisez une disquette 2HD pour procéder à la conversion des données enregistrées. > Appuyez sur OK et copiez les données de morceau à convertir sur une disquette 2DD, puis procédez à la conversion en utilisant la disquette. |
|  Completed ! SONG No. 2 | A la suite de la conversion des données, ce message affiche le numéro de morceau sous lequel les données ont été sauvegardées. |



● Messages se rapportant aux changements de données initiales

| | |
|---|--|
|  Write edited data ? <input type="button" value="YES"/> <input type="button" value="NO"/> <input type="button" value="CANCEL"/> | Ce message de confirmation apparaît quand vous essayez de sortir de la fonction d'édition initiale sans écrire les données. > Appuyez sur YES pour écrire les données modifiées. Appuyez sur NO pour sortir sans rien écrire. Appuyez sur CANCEL pour revenir à l'afficheur d'édition initiale sans rien écrire. |
|---|--|





● Messages se rapportant aux séquences d'accord

| | |
|--|--|
|  Save recorded data ? <input type="button" value="YES"/> <input type="button" value="NO"/> <input type="button" value="CANCEL"/> | Ce message de confirmation apparaît quand vous essayez de sortir de la fonction de séquence d'accords pendant l'enregistrement. > Appuyez sur YES pour sauvegarder les données enregistrées. Appuyez sur NO pour sortir sans sauvegarder. Appuyez sur CANCEL pour revenir à l'afficheur de séquence d'accords sans rien sauvegarder. |
|  Button not valid ! Enter at the top of measure. | Ce message apparaît pendant l'enregistrement de la séquence d'accords, quand vous essayez d'introduire un style d'accompagnement ou un changement de section à une position autre que le commencement d'une mesure. > Enregistrez les modifications du style d'accompagnement ou de section seulement au début d'une mesure. (Voir page 118 dans le mode d'emploi). |

● Messages se rapportant au chargement des fichiers de style

| | |
|---|---|
|  Not enough memory ! Delete an unneeded style ? MEMORY No. 118Beat Pop1 (17KB) <input type="button" value="DELETE"/> <input type="button" value="CANCEL"/> | Ce message apparaît quand vous essayez de charger un fichier de style sans qu'il y ait suffisamment de mémoire pour contenir le fichier spécifié. (Voir page 82 dans le mode d'emploi). |
|  Too much data for LISTEN function ! Please load data. | Certains fichiers de données sont trop gros pour que la fonction LISTEN puisse les gérer dans la fonction chargement de fichier de style. (Voir page 81 dans le mode d'emploi). |

● Autres messages

| | |
|--|---|
|  HOST is offline ! | Ce message apparaît lorsque l'ordinateur hôte n'est pas sous tension, lorsque les connexions n'ont pas été effectuées correctement, que le commutateur HOST SELECT ne se trouve pas sur la position appropriée ou que le programme pilote MIDI ou le programme d'application MIDI n'est pas activé. Dans ce cas, mettez le Clavinova et l'ordinateur sous tension puis vérifiez le branchement des câbles et le positionnement du commutateur HOST SELECT. Après s'être assuré que les connexions ont été effectuées correctement et que le commutateur HOST SELECT se trouve bien sur la position appropriée, mettez d'abord l'ordinateur sous tension puis le Clavinova sous tension de manière à vérifier si le programme pilote MIDI et le programme d'application MIDI réagissent normalement. |
|  Back up data erased and replaced by factory data. | Tant que le Clavinova est régulièrement utilisé, les données sont conservées dans la mémoire. Ce message apparaît lorsque vous n'avez pas mis l'instrument sous tension pendant une semaine ou plus et les données sont alors effacées. Ce message apparaît également quand vous rappelez tous les réglages de départ usine. (Voir page 147 dans le mode d'emploi). |
|  Hardware error ! | Un problème est détecté au niveau du système de matériel au moment de la mise sous tension. > Adressez-vous à votre revendeur Yamaha. |
|  Clean the disk head ! <input type="button" value="OK"/> | La tête de disquette est sale. Nettoyez-la avec une disquette de nettoyage de tête disponible dans le commerce. |

Dépistage des pannes

| Problème | Cause | Solution |
|---|--|---|
| Impossible de mettre le Clavinova sous tension. | Les prises du cordon d'alimentation ne sont pas insérées soit dans le Clavinova soit dans la prise murale secteur. | Introduisez fermement l'une des prises du cordon dans l'instrument lui-même et l'autre prise dans une prise murale adéquate. |
| Un dé clic ou un "pop" se produit à la mise sous tension ou hors tension. | Le courant électrique passe dans l'instrument. | C'est un phénomène normal, qui n'est pas un sujet d'inquiétude. |
| L'afficheur à cristaux liquides est trop brillant ou trop foncé pour être lisible. | La brillance est peut-être modifiée par la température ambiante. | Réglez le contraste de l'afficheur en utilisant le bouton de commande [CONTRAST] . (Voir page 15 dans le mode d'emploi). |
| L'afficheur temporaire ne s'ouvre pas. | Le témoin [DISPLAY HOLD] est allumé.. | Appuyez sur la touche [DISPLAY HOLD] afin que le témoin s'éteigne. (Voir page 15 dans le mode d'emploi). |
| Le volume de son du clavier est faible comparé à celui de l'accompagnement automatique ou à celui de la reproduction de disquette. | Le niveau de volume indépendant du son de performance au clavier est trop bas. | Augmentez le volume de la performance au clavier dans l'afficheur Mixer. (Voir page 94 dans le mode d'emploi). |
| Le son de l'accompagnement automatique ou de la reproduction de disquette est faible comparé à celui de la performance au clavier. | [ACMP/SONG VOLUME] est bas. | Augmentez le niveau [ACMP/SONG VOLUME] . |
| L'ensemble du son est faible ou aucun son ne sort. | [MASTER VOLUME] est bas. | Augmentez [MASTER VOLUME] . |
| | Le casque d'écoute est branché. | Débranchez le casque. |
| | La commande locale est désactivée. | Activez la commande locale. (Voir page 144 dans le mode d'emploi). |
| La pédale de sustain est sans effet ou le son est continuellement maintenu, même quand vous n'appuyez pas sur la pédale de sustain. | Le cordon de connexion de la pédale n'est pas raccordé. | Introduisez correctement le cordon de connexion de la pédale dans la bonne prise. (Reportez-vous à la page 41 du présent mode d'emploi du modèle CVP-600 et à la page 49 du mode d'emploi du CVP-98/96.). |
| L'accompagnement automatique ou la reproduction de la disquette ne commence pas. | La synchro MIDI est fixée sur "EXT". | Fixez la synchro MIDI sur "INT". (Voir page 144 dans le mode d'emploi). |
| Quand vous jouez sur le clavier, toutes les notes ne sont pas audibles; | Les notes sont jouées au-delà de la capacité polyphonique simultanée totale (nombre maximum de notes). | Le système de génération de sons est configuré de telle manière que les dernières notes ont priorité, ce qui fait qu'occasionnellement les notes précédentes sont coupées. Reportez-vous à la section "Spécifications" de la page 37 de ce manuel pour toutes les informations sur la capacité polyphonique simultanée. |
| L'accompagnement automatique n'est pas reproduit. | L'accompagnement automatique n'est pas activé. | Appuyez sur la touche [ACMP ON] pour activer l'accompagnement automatique. |

MIDI et la compatibilité des données

■ MIDI

MIDI (Musical Instrument Digital Interface) est une interface standard de communication mondiale qui permet aux instruments de musique et à leurs équipements compatibles MIDI de partager des informations musicales et de se commander les uns les autres.

- Les données transmissibles/recevables varient selon les appareils MIDI et seules les données qui sont communément reconnues parmi les appareils MIDI connectés peuvent être transmises ou reçues. Vous pouvez vérifier si votre instrument accepte certains types de données en vous référant à la feuille d'implantation MIDI dans le mode d'emploi de l'instrument. Vous trouverez la feuille d'implantation MIDI du CVP-98/96/600 page 25 de ce manuel.

Connecteurs MIDI

Les données reçues via le connecteur MIDI IN sont retransmises inchangées via ce connecteur.

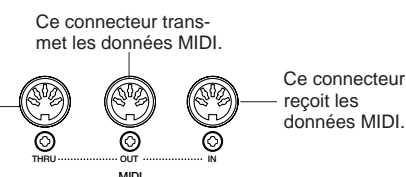

Câble MIDI

Raccordez les appareils MIDI avec les câbles spéciaux MIDI.

- Vous pouvez procéder aux divers réglages MIDI à partir de la section fonction des pages 1 - 3 MIDI.
- Vous trouverez de plus amples informations sur MIDI et ses applications dans les livres et magazines de musique.

■ Compatibilité des données

Cette section couvre les informations de base sur la compatibilité des données : à savoir, si les autres appareils MIDI peuvent ou non reproduire les données enregistrées sur le CVP-98/96/600 et si le CVP-98/96/600 peut ou non reproduire les données de morceaux disponibles dans le commerce ou les données de morceaux créés pour d'autres instruments ou sur un ordinateur.

En fonction de l'appareil MIDI ou des caractéristiques de données, vous pourrez reproduire les données sans problème ou vous devrez procéder à des opérations spéciales avant de pouvoir reproduire ces données. Si vous rencontrez des problèmes pour reproduire vos données, veuillez vous reporter aux informations mentionnées ci-dessous.

● Points de base à vérifier

Les données et les appareils MIDI doivent correspondre au niveau des points indiqués ci-dessous.

- **Format de disquette**
- **Format de séquence**
- **Format d'allocation de voix**

● Format de disquette

Les disquettes sont le moyen de sauvegarde principal des données utilisées avec divers appareils, dont les ordinateurs. Les appareils différents sont dotés de systèmes différents de sauvegarde des données et il est donc nécessaire de configurer tout d'abord la disquette au système de l'appareil utilisé. Cette opération s'appelle le "formatage".

- Il y a deux sortes de disquettes : MF2DD (double face, double densité) et MF2HD (double face, haute densité) et chacun de ces types dispose d'un système de formatage différent.
- Le CVP-98/96/600 peut enregistrer et reproduire avec ces deux types de disquettes.
- Lorsqu'elles sont formatées par le CVP-98/96/600, une disquette 2DD sauvegarde jusqu'à 720 KO (kilo-octets) et une disquette 2HD jusqu'à 1,44 MO (méga-octets). (Les chiffres "720 KO" et "1,44 MO" indiquent la capacité mémoire des disquettes. Ils sont également utilisés pour identifier le type de format de la disquette).

- Vous ne pouvez reproduire que lorsque l'appareil MIDI à utiliser est compatible avec le format de la disquette.

● Format de séquence

Le système qui enregistre les données de morceaux est appelé "format de séquence".

- Vous ne pouvez reproduire que lorsque le format de séquence des disquettes correspond à celui des appareils MIDI.

[Formats de séquence communs]

SMF (Fichier MIDI standard)

C'est le format de séquence le plus commun.

- Les fichiers MIDI standard sont généralement disponibles sous l'un de ces deux types : Format 0 ou Format 1.
- De nombreux appareils MIDI sont compatibles avec le format 0 et la plupart des logiciels disponibles dans le commerce sont enregistrés dans le format 0.
- Le CVP-98/96/600 est compatible avec le format 0 et le format 1 (pour le format 1, jusqu'à un maximum de 17 gros morceaux).
- Les données enregistrées sur le CVP-98/96/600 sont automatiquement enregistrées comme SMF de format 0.

ESEQ

Ce format de séquence est compatible avec de nombreux appareils MIDI de Yamaha, y compris les instruments de la série Clavinova. C'est le format commun utilisé pour différents logiciels Yamaha.

- Le CVP-98/96/600 est compatible avec le format ESEQ.

● Format d'allocation de voix

Avec MIDI, les voix sont assignées à des numéros spécifiques, appelés "numéros de programmes". Le standard de numérotation (ordre d'allocation de voix), est appelé le "format d'allocation de voix".

- La reproduction des voix peut s'avérer différente des résultats escomptés à moins que le format d'allocation de voix des données corresponde à celui de l'appareil MIDI compatible utilisé pour la reproduction.

[Principaux formats d'allocation de voix]

Niveau 1 du système GM

C'est l'un des formats d'allocation de voix les plus courants.

- De nombreux appareils MIDI sont compatibles avec le niveau 1 du système GM, comme la plupart des logiciels disponibles dans le commerce.
- Le CVP-98/96/600 est compatible avec le niveau 1 du système GM.

XG

XG est une amélioration majeure du format de niveau 1 du système GM qui a été développé par Yamaha, spécialement pour offrir plus de voix et de variations, de même qu'une plus grande commande expressive sur les voix et les effets et aussi pour assurer la compatibilité des données dans l'avenir.

- Le CVP-98/96/600 est compatible avec le format XG.
- Les données enregistrées sur le CVP-98/96/600 reçoivent automatiquement une allocation de voix XG.

DOC











Ce format d'allocation de voix est compatible avec de nombreux appareils MIDI de Yamaha, y compris les instruments de la série Clavinova. C'est aussi un format commun utilisé avec les divers logiciels Yamaha.









- Le CVP-98/96/600 est compatible avec le format DOC.

Même quand les appareils et les données satisfont à toutes les conditions mentionnées ci-dessus, les données pas toujours entièrement compatibles, en fonction des spécifications des appareils et notamment des méthodes d'enregistrement des données.



Mensajes













● Mensajes comunes

| | |
|---|--|
|  No disk ! | <p>Este mensaje aparece cuando no hay ningún disco en la unidad de discos.</p> <p>➤ Ponga el disco apropiado en la unidad de discos y vuelva a intentar la operación</p> |
|  No songs ! | <p>Cuando cambia el nombre de la canción original o convierte los datos, aparecerá este mensaje para avisarle que no hay datos de canción.</p> <p>➤ Seleccione una canción que contenga datos, o inserte un disco con datos de canción en la unidad de discos flexibles.</p> |
|  No file ! | <p>Este mensaje aparece si no hay datos de la memoria de registros, de microafinación, ni otros datos relacionados en el disco actualmente insertado cuando usted intenta hacer una operación relacionada con archivos.</p> <p>➤ Cree un archivo o inserte un disco con un archivo adecuado.</p> |
|  Start disk format ? <input type="button" value="OK"/> <input type="button" value="CANCEL"/> | <p>Este mensaje aparece cuando se ha insertado en la unidad de discos un disco nuevo o un disco que no está formateado para la Clavinova. (Vea la página 106 del manual de instrucciones.)</p> <p>➤ Presione OK si desea formatear el disco. Presione CANCEL si desea abortar el proceso de formato.</p> |
|  Protected disk ! | <p>Este mensaje aparece cuando usted intenta grabar o efectuar otras operaciones de archivos en un disco cuyo lengüeta de protección contra escritura está colocada en el lado de "protección contra escritura".</p> <p>➤ Ajuste la lengüeta de protección contra escritura en la posición de escritura permitida (página 7 del manual de instrucciones) e intente de nuevo la operación. Si todavía no puede realizarse la operación, significa que el disco tiene en sí protección interna, haciendo imposible las operaciones de escritura o de archivos en el disco.</p> |
|  Protected songs ! | <p>Este mensaje aparece cuando se intentan grabar partes u otras operaciones de archivos que no son compatible o que no permiten tales operaciones. Dependiendo del tipo de archivo, las operaciones tales como las de grabación adicional, copiado, borrado, etc. pueden resultar imposibles en la CVP-98/96/600.</p> |
|  Disk read/write error ! <input type="button" value="OK"/> | <p>Ha ocurrido un error durante la escritura (como por ejemplo al grabar o almacenar archivos) o al leer del disco.</p> <p>➤ Intente de nuevo la operación después de presionar el botón OK. Si el error vuelve a ocurrir, significa que el disco o la unidad de discos están defectuosos. Si usted sospecha que la unidad de discos está defectuosa, mencione este problema a su distribuidor Yamaha.</p> |
|  Completed ! | <p>Aparece durante algunos segundos cuando se ha terminado una operación que lleva cierto tiempo en completarse como por ejemplo las de formato, copiado de canciones, etc.</p> |
|  Don't remove the disk ! | <p>Este mensaje aparece cuando los datos se transfieren entre la Clavinova y el disco.</p> <p>➤ El mensaje desaparece automáticamente cuando se termina la operación.</p> |
|  Are you sure ? <input type="button" value="YES"/> <input type="button" value="NO"/> | <p>Cuando se seleccionan operaciones tales como las de borrado de canciones o de formato, este mensaje le hace confirmar si desea proseguir o no con la operación.</p> <p>➤ Presione YES para ejecutar la operación. Presione NO para volver a la visualización anterior.</p> |
|  Disk full ! <input type="button" value="OK"/> | <p>El disco actualmente insertado está lleno y no tiene espacio para almacenar más datos.</p> <p>➤ Presione el botón OK, y borre los datos que no sean necesarios del disco (página 138 del manual de instrucciones), o emplee un disco que tenga más espacio libre disponible. Si aparece durante la grabación de canciones (en este caso no aparecerá OK), la grabación se detendrá y los datos grabados hasta ese punto se almacenarán automáticamente.</p> |

| | |
|--|--|
|  Too many files ! <input type="button" value="OK"/> | <p>Un disco del tipo 2DD o del tipo 2HD tiene cabida para 60 archivos de canciones. Un disco 2DD tiene cabina para unos 110 archivos (de varios tipos), y un disco 2HD tiene cabina para unos 220 archivos.</p> <p>Este mensaje aparece cuando se intentan producir más archivos de los que es capaz el disco.</p> <ul style="list-style-type: none"> > Presione el botón OK, y borre los archivos innecesarios del disco (página 138 del manual de instrucciones), o emplee un disco que tenga más espacio disponible. |
|  Same name ! Overwrite ? <input type="button" value="OK"/> <input type="button" value="CANCEL"/> | <p>Existe un nombre con el mismo archivo.</p> <ul style="list-style-type: none"> > Presione el botón OK si desea sobrescribir el archivo original con los datos nuevos, o presione CANCEL para abortar la operación. |
|  This button can't be used during recording or playback ! | <p>Este mensaje aparece cuando se intentan efectuar operaciones que no pueden hacerse durante la grabación o reproducción, tales como las de conversión de datos, formateado, etc.</p> <ul style="list-style-type: none"> > Detenga la grabación o reproducción, o salga del modo de grabación/reproducción, y efectúe entonces la operación. |
|  This button can't be used during playback ! | <p>Este mensaje aparece cuando se intentan efectuar otras operaciones mientras se leen o almacenan datos en el disco.</p> <ul style="list-style-type: none"> > Detenga la reproducción de la canción, o salga del modo de reproducción, y efectúe entonces la operación. |
|  Button not valid ! | <p>Se ha presionado un botón que no tiene una función en el modo actual.</p> |
|  Disk read/write operation in process ! | <p>Este mensaje aparece cuando se intentan ejecutar otras operaciones mientras se leen o almacenan datos en el disco.</p> <ul style="list-style-type: none"> > Espere a que se termine la operación de lectura/escritura de datos, y efectúe entonces la operación. |
|  Memory write operation in process ! | <p>Este mensaje aparece cuando se intentan ejecutar otras operaciones mientras se escriben datos editados de una canción grabada en la RAM interna.</p> <ul style="list-style-type: none"> > Complete la operación de escritura de datos y luego efectúe la otra operación. |
|  Delete CVP MEMORY ? <input type="button" value="YES"/> <input type="button" value="NO"/> | <p>Este mensaje aparece cuando se ejecuta una operación que ocasiona el borrado de los datos grabados en la RAM interna, como por ejemplo la reproducción de programas de discos.</p> <ul style="list-style-type: none"> > Presione YES para borrar los datos grabados en la RAM interna, y efectúe entonces la operación deseada. Presione el botón NO si desea conservar los datos. |
|  Convert to CVP songs ? <input type="button" value="YES"/> <input type="button" value="NO"/> | <p>Este mensaje aparece cuando se intenta grabar encima de datos de edición o de programas de venta en el mercado, o datos grabados en otras Clavinovas que no son las CVP-94/92/98/96/600.</p> <ul style="list-style-type: none"> > Presione YES para convertir los datos para grabación/edición en las CVP-94/92/98/96/600. Presione NO si no desea convertir los datos. |

● Mensajes relacionados con el copiado de canciones

| | |
|--|--|
|  Number of disk exchange (1) <input type="button" value="OK"/> <input type="button" value="CANCEL"/> | <p>Este mensaje le informa de las veces que los discos deben intercambiarse cuando se copia una canción a otro disco antes de empezar la operación de copiado de discos. (Vea la página 137 del manual de instrucciones.)</p> |
|  Insert Disk 2. (1 / 3) <input type="button" value="CANCEL"/> | <p>Inserte el disco de destino a copiarse. (Vea la página 137 del manual de instrucciones.)</p> |
|  Please select destination song number. <div style="border: 1px solid black; padding: 2px; display: inline-block;">SONG 11</div> <input type="button" value="OK"/> <input type="button" value="CANCEL"/> | <p>Cuando copia una canción del disco de origen a otro disco, este mensaje le indica que especifique el número de canción en el disco de destino al que debe copiarse la canción, cuando se inserta primero el disco. (Vea la página 137 del manual de instrucciones.)</p> |

| | |
|---|---|
|  Insert Disk 1. (2 / 3) <input type="button" value="CANCEL"/> | <p>Este mensaje le indica que inserte el disco de origen cuando copie canciones a un segundo disco. (Vea la página 137 del manual de instrucciones.)</p> |
|  Select a different number ! | <p>Aparece cuando se selecciona el mismo número de canción para el origen y destino en la operación de copiado de canciones.</p> <p>➤ Cambie el número de canción de destino.</p> |
| <h2>● Mensajes relacionados con los estilos de usuario</h2> | |
|  CUSTOM STYLE Please select a source style. | <p>Este mensaje aparece durante algunos segundos cuando se activa el modo de estilos del usuario. (Vea la página 68 del manual de instrucciones.)</p> |
|  Clear style ? <input type="button" value="OK"/> <input type="button" value="CANCEL"/> | <p>Este mensaje de confirmación aparece cuando se intenta cambiar el parámetro del tiempo en el modo de estilo de usuario. (Vea la página 70 del manual de instrucciones.)</p> |
|  Clear section ? <input type="button" value="OK"/> <input type="button" value="CANCEL"/> | <p>Este mensaje de confirmación aparece cuando se intenta cambiar el número de compases en el modo de estilo de usuario. (Vea la página 70 del manual de instrucciones.)</p> |
|  Clear part ? <input type="button" value="OK"/> <input type="button" value="CANCEL"/> | <p>Este mensaje de confirmación aparece cuando se intenta efectuar alguna operación que sólo puede hacerse después de borrar la parte del estilo original en el modo de estilos del usuario. (Vea la página 71 del manual de instrucciones.)</p> |
|  Store Bossa NovaX ? MEMORY No. 1 TEMP. STYLE 1 <input type="button" value="OK"/> <input type="button" value="CANCEL"/> | <p>Este mensaje de confirmación aparece cuando se intenta una operación de almacenamiento en el modo de estilos de usuario. (Vea la página 74 del manual de instrucciones.) También aparece cuando se intenta cambiar de estilo antes del almacenamiento. (Vea la página 79 del manual de instrucciones.)</p> |
|  Store Bossa NovaX ? MEMORY No. 1 TEMP. STYLE 1 <input type="button" value="YES"/> <input type="button" value="NO"/> <input type="button" value="CANCEL"/> | <p>Este mensaje de confirmación aparece cuando se intenta salir del modo de estilos de usuario antes de almacenar los datos. (Vea la página 79 del manual de instrucciones.)</p> <p>➤ Seleccione YES para almacenarlos. Presione NO para salir sin almacenar los datos. Presione CANCEL para volver a la visualización anterior sin almacenar los datos. (Vea la página 79 del manual de instrucciones.)</p> |
|  Can't recall ! <input type="button" value="OK"/> | <p>Este mensaje aparece cuando no puede efectuarse la operación de la sección de llamada del modo de estilos del usuario, debido a cambios en la signatura de tiempo (tiempo). (Vea la página 74 del manual de instrucciones.)</p> |
|  Please store to memory before saving to disk <input type="button" value="OK"/> | <p>Si los datos no se han puesto en la memoria antes de su almacenamiento en el disco en el modo de estilos del usuario, este mensaje le indica que ponga los datos en la memoria antes de proseguir. (Vea la página 76 del manual de instrucciones.)</p> |
|  Not enough memory ! Please delete an unneeded style or simplify the current style. <input type="button" value="DELETE"/> <input type="button" value="CANCEL"/> | <p>Este mensaje aparece cuando no hay suficiente espacio de memoria interna para almacenar los datos en el modo de estilos del usuario. (Vea la página 78 del manual de instrucciones.)</p> |
|  Delete style ? MEMORY No. 1 188Beat Pop1 17KB <input type="button" value="OK"/> <input type="button" value="CANCEL"/> | <p>Este mensaje aparece cuando se selecciona DELETE desde la visualización arriba mostrada.</p> <p>➤ Seleccione el estilo a borrarse y presione el botón OK. Presione CANCEL si no desea borrar el estilo.</p> |
|  Not enough memory ! <input type="button" value="OK"/> | <p>Este mensaje aparece cuando la capacidad de la memoria se ha llenado durante la grabación en el modo de estilos del usuario (página 78 del manual de instrucciones.) También aparece cuando se ha llenado la memoria durante la grabación de una canción en la RAM interna. En este caso (OK no aparece), la grabación se parará y los datos grabados hasta ese punto se almacenarán automáticamente.</p> |

● Mensajes relacionados con la conversión de datos grabados

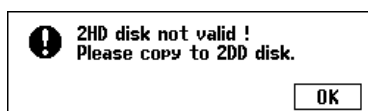

Este mensaje aparece si se emplea un disco 2HD para efectuar la conversión de los datos grabados.

- Presione **OK** y copie los datos de canción a convertirse a un disco 2DD, y efectúe entonces la conversión de datos empleando el disco.

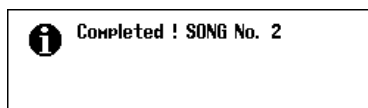

Después de la conversión de los datos de canción, aparece este mensaje mostrando el número de la canción en la que se han almacenado los datos.

● Mensajes relacionados con cambios de datos iniciales

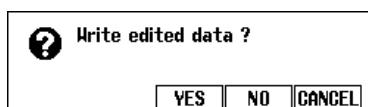

Este mensaje de confirmación aparece si intenta salir de la función de edición inicial sin escribir los datos.

- Presione **YES** para escribir los datos cambiados. Presione **NO** para salir sin escribirlos. Presione **CANCEL** para volver a la visualización de edición inicial sin escribirlos.

● Mensajes relacionados con secuencias de acordes

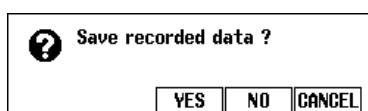

Este mensaje de confirmación aparece si intenta salir de la función de secuencias de acordes durante la grabación.

- Presione **YES** para almacenar los datos grabados. Presione **NO** para salir sin almacenarlos. Presione **CANCEL** para volver a la visualización de secuencia de acordes sin almacenar.

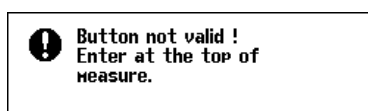

Este mensaje aparece durante la grabación de secuencias de acordes cuando se intenta introducir un estilo de acompañamiento o cambio de sección en una posición que no es el principio de un compás.

- Grabe los cambios de estilo de acompañamiento o de sección sólo al principio del compás. (Vea la página 118 del manual de instrucciones.)

● Mensajes relacionados con la carga de archivos de estilos

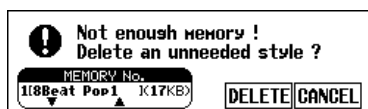

Este mensaje aparece cuando se intenta cargar un archivo de estilos sin haber suficiente memoria para el archivo especificado. (Vea la página 82 del manual de instrucciones.)

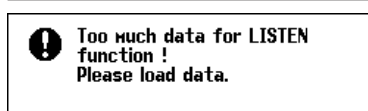

Algunos archivos de estilos son demasiado grandes para poder ser manipulados por la característica **LISTEN** de la función de carga de archivos de estilos. (Vea la página 81 del manual de instrucciones.)

● Otros mensajes

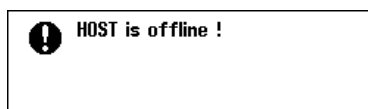

Este mensaje aparece cuando el ordenador principal no tiene la alimentación conectada, cuando el selector **HOST SELECT** no está en la posición correcta, o cuando el driver de MIDI o la aplicación MIDI no están activados. En este caso, desconecte la alimentación de la Clavinova y del ordenador, y compruebe la conexión del cable y la posición del selector **HOST SELECT**. Una vez ha verificado la conexión y la posición del selector **HOST SELECT**, conecte primero la alimentación del ordenador y luego la de la Clavinova, para comprobar si el driver de MIDI y la aplicación MIDI funcionan correctamente.

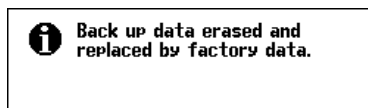

Mientras se emplee regularmente la Clavinova, los datos se retienen en la memoria. Si se deja sin utilizar el instrumento durante una semana o período más largo antes de volver a conectar la alimentación, los datos se borran y aparece este mensaje. Este mensaje también aparece cuando usted activa todos los datos de fábrica. (Vea la página 147 del manual de instrucciones.)



Se ha detectado un problema en el sistema del hardware durante la conexión de la alimentación.

- Pregunte a su distribuidor Yamaha sobre este problema.

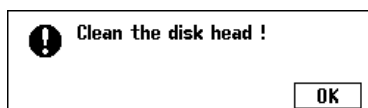

La cabeza del disco está sucia. Limpie la cabeza del disco empleando un disco de limpieza de cabezas de venta en las tiendas del ramo.

Localización y reparación de averías.....

| Problema | Causa | Solución |
|---|--|---|
| La alimentación de la Clavinova no se conecta. | Las clavijas del cable de la alimentación no están insertadas en la Clavinova o en la toma de corriente de CA. | Inserte bien una de las clavijas del cable en el instrumento y la otra en una toma adecuada de corriente de CA. |
| Suena un sonido seco o de ruido cuando se conecta/desconecta la alimentación. | Circula la corriente eléctrica al instrumento. | Esto es normal, y no hay por qué preocuparse. |
| El visualizador LCD tiene demasiado brillo o es demasiado oscuro para leerse. | El brillo puede cambiar debido a la temperatura ambiental. | Ajuste el contraste del visualizador empleando el control [CONTRAST] . (Vea la página 15 del manual de instrucciones.) |
| La pantalla instantánea no se abre. | La lámpara [DISPLAY HOLD] está encendida. | Presione el botón [DISPLAY HOLD] para que se apague la lámpara. (Vea la página 15 del manual de instrucciones.) |
| El volumen del sonido del teclado es bajo en comparación con el del acompañamiento automático o de la reproducción de discos. | El nivel de volumen independiente del sonido de interpretación del teclado tiene un ajuste demasiado bajo. | Suba el volumen de interpretación del teclado en la visualización de MIXER . (Vea la página 94 del manual de instrucciones.) |
| El sonido del acompañamiento automático o de la reproducción de discos es bajo en comparación con el del teclado. | El ajuste de [ACMP/SONG VOLUME] es bajo. | Aumente el nivel de [ACMP/SONG VOLUME] . |
| Todo el sonido es bajo o no sale sonido. | El ajuste de [MASTER VOLUME] es bajo. | Aumente el nivel de [MASTER VOLUME] . |
| | Los auriculares están conectados. | Desconecte los auriculares. |
| | El control local está desactivado. | Active el control local. (Vea la página 144 del manual de instrucciones.) |
| El pedal apagador no tiene ningún efecto, o el sonido se sostiene continuamente incluso cuando no se pisa el pedal. | La clavija del cable del pedal no está enchufada. | Inserte correctamente la clavija del cable del pedal en la toma adecuada. (Vea la página 41 de este manual para la CVP-600, y la página 49 para la CVP-98/96.) |
| El acompañamiento automático o la reproducción de discos no se inician. | MIDI Sync se ha ajustado a "EXT". | Ajuste MIDI Sync a "INT." (Vea la página 144 del manual de instrucciones.) |
| Cuando se toca el teclado, no suenan todas las notas. | Se han tocado notas que exceden la capacidad de polifonía simultánea del teclado (número máximo de notas). | El sistema de generación de notas está configurado de modo que las últimas notas tienen prioridad, pudiendo provocar el corte de notas anteriores. Vea la sección de "Especificaciones" de la página 37 de este manual para encontrar información sobre la capacidad polifónica simultánea. |
| No se reproduce el acompañamiento automático. | El acompañamiento automático no está activado. | Presione el botón [ACMP ON] para activar el acompañamiento automático. |

| Problema | Causa | Solución |
|--|---|--|
| El acorde deseado no se reconoce o no se emite con el acompañamiento automático. | Las teclas no se tocan correctamente. | Consulte la “Gráfica de digitado” (página 36 de este manual). |
| | Las teclas no se tocan de acuerdo con el tipo de acompañamiento automático seleccionado. | Compruebe el tipo del acompañamiento automático, y toque las teclas de acuerdo con el tipo seleccionado. (Vea la página 56 del manual de instrucciones.) |
| No pueden grabarse el máximo de 60 canciones. | La capacidad de la memoria está llena porque el tiempo de interpretación de una o más canciones es largo, o porque se han usado muchas funciones. | Borre las canciones innecesarias (página 138 del manual de instrucciones) o grabe en un disco nuevo. |
| Algunas pistas no se reproducen durante la reproducción de datos. | Se ha desactivado la reproducción de las pistas. | Active la reproducción de las pistas que no suenan. (Vea las páginas 91, 94 del manual de instrucciones.) |



- * Si aparece un mensaje de “Hardware Error!” en el visualizador cuando se conecta la alimentación, póngase en contacto inmediatamente con el distribuidor Yamaha porque indica algún tipo de daño interno del instrumento.

MIDI y compatibilidad de datos

■ MIDI

MIDI (interfaz digital de instrumentos musicales) es una interfaz de comunicaciones de normas internacionales que permite a instrumentos y equipos musicales compatibles con MIDI intercambiar y compartir información y control musical.

- Dependiendo del dispositivo MIDI, los datos que pueden transmitirse/recibirse son distintos, y sólo los datos que normalmente se reconocen entre los dispositivos MIDI conectados pueden transmitirse y recibirse. Podrá comprobar si su instrumento apoya ciertos tipos de datos consultando la gráfica de implementación MIDI del manual de instrucciones del instrumento. La gráfica de implementación MIDI de la CVP-98/96/600 está en la página 25 de este manual.

Terminales MIDI

Los datos recibidos a través del terminal MIDI IN se retransmiten sin cambiar por este terminal.

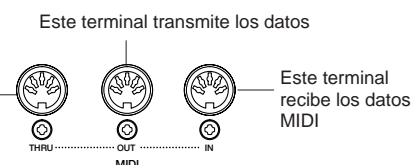

Cable MIDI

Conecte los dispositivos MIDI con cables MIDI especiales.

- Pueden hacerse varios ajustes MIDI desde las páginas MIDI 1 - 3 de la sección de "Function".
- Para más información sobre MIDI y sus aplicaciones, consulte libros y revistas musicales.

■ Compatibilidad de datos

Esta sección abarca la información básica sobre la compatibilidad de datos: si otros dispositivos MIDI pueden reproducir los datos granados con la CVP-98/96/600, y si la CVP-98/96/600 puede reproducir datos de canciones de venta en las tiendas del ramo creados para otros instrumentos o en un ordenador.

Dependiendo de las características del dispositivo MIDI o de los datos, es posible reproducir los datos sin ningún problema, o es posible que se tengan que realizar operaciones especiales antes de reproducir los datos. Si tiene algún problema con la reproducción de datos, consulte la información siguiente.

● Puntos básicos de comprobación

Los datos y el dispositivo MIDI deben corresponderse en cuanto a los puntos siguientes.

- Formato de disco
- Formato de secuencias
- Formato de asignación de voces

● Formato de disco

Los discos flexibles son un medio de almacenamiento principal para datos y se emplean con varios dispositivos, incluyendo ordenadores. Los dispositivos tienen sistemas diferentes para almacenar los datos, por lo que es necesario primero configurar el disco flexible para el dispositivo en el que se va a utilizar. Esta operación se denomina "formateado".

- Hay dos tipos de discos flexibles: MF2DD (dos caras, densidad doble) y MF2HD (dos caras, alta densidad), y cada uno tiene sistemas de formateado distintos.
- La CVP-98/96/600 puede grabar y reproducir en ambos tipos de discos flexibles.
- Los discos 2DD, cuando se han formateado con la CVP-98/96/600, tienen una capacidad de 720 KB (kilobytes) y un disco 2HD puede almacenar hasta 1,44 MB (megabytes). (Los números de "720 KB" y "1,44 MB" indican la capacidad de memoria de datos. También se emplean para indicar el tipo de formato del disco.)
- La reproducción sólo es posible cuando el dispositivo MIDI a utilizarse es compatible con el formato del disco.

● Formato de secuencias

El sistema que graba datos de canción se denomina "formato de secuencias".

- La reproducción sólo es posible cuando el formato de secuencias del disco corresponde con el del dispositivo MIDI.

[Formatos de secuencias comunes]

SMF (archivo MIDI estándar)

Este es el formato de secuencias más común.

- Los archivos MIDI estándar están normalmente disponibles en uno de los dos tipos: Formato 0 o formato 1.
- Muchos dispositivos MIDI son compatibles con el formato 0, y la mayor parte de programas de venta en las tiendas del ramo están grabados en el formato 0.
- La CVP-98/96/600 es compatible con ambos formatos, el 0 y el 1 (para el formato 1, hasta un máximo de 17 bloques de información).
- Los datos de canción grabados en la CVP-98/96/600 se graban automáticamente en el formato 0 de SMF.

ESEQ

Este formato de secuencias es compatible con muchos de los dispositivos MIDI Yamaha, incluyendo instrumentos de la serie de la Clavinova. Es un formato común empleado con varios programas de Yamaha.

- La CVP-98/96/600 es compatible con ESEQ.

● Formato de asignación de voces

Con el sistema MIDI, las voces se asignan a números específicos, denominados "números de programa". La norma de numeración (orden de asignación de voces) se denomina "formato de asignación de voces".

- Es posible que las voces no se reproduzcan como se espera a menos que el formato de asignación de voces de los datos de canción corresponda con el del dispositivo MIDI compatible utilizado para la reproducción.

[Formatos principales de asignación de voces]

Sistema GM de nivel 1

Este es uno de los formatos de asignación de voces más comunes.

- Muchos dispositivos MIDI son compatibles con el sistema GM de nivel 1, así como la mayor parte de programas de venta en las tiendas del ramo.
- La CVP-98/96/600 es compatible con el sistema GM de nivel 1.

XG

XG es una mejora importante del formato del sistema GM de nivel 1, y fue desarrollado por Yamaha especialmente para proporcionar más voces y variaciones, así como mayor control de la expresión de voces y efectos, y para asegurar compatibilidad de datos para el futuro.

- La CVP-98/96/600 es compatible con XG.
- Los datos de canción grabados en la CVP-98/96/600 reciben automáticamente asignación de voces XG.

DOC

Este formato de asignación de voces es compatible con muchos de los dispositivos MIDI de Yamaha, incluyendo los instrumentos de la serie de la Clavinova.

Este formato también es comúnmente empleado en los programas de Yamaha de venta en las tiendas del ramo.

- La CVP-98/96/600 es compatible con DOC.

Aunque los dispositivos y datos empleados satisfagan todas las condiciones de arriba, es posible que los datos no acaben de ser compatibles del tono, dependiendo de las especificaciones de los dispositivos y métodos particulares de grabación de los datos.

MIDI Data Format / MIDI-Datenformat / Format des données MIDI / Formato de datos MIDI

Many MIDI messages listed in the MIDI Data Format are expressed in decimal numbers, binary numbers and hexadecimal numbers. Hexadecimal numbers may include the letter "H" as a suffix. Also, "n" can freely be defined as any whole number.

To enter data/values, refer to the table below.

| Decimal | Hexadecimal | Binary | Decimal | Hexadecimal | Binary |
|---------|-------------|-----------|---------|-------------|-----------|
| 0 | 00 | 0000 0000 | 64 | 40 | 0100 0000 |
| 1 | 01 | 0000 0001 | 65 | 41 | 0100 0001 |
| 2 | 02 | 0000 0010 | 66 | 42 | 0100 0010 |
| 3 | 03 | 0000 0011 | 67 | 43 | 0100 0011 |
| 4 | 04 | 0000 0100 | 68 | 44 | 0100 0100 |
| 5 | 05 | 0000 0101 | 69 | 45 | 0100 0101 |
| 6 | 06 | 0000 0110 | 70 | 46 | 0100 0110 |
| 7 | 07 | 0000 0111 | 71 | 47 | 0100 0111 |
| 8 | 08 | 0000 1000 | 72 | 48 | 0100 1000 |
| 9 | 09 | 0000 1001 | 73 | 49 | 0100 1001 |
| 10 | 0A | 0000 1010 | 74 | 4A | 0100 1010 |
| 11 | 0B | 0000 1011 | 75 | 4B | 0100 1011 |
| 12 | 0C | 0000 1100 | 76 | 4C | 0100 1100 |
| 13 | 0D | 0000 1101 | 77 | 4D | 0100 1101 |
| 14 | 0E | 0000 1110 | 78 | 4E | 0100 1110 |
| 15 | 0F | 0000 1111 | 79 | 4F | 0100 1111 |
| 16 | 10 | 0001 0000 | 80 | 50 | 0101 0000 |
| 17 | 11 | 0001 0001 | 81 | 51 | 0101 0001 |
| 18 | 12 | 0001 0010 | 82 | 52 | 0101 0010 |
| 19 | 13 | 0001 0011 | 83 | 53 | 0101 0011 |
| 20 | 14 | 0001 0100 | 84 | 54 | 0101 0100 |
| 21 | 15 | 0001 0101 | 85 | 55 | 0101 0101 |
| 22 | 16 | 0001 0110 | 86 | 56 | 0101 0110 |
| 23 | 17 | 0001 0111 | 87 | 57 | 0101 0111 |
| 24 | 18 | 0001 1000 | 88 | 58 | 0101 1000 |
| 25 | 19 | 0001 1001 | 89 | 59 | 0101 1001 |
| 26 | 1A | 0001 1010 | 90 | 5A | 0101 1010 |
| 27 | 1B | 0001 1011 | 91 | 5B | 0101 1011 |
| 28 | 1C | 0001 1100 | 92 | 5C | 0101 1100 |
| 29 | 1D | 0001 1101 | 93 | 5D | 0101 1101 |
| 30 | 1E | 0001 1110 | 94 | 5E | 0101 1110 |
| 31 | 1F | 0001 1111 | 95 | 5F | 0101 1111 |
| 32 | 20 | 0010 0000 | 96 | 60 | 0110 0000 |
| 33 | 21 | 0010 0001 | 97 | 61 | 0110 0001 |
| 34 | 22 | 0010 0010 | 98 | 62 | 0110 0010 |
| 35 | 23 | 0010 0011 | 99 | 63 | 0110 0011 |
| 36 | 24 | 0010 0100 | 100 | 64 | 0110 0100 |
| 37 | 25 | 0010 0101 | 101 | 65 | 0110 0101 |
| 38 | 26 | 0010 0110 | 102 | 66 | 0110 0110 |
| 39 | 27 | 0010 0111 | 103 | 67 | 0110 0111 |
| 40 | 28 | 0010 1000 | 104 | 68 | 0110 1000 |
| 41 | 29 | 0010 1001 | 105 | 69 | 0110 1001 |
| 42 | 2A | 0010 1010 | 106 | 6A | 0110 1010 |
| 43 | 2B | 0010 1011 | 107 | 6B | 0110 1011 |
| 44 | 2C | 0010 1100 | 108 | 6C | 0110 1100 |
| 45 | 2D | 0010 1101 | 109 | 6D | 0110 1101 |
| 46 | 2E | 0010 1110 | 110 | 6E | 0110 1110 |
| 47 | 2F | 0010 1111 | 111 | 6F | 0110 1111 |
| 48 | 30 | 0011 0000 | 112 | 70 | 0111 0000 |
| 49 | 31 | 0011 0001 | 113 | 71 | 0111 0001 |
| 50 | 32 | 0011 0010 | 114 | 72 | 0111 0010 |
| 51 | 33 | 0011 0011 | 115 | 73 | 0111 0011 |
| 52 | 34 | 0011 0100 | 116 | 74 | 0111 0100 |
| 53 | 35 | 0011 0101 | 117 | 75 | 0111 0101 |
| 54 | 36 | 0011 0110 | 118 | 76 | 0111 0110 |
| 55 | 37 | 0011 0111 | 119 | 77 | 0111 0111 |
| 56 | 38 | 0011 1000 | 120 | 78 | 0111 1000 |
| 57 | 39 | 0011 1001 | 121 | 79 | 0111 1001 |
| 58 | 3A | 0011 1010 | 122 | 7A | 0111 1010 |
| 59 | 3B | 0011 1011 | 123 | 7B | 0111 1011 |
| 60 | 3C | 0011 1100 | 124 | 7C | 0111 1100 |
| 61 | 3D | 0011 1101 | 125 | 7D | 0111 1101 |
| 62 | 3E | 0011 1110 | 126 | 7E | 0111 1110 |
| 63 | 3F | 0011 1111 | 127 | 7F | 0111 1111 |

- Except the table above, for example 144-159(decimal)/9nH/1001 0000-1001 1111(binary) displays the Note On Message for each channel (1-16). 176-191/ BnH/1011 0000-1011 1111 displays the Control Change Message for each channel (1-16). 192-207/CnH/1100 0000-1100 1111 displays the Program Change Message for each channel (1-16). 240/FOH/1111 0000 denotes the start of a System Exclusive Message. 247/F7H/1111 0111 denotes the end of a System Exclusive Message.
- aaH (hexadecimal)/0aaaaaaa (binary) denotes the data address. The address contains High, Mid, and Low.
- bbH/0bbbbbbb denotes the byte count.
- ccH/0ccccccc denotes the check sum.
- ddH/0ddddddd denotes the data/value.

(1) TRANSMIT FLOW

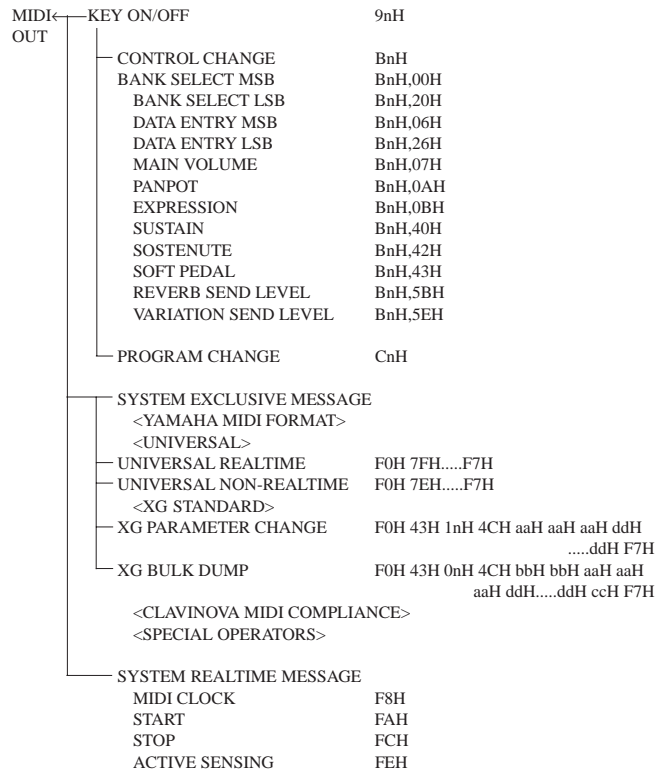

(2) RECEIVE FLOW

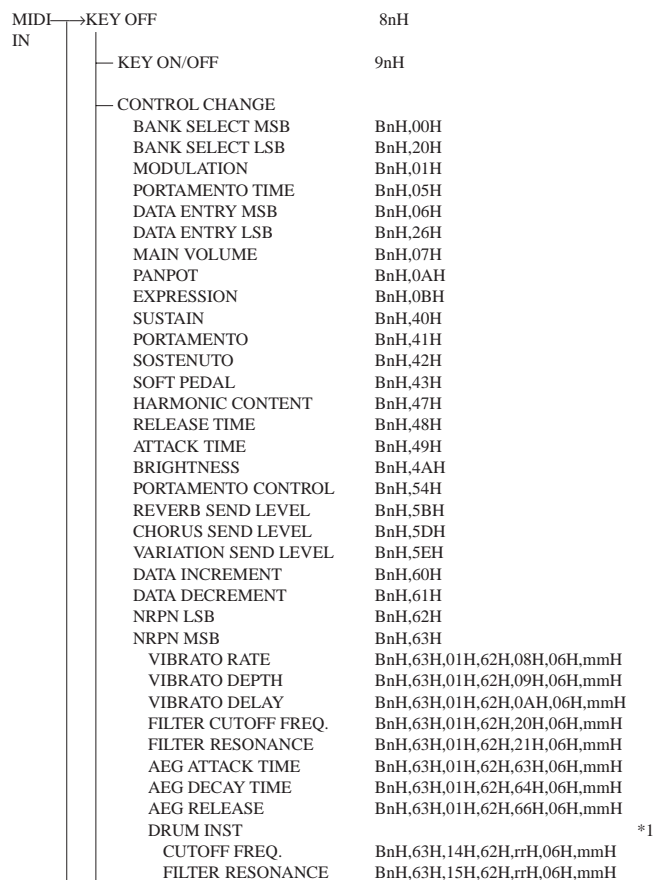

*1

| | |
|-----------------------------|--|
| AEG ATTACK RATE | BnH,63H,16H,62H,rrH,06H,mmH |
| AEG DECAY RATE | BnH,63H,17H,62H,rrH,06H,mmH |
| PITCH COARSE | BnH,63H,18H,62H,rrH,06H,mmH |
| PITCH FINE | BnH,63H,19H,62H,rrH,06H,mmH |
| LEVEL | BnH,63H,1AH,62H,rrH,06H,mmH |
| PANPOT | BnH,63H,1CH,62H,rrH,06H,mmH |
| REVERB SEND | BnH,63H,1DH,62H,rrH,06H,mmH |
| CHORUS SEND | BnH,63H,1EH,62H,rrH,06H,mmH |
| VARIATION SEND | BnH,63H,1FH,62H,rrH,06H,mmH |
| RPN LSB | BnH,64H |
| RPN MSB | BnH,65H |
| PITCH BEND SENS. | BnH,65H,00H,64H,00H,06H,mmH |
| FINE TUNING | BnH,65H,00H,64H,01H,06H,mmH, 26H,IlH |
| COARSE TUNING | BnH,65H,00H,64H,02H,06H,mmH |
| NULL | BnH,65H,7FH,64H,7FH |
| ALL SOUND OFF | BnH,78H,00H |
| RESET ALL CONTROLLERS | BnH,79H,00H |
| ALL NOTES OFF | BnH,7BH,00H |
| OMNI OFF | BnH,7CH,00H |
| OMNI ON | BnH,7DH,00H |
| MONO | BnH,7EH |
| POLY | BnH,7FH |
| PROGRAM CHANGE | CnH |
| CHANNEL AFTER TOUCH | DnH |
| PITCH BEND CHANGE | EnH |
| SYSTEM EXCLUSIVE MESSAGE | |
| <YAMAHA MIDI FORMAT> | |
| <UNIVERSAL> | |
| UNIVERSAL REALTIME | F0H 7FH.....F7H |
| UNIVERSAL NON-REALTIME | F0H 7EH.....F7H |
| <XG STANDARD> | |
| XG PARAMETER CHANGE | F0H 43H 1nH 4CH aaH aaH aaH ddHddH F7H |
| XG BULK DUMP | F0H 43H 0nH 4CH bbH bbH aaH aaH aaH ddH.....ddH ccH F7H |
| PARAMETER REQUEST | F0H 43H 3nH 4CH aaH aaH aaH F7H |
| DUMP REQUEST | F0H 43H 2nH 4CH aaH aaH aaH F7H |
| <CLAVINOVA MIDI COMPLIANCE> | |
| <SPETIAL OPERATORS> | |
| <Others> | |
| SYSTEM REALTIME MESSAGE | |
| MIDI CLOCK | F8H |
| START | FAH |
| STOP | FCH |
| ACTIVE SENSING | FEH |

*** PROGRAM NUMBER: XG SFX KIT number correspondence**

P = 1 SFX1 Kit
P = 2 SFX2 Kit

When DRUM VOICE is selected and program change data for a different DRUM VOICE is received, the currently selected DRUM VOICE will be replaced with the new DRUM VOICE.

(3-1-4) CHANNEL AFTER TOUCH (Recive only)

STATUS 1101nnnn(DnH) n = 0 - 15 VOICE CHANNEL NUMBER
VALUE 0vvvvvvv v = 0 - 127 AFTER TOUCH VALUE

(3-1-5) PITCH BEND CHANGE

STATUS 1110nnnn(EnH) n = 0 - 15 VOICE CHANNEL NUMBER
LSB 0vvvvvvv PITCH BEND CHANGE LSB
MSB 0vvvvvvv PITCH BEND CHANGE MSB

(3-1-6) CONTROL CHANGE

STATUS 1011nnnn(BnH) n = 0 - 15 VOICE CHANNEL NUMBER
CONTROL NUMBER 0ccccccc
CONTROL VALUE 0vvvvvvv

*** Transmit CONTROL NUMBER.**

c = 0 BANK SELECT MSB ; v = 0:XG NORMAL,
64:SFX NORMAL,
126:XG SFX KIT,
127:XG DRUM

c = 32 BANK SELECT LSB ; v = 0 - 127 *3
c = 6 DATA ENTRY MSB ; v = 0 - 127 *1
c = 38 DATA ENTRY LSB ; v = 0 - 127 *1
c = 7 MAIN VOLUME ; v = 0 - 127
c = 10 PANPOT ; v = 0 - 127
c = 11 EXPRESSION ; v = 0 - 127
c = 64 SUSTAIN ; v = 0-63:OFF , 64-127:ON *2
c = 66 SOSTENUTO ; v = 0-63:OFF , 64-127:ON *2
c = 67 SOFT PEDAL ; v = 0-63:OFF , 64-127:ON *2
c = 91 REVERB SEND LEVEL ; v = 0 - 127
c = 94 VARIATION SEND LEVEL ; v = 0 - 127
(When only Connection = 1[System])

*** Receive CONTROL NUMBER.**

c = 0 BANK SELECT MSB ; v = 0:XG NORMAL,
64:SFX NORMAL,
126:XG SFX KIT,
127:XG DRUM

c = 32 BANK SELECT LSB ; v = 0 - 127 *3
c = 1 MODULATION ; v = 0 - 127 *2
c = 5 PORTAMENTO TIME ; v = 0 - 127 *2
c = 6 DATA ENTRY MSB ; v = 0 - 127 *1
c = 38 DATA ENTRY LSB ; v = 0 - 127 *1
c = 7 MAIN VOLUME ; v = 0 - 127
c = 10 PANPOT ; v = 0 - 127
c = 11 EXPRESSION ; v = 0 - 127
c = 64 SUSTAIN ; v = 0-63:OFF , 64-127:ON *2
c = 65 PORTAMENTO ; v = 0-63:OFF , 64-127:ON *2
c = 66 SOSTENUTO ; v = 0-63:OFF , 64-127:ON *2
c = 67 SOFT PEDAL ; v = 0-63:OFF , 64-127:ON *2
c = 71 HARMONIC CONTENT ; v = 0:-64 - 64:0 - 127:+63 *2
c = 72 RELEASE TIME ; v = 0:-64 - 64:0 - 127:+63 *2
c = 73 ATTACK TIME ; v = 0:-64 - 64:0 - 127:+63 *2
c = 74 BRIGHTNESS ; v = 0:-64 - 64:0 - 127:+63 *2
c = 84 PORTAMENT CONTROL ; v = 0 - 127 *2
c = 91 REVERB SEND LEVEL ; v = 0 - 127
c = 93 CHORUS SEND LEVEL ; v = 0 - 127
c = 94 VARIATION SEND LEVEL ; v = 0 - 127
(When only Connection = 1[System])
c = 96 DATA INCREMENT ; v = 127 *1
c = 97 DATA DECREMENT ; v = 127 *1

*1 Only when setting the appointed parameter with RPN, NRPn.

*2 Does not effect Rhythm Voice.

*3 MSB=0, anything other than 63 is 0.

• Until a PROGRAM CHANGE message is received, the BANK SELECT operation will be suspended. When a Voice, including VOICE BANK, is changed, set the BANK SELECT and Program Change Message, and transmit in the following order, BANK SELECT MSB, LSB, PROGRAM CHANGE.

• MODULATION controls the Vibrato Depth.

• PORTAMENTO TIME controls the Pitch Change Speed when the Portamento Switch = ON. 0 being the shortest time, and 127 being the longest.

(3) TRANSMIT/RECEIVE DATA

(3-1) CHANNEL VOICE MESSAGES

(3-1-1) KEY OFF(Recive only)

STATUS 1000nnnn(8nH) n = 0 - 15 VOICE CHANNEL NUMBER
NOTE NUMBER 0kkkkkkk k = 0 (C-2) - 127 (G8)
VELOCITY 0vvvvvvv v: ignored

(3-1-2) KEY ON/OFF

STATUS 1001nnnn(9nH) n = 0 - 15 VOICE CHANNEL NUMBER
NOTE NUMBER 0kkkkkkk k = 0 (C-2) - 127 (G8)
VELOCITY 0vvvvvvv (v ≠ 0) NOTE ON
00000000 (v = 0) NOTE OFF

(3-1-3) PROGRAM CHANGE

STATUS 1100nnnn(CnH) n = 0 - 15 VOICE CHANNEL NUMBER
PROGRAM NUMBER 0ppppppp p = 0 - 127

*** PROGRAM NUMBER: XG DRUM VOICE number correspondence**

P = 0 Standard Kit
P = 1 Standard2 Kit
P = 8 Room Kit
P = 16 Rock Kit
P = 24 Elctmic Kit
P = 25 Analog Kit
P = 27 Dance Kit
P = 32 Jazz Kit
P = 40 Brush Kit
P = 48 Classic Kit

- PANPOT changes the value for the melody voice and rhythm voice in relation to the preset value.
- Portamento time is fixed to 0 when the PORTAMENTO CONTROL is used.
- HARMONIC CONTENT applies adjustment to the resonance value that is set by the voice. This parameter specifies relative change with the value of 64 producing 0 adjustment. As values get higher the sound becomes increasingly eccentric. Note that for some voices the effective parameter range is narrower than the legal parameter range.
- RELEASE TIME applies adjustment to the envelope release time set by the voice. This parameter specifies relative change with the value of 64 producing 0 adjustment.
- ATTACK TIME applies adjustment to the envelope attack time set by the voice. This parameter specifies relative change with the value of 64 producing 0 adjustment.
- BRIGHTNESS applies adjustment to the cut-off frequency set by the voice. This parameter specifies relative change with the value of 64 producing 0 adjustment. Lower voices produce a softer sound. For some voices the effective parameter range is narrower than the legal parameter range.

(3-2) CHANNEL MODE MESSAGES

| | | |
|----------------|---------------|---------------------------------|
| STATUS | 1011nnnn(BnH) | n = 0 - 15 VOICE CHANNEL NUMBER |
| CONTROL NUMBER | 0ccccccc | c = CONTROL NUMBER |
| CONTROL VALUE | 0vvvvvvv | v = DATA VALUE |

(3-2-1) ALL SOUND OFF (Recv only)

(CONTROL NUMBER = 78H , DATA VALUE = 0)

Switches off all sound from the channel. Does not reset Note On and Hold On conditions established by Channel Messages.

(3-2-2) RESET ALL CONTROLLERS (Recv only)

(CONTROL NUMBER = 79H , DATA VALUE = 0)

Resets controllers as follows.

| | |
|-------------------|--|
| PITCH BEND CHANGE | 0 (Center) |
| AFTER TOUCH | 0 (min.) |
| MODULATION | 0 (min.) |
| EXPRESSION | 127 (max.) |
| SUSTAIN | 0 (off) |
| SOSTENUTO | 0 (off) |
| SOFT PEDAL | 0 (off) |
| NRPN | Sets number to null. (Internal data remains unchanged) |
| RPN | Sets number to null. (Internal data remains unchanged) |
| PORTAMENT CONTROL | Resets portamento source note number |
| PORTAMENTO | 0 (off) |

(3-2-3) ALL NOTES OFF (Recv only)

(CONTROL NUMBER = 7BH , DATA VALUE = 0)

Switches off all of the channel's "on" notes. However, any notes being held by SUSTAIN or SOSTENUTO continue to sound until SUSTAIN/SOSTENUTO goes off.

(3-2-4) OMNI OFF (Recv only) (CONTROL NUMBER = 7CH , DATA VALUE = 0)

Same processing as for All Notes Off.

(3-2-5) OMNI ON (Recv only) (CONTROL NUMBER = 7DH , DATA VALUE = 0)

Same processing as for All Notes Off. Omni On is not executed.

(3-2-6) MONO (Recv only) (CONTROL NUMBER = 7EH , DATA VALUE = 0)

Same processing as for All Notes Off. If the 3rd byte is in a range of 0-16 the corresponding channel will be changed to Mode 4 (m=1).

(3-2-7) POLY (Recv only) (CONTROL NUMBER = 7FH , DATA VALUE = 0)

Same processing as for All Sounds Off and the corresponding channel will be changed to Mode 3.

(3-3) REGISTERED PARAMETER NUMBER(RPN)

| | | |
|----------------|---------------|--------------------------------------|
| STATUS | 1011nnnn(BnH) | n = 0 - 15 VOICE CHANNEL NUMBER |
| RPN LSB | 01100100(64H) | |
| RPN LSB NUMBER | 0ppppppp | p = RPN LSB(refer to the list below) |
| RPN MSB | 01100101(65H) | |
| RPN MSB NUMBER | 0qqqqqqq | q = RPN MSB(refer to the list below) |
| DATA ENTRY MSB | 00000110(06H) | |
| DATA VALUE | 0mmmmmmm | m = Data Value |
| DATA ENTRY LSB | 00100110(26H) | |
| DATA VALUE | 0lllllll | l = Data Value |

First appoints the parameter for RPN MSB/LSB, then sets the parameter value for data entry MSB/LSB.

| RPN | D.ENTRY | PARAMETER NAME | DATA RANGE |
|---------|---------|------------------------|--|
| LSB MSB | MSB LSB | | |
| 00H 00H | mmH — | PITCH BEND SENSITIVITY | 00H - 18H (0 - 24 semitones) |
| 01H 00H | mmH llH | FINE TUNE | {mmH,llH} = {00H,00H} - {40H,00H} - {7FH,7FH} (-8192*100/8192) - 0 - (+8192*100/8192) |
| 02H 00H | mmH — | COARSE TUNE | 28H - 40H - 58H (-24 - 0 +24 semitones) |
| 7FH 7FH | — — | NULL | |

Clears the current RPN number setting. Does not change the internal parameter settings.

(3-4) NON-REGISTERED PARAMETER NUMBER(NRPN) (Recv only)

| | | |
|-----------------|---------------|---------------------------------------|
| STATUS | 1011nnnn(BnH) | n = 0 - 15 VOICE CHANNEL NUMBER |
| NRPN LSB | 01100010(62H) | |
| NRPN LSB NUMBER | 0ppppppp | p = NRPN LSB(refer to the list below) |
| NRPN MSB | 01100011(63H) | |
| NRPN MSB NUMBER | 0qqqqqqq | q = NRPN MSB(refer to the list below) |
| DATA ENTRY MSB | 00000110(06H) | |
| DATA VALUE | 0mmmmmmm | m = Data Value |

First appoints the parameter for NRPN MSB/LSB, then sets the parameter value for data entry MSB/LSB.

| NRPN | D.ENTRY | PARAMETER NAME | DATA RANGE |
|---------|---------|---------------------------|--|
| MSB LSB | MSB LSB | | |
| 01H 08H | mmH — | VIBRATO RATE | 00H - 40H - 7FH (-64 - 0 +63) |
| 01H 09H | mmH — | VIBRATO DEPTH | 00H - 40H - 7FH (-64 - 0 +63) |
| 01H 0AH | mmH — | VIBRATO DELAY | 00H - 40H - 7FH (-64 - 0 +63) |
| 01H 20H | mmH — | FILTER CUTOFF FREQUENCY | 00H - 40H - 7FH (-64 - 0 +63) |
| 01H 21H | mmH — | FILTER RESONANCE | 00H - 40H - 7FH (-64 - 0 +63) |
| 01H 63H | mmH — | EG ATTACK TIME | 00H - 40H - 7FH (-64 - 0 +63) |
| 01H 64H | mmH — | EG DECAY TIME | 00H - 40H - 7FH (-64 - 0 +63) |
| 01H 66H | mmH — | EG RELEASE | 00H - 40H - 7FH (-64 - 0 +63) |
| 14H rrH | mmH — | DRUM FILTER CUTOFF FREQ. | 00H - 40H - 7FH (-64 - 0 +63) |
| 15H rrH | mmH — | DRUM FILTER RESONANCE | 00H - 40H - 7FH (-64 - 0 +63) |
| 16H rrH | mmH — | DRUM AEG ATTACK RATE | 00H - 40H - 7FH (-64 - 0 +63) |
| 17H rrH | mmH — | DRUM AEG DECAY RATE | 00H - 40H - 7FH (-64 - 0 +63) |
| 18H rrH | mmH — | DRUM PITCH COARSE | 00H - 40H - 7FH (-64 - 0 +63) |
| 19H rrH | mmH — | DRUM PITCH FINE | 00H - 40H - 7FH (-64 - 0 +63) |
| 1AH rrH | mmH — | DRUM LEVEL | 00H - 7FH (0 - max.) |
| 1CH rrH | mmH — | DRUM PANPOT | 00H ,01H - 40H - 7FH (random,left - center - right) |
| 1DH rrH | mmH — | DRUM REVERB SEND LEVEL | 00H - 7FH (0 - max.) |
| 1EH rrH | mmH — | DRUM CHORUS SEND LEVEL | 00H - 7FH (0 - max.) |
| 1FH rrH | mmH — | DRUM VARIATION SEND LEVEL | 00H - 7FH (0 - max.) |

The MSG14H-1FH (for drums) message is accepted as long as the channel is set with a drum voice.

rrH : drum instrument note number

(3-5) SYSTEM REALTIME MESSAGES

(3-5-1) MIDI CLOCK

STATUS 11111000 (F8H)

Transmission: 96 clocks per measure are transmitted.

Reception: If the instrument's clock is set to external, after FAH is received from the external device the instrument's clock will sync with the 96 beats per measure received from the external device.

Decides whether the internal clock, or Timing Clocks received via the MIDI IN will be used.

(3-5-2) START

STATUS 11111010 (FAH)

Transmission: Transmitted when instrument's Rhythm or Song playback is started.

Reception: Depending upon the condition, Rhythm, Song Playback, or Song Rec will start.

(3-5-3) STOP

STATUS 11111100 (FCH)

Transmission: Transmitted when instrument's Rhythm or Song playback is stopped.

Reception: Depending upon the condition, Rhythm, Song Playback, or Song Rec will stop.

(3-5-4) ACTIVE SENSING

STATUS 11111110 (FEH)

Transmission: Transmitted approximately once every 200msec.

Reception: Sensing is started once this Code is received. If Status or Data is not received within 400ms, the MIDI Receive Buffer will be cleared, and all notes, including those being sustained, will be cut OFF. Also, all control values will be reset to their factory defaults.

(3-6) SYSTEM EXCLUSIVE MESSAGE

(3-6-1) YAMAHA MIDI FORMAT

(3-6-1-1) SECTION CONTROL

| binary | hexadecimal | |
|----------|-------------|---------------------------------|
| 11110000 | F0 | Exclusive status |
| 01000011 | 43 | YAMAHA ID |
| 01111110 | 7E | Style |
| 00000000 | 00 | |
| 0sssssss | SS | Switch No. |
| | | 00H : INTRO A |
| | | 01H-07H : INTRO B |
| | | 08H : MAIN A |
| | | 09H-0FH : MAIN B |
| | | 10H : FILL IN AA |
| | | 11H-17H : FILL IN BB |
| | | 18H : FILL IN AB |
| | | 19H-1FH : FILL IN BA |
| | | 20H : ENDING A |
| | | 21H-27H : ENDING B |
| 0ddddd | DD | Switch On/Off: 00H(Off),7FH(On) |
| 11110111 | F7 | End of Exclusive |

When an ON code is received, the appointed section will be changed.

(3-6-1-2) TEMPO CONTROL

| binary | hexadecimal | |
|----------|-------------|------------------|
| 11110000 | F0 | Exclusive status |
| 01000011 | 43 | YAMAHA ID |
| 01111110 | 7E | Style |
| 00000000 | 01 | |
| 0ttttt | TT | Tempo4 |
| 0ttttt | TT | Tempo3 |
| 0ttttt | TT | Tempo2 |
| 0ttttt | TT | Tempo1 |
| 11110111 | F7 | End of Exclusive |

The internal clock will be set to the received Tempo value.

Tempo Meta Event is a large data block (24-bit), it is divided into 4 groups with 7-bits going into each of the Tempos 1-4 (4 receives the remaining 3 bits).

(3-6-2) UNIVERSAL SYSTEM EXCLUSIVE

(3-6-2-1) UNIVERSAL REALTIME MESSAGE

(3-6-2-1-1) MIDI MASTER VOLUME (Recive only)

| binary | hexadecimal | |
|----------|-------------|---|
| 11110000 | F0 | Exclusive status |
| 01111110 | 7F | Universal Realtime |
| 01111111 | 7F | ID of target Device |
| 00001001 | 04 | Sub-ID #1=Device Control Message |
| 00000001 | 01 | Sub-ID #2=Master Volume |
| 0sssssss | SS | Volume LSB |
| 0ttttt | TT | Volume MSB |
| 11110111 | F7 | End of Exclusive |
| or | | |
| 11110000 | F0 | Exclusive status |
| 01111110 | 7F | Universal Realtime |
| 0xxxxxxx | XN | When N is received N=0-F, whichever is received. When N is transmitted N always=0. X = don't care |
| 00001001 | 04 | Sub-ID #1=Device Control Message |
| 00000001 | 01 | Sub-ID #2=Master Volume |
| 0sssssss | SS | Volume LSB |
| 0ttttt | TT | Volume MSB |
| 11110111 | F7 | End of Exclusive |

The volume for all channels will be changed simultaneously.

The TT value is used as the MIDI Master Volume value. (the ss value is ignored.)

(3-6-2-2) UNIVERSAL NON REALTIME MESSAGE

(3-6-2-2-1) GENERAL MIDI SYSTEM ON

| binary | hexadecimal | |
|----------|-------------|--------------------------------|
| 11110000 | F0 | Exclusive status |
| 01111110 | 7E | Universal Non-Realtime |
| 01111111 | 7F | ID of target Device |
| 00001001 | 09 | Sub-ID #1=General MIDI Message |
| 00000001 | 01 | Sub-ID #2=General MIDI On |
| 11110111 | F7 | End of Exclusive |
| or | | |

| | | |
|----------|----|---|
| 11110000 | F0 | Exclusive status |
| 01111110 | 7E | Universal Non-Realtime |
| 0xxxxxxx | XN | When N is received N=0-F, whichever is received. When N is transmitted N always=0. X = don't care |
| 00001001 | 09 | Sub-ID #1=General MIDI Message |
| 00000001 | 01 | Sub-ID #2=General MIDI On |
| 11110111 | F7 | End of Exclusive |

Depending upon the received ON message, the System Mode will be changed to XG.

Except MIDI Master Tuning, all control data be reset to default values.

This message requires approximately 50ms to execute, so sufficient time should be allowed before the next message is sent.

(3-6-3) XG STANDARD

(3-6-3-1) XG PARAMETER CHANGE

(3-6-3-1-1) XG SYSTEM ON

| binary | hexadecimal | |
|----------|-------------|------------------|
| 11110000 | F0 | Exclusive status |
| 01000011 | 43 | YAMAHA ID |
| 0001nnnn | 1N | Device Number |
| 01001100 | 4C | Model ID |
| 00000000 | 00 | Address High |
| 00000000 | 00 | Address Mid |
| 01111110 | 7E | Address Low |
| 00000000 | 00 | Data |
| 11110111 | F7 | End of Exclusive |

Depending upon the received ON message, the SYSTEM MODE will be changed to XG. Controllers will be reset, all values of Multi Part and Effect, and All System values denoted by "XG" data within All System will be reset to default values in the table.

This message requires approximately 50ms to execute, so sufficient time should be allowed before the next message is sent.

(3-6-3-1-2) XG PARAMETER CHANGE

| binary | hexadecimal | |
|----------|-------------|------------------|
| 11110000 | F0 | Exclusive status |
| 01000011 | 43 | YAMAHA ID |
| 0001nnnn | 1N | Device Number |
| 01001100 | 4C | Model ID |
| 0aaaaaaa | AA | Address High |
| 0aaaaaaa | AA | Address Mid |
| 0aaaaaaa | AA | Address Low |
| 0ddddd | DD | Data |
| | | |
| 11110111 | F7 | End of Exclusive |

For parameters with data size of 2 or 4, transmit the appropriate number of data bytes.

For more information on Address and Parameters, refer to < Table 1-2 > (page 14) and < Table 1-4 > ~ < Table 1-8 > (pages 15-19).

The 4 data types listed below are transmitted and received.

(These are transmitted only after a Parameter change request is received.)

XG System Data
Multi Effect Data
Multi EQ Data
Multi Part Data
Drums Setup Data

(3-6-3-2) XG BULK DUMP

| binary | hexadecimal | |
|----------|-------------|------------------|
| 11110000 | F0 | Exclusive status |
| 01000011 | 43 | YAMAHA ID |
| 0000nnnn | 0N | Device Number |
| 01001100 | 4C | Model ID |
| 0bbbbbbb | BB | ByteCount |
| 0bbbbbbb | BB | ByteCount |
| 0aaaaaaa | AA | Address High |
| 0aaaaaaa | AA | Address Mid |
| 0aaaaaaa | AA | Address Low |
| 0ddddd | DD | Data |
| | | |
| 0ccccccc | CC | Check sum |
| 11110111 | F7 | End of Exclusive |

For more information on Address and Byte Count, refer to < Table 1-2 > ~ < Table 1-8 > (pages 14-19).

The Check Sum value is set such that the sum of Byte Count, Address, Data, and Check Sum has value zero in its seven least significant bits.

If the top of the block is appointed to the Address the XG Bulk Dump, Bulk Request will be received.

The Block is a unit that consists of the data, arranged in the list, as the Total Size.

The 5 data types listed below are transmitted and received.
(These are transmitted only after a Bulk Dump request is received.)

System Data
Multi Effect Data(Individual effect unit)
Multi EQ Data
Multi Part Data(Individual part unit)
Drums Setup Data(Individual note unit)
System Information(Individual only)

(3-6-3-3) XG PARAMETER REQUEST (Recv only)

| binary | hexadecimal | |
|----------|-------------|------------------|
| 11110000 | F0 | Exclusive status |
| 01000011 | 43 | YAMAHA ID |
| 0011nnnn | 3n | Device Number |
| 01001100 | 4C | Model ID |
| 0aaaaaaa | AA | Address High |
| 0aaaaaaa | AA | Address Mid |
| 0aaaaaaa | AA | Address Low |
| 11110111 | F7 | End of Exclusive |

For more information on Address and Byte Count refer to < Table 1-2 > (page 14) and < Table 1-4 > ~ < Table 1-8 > (pages 15-19).

The 4 data types listed below are received.

System Data
Multi Effect Data
Multi EQ Data
Multi Part Data
Drums Setup Data

(3-6-3-4) XG DUMP REQUEST (Recv only)

| binary | hexadecimal | |
|----------|-------------|------------------|
| 11110000 | F0 | Exclusive status |
| 01000011 | 43 | YAMAHA ID |
| 0010nnnn | 2n | Device Number |
| 01001100 | 4C | Model ID |
| 0aaaaaaa | AA | Address High |
| 0aaaaaaa | AA | Address Mid |
| 0aaaaaaa | AA | Address Low |
| 11110111 | F7 | End of Exclusive |

For more information on Address and Byte Count refer to < Table 1-2 > ~ < Table 1-8 > (pages 14-19).

The 5 data types listed below are received.

System Data
Multi Effect Data(Individual module unit)
Multi EQ Data
Multi Part Data(Individual part unit)
Drums Setup Data(Individual note unit)
System Information

(3-6-4) CLAVINOVA MIDI COMPLIANCE

(3-6-4-1) INTERNAL CLOCK / EXTERNAL CLOCK (Recv only)

| binary | hexadecimal | |
|----------|-------------|--|
| 11110000 | F0 | Exclusive status |
| 01000011 | 43 | YAMAHA ID |
| 01110011 | 73 | Clavinova ID |
| 00000001 | 01 | Clavinova common ID |
| 0000001n | 0N | N: 2(Internal Clock),3(External Clock) |
| 11110111 | F7 | End of Exclusive |

(3-6-4-2) DOC MULTI TIMBRE ON / OFF (Recv only)

| binary | hexadecimal | |
|----------|-------------|---|
| 11110000 | F0 | Exclusive status |
| 01000011 | 43 | YAMAHA ID |
| 01110011 | 73 | Clavinova ID |
| 00000001 | 01 | Clavinova common ID |
| 00000110 | 1N | N: 3(DOC Multi Timbre Off),4(DOC Multi Timbre On) |
| 11110111 | F7 | End of Exclusive |

(3-6-4-3) PANEL LED ON / OFF (Recv only)

| binary | hexadecimal | |
|----------|-------------|---|
| 11110000 | F0 | Exclusive status |
| 01000011 | 43 | YAMAHA ID |
| 01110011 | 73 | Clavinova ID |
| 01000101 | 45 | CVP-98/96/600/94/92 |
| 00011010 | 1A | PANEL LED On/Off |
| 0mmmmmmm | MM | MM: 00H(LED Off),01H(LED On),02H(The LED flashes) 03H (LED All off), 04H (Panel LED returns to normal operation) |
| 00000000 | 00 | |
| 0nnnnnnn | NN | LED No. |
| 11110111 | F7 | End of Exclusive |

Remotely switches the Panel LED On/Off.

(3-6-4-4) STYLE NUMBER

| binary | hexadecimal | |
|----------|-------------|---------------------|
| 11110000 | F0 | Exclusive status |
| 01000011 | 43 | YAMAHA ID |
| 01110011 | 73 | Clavinova ID |
| 01000101 | 45 | CVP-98/96/600/94/92 |
| 00011101 | 1D | Style No. |
| 00000000 | 00 | |
| 0ccccccc | CC | Style No. MSB |
| 0ddddddd | DD | Style No. LSB |
| 11110111 | F7 | End of Exclusive |

(3-6-4-5) MIDI FA CANCEL (Recv only)

| binary | hexadecimal | |
|----------|-------------|---------------------|
| 11110000 | F0 | Exclusive status |
| 01000011 | 43 | YAMAHA ID |
| 01110011 | 73 | Clavinova ID |
| 01000101 | 01 | Clavinova common ID |
| 01110001 | 61 | MIDI FA Cancel |
| 11110111 | F7 | End of Exclusive |

If this message is received, even if FAH is received the Rhythm will not start.

(3-6-5) SPECIAL OPERATORS

(3-6-5-1) SPLIT POINT

| binary | hexadecimal | |
|----------|-------------|---------------------|
| 11110000 | F0 | Exclusive status |
| 01000011 | 43 | YAMAHA ID |
| 01110011 | 73 | Clavinova ID |
| 01000101 | 01 | Clavinova common ID |
| 00010001 | 11 | Sub ID |
| 00000000 | 00 | |
| 00010100 | 14 | Split Point |
| 0ddddddd | DD | Split Key No. |
| 11110111 | F7 | End of Exclusive |

(3-6-5-2) FINGERING

| binary | hexadecimal | |
|----------|-------------|--|
| 11110000 | F0 | Exclusive status |
| 01000011 | 43 | YAMAHA ID |
| 01110011 | 73 | Clavinova ID |
| 01000101 | 01 | Clavinova common ID |
| 00010001 | 11 | Sub ID |
| 00000000 | 00 | |
| 01000000 | 40 | Fingering |
| 0000dddd | 0D | 0D: 00H(Off),01H(Single Finger),02H(Fingered), 04H(Full Keyboard),07H(Multi Finger) |
| 11110111 | F7 | End of Exclusive |

(3-6-5-3) ACCOMP VOLUME

| binary | hexadecimal | |
|----------|-------------|---|
| 11110000 | F0 | Exclusive status |
| 01000011 | 43 | YAMAHA ID |
| 01110011 | 73 | Clavinova ID |
| 01000101 | 01 | Clavinova common ID |
| 00010001 | 11 | Sub ID |
| 0000nnnn | 0N | Part: 00H(All Part),05H(Rhythm),0AH(Bass), 06H(Chord),0DH(Pad),07H(Phrase) |
| 01000000 | 42 | Accomp Volume |
| 0ddddddd | DD | Volume Data: 00H~7FH |
| 11110111 | F7 | End of Exclusive |

(3-6-5-4) CHANNEL DETUNE

| binary | hexadecimal | |
|----------|-------------|---|
| 11110000 | F0 | Exclusive status |
| 01000011 | 43 | YAMAHA ID |
| 01110011 | 73 | Clavinova ID |
| 01000101 | 45 | CVP-98/96/600/94/92 ID |
| 00010001 | 11 | Sub ID |
| 0000nnnn | 0N | N = MIDI Channel |
| 01000011 | 43 | Dual Detune |
| 0vvvvvvv | VV | Value VV: 00H - 40H - 7FH (-64 - 0 - +63) |
| 11110111 | F7 | End of Exclusive |

The Channel Detune message only affects the specified channel.

MIDI Data Format / MIDI-Datenformat / Format des données MIDI / Formato de datos MIDI

(3-6-5-5) VOLUME ,EXPRESSION AND PAN REALTIME CONTROL OFF

| binary | hexadecimal | |
|----------|-------------|--|
| 11110000 | F0 | Exclusive status |
| 01000011 | 43 | YAMAHA ID |
| 01110011 | 73 | Clavinova ID |
| 01000101 | 45 | CVP-98/96/600/94/92 ID |
| 00010001 | 11 | Sub ID |
| 0000nnnn | 0N | N = MIDI Channel |
| 01001001 | 45 | Volume and Expression Realtime Control Off |
| 0vvvvvvv | VV | Value VV: off=7FH, on=00H |
| 11110111 | F7 | End of Exclusive |

When "On" is received, subsequent volume, expression, and PAN changes are only valid after the reception of the next key on. Normal operation resumes when "Off" is received.

(3-6-5-6) MIDI KEY LED MODE ON / OFF (Recive only)

| binary | hexadecimal | |
|----------|-------------|--|
| 11110000 | F0 | Exclusive status |
| 01000011 | 43 | YAMAHA ID |
| 01110011 | 73 | Clavinova ID |
| 01000101 | 01 | Sub ID |
| 00010001 | 11 | Sub ID |
| 0000nnnn | 0N | N = MIDI Channel |
| 01000111 | 47 | MIDI Key LED Mode On / Off |
| 0ddddd | DD | DD: 00H(Key LED Mode Off),01H(Key LED Mode On + no tone), 02H(Key LED Mode On + tone) |
| 11110111 | F7 | End of Exclusive |

(3-6-6) Others

(3-6-6-1) MIDI MASTER TUNING (Recive only)

| binary | hexadecimal | |
|----------|-------------|--|
| 11110000 | F0 | Exclusive status |
| 01000011 | 43 | YAMAHA ID |
| 0001nnnn | 1N | When N is received N=0-F, whichever is received. |
| 00100111 | 27 | Model ID |
| 00110000 | 30 | Sub ID |
| 00000000 | 00 | |
| 00000000 | 00 | |
| 0mmmmmmm | MM | Master Tune MSB |
| 0lllllll | LL | Master Tune LSB |
| 0ccccccc | CC | don't care |
| 11110111 | F7 | End of Exclusive |

Changes tuning of all channels.

MM, LL values are used to define the MIDI Master Tuning value.

T = M-128

T : Tuning value (-99cent - +99cent)

M : A single byte value (28-228) consists of bytes 0-3 of MM = MSB, bytes 0-3 of LL = LSB.

In this setting, GM System ON, XG System ON will not be reset.

< Table 1-1 >

Parameter Basic Address

| Parameter | Parameter Change Address | | | Description |
|-------------|--------------------------|-----|-----|-----------------------------------|
| | (H) | (M) | (L) | |
| SYSTEM | 00 | 00 | 00 | System |
| | 00 | 00 | 7D | Drum Setup Reset |
| | 00 | 00 | 7E | XG System On |
| | 00 | 00 | 7F | All Parameter Reset |
| INFORMATION | 01 | 00 | 00 | System Information |
| EFFECT 1 | 02 | 01 | 00 | Effect1(Reverb,Chorus,Variation) |
| MULTI PART | 08 | 00 | 00 | Multi Part 1 |
| | : | : | : | |
| | 08 | 0F | 00 | Multi Part 16 |
| | 08 | 10 | 00 | Reserved |
| : | : | : | : | |
| DRUM | 30 | 0D | 00 | Drum Setup 1 |
| | 31 | 0D | 00 | Drum Setup 2 |
| | 3n | 0D | 00 | note number 13 |
| | 3n | 0E | 00 | note number 14 |
| | : | : | : | : |
| | 3n | 5B | 00 | note number 91 |
| | 3F | nn | nn | Reserved |

< Table 1-2 >

MIDI Parameter Change table (SYSTEM)

| Address (H) | Size | Data (H) | Parameter Name | Description | Default | Value(H) | |
|--------------|------|----------|----------------|---------------------|----------------------|------------------------|--------------------------------------|
| 00 | 00 | 00 | 04 | 0000 | Master Tune | -102.4..+102.3[cent] | 00 04 00 00 |
| | | 01 | | ..07FF | | 1st bit3-0 -> bit15-12 | (0400) |
| | | 02 | | | | 2nd bit3-0 -> bit11-8 | (With XG, GM On, it will not reset.) |
| | | 03 | | | | 3rd bit3-0 -> bit7-4 | |
| | | | | | | 4th bit3-0 -> bit3-0 | |
| | 04 | 1 | 00..7F | Master Volume | 0..127 | 7F | |
| | 05 | 1 | | Not Used | | | |
| | 06 | 1 | 28..58 | Transpose | -24..+24[semitones] | 40 | |
| | 7D | n | | Drum Setup Reset | n=Drum Setup Number | | |
| | 7E | 00 | | XG System On | 00=XG System on | | |
| | 7F | 00 | | All Parameter Reset | 00=on (receive only) | | |
| TOTAL SIZE 6 | | | | | | | |

< Table 1-3 >

MIDI Parameter table (System information)

| Address (H) | Size | Data (H) | Parameter Name (H) | Description |
|-------------|------|----------|--------------------|----------------|
| 01 | 00 | E | 20..7F | Model Name |
| | | : | | 32..127(ASCII) |
| | | 0D | | |
| | | 0E | 1 00 | |
| | | 0F | 1 00 | |

TOTAL SIZE 10

(Transmitted by Dump Request. Not received. Bulk Dump Only)

< Table 1-4 >

MIDI Parameter Change table (EFFECT 1)

| Address (H) | Size | Data (H) | Parameter Name (H) | Description | Default | Value(H) | |
|-------------|------|----------|--------------------|-------------|---------------------|---------------------------------|-----------------------|
| 02 | 01 | 00 | 2 | 00..7F | Reverb Type MSB | Refer to the Effect Type List | 01(=HALL1) |
| | | | | 00..7F | Reverb Type LSB | 00 : basic type | 00 |
| | | 02 | 1 | 00..7F | Reverb Parameter 1 | Refer to the Ef. Parameter List | Depend on Reverb type |
| | | 03 | 1 | 00..7F | Reverb Parameter 2 | Refer to the Ef. Parameter List | Depend on Reverb type |
| | | 04 | 1 | 00..7F | Reverb Parameter 3 | Refer to the Ef. Parameter List | Depend on Reverb type |
| | | 05 | 1 | 00..7F | Reverb Parameter 4 | Refer to the Ef. Parameter List | Depend on Reverb type |
| | | 06 | 1 | 00..7F | Reverb Parameter 5 | Refer to the Ef. Parameter List | Depend on Reverb type |
| | | 07 | 1 | 00..7F | Reverb Parameter 6 | Refer to the Ef. Parameter List | Depend on Reverb type |
| | | 08 | 1 | 00..7F | Reverb Parameter 7 | Refer to the Ef. Parameter List | Depend on Reverb type |
| | | 09 | 1 | 00..7F | Reverb Parameter 8 | Refer to the Ef. Parameter List | Depend on Reverb type |
| | | 0A | 1 | 00..7F | Reverb Parameter 9 | Refer to the Ef. Parameter List | Depend on Reverb type |
| | | 0B | 1 | 00..7F | Reverb Parameter 10 | Refer to the Ef. Parameter List | Depend on Reverb type |
| | | 0C | 1 | 00..7F | Reverb Return | -∞..0..+6dB(0..96..127) | 60 |
| | | 0D | 1 | 01..7F | Reverb Pan | L63..C..R63(1..64..127) | 40 |

TOTAL SIZE 0E

| | | | | | | | |
|----|----|----|---|--------|---------------------|---------------------------------|-----------------------|
| 02 | 01 | 10 | 1 | 00..7F | Reverb Parameter 11 | Refer to the Ef. Parameter List | Depend on Reverb type |
| | | 11 | 1 | 00..7F | Reverb Parameter 12 | Refer to the Ef. Parameter List | Depend on Reverb type |
| | | 12 | 1 | 00..7F | Reverb Parameter 13 | Refer to the Ef. Parameter List | Depend on Reverb type |
| | | 13 | 1 | 00..7F | Reverb Parameter 14 | Refer to the Ef. Parameter List | Depend on Reverb type |
| | | 14 | 1 | 00..7F | Reverb Parameter 15 | Refer to the Ef. Parameter List | Depend on Reverb type |
| | | 15 | 1 | 00..7F | Reverb Parameter 16 | Refer to the Ef. Parameter List | Depend on Reverb type |

TOTAL SIZE 6

| | | | | | | | |
|----|----|----|---|--------|-----------------------|---------------------------------|-----------------------|
| 02 | 01 | 20 | 2 | 00..7F | Chorus Type MSB | Refer to the Effect Type List | 41(=Chorus1) |
| | | | | 00..7F | Chorus Type LSB | 00 : basic type | 00 |
| | | 22 | 1 | 00..7F | Chorus Parameter 1 | Refer to the Ef. Parameter List | Depend on Chorus Type |
| | | 23 | 1 | 00..7F | Chorus Parameter 2 | Refer to the Ef. Parameter List | Depend on Chorus Type |
| | | 24 | 1 | 00..7F | Chorus Parameter 3 | Refer to the Ef. Parameter List | Depend on Chorus Type |
| | | 25 | 1 | 00..7F | Chorus Parameter 4 | Refer to the Ef. Parameter List | Depend on Chorus Type |
| | | 26 | 1 | 00..7F | Chorus Parameter 5 | Refer to the Ef. Parameter List | Depend on Chorus Type |
| | | 27 | 1 | 00..7F | Chorus Parameter 6 | Refer to the Ef. Parameter List | Depend on Chorus Type |
| | | 28 | 1 | 00..7F | Chorus Parameter 7 | Refer to the Ef. Parameter List | Depend on Chorus Type |
| | | 29 | 1 | 00..7F | Chorus Parameter 8 | Refer to the Ef. Parameter List | Depend on Chorus Type |
| | | 2A | 1 | 00..7F | Chorus Parameter 9 | Refer to the Ef. Parameter List | Depend on Chorus Type |
| | | 2B | 1 | 00..7F | Chorus Parameter 10 | Refer to the Ef. Parameter List | Depend on Chorus Type |
| | | 2C | 1 | 00..7F | Chorus Return | -∞..0..+6dB(0..96..127) | 60 |
| | | 2D | 1 | 01..7F | Chorus Pan | L63..C..R63(1..64..127) | 40 |
| | | 2E | 1 | 00..7F | Send Chorus To Reverb | -∞..0..+6dB(0..96..127) | 00 |

TOTAL SIZE 0F

| | | | | | | | |
|----|----|----|---|--------|---------------------|---------------------------------|-----------------------|
| 02 | 01 | 30 | 1 | 00..7F | Chorus Parameter 11 | Refer to the Ef. Parameter List | Depend on Chorus Type |
| | | 31 | 1 | 00..7F | Chorus Parameter 12 | Refer to the Ef. Parameter List | Depend on Chorus Type |
| | | 32 | 1 | 00..7F | Chorus Parameter 13 | Refer to the Ef. Parameter List | Depend on Chorus Type |
| | | 33 | 1 | 00..7F | Chorus Parameter 14 | Refer to the Ef. Parameter List | Depend on Chorus Type |
| | | 34 | 1 | 00..7F | Chorus Parameter 15 | Refer to the Ef. Parameter List | Depend on Chorus Type |
| | | 35 | 1 | 00..7F | Chorus Parameter 16 | Refer to the Ef. Parameter List | Depend on Chorus Type |

TOTAL SIZE 6

| | | | | | | | |
|----|----|----|---|--------|--------------------|---------------------------------|----------------------|
| 02 | 01 | 40 | 2 | 00..7F | Variation Type MSB | Refer to the Effect Type List | "05(=DELAY L,C,R)" |
| | | | | 00..7F | Variation Type LSB | 00 : basic type | 00 |
| | | 42 | 2 | 00..7F | Vari. Param. 1 MSB | Refer to the Ef. Parameter List | Depend on Vari. Type |
| | | | | 00..7F | Vari. Param. 1 LSB | Refer to the Ef. Parameter List | Depend on Vari. Type |
| | | 44 | 2 | 00..7F | Vari. Param. 2 MSB | Refer to the Ef. Parameter List | Depend on Vari. Type |
| | | | | 00..7F | Vari. Param. 2 LSB | Refer to the Ef. Parameter List | Depend on Vari. Type |
| | | 46 | 2 | 00..7F | Vari. Param. 3 MSB | Refer to the Ef. Parameter List | Depend on Vari. Type |
| | | | | 00..7F | Vari. Param. 3 LSB | Refer to the Ef. Parameter List | Depend on Vari. Type |
| | | 48 | 2 | 00..7F | Vari. Param. 4 MSB | Refer to the Ef. Parameter List | Depend on Vari. Type |
| | | | | 00..7F | Vari. Param. 4 LSB | Refer to the Ef. Parameter List | Depend on Vari. Type |

MIDI Data Format / MIDI-Datenformat / Format des données MIDI / Formato de datos MIDI

| | | | | | | | |
|---------------|----|--------|----------------------|---------------------------------|------------------------|------------------|--------------------------|
| 4A | 2 | 00..7F | Vari. Param. 5 MSB | Refer to the Ef. Parameter List | Depend on Vari. Type | | |
| | | 00..7F | Vari. Param. 5 LSB | Refer to the Ef. Parameter List | Depend on Vari. Type | | |
| 4C | 2 | 00..7F | Vari. Param. 6 MSB | Refer to the Ef. Parameter List | Depend on Vari. Type | | |
| | | 00..7F | Vari. Param. 6 LSB | Refer to the Ef. Parameter List | Depend on Vari. Type | | |
| 4E | 2 | 00..7F | Vari. Param. 7 MSB | Refer to the Ef. Parameter List | Depend on Vari. Type | | |
| | | 00..7F | Vari. Param. 7 LSB | Refer to the Ef. Parameter List | Depend on Vari. Type | | |
| 50 | 2 | 00..7F | Vari. Param. 8 MSB | Refer to the Ef. Parameter List | Depend on Vari. Type | | |
| | | 00..7F | Vari. Param. 8 LSB | Refer to the Ef. Parameter List | Depend on Vari. Type | | |
| 52 | 2 | 00..7F | Vari. Param. 9 MSB | Refer to the Ef. Parameter List | Depend on Vari. Type | | |
| | | 00..7F | Vari. Param. 9 LSB | Refer to the Ef. Parameter List | Depend on Vari. Type | | |
| 54 | 2 | 00..7F | Vari. Param. 10 MSB | Refer to the Ef. Parameter List | Depend on Vari. Type | | |
| | | 00..7F | Vari. Param. 10 LSB | Refer to the Ef. Parameter List | Depend on Vari. Type | | |
| 56 | 1 | 00..7F | Variation Return | -∞..0..+6dB(0..96..127) | 60 | | |
| 57 | 1 | 01..7F | Variation Pan | L63..C..R63(1..64..127) | 40 | | |
| 58 | 1 | 00..7F | Send Vari. To Reverb | -∞..0..+6dB(0..96..127) | 00 | | |
| 59 | 1 | 00..7F | Send Vari. To Chorus | -∞..0..+6dB(0..96..127) | 00 | | |
| 5A | 1 | 00..01 | Variation Connection | 0:insertion,1:system | 00 | | |
| 5B | 1 | 00..1F | Variation Part | part1..32(0..31),off(127) | 7F | | |
| 5C | 1 | 01..7F | MW Vari. Ctrl Depth | -63..+63 | 40 | | |
| 5D | 1 | 01..7F | PB Vari. Ctrl Depth | -63..+63 | 40 | | |
| 5E | 1 | 01..7F | CAT Vari. Ctrl Depth | -63..+63 | 40 | | |
| 5F | 1 | 01..7F | Not Used | | | | |
| 60 | 1 | 01..7F | Not Used | | | | |
| TOTAL SIZE 21 | | | | | | | |
| 02 | 01 | 70 | 1 | 00..7F | Variation Parameter 11 | option Parameter | Depend on Variation Type |
| | | 71 | 1 | 00..7F | Variation Parameter 12 | option Parameter | Depend on Variation Type |
| | | 72 | 1 | 00..7F | Variation Parameter 13 | option Parameter | Depend on Variation Type |
| | | 73 | 1 | 00..7F | Variation Parameter 14 | option Parameter | Depend on Variation Type |
| | | 74 | 1 | 00..7F | Variation Parameter 15 | option Parameter | Depend on Variation Type |
| | | 75 | 1 | 00..7F | Variation Parameter 16 | option Parameter | Depend on Variation Type |
| TOTAL SIZE 6 | | | | | | | |

< Table 1-5 >

MIDI Parameter Change table (MULTI EQ)

| Address (H) | Size (H) | Data (H) | Parameter Name (H) | Description | Default | Value(H) | |
|---------------|----------|----------|--------------------|-------------|---------------|------------------------|----|
| 02 | 40 | 00 | 1 | 34..4C | EQ Type | 0:FLAT | 0 |
| | | | | | 1:JAZZ | | |
| | | | | | 2:POPS | | |
| | | | | | 3:ROCK | | |
| | | | | | 4:CLASSIC | | |
| | | 01 | 1 | 34..4C | EQ Gain1 | -12..+12[dB] | 40 |
| | | 02 | 1 | 04..28 | EQ Frequency1 | 32..2000[Hz] | 0C |
| | | 03 | 1 | 01..78 | EQ Q1 | 0.1..12.0 | 07 |
| | | 04 | 1 | 00..01 | EQ Shape1 | 00:Shelving,01:Peaking | 00 |
| | | 05 | 1 | 34..4C | EQ Gain2 | -12..+12[dB] | 40 |
| | | 06 | 1 | 0E..36 | EQ Frequency2 | 0.1..10[KHz] | 1C |
| | | 07 | 1 | 01..78 | EQ Q2 | 0.1..12.0 | 07 |
| | | 08 | 1 | | Not Used | | |
| | | 09 | 1 | 34..4C | EQ Gain3 | -12..+12[dB] | 40 |
| | | 0A | 1 | 0E..36 | EQ Frequency3 | 0.1..10[KHz] | 22 |
| | | 0B | 1 | 01..78 | EQ Q3 | 0.1..12.0 | 07 |
| | | 0C | 1 | | Not Used | | |
| | | 0D | 1 | 34..4C | EQ Gain4 | -12..+12[dB] | 40 |
| | | 0E | 1 | 0E..36 | EQ Frequency4 | 0.1..10[KHz] | 2E |
| | | 0F | 1 | 01..78 | EQ Q4 | 0.1..12.0 | 07 |
| | | 10 | 1 | | Not Used | | |
| | | 11 | 1 | 34..4C | EQ Gain5 | -12..+12[dB] | 40 |
| | | 12 | 1 | 1C..3A | EQ Frequency5 | 0.5..16.0[KHz] | 3C |
| | | 13 | 1 | 01..78 | EQ Q5 | 0.1..12.0 | 07 |
| | | 14 | 1 | 00..01 | EQ Shape5 | 00:Shelving,01:Peaking | 00 |
| TOTAL SIZE 15 | | | | | | | |

< Table 1-6 >

MIDI Parameter Change table (EFFECT 2)

| Address (H) | Size (H) | Data (H) | Parameter Name (H) | Description | Default | Value(H) | |
|-------------|----------|----------|--------------------|-------------|----------------------|---------------------------------|---------------------|
| 03 | 00 | 00 | 2 | 00..7F | Insertion Type MSB | Refer to the Ef. Type List | "49(=DISTORTION)" |
| | | | | 00..7F | Insertion Type LSB | 00 : basic type | 00 |
| | | 02 | 1 | 00..7F | Insertion Parameter1 | Refer to the Ef. Parameter List | Depend on Ins. Type |
| | | 03 | 1 | 00..7F | Insertion Parameter2 | Refer to the Ef. Parameter List | Depend on Ins. Type |
| | | 04 | 1 | 00..7F | Insertion Parameter3 | Refer to the Ef. Parameter List | Depend on Ins. Type |

| | | | | | |
|----|---|--------|-----------------------|---------------------------------|---------------------|
| 05 | 1 | 00..7F | Insertion Parameter4 | Refer to the Ef. Parameter List | Depend on Ins. Type |
| 06 | 1 | 00..7F | Insertion Parameter5 | Refer to the Ef. Parameter List | Depend on Ins. Type |
| 07 | 1 | 00..7F | Insertion Parameter6 | Refer to the Ef. Parameter List | Depend on Ins. Type |
| 08 | 1 | 00..7F | Insertion Parameter7 | Refer to the Ef. Parameter List | Depend on Ins. Type |
| 09 | 1 | 00..7F | Insertion Parameter8 | Refer to the Ef. Parameter List | Depend on Ins. Type |
| 0A | 1 | 00..7F | Insertion Parameter9 | Refer to the Ef. Parameter List | Depend on Ins. Type |
| 0B | 1 | 00..7F | Insertion Parameter10 | Refer to the Ef. Parameter List | Depend on Ins. Type |
| 0C | 1 | 00..7F | Insertion Part | Part1..16,OFF | 7F |
| 0D | 1 | 00..7F | MW INS CTRL DPT | | |
| 0E | 1 | 00..7F | BEND INS CTRL DPT | | |
| 0F | 1 | 00..7F | CAT INS CTRL DPT | | |
| 10 | 1 | 00..7F | Not Used | | |
| 11 | 1 | 00..7F | Not Used | | |

TOTAL SIZE 12

| | | | | | | | |
|----|----|----|---|--------|-----------------------|---------------------------------|---------------------|
| 03 | 00 | 20 | 1 | 00..7F | Insertion Parameter11 | Refer to the Ef. Parameter List | Depend on Ins. Type |
| | | 21 | 1 | 00..7F | Insertion Parameter12 | Refer to the Ef. Parameter List | Depend on Ins. Type |
| | | 22 | 1 | 00..7F | Insertion Parameter13 | Refer to the Ef. Parameter List | Depend on Ins. Type |
| | | 23 | 1 | 00..7F | Insertion Parameter14 | Refer to the Ef. Parameter List | Depend on Ins. Type |
| | | 24 | 1 | 00..7F | Insertion Parameter15 | Refer to the Ef. Parameter List | Depend on Ins. Type |
| | | 25 | 1 | 00..7F | Insertion Parameter16 | Refer to the Ef. Parameter List | Depend on Ins. Type |

TOTAL SIZE 06

| | | | | | | | |
|----|----|----|---|--------|-------------------|---------------------------------|---------------------|
| 03 | 00 | 30 | 2 | 00..7F | Ins. Param.1 MSB | Refer to the Ef. Parameter List | Depend on Ins. Type |
| | | | | 00..7F | Ins. Param.1 LSB | Refer to the Ef. Parameter List | Depend on Ins. Type |
| 03 | 00 | 32 | 2 | 00..7F | Ins. Param.2 MSB | Refer to the Ef. Parameter List | Depend on Ins. Type |
| | | | | 00..7F | Ins. Param.2 LSB | Refer to the Ef. Parameter List | Depend on Ins. Type |
| 03 | 00 | 34 | 2 | 00..7F | Ins. Param.3 MSB | Refer to the Ef. Parameter List | Depend on Ins. Type |
| | | | | 00..7F | Ins. Param.3 LSB | Refer to the Ef. Parameter List | Depend on Ins. Type |
| 03 | 00 | 36 | 2 | 00..7F | Ins. Param.4 MSB | Refer to the Ef. Parameter List | Depend on Ins. Type |
| | | | | 00..7F | Ins. Param.4 LSB | Refer to the Ef. Parameter List | Depend on Ins. Type |
| 03 | 00 | 38 | 2 | 00..7F | Ins. Param.5 MSB | Refer to the Ef. Parameter List | Depend on Ins. Type |
| | | | | 00..7F | Ins. Param.5 LSB | Refer to the Ef. Parameter List | Depend on Ins. Type |
| 03 | 00 | 3A | 2 | 00..7F | Ins. Param.6 MSB | Refer to the Ef. Parameter List | Depend on Ins. Type |
| | | | | 00..7F | Ins. Param.6 LSB | Refer to the Ef. Parameter List | Depend on Ins. Type |
| 03 | 00 | 3C | 2 | 00..7F | Ins. Param.7 MSB | Refer to the Ef. Parameter List | Depend on Ins. Type |
| | | | | 00..7F | Ins. Param.7 LSB | Refer to the Ef. Parameter List | Depend on Ins. Type |
| 03 | 00 | 3E | 2 | 00..7F | Ins. Param.8 MSB | Refer to the Ef. Parameter List | Depend on Ins. Type |
| | | | | 00..7F | Ins. Param.8 LSB | Refer to the Ef. Parameter List | Depend on Ins. Type |
| 03 | 00 | 40 | 2 | 00..7F | Ins. Param.9 MSB | Refer to the Ef. Parameter List | Depend on Ins. Type |
| | | | | 00..7F | Ins. Param.9 LSB | Refer to the Ef. Parameter List | Depend on Ins. Type |
| 03 | 00 | 42 | 2 | 00..7F | Ins. Param.10 MSB | Refer to the Ef. Parameter List | Depend on Ins. Type |
| | | | | 00..7F | Ins. Param.10 LSB | Refer to the Ef. Parameter List | Depend on Ins. Type |

TOTAL SIZE 14

For effect types that do not require MSB, the Parameters for Address 02-0B will be received. Address 30-42 will not be received.

For effect types that require MSB, the Parameters for Address 30-42 will be received. Address 02-0B will not be received.

When Bulk Dumps that include Effect Type data are transmitted, the Parameters for Address 02 - 0B will always be transmitted. But, effects that require MSB, when the bulk dump is received the Parameters for Address 02 - 0B will not be received.

< Table 1-7 >

MIDI Parameter Change table (MULTI PART)

| Address (H) | Size | Data (H) | Parameter Name (H) | Description | Default | Value(H) | |
|-------------|------|----------|--------------------|---------------|-------------------------|------------------------|-----------------------|
| 08 | nn | 00 | 1 | 00..20 | Element Reserve | 0..32 | 0(Part10),2(Others) |
| | nn | 01 | 1 | 00..7F | Bank Select MSB | 0..127 | 7F(Part10),00(Others) |
| | nn | 02 | 1 | 00..7F | Bank Select LSB | 0..127 | 00 |
| | nn | 03 | 1 | 00..7F | Program Number | 1..128 | 00 |
| | nn | 04 | 1 | 00..0F, 7F | Rcv Channel | 0..16;1..16,127;off | Part No. |
| | nn | 05 | 1 | 00..01 | Mono/Poly Mode | 0:mono,1:poly | 01 |
| | nn | 06 | 1 | 00..02 | Same Note Number | 0:single | 00 |
| | | | | Key On Assign | 1:multi | | |
| | | | | | 2:inst (for DRUM) | | |
| | nn | 07 | 1 | 00..02 | Part Mode | 0:normal | 00 (Except Part10) |
| | | | | | 1..3:drum thru,drum1..2 | | 01 (Part10) |
| | nn | 08 | 1 | 28..58 | Note Shift | -24..+24[semitones] | 40 |
| | nn | 09 | 2 | 00..FF | Detune | -12.8..+12.7[Hz] | 08 00 |
| | nn | 0A | | | | 1st bit3..0 -> bit7..4 | (80) |
| | | | | | | 2nd bit3..0 -> bit3..0 | |
| | nn | 0B | 1 | 00..7F | Volume | 0..127 | 64 |
| | nn | 0C | 1 | 00..7F | Velocity Sense Depth | 0..127 | 40 |
| | nn | 0D | 1 | 00..7F | Velocity Sense Offset | 0..127 | 40 |
| | nn | 0E | 1 | 00..7F | Pan | 0:random | 40 |
| | | | | | L63..C..R63(1..64..127) | | |

MIDI Data Format / MIDI-Datenformat / Format des données MIDI / Formato de datos MIDI ●●

| | | | | | | |
|----|----|---|--------|---------------------|---------------------|----|
| nn | 0F | 1 | 00..7F | Note Limit Low | C-2..G8 | 00 |
| nn | 10 | 1 | 00..7F | Note Limit High | C-2..G8 | 7F |
| nn | 11 | 1 | 00..7F | Dry Level | 0..127 | 7F |
| nn | 12 | 1 | 00..7F | Chorus Send | 0..127 | 00 |
| nn | 13 | 1 | 00..7F | Reverb Send | 0..127 | 28 |
| nn | 14 | 1 | 00..7F | Variation Send | 0..127 | 00 |
| | | | | | | |
| nn | 15 | 1 | 00..7F | Vibrato Rate | -64..+63 | 40 |
| nn | 16 | 1 | 00..7F | Vibrato Depth | -64..+63 | 40 |
| nn | 17 | 1 | 00..7F | Vibrato Delay | -64..+63 | 40 |
| nn | 18 | 1 | 00..7F | Filter Cutoff Freq. | -64..+63 | 40 |
| nn | 19 | 1 | 00..7F | Filter Resonance | -64..+63 | 40 |
| nn | 1A | 1 | 00..7F | EG Attack Time | -64..+63 | 40 |
| nn | 1B | 1 | 00..7F | EG Decay Time | -64..+63 | 40 |
| nn | 1C | 1 | 00..7F | EG Release Time | -64..+63 | 40 |
| | | | | | | |
| nn | 1D | 1 | 28..58 | MW Pitch Control | -24..+24[semitones] | 40 |
| nn | 1E | 1 | 00..7F | MW Filter Control | -9600..+9450[cent] | 40 |
| nn | 1F | 1 | 00..7F | MW Amp. Control | -100..+100[%] | 40 |
| nn | 20 | 1 | 00..7F | MW LFO PMod Depth | 0..127 | 0A |
| nn | 21 | 1 | 00..7F | MW LFO FMod Depth | 0..127 | 00 |
| nn | 22 | 1 | 00..7F | MW LFO AMod Depth | 0..127 | 00 |
| | | | | | | |
| nn | 23 | 1 | 28..58 | Bend Pitch Control | -24..+24[semitones] | 42 |
| nn | 24 | 1 | 00..7F | Bend Filter Control | -9600..+9450[cent] | 40 |
| nn | 25 | 1 | 00..7F | Bend Amp. Control | -100..+100[%] | 40 |
| nn | 26 | 1 | 00..7F | Bend LFO PMod Depth | 0..127 | 00 |
| nn | 27 | 1 | 00..7F | Bend LFO FMod Depth | 0..127 | 00 |
| nn | 28 | 1 | 00..7F | Bend LFO AMod Depth | 0..127 | 00 |

TOTAL SIZE 29

| | | | | | | |
|----|----|---|--------|-----------------------|---------------------|----|
| nn | 30 | | | Not Used | | |
| | : | | | : | | |
| nn | 40 | | | Not Used | | |
| | | | | | | |
| nn | 41 | 1 | 00..7F | Scale Tuning C | -64..+63[cent] | 40 |
| nn | 42 | 1 | 00..7F | Scale Tuning C# | -64..+63[cent] | 40 |
| nn | 43 | 1 | 00..7F | Scale Tuning D | -64..+63[cent] | 40 |
| nn | 44 | 1 | 00..7F | Scale Tuning D# | -64..+63[cent] | 40 |
| nn | 45 | 1 | 00..7F | Scale Tuning E | -64..+63[cent] | 40 |
| nn | 46 | 1 | 00..7F | Scale Tuning F | -64..+63[cent] | 40 |
| nn | 47 | 1 | 00..7F | Scale Tuning F# | -64..+63[cent] | 40 |
| nn | 48 | 1 | 00..7F | Scale Tuning G | -64..+63[cent] | 40 |
| nn | 49 | 1 | 00..7F | Scale Tuning G# | -64..+63[cent] | 40 |
| nn | 4A | 1 | 00..7F | Scale Tuning A | -64..+63[cent] | 40 |
| nn | 4B | 1 | 00..7F | Scale Tuning A# | -64..+63[cent] | 40 |
| nn | 4C | 1 | 00..7F | Scale Tuning B | -64..+63[cent] | 40 |
| | | | | | | |
| nn | 4D | 1 | 28..58 | CAT Pitch Control | -24..+24[semitones] | 40 |
| nn | 4E | 1 | 00..7F | CAT Filter Control | -9600..+9450[cent] | 40 |
| nn | 4F | 1 | 00..7F | CAT Amplitude Control | -100..+100[%] | 40 |
| nn | 50 | 1 | 00..7F | CAT LFO PMod Depth | 0..127 | 00 |
| nn | 51 | 1 | 00..7F | CAT LFO FMod Depth | 0..127 | 00 |
| nn | 52 | 1 | 00..7F | CAT LFO AMod Depth | 0..127 | 00 |
| | | | | | | |
| nn | 53 | | | Not Used | | |
| | : | | | : | | |
| | 66 | | | Not Used | | |
| | | | | | | |
| nn | 67 | 1 | 00..01 | Portamento Switch | off/on | 00 |
| nn | 68 | 1 | 00..7F | Portamento Time | 0..127 | 00 |
| | | | | | | |
| nn | 69 | | | Not Used | | |
| | : | | | : | | |
| | 6E | | | Not Used | | |

TOTAL SIZE 3F

nn = PartNumber

If there is a Drum Voice assigned to the Part, the following parameters are ineffective.

- Bank Select LSB
- Amp EG
- Portamento
- Soft Pedal
- Mono/Poly
- Scale Tuning

<Table 1-8 >

MIDI Parameter Change table (DRUM SETUP)

| Address (H) | Size | Data (H) | Parameter Name (H) | Description | Default | Value(H) | |
|-------------|------|----------|--------------------|-------------|----------------------|-------------------------------------|--------------------|
| 3n | rr | 00 | 1 | 00..7F | Pitch Coarse | -64..+63 | 40 |
| 3n | rr | 01 | 1 | 00..7F | Pitch Fine | -64..+63[cent] | 40 |
| 3n | rr | 02 | 1 | 00..7F | Level | 0..127 | Depend on the Note |
| 3n | rr | 03 | 1 | 00..7F | Alternate Group | 0:off,1..127 | Depend on the Note |
| 3n | rr | 04 | 1 | 00..7F | Pan | 0:random L63..C..R63(1..64..127) | Depend on the Note |
| 3n | rr | 05 | 1 | 00..7F | Reverb Send Level | 0..127 | Depend on the Note |
| 3n | rr | 06 | 1 | 00..7F | Chorus Send Level | 0..127 | Depend on the Note |
| 3n | rr | 07 | 1 | 00..7F | Variation Send Level | 0..127 | 7F |
| 3n | rr | 08 | 1 | 00..01 | Key Assign | 0:single,1:multi | 00 |
| 3n | rr | 09 | 1 | 00..01 | Rcv Note Off | off/on | Depend on the Note |
| 3n | rr | 0A | 1 | 00..01 | Rcv Note On | off/on | 01 |
| 3n | rr | 0B | 1 | 00..7F | Filter Cutoff Freq. | -64..63 | 40 |
| 3n | rr | 0C | 1 | 00..7F | Filter Resonance | -64..63 | 40 |
| 3n | rr | 0D | 1 | 00..7F | EG Attack Rate | -64..63 | 40 |
| 3n | rr | 0E | 1 | 00..7F | EG Decay1 Rate | -64..63 | 40 |
| 3n | rr | 0F | 1 | 00..7F | EG Decay2 Rate | -64..63 | 40 |

TOTAL SIZE 10

n:Drum Setup Number(0 - 1)

rr:note number(0DH - 54H)

If XG SYSTEM ON and/or GM On message is received, all Drum Setup Parameter will be reset to default values.

According to the Drum Setup Reset message, individual Drum Setup Parameters can be reset to default values.

< Table 1-9 > Effect Type List

| | |
|--|---------------------|
| | XG ESSENTIAL EFFECT |
| | Same as LSB=0 |
| | XG OPTION EFFECT |

* If the received value does not contain an effect type in the TYPE LSB, The LSB will be directed to TYPE 0.

* Panel Effects are based on the "[Number] Effect Name".

REVERB TYPE

| TYPE | TYPE LSB | 01 | 02 | 03..07 | 08 | 09..15 | 16 | 17 | 18 | 19 | 20 | 21.. |
|----------|----------------|------------|----------|--------|----|--------|----------|------------|----------|----------|----|------|
| 000 | NO EFFECT | | | | | | | | | | | |
| 001 | [1]HALL1 | [2]HALL2 | | | | | [3]HALL3 | [4]HALL4 | [5]HALL5 | | | |
| 002 | [6]ROOM1 | ROOM2 | [7]ROOM2 | | | | [8]ROOM3 | ROOM | ROOM | [9]ROOM4 | | |
| 003 | [10]STAGE1 | [11]STAGE2 | | | | | STAGE | [12]STAGE3 | | | | |
| 004 | [13]PLATE | | | | | | PLATE | PLATE | | | | |
| 005..015 | NO EFFECT | | | | | | | | | | | |
| 016 | [14]WHITE ROOM | | | | | | | | | | | |
| 017 | [15]TUNNEL | | | | | | | | | | | |
| 018 | CANYON | | | | | | | | | | | |
| 019 | [16]BASEMENT | | | | | | | | | | | |
| 020..127 | NO EFFECT | | | | | | | | | | | |

CHORUS TYPE

| TYPE | TYPE LSB | 01 | 02 | 03..07 | 08 | 09..15 | 16 | 17 | 18 | 19 | 20 | 21.. |
|----------|-----------------|----------|----------|--------|----------|--------|---------|---------|----|----|----|------|
| 000 | NO EFFECT | | | | | | | | | | | |
| 001..064 | NO EFFECT | | | | | | | | | | | |
| 065 | CHORUS1 | CHORUS2 | CHORUS3 | | CHORUS4 | | | | | | | |
| 066 | CELESTE1 | CELESTE2 | CELESTE3 | | CELESTE4 | | CELESTE | CELESTE | | | | |
| 067 | FLANGER 1 | FLANGER2 | | | FLANGER3 | | FLANGER | FLANGER | | | | |
| 068 | SYMPHONIC | | | | | | | | | | | |
| 069..071 | NO EFFECT | | | | | | | | | | | |
| 072 | PHASER 1 | | | | | | | | | | | |
| 073..086 | NO EFFECT | | | | | | | | | | | |
| 087 | ENSEMBLE DETUNE | | | | | | | | | | | |
| 088..127 | NO EFFECT | | | | | | | | | | | |

MIDI Data Format / MIDI-Datenformat / Format des données MIDI / Formato de datos MIDI ●●

VARIATION EFFECT TYPE

| TYPE | TYPE LSB | | | | | | | | | | | |
|----------|-----------------|-----------------|---------------------|--------|-------------|--------|---------------|-------------|-----------------|-----------|---------|-------------|
| MSB | 00 | 01 | 02 | 03..07 | 08 | 09..15 | 16 | 17 | 18 | 19 | 20 | 21.. |
| 000 | NO EFFECT | | | | | | | | | | | |
| 001 | [1]HALL1 | [2]HALL2 | | | | | [3]HALL3 | HALL | HALL | | | |
| 002 | [4]ROOM1 | ROOM2 | [5]ROOM2 | | | | [6]ROOM3 | ROOM | ROOM | ROOM | | |
| 003 | [7]STAGE1 | [8]STAGE2 | | | | | STAGE | [9]STAGE3 | | | | |
| 004 | PLATE | | | | | | PLATE | PLATE | | | | |
| 005 | DELAY L,C,R | | | | | | [17]DELAY LCR | | | | | |
| 006 | [18]DELAY L,R | | | | | | | | | | | |
| 007 | [19]ECHO | | | | | | | | | | | |
| 008 | [20]CROSS DELAY | | | | | | | | | | | |
| 009 | ER1 | ER2 | | | | | | | | | | |
| 010 | GATE REVERB | | | | | | | | | | | |
| 011 | REVERS GATE | | | | | | | | | | | |
| 012..015 | NO EFFECT | | | | | | | | | | | |
| 016 | WHITE ROOM | | | | | | | | | | | |
| 017 | TUNNEL | | | | | | | | | | | |
| 018 | CANYON | | | | | | | | | | | |
| 019 | BASEMENT | | | | | | | | | | | |
| 020 | KARAOKE 1 | KARAOKE 2 | KARAOKE 3 | | | | | | | | | |
| 021..063 | NO EFFECT | | | | | | | | | | | |
| 064 | THRU | | | | | | | | | | | |
| 065 | CHORUS1 | CHORUS2 | CHORUS | | CHORUS | | | | | | | |
| 066 | [13]CELESTE | [12]CHORUS3 | CELESTE3 | | [11]CHORUS2 | | CHORUS | [10]CHORUS1 | [22] [23]ROTARY | | | |
| 067 | FLANGER 1 | FLANGER | | | FLANGER | | [14]FLANGER | FLANGER | | | | |
| 068 | SYMPHONIC | | | | | | [15]SYMPHONIC | | | | | |
| 069 | ROTARY SP. | | | | | | Rotary Sp | | | | | |
| 070 | TREMOLO | | | | | | [21]TREMOLO | Rotary Sp | | | | |
| 071 | AUTO PAN | | | | | | [16]AUTO PAN | Rotary Sp | Rotary Sp | Rotary Sp | Tremolo | Gtr Tremolo |
| 072 | [24]PHASER | | | | PHASER | | | | | | | |
| 073 | DISTORTION | COMP+DISTORTION | | | | | | | | | | |
| 074 | OVER DRIVE | | | | | | | | | | | |
| 075 | AMP SIM. | | | | | | | | | | | |
| 076 | 3BAND EQ | | | | | | DIST.HARD | DIST.SOFT | | | | |
| 077 | 2BAND EQ | | | | | | EQ DISCO | EQ TEL | | | | |
| 078 | AUTO WAH | AUTO WAH+DIST | AUTO WAH+OVERDRIVE | | | | [25]WAH | | | | | |
| 079 | THRU | | | | | | | | | | | |
| 080 | PITCH CHANGE | PITCH CHANGE2 | | | | | | | | | | |
| 081 | THRU | | | | | | | | | | | |
| 082 | TOUCH WAH 1 | TOUCH WAH+DIST | TOUCH WAH+OVERDRIVE | | TOUCH WAH 2 | | | | | | | |
| 083 | COMPRESSOR | | | | | | | | | | | |
| 084 | NOISE GATE | | | | | | | | | | | |
| 085 | VOICE CANCEL | | | | | | | | | | | |
| 086 | 2WAY ROTARY SP | | | | | | | | | | | |
| 087 | ENSEMBLE DETUNE | | | | | | | | | | | |
| 088 | AMBIENCE | | | | | | | | | | | |
| 089..127 | THRU | | | | | | | | | | | |

INSERTION EFFECT TYPE

| TYPE | TYPE LSB | | | | | | | | | | | |
|----------|------------------|-----------|-----------|--------|-------------|--------|-----------|-----------|-----------|---------|-------------|------|
| MSB | 00 | 01 | 02 | 03..07 | 08 | 09..15 | 16 | 17 | 18 | 19 | 20 | 21.. |
| 000 | THRU | | | | | | | | | | | |
| 001 | HALL 1 | HALL 2 | | | | | HALL | HALL | HALL | | | |
| 002 | ROOM 1 | ROOM 2 | ROOM 3 | | | | ROOM | ROOM | ROOM | ROOM | | |
| 003 | STAGE 1 | STAGE 2 | | | | | STAGE | STAGE | | | | |
| 004 | PLATE | | | | | | PLATE | PLATE | | | | |
| 005 | DELAY L,C,R | | | | | | Delay LCR | | | | | |
| 006 | DELAY L,R | | | | | | | | | | | |
| 007 | ECHO | | | | | | | | | | | |
| 008 | CROSS DELAY | | | | | | | | | | | |
| 009..019 | THRU | | | | | | | | | | | |
| 020 | KARAOKE 1 | KARAOKE 2 | KARAOKE 3 | | | | | | | | | |
| 021..064 | THRU | | | | | | | | | | | |
| 065 | CHORUS 1 | CHORUS 2 | CHORUS 3 | | CHORUS 4 | | | | | | | |
| 066 | CELESTE 1 | CELESTE 2 | CELESTE 3 | | CELESTE 4 | | CHORUS | CHORUS | Rotary Sp | | | |
| 067 | FLANGER 1 | FLANGER 2 | | | FLANGER 3 | | FLANGER | FLANGER | | | | |
| 068 | SYMPHONIC | | | | | | Symphonic | | | | | |
| 069 | ROTARY SPEAKER 1 | | | | | | Rotary Sp | | | | | |
| 070 | TREMOLO | | | | | | Tremolo | Rotary Sp | | | | |
| 071 | AUTO PAN | | | | | | AutoPan | Rotary Sp | Rotary Sp | Tremolo | Gtr Tremolo | |
| 072 | PHASER 1 | | | | | | | | | | | |
| 073 | DISTORTION | | | | | | | | | | | |
| 074 | OVER DRIVE | | | | | | | | | | | |
| 075 | AMP SIMULATOR | | | | | | | | | | | |
| 076 | 3BAND EQ | | | | | | DIST.HARD | DIST.SOFT | | | | |
| 077 | 2-BAND EQ | | | | | | EQ DISCO | EQ TEL | | | | |
| 078 | AUTO WAH(LFO) | | | | | | Auto Wah | | | | | |
| 079..081 | THRU | | | | | | | | | | | |
| 082 | TOUCH WAH 1 | | | | TOUCH WAH 2 | | | | | | | |
| 083 | COMPRESSOR | | | | | | | | | | | |
| 084 | NOISE GATE | | | | | | | | | | | |
| 085..086 | THRU | | | | | | | | | | | |
| 087 | ENSEMBLE DETUNE | | | | | | | | | | | |
| 088..127 | THRU | | | | | | | | | | | |

< Table 1-10 > Effect Parameter List

HALL1,HALL2, ROOM1,ROOM2,ROOM3, STAGE1,STAGE2
PLATE (reverb, variation, insertion block)

| No. | Parameter | Value | See Table | Control |
|-----|----------------|--|------------|---------|
| 1 | Reverb Time | 0.3-30.0s | 0-69 | table#4 |
| 2 | Diffusion | 0-10 | 0-10 | |
| 3 | Initial Delay | 0-63 | table#5 | |
| 4 | HPF Cutoff | Thru-8.0kHz | 0-52 | table#3 |
| 5 | LPF Cutoff | 1.0k-Thru | 34-60 | table#3 |
| 6 | | | | |
| 7 | | | | |
| 8 | | | | |
| 9 | | | | |
| 10 | Dry/Wet | D63>W - D=W - D<W63 | 1-127 | ● |
| 11 | Rev Delay | 0-63 | table#5 | |
| 12 | Density | 0-4 (reverb, variation block) 0-2 (insertion block) | 0-4 0-2 | |
| 13 | Er/Rev Balance | E63>R - E=R - E<R63 | 1-127 | |
| 14 | High Damp | 0.1-1.0 | 1-10 | |
| 15 | Feedback Level | -63+63 | 1-127 | |
| 16 | | | | |

WHITE ROOM, TUNNEL, CANYON, BASEMENT (reverb, variation block)

| No. | Parameter | Value | See Table | Control |
|-----|----------------|---------------------|-----------|----------|
| 1 | Reverb Time | 0.3-30.0s | 0-69 | table#4 |
| 2 | Diffusion | 0-10 | 0-10 | |
| 3 | Initial Delay | 0-63 | table#5 | |
| 4 | HPF Cutoff | Thru-8.0kHz | 0-52 | table#3 |
| 5 | LPF Cutoff | 1.0k-Thru | 34-60 | table#3 |
| 6 | Width | 0.5-10.2m | 0-37 | table#11 |
| 7 | Height | 0.5-20.2m | 0-73 | table#11 |
| 8 | Depth | 0.5-30.2m | 0-104 | table#11 |
| 9 | Wall Vary | 0-30 | 0-30 | |
| 10 | Dry/Wet | D63>W - D=W - D<W63 | 1-127 | ● |
| 11 | Rev Delay | 0-63 | table#5 | |
| 12 | Density | 0-4 | 0-4 | |
| 13 | Er/Rev Balance | E63>R - E=R - E<R63 | 1-127 | |
| 14 | High Damp | 0.1-1.0 | 1-10 | |
| 15 | Feedback Level | -63+63 | 1-127 | |
| 16 | | | | |

DELAY L,C,R (variation, insertion block)

| No. | Parameter | Value | See Table | Control |
|-----|-------------------|---|-------------------|---------|
| 1 | Lch Delay | 0.1-1486.0ms (variation block) 0.1-742.9ms (insertion block) | 1-14860 1-7429 | |
| 2 | Rch Delay | 0.1-1486.0ms (variation block) 0.1-742.9ms (insertion block) | 1-14860 1-7429 | |
| 3 | Cch Delay | 0.1-1486.0ms (variation block) 0.1-742.9ms (insertion block) | 1-14860 1-7429 | |
| 4 | Feedback Delay | 0.1-1486.0ms (variation block) 0.1-742.9ms (insertion block) | 1-14860 1-7429 | |
| 5 | Feedback Level | -63+63 | 1-127 | |
| 6 | Cch Level | 0-127 | 0-127 | |
| 7 | High Damp | 0.1-1.0 | 1-10 | |
| 8 | | | | |
| 9 | | | | |
| 10 | Dry/Wet | D63>W - D=W - D<W63 | 1-127 | ● |
| 11 | | | | |
| 12 | | | | |
| 13 | EQ Low Frequency | 32Hz-2.0kHz | 4-40 | table#3 |
| 14 | EQ Low Gain | -12+12dB | 52-76 | |
| 15 | EQ High Frequency | 500Hz-16.0kHz | 28-58 | table#3 |
| 16 | EQ High Gain | -12+12dB | 52-76 | |

DELAY L,R (variation, insertion block)

| No. | Parameter | Value | See Table | Control |
|-----|-------------------|---|-------------------|---------|
| 1 | Lch Delay | 0.1-1486.0ms (variation block) 0.1-742.9ms (insertion block) | 1-14860 1-7429 | |
| 2 | Rch Delay | 0.1-1486.0ms (variation block) 0.1-742.9ms (insertion block) | 1-14860 1-7429 | |
| 3 | Feedback Delay 1 | 0.1-1486.0ms (variation block) 0.1-742.9ms (insertion block) | 1-14860 1-7429 | |
| 4 | Feedback Delay 2 | 0.1-1486.0ms (variation block) 0.1-742.9ms (insertion block) | 1-14860 1-7429 | |
| 5 | Feedback Level | -63+63 | 1-127 | |
| 6 | High Damp | 0.1-1.0 | 1-10 | |
| 7 | | | | |
| 8 | | | | |
| 9 | | | | |
| 10 | Dry/Wet | D63>W - D=W - D<W63 | 1-127 | ● |
| 11 | | | | |
| 12 | | | | |
| 13 | EQ Low Frequency | 32Hz-2.0kHz | 4-40 | table#3 |
| 14 | EQ Low Gain | -12+12dB | 52-76 | |
| 15 | EQ High Frequency | 500Hz-16.0kHz | 28-58 | table#3 |
| 16 | EQ High Gain | -12+12dB | 52-76 | |

ECHO (variation, insertion block)

| No. | Parameter | Value | See Table | Control |
|-----|--------------------|--|------------------|---------|
| 1 | Lch Delay1 | 0.1-743.0ms (variation block) 0.1-371.4ms (insertion block) | 1-7430 1-3714 | |
| 2 | Lch Feedback Level | -63+63 | 1-127 | |
| 3 | Rch Delay1 | 0.1-743.0ms (variation block) 0.1-371.4ms (insertion block) | 1-7430 1-3714 | |
| 4 | Rch Feedback Level | -63+63 | 1-127 | |
| 5 | High Damp | 0.1-1.0 | 1-10 | |
| 6 | Lch Delay2 | 0.1-743.0ms (variation block) 0.1-371.4ms (insertion block) | 1-7430 1-3714 | |
| 7 | Rch Delay2 | 0.1-743.0ms (variation block) 0.1-371.4ms (insertion block) | 1-7430 1-3714 | |
| 8 | Delay2 Level | 0-127 | 0-127 | |
| 9 | | | | |
| 10 | Dry/Wet | D63>W - D=W - D<W63 | 1-127 | ● |
| 11 | | | | |
| 12 | | | | |
| 13 | EQ Low Frequency | 32Hz-2.0kHz | 4-40 | table#3 |
| 14 | EQ Low Gain | -12+12dB | 52-76 | |
| 15 | EQ High Frequency | 500Hz-16.0kHz | 28-58 | table#3 |
| 16 | EQ High Gain | -12+12dB | 52-76 | |

CROSS DELAY (variation, insertion block)

| No. | Parameter | Value | See Table | Control |
|-----|-------------------|--|------------------|---------|
| 1 | L->R Delay | 0.1-743.0ms (variation block) 0.1-371.4ms (insertion block) | 1-7430 1-3714 | |
| 2 | R->L Delay | 0.1-743.0ms (variation block) 0.1-371.4ms (insertion block) | 1-7430 1-3714 | |
| 3 | Feedback Level | -63+63 | 1-127 | |
| 4 | Input Select | L,R,L&R | 0-2 | |
| 5 | High Damp | 0.1-1.0 | 1-10 | |
| 6 | | | | |
| 7 | | | | |
| 8 | | | | |
| 9 | Dry/Wet | D63>W - D=W - D<W63 | 1-127 | ● |
| 10 | | | | |
| 11 | | | | |
| 12 | | | | |
| 13 | EQ Low Frequency | 32Hz-2.0kHz | 4-40 | table#3 |
| 14 | EQ Low Gain | -12+12dB | 52-76 | |
| 15 | EQ High Frequency | 500Hz-16.0kHz | 28-58 | table#3 |
| 16 | EQ High Gain | -12+12dB | 52-76 | |

EARLY REF1,EARLY REF2(variation block)

| No. | Parameter | Value | See Table | Control |
|-----|----------------|------------------------------|-----------|---------|
| 1 | Type | S-H, L-H, Rdm, Rvs, Plt, Spr | 0-5 | |
| 2 | Room Size | 0.1-7.0 | 0-44 | table#6 |
| 3 | Diffusion | 0-10 | 0-10 | |
| 4 | Initial Delay | 0-63 | 0-63 | table#5 |
| 5 | Feedback Level | -63+63 | 1-127 | |
| 6 | HPF Cutoff | Thru-8.0kHz | 0-52 | table#3 |
| 7 | LPF Cutoff | 1.0k-Thru | 34-60 | table#3 |
| 8 | | | | |
| 9 | | | | |
| 10 | Dry/Wet | D63>W - D=W - D<W63 | 1-127 | ● |
| 11 | Liveness | 0-10 | 0-10 | |
| 12 | Density | 0-3 | 0-3 | |
| 13 | High Damp | 0.1-1.0 | 1-10 | |
| 14 | | | | |
| 15 | | | | |
| 16 | | | | |

GATE REVERB, REVERSE GATE (variation block)

| No. | Parameter | Value | See Table | Control |
|-----|----------------|---------------------|-----------|---------|
| 1 | Type | TypeA, TypeB | 0-1 | |
| 2 | Room Size | 0.1-20.0 | 0-127 | table#6 |
| 3 | Diffusion | 0-10 | 0-10 | |
| 4 | Initial Delay | 0-127 | 0-127 | table#5 |
| 5 | Feedback Level | -63+63 | 1-127 | |
| 6 | HPF Cutoff | Thru-8.0kHz | 0-52 | table#3 |
| 7 | LPF Cutoff | 1.0k-Thru | 34-60 | table#3 |
| 8 | | | | |
| 9 | | | | |
| 10 | Dry/Wet | D63>W - D=W - D<W63 | 1-127 | ● |
| 11 | Liveness | 0-10 | 0-10 | |
| 12 | Density | 0-3 | 0-3 | |
| 13 | High Damp | 0.1-1.0 | 1-10 | |
| 14 | | | | |
| 15 | | | | |
| 16 | | | | |

KARAOKE1,2,3 (variation, insertion block)

| No. | Parameter | Value | See Table | Control |
|-----|----------------|---------------------|-----------|---------|
| 1 | Delay Time | 0-127 | 0-127 | table#7 |
| 2 | Feedback Level | -63+63 | 1-127 | |
| 3 | HPF Cutoff | Thru-8.0kHz | 0-52 | table#3 |
| 4 | LPF Cutoff | 1.0k-Thru | 34-60 | table#3 |
| 5 | | | | |
| 6 | | | | |
| 7 | | | | |
| 8 | | | | |
| 9 | | | | |
| 10 | Dry/Wet | D63>W - D=W - D<W63 | 1-127 | ● |
| 11 | | | | |
| 12 | | | | |
| 13 | | | | |
| 14 | | | | |
| 15 | | | | |
| 16 | | | | |

CHORUS1,2,3,4, CELESTE1,2,3,4 (chorus, variation, insertion block)

| No. | Parameter | Value | See Table | Control |
|-----|-------------------|---------------------------------|-----------|---------|
| 1 | LFO Frequency | 0.00Hz-39.7Hz | 0-127 | table#1 |
| 2 | LFO Depth | 0-127 | 0-127 | |
| 3 | Feedback Level | -63+63 | 1-127 | |
| 4 | Delay Offset | 0-127 | 0-127 | table#2 |
| 5 | | | | |
| 6 | EQ Low Frequency | 32Hz-2.0kHz | 4-40 | table#3 |
| 7 | EQ Low Gain | -12+12dB | 52-76 | |
| 8 | EQ High Frequency | 500Hz-16.0kHz | 28-58 | table#3 |
| 9 | EQ High Gain | -12+12dB | 52-76 | |
| 10 | Dry/Wet | D63>W - D=W - D<W63 | 1-127 | ● |
| 11 | | | | |
| 12 | EQ Mid Frequency | 100Hz-10.0kHz (variation block) | 14-54 | table#3 |
| 13 | EQ Mid Gain | -12+12dB (variation block) | 52-76 | |
| 14 | EQ Mid Width | 1.0-12.0 (variation block) | 10-120 | |
| 15 | | | | |
| 16 | Input Mode | mono/stereo | 0-1 | |

FLANGER1,2,3 (chorus, variation, insertion block)

| No. | Parameter | Value | See Table | Control |
|-----|----------------------|---------------------------------|-----------|---------|
| 1 | LFO Frequency | 0.00Hz-39.7Hz | 0-127 | table#1 |
| 2 | LFO Depth | 0-127 | 0-127 | |
| 3 | Feedback Level | -63+63 | 1-127 | |
| 4 | Delay Offset | 0-127 | 0-127 | table#2 |
| 5 | | | | |
| 6 | EQ Low Frequency | 32Hz-2.0kHz | 4-40 | table#3 |
| 7 | EQ Low Gain | -12+12dB | 52-76 | |
| 8 | EQ High Frequency | 500Hz-16.0kHz | 28-58 | table#3 |
| 9 | EQ High Gain | -12+12dB | 52-76 | |
| 10 | Dry/Wet | D63>W - D=W - D<W63 | 1-127 | ● |
| 11 | | | | |
| 12 | EQ Mid Frequency | 100Hz-10.0kHz (variation block) | 14-54 | table#3 |
| 13 | EQ Mid Gain | -12+12dB (variation block) | 52-76 | |
| 14 | EQ Mid Width | 1.0-12.0 (variation block) | 10-120 | |
| 15 | LFO Phase Difference | -180+180deg(resolution=3deg.) | 4-124 | |
| 16 | | | | |

MIDI Data Format / MIDI-Datenformat / Format des données MIDI / Formato de datos MIDI ●●

SYMPHONIC (chorus, variation, insertion block)

| No. | Parameter | Value | See Table | Control |
|-----|-------------------|---------------------------------|-----------|---------|
| 1 | LFO Frequency | 0.00Hz–39.7Hz | 0–127 | table#1 |
| 2 | LFO Depth | 0–127 | 0–127 | |
| 3 | Delay Offset | 0–127 | table#2 | |
| 4 | | | | |
| 5 | | | | |
| 6 | EQ Low Frequency | 32Hz–2.0kHz | 4–40 | table#3 |
| 7 | EQ Low Gain | -12→+12dB | 52–76 | |
| 8 | EQ High Frequency | 500Hz–16.0kHz | 28–58 | table#3 |
| 9 | EQ High Gain | -12→+12dB | 52–76 | |
| 10 | Dry/Wet | D63>W – D=W – D<W63 | 1–127 | ● |
| 11 | EQ Mid Frequency | 100Hz–10.0kHz (variation block) | 14–54 | table#3 |
| 12 | EQ Mid Gain | -12→+12dB (variation block) | 52–76 | |
| 13 | EQ Mid Width | 1.0–12.0 (variation block) | 10–120 | |
| 14 | | | | |
| 15 | | | | |
| 16 | | | | |

ENSEMBLE DETUNE (chorus, variation, insertion block)

| No. | Parameter | Value | See Table | Control |
|-----|-------------------|--|-----------|---------|
| 1 | Detune | -50→+50cent | 14–114 | |
| 2 | Lch Init Delay | 0–127 | 0–127 | table#2 |
| 3 | Rch Init Delay | 0–127 | 0–127 | table#2 |
| 4 | | | | |
| 5 | | | | |
| 6 | | | | |
| 7 | | | | |
| 8 | | | | |
| 9 | | | | |
| 10 | Dry/Wet | D63>W – D=W – D<W63 | 1–127 | ● |
| 11 | EQ Low Frequency | 32Hz–2.0kHz (variation, insertion block) | 4–40 | table#3 |
| 12 | EQ Low Gain | -12→+12dB (variation, insertion block) | 52–76 | |
| 13 | EQ High Frequency | 500Hz–16.0kHz (variation, insertion block) | 28–58 | table#3 |
| 14 | EQ High Gain | -12→+12dB (variation, insertion block) | 52–76 | |
| 15 | | | | |
| 16 | | | | |

AMBIENCE (variation block)

| No. | Parameter | Value | See Table | Control |
|-----|-------------------|---------------------|-----------|---------|
| 1 | Delay Time | 0–127 | 0–127 | table#2 |
| 2 | Output Phase | normal/invers | 0–1 | |
| 3 | | | | |
| 4 | | | | |
| 5 | | | | |
| 6 | EQ Low Frequency | 32Hz–2.0kHz | 4–40 | table#3 |
| 7 | EQ Low Gain | -12→+12dB | 52–76 | |
| 8 | EQ High Frequency | 500Hz–16.0kHz | 28–58 | table#3 |
| 9 | EQ High Gain | -12→+12dB | 52–76 | |
| 10 | Dry/Wet | D63>W – D=W – D<W63 | 1–127 | ● |
| 11 | | | | |
| 12 | | | | |
| 13 | | | | |
| 14 | | | | |
| 15 | | | | |
| 16 | | | | |

ROTARY SPEAKER (variation, insertion block)

| No. | Parameter | Value | See Table | Control |
|-----|-------------------|---------------------------------|-----------|---------|
| 1 | LFO Frequency | 0.00Hz–39.7Hz | 0–127 | table#1 |
| 2 | LFO Depth | 0–127 | 0–127 | |
| 3 | | | | |
| 4 | | | | |
| 5 | | | | |
| 6 | EQ Low Frequency | 32Hz–2.0kHz | 4–40 | table#3 |
| 7 | EQ Low Gain | -12→+12dB | 52–76 | |
| 8 | EQ High Frequency | 500Hz–16.0kHz | 28–58 | table#3 |
| 9 | EQ High Gain | -12→+12dB | 52–76 | |
| 10 | Dry/Wet | D63>W – D=W – D<W63 | 1–127 | ● |
| 11 | EQ Mid Frequency | 100Hz–10.0kHz (variation block) | 14–54 | table#3 |
| 12 | EQ Mid Gain | -12→+12dB (variation block) | 52–76 | |
| 13 | EQ Mid Width | 1.0–12.0 (variation block) | 10–120 | |
| 14 | | | | |
| 15 | | | | |
| 16 | | | | |

2WAY ROTARY SPEAKER (variation block)

| No. | Parameter | Value | See Table | Control |
|-----|---------------------|-------------------------------|-----------|---------|
| 1 | Rotor Speed | 0.0Hz–39.7Hz | 0–127 | table#1 |
| 2 | Drive Low | 0–127 | 0–127 | |
| 3 | Drive High | 0–127 | 0–127 | |
| 4 | Low/High | L63>H – L=H – L<H63 | 1–127 | |
| 5 | | | | |
| 6 | EQ Low Frequency | 32Hz–2.0kHz | 4–40 | table#3 |
| 7 | EQ Low Gain | -12→+12dB | 52–76 | |
| 8 | EQ High Frequency | 500Hz–16.0kHz | 28–58 | table#3 |
| 9 | EQ High Gain | -12→+12dB | 52–76 | |
| 10 | | | | |
| 11 | Crossover Frequency | 100Hz–10.0kHz | 14–54 | table#3 |
| 12 | Mic L-R Angle | 0deg–180deg(resolution=3deg.) | 0–60 | |
| 13 | | | | |
| 14 | | | | |
| 15 | | | | |
| 16 | | | | |

TREMOLO (variation, insertion block)

| No. | Parameter | Value | See Table | Control |
|-----|----------------------|---------------------------------|-----------|---------|
| 1 | LFO Frequency | 0.00Hz–39.7Hz | 0–127 | table#1 |
| 2 | AM Depth | 0–127 | 0–127 | |
| 3 | PM Depth | 0–127 | 0–127 | |
| 4 | | | | |
| 5 | | | | |
| 6 | EQ Low Frequency | 32Hz–2.0kHz | 4–40 | table#3 |
| 7 | EQ Low Gain | -12→+12dB | 52–76 | |
| 8 | EQ High Frequency | 500Hz–16.0kHz | 28–58 | table#3 |
| 9 | EQ High Gain | -12→+12dB | 52–76 | |
| 10 | | | | |
| 11 | EQ Mid Frequency | 100Hz–10.0kHz (variation block) | 14–54 | table#3 |
| 12 | EQ Mid Gain | -12→+12dB (variation block) | 52–76 | |
| 13 | EQ Mid Width | 1.0–12.0 (variation block) | 10–120 | |
| 14 | LFO Phase Difference | -180→+180deg(resolution=3deg.) | 4–124 | |
| 15 | Input Mode | mono/stereo | 0–1 | |
| 16 | | | | |

AUTO PAN (variation, insertion block)

| No. | Parameter | Value | See Table | Control |
|-----|-------------------|---------------------------------|-----------|---------|
| 1 | LFO Frequency | 0.00Hz–39.7Hz | 0–127 | table#1 |
| 2 | L/R Depth | 0–127 | 0–127 | |
| 3 | F/R Depth | 0–127 | 0–127 | |
| 4 | PAN Direction | L<->R,L->R,L<-R,Lturn,Rturn,L/R | 0–5 | |
| 5 | | | | |
| 6 | EQ Low Frequency | 32Hz–2.0kHz | 4–40 | table#3 |
| 7 | EQ Low Gain | -12→+12dB | 52–76 | |
| 8 | EQ High Frequency | 500Hz–16.0kHz | 28–58 | table#3 |
| 9 | EQ High Gain | -12→+12dB | 52–76 | |
| 10 | | | | |
| 11 | EQ Mid Frequency | 100Hz–10.0kHz (variation block) | 14–54 | table#3 |
| 12 | EQ Mid Gain | -12→+12dB (variation block) | 52–76 | |
| 13 | EQ Mid Width | 1.0–12.0 (variation block) | 10–120 | |
| 14 | | | | |
| 15 | | | | |
| 16 | | | | |

PHASER 1 (chorus, variation, insertion block)

| No. | Parameter | Value | See Table | Control |
|-----|--------------------|-----------------------------------|-----------|---------|
| 1 | LFO Frequency | 0.00Hz–39.7Hz | 0–127 | table#1 |
| 2 | LFO Depth | 0–127 | 0–127 | |
| 3 | Phase Shift Offset | 0–127 | 0–127 | |
| 4 | Feedback Level | -63→+63 | 1–127 | |
| 5 | | | | |
| 6 | EQ Low Frequency | 32Hz–2.0kHz | 4–40 | table#3 |
| 7 | EQ Low Gain | -12→+12dB | 52–76 | |
| 8 | EQ High Frequency | 500Hz–16.0kHz | 28–58 | table#3 |
| 9 | EQ High Gain | -12→+12dB | 52–76 | |
| 10 | Dry/Wet | D63>W – D=W – D<W63 | 1–127 | ● |
| 11 | Stage | 4, 5, 6 (chorus, insertion block) | 4–6 | |
| 12 | Diffusion | 4→12 (variation block) | 4–12 | |
| 13 | | mono/stereo | 0–1 | |
| 14 | | | | |
| 15 | | | | |
| 16 | | | | |

PHASER 2 (variation block)

| No. | Parameter | Value | See Table | Control |
|-----|----------------------|-----------------------------------|-----------|---------|
| 1 | LFO Frequency | 0.00Hz–39.7Hz | 0–127 | table#1 |
| 2 | LFO Depth | 0–127 | 0–127 | |
| 3 | Phase Shift Offset | 0–127 | 0–127 | |
| 4 | Feedback Level | -63→+63 | 1–127 | |
| 5 | | | | |
| 6 | EQ Low Frequency | 32Hz–2.0kHz | 4–40 | table#3 |
| 7 | EQ Low Gain | -12→+12dB | 52–76 | |
| 8 | EQ High Frequency | 500Hz–16.0kHz | 28–58 | table#3 |
| 9 | EQ High Gain | -12→+12dB | 52–76 | |
| 10 | Dry/Wet | D63>W – D=W – D<W63 | 1–127 | ● |
| 11 | Stage | 3, 4, 5, 6 | 3–6 | |
| 12 | | | | |
| 13 | LFO Phase Difference | -180deg→+180deg(resolution=3deg.) | 4–124 | |
| 14 | | | | |
| 15 | | | | |
| 16 | | | | |

DISTORTION, OVERDRIVE (variation, insertion block)

| No. | Parameter | Value | See Table | Control |
|-----|------------------|---------------------|-----------|------------|
| 1 | Drive | 0–127 | 0–127 | table#1 |
| 2 | EQ Low Frequency | 32Hz–2.0kHz | 4–40 | table#3 |
| 3 | EQ Low Gain | -12→+12dB | 52–76 | |
| 4 | LPF Cutoff | 1.0k–Thru | 34–60 | table#3 |
| 5 | Output Level | 0–127 | 0–127 | |
| 6 | | | | |
| 7 | EQ Mid Frequency | 100Hz–10.0kHz | 14–54 | table#3 |
| 8 | EQ Mid Gain | -12→+12dB | 52–76 | |
| 9 | EQ Mid Width | 1.0–12.0 | 10–120 | |
| 10 | Dry/Wet | D63>W – D=W – D<W63 | 1–127 | ● |
| 11 | Edge(Clip Curve) | 0–127 | 0–127 | mild-sharp |
| 12 | | | | |
| 13 | | | | |
| 14 | | | | |
| 15 | | | | |
| 16 | | | | |

COMP+DIST (variation block)

| No. | Parameter | Value | See Table | Control |
|-----|------------------|---------------------|-----------|------------|
| 1 | Drive | 0–127 | 0–127 | table#1 |
| 2 | EQ Low Frequency | 32Hz–2.0kHz | 4–40 | table#3 |
| 3 | EQ Low Gain | -12→+12dB | 52–76 | |
| 4 | LPF Cutoff | 1.0k–Thru | 34–60 | table#3 |
| 5 | Output Level | 0–127 | 0–127 | |
| 6 | | | | |
| 7 | EQ Mid Frequency | 100Hz–10.0kHz | 14–54 | table#3 |
| 8 | EQ Mid Gain | -12→+12dB | 52–76 | |
| 9 | EQ Mid Width | 1.0–12.0 | 10–120 | |
| 10 | Dry/Wet | D63>W – D=W – D<W63 | 1–127 | ● |
| 11 | Edge(Clip Curve) | 0–127 | 0–127 | mild-sharp |
| 12 | Attack | 1ms–40ms | 0–19 | table#8 |
| 13 | Release | 10ms–680ms | 0–15 | table#9 |
| 14 | Threshold | -48dB–6dB | 79–121 | |
| 15 | Ratio | 1.0–20.0 | 0–7 | table#10 |
| 16 | | | | |

AMP SIMULATOR (variation, insertion block)

| No. | Parameter | Value | See Table | Control |
|-----|------------------|------------------------|-----------|------------|
| 1 | Drive | 0-127 | | ● |
| 2 | AMP Type | Off Stack, Combo, Tube | | |
| 3 | LPF Cutoff | 1.0k-Thru | table#3 | |
| 4 | Output Level | 0-127 | | |
| 5 | | | | |
| 6 | | | | |
| 7 | | | | |
| 8 | | | | |
| 9 | Dry/Wet | D63>W - D=W - D<W63 | | |
| 10 | | | | |
| 11 | Edge(Clip Curve) | 0-127 | | mild-sharp |
| 12 | | | | |
| 13 | | | | |
| 14 | | | | |
| 15 | | | | |
| 16 | | | | |

3BAND EQ(MONO) (variation, insertion block)

| No. | Parameter | Value | See Table | Control |
|-----|-------------------|---------------|-----------|---------|
| 1 | EQ Low Gain | -12+12dB | | |
| 2 | EQ Mid Frequency | 100Hz-10.0kHz | table#3 | |
| 3 | EQ Mid Gain | -12+12dB | | |
| 4 | EQ Mid Width | 1.0-12.0 | | |
| 5 | EQ High Gain | -12+12dB | | |
| 6 | EQ Low Frequency | 50Hz-2.0kHz | table#3 | |
| 7 | EQ High Frequency | 500Hz-16.0kHz | table#3 | |
| 8 | | | | |
| 9 | | | | |
| 10 | | | | |
| 11 | | | | |
| 12 | | | | |
| 13 | | | | |
| 14 | Input Mode | mono/stereo | | 0-1 |
| 15 | | | | |
| 16 | | | | |

2BAND EQ(STEREO) (variation, insertion block)

| No. | Parameter | Value | See Table | Control |
|-----|-------------------|---------------|-----------|---------|
| 1 | EQ Low Frequency | 32Hz-2.0kHz | table#3 | |
| 2 | EQ Low Gain | -12+12dB | | |
| 3 | EQ High Frequency | 500Hz-16.0kHz | table#3 | |
| 4 | EQ High Gain | -12+12dB | | |
| 5 | | | | |
| 6 | | | | |
| 7 | | | | |
| 8 | | | | |
| 9 | | | | |
| 10 | | | | |
| 11 | | | | |
| 12 | | | | |
| 13 | | | | |
| 14 | | | | |
| 15 | | | | |
| 16 | | | | |

AUTO WAH (variation, insertion block)

| No. | Parameter | Value | See Table | Control |
|-----|-------------------------|---------------------|-----------|---------|
| 1 | LFO Frequency | 0.00Hz-39.7Hz | table#1 | |
| 2 | LFO Depth | 0-127 | | |
| 3 | Cutoff Frequency Offset | 0-127 | | ● |
| 4 | Resonance | 1.0-12.0 | | |
| 5 | | | | |
| 6 | EQ Low Frequency | 32Hz-2.0kHz | table#3 | |
| 7 | EQ Low Gain | -12+12dB | | |
| 8 | EQ High Frequency | 500Hz-16.0kHz | table#3 | |
| 9 | EQ High Gain | -12+12dB | | |
| 10 | Dry/Wet | D63>W - D=W - D<W63 | | |
| 11 | Drive | 0-127 | | |
| 12 | | | | |
| 13 | | | | |
| 14 | | | | |
| 15 | | | | |
| 16 | | | | |

AUTO WAH+DIST, AUTO WHA+ODRV (variation block)

| No. | Parameter | Value | See Table | Control |
|-----|-------------------------|---------------------|-----------|---------|
| 1 | LFO Frequency | 0.00Hz-39.7Hz | table#1 | |
| 2 | LFO Depth | 0-127 | | |
| 3 | Cutoff Frequency Offset | 0-127 | | ● |
| 4 | Resonance | 1.0-12.0 | | |
| 5 | | | | |
| 6 | EQ Low Frequency | 32Hz-2.0kHz | table#3 | |
| 7 | EQ Low Gain | -12+12dB | | |
| 8 | EQ High Frequency | 500Hz-16.0kHz | table#3 | |
| 9 | EQ High Gain | -12+12dB | | |
| 10 | Dry/Wet | D63>W - D=W - D<W63 | | |
| 11 | Drive | 0-127 | | |
| 12 | EQ Low Gain(distortion) | -12+12dB | | |
| 13 | EQ Mid Gain(distortion) | -12+12dB | | |
| 14 | LPF Cutoff | 1.0kHz-thru | table#3 | |
| 15 | Output Level | 0-127 | | |
| 16 | | | | |

TOUCH WAH 1 (variation, insertion block), TOUCH WAH+DIST (variation block)

| No. | Parameter | Value | See Table | Control |
|-----|-------------------------|---------------------|-----------|---------|
| 1 | Sensitive | 0-127 | | |
| 2 | Cutoff Frequency Offset | 0-127 | | ● |
| 3 | Resonance | 1.0-12.0 | | |
| 4 | | | | |
| 5 | | | | |
| 6 | EQ Low Frequency | 32Hz-2.0kHz | table#3 | |
| 7 | EQ Low Gain | -12+12dB | | |
| 8 | EQ High Frequency | 500Hz-16.0kHz | table#3 | |
| 9 | EQ High Gain | -12+12dB | | |
| 10 | Dry/Wet | D63>W - D=W - D<W63 | | |
| 11 | Drive | 0-127 | | |
| 12 | | | | |
| 13 | | | | |
| 14 | | | | |
| 15 | | | | |
| 16 | | | | |

TOUCH WAH 2 (variation, insertion block), TOUCH WAH+ODRV (variation block)

| No. | Parameter | Value | See Table | Control |
|-----|-------------------------|---------------------|-----------|---------|
| 1 | Sensitive | 0-127 | | |
| 2 | Cutoff Frequency Offset | 0-127 | | ● |
| 3 | Resonance | 1.0-12.0 | | |
| 4 | | | | |
| 5 | | | | |
| 6 | EQ Low Frequency | 32Hz-2.0kHz | table#3 | |
| 7 | EQ Low Gain | -12+12dB | | |
| 8 | EQ High Frequency | 500Hz-16.0kHz | table#3 | |
| 9 | EQ High Gain | -12+12dB | | |
| 10 | Dry/Wet | D63>W - D=W - D<W63 | | |
| 11 | Drive | 0-127 | | |
| 12 | EQ Low Gain(distortion) | -12+12dB | | |
| 13 | EQ Mid Gain(distortion) | -12+12dB | | |
| 14 | LPF Cutoff | 1.0kHz-thru | table#3 | |
| 15 | Output Level | 0-127 | | |
| 16 | | | | |

PITCH CHANGE 1 (variation block)

| No. | Parameter | Value | See Table | Control |
|-----|----------------|---------------------|-----------|---------|
| 1 | Pitch | -24+24 | | |
| 2 | Initial Delay | 0-127 | table#7 | |
| 3 | Fine 1 | -50Hz+50Hz | | |
| 4 | Fine 2 | -50Hz+50Hz | | |
| 5 | Feedback Level | -99+99% | | |
| 6 | | | | |
| 7 | | | | |
| 8 | | | | |
| 9 | | | | |
| 10 | Dry/Wet | D63>W - D=W - D<W63 | | ● |
| 11 | Pan 1 | L63-R63 | | 1-127 |
| 12 | Output Level 1 | 0-127 | | 0-127 |
| 13 | Pan 2 | L63-R63 | | 1-127 |
| 14 | Output Level 2 | 0-127 | | 0-127 |
| 15 | | | | |
| 16 | | | | |

PITCH CHANGE 2 (variation block)

| No. | Parameter | Value | See Table | Control |
|-----|----------------|---------------------|-----------|---------|
| 1 | Pitch | -24+24 | | |
| 2 | Initial Delay | 0-127 | table#7 | |
| 3 | Fine 1 | -50+50cent | | |
| 4 | Fine 2 | -50+50cent | | |
| 5 | Feedback Level | -99+99% | | |
| 6 | | | | |
| 7 | | | | |
| 8 | | | | |
| 9 | | | | |
| 10 | Dry/Wet | D63>W - D=W - D<W63 | | ● |
| 11 | Pan 1 | L63-R63 | | 1-127 |
| 12 | Output Level 1 | 0-127 | | 0-127 |
| 13 | Pan 2 | L63-R63 | | 1-127 |
| 14 | Output Level 2 | 0-127 | | 0-127 |
| 15 | | | | |
| 16 | | | | |

COMPRESSOR (variation, insertion block)

| No. | Parameter | Value | See Table | Control |
|-----|--------------|----------|-----------|---------|
| 1 | Attack | 1-40ms | | 0-19 |
| 2 | Release | 10-680ms | | 0-15 |
| 3 | Threshold | -48-6dB | table#9 | 79-121 |
| 4 | Ratio | 1.0-20.0 | | 0-7 |
| 5 | Output Level | 0-127 | | 0-127 |
| 6 | | | | |
| 7 | | | | |
| 8 | | | | |
| 9 | | | | |
| 10 | | | | |
| 11 | | | | |
| 12 | | | | |
| 13 | | | | |
| 14 | | | | |
| 15 | | | | |
| 16 | | | | |

NOISE GATE (variation, insertion block)

| No. | Parameter | Value | See Table | Control |
|-----|--------------|----------|-----------|---------|
| 1 | Attack | 1-40ms | | 0-19 |
| 2 | Release | 10-680ms | | 0-15 |
| 3 | Threshold | -72-30dB | table#9 | 55-97 |
| 4 | Output Level | 0-127 | | 0-127 |
| 5 | | | | |
| 6 | | | | |
| 7 | | | | |
| 8 | | | | |
| 9 | | | | |
| 10 | | | | |
| 11 | | | | |
| 12 | | | | |
| 13 | | | | |
| 14 | | | | |
| 15 | | | | |
| 16 | | | | |

MIDI Implementation Chart

| Function | Transmitted | Recognized | Remarks |
|--|--|--|--|
| Basic Default Channel Changed | 1 1~16 | 1~16 1~16 | |
| Mode Default Messages Altered | 3 × ***** | 1 × × | *1 Poly Mode only |
| Note Number : True voice | 21~108 ***** | 0~127 21~108 | |
| Velocity Note ON Note OFF | ○ 9nH, v=1~127 × | ○ 9nH, v=1~127 × | |
| After Touch Key's Ch's | × × | ○ ○ | |
| Pitch Bender | × | ○ 0~24 semi | |
| Control Change | 0, 32 1, 5, 7, 10, 11 6, 38 64~67 71~74 84 91, 93, 94 96~97 98~99 100~101 120 121 | ○ × *2 ○ ○ × *2 × *2 ○ (#93 × *2) × × *2 ○ × × ○ ○ ○ ○ ○ | Bank Select Data Entry Sound Controller Portamento Controller Effect Depth RPN Inc, Dec NRPN LSB, MSB RPN LSB, MSB All Sounds off Reset All Controllers |
| Program Change : True # | ○ 0~127 ***** | ○ 0~127 | |
| System Exclusive | ○ | ○ | |
| System Common : Song Position : Song Select : Tune | × × × | × ○ × | |
| System Real Time : Clock : Commands | ○ ○ | ○ ○ | |
| Aux Messages : Local ON/OFF : All Notes OFF : Active Sense : Reset | × ○ ○ × | × ○ (123~127) ○ × | |
| Notes : *1 ; Recieve Mode is always multi timbre and Poly mode. *2 ; Transmitted when "ACMP&RHY" or "HARMONY" MIDI send SW is ON. | | | |

Mode 1: OMNI ON, POLY Mode 2: OMNI ON, MONO
 Mode 3: OMNI OFF, POLY Mode 4: OMNI OFF, MONO

○: Yes
 ×: No

Voice List / Stimmenverzeichnis / Liste des voix / Lista de voces



| Category | Voice Name | Voice # | | | |
|---------------------|--------------|-------------|-------|------------------|----|
| | | MSB # | LSB # | Program Change # | |
| Piano | Grand Piano | 0 | 112 | 0 | |
| | Bright Piano | 0 | 112 | 1 | |
| | Mellow Piano | 0 | 114 | 0 | |
| | Rock Piano | 0 | 113 | 1 | |
| | Mono Piano | 0 | 113 | 0 | |
| | Piano EP | 0 | 115 | 2 | |
| | Honky Tonk | 0 | 112 | 3 | |
| | Harpsichord1 | 0 | 112 | 6 | |
| | Harpsichord2 | 0 | 113 | 6 | |
| | Grand Harpsi | 0 | 115 | 6 | |
| | E.Piano | Elec. Piano | 0 | 113 | 4 |
| DX EP | | 0 | 112 | 5 | |
| CP80 | | 0 | 116 | 2 | |
| Jazz EP 1 | | 0 | 116 | 4 | |
| DX EP Modern | | 0 | 115 | 5 | |
| Stage EP | | 0 | 117 | 4 | |
| Galaxy EP | | 0 | 113 | 5 | |
| Funky EP | | 0 | 114 | 4 | |
| Hyper EP | | 0 | 115 | 4 | |
| Dream EP | | 0 | 114 | 5 | |
| Jazz EP 2 | | 0 | 112 | 4 | |
| Wire EP | | 0 | 113 | 5 | |
| Tremolo EP | | 0 | 118 | 4 | |
| Clavi. | | 0 | 112 | 7 | |
| Vibes | | Vibes | 0 | 112 | 11 |
| | Jazz Vibes | 0 | 113 | 11 | |
| | Celesta | 0 | 112 | 8 | |
| | Marimba | 0 | 112 | 12 | |
| | Glockenspiel | 0 | 112 | 9 | |
| | Xylophone | 0 | 112 | 13 | |
| | TubularBells | 0 | 112 | 14 | |
| | Music Box | 0 | 112 | 10 | |
| | Steel Drums | 0 | 112 | 114 | |
| | Guitar | Gut Guitar | 0 | 112 | 24 |
| | | Folk Guitar | 0 | 112 | 25 |
| Jazz Guitar1 | | 0 | 112 | 26 | |
| Banjo | | 0 | 112 | 105 | |
| Harp | | 0 | 112 | 46 | |
| Nylon Guitar | | 0 | 113 | 24 | |
| Steel Guitar | | 0 | 113 | 25 | |
| Jazz Guitar2 | | 0 | 113 | 26 | |
| Clean Guitar | | 0 | 112 | 27 | |
| Dist. Guitar | | 0 | 112 | 30 | |
| 12Str.Guitar | | 0 | 115 | 25 | |
| Mute Guitar | | 0 | 112 | 28 | |
| HawaiianGtr. | | 0 | 114 | 26 | |
| OctaveGuitar | | 0 | 115 | 26 | |
| Clavi. Tone / Synth | Clavinova T. | 0 | 112 | 88 | |
| | NewAge Pad1 | 0 | 113 | 88 | |
| | NewAge Pad2 | 0 | 115 | 88 | |
| | Square Lead | 0 | 112 | 80 | |
| | Saw. Lead | 0 | 112 | 81 | |
| | Synth Pf | 0 | 114 | 88 | |

| Category | Voice Name | Voice # | | | |
|---------------------|--------------|--------------|-------|------------------|----|
| | | MSB # | LSB # | Program Change # | |
| Clavi. Tone / Synth | Strings Pad | 0 | 112 | 51 | |
| | Atmosphere | 0 | 112 | 99 | |
| | Brass Bells | 0 | 112 | 93 | |
| | SynthCrystal | 0 | 112 | 96 | |
| | Synth Bell | 0 | 116 | 88 | |
| | Brass Pad | 0 | 112 | 90 | |
| | Choir Pad | 0 | 112 | 91 | |
| | Cosmic Pad | 0 | 112 | 101 | |
| | Quack Lead | 0 | 112 | 87 | |
| | Organ | Pipe Organ | 0 | 112 | 19 |
| | | Class. Organ | 0 | 113 | 19 |
| Chapel Organ | | 0 | 115 | 19 | |
| Jazz Organ | | 0 | 112 | 16 | |
| Accordion | | 0 | 115 | 21 | |
| Perc. Organ | | 0 | 112 | 17 | |
| Trem. Organ | | 0 | 112 | 18 | |
| Rock Organ | | 0 | 113 | 18 | |
| Theatre Org. | | 0 | 114 | 16 | |
| Organ Combi. | | 0 | 116 | 16 | |
| Elec. Organ | | 0 | 113 | 16 | |
| French Accrd | | 0 | 112 | 21 | |
| Tango Accrd. | | 0 | 112 | 23 | |
| Strings / Choir | Orch.Strings | 0 | 115 | 48 | |
| | Strings | 0 | 112 | 48 | |
| | Violin | 0 | 112 | 40 | |
| | Pizzicato | 0 | 112 | 45 | |
| | Choir | 0 | 115 | 52 | |
| | Class. Strs. | 0 | 114 | 48 | |
| | PopularStrs. | 0 | 116 | 48 | |
| | StringsSlow1 | 0 | 112 | 49 | |
| | StringsSlow2 | 0 | 112 | 49 | |
| | Choir Oohs | 0 | 112 | 53 | |
| | ChamberStrs. | 0 | 113 | 48 | |
| | Cello | 0 | 112 | 42 | |
| | Syn. Strings | 0 | 112 | 50 | |
| | Synth Choir | 0 | 112 | 52 | |
| OrchestraHit | 0 | 112 | 55 | | |
| Brass | BigBnd Brass | 0 | 115 | 61 | |
| | Small Brass | 0 | 113 | 61 | |
| | Trumpet | 0 | 112 | 56 | |
| | Trombone | 0 | 112 | 57 | |
| | French Horn | 0 | 112 | 60 | |
| | BrassSection | 0 | 112 | 61 | |
| | Octave Brass | 0 | 114 | 61 | |
| | MuteTrumpet1 | 0 | 113 | 59 | |
| | MuteTrumpet2 | 0 | 112 | 59 | |
| | Tuba | 0 | 112 | 58 | |
| | Synth Brass1 | 0 | 112 | 62 | |
| | Synth Brass2 | 0 | 112 | 63 | |
| | Soft Trumpet | 0 | 112 | 56 | |
| | Flugel Horn | 0 | 113 | 56 | |
| | Brass&Sax | 0 | 116 | 61 | |



Voice List / Stimmenverzeichnis / Liste des voix / Lista de voces

| Category | Voice Name | Voice # | | | |
|-------------|--------------|--------------|-------|------------------|---|
| | | MSB # | LSB # | Program Change # | |
| Sax / Flute | Tenor Sax | 0 | 112 | 66 | |
| | Alto Sax | 0 | 112 | 65 | |
| | Flute | 0 | 112 | 73 | |
| | Oboe | 0 | 112 | 68 | |
| | Clarinet | 0 | 112 | 71 | |
| | Soprano Sax | 0 | 112 | 64 | |
| | Baritone Sax | 0 | 112 | 67 | |
| | Pan Flute | 0 | 112 | 75 | |
| | Bassoon | 0 | 112 | 70 | |
| | Harmonica | 0 | 112 | 22 | |
| | Piccolo | 0 | 112 | 72 | |
| | Recorder | 0 | 112 | 74 | |
| | Sax&Clarinet | 0 | 113 | 65 | |
| | Sax Section | 0 | 114 | 65 | |
| Bass | WindEnsemble | 0 | 113 | 73 | |
| | Acous.Bass 1 | 0 | 112 | 32 | |
| | Acous.Bass 2 | 0 | 113 | 32 | |
| | E. Bass Slap | 0 | 112 | 33 | |
| | Finger Bass | 0 | 114 | 33 | |
| | Timpani | 0 | 112 | 47 | |
| | Elec. Bass | 0 | 113 | 33 | |
| | FretlessBass | 0 | 112 | 35 | |
| | Slap Bass | 0 | 112 | 36 | |
| | Synth Bass 1 | 0 | 112 | 38 | |
| | Synth Bass 2 | 0 | 112 | 39 | |
| | Pick Bass | 0 | 112 | 34 | |
| | Organ Bass | 0 | 117 | 16 | |
| | Bass&Cymbal | 0 | 114 | 32 | |
| | Drums | Standard Kit | 127 | 0 | 0 |
| | | Standard2Kit | 127 | 0 | 1 |
| Room Kit | | 127 | 0 | 8 | |
| Rock Kit | | 127 | 0 | 16 | |
| Electro Kit | | 127 | 0 | 24 | |
| Analog Kit | | 127 | 0 | 25 | |
| Dance Kit | | 127 | 0 | 27 | |
| Jazz Kit | | 127 | 0 | 32 | |
| Brush Kit | | 127 | 0 | 40 | |
| Classic Kit | | 127 | 0 | 48 | |
| SFX1 Kit | | 126 | 0 | 0 | |
| SFX2 Kit | | 126 | 0 | 1 | |
| XG | GrandPno | 0 | 0 | 0 | |
| | GrndPnoK | 0 | 1 | 0 | |
| | MelloGrP | 0 | 18 | 0 | |
| | PianoStr | 0 | 40 | 0 | |
| | Dream | 0 | 41 | 0 | |
| | BritePno | 0 | 0 | 1 | |
| | BritPnoK | 0 | 1 | 1 | |
| | El.Grand | 0 | 0 | 2 | |
| | ElGrPnoK | 0 | 1 | 2 | |
| | Det.CP80 | 0 | 32 | 2 | |
| | LayerCP1 | 0 | 40 | 2 | |
| | LayerCP2 | 0 | 41 | 2 | |
| | HnkyTonk | 0 | 0 | 3 | |

| Category | Voice Name | Voice # | | |
|-----------|------------|---------|-------|------------------|
| | | MSB # | LSB # | Program Change # |
| XG | HnkyTnkK | 0 | 1 | 3 |
| | E.Piano1 | 0 | 0 | 4 |
| | El.Pno1K | 0 | 1 | 4 |
| | MelloEP1 | 0 | 18 | 4 |
| | Chor.EP1 | 0 | 32 | 4 |
| | HardEl.P | 0 | 40 | 4 |
| | VX El.P1 | 0 | 45 | 4 |
| | 60sEl.P1 | 0 | 64 | 4 |
| | E.Piano2 | 0 | 0 | 5 |
| | El.Pno2K | 0 | 1 | 5 |
| | Chor.EP2 | 0 | 32 | 5 |
| | DX Hard | 0 | 33 | 5 |
| | DXLegend | 0 | 34 | 5 |
| | DX Phase | 0 | 40 | 5 |
| | DX+Analg | 0 | 41 | 5 |
| | DXKotoEP | 0 | 42 | 5 |
| | VX El.P2 | 0 | 45 | 5 |
| | Harpsi. | 0 | 0 | 6 |
| | Harpsi.K | 0 | 1 | 6 |
| | Harpsi.2 | 0 | 25 | 6 |
| | Harpsi.3 | 0 | 35 | 6 |
| | Clavi | 0 | 0 | 7 |
| | Clavi K | 0 | 1 | 7 |
| | ClaviWah | 0 | 27 | 7 |
| | PulseClv | 0 | 64 | 7 |
| | PierceCl | 0 | 65 | 7 |
| | Celesta | 0 | 0 | 8 |
| | Glocken | 0 | 0 | 9 |
| | MusicBox | 0 | 0 | 10 |
| | Orgel | 0 | 64 | 10 |
| | Vibes | 0 | 0 | 11 |
| | Vibes K | 0 | 1 | 11 |
| | HardVibe | 0 | 45 | 11 |
| | Marimba | 0 | 0 | 12 |
| | MarimbaK | 0 | 1 | 12 |
| | SineMrmb | 0 | 64 | 12 |
| | Balimba | 0 | 97 | 12 |
| | Log Drum | 0 | 98 | 12 |
| | Xylophon | 0 | 0 | 13 |
| | TubulBel | 0 | 0 | 14 |
| | ChrchBel | 0 | 96 | 14 |
| | Carillon | 0 | 97 | 14 |
| Dulcimer | 0 | 0 | 15 | |
| Dulcimer2 | 0 | 35 | 15 | |
| Cimbalom | 0 | 96 | 15 | |
| Santur | 0 | 97 | 15 | |
| DrawOrgn | 0 | 0 | 16 | |
| DetDrwOr | 0 | 32 | 16 | |
| 60sDrOr1 | 0 | 33 | 16 | |
| 60sDrOr2 | 0 | 34 | 16 | |
| 70sDrOr1 | 0 | 35 | 16 | |
| DrawOrg2 | 0 | 36 | 16 | |
| 60sDrOr3 | 0 | 37 | 16 | |

Voice List / Stimmenverzeichnis / Liste des voix / Lista de voces.....

| Category | Voice Name | Voice # | | |
|----------|------------|---------|-------|------------------|
| | | MSB # | LSB # | Program Change # |
| XG | EvenBar | 0 | 38 | 16 |
| | 16+2'2/3 | 0 | 40 | 16 |
| | Organ Ba | 0 | 64 | 16 |
| | 70sDrOr2 | 0 | 65 | 16 |
| | CheezOrg | 0 | 66 | 16 |
| | DrawOrg3 | 0 | 67 | 16 |
| | PercOrgn | 0 | 0 | 17 |
| | 70sPcOr1 | 0 | 24 | 17 |
| | DetPrcOr | 0 | 32 | 17 |
| | Lite Org | 0 | 33 | 17 |
| | PercOrg2 | 0 | 37 | 17 |
| | RockOrgn | 0 | 0 | 18 |
| | RotaryOr | 0 | 64 | 18 |
| | SloRotar | 0 | 65 | 18 |
| | FstRotar | 0 | 66 | 18 |
| | ChrchOrg | 0 | 0 | 19 |
| | ChurOrg3 | 0 | 32 | 19 |
| | ChurOrg2 | 0 | 35 | 19 |
| | NotreDam | 0 | 40 | 19 |
| | OrgFlute | 0 | 64 | 19 |
| | TrmOrgFl | 0 | 65 | 19 |
| | ReedOrgn | 0 | 0 | 20 |
| | Puff Org | 0 | 40 | 20 |
| | Acordion | 0 | 0 | 21 |
| | AccordIt | 0 | 32 | 21 |
| | Harmnica | 0 | 0 | 22 |
| | Harmo. 2 | 0 | 32 | 22 |
| | TangoAcd | 0 | 0 | 23 |
| | TngoAcd2 | 0 | 64 | 23 |
| | NylonGtr | 0 | 0 | 24 |
| | NylonGt2 | 0 | 16 | 24 |
| | NylonGt3 | 0 | 25 | 24 |
| | VelGtHrm | 0 | 43 | 24 |
| | Ukulele | 0 | 96 | 24 |
| | SteelGtr | 0 | 0 | 25 |
| | SteelGt2 | 0 | 16 | 25 |
| | 12StrGtr | 0 | 35 | 25 |
| | Nyln&Stl | 0 | 40 | 25 |
| | Stl&Body | 0 | 41 | 25 |
| | Mandolin | 0 | 96 | 25 |
| | Jazz Gtr | 0 | 0 | 26 |
| | MelloGtr | 0 | 18 | 26 |
| | Jazz Amp | 0 | 32 | 26 |
| | CleanGtr | 0 | 0 | 27 |
| | ChorusGt | 0 | 32 | 27 |
| | Mute Gtr | 0 | 0 | 28 |
| | FunkGtr1 | 0 | 40 | 28 |
| | MuteStlG | 0 | 41 | 28 |
| | FunkGtr2 | 0 | 43 | 28 |
| | Jazz Man | 0 | 45 | 28 |
| | Ovrdrive | 0 | 0 | 29 |
| | Gt.Pinch | 0 | 43 | 29 |
| | Dist.Gtr | 0 | 0 | 30 |

| Category | Voice Name | Voice # | | |
|----------|------------|---------|-------|------------------|
| | | MSB # | LSB # | Program Change # |
| XG | FeedbkGt | 0 | 40 | 30 |
| | FeedbGt2 | 0 | 41 | 30 |
| | GtrHarmo | 0 | 0 | 31 |
| | GtFeedbk | 0 | 65 | 31 |
| | GtrHrmo2 | 0 | 66 | 31 |
| | Aco.Bass | 0 | 0 | 32 |
| | JazzRthm | 0 | 40 | 32 |
| | VXUprght | 0 | 45 | 32 |
| | FngrBass | 0 | 0 | 33 |
| | FingrDrk | 0 | 18 | 33 |
| | FlangeBa | 0 | 27 | 33 |
| | Ba&DstEG | 0 | 40 | 33 |
| | FngrSlap | 0 | 43 | 33 |
| | FngBass2 | 0 | 45 | 33 |
| | Mod.Bass | 0 | 65 | 33 |
| | PickBass | 0 | 0 | 34 |
| | MutePkBa | 0 | 28 | 34 |
| | Fretless | 0 | 0 | 35 |
| | Fretles2 | 0 | 32 | 35 |
| | Fretles3 | 0 | 33 | 35 |
| | Fretles4 | 0 | 34 | 35 |
| | SynFretl | 0 | 96 | 35 |
| | SmthFrt1 | 0 | 97 | 35 |
| | SlapBas1 | 0 | 0 | 36 |
| | ResoSlap | 0 | 27 | 36 |
| | PunchThm | 0 | 32 | 36 |
| | SlapBas2 | 0 | 0 | 37 |
| | VeloSlap | 0 | 43 | 37 |
| | SynBass1 | 0 | 0 | 38 |
| | SynBa1Dk | 0 | 18 | 38 |
| | FastResB | 0 | 20 | 38 |
| | AcidBass | 0 | 24 | 38 |
| | Civ Bass | 0 | 35 | 38 |
| | TechnoBa | 0 | 40 | 38 |
| | Orbiter | 0 | 64 | 38 |
| | Sqr.Bass | 0 | 65 | 38 |
| | RubberBa | 0 | 66 | 38 |
| | Hammer | 0 | 96 | 38 |
| | SynBass2 | 0 | 0 | 39 |
| | MelloSBa | 0 | 6 | 39 |
| | Seq Bass | 0 | 12 | 39 |
| | ClkSynBa | 0 | 18 | 39 |
| | SynBa2Dk | 0 | 19 | 39 |
| | SmthSynB | 0 | 32 | 39 |
| | ModulrBa | 0 | 40 | 39 |
| | DX Bass | 0 | 41 | 39 |
| | X WireBa | 0 | 64 | 39 |
| | Violin | 0 | 0 | 40 |
| | Slow Vln | 0 | 8 | 40 |
| | Viola | 0 | 0 | 41 |
| | Cello | 0 | 0 | 42 |
| | Contrabs | 0 | 0 | 43 |
| | Trem.Str | 0 | 0 | 44 |

Voice List / Stimmenverzeichnis / Liste des voix / Lista de voces

| Category | Voice Name | Voice # | | |
|----------|------------|---------|-------|------------------|
| | | MSB # | LSB # | Program Change # |
| XG | SlwTrStr | 0 | 8 | 44 |
| | Susp. Str | 0 | 40 | 44 |
| | Pizz.Str | 0 | 0 | 45 |
| | Harp | 0 | 0 | 46 |
| | YangChin | 0 | 40 | 46 |
| | Timpani | 0 | 0 | 47 |
| | Strings1 | 0 | 0 | 48 |
| | S.Strngs | 0 | 3 | 48 |
| | Slow Str | 0 | 8 | 48 |
| | Arco Str | 0 | 24 | 48 |
| | 60sStrng | 0 | 35 | 48 |
| | Orchestr | 0 | 40 | 48 |
| | Orchstr2 | 0 | 41 | 48 |
| | TremOrch | 0 | 42 | 48 |
| | Velo.Str | 0 | 45 | 48 |
| | Strings2 | 0 | 0 | 49 |
| | S.SlwStr | 0 | 3 | 49 |
| | LegatoSt | 0 | 8 | 49 |
| | Warm Str | 0 | 40 | 49 |
| | Kingdom | 0 | 41 | 49 |
| | 70s Str | 0 | 64 | 49 |
| | Strings3 | 0 | 65 | 49 |
| | Syn Str1 | 0 | 0 | 50 |
| | Reso Str | 0 | 27 | 50 |
| | Syn Str4 | 0 | 64 | 50 |
| | Syn Str5 | 0 | 65 | 50 |
| | Syn Str2 | 0 | 0 | 51 |
| | ChoirAah | 0 | 0 | 52 |
| | S.Choir | 0 | 3 | 52 |
| | Ch.Aahs2 | 0 | 16 | 52 |
| | MelChoir | 0 | 32 | 52 |
| | ChoirStr | 0 | 40 | 52 |
| | VoiceOoh | 0 | 0 | 53 |
| | SynVoice | 0 | 0 | 54 |
| | SyVoice2 | 0 | 40 | 54 |
| | Choral | 0 | 41 | 54 |
| | AnaVoice | 0 | 64 | 54 |
| | Orch.Hit | 0 | 0 | 55 |
| | OrchHit2 | 0 | 35 | 55 |
| | Impact | 0 | 64 | 55 |
| | Trumpet | 0 | 0 | 56 |
| | Trumpet2 | 0 | 16 | 56 |
| | BriteTrp | 0 | 17 | 56 |
| | Warm Trp | 0 | 32 | 56 |
| | Trombone | 0 | 0 | 57 |
| | Trmbone2 | 0 | 18 | 57 |
| | Tuba | 0 | 0 | 58 |
| | Tuba 2 | 0 | 16 | 58 |
| | Mute Trp | 0 | 0 | 59 |
| | Fr.Horn | 0 | 0 | 60 |
| | FrHrSolo | 0 | 6 | 60 |
| | FrHorn 2 | 0 | 32 | 60 |
| | HornOrch | 0 | 37 | 60 |

| Category | Voice Name | Voice # | | |
|----------|------------|---------|-------|------------------|
| | | MSB # | LSB # | Program Change # |
| XG | BrssSect | 0 | 0 | 61 |
| | Tp&TbSec | 0 | 35 | 61 |
| | BrssSec2 | 0 | 40 | 61 |
| | HiBrass | 0 | 41 | 61 |
| | MelloBrs | 0 | 42 | 61 |
| | SynBrss1 | 0 | 0 | 62 |
| | Quack Br | 0 | 12 | 62 |
| | RezSynBr | 0 | 20 | 62 |
| | PolyBrss | 0 | 24 | 62 |
| | SynBrss3 | 0 | 27 | 62 |
| | JumpBrss | 0 | 32 | 62 |
| | AnVelBr1 | 0 | 45 | 62 |
| | AnVelBr2 | 0 | 64 | 62 |
| | SynBrss2 | 0 | 0 | 63 |
| | Soft Brs | 0 | 18 | 63 |
| | SynBrss4 | 0 | 40 | 63 |
| | ChoirBrs | 0 | 41 | 63 |
| | VelBrss2 | 0 | 45 | 63 |
| | AnaBrss2 | 0 | 64 | 63 |
| | SprnoSax | 0 | 0 | 64 |
| | Alto Sax | 0 | 0 | 65 |
| | Sax Sect | 0 | 40 | 65 |
| | HyprAlto | 0 | 43 | 65 |
| | TenorSax | 0 | 0 | 66 |
| | BrthTnSx | 0 | 40 | 66 |
| | SoftTenr | 0 | 41 | 66 |
| | TnrSax 2 | 0 | 64 | 66 |
| | Bari.Sax | 0 | 0 | 67 |
| | Oboe | 0 | 0 | 68 |
| | Eng.Horn | 0 | 0 | 69 |
| | Bassoon | 0 | 0 | 70 |
| | Clarinet | 0 | 0 | 71 |
| | Piccolo | 0 | 0 | 72 |
| | Flute | 0 | 0 | 73 |
| | Recorder | 0 | 0 | 74 |
| | PanFlute | 0 | 0 | 75 |
| | Bottle | 0 | 0 | 76 |
| | Shakhchi | 0 | 0 | 77 |
| | Whistle | 0 | 0 | 78 |
| | Ocarina | 0 | 0 | 79 |
| | SquareLd | 0 | 0 | 80 |
| | SquarLd2 | 0 | 6 | 80 |
| | LMSquare | 0 | 8 | 80 |
| | Hollow | 0 | 18 | 80 |
| | Shroud | 0 | 19 | 80 |
| | Mellow | 0 | 64 | 80 |
| | SoloSine | 0 | 65 | 80 |
| | SineLead | 0 | 66 | 80 |
| | Saw Lead | 0 | 0 | 81 |
| | Saw Ld 2 | 0 | 6 | 81 |
| | ThickSaw | 0 | 8 | 81 |
| | Dyna Saw | 0 | 18 | 81 |
| | Digi Saw | 0 | 19 | 81 |

Voice List / Stimmenverzeichnis / Liste des voix / Lista de voces

| Category | Voice Name | Voice # | | |
|----------|------------|---------|-------|------------------|
| | | MSB # | LSB # | Program Change # |
| XG | Sci-Fi | 0 | 0 | 103 |
| | Starz | 0 | 64 | 103 |
| | Sitar | 0 | 0 | 104 |
| | DetSitar | 0 | 32 | 104 |
| | Sitar 2 | 0 | 35 | 104 |
| | Tambra | 0 | 96 | 104 |
| | Tamboura | 0 | 97 | 104 |
| | Banjo | 0 | 0 | 105 |
| | MuteBnjo | 0 | 28 | 105 |
| | Rabab | 0 | 96 | 105 |
| | Gopichnt | 0 | 97 | 105 |
| | Oud | 0 | 98 | 105 |
| | Shamisen | 0 | 0 | 106 |
| | Koto | 0 | 0 | 107 |
| | Taisho-k | 0 | 96 | 107 |
| | Kanoon | 0 | 97 | 107 |
| | Kalimba | 0 | 0 | 108 |
| | Bagpipe | 0 | 0 | 109 |
| | Fiddle | 0 | 0 | 110 |
| | Shanai | 0 | 0 | 111 |
| | Shanai 2 | 0 | 64 | 111 |
| | Pungi | 0 | 96 | 111 |
| | Hichriki | 0 | 97 | 111 |
| | TnklBell | 0 | 0 | 112 |
| | Bonang | 0 | 96 | 112 |
| | Altair | 0 | 97 | 112 |
| | Gamelan | 0 | 98 | 112 |
| | S.Gamlan | 0 | 99 | 112 |
| | Rama Cym | 0 | 100 | 112 |
| | AsianBel | 0 | 101 | 112 |
| | Agogo | 0 | 0 | 113 |
| | SteelDrm | 0 | 0 | 114 |
| | GlasPerc | 0 | 97 | 114 |
| | ThaiBell | 0 | 98 | 114 |
| | WoodBlok | 0 | 0 | 115 |
| | Castanet | 0 | 96 | 115 |
| | TaikoDrm | 0 | 0 | 116 |
| | Gr.Cassa | 0 | 96 | 116 |
| | MelodTom | 0 | 0 | 117 |
| | Mel Tom2 | 0 | 64 | 117 |
| | Real Tom | 0 | 65 | 117 |
| | Rock Tom | 0 | 66 | 117 |
| | Syn Drum | 0 | 0 | 118 |
| | Ana Tom | 0 | 64 | 118 |
| | ElecPerc | 0 | 65 | 118 |
| | RevCymb1 | 0 | 0 | 119 |
| | FretNoiz | 0 | 0 | 120 |
| | BrthNoiz | 0 | 0 | 121 |
| | Seashore | 0 | 0 | 122 |
| | Tweet | 0 | 0 | 123 |
| | Telephone | 0 | 0 | 124 |
| | Helicptr | 0 | 0 | 125 |
| | Applause | 0 | 0 | 126 |

| Category | Voice Name | Voice # | | |
|----------|------------|---------|-------|------------------|
| | | MSB # | LSB # | Program Change # |
| XG | Gunshot | 0 | 0 | 127 |
| | CuttngNz | 64 | 0 | 0 |
| | CttngNz2 | 64 | 0 | 1 |
| | Str Slap | 64 | 0 | 3 |
| | Fl.KClik | 64 | 0 | 16 |
| | Shower | 64 | 0 | 32 |
| | Thunder | 64 | 0 | 33 |
| | Wind | 64 | 0 | 34 |
| | Stream | 64 | 0 | 35 |
| | Bubble | 64 | 0 | 36 |
| | Feed | 64 | 0 | 37 |
| | Dog | 64 | 0 | 48 |
| | Horse | 64 | 0 | 49 |
| | Tweet 2 | 64 | 0 | 50 |
| | Ghost | 64 | 0 | 54 |
| | Maou | 64 | 0 | 55 |
| | Tel.Dial | 64 | 0 | 64 |
| | DoorSqek | 64 | 0 | 65 |
| | DoorSlam | 64 | 0 | 66 |
| | ScratchC | 64 | 0 | 67 |
| | ScratchS | 64 | 0 | 68 |
| | WindChim | 64 | 0 | 69 |
| | Telphon2 | 64 | 0 | 70 |
| | CarElgnt | 64 | 0 | 80 |
| | CarTSqel | 64 | 0 | 81 |
| | Car Pass | 64 | 0 | 82 |
| | CarCrash | 64 | 0 | 83 |
| | Siren | 64 | 0 | 84 |
| | Train | 64 | 0 | 85 |
| | JetPlane | 64 | 0 | 86 |
| | Starship | 64 | 0 | 87 |
| | Burst | 64 | 0 | 88 |
| | Coaster | 64 | 0 | 89 |
| | Submarin | 64 | 0 | 90 |
| | Laugh | 64 | 0 | 96 |
| | Scream | 64 | 0 | 97 |
| | Punch | 64 | 0 | 98 |
| | Heart | 64 | 0 | 99 |
| | Footstep | 64 | 0 | 100 |
| | MchinGun | 64 | 0 | 112 |
| | LaserGun | 64 | 0 | 113 |
| | Xplosion | 64 | 0 | 114 |
| | Firework | 64 | 0 | 115 |

Drum/key Assignment List / Verzeichnis der Liste d'assignation instrument de batterie/ Lista de asignaciones de teclas/batería

| Bank Select MSB | | | | | 127 | 127 | 127 | 127 | 127 | 127 |
|-------------------|--------|-------|---------|------------------|--------------|----------------|--------------|--------------|----------------|--------------|
| Bank Select LSB | | | | | 0 | 0 | 0 | 0 | 0 | 0 |
| Program # (1-128) | | | | | 1 | 2 | 9 | 17 | 25 | 26 |
| Keyboard Note | MIDI | | Key off | Alternate assign | Standard Kit | Standard Kit 2 | Room Kit | Rock Kit | Electronic Kit | Analog Kit |
| | Note # | Note | | | | | | | | |
| C# 1 | 13 | C# -1 | | | Surdo Mute | Surdo Mute | Surdo Mute | Surdo Mute | Surdo Mute | Surdo Mute |
| D 1 | 14 | D -1 | | 3 | Surdo Open | Surdo Open | Surdo Open | Surdo Open | Surdo Open | Surdo Open |
| D# 1 | 15 | D# -1 | | | Hi Q | Hi Q | Hi Q | Hi Q | Hi Q | Hi Q |
| E 1 | 16 | E -1 | | | Whip Slap | Whip Slap | Whip Slap | Whip Slap | Whip Slap | Whip Slap |
| F 1 | 17 | F -1 | | 4 | Scratch H | Scratch H | Scratch H | Scratch H | Scratch H | Scratch H |
| F# 1 | 18 | F# -1 | | 4 | Scratch L | Scratch L | Scratch L | Scratch L | Scratch L | Scratch L |
| G 1 | 19 | G -1 | | | Finger Snap | Finger Snap | Finger Snap | Finger Snap | Finger Snap | Finger Snap |
| G# 1 | 20 | G# -1 | | | Click Noise | Click Noise | Click Noise | Click Noise | Click Noise | Click Noise |
| A 1 | 21 | A -1 | | | Mtrnm Click | Mtrnm Click | Mtrnm Click | Mtrnm Click | Mtrnm Click | Mtrnm Click |
| A# 1 | 22 | A# -1 | | | Mtrnm Bell | Mtrnm Bell | Mtrnm Bell | Mtrnm Bell | Mtrnm Bell | Mtrnm Bell |
| B 1 | 23 | B -1 | | | Seq Click L | Seq Click L | Seq Click L | Seq Click L | Seq Click L | Seq Click L |
| C 2 | 24 | C 0 | | | Seq Click H | Seq Click H | Seq Click H | Seq Click H | Seq Click H | Seq Click H |
| C# 2 | 25 | C# 0 | | | Brush Tap | Brush Tap | Brush Tap | Brush Tap | Brush Tap | Brush Tap |
| D 2 | 26 | D 0 | ○ | | Brush Swirl | Brush Swirl | Brush Swirl | Brush Swirl | Brush Swirl | Brush Swirl |
| D# 2 | 27 | D# 0 | | | Brush Slap | Brush Slap | Brush Slap | Brush Slap | Brush Slap | Brush Slap |
| E 2 | 28 | E 0 | ○ | | BrushTapSwrl | BrushTapSwrl | BrushTapSwrl | BrushTapSwrl | ReversCymbal | ReversCymbal |
| F 2 | 29 | F 0 | ○ | | Snare Roll | Snare Roll 2 | Snare Roll | Snare Roll | Snare Roll | Snare Roll |
| F# 2 | 30 | F# 0 | | | Castanet | Castanet | Castanet | Castanet | Hi Q 2 | Hi Q 2 |
| G 2 | 31 | G 0 | | | Snare Soft | Snare Soft 2 | Snare Soft | Snare Noisy | SnrSnpylctr | SnareNoisy 4 |
| G# 2 | 32 | G# 0 | | | Sticks | Sticks | Sticks | Sticks | Sticks | Sticks |
| A 2 | 33 | A 0 | | | Kick Soft | Kick Soft | Kick Soft | Kick Tight 2 | Kick 3 | Kick Tight 2 |
| A# 2 | 34 | A# 0 | | | OpenRimShot | RimShotHSht | OpenRimShot | OpenRimShot | OpenRimShot | OpenRimShot |
| B 2 | 35 | B 0 | | | Kick Tight | KickTghtShrt | Kick Tight | Kick 2 | Kick Gate | KickAnlgShrt |
| C 3 | 36 | C 1 | | | Kick | Kick Short | Kick | Kick Gate | KckGateHeavy | Kick Analog |
| C# 3 | 37 | C# 1 | | | Side Stick | Side Stick | Side Stick | Side Stick | Side Stick | SideStickAn |
| D 3 | 38 | D 1 | | | Snare | Snare Short | Snare Snappy | Snare Rock | SnareNoisy 2 | SnareAnalog |
| D# 3 | 39 | D# 1 | | | Hand Clap | Hand Clap | Hand Clap | Hand Clap | Hand Clap | Hand Clap |
| E 3 | 40 | E 1 | | | Snare Tight | SnareTight H | SnrTightSnp | SnareRockRim | SnareNoisy 3 | SnareAnalog2 |
| F 3 | 41 | F 1 | | | Floor Tom L | Floor Tom L | Tom Room 1 | Tom Rock 1 | TomElectro 1 | Tom Analog 1 |
| F# 3 | 42 | F# 1 | | 1 | Hi-HatClosed | Hi-HatClosed | Hi-HatClosed | Hi-HatClosed | Hi-HatClosed | HatCloseAnlg |
| G 3 | 43 | G 1 | | | Floor Tom H | Floor Tom H | Tom Room 2 | Tom Rock 2 | TomElectro 2 | Tom Analog 2 |
| G# 3 | 44 | G# 1 | | 1 | Hi-Hat Pedal | Hi-Hat Pedal | Hi-Hat Pedal | Hi-Hat Pedal | Hi-Hat Pedal | HatCloseAn 2 |
| A 3 | 45 | A 1 | | | Low Tom | Low Tom | Tom Room 3 | Tom Rock 3 | TomElectro 3 | Tom Analog 3 |
| A# 3 | 46 | A# 1 | | 1 | Hi-Hat Open | Hi-Hat Open | Hi-Hat Open | Hi-Hat Open | Hi-Hat Open | HatOpen Anlg |
| B 3 | 47 | B 1 | | | Mid Tom L | Mid Tom L | Tom Room 4 | Tom Rock 4 | TomElectro 4 | Tom Analog 4 |
| C 4 | 48 | C 2 | | | Mid Tom H | Mid Tom H | Tom Room 5 | Tom Rock 5 | TomElectro 5 | Tom Analog 5 |
| C# 4 | 49 | C# 2 | | | CrashCymbal1 | CrashCymbal1 | CrashCymbal1 | CrashCymbal1 | CrashCymbal1 | Crash Analog |
| D 4 | 50 | D 2 | | | High Tom | High Tom | Tom Room 6 | Tom Rock 6 | TomElectro 6 | Tom Analog 6 |
| D# 4 | 51 | D# 2 | | | RideCymbal 1 | RideCymbal 1 | RideCymbal 1 | RideCymbal 1 | RideCymbal 1 | RideCymbal 1 |
| E 4 | 52 | E 2 | | | Chinese Cym | Chinese Cym | Chinese Cym | Chinese Cym | Chinese Cym | Chinese Cym |
| F 4 | 53 | F 2 | | | Ride Cym Cup | Ride Cym Cup | Ride Cym Cup | Ride Cym Cup | Ride Cym Cup | Ride Cym Cup |
| F# 4 | 54 | F# 2 | | | Tambourine | Tambourine | Tambourine | Tambourine | Tambourine | Tambourine |
| G 4 | 55 | G 2 | | | SplashCymbal | SplashCymbal | SplashCymbal | SplashCymbal | SplashCymbal | SplashCymbal |
| G# 4 | 56 | G# 2 | | | Cowbell | Cowbell | Cowbell | Cowbell | Cowbell | Cowbell Anlg |
| A 4 | 57 | A 2 | | | CrashCymbal2 | CrashCymbal2 | CrashCymbal2 | CrashCymbal2 | CrashCymbal2 | CrashCymbal2 |
| A# 4 | 58 | A# 2 | | | Vibraslap | Vibraslap | Vibraslap | Vibraslap | Vibraslap | Vibraslap |
| B 4 | 59 | B 2 | | | RideCymbal 2 | RideCymbal 2 | RideCymbal 2 | RideCymbal 2 | RideCymbal 2 | RideCymbal 2 |
| C 5 | 60 | C 3 | | | Bongo H | Bongo H | Bongo H | Bongo H | Bongo H | Bongo H |
| C# 5 | 61 | C# 3 | | | Bongo L | Bongo L | Bongo L | Bongo L | Bongo L | Bongo L |
| D 5 | 62 | D 3 | | | Conga H Mute | Conga H Mute | Conga H Mute | Conga H Mute | Conga H Mute | Conga Anlg H |
| D# 5 | 63 | D# 3 | | | Conga H Open | Conga H Open | Conga H Open | Conga H Open | Conga H Open | Conga Anlg M |
| E 5 | 64 | E 3 | | | Conga L | Conga L | Conga L | Conga L | Conga L | Conga Anlg L |
| F 5 | 65 | F 3 | | | Timbale H | Timbale H | Timbale H | Timbale H | Timbale H | Timbale H |
| F# 5 | 66 | F# 3 | | | Timbale L | Timbale L | Timbale L | Timbale L | Timbale L | Timbale L |
| G 5 | 67 | G 3 | | | Agogo H | Agogo H | Agogo H | Agogo H | Agogo H | Agogo H |
| G# 5 | 68 | G# 3 | | | Agogo L | Agogo L | Agogo L | Agogo L | Agogo L | Agogo L |
| A 5 | 69 | A 3 | | | Cabasa | Cabasa | Cabasa | Cabasa | Cabasa | Cabasa |
| A# 5 | 70 | A# 3 | | | Maracas | Maracas | Maracas | Maracas | Maracas | Maracas 2 |
| B 5 | 71 | B 3 | ○ | | SambaWhistlH | SambaWhistlH | SambaWhistlH | SambaWhistlH | SambaWhistlH | SambaWhistlH |
| C 6 | 72 | C 4 | ○ | | SambaWhistlL | SambaWhistlL | SambaWhistlL | SambaWhistlL | SambaWhistlL | SambaWhistlL |
| C# 6 | 73 | C# 4 | | | Guiro Short | Guiro Short | Guiro Short | Guiro Short | Guiro Short | Guiro Short |
| D 6 | 74 | D 4 | ○ | | Guiro Long | Guiro Long | Guiro Long | Guiro Long | Guiro Long | Guiro Long |
| D# 6 | 75 | D# 4 | | | Claves | Claves | Claves | Claves | Claves | Claves 2 |
| E 6 | 76 | E 4 | | | Wood Block H | Wood Block H | Wood Block H | Wood Block H | Wood Block H | Wood Block H |
| F 6 | 77 | F 4 | | | Wood Block L | Wood Block L | Wood Block L | Wood Block L | Wood Block L | Wood Block L |
| F# 6 | 78 | F# 4 | | | Cuica Mute | Cuica Mute | Cuica Mute | Cuica Mute | Scratch H 2 | Scratch H 2 |
| G 6 | 79 | G 4 | | | Cuica Open | Cuica Open | Cuica Open | Cuica Open | Scratch L 2 | Scratch L 3 |
| G# 6 | 80 | G# 4 | | 2 | TriangleMute | TriangleMute | TriangleMute | TriangleMute | TriangleMute | TriangleMute |
| A 6 | 81 | A 4 | | 2 | TriangleOpen | TriangleOpen | TriangleOpen | TriangleOpen | TriangleOpen | TriangleOpen |
| A# 6 | 82 | A# 4 | | | Shaker | Shaker | Shaker | Shaker | Shaker | Shaker |
| B 6 | 83 | B 4 | | | Jingle Bells | Jingle Bells | Jingle Bells | Jingle Bells | Jingle Bells | Jingle Bells |
| C 7 | 84 | C 5 | | | Bell Tree | Bell Tree | Bell Tree | Bell Tree | Bell Tree | Bell Tree |
| - | 85 | C# 5 | | | | | | | | |
| - | 86 | D 5 | | | | | | | | |
| - | 87 | D# 5 | | | | | | | | |
| - | 88 | E 5 | | | | | | | | |
| - | 89 | F 5 | | | | | | | | |
| - | 90 | F# 5 | | | | | | | | |
| - | 91 | G 5 | | | | | | | | |

- Key Off: Keys marked "○" stop sounding the instant they are released.
- Alternate Assign: Playing any instrument within a numbered group will immediately stop the sound of any other instrument in the same group of the same number.

- Key Off: Durch "○" gekennzeichnete Klänge verstummen beim Loslassen der Taste.
- Alternate Assign: Mit derselben Nummer gekennzeichnete Klänge werden von demselben Instrument erzeugt und können daher nicht gleichzeitig produziert werden. Spielt einer dieser Klänge gerade, wird er beim Anschlagen einer anderen Taste mit derselben "Alternate Assign"-Nummer stummgeschaltet.

Schlagzeugklänge / touche du clavier /

| Bank Select MSB | | | | 127 | 127 | 127 | 127 | 126 | 126 | |
|-------------------|--------|------|---------|------------------|-----------|--------------|--------------|--------------|--------------|--------------|
| Bank Select LSB | | | | 0 | 0 | 0 | 0 | 0 | 0 | |
| Program # (1-128) | | | | 28 | 33 | 41 | 49 | 1 | 2 | |
| Keyboard Note | MIDI | | Key off | Alternate assign | Dance Kit | Jazz Kit | Brush Kit | Symphony Kit | SFX Kit 1 | SFX Kit 2 |
| | Note # | Note | | | | | | | | |
| C# | 1 | 13 | C# | -1 | 3 | Surdo Mute | Surdo Mute | Surdo Mute | Surdo Mute | |
| D | 1 | 14 | D | -1 | 3 | Surdo Open | Surdo Open | Surdo Open | Surdo Open | |
| D# | 1 | 15 | D# | -1 | | Hi Q | Hi Q | Hi Q | Hi Q | |
| E | 1 | 16 | E | -1 | | Whip Slap | Whip Slap | Whip Slap | Whip Slap | |
| F | 1 | 17 | F | -1 | 4 | Scratch H | Scratch H | Scratch H | Scratch H | |
| F# | 1 | 18 | F# | -1 | 4 | Scratch L | Scratch L | Scratch L | Scratch L | |
| G | 1 | 19 | G | -1 | | Finger Snap | Finger Snap | Finger Snap | Finger Snap | |
| G# | 1 | 20 | G# | -1 | | Click Noise | Click Noise | Click Noise | Click Noise | |
| A | 1 | 21 | A | -1 | | Mtrnm Click | Mtrnm Click | Mtrnm Click | Mtrnm Click | |
| A# | 1 | 22 | A# | -1 | | Mtrnm Bell | Mtrnm Bell | Mtrnm Bell | Mtrnm Bell | |
| B | 1 | 23 | B | -1 | | Seq Click L | Seq Click L | Seq Click L | Seq Click L | |
| C | 2 | 24 | C | 0 | | Seq Click H | Seq Click H | Seq Click H | Seq Click H | |
| C# | 2 | 25 | C# | 0 | | Brush Tap | Brush Tap | Brush Tap | Brush Tap | |
| D | 2 | 26 | D | 0 | ○ | Brush Swirl | Brush Swirl | Brush Swirl | Brush Swirl | |
| D# | 2 | 27 | D# | 0 | | Brush Slap | Brush Slap | Brush Slap | Brush Slap | |
| E | 2 | 28 | E | 0 | ○ | ReversCymbal | BrushTapSwrl | BrushTapSwrl | BrushTapSwrl | |
| F | 2 | 29 | F | 0 | ○ | Snare Roll | Snare Roll | Snare Roll | Snare Roll | |
| F# | 2 | 30 | F# | 0 | | Hi Q 2 | Castanet | Castanet | Castanet | |
| G | 2 | 31 | G | 0 | | SnareTechno3 | Snare Soft | Brush Slap 2 | Brush Slap 2 | |
| G# | 2 | 32 | G# | 0 | | Sticks | Sticks | Sticks | Sticks | |
| A | 2 | 33 | A | 0 | | KickTechno Q | Kick Soft | Kick Soft | Kick Soft 2 | |
| A# | 2 | 34 | A# | 0 | | Rim Gate | OpenRimShot | OpenRimShot | OpenRimShot | |
| B | 2 | 35 | B | 0 | | KickTechno L | Kick Tight | Kick Tight | Gran Cassa | |
| C | 3 | 36 | C | 1 | | KickTechno 2 | Kick Jazz | Kick Small | GranCassa Mu | CuttingNoiz |
| C# | 3 | 37 | C# | 1 | | SideStickAn | Side Stick | Side Stick | CuttingNoiz2 | Phone Call |
| D | 3 | 38 | D | 1 | | Snare Clap | Snare | Brush Slap 3 | Band Snare | Door Squeak |
| D# | 3 | 39 | D# | 1 | | Hand Clap | Hand Clap | Hand Clap | String Slap | Door Slam |
| E | 3 | 40 | E | 1 | | Snare Dry 2 | Snare Tight | Brush Tap 2 | Band Snare 2 | Scratch Cut |
| F | 3 | 41 | F | 1 | | Tom Analog 1 | Tom Jazz 1 | Tom Brush 1 | Tom Jazz 1 | Scratch H 3 |
| F# | 3 | 42 | F# | 1 | 1 | HiHatClose 3 | Hi-HatClosed | Hi-HatClosed | Hi-HatClosed | Wind Chime |
| G | 3 | 43 | G | 1 | | Tom Analog 2 | Tom Jazz 2 | Tom Brush 2 | Tom Jazz 2 | Telephone 2 |
| G# | 3 | 44 | G# | 1 | 1 | HatCloseAn 2 | Hi-Hat Pedal | Hi-Hat Pedal | Hi-Hat Pedal | |
| A | 3 | 45 | A | 1 | | Tom Analog 3 | Tom Jazz 3 | Tom Brush 3 | Tom Jazz 3 | |
| A# | 3 | 46 | A# | 1 | 1 | HiHat Open 3 | Hi-Hat Open | Hi-Hat Open | Hi-Hat Open | |
| B | 3 | 47 | B | 1 | | Tom Analog 4 | Tom Jazz 4 | Tom Brush 4 | Tom Jazz 4 | |
| C | 4 | 48 | C | 2 | | Tom Analog 5 | Tom Jazz 5 | Tom Brush 5 | Tom Jazz 5 | |
| C# | 4 | 49 | C# | 2 | | Crash Analog | CrashCymbal1 | CrashCymbal1 | Hand Cymbal | |
| D | 4 | 50 | D | 2 | | Tom Analog 6 | Tom Jazz 6 | Tom Brush 6 | Tom Jazz 6 | |
| D# | 4 | 51 | D# | 2 | | RideCymbal 1 | RideCymbal 1 | RideCymbal 1 | HandCymShort | |
| E | 4 | 52 | E | 2 | | Chinese Cym | Chinese Cym | Chinese Cym | Chinese Cym | Fl.Key Click |
| F | 4 | 53 | F | 2 | | Ride Cym Cup | Ride Cym Cup | Ride Cym Cup | Ride Cym Cup | Ignition |
| F# | 4 | 54 | F# | 2 | | Tambourine | Tambourine | Tambourine | Tambourine | Squeal |
| G | 4 | 55 | G | 2 | | SplashCymbal | SplashCymbal | SplashCymbal | SplashCymbal | Exhaust |
| G# | 4 | 56 | G# | 2 | | Cowbell Anlg | Cowbell | Cowbell | Cowbell | Crash |
| A | 4 | 57 | A | 2 | | CrashCymbal2 | CrashCymbal2 | CrashCymbal2 | HandCymbal 2 | Siren |
| A# | 4 | 58 | A# | 2 | | Vibraslap | Vibraslap | Vibraslap | Vibraslap | Train |
| B | 4 | 59 | B | 2 | | RideCymbal 2 | RideCymbal 2 | RideCymbal 2 | HandCym2Shrt | Jet Plane |
| C | 5 | 60 | C | 3 | | Bongo H | Bongo H | Bongo H | Bongo H | Starship |
| C# | 5 | 61 | C# | 3 | | Bongo L | Bongo L | Bongo L | Bongo L | Burst |
| D | 5 | 62 | D | 3 | | Conga Anlg H | Conga H Mute | Conga H Mute | Conga H Mute | Coaster |
| D# | 5 | 63 | D# | 3 | | Conga Anlg M | Conga H Open | Conga H Open | Conga H Open | Submarine |
| E | 5 | 64 | E | 3 | | Conga Anlg L | Conga L | Conga L | Conga L | |
| F | 5 | 65 | F | 3 | | Timbale H | Timbale H | Timbale H | Timbale H | |
| F# | 5 | 66 | F# | 3 | | Timbale L | Timbale L | Timbale L | Timbale L | |
| G | 5 | 67 | G | 3 | | Agogo H | Agogo H | Agogo H | Agogo H | |
| G# | 5 | 68 | G# | 3 | | Agogo L | Agogo L | Agogo L | Agogo L | |
| A | 5 | 69 | A | 3 | | Cabasa | Cabasa | Cabasa | Cabasa | Shower |
| A# | 5 | 70 | A# | 3 | | Maracas 2 | Maracas | Maracas | Maracas | Thunder |
| B | 5 | 71 | B | 3 | ○ | SambaWhistlH | SambaWhistlH | SambaWhistlH | SambaWhistlH | Wind |
| C | 6 | 72 | C | 4 | ○ | SambaWhistlL | SambaWhistlL | SambaWhistlL | SambaWhistlL | Stream |
| C# | 6 | 73 | C# | 4 | | Guiro Short | Guiro Short | Guiro Short | Guiro Short | Bubble |
| D | 6 | 74 | D | 4 | ○ | Guiro Long | Guiro Long | Guiro Long | Guiro Long | Feed |
| D# | 6 | 75 | D# | 4 | | Claves 2 | Claves | Claves | Claves | |
| E | 6 | 76 | E | 4 | | Wood Block H | Wood Block H | Wood Block H | Wood Block H | |
| F | 6 | 77 | F | 4 | | Wood Block L | Wood Block L | Wood Block L | Wood Block L | |
| F# | 6 | 78 | F# | 4 | | Scratch H 2 | Cuica Mute | Cuica Mute | Cuica Mute | |
| G | 6 | 79 | G | 4 | | Scratch L 3 | Cuica Open | Cuica Open | Cuica Open | |
| G# | 6 | 80 | G# | 4 | 2 | TriangleMute | TriangleMute | TriangleMute | TriangleMute | |
| A | 6 | 81 | A | 4 | 2 | TriangleOpen | TriangleOpen | TriangleOpen | TriangleOpen | |
| A# | 6 | 82 | A# | 4 | | Shaker | Shaker | Shaker | Shaker | |
| B | 6 | 83 | B | 4 | | Jingle Bells | Jingle Bells | Jingle Bells | Jingle Bells | |
| C | 7 | 84 | C | 5 | | Bell Tree | Bell Tree | Bell Tree | Bell Tree | Dog |
| - | | 85 | C# | 5 | | | | | | Horse |
| - | | 86 | D | 5 | | | | | | Bird Tweet 2 |
| - | | 87 | D# | 5 | | | | | | Explosion |
| - | | 88 | E | 5 | | | | | | Firework |
| - | | 89 | F | 5 | | | | | | |
| - | | 90 | F# | 5 | | | | | | |
| - | | 91 | G | 5 | | | | | | |
| | | | | | | | | | Ghost | |
| | | | | | | | | | Maou | |

- **Key off :** Le son produit par les touches marquées "○" cesse à l'instant où la touche est relâchée.
- **Alternate Assign :** Le fait de jouer un instrument appartenant à un groupe ayant un numéro arrête immédiatement le son de tout autre instrument appartenant à un groupe ayant le même numéro.

- **Key Off:** Las teclas marcadas con "○" dejan de sonar en el momento en que se sueltan.
- **Alternate Assign:** Al tocar algún instrumento con un grupo numerado detendrá inmediatamente el sonido de cualquier otro instrumento del mismo grupo con el mismo número.

Style List / Style-Verzeichnis / Liste des styles / Lista de estilos



| Category | Style Name |
|------------------------|------------------|
| POP | 8Beat Pop 1 |
| | 8Beat Pop 2 |
| | 8Beat Standard |
| | 8Beat Medium |
| | 8Beat Ballad |
| | Piano Ballad |
| | Pop Ballad 1 |
| | Pop Ballad 2 |
| | Organ Ballad |
| | New Age |
| 16BEAT | 16Beat Pop |
| | 16Beat Shuffle 1 |
| | 16Beat Shuffle 2 |
| | 16Beat Ballad 1 |
| | 16Beat Ballad 2 |
| | 16Beat Ballad 3 |
| | Fusion |
| | Fusion Ballad |
| | Funk 1 |
| | Funk 2 |
| | DANCE POP |
| Dance Pop 2 | |
| Techno | |
| Eurobeat | |
| Synth Boogie | |
| 70s Disco | |
| Tropical | |
| Party Pop | |
| Jungle | |
| ROCK | |
| | 16Beat Rock |
| | 8Beat Uptempo |
| | Rock Shuffle |
| | Pop Shuffle |
| | Rhythm & Blues |
| | Soul |
| | Gospel Shuffle |
| | Rock & Roll |
| | Twist |
| | BALLAD |
| Slow Rock 2 | |
| 6/8 Ballad | |
| Jazz Ballad | |
| Orchestral Jazz Ballad | |
| Rock Ballad | |
| Soul Ballad | |
| 6/8 Gospel | |
| Blues | |
| Enka | |

| Category | Style Name | |
|-------------------|-----------------|--------------------|
| JAZZ | Swing | |
| | Big Band Swing | |
| | Big Band Ballad | |
| | Jazz Quartet | |
| | Cool Jazz | |
| | Dixieland | |
| | Boogie | |
| | Bebop | |
| | Jazz Rock | |
| | BALLROOM | Foxtrot |
| | | Jive |
| | | Big Band Quickstep |
| | | Cha Cha |
| Rhumba | | |
| Tango Continental | | |
| Mambo | | |
| Beguine | | |
| LATIN POP | | Bossa Nova 1 |
| | | Bossa Nova 2 |
| | Bossa Nova 3 | |
| | Salsa | |
| | Samba | |
| | Jazz Samba | |
| | Reggae | |
| | Pop Reggae | |
| | TRADITIONAL | March 1 |
| | | March 2 |
| 6/8 March | | |
| Polka | | |
| Ragtime | | |
| Showtune | | |
| Showtime | | |
| COUNTRY | | Bluegrass 1 |
| | Bluegrass 2 | |
| | Country Rock | |
| | Country Shuffle | |
| | 8Beat Country | |
| | Light Pop | |
| | Folkrock | |
| | Country Ballad | |
| | Cowboy Boogie | |
| | Country 2Step | |
| | WALTZ | Standard Waltz |
| Traditional Waltz | | |
| Pop Waltz | | |
| Jazz Waltz | | |
| Big Band Waltz | | |
| Viennese Waltz | | |
| Musette Waltz | | |
| Country T. Waltz | | |
| Country Waltz | | |

● Pianist Style List / Pianist-Style-Verzeichnis / Liste des styles Pianiste / Lista de estilos de pianista

| |
|--------------|
| Piano Ballad |
| Swing1 |
| March |
| Arpeggio1 |
| Samba |
| Rock & Roll |
| 80's Pop |
| 6/8 March |
| Pop Ballad |
| Petit Waltz |
| Jazz Ballad |
| Swing2 |
| Ragtime1 |
| Arpeggio2 |
| Bossa Nova |
| Honky Tonk |
| Tight Rock |
| Ragtime2 |
| Rock Piano |
| Jazz Waltz |
| 16beatBallad |
| 2beat |
| Musical |
| Arpeggio3 |
| Rhumba |
| BoogieWoogie |
| Dance Pop |
| Fanfare |
| Arpeggio4 |
| Minuet |
| Rocca Ballad |
| Old Jazz |
| Galop |
| Like Harp |
| Beguine |
| 16beat Rock |
| 8beat |
| Cha Cha |
| Like Swan |
| Birthday |



Parameter Chart / Parameterübersicht / Tableau des paramètres / Gráfica de parámetros

| Group | Parameters | Basic Setting | One Touch Setting Parameters | Registration Parameters (Freeze Parameters) | Registration All Setup (*1) | Backup Group | Recall Group |
|--------------------------|--|--|------------------------------|---|-----------------------------|----------------------|---------------|
| VOICE | First voice name *2 | Grand Piano | ○ | VOICE SETTING | ○ | VOICE SETTING | VOICES ETTING |
| | Octave Shift of first voice | 0 | ○ | VOICE SETTING | ○ | VOICE SETTING | VOICES ETTING |
| | Voice selected on each group | First voice of a voice group | ○ | VOICE SETTING | ○ | VOICE SETTING | VOICES ETTING |
| DUAL | Dual ON/OFF | OFF | — | — | ○ | VOICE SETTING | VOICES ETTING |
| | Second voice name | Strings Slow 1 | ○ | VOICE SETTING | ○ | VOICE SETTING | VOICES ETTING |
| | Octave Shift of second voice | 0 | ○ | VOICE SETTING | ○ | VOICE SETTING | VOICES ETTING |
| | Detune Depth | 5 | ○ | VOICE SETTING | ○ | VOICE SETTING | VOICES ETTING |
| | Dual Volume Balance | Equal level | ○ | VOICE SETTING | ○ | VOICE SETTING | VOICES ETTING |
| SPLIT | Split ON/OFF | OFF | ○ | VOICE SETTING | ○ | VOICE SETTING | VOICES ETTING |
| | Left range voice name | Acous.Bass 1 | ○ | VOICE SETTING | ○ | VOICE SETTING | VOICES ETTING |
| | Octave Shift of left range voice | 0 | ○ | VOICE SETTING | ○ | VOICE SETTING | VOICES ETTING |
| | Split Volume Balance | Equal level | ○ | VOICE SETTING | ○ | VOICE SETTING | VOICES ETTING |
| | Split Point | F#2 | — | VOICE SETTING | ○ | VOICE SETTING | VOICES ETTING |
| ORGAN COMBINATION | Six types of Organ settings. | Initial data | — | — | — | VOICE SETTING | VOICE SETTING |
| REVERB | Reverb ON/OFF | Differs depending on the voice | ○ | REVERB/EFFECT | ○ | REVERB/EFFECT | REVERB/EFFECT |
| | Reverb Type | Differs depending on the style | ○ | REVERB/EFFECT | ○ | REVERB/EFFECT | REVERB/EFFECT |
| | Reverb Total Depth | 50 | ○ | REVERB/EFFECT | ○ | REVERB/EFFECT | REVERB/EFFECT |
| | Reverb Part Depth (BASS, CHORD, RHYTHM, KBD, MIC.) | 50 | ○ | REVERB/EFFECT | ○ | REVERB/EFFECT | REVERB/EFFECT |
| EFFECT | Effect ON/OFF | Differs depending on the voice | ○ | REVERB/EFFECT | ○ | REVERB/EFFECT | REVERB/EFFECT |
| | Effect Type | Differs depending on the voice | ○ | REVERB/EFFECT | ○ | REVERB/EFFECT | REVERB/EFFECT |
| | Effect Depth (R1,R2, L) | Differs depending on the voice | ○ | REVERB/EFFECT | ○ | REVERB/EFFECT | REVERB/EFFECT |
| | Effect Depth (MIC.) | 0 | ○ | REVERB/EFFECT | ○ | REVERB/EFFECT | REVERB/EFFECT |
| MASTER EQUALIZER | Equalizer Type | FLAT | ○ | VOICE SETTING | ○ | VOICE SETTING | VOICES ETTING |
| POWER BASS (CVP-98 only) | Power Bass ON/OFF | OFF | — | — | ○ | VOICE SETTING | VOICES ETTING |
| | Power Bass Volume | 6 | — | — | ○ | VOICE SETTING | VOICES ETTING |
| REGISTRATION | Regist Freeze ON/OFF | OFF | — | — | — | REGISTRATION | REGISTRATION |
| | Freeze Parameters ON/OFF (VOICE SETTING, REVERB/EFFECT, TUNE, PEDAL) | OFF | — | — | — | REGISTRATION | REGISTRATION |
| | Freeze Parameters ON/OFF (ACMP SETTING) | ON | — | — | — | REGISTRATION | REGISTRATION |
| | Memorized Parameters of all 20 Registrations | Initial data | — | — | — | REGISTRATION | REGISTRATION |
| MIXER | Registration Name | REGIST A-1 — E-4 | — | — | — | REGISTRATION | REGISTRATION |
| | Mixer Part Volume (BASS, CHORD, PAD, PHRASE, RHYTHM) | 90 | ○ | ACMP SETTING | ○ | ACMP SETTING | ACMP SETTING |
| | Mixer Part Volume (HARMONY) | 90 | ○ | ACMP SETTING | ○ | ACMP SETTING | ACMP SETTING |
| STYLE | Mixer Part Volume (KBD) | 100 | ○ | VOICE SETTING | ○ | VOICE SETTING | VOICES ETTING |
| | Style Name | 8 Beat Pop 1 | ○ | ACMP SETTING | ○ | ACMP SETTING | ACMP SETTING |
| | Style selected on each group | First style of a style group | — | — | ○ | ACMP SETTING | ACMP SETTING |
| | MAIN A/B setting | MAIN A | ○ | ACMP SETTING | ○ | ACMP SETTING | — |
| | Auto Accompaniment ON/OFF | OFF | ○ | ACMP SETTING | ○ | ACMP SETTING | ACMP SETTING |
| | Auto Accompaniment type | MULTI FINGER | — | ACMP SETTING | ○ | ACMP SETTING | ACMP SETTING |
| | SMALL ACMP ON/OFF | OFF | ○ | ACMP SETTING | ○ | ACMP SETTING | ACMP SETTING |
| | Virtual Arranger ON/OFF | ON | ○ | ACMP SETTING | ○ | ACMP SETTING | ACMP SETTING |
| | Harmony ON/OFF | OFF | ○ | ACMP SETTING | ○ | ACMP SETTING | ACMP SETTING |
| | Harmony type | Trio | ○ | ACMP SETTING | ○ | ACMP SETTING | ACMP SETTING |
| METRONOME | Metronome type | NORMAL | — | — | ○ | ACMP SETTING | ACMP SETTING |
| | Metronome volume | 50 | — | — | ○ | ACMP SETTING | ACMP SETTING |
| SONG | Guide mode | NORMAL | — | — | ○ | SONG SETTING | SONG SETTING |
| | Guide Repeat number | 3 | — | — | ○ | SONG SETTING | SONG SETTING |
| | Piano Roll display | AUTO | — | — | ○ | SONG SETTING | SONG SETTING |
| | Lyric Display ON/OFF | ON | — | — | ○ | SONG SETTING | SONG SETTING |
| HELP | Help language | ENGLISH | — | — | — | Always set to BACKUP | — |
| FUNCTION | Tune | 440.0 Hz | — | — | ○ | TUNE | TUNE |
| | Transpose | 0 | — | VOICE SETTING | ○ | VOICE SETTING | VOICE SETTING |
| | Effect setting | AUTO | — | — | ○ | REVERB/EFFECT | REVERB/EFFECT |
| | Key Touch | NORMAL | — | VOICE SETTING | ○ | VOICE SETTING | VOICE SETTING |
| | Volume when [FIXED] is selected | 76 | — | VOICE SETTING | ○ | VOICE SETTING | VOICE SETTING |
| | Pan (LEFT, RIGHT1, RIGHT2) settings | CENTER | — | VOICE SETTING | ○ | VOICE SETTING | VOICE SETTING |
| | Left pedal setting | SOFT | — | PEDAL | ○ | PEDAL | PEDAL |
| | Damper range | R | — | PEDAL | ○ | PEDAL | PEDAL |
| | Damper mode | CONT. | — | PEDAL | ○ | PEDAL | PEDAL |
| | Soundboard depth (CVP-98 only) | 50 | — | — | — | VOICE SETTING | VOICE SETTING |
| | Transmission channel of left range voice | 3 | — | — | ○ | MIDI SETTING | MIDI SETTING |
| | Transmission channel of first voice | 1 | — | — | ○ | MIDI SETTING | MIDI SETTING |
| | Transmission channel of second voice | 2 | — | — | ○ | MIDI SETTING | MIDI SETTING |
| | Local Control ON/OFF | ON | — | — | ○ | MIDI SETTING | MIDI SETTING |
| | Sync. setting | INT. | — | — | ○ | MIDI SETTING | MIDI SETTING |
| | Program receive/send ON/OFF | Tx&Rx | — | — | ○ | MIDI SETTING | MIDI SETTING |
| | Control receive/send ON/OFF | Tx&Rx | — | — | ○ | MIDI SETTING | MIDI SETTING |
| | System Exclusive receive/send ON/OFF | Tx&Rx | — | — | ○ | MIDI SETTING | MIDI SETTING |
| | Start/Stop receive/send ON/OFF | Tx&Rx | — | — | ○ | MIDI SETTING | MIDI SETTING |
| | MIDI transpose receive ON/OFF | ON | — | — | ○ | MIDI SETTING | MIDI SETTING |
| | Auto Accompaniment and rhythm send ON/OFF | OFF | — | — | ○ | MIDI SETTING | MIDI SETTING |
| | Harmony send ON/OFF | OFF | — | — | ○ | MIDI SETTING | MIDI SETTING |
| | Remote Keyboard | OFF | — | — | ○ | MIDI SETTING | MIDI SETTING |
| | Micro Tuning ON/OFF | OFF | — | — | ○ | TUNE | TUNE |
| | Micro Tuning parameter settings | 0 | — | — | ○ | TUNE | TUNE |
| | Scale Tuning setting | PRESET | — | TUNE | ○ | TUNE | TUNE |
| | Preset Scale setting | EQUAL | — | TUNE | ○ | TUNE | TUNE |
| | Basic key of Preset Scale | C | — | TUNE | ○ | TUNE | TUNE |
| | User Scale parameter setting | 0 | — | TUNE | ○ | TUNE | TUNE |
| | Backup parameter ON/OFF settings | Differs depending on each parameter (*3) | — | — | — | Always set to BACKUP | — |
| | Pop-up Time (VOICE/STYLE) | 15 | — | — | ○ | UTILITY | UTILITY |
| | Pop-up Time (OTHERS) | 8 | — | — | ○ | UTILITY | UTILITY |
| | Alert Voice | STEEL DRUMS | — | — | ○ | UTILITY | UTILITY |
| | Alert Volume | 50 | — | — | ○ | UTILITY | UTILITY |

*1 These are the [ALL SETUP] parameters in the FUNCTION [REGISTRATION] page (display page 7).

*2 When an Organ Combination voice is selected, the edited settings are also included.

*3 REGISTRATION, UTILITY are set to ON, and others are set to OFF.

*1 Ce sont les paramètres [ALL SETUP] dans la page FONCTION [REGISTRATION] (page 7 de l'afficheur).

*2 Quand vous sélectionnez une voix de combinaison d'orgues, les réglages édités sont également inclus.

*3 REGISTRATION, UTILITY sont activés et les autres désactivés.

*1 Dies sind die [ALL SETUP]-Parameter auf der FUNCTION [REGISTRATION]-Anzeigeseite (Nr. 7).

*2 Wenn eine ORGAN COMBINATION-Stimme gewählt ist, sind die bearbeiteten Einstellungen ebenfalls eingeschlossen.

*3 REGISTRATION und UTILITY sind auf "BACKUP ON" (Speichererhalt EIN) gesetzt, alle anderen sind OFF (kein Speichererhalt).

*1 Etos son los parámetros de [ALL SETUP] de la página [REGISTRATION] de FUNCTION (página 7 de la visualización).

*2 Cuando se selecciona una voz de combinación de órgano, los ajustes editados también se incluyen.

*3 REGISTRATION y UTILITY se activan (ON) y los demás se desactivan (OFF).

Fingering Chart / Akkordliste / Tablature / Gráfica de digitado



* All fingerings shown are simple root-position types.
 * Die hier gezeigten Akkorde sind jeweils die Grundakkorde.
 * Tous les doigtés indiqués sont du type à position fondamentale simple.
 * Todos los digitados se muestran como tipos de posición de raíz sencilla.

Example for "C" chords Beispiele für "C"-Akkorde Exemples d'accords en "C" Ejemplo de acordes "C"

| | | | | |
|----------|----------|----------|----------|-----------|
| C | C6 | CM7 | CM7 (b5) | CM7 (#11) |
| Cadd9 | CM7 (9) | C6 (9) | C (b5) | Caug |
| C7 (#5) | CM7 (#5) | Cm | Cm6 | Cm7 |
| Cm7 (b5) | Cmadd9 | Cm7 (9) | Cm7 (11) | CmM7 (b5) |
| CmM7 | CmM7 (9) | Cm (b5) | Cdim7 | C7 |
| C7sus4 | C7 (9) | C7 (#11) | C7 (13) | C7 (b5) |
| C7 (b9) | C7 (b13) | C7 (#9) | Csus4 | |



Specifications / Technische Daten / Spécifications / Especificaciones

| | CVP-98 | CVP-96 | CVP-600 |
|---------------------------------------|--|---|---|
| KEYBOARD | 88 keys (A-1 — C7) | | |
| TONE GENERATOR | AWM (Advanced Wave Memory) | | |
| MAXIMUM SIMULTANEOUS POLYPHONY | 128 | 64 | |
| VOICES | Clavinova voices: 133 ; XG voices: 480 ; Drum Kits: 12 sets Voice Groups: Piano, Electric Piano, Vibraphone, Guitar, Clavinova Tone/Synth, Organ, Strings/Choir, Brass, Sax/Flute, Bass, Drums, XG Organ Combination, Dual/Split | | |
| EFFECTS | Effect (25 types), Reverb (16 types) | | |
| TONE CONTROLS | Master Equalizer, Power Bass (CVP-98 only) | | |
| ACCOMPANIMENT STYLES | Accompaniment Styles: 100; Pianist Styles: 40 Style Groups: Pop, 16 Beat, Dance Pop, Rock, Ballad, Jazz, Ballroom, Latin Pop, Traditional, Country, Waltz Disk/Custom Pianist Controls: Start/Stop, Syncro, Tap, Intro, Main A, Main B, Auto-fill, Ending, Fade in/out buttons Metronome, Tempo +/- buttons | | |
| AUTO ACCOMPANIMENT | Single Finger, Multi Finger, Fingered, Full Keyboard Harmony, Pianist, One Touch Setting, Virtual Arranger, Synchro Stop, Small ACMP, Chord Assist, Individual Part Volume Control (Mixer) | | |
| REGISTRATION | Bank A - E x 4 memory locations (20), Freeze | | |
| SONG PLAY MODE | Song Playback, Repeat, Volume control of individual Parts (Mixer) Controls: Song, Play/Stop, Rewind, Fast forward, Pause Guide Control: Easy Play, Next Note, Sound Repeat Lyric Disply | | |
| SONG RECORD MODE | Quick Recording, Track Recording, Chord Sequence, Song Name, Track Edit, Initial Edit | | |
| LCD/CONTROLS | 320 x 240 dot liquid crystal display, Contrast dial, Beat lamp, Function button, Mixer button, Page ◀ ▶ buttons, Display hold button, LCD buttons, data dial, +/- buttons, Exit button | | |
| VOLUME CONTROLS | Master volume, ACMP/Song volume | | |
| DEMO/HELP | 27 Demo Songs; 5 help languages (English, Japanese, German, French, Spanish) | | |
| DISK DRIVE | 3.5-inch micro floppy disk drive | | |
| PEDAL CONTROLS | RIGHT | Damper | |
| | CENTER | Sostenuto | |
| | LEFT | Soft, Start/Stop, Harmony On/Off, Registration+, Main A, Main B, Ending/Rit, Break, Fade In/Out | |
| JACKS AND TERMINALS | Headphone jacks x 2, AUX OUT jacks (L/L+R, R), AUX IN jacks (L/L+R, R), EXP.PEDAL jack, MIC. jack, TO HOST terminal, MIDI terminals (IN, OUT, THRU) | | |
| INPUT/OUTPUT SPECIFICATIONS | AUX OUT: Output Impedance: 600 Ω AUX IN: Input Impedance: 10 kΩ; Input Sensitivity: -10 dBm | | |
| MAIN AMPLIFIERS | 240 W (60 W x 4) | 120 W (60 W x 2) | |
| SPEAKERS | 16 cm x 2, 14 cm x 2, 2.5 cm x 2, 5 cm x 2 | 16 cm x 2, 5 cm x 4 | |
| DIMENSIONS (W x D x H) | Music stand down | | Lid down |
| | 1415 mm x 603 mm x 890 mm (55-3/4" x 23-3/4" x 35") | 1415 mm x 603 mm x 890 mm (55-3/4" x 23-3/4" x 35") | 1417 mm x 870 mm x 908 mm (55-3/4" x 34-1/4" x 35-3/4") |
| | Music stand up | | Lid up |
| | 1415 mm x 603 mm x 1055 mm (55-3/4" x 23-3/4" x 41-1/2") | 1415 mm x 603 mm x 1050 mm (55-3/4" x 23-3/4" x 41-3/8") | 1417 mm x 870 mm x 1253 mm (55-3/4" x 34-1/4" x 49-3/8") |
| WEIGHT | 69.5 kg (153 lbs., 4 oz.) | 66.0 kg (145 lbs., 8 oz.) | 84.0 kg (185 lbs., 3 oz.) |

• Specifications and descriptions in this owner's manual are for information purposes only. Yamaha Corp. reserves the right to change or modify products or specifications at any time without prior notice. Since specifications, equipment or options may not be the same in every locale, please check with your Yamaha dealer.

• Die technischen Daten und Beschreibungen in dieser Bedienungsanleitung dienen nur der Information. Yamaha Corp. behält sich das Recht vor, Produkte oder deren technische Daten jederzeit ohne vorherige Ankündigung zu verändern oder zu modifizieren. Da die technischen Daten, das Gerät selbst oder Sonderzubehör nicht in jedem Land gleich sind, setzen Sie sich im Zweifel bitte mit Ihrem Yamaha-Händler in Verbindung.

• Les caractéristiques techniques et les descriptions du mode d'emploi ne sont données que pour information. Yamaha Corp. se réserve le droit de changer ou modifier les produits et leurs caractéristiques techniques à tout moment sans aucun avis. Du fait que les caractéristiques techniques, les équipements et les options peuvent différer d'un pays à l'autre, adressez-vous au distributeur Yamaha le plus proche.

• Las especificaciones y descripciones de este manual del propietario tienen sólo el propósito de servir como información. Yamaha Corp. se reserva el derecho a efectuar cambios o modificaciones en los productos o especificaciones en cualquier momento sin previo aviso. Puesto que las especificaciones, equipos u opciones pueden no ser las mismas en todos los mercados, solicite información a su distribuidor Yamaha.

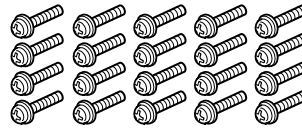
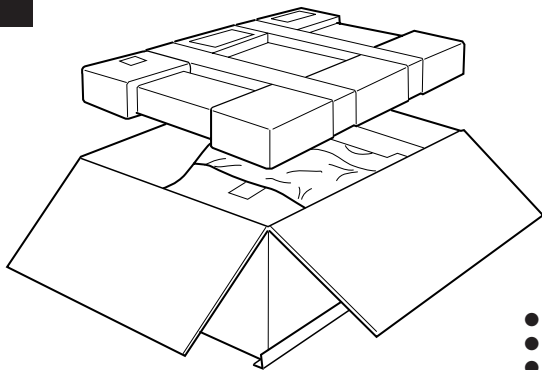
1

5 x 20 mm long screws
Lange Schrauben
(5 x 20 mm)
Vis longue 5 x 20 mm
Tornillos largos de 5 x 20 mm

x 20

● Cord holders
● Kabelhalter
● Serre-câble
● Soportes de cable

x 2

● AC power cord
● Netzkabel
● Cordon d'alimentation
● Cable de alimentación de CA

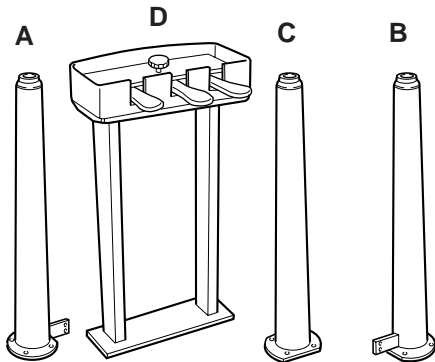

● Front leg **A**
● Vorderes Standbein **A**
● Pied avant **A**
● Pata frontal **A**

● Front leg **B**
● Vorderes Standbein **B**
● Pied avant **B**
● Pata frontal **B**

● Rear leg **C**
● Hinteres Standbein **C**
● Pied arrière **C**
● Pata trasera **C**

● Pedal box **D**
● Pedalkasten **D**
● Pédalier **D**
● Caja de pedales **D**

CVP-600: Assembly

- NOTE**
- Be careful not to confuse parts, and be sure to install all parts in the correct direction. Please assemble in accordance with the sequence given below.
 - Assembly should be carried out by at least two persons.
 - Be sure to use the correct screw size, as indicated above. Use of incorrect screws can cause damage.
 - Be sure to tighten up all screws upon completing assembly of each unit.
 - The entire package must be turned over during assembly, so select an area that is large enough for the unpacking and assembly operation.

1 Open the carton and remove the parts from the upper level.

Referring to the illustration, make sure that you have all the required parts.

- NOTE**
- A bench may be supplied or optional, depending on the location in which the instrument was purchased.

2 Attach the three legs (A, B, C).

Use scissors or a cutter to remove the packing material in which the main unit is wrapped. Then attach the legs to the bottom of the main unit using four 5 x 20 mm long screws per leg. Please refer to the illustration carefully when attaching the legs, to ensure that the positions of the (A) and (B) legs are not reversed. Also make sure that there is minimum space between the (A) and (B) leg flanges and the metal frame on the bottom of the main unit (the screws which attach the legs to this frame will be installed later, in step **6**).

CVP-600: Zusammenbau

- NOTIZ**
- Achten Sie darauf, die Teile nicht zu verwechseln, und installieren Sie alle Teile in der richtigen Ausrichtung. Gehen Sie beim Zusammenbau bitte in der angegebenen Reihenfolge vor.
 - Die Montage sollte von mindestens zwei Personen vorgenommen werden.
 - Achten Sie darauf, die richtige Schraubengröße zu verwenden, wie es oben gezeigt ist. Die Verwendung der falschen Schrauben kann zu Schäden führen.
 - Achten Sie während der Montage darauf, bei jedem Arbeitsgang alle Schrauben festzuziehen.
 - Das Instrument wird im Karton zusammengebaut und muß abschließend zum Aufstellen umgedreht werden. Achten Sie darauf, daß ausreichend Platz zum Auspacken und Aufstellen vorhanden ist.

1 Den Karton öffnen und die Teile der obersten Lage herausnehmen.

Prüfen Sie anhand der Abbildung, ob die Teile vollständig vorhanden sind.

- NOTIZ**
- Je nach Vertriebsland wird eine Sitzbank entweder standardmäßig mitgeliefert oder ist als Sonderzubehör erhältlich.

2 Die drei Standbeine (A, B und C) montieren.

Entfernen Sie das Verpackungsmaterial an der Unterseite des Instruments mit einer Schere oder einem anderen Schneidwerkzeug. Schrauben Sie dann die drei Standbeine mit jeweils vier langen Schrauben (5 x 20 mm) an das Instrument. Richten Sie sich bei der Montage der Standbeine bitte nach der Abbildung — die vorderen Standbeine (A und B) dürfen nicht vertauscht werden. Achten Sie auch darauf, daß zwischen den Ansätzen an den vorderen Standbeinen (A und B) und dem Metallrahmen an der Unterseite des Instruments ein möglichst kleiner Zwischenraum verbleibt (die Standbeine werden an späterer Stelle, in Schritt **6**, mit diesem Rahmen verschraubt).

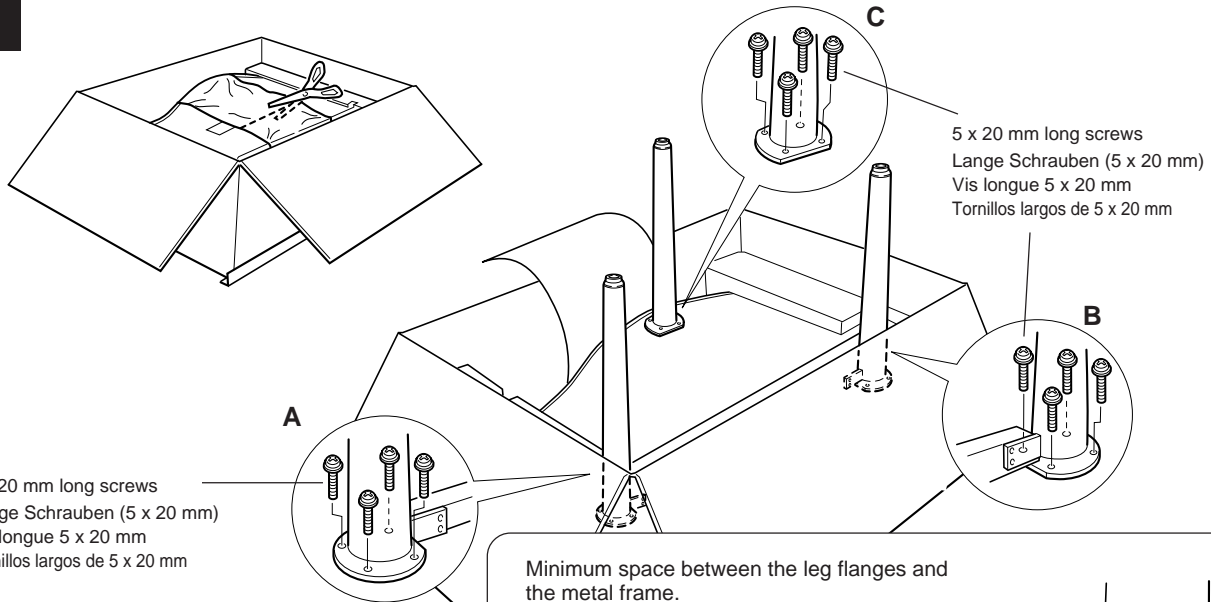
2

5 x 20 mm long screws
Lange Schrauben (5 x 20 mm)
Vis longue 5 x 20 mm
Tornillos largos de 5 x 20 mm

5 x 20 mm long screws
Lange Schrauben (5 x 20 mm)
Vis longue 5 x 20 mm
Tornillos largos de 5 x 20 mm

Minimum space between the leg flanges and the metal frame.

Minimaler Zwischenraum zwischen Ansatz und Metallrahmen.

Espace minimum entre les collerettes de pieds et le châssis métallique.

Espacio mínimo entre las bridas de las patas y el bastidor metálico.

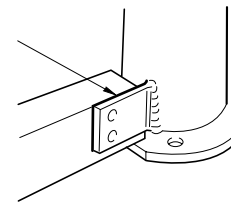

CVP-600: Montage

- NOTE**
- Veiller à ne pas mélanger les pièces et à les installer dans le sens correct. Veuillez assembler l'instrument dans l'ordre indiqué ci-dessous.
 - La présence de deux personnes minimum est nécessaire pour procéder au montage.
 - Toujours utiliser des vis aux dimensions correctes, comme indiqué cidessus. L'utilisation de vis aux dimensions incorrectes pourrait en effet endommager l'instrument.
 - Resserrer convenablement toutes les vis après le montage de chaque élément.
 - L'ensemble du carton d'emballage doit être retourné pendant le montage aussi, choisir un endroit suffisamment spacieux pour les opérations de déballage et de montage.

1 Ouvrir le carton et retirer les pièces du niveau supérieur.

Vérifier que toutes les pièces figurant sur l'illustration se trouvent bien dans le carton.

- NOTE**
- Un banc peut être fourni ou en option, selon l'endroit où l'instrument a été acheté.

2 Monter les trois pieds (A, B, C).

Utiliser une paire de ciseaux ou un cutter pour retirer les matériaux dans lesquels l'instrument est emballé. Puis, monter les pieds au-dessous de l'instrument avec quatre vis longues 5 x 20 mm par pied. Pour le montage des pieds, se référer soigneusement à l'illustration afin de garantir que la position des pieds (A) et (B) n'est pas inversée. S'assurer aussi qu'il y a un espace minimum entre les collerettes de pieds (A) et (B) et le châssis métallique sous l'instrument (les vis qui fixent les pieds sur ce châssis seront installées ultérieurement, à l'étape 6).

CVP-600: Montaje

- NOTA**
- Observe cuidado para no confundir las piezas, y asegúrese de montar todas ellas en el sentido correcto. Proceda al montaje en el orden indicado a continuación.
 - El montaje deberá realizarse al menos por dos personas.
 - Procure utilizar los tornillos del tamaño adecuado, según se indica arriba. El empleo de tornillos inadecuados puede ocasionar daños en el instrumento.
 - Asegúrese de apretar bien todos los tornillos después de montar cada unidad.
 - Deberá dar la vuelta a todo el paquete durante el montaje, por lo que es mejor que seleccione un lugar espacioso para efectuar el desembalaje y el montaje.

1 Abra el cartón y extraiga las partes del nivel superior.

Consultando la ilustración, asegúrese de que dispone de todas las partes necesarias.

- NOTA**
- Es posible que se suministre un banco o que sea opcional, dependiendo del lugar de venta del instrumento.

2 Coloque las tres patas (A, B, C).

Emplee unas tijeras o un cortador para sacar el material de embalaje en el que está envuelta la unidad principal. Luego, monte las patas en la parte inferior de la unidad principal empleando cuatro tornillos largos de 5 x 20 mm por pata. Consulte con cuidado la ilustración para asegurarse de que las posiciones de las patas (A) y (B) no se invierten. Asegúrese también que existe un espacio mínimo entre las bridas de las patas (A) y (B) y el bastidor metálico en la parte inferior de la unidad principal (los tornillos que se unen las patas a este bastidor se instalarán después, en el paso 6).

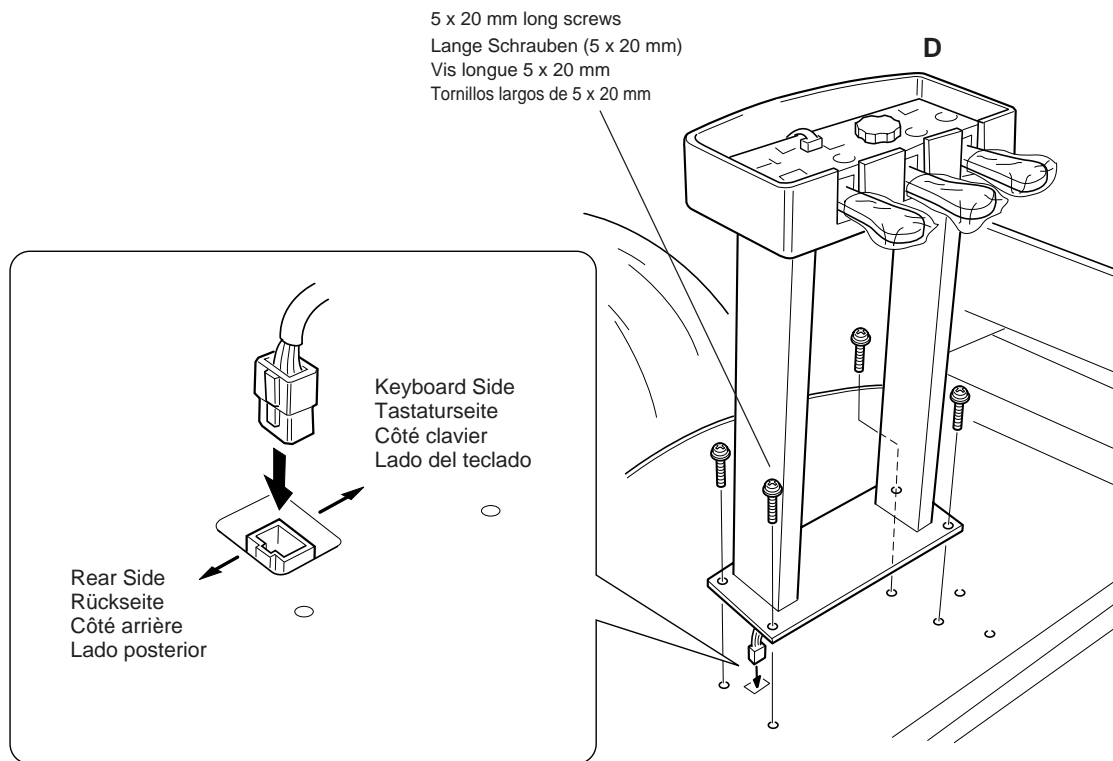

3 Attach the pedal box (D).

Before attaching the pedal box, connect the pedal cord. Pull the pedal plug out from the hole in the base plate and plug it into the socket in the bottom of the main unit with the lug on the plug facing the rear of the main unit (refer to the illustration). If the plug won't go in properly, don't force it ... check the plug orientation and try again.

Making sure that the pedal cord doesn't get caught between the base plate and main unit, carefully lower the pedal box assembly onto the bottom of the main unit and line up the screw holes. Finally, attach the pedal box with four 5 x 20 mm long screws.

4 Turn over the instrument and packing.

Make sure that the three legs are firmly attached, then using the front legs (A) and (B) for support, turn over the instrument and packing so that the carton is on top of the instrument.

3 Den Pedalkasten (D) montieren.

Schließen Sie vor der Montage des Pedalkastens zunächst das Pedalkabel an. Führen Sie den Kabelstecker durch das Loch in der Grundplatte, um ihn dann, mit der Führungsnase zur Rückseite des Instruments weisend, an die Buchse an der Unterseite anzuschließen (siehe Abbildung). Wenn der Stecker nicht in die Buchse paßt, bitte nicht mit Gewalt hineinstecken ... prüfen Sie seine Ausrichtung, und versuchen Sie es dann noch einmal.

Setzen Sie den Pedalkasten nun so auf der Unterseite des Instruments an, daß das Pedalkabel nicht zwischen Grundplatte und Instrument eingeklemmt wird und die Schraubenbohrungen zur Deckung kommen. Schrauben Sie den Pedalkasten dann mit vier langen Schrauben (5 x 20 mm) fest.

4 Das Instrument mit dem Karton aufstellen.

Prüfen Sie noch einmal, ob die drei Standbeine fest montiert sind, und stellen Sie das Instrument dann über die vorderen Standbeine (A und B) so aufrecht, daß der Karton oben ist.

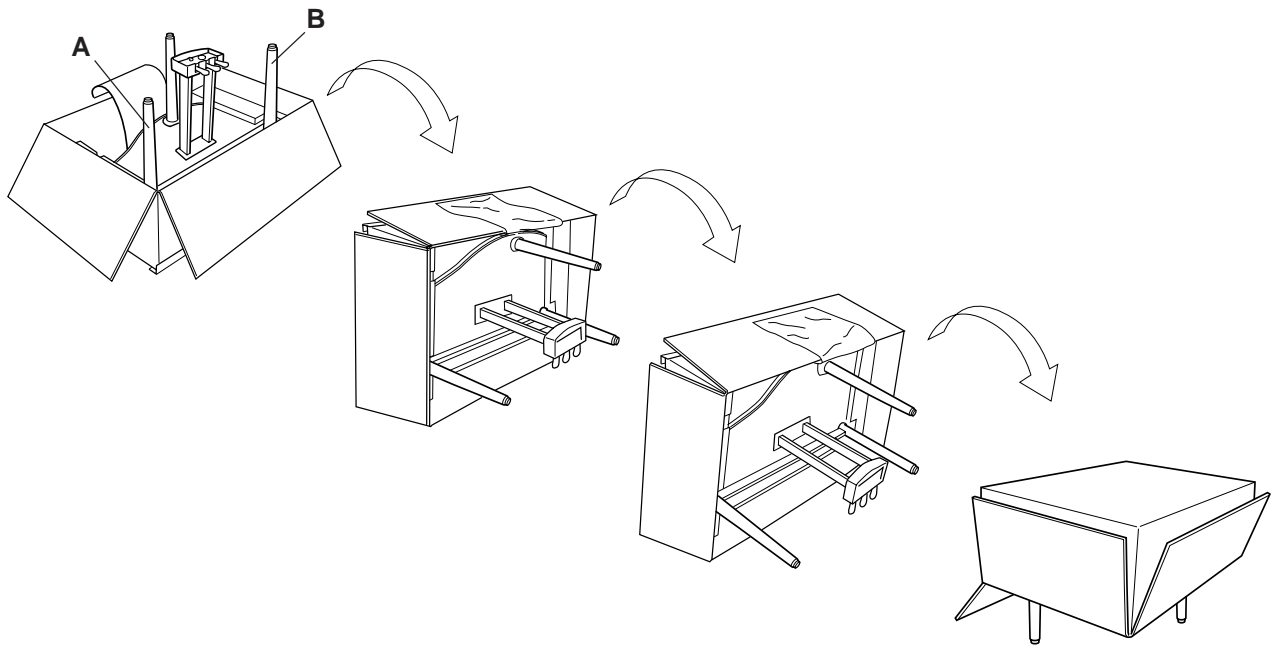

3 Monter le pédalier (D).

Avant de monter le pédalier, raccordez son cordon. Sortir le connecteur de pédalier de l'orifice de l'embase et le brancher dans la prise sous de l'instrument, la cosse du connecteur orienté vers l'arrière de l'instrument (comme indiqué sur l'illustration). Si la prise est difficile à enclencher, ne pas forcer... vérifier l'orientation de la prise et essayer à nouveau.

En vérifiant que le cordon du pédalier n'est pas pincé entre l'embase et l'instrument, abaisser soigneusement l'ensemble de pédalier en place au bas de l'instrument et l'aligner sur les trous de vis. Pour finir, monter le pédalier avec quatre vis longues 5 x 20 mm.

4 Retourner l'instrument et l'emballage.

Vérifier que les trois pieds sont fermement fixés, puis, en utilisant les pieds avant (A) et (B) comme support, retourner l'instrument et l'emballage, de manière à ce que le carton se trouve sur l'instrument.

3 Coloque la caja de pedales (D).

Antes de montar la caja de pedales, conecte el cable de los pedales. Tire de la clavija de pedales desde el orificio de la placa de la base y enchúfelo a la toma de la parte inferior de la unidad principal con el apéndice de la clavija encarado a la parte posterior de la unidad principal (consulte la ilustración). Si la clavija no entra correctamente, no la fuerza ... compruebe la orientación de la clavija e inténtelo de nuevo.

Teniendo cuidado de que el cable de los pedales no queda pillado entre la placa de la base y la unidad principal, baje con cuidado el conjunto de la caja de pedales a la parte inferior de la unidad principal y alinee los orificios de los tornillos. Finalmente, monte la caja de pedales con cuatro tornillos largos de 5 x 20 mm.

4 Dé la vuelta al instrumentos y al embalaje.

Asegúrese de que las tres patas estén firmemente unidas, y empleando las patas frontales (A) y (B) como soporte, dé la vuelta al instrumento y al embalaje de modo que el cartón quede en la parte superior del instrumento.

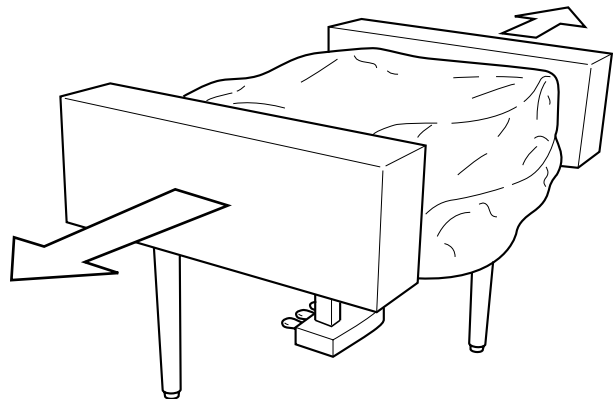
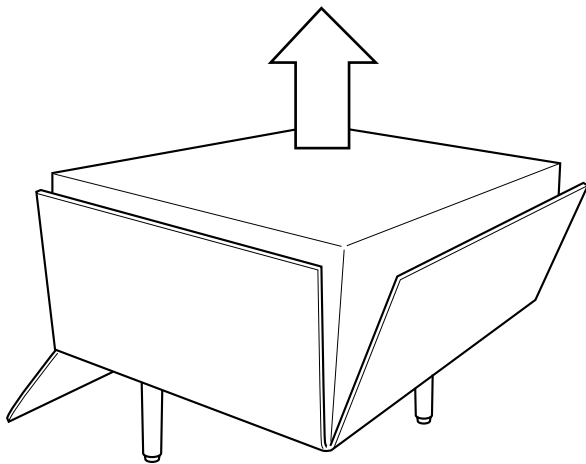
5**5 Remove the carton and packing material.**

Lift and remove the carton, then remove the remaining packing material from the main unit.

6 Attach the front leg/frame screws.

Firmly attach the front legs (A) and (B) to the frame on the bottom of the main unit using two 5 x 20 mm long screws for each leg.

7 Voltage Selector

Check the setting of the voltage selector which is provided in some areas. To set the selector for 110V, 127V, 220V or 240V main voltages, use a "minus" screwdriver to rotate the selector dial so that the correct voltage for your region appears next to the pointer on the panel. The voltage selector is set at 240V when the unit is initially shipped.

5 Den Karton und das Verpackungsmaterial entfernen.

Heben Sie zunächst den Karton weg, und entfernen Sie dann die beiden Formstücke und das übrige Verpackungsmaterial.

6 Die vorderen Standbeine mit dem Rahmen verschrauben.

Schrauben Sie die vorderen Standbeine (A und B) mit jeweils zwei langen Schrauben (5 x 20 mm) gut am Rahmen an der Unterseite des Instruments fest.

7 Den Spannungswähler einstellen.

Stellen Sie den Spannungswähler (falls vorhanden) auf die örtliche Netzspannung ein. Zum Verstellen drehen Sie den Spannungswähler mit einem Schlitzschraubendreher, bis der richtige Spannungswert (110, 127, 220 oder 240) an der Pfeilmarkierung steht. Bei der Auslieferung werden alle Instrumente mit Spannungswähler auf "240" voreingestellt.

6

5 x 20 mm long screws
Lange Schrauben (5 x 20 mm)
Vis longue 5 x 20 mm
Tornillos largos de 5 x 20 mm

5 x 20 mm long screws
Lange Schrauben (5 x 20 mm)
Vis longue 5 x 20 mm
Tornillos largos de 5 x 20 mm

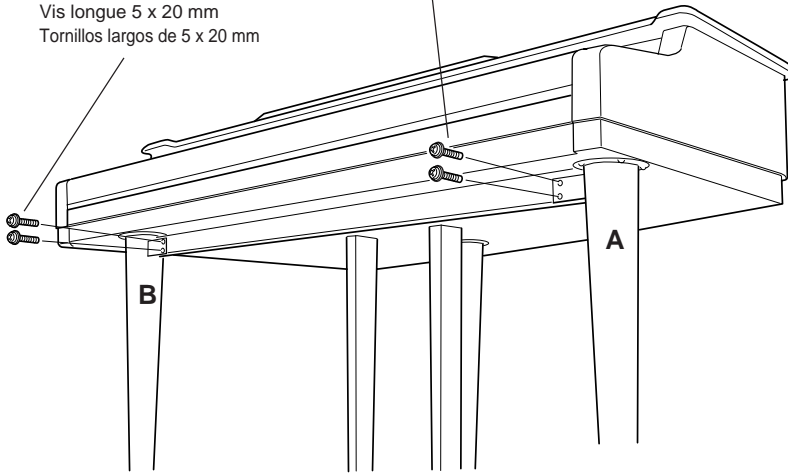
**7**

- A voltage selector is provided in some areas.
- Spannungswähler (nur in bestimmten Verkaufsgebieten)
- Un sélecteur de tension est prévu pour certaines régions
- El selector de tensión está provisto para ciertos destinos.

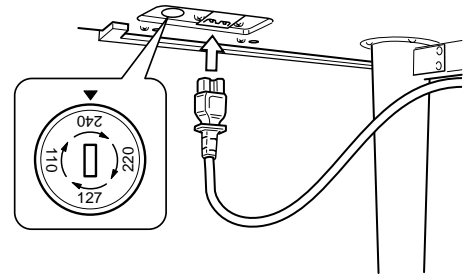

5 Retirer le carton et les matériaux de garniture.

Soulever le carton et le retirer, puis retirer les matériaux d'emballage qui restaient sur l'instrument.

6 Fixer les vis pieds avant/châssis.

Fixer fermement, sous l'instrument, les pieds avant (A) et (B) au châssis avec deux vis longues 5 x 20 mm par pied.

7 Sélecteur de tension.

Vérifiez le réglage du sélecteur de tension qui est prévu pour certaines régions. Pour régler le sélecteur sur 110 V, 127 V, 220 V ou 240 V, utilisez un tournevis à lame plate pour tourner le cadran du sélecteur afin de mettre l'indication correspondant à la tension de votre région vis à vis du repère triangulaire situé sur le panneau. Le sélecteur de tension est réglé sur 240 V au départ d'usine.

5 Extraiga el cartón y el material de embalaje.

Levante y extraiga el cartón, y saque entonces el material de embalaje restante de la unidad principal.

6 Monte los tornillos de las patas frontales/bastidor.

Coloque firmemente las patas frontales (A) y (B) en el bastidor en la parte inferior de la unidad principal empleando dos tornillos largos de 5 x 20 mm para cada pata.

7 Selector de tensión.

Compruebe el ajuste del selector de tensión que se incorpora para ciertos destinos. Para ajustar el selector a 110V, 127V, 220V ó 240V de la red de alimentación, emplee un destornillador de cabeza recta "-" para girar el selector de modo que la tensión correcta de su zona aparezca al lado del indicador del panel. El selector de tensión se ajusta a 240V cuando la unidad sale de fábrica.

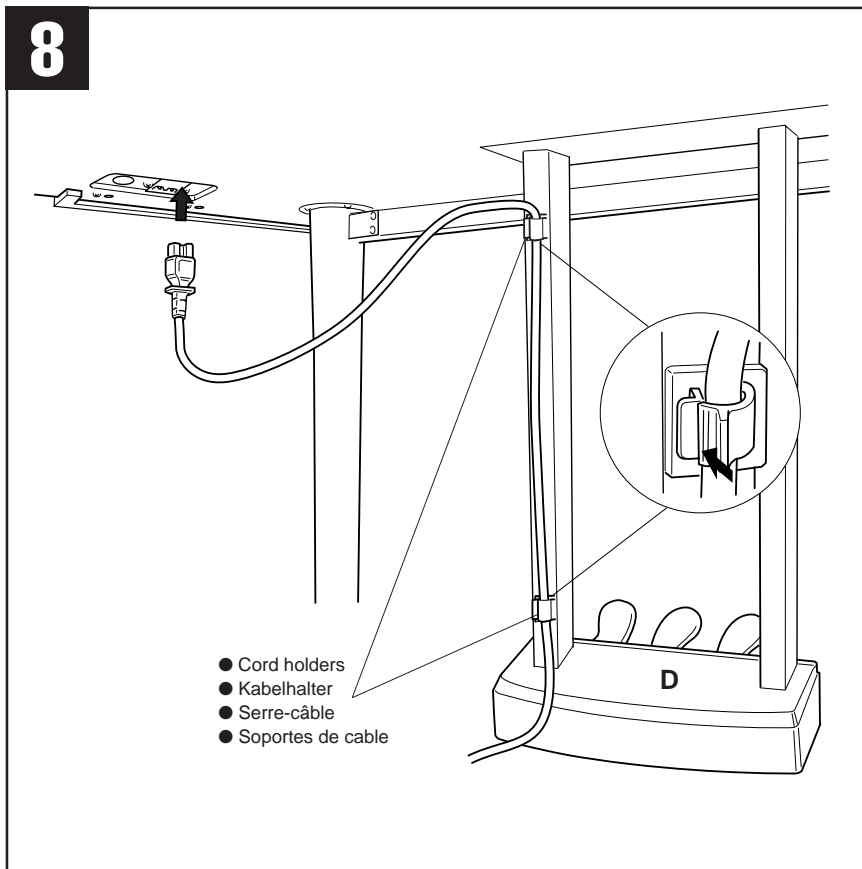

8 Attach the cord holders and plug in the AC cord.

Remove the protective backing from the adhesive surface of the cord holders, and attach at approximately the locations shown in the illustration. Plug the main-unit end of the AC cord into the corresponding socket on the bottom of the main unit, then secure the cord with the cord holders.

A plug adaptor may be also provided in some areas to match the pin configuration of the AC wall outlets in your area.

9 Set the adjuster.

For stability, an adjuster is provided on the bottom of the pedal box (D). Rotate the adjuster until it comes in firm contact with the floor surface. The adjuster ensures stable pedal operation and facilitates pedal effect control. If the adjuster is not in firm contact with the floor surface, distorted sound may result.

■ After completing the assembly, please check the following.

- Are there any parts left over?
→ Review the assembly procedure and correct any errors.
- Is the Clavinova clear of doors and other movable fixtures?
→ Move the Clavinova to an appropriate location.
- Does the Clavinova make a rattling noise when you shake it?
→ Tighten all screws.
- Does the pedal box rattle or give way when you step on the pedals?
→ Turn the adjuster so that it is set firmly against the floor.
- Are the pedal and power cords inserted securely into the sockets?
→ Check the connection.
- If the main unit creaks or is otherwise unsteady when you play on the keyboard, refer to the assembly diagrams and retighten all screws.

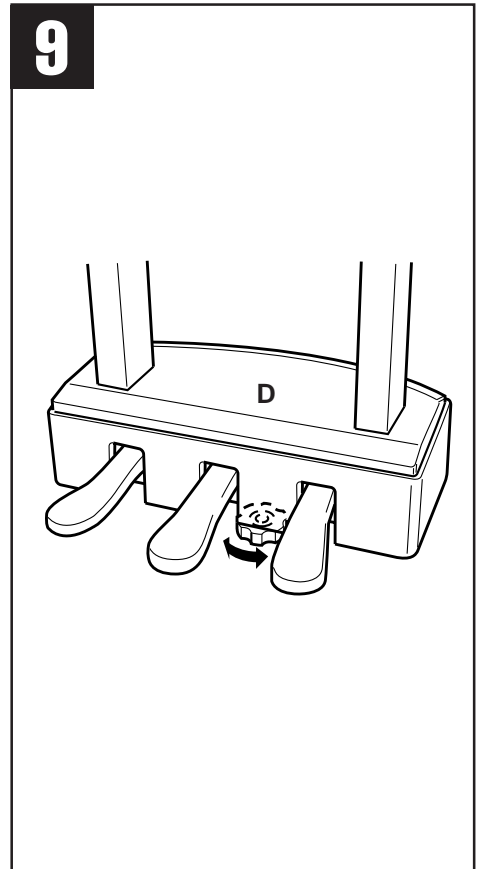

8 Die Kabelhalter anbringen und das Netzkabel anschließen.

Ziehen Sie das Schutzpapier von der Klebefläche der Kabelhalter ab, und bringen Sie die Halter ungefähr an den in der Abbildung gezeigten Stellen an. Stecken Sie den kleineren Stecker des Netzkabels in die entsprechende Buchse an der Unterseite des Instruments, um das Kabel dann in die Kabelhalter zu legen.

In manchen Gebieten wird ein Steckeradapter mitgeliefert, um den Anschluß an die evtl. unterschiedlich geformte Steckdose zu ermöglichen.

9 Den Pedalfuß einstellen.

Um dem Pedalkasten (D) mehr Standfestigkeit zu geben, ist er mit einem verstellbaren Pedalfuß ausgestattet. Drehen Sie diesen Fuß heraus, bis er fest auf der Bodenfläche steht. Der Pedalfuß stabilisiert den Pedalkasten und ermöglicht eine präzise Pedalbetätigung. Wenn der Pedalfuß nicht fest auf dem Boden steht, können Klangverzerrungen auftreten.

■ Wenn der Zusammenbau beendet ist, prüfen Sie bitte folgende Dinge:

- Sind Teile übrig geblieben?
→ Gehen Sie den Vorgang des Zusammenbaus noch einmal durch und korrigieren Sie eventuelle Fehler.
- Befindet sich das Clavinova weit genug von Türen und anderen beweglichen Vorrichtungen entfernt?
→ Bewegen Sie das Clavinova an einen entsprechend sicheren Ort.
- Macht das Clavinova Klappergeräusche, wenn Sie es schütteln?
→ Ziehen Sie alle Schrauben fest.
- Klappert der Pedalkasten oder gibt er nach, wenn Sie das Pedal treten?
→ Drehen Sie den Höhenversteller, bis er fest auf dem Fußboden steht.
- Sind Pedal- und Netzkabel richtig an den Buchsen angeschlossen?
→ Prüfen Sie die Verbindung.
- Wenn die Haupteinheit knarrt oder beim Spielen wackelt, betrachten Sie die Abbildungen und ziehen Sie alle Schrauben noch einmal nach.

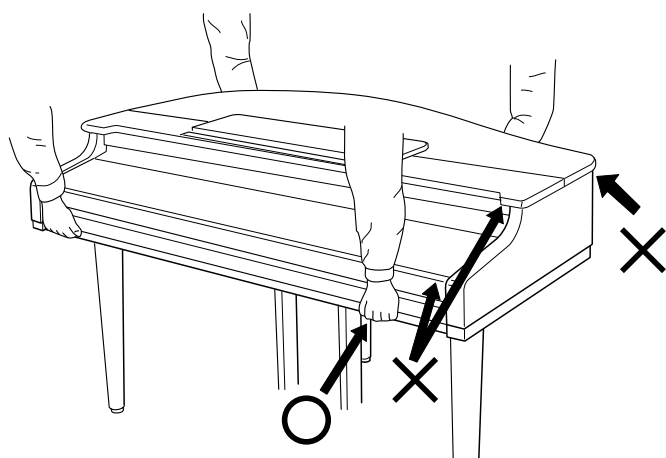

CAUTION • When moving the instrument after assembly, always hold the lower surface of the main unit, NEVER the lid or keyboard cover. Improper handling can result in damage to the instrument or personal injury.

VORSICHT • Fassen Sie zum Umstellen des Instruments nach dem Zusammenbau stets unter das Gehäuse; heben Sie es niemals am Gehäuse- oder Tastaturdeckel. Bei Nichtbeachtung dieses Punkts kann das Instrument beschädigt und im Extremfall eine Verletzung hervorgerufen werden.

PRECAUTION • Pour déplacer l'instrument après le montage, toujours tenir l'instrument par la surface inférieure, JAMAIS par le couvercle ou le protège-clavier. Une mauvaise manipulation peut provoquer des dommages ou des blessures.

CUIDADO • Cuando mueva el instrumento después del montaje, sostenga siempre la superficie inferior de la unidad principal. NUNCA por la tapa ni cubierta del teclado. La manipulación indebida puede causar daños en el instrumento o personales.

8 Fixer les serre-fils et brancher le cordon de l'alimentation secteur.

Retirer le film protecteur des surfaces adhésives aux serre-fils et les fixer approximativement aux emplacements indiqués sur l'illustration. Brancher l'extrémité instrument du cordon secteur dans la prise correspondante au bas de l'instrument et fixer le cordon avec les serre-fils.

Un adaptateur de prise peut également être fourni dans certaines régions pour pouvoir brancher le cordon à la prise secteur murale.

9 Régler la hauteur du pédalier

Pour assurer la stabilité, un dispositif de réglage du pédalier (D) est équipé. Tourner ce dispositif jusqu'à ce qu'il soit en contact ferme avec le sol. Ce dispositif assure la stabilité du pédalier pendant son utilisation et facilite la commande au pied des effets. Si ce dispositif n'est pas fermement en contact avec le sol, le son pourra être déformé.

■ Lorsque le montage est terminé, veuillez mener à bien les vérifications suivantes.

- Reste-t-il des pièces non utilisées?
→ Passer en revue la procédure de montage et corriger toute erreur éventuelle.
- Le Clavinova est-il placé à l'écart des portes et de toute autre structure mobile?
→ Déplacer le Clavinova vers un emplacement approprié.
- Lorsque vous secouez quelque peu le Clavinova, entendez-vous un cliquetis?
→ Serrer convenablement toutes les vis.
- Le pédalier fait-il du bruit ou s'écarte-t-il lorsque vous appuyez sur les pédales?
→ Tourner le stabilisateur de sorte qu'il repose fermement sur le sol.
- Les cordons des pédales et d'alimentation sont-ils bien enfoncés dans les prises?
→ Vérifier toutes les connexions.
- Si la partie principale de l'appareil craque ou est instable lorsque vous jouez sur le clavier, consulter les diagrammes de montage et resserrer toutes les vis.

8 Monte los soportes de cable y enchufe el cable de CA

Extraiga el dorso protector de la superficie adhesiva de los soportes de cable, y colóquelos aproximadamente en los lugares mostrados en la ilustración. Enchufe e extremo de la unidad principal del cable de CA en la toma correspondiente de la parte inferior de la unidad principal, y fije el cable con los soportes de cables.

En algunas zonas puede suministrarse también un adaptador para adaptar la configuración de las patillas de los tomacorrientes de CA de su localidad.

9 Ajuste el ajustador.

Para mayor estabilidad, se proporciona un ajustador en la parte inferior de la caja de pedales (D). Gire el ajustador hasta que se ponga firmemente en contacto con la superficie del suelo. El ajustador asegura la operación estable de los pedales y facilita el control de efectos de los pedales. Si el ajustador no está firmemente en contacto con la superficie del suelo, puede producirse sonido distorsionado.

■ Cuando haya concluido el montaje, compruebe los siguientes puntos:

- ¿Ha quedado alguna pieza sin instalar?
→ Revise el procedimiento de montaje y corrija cualquier error que se haya podido cometer.
- ¿Está el Clavinova alejado del recorrido de puertas y muebles?
→ Traslade el Clavinova a una posición adecuada.
- ¿Suena algún ruido de holgura cuando se mueve el Clavinova?
→ Apriete con firmeza todos los tornillos.
- ¿Vibra o cede la caja de pedales cuando se pisan los pedales?
→ Gire el ajustador hasta que se apoye firmemente sobre el suelo.
- ¿Están perfectamente insertados los cables de pedal y alimentación en los conectores?
→ Revise las conexiones.
- Si la unidad principal cruje o presenta algún signo de inestabilidad cuando se toca el teclado, consulte los esquemas de montaje y vuelva a apretar todos los tornillos.

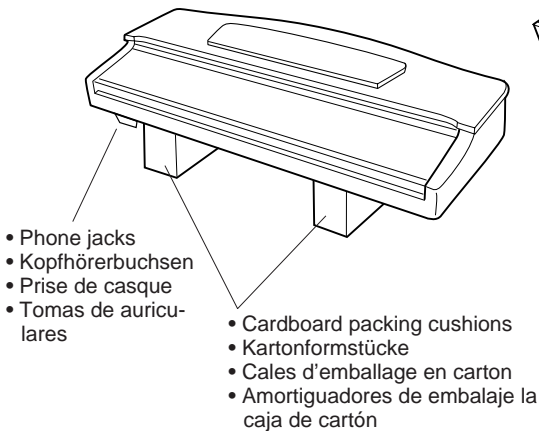

- Phone jacks
- Kopfhörerbuchsen
- Prise de casque
- Tomas de auriculares

- Cardboard packing cushions
- Kartonformstücke
- Cales d'emballage en carton
- Amortiguadores de embalaje la caja de cartón

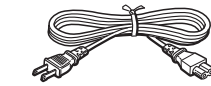
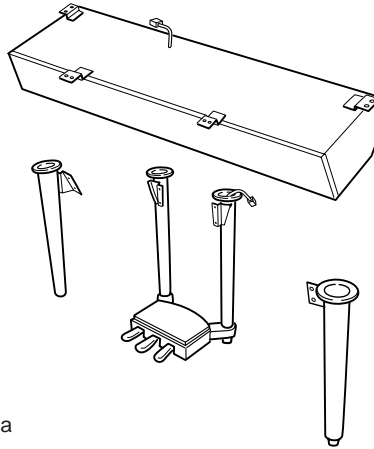

- AC power cord
- Netzkabel
- Cordon d'alimentation
- Cable de alimentación de CA

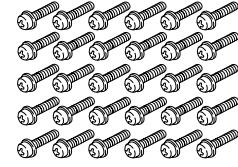

- 5 x 18 mm screws x 30
- Schrauben (5 x 18 mm) x 30
- Vis de 5 x 18 mm x 30
- Tornillos de 5 x 18 mm x 30

CVP-98/96: Assembly

NOTE

- Be careful not to confuse parts, and be sure to install all parts in the correct direction. Please assemble in accordance with the sequence given below.
- Assembly should be carried out by at least two persons.
- Be sure to use the correct screw size, as indicated above. Use of incorrect screws can cause damage.
- Be sure to tighten up all screws upon completing assembly of each unit.
- To disassemble, reverse the assembly sequence given below.

1 Open the box and remove all the parts.

Take out the two cardboard packing cushions and place them on the floor. Then take out main unit and place it on top of the packing cushions. Position the cushions so as to protect the phone jacks on the base of the unit. Remove all parts from the box. Confirm that all parts shown in the illustration above are provided.

CAUTION

- When you lift the pedal box assembly, make sure that you lift by both legs.

2 Carefully lean the main unit against a wall.

To make it easier to install the legs, place a soft blanket or similar material on the floor near a wall, close the Clavinova keyboard cover, place the front panel of the Clavinova (the side with the keyboard) on the blanket and gently lean the unit against the wall — **MAKING SURE THAT IT CAN NOT FALL** — as shown in the illustration.

CAUTION

- Do not lay the main unit upside-down on the floor.

3 Attach the front legs.

Securely attach the two front legs using three screws for each leg (use a Philips “+” screwdriver) as shown in the illustration. Make sure that the screws are firmly tightened.

CVP-98/96: Zusammenbau

NOTIZ

- Achten Sie darauf, die Teile nicht zu verwechseln, und installieren Sie alle Teile in der richtigen Ausrichtung. Gehen Sie beim Zusammenbau bitte in der angegebenen Reihenfolge vor.
- Die Montage sollte von mindestens zwei Personen vorgenommen werden.
- Achten Sie darauf, die richtige Schraubengröße zu verwenden, wie es oben gezeigt ist. Die Verwendung der falschen Schrauben kann zu Schäden führen.
- Achten Sie während der Montage darauf, bei jedem Arbeitsgang alle Schrauben festzuziehen.
- Für die Demontage muß die angegebene Reihenfolge umgekehrt befolgt werden.

1 Den Versandkarton öffnen und alle Teile auspacken.

Nehmen Sie die beiden Kartonformstücke heraus, und legen Sie sie auf den Boden. Nehmen Sie dann die Haupteinheit heraus, und stellen Sie sie auf die abgelegten Formstücke. Positionieren Sie die Formstück dabei so, daß die Kopfhörerbuchsen unten am Instrument nicht beschädigt werden können. Vergewissern Sie sich, daß alle in der obigen Abbildung aufgeführten Teile vollständig vorhanden sind.

VORSICHT

- Halten Sie die Pedalkasten-Baugruppe beim Heben stets an beiden Beinen.

2 Die Haupteinheit vorsichtig an eine Wand lehnen.

Um das Anschrauben der Beine zu erleichtern, breiten Sie eine Decke oder ein weiches Tuch neben der Wand auf dem Boden aus, schließen die Tastaturabdeckung des Clavinova, stellen das Instrument mit der Vorderkante (Seite mit der Tastatur) vorsichtig auf die Decke und lehnen es an die Wand, wie in der Abbildung gezeigt. **VERGEWISSERN SIE SICH, DASS DAS INSTRUMENT NICHT KIPPEN ODER WEGRUTSCHEN KANN!**

VORSICHT

- Legen Sie die Haupteinheit nicht mit der Oberseite nach unten auf den Boden!

3 Die vorderen Beine montieren.

Schrauben Sie die beiden vorderen Beine mit jeweils drei Schrauben (Kreuzschlitzschraubendreher verwenden!) gut am Clavinova fest, wie in der Abbildung gezeigt. Ziehen Sie die Schrauben fest an.

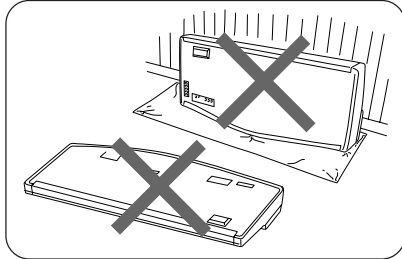
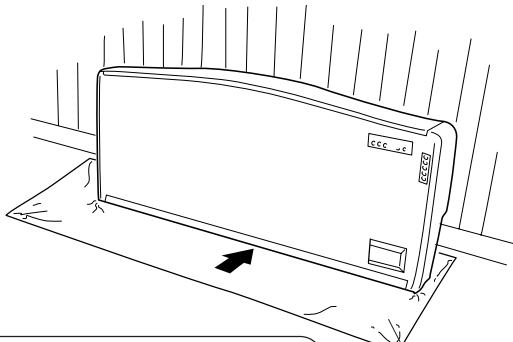
2

- Blanket, etc.
- Decke o. ä.
- Couverture, etc.
- Manta, etc.

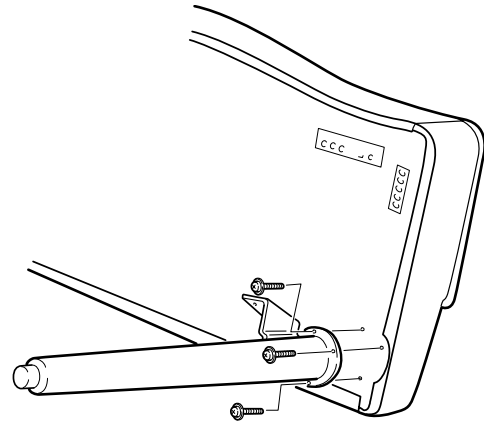
3

- Three screws on each side
- Drei Schrauben pro Bein
- Trois vis de chaque côté
- Tres tornillos en cada lado

CVP-98/96: Montage

NOTE

- Veiller à ne pas mélanger les pièces et à les installer dans le sens correct. Veuillez assembler l'instrument dans l'ordre indiqué ci-dessous.
- La présence de deux personnes minimum est nécessaire pour procéder au montage.
- Toujours utiliser des vis aux dimensions correctes, comme indiqué ci-dessus. L'utilisation de vis aux dimensions incorrectes pourrait en effet endommager l'instrument.
- Resserrer convenablement toutes les vis après le montage de chaque élément.
- Pour démonter le Clavinova, inverser l'ordre des indications données ci-dessous.

1 Ouvrez le carton et retirez toutes les pièces.

Sortez les deux cales d'emballage en carton et placez-les sur le sol. Puis sortez le clavier et placez-le sur ces cales. Positionnez les cales de manière à protéger la prise de casque d'écoute sur la base du clavier. Vérifiez que toutes les pièces qui figurent sur l'illustration sont bien fournies.

PRECAUTION

- Lorsque vous soulevez l'ensemble de boîtier de pédale, soulevez-le par les deux bords.

2 Appuyez le clavier contre un mur en faisant très attention.

Pour faciliter la pose des pieds, placez une couverture épaisse, ou un matériau similaire, sur le plancher à proximité d'un mur. Fermez le protège-clavier et placez la face avant du Clavinova (côté clavier) sur la couverture et appuyez ensuite le clavier contre le mur de la manière illustrée. **ASSUREZ-VOUS QU'IL NE PEUT PAS TOMBER.**

PRECAUTION

- Ne posez pas le clavier à l'envers sur le sol.

3 Posez les pieds avant.

Fixez les deux pieds avant en utilisant trois vis par pied (utilisez un tournevis cruciforme "+") comme illustré. Vérifiez que les vis sont serrées à fond.

CVP-98/96: Montaje

NOTA

- Observe cuidado para no confundir las piezas, y asegúrese de montar todas ellas en el sentido correcto. Proceda al montaje en el orden indicado a continuación.
- El montaje deberá realizarse al menos por dos personas.
- Procure utilizar los tornillos del tamaño adecuado, según se indica arriba. El empleo de tornillos inadecuados puede ocasionar daños en el instrumento.
- Asegúrese de apretar bien todos los tornillos después de montar cada unidad.
- Para desmontar las unidades, invierta la secuencia de montaje facilitada a continuación.

1 Abra la caja y extraiga todas las partes.

Saque los dos amortiguadores de embalaje de la caja de cartón y póngalos en el suelo. Entonces, saque la unidad principal y póngala encima de los amortiguadores de embalaje. Coloque los amortiguadores de modo que protejan las tomas de auriculares de la base de la unidad. Extraiga todas las partes de la caja. Confirme que están incluidas todas las partes que se muestran en la ilustración de arriba.

CUIDADO

- Cuando levante el conjunto de la caja de pedales, asegúrese de que levanta ambas patas.

2 Incline con cuidado la unidad principal contra una pared.

Para facilitar la instalación de las patas, coloque una manta blanda o un material semejante sobre el piso cerca de una pared, cierre la cubierta del teclado de la Clavinova, coloque el panel frontal de la Clavinova (el lado con el teclado) sobre la manta e incline con cuidado la unidad contra la pared — **ASEGURÁNDOSE DE QUE NO PUEDA CAERSE** — como se muestra en la ilustración.

CUIDADO

- No ponga la unidad principal al revés sobre el suelo.

3 Coloque las patas delanteras.

Fije las dos patas delanteras usando tres tornillos para cada pata (emplee un destornillador de cabeza en cruz "+") como se muestra en la ilustración. Asegúrese de que los tornillos queden bien apretados.

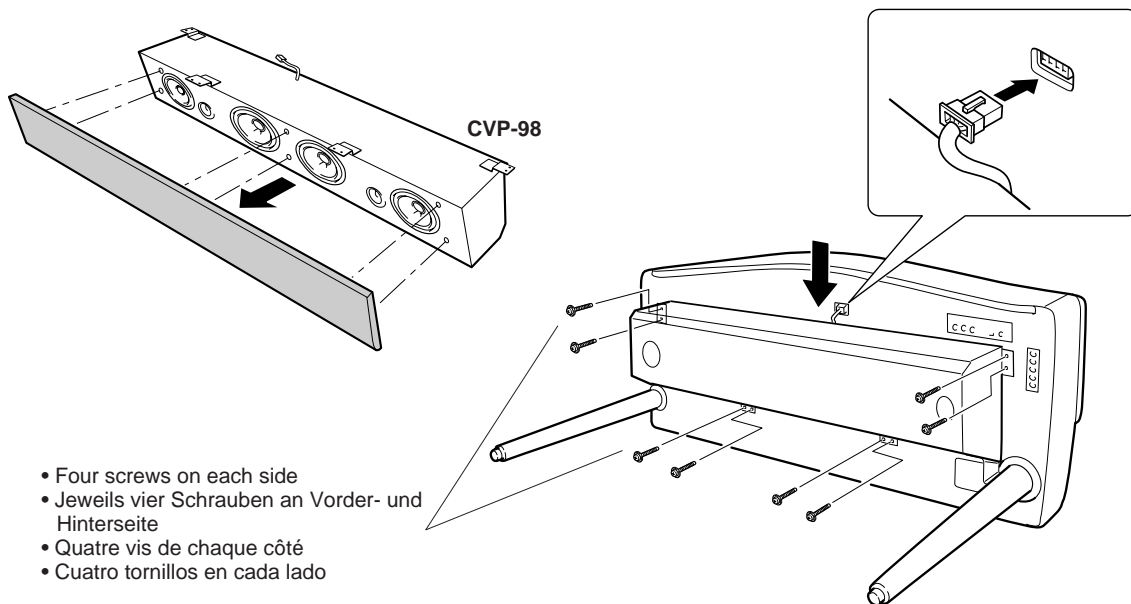
4

- Four screws on each side
- Jeweils vier Schrauben an Vorder- und Hinterseite
- Quatre vis de chaque côté
- Cuatro tornillos en cada lado

4 Attach the speaker box.

Remove the speaker box cover (attached to the speaker box in 6 places with plastic plugs) from the speaker box. Gently rest the speaker box onto the corresponding brackets on the front legs. (Be careful not to touch the speakers when handling the speaker box. Damage may result.)

Make sure the speaker cord is extending out from the rear of the speaker box. Secure the speaker box to the main keyboard unit using four screws on each side. Insert the speaker cord connector into the corresponding socket on the main keyboard unit, making sure that the protruding clip on the connector is facing up.

5 Attach the pedal box assembly.

Before attaching the rear leg and pedal box assembly, insert the pedal cord plug extending from the rear leg into the corresponding socket in the main unit. Make sure that the protruding clip on the connector is facing up. Put the excess cord into the leg and loosely secure the rear leg and pedal assembly using 6 screws for each leg (four screws per leg and two screws on each leg bracket). Once the rear leg and pedal assembly has been loosely attached, go back and tighten all 12 of the screws on the rear leg and pedal assembly.

4 Den Lautsprecherkasten montieren.

Nehmen Sie die Bespannung (wird an 6 Punkten von Plastikdübeln gehalten) vom Lautsprecherkasten ab. Setzen Sie den Lautsprecherkasten vorsichtig auf die Halterungen an den vorderen Beinen. (Vermeiden Sie dabei unbedingt ein Berühren der Lautsprechermembrane.) Das Lautsprecherkabel muß an der Hinterseite (d.h. oben) aus dem Lautsprecherkasten ragen. Schrauben Sie den Lautsprecherkasten mit jeweils vier Schrauben an Vorder- und Hinterseite an der Haupteinheit fest. Schließen Sie dann das Lautsprecherkabel an die Buchse der Haupteinheit an (die Führungsnase am Stecker muß dabei nach oben weisen).

5 Die Pedalkastengruppe montieren.

Bevor Sie die Pedalkastengruppe mit den hinteren Beinen montieren, schließen Sie das aus dem einen Bein ragende Pedalkabel an die entsprechende Buchse der Haupteinheit an (die Führungsnase am Stecker muß dabei nach oben weisen). Schieben Sie überlanges Kabel wieder in das Bein zurück, und schrauben Sie dann die hinteren Beine mit der Pedalkastengruppe provisorisch mit 6 Schrauben pro Bein (jeweils 4 für das Bein selbst und 2 für die Halterung am Bein) an die Haupteinheit. Nachdem Sie die hinteren Beine mit dem Pedalkasten fixiert haben, ziehen Sie die 12 Schrauben fest an.

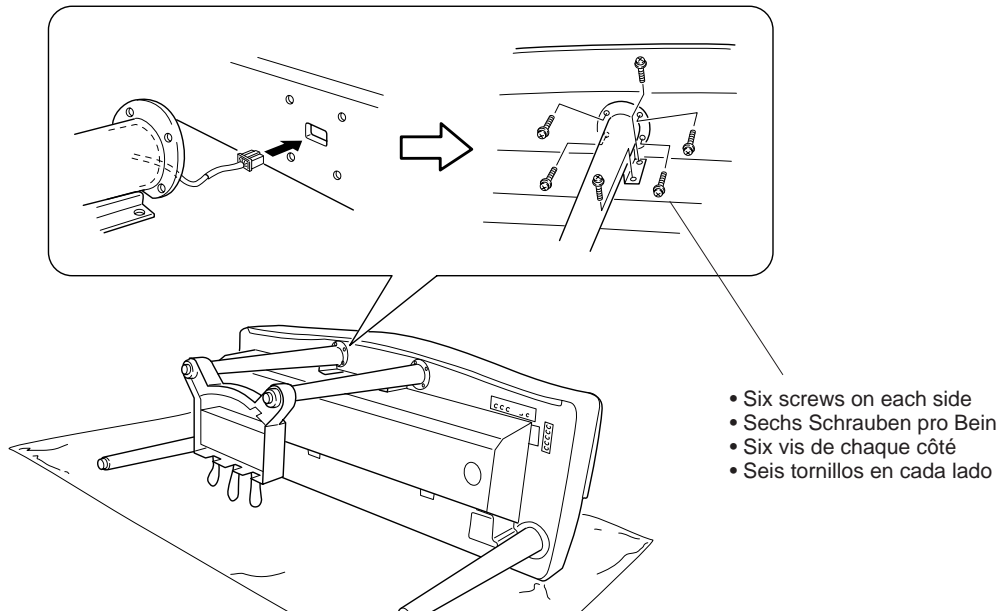
5**4 Posez la boîte des haut-parleurs.**

Retirez le couvercle du coffret du haut-parleur (fixé au coffret du haut-parleur en six endroits avec des chevilles en plastique) au coffret du haut-parleur. Poser la boîte des haut-parleurs sur les ferrures correspondantes des pieds avant. (Faites bien attention de ne pas toucher les haut-parleurs lorsque vous manipulez la boîte. Cela pourrait les endommager.) Assurez-vous que le cordon des haut-parleurs sort de l'arrière de la boîte. Fixez la boîte sur le clavier en utilisant quatre vis de chaque côté. Branchez le connecteur du cordon des haut-parleurs à la prise correspondante du clavier en veillant à ce que la partie en saillie du connecteur soit orientée vers le haut.

5 Fixez le pédalier.

Avant de poser l'ensemble pied arrière/pédalier, branchez le connecteur du cordon de pédalier sortant du pied arrière à la prise correspondante du clavier. Veillez à ce que la partie en saillie du connecteur soit dirigée vers le haut. Placez le cordon en excès dans le pied et montez sans trop serrer l'ensemble pied arrière/pédalier en utilisant six vis pour chaque pied (4 vis par pied et 2 vis pour chaque ferrure de fixation). Une fois que l'ensemble pied arrière/pédalier est provisoirement monté, serrez à fond ses 12 vis.

4 Monte la caja de altavoces.

Extraiga la cubierta de la caja de altavoces (unida a la caja de altavoces en 6 lugares con tapones de plástico) desde la caja de altavoces. Apoye con cuidado la caja de altavoces en las ménsulas correspondientes de las patas delanteras. (Tenga cuidado en no tocar los altavoces cuando se manipule la caja de altavoces. Podrían ocasionarse daños.) Asegúrese de que el cable de altavoz se extienda desde la parte posterior de la caja del altavoz. Fije la caja de altavoces a la unidad del teclado principal usando cuatro tornillos en cada lado. Inserte el conector del cable de altavoces en el receptáculo correspondiente de la unidad del teclado principal, asegurándose de que el retenedor que sobresale del conector queda orientado hacia arriba.

5 Monte el conjunto de la caja de pedales

Antes de montar la pata trasera y el conjunto de la caja de pedales, inserte la clavija del cables de los pedales, que se extiende desde la pata trasera al receptáculo correspondiente de la unidad principal. Asegúrese de que el retenedor que sobresale del conector queda orientado hacia arriba. Ponga el cable sobrante en la pata y fije sin apretar la pata trasera y el conjunto de pedales usando 6 tornillos para cada pata (cuatro tornillos por pata y dos tornillos en la ménsula de cada pata). Después de haber montado sin apretar la pata trasera y el conjunto de pedales, apriete los 12 tornillos de la tapa trasera y el conjunto de pedales.

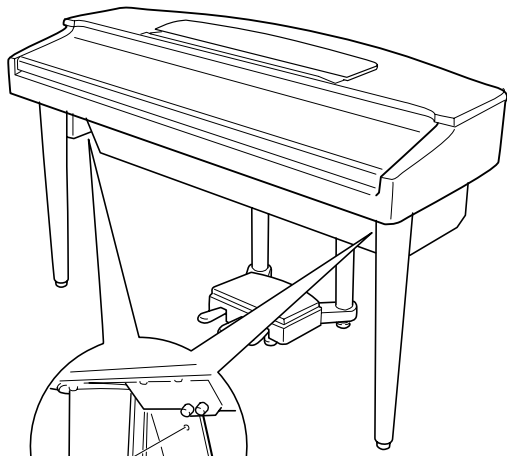

- Two screws on each side
- Jeweils zwei Schrauben links und rechts
- Deux vis de chaque côté
- Dos tornillos en cada lado

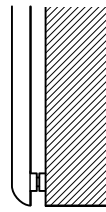
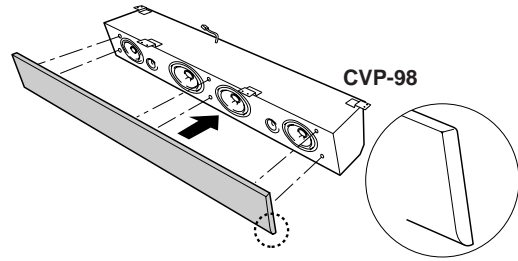

- Make sure the plugs are fully inserted and there is no space left around the plugs and holes.
- Vergewissern Sie sich, daß die Dübel bis zum Anschlag in den Löchern sitzen und kein Zwischenraum verbleibt.
- Vérifiez que les chevilles sont complètement insérées et qu'il n'y a pas d'espace entre la cheville et le matériau.
- Asegúrese de que los tapones estén insertados a fondo y que no quede espacio en torno a los tapones y los orificios.

6 Secure the speaker box.

Stand the main unit on its legs and securely attach the speaker box to the bracket on the front legs using two screws for each bracket. If it is impossible to align the bracket holes with the speaker box holes, slightly loosen the three screws on each of the front legs, and secure the speaker box. After the speaker box is firmly attached, retighten the screws on the front legs firmly. Put the speaker box cover back in place with the rounded edge of the cover at the bottom, insert the plugs on the cover into their corresponding holes on the speaker box.



- When attaching the cover, make sure you push where the plugs are. The speaker cover is made of a soft material so pushing in a place where there are no plugs may cause damage to the speaker.

7 Voltage Selector

Before connecting the AC power cord, check the setting of the voltage selector which is provided in some areas. To set the selector for 110V, 127V, 220V or 240V main voltages, use a “minus” screwdriver to rotate the selector dial so that the correct voltage for your region appears next to the pointer on the panel. The voltage selector is set at 240V when the unit is initially shipped. After the proper voltage has been selected connect the AC power cord.

8 Set the adjuster.

For stability, an adjuster is provided on the bottom of the pedal box. Rotate the adjuster until it comes in firm contact with the floor surface. The adjuster ensures stable pedal operation and facilitates pedal effect control. If the adjuster is not in firm contact with the floor surface, distorted sound may result.

6 Den Lautsprecherkasten an den vorderen Beinen sichern.

Stellen Sie das Instrument nun auf seine Beine, um den Lautsprecherkasten zusätzlich mit jeweils zwei Schrauben an die Halterungen der beiden vorderen Beine zu schrauben. Sollten die Schraubenbohrungen nicht zur Deckung gebracht werden können, lösen Sie die Befestigungsschrauben der vorderen Beine ein wenig. Nach Festschrauben des Lautsprecherkastens dürfen Sie jedoch nicht vergessen, die Schrauben der Beine wieder fest anzuziehen. Bringen Sie nun die Bespannung mit der abgerundeten Kante nach unten weisend wieder am Lautsprecherkasten an, indem Sie die Plastikdübel in die entsprechenden Löcher stecken.



- Drücken Sie beim Anbringen der Bespannung nur auf die Stellen mit den Plastikdübeln. Die Bespannung besteht aus sehr weichem Material, so daß der Lautsprecher beim Drücken auf eine andere Stelle leicht beschädigt wird.

7 Den Spannungswähler einstellen.

Bevor Sie nun das Netzkabel anschließen, müssen Sie den Spannungswähler (falls vorhanden) auf die örtliche Netzspannung einstellen. Zum Verstellen drehen Sie den Spannungswähler mit einem Schlitzschraubendreher, bis der richtige Spannungswert (110, 127, 220 oder 240) an der Pfeilmarkierung steht. Bei der Auslieferung werden alle Instrumente mit Spannungswähler auf “240” voreingestellt.

Nachdem Sie den Spannungswähler richtig eingestellt haben, können Sie nun das Netzkabel anschließen.

8 Die Pedalstützen einstellen.

Zur Stabilisierung ist an der Unterseite des Pedalkastens ein Höhenversteller vorgesehen. Schrauben Sie den Höhenversteller heraus, bis er fest auf dem Fußboden steht. Der Höhenversteller sorgt für stabile Pedalbetätigung und ermöglicht eine präzise Regelung des Betätigungshubs. Wenn er nicht fest auf dem Boden steht, können beim Treten der Pedale Klangverzerrungen auftreten.

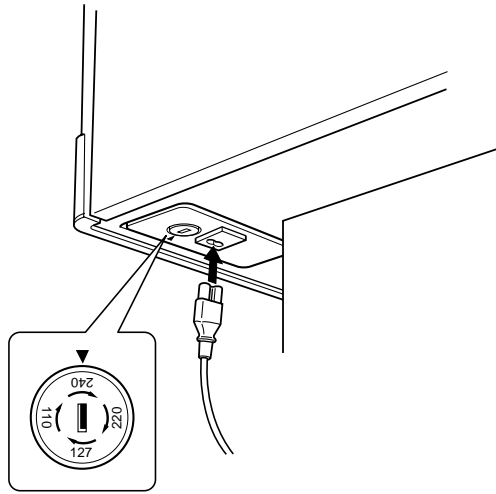
7

- A voltage selector is provided in some areas.
- Spannungswähler (nur in bestimmten Verkaufsgebieten)
- Un sélecteur de tension est prévu pour certaines régions
- El selector de tensión está provisto para ciertos destinos.

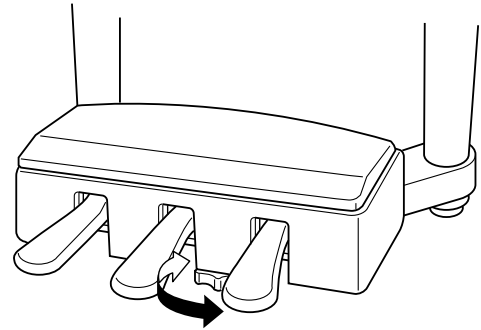
8

6 Fixer la boîte des haut-parleurs.

Mettez le clavier sur ses pieds et fixez la boîte des haut-parleurs à la ferrure de fixation des pieds avant à l'aide de deux vis par ferrure. S'il est impossible d'aligner les trous des ferrures de fixation sur les trous de la boîte des haut-parleurs, desserrez légèrement les trois vis de chaque pied avant, alignez les trous et fixez la boîte des haut-parleurs. Remettez le couvercle du coffret du haut-parleur à sa place, avec le bord arrondi de ce couvercle en bas, insérez les chevilles dans le couvercle et dans leurs trous correspondant sur le coffret du haut-parleur.



- En montant le couvercle, appuyez bien à l'endroit où se trouvent les chevilles. Le couvercle du haut-parleur est constitué d'une matière souple et le fait d'appuyer à un endroit où il n'y a pas de cheville pourrait endommager le haut-parleur.

7 Sélecteur de tension

Avant de connecter le cordon d'alimentation, vérifiez le réglage du sélecteur de tension qui est prévu pour certaines régions. Pour régler le sélecteur sur 110 V, 127 V, 220 V ou 240 V, utilisez un tournevis à lame plate pour tourner le cadran du sélecteur afin de mettre l'indication correspondant à la tension de votre région vis à vis du repère triangulaire situé sur le panneau. Le sélecteur de tension est réglé sur 240 V au départ d'usine.

Une fois que vous avez réglé le sélecteur de tension, connectez le cordon d'alimentation.

8 Réglez la hauteur du pédalier.

Pour assurer la stabilité du pédalier, un dispositif de réglage a été prévu à sa partie inférieure. Tournez ce dispositif jusqu'à ce qu'il soit en contact ferme avec la surface du sol. Ce dispositif assure la stabilité du pédalier lors de son utilisation et facilite la commande au pied des effets. Si ce dispositif n'est pas en contact ferme avec le sol, il pourra se produire une distorsion du son.

6 Fije la caja de altavoces

Apye la unidad principal sobre sus patas y monte con seguridad la caja de altavoces en la ménsula de las patas delanteras usando dos tornillos para cada ménsula. Si es imposible alinear los orificios de las ménsulas con los orificios de la caja de altavoces, afloje un poco los tres tornillos de cada una de las patas delanteras, alinee los orificios, y fije la caja de altavoces. Después de haber montado firmemente la caja de altavoces, vuelva a apretar bien los tornillos de las patas delanteras. Vuelva a poner la cubierta de la caja de altavoces en su lugar con el borde redondeado de la cubierta en la parte inferior, e inserte los tapones de la cubierta en sus orificios correspondientes de la caja de altavoces.



- Cuando monte la cubierta, asegúrese de empujar por la parte de los tapones. La cubierta de altavoces está hecha de material blando, por lo que si se empuja por una parte que no hay tapones, pueden dañarse los altavoces.

7 Selector de tensión

Antes de conectar el cable de alimentación de CA, compruebe el ajuste del selector de tensión que se incorpora para ciertos destinos. Para ajustar el selector a 110V, 127V, 220V ó 240V de la red de alimentación, emplee un destornillador de cabeza recta "-" para girar el selector de modo que la tensión correcta de su zona aparezca al lado del indicador del panel. El selector de tensión se ajusta a 240V cuando la unidad sale de fábrica.

Después de haber seleccionado la tensión correcta, enchufe el cable de alimentación.

8 Ajuste los reguladores

Para la estabilidad del aparato, se proporciona un ajustador en la parte inferior de la caja de pedales. Gire el ajustador hasta que contacte firmemente con el suelo. El ajustador asegura una operación estable de los pedales y facilita el control del efecto de los pedales. Si el ajustador no contacta firmemente con el suelo, puede resultar en sonido distorsionado.

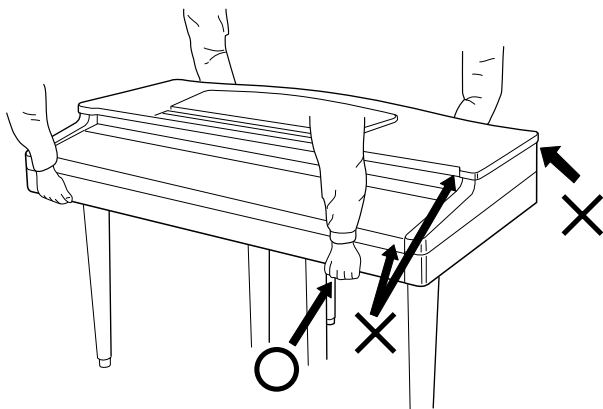

⚠ CAUTION

- When moving the instrument after assembly, always hold the lower surface of the main unit, NEVER the top portion or keyboard cover. Improper handling can result in damage to the instrument or personal injury.

⚠ VORSICHT

- Fassen Sie zum Umstellen des Instruments nach dem Zusammenbau stets unter das Gehäuse; heben Sie es NIE-MALS am oberen Teil des Gehäuses oder am Tastaturdeckel. Bei Nichtbeachtung dieses Punkts kann das Instrument beschädigt und im Extremfall eine Verletzung hervorgerufen werden.

⚠ PRECAUTION

- Pour déplacer l'instrument après le montage, toujours tenir l'instrument par la surface inférieure, JAMAIS par sa partie supérieure ou par le protège-clavier. Une mauvaise manipulation peut provoquer des dommages ou des blessures.

⚠ CUIDADO

- Cuando mueva el instrumento después del montaje, sostenga siempre la superficie inferior de la unidad principal, y NUNCA la parte superior de la cubierta del teclado. La manipulación indebida puede causar daños en el instrumento o personales.

■ After completing the assembly, please check the following.

- Are there any parts left over?
 - Review the assembly procedure and correct any errors.
- Is the Clavinova clear of doors and other movable fixtures?
 - Move the Clavinova to an appropriate location.
- Does the Clavinova make a rattling noise when you shake it?
 - Tighten all screws.
- Does the pedal box rattle or give way when you step on the pedals?
 - Turn the adjuster so that it is set firmly against the floor.
- Are the pedal and power cords inserted securely into the sockets?
 - Check the connection.
- If the main unit creaks or is otherwise unsteady when you play on the keyboard, refer to the assembly diagrams and retighten all screws.

■ Lorsque le montage est terminé, veuillez mener à bien les vérifications suivantes.

- Reste-t-il des pièces non utilisées?
 - Passer en revue la procédure de montage et corriger toute erreur éventuelle.
- Le Clavinova est-il placé à l'écart des portes et de toute autre structure mobile?
 - Déplacer le Clavinova vers un emplacement approprié.
- Lorsque vous secouez quelque peu le Clavinova, entendez-vous un cliquetis?
 - Serrer convenablement toutes les vis.
- Le pédalier fait-il du bruit ou s'écarte-t-il lorsque vous appuyez sur les pédales?
 - Tourner le stabilisateur de sorte que le Clavinova repose fermement sur le sol.
- Les cordons des pédales et d'alimentation sont-ils bien enfoncés dans les prises?
 - Vérifier toutes les connexions.
- Si la partie principale de l'appareil craque ou est instable lorsque vous jouez sur le clavier, consulter les diagrammes de montage et resserrer toutes les vis.

■ Wenn der Zusammenbau beendet ist, prüfen Sie bitte folgende Dinge:

- Sind Teile übrig geblieben?
 - Gehen Sie den Vorgang des Zusammenbaus noch einmal durch und korrigieren Sie eventuelle Fehler.
- Befindet sich das Clavinova weit genug von Türen und anderen beweglichen Vorrichtungen entfernt?
 - Bewegen Sie das Clavinova an einen entsprechend sicheren Ort.
- Macht das Clavinova Klappergeräusche, wenn Sie es schütteln?
 - Ziehen Sie alle Schrauben fest.
- Klappert der Pedalkasten oder gibt er nach, wenn Sie das Pedal treten?
 - Drehen Sie den Höhenversteller, bis er fest auf dem Fußboden steht.
- Sind Pedal- und Netzkabel richtig an den Buchsen angeschlossen?
 - Prüfen Sie die Verbindung.
- Wenn die Haupteinheit knarrt oder beim Spielen wackelt, betrachten Sie die Abbildungen und ziehen Sie alle Schrauben noch einmal nach.

■ Cuando haya concluido el montaje, compruebe los siguientes puntos:

- ¿Ha quedado alguna pieza sin instalar?
 - Revise el procedimiento de montaje y corrija cualquier error que se haya podido cometer.
- ¿Está el Clavinova alejado del recorrido de puertas y muebles?
 - Traslade el Clavinova a una posición adecuada.
- ¿Suena algún ruido de holgura cuando se mueve el Clavinova?
 - Apriete con firmeza todos los tornillos.
- ¿Vibra o cede la caja de pedales cuando se pisan los pedales?
 - Gire el estabilizador hasta que apoye firmemente sobre el suelo.
- ¿Están perfectamente insertados los cables de pedal y alimentación en los conectores?
 - Revise las conexiones.
- Si la unidad principal cruje o presenta algún signo de inestabilidad cuando se toca el teclado, consulte los esquemas de montaje y vuelva a apretar todos los tornillos.

