



CS-80 POLYPHONIC SYNTHESIZER

INSTRUCTION MANUAL

 **YAMAHA**

HOW TO USE THIS MANUAL

This instruction manual is probably different from any synthesizer manual you have previously read. The controls and functions are explained in terms that should be comprehensible to non-technical and technically oriented players alike. The CS-80 is a unique step forward in synthesizer technology, an advanced and very playable instrument. This instruction manual complements the CS-80, and will also serve as a valuable reference book for understanding many other synthesizers.

All CS-80 controls referenced in the manual are followed by a number in brackets, like this: the VOLUME control [2]. The numbers refer to the callouts on the photograph inside the front cover. Consult the INDEX on page 1 to find other pages where the same control is discussed.

Those who are already experienced with synthesizers may wish to review the control functions as outlined in Section IV. A more detailed and less technical explanation is provided in Sections II and III.

When portions of the control panels are shown in examples, all controls not shown in the example should be set at the nominal positions indicated by the inside cover photo (unless otherwise suggested by the accompanying text).

Try the example settings shown, and experiment as you read the text. Feel free to use your own music, and adjust your playing style to suit the nature of the patch you have selected.



- | | | | |
|--|-----------------------------------|----------------------------------|--|
| [1] AC POWER switch | [12] TOUCH RESPONSE | [24] Sawtooth wave ON/OFF | [36] Sine Wave |
| [2] Main VOLUME | [13] SUSTAIN | [25] White NOISE | [37] A (Attack Time) |
| [3] TONE SELECTORS | [14] PORTAMENTO/GLISSANDO | [26] HPF filter cutoff | [38] D (Decay Time) |
| [4] MIX I-II | [15] TREMOLO/CHORUS | [27] RES _H filter "Q" | [39] S (Sustain Level) |
| [5] FEET I-II | [16] RING MODULATOR | [28] LPF filter cutoff | [40] R (Release Time) |
| [6] DETUNE CH II | [17] FOOT PEDAL SELECTOR | [29] RES _L filter "Q" | [41] VCA LEVEL |
| [7] Overall BRILLIANCE | [18] PITCH (tuning) | [30] IL (Initial Level) | [42] INITIAL-TOUCH BRILLIANCE |
| [8] Overall RESONANCE | [19] Ribbon (glide) controller | [31] AL (Attack Level) | [43] INITIAL-TOUCH LEVEL |
| [9] KEYBOARD CONTROL-
BRILLIANCE LOW & HIGH | [20] Pulse Width Modulation SPEED | [32] A (Attack Time) | [44] AFTER-TOUCH BRILLIANCE |
| [10] KEYBOARD CONTROL-
LEVEL LOW & HIGH | [21] PWM depth | [33] D (Decay Time) | [45] AFTER-TOUCH LEVEL |
| [11] SUB OSCILLATOR | [22] PW duty cycle | [34] R (Release Time) | [46] MEMORY PANEL
(beneath Block Diagram) |
| | [23] Square wave ON/OFF | [35] VCF LEVEL | |

QUICK SETUP INSTRUCTIONS

1. Physically assemble the legs (see instructions on page 2) or set the CS-80 atop a sturdy surface, allowing space for air to circulate through the top and bottom cooling vent panels.
2. Plug in the FOOT SWITCH and FOOT PEDAL (CONTROLLER) at the rear panel; **be sure to insert the plugs in the proper jacks.**
3. Using guitar cord(s), connect the CS-80 Rear-Panel Output Jack(s) to a professional, wide-range speaker/amplifier unit. LEFT and RIGHT may be used for 2-channel systems, or GENERAL (mono) for single-channel systems, such as guitar amps. (Hi-Fi music systems are **not** recommended for this application.)
Alternately, connect a pair of stereo headphones to the PHONE JACK below the right side of the keyboard.
4. Open the storage panel below the synthesizer, remove the power cord, and plug it in to a suitable AC power main.
5. Set the rear-panel HIGH/LOW switch to LOW, turn on the CS-80 power, and set all controls at nominal. If the volume is too low, even with the VOLUME control all the way up and the FOOT PEDAL flat (maximum level), then switch HIGH/LOW to HIGH.
6. Try various preset patches by touching different TONE SELECTOR buttons [3] and moving the MIX I—II lever [4] up or down to point at the row corresponding to the selected preset. Adjust BRILLIANCE [7] as you do this. See pages 24 through 30 for additional panel-programmed patches.

IMPORTANT INFORMATION

1. Always allow space below and above the synthesizer for air to circulate through the vent panels. This is essential for proper cooling of the circuitry. **If the vents are blocked, tuning instability and component failure may occur.**
2. Always plug the FOOT SWITCH and FOOT PEDAL (CONTROLLER) into the proper jacks. **THE SYNTHESIZER WILL NOT WORK AND MAY REQUIRE REPAIR.**
3. Avoid exposing the synthesizer to direct sunlight or very high humidity environments.
4. Clean the keys and plastic parts with Yamaha Key Cleaner creme polish, or with a moistened soft cloth. Never use abrasives, cleansers, waxes or solvents, which may dull the keys or chemically attack the finish.
5. **Leave internal adjustments to qualified Yamaha service personnel. If you open up the unit and reset any trimmers, the unit may require a complete re-voicing by Yamaha.**
6. The **EXT IN** jack is designed for audio, line-level signals. Never connect it to an AC power line, or to a speaker-level output. Also, **do not connect any CS-80 output to the EXT IN jack**, as this may cause feedback and possible damage to your equipment.
7. The CS-80 weighs approximately 100kg (220 lbs.). When setting it up or transporting it, at least two people should do the lifting.
8. While the CS-80 is constructed with an integral case of sturdy plywood and metal-reinforced corners, we recommend the use of an additional travel case for cartage, preferably built to ATA-300 specifications. (See page 48.)

INTRODUCTION

The CS-80 is easy to play. While it is a high-technology musical instrument, you don't have to know about electronics to understand how to use the CS-80. We do recommend, however, that you read this manual thoroughly, and periodically refer back to it as you learn the instrument. If you're in a hurry, check the Quick Setup Instructions on this page.

The Yamaha CS-80 is a unique 8-note polyphonic synthesizer, one which places the entire realm of musical expression at your fingertips. The CS-80 is a true musical instrument, not merely a "special effects" tool. The sounds are infinitely variable, and, because the keyboard is both velocity and pressure sensitive, you have true dynamic control over your music.

The CS-80 will give you an incredible variety of electronic sounds, but it goes further than that. Having a CS-80 is like having a symphony orchestra to choose from. Largely due to touch sensitivity (keyboard dynamics), Yamaha has overcome a traditional challenge for synthesizers, namely, the difficulty in creating the sound of an acoustic instrument. For example, if you've ever tried to create a "violin" on the keyboard of most synthesizers, you probably found the result too "electronic." While you may have achieved a good basic violin sound, when you played it, there was something missing . . . but what?

Ask a great violinist to play the note "G" 8 consecutive times (not an open string). Request that he make them **absolutely** identical in pitch, timbre, volume and every other possible variable. You'll discover that he **cannot do it** . . . fortunately. Much of the charm of a musical performance is that it is not "textbook perfect," and this is why your well-programmed synthesized violin did not sound "right" to you. However, your CS-80 is another story.

Touch response makes all the difference. You can set up a "violin" so that the way you press a key changes the vibrato, timbre, pitch, volume, brilliance . . . the whole essence of the sound. With this kind of expressive capability you too may not exactly duplicate 8 consecutive notes. However, the sound you do achieve will be much more realistic and musical than has ever before been practical with an electronic musical instrument.

The CS-80 is the first of a whole new generation of **performer-oriented** electronic musical instruments. Only Yamaha, the world's leading manufacturer of fine musical instruments and high-quality sound equipment, could have built it.

INSIDE COVER PHOTO ::	PANEL LABEL OR FUNCTION	SEE PAGE
[1]	AC POWER switch	6, 39
[2]	Main VOLUME	6, 38
[3]	TONE SELECTORS	7, 37
[4]	MIX I-II	7, 37
[5]	FEET I-II	8, 37
[6]	DETUNE CH II	8, 37
[7]	Overall BRILLIANCE	8, 38
[8]	Overall RESONANCE	8, 38
[9]	KEYBOARD CONTROL— BRILLIANCE LOW & HIGH	9, 38
[10]	KEYBOARD CONTROL— LEVEL LOW & HIGH	9, 38
[11]	SUB OSCILLATOR	8, 37
[12]	TOUCH RESPONSE	10, 38
[13]	SUSTAIN	11, 39
[14]	PORTAMENTO/GLISSANDO	12, 39
[15]	TREMOLLO/CHORUS	13, 39
[16]	RING MODULATOR	13, 37
[17]	FOOT PEDAL SELECTOR	14, 39
[18]	PITCH (tuning)	14, 37
[19]	Ribbon (glide) controller	14
(PROGRAMMABLE PANELS)		
VCO Section		
[20]	Pulse Width Modulation SPEED	15, 32
[21]	PWM depth	15, 32
[22]	PW duty cycle	14, 32
[23]	Square wave ON/OFF	14, 32
[24]	Sawtooth wave ON/OFF	15, 32
[25]	White NOISE	18, 32
VCF Section		
[26]	HPF filter cutoff	16, 17, 33
[27]	RES _H "Q"	16, 17, 33
[28]	LPF filter cutoff	16, 17, 33
[29]	RES _L "Q"	16, 17, 33
[30]	IL (Initial Level)	20-23, 33
[31]	AL (Attack Level)	20-23, 33
[32]	A (Attack Time)	20-23, 33
[33]	D (Decay Time)	20-23, 34
[34]	R (Release Time)	20-23, 34

VCA Section

[35]	VCF LEVEL	20, 35
[36]	Sine Wave	15, 16, 20, 35
[37]	A (Attack Time)	18, 19, 35
[38]	D (Decay Time)	18, 19, 35
[39]	S (Sustain Level)	18, 19, 35
[40]	R (Release Time)	18, 19, 35
[41]	VCA LEVEL	18, 35
Touch Response Section		
[42]	INITIAL-TOUCH BRILLIANCE	23, 36
[43]	INITIAL-TOUCH LEVEL	23, 36
[44]	AFTER-TOUCH BRILLIANCE	23, 36
[45]	AFTER-TOUCH LEVEL	23, 36
[46]	MEMORY PANEL (beneath Block Diagram)	15, 23, 36
<i>(Items Not Visible in Cover Photo)</i>		
	HEADPHONE jack	5
	EXTERNAL INPUT jack & LEVEL control	4
	OUTPUT jacks & HIGH/LOW level switch	4
	FOOT SWITCH PEDAL	3, 4, 11, 12, 14
	FOOT CONTROLLER PEDAL	3, 4

SECTION I: GENERAL INFORMATION & SETUP

How To Use This Manual	Cover
Color Photo for Feature Identification and Nominal Control Settings	Cover
Quick Setup Instructions	Cover
Important Information	Cover
Introduction	Cover
Leg Assembly	2
Connections	4

SECTION II: DETAILED, NON-TECHNICAL CONTROL DESCRIPTIONS (Except Programming)

General Discussion and Notes	6
Controls and Switches	6

SECTION III: DESCRIPTION OF PROGRAMMABLE PANELS, MEMORY, HOW TO PROGRAM, & SUGGESTED PATCHES

What the (Programmable) Panel Controls Do	15
Memories	23
How to Use Programming to Get a Sound	24
Using the Programmable Panels to Duplicate the Preset Patches	28

SECTION IV: TECHNICAL CONTROL DESCRIPTIONS

Overall Picture	31
The Programmable Panels	31
Other Selectors & Sound Modifiers	37

SECTION V: UNDERSTANDING SYNTHESIZERS

General Information	40
How The Synthesizer Works	41

SECTION VI: APPENDIX

Where's The Sound? (Troubleshooting)	46
Tips on Recording	46
Tips on Live Performance	46
Tips on Auxiliary Signal Processing	47
Direct Box	47
Travel Case	48
Specifications	49
Blank Programming Diagrams	50

LEG ASSEMBLY

1. Unzip and open the carrying case. If you wish to move the CS-80 before you set it up, you need not carry it. Remove the casters from the case and insert them in the four holes at the corners of the CS-80 rear panel.
2. Hold the left leg assembly so the two thumbscrews on its mounting flange line up with the threaded sockets under the CS-80, as shown. Tighten the screws sufficiently to hold the leg in place, but do not tighten securely. Swing the upper leg brace so it is parallel with the bottom of the synthesizer, and leave the lower leg brace pivoted out of the way.
3. Remove the thumbscrew from the end of the upper leg brace on the right leg assembly, and set the screw aside temporarily: **BE SURE TO SAVE THE THUMBSCREW.** First slide the right upper leg brace into the end of the left upper leg brace. Then align the two mounting flange thumbscrews over their sockets and tighten the screws partially.
4. Swing the right lower leg brace over the point where the two upper leg braces join, aligning the holes as shown.
5. Swing the left lower leg brace over the junction of the other leg braces, also keeping the holes aligned.
6. Insert the thumbscrew through the two lower braces and tighten it firmly into the upper braces.
7. Tighten the four thumb screws that firmly secure the left and right leg flanges.

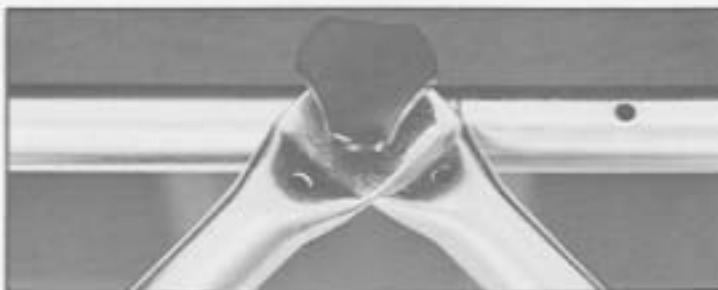
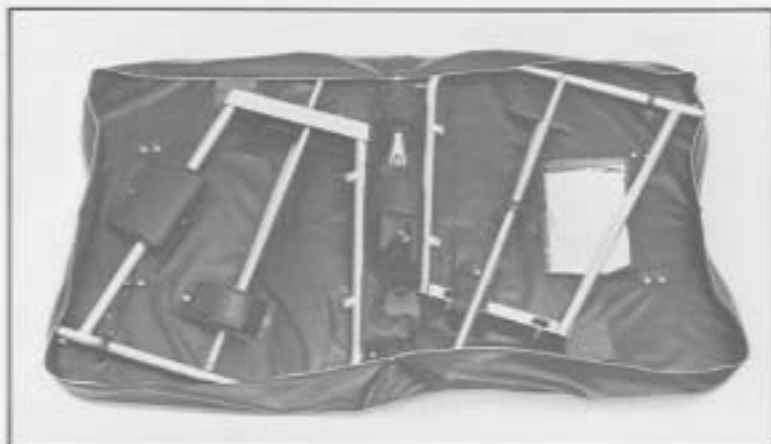

8. Flip up the latch on the power cord storage compartment, and remove the power cord.
9. Close the compartment cover, routing the cord through the notched corner so the cover does not pinch the cord.
10. With one person lifting each end, lift the unit up and stand it on its legs. The leveling screws on the front of each leg may be adjusted to steady the synthesizer, if necessary.*
11. Remove the Foot Switch and Foot Pedal Controller from the carrying case and place them below the synthesizer. To keep the cables out of your way, slip them into the clips on the right leg. (As stated in "Connections," be sure you plug the two cables into the correct jacks; the Pedal's three-circuit phone plug goes to the FOOT CONTROLLER jack.)
12. To keep the AC cord out of your way, slip it into the clips on the left leg. (Separating the power cord from audio cables is always a good idea since it avoids hum.)
13. Remove the casters, unlatch the cover, open the cover and lift it off as the half-round hinges disengage. If you wish, remove the music stand from the cover and insert it in the two slotted fittings atop the synthesizer (on the vent panel).

* CAUTION: The CS-80 weighs 100kg (220 lbs.). For safety, please have someone help you lift it.

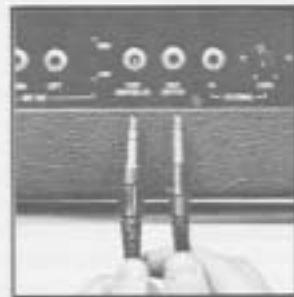

4 NOTE: See Section VI for information on direct boxes, balanced lines, etc.

AC Power & Grounding

Plug the power cord into 50 or 60Hz AC outlet.*
When using the CS-80 with a standard guitar amplifier, it's a good idea to plug the AC cables of both the CS-80 and the guitar amplifier into the same AC outlet box or the same AC plug strip. If you use a plug strip, use the grounded type. **Do not defeat the ground connection (third pin on the AC plug) on either the CS-80 or the guitar amplifier.** By connecting the AC cables of both units to the same AC outlet and then connecting the CS-80's output to the guitar amp's input with a shielded cable ("output connections"), you insure that the chassis of both devices will be at the same ground potential, avoiding any possible shock hazard.
(Not applicable for the model with the 2P-plug.)

Output Jacks

The LEFT and RIGHT outputs are identical except when the TREMOLO or CHORUS effect is used, in which case they alternately change in level and phase to produce a rotary speaker effect. The GENERAL output is mono mix of LEFT and RIGHT.

Each jack is a low impedance, standard tip/sleeve phone jack. LOW line level is nominal -20dB (77.5 millivolts), and HIGH line level is 0dB (0.775V).

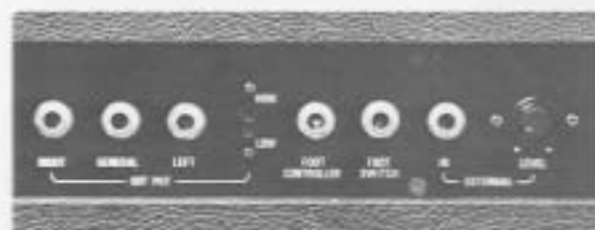

*As is the case with any electric or electronic instrument, the AC power receptacle should be checked for correct voltage and polarity. For operation with power mains that do not meet these specifications, contact the Yamaha authorized dealer.

The CS-80 outputs are unbalanced and will drive low-impedance (600-ohm) or high impedance inputs, either balanced or unbalanced; this includes mixers, guitar amps, tape recorders, and many other audio devices. If you are not sure about the sensitivity of your equipment, start with the HIGH/LOW switch at LOW to avoid excessive levels. Use any high quality phone-to-phone plug patch cable (guitar cord) to connect the CS-80 to a standard guitar amplifier, a high impedance mixer such as Yamaha's PM-170 or directly to an amplifier/speaker system combination such as the Yamaha A4115H.**

To minimize hum pickup in very long sound system cables, use an accessory transformer or line-level direct box close to the CS-80 and then run a balanced line (2-conductor shielded XLR mic cable) to the mixer.

Foot Jacks

Plug the FOOT CONTROLLER PEDAL into the FOOT CONTROLLER jack. The controller plug is a 3-circuit phone plug (tip/ring/sleeve). The FOOT SWITCH and FOOT CONTROLLER plugs should never be inserted in each other's jacks.

External Input Jack

The External Input jack is for special Sub Oscillator effects. It allows for modulation of the filter, oscillator or amplifier by line-level sources, such as oscillators, rhythm boxes, other electronic instruments, etc. The input is high impedance, so it will not overload the external device. Sensitivity is adjustable with the EXTERNAL LEVEL control, but even at maximum sensitivity the input will not provide a discernable effect with mic-level or guitar pickup level signals.

Accessory Devices

You can use a variety of accessory devices between the CS-80 output and the sound system input: reverbs, echo boxes, phase shifters, and so forth. Remember that the CS-80 has built-in circuitry to produce wah-wah, tremolo, vibrato and certain phasing effects (SUB OSCILLATOR [11] and TREMOLO/CHORUS [15]).

The Speaker/Amplifier System

The sound of the CS-80 will depend to a large degree on the amplifier and speaker system; the wider the response, the better. We recommend use of the self-powered Yamaha A4115H speaker system, due to its wide, flat frequency response. However, the CS-80 may be used with almost any wide-range professional

**Set the INPUT LEVEL switch on the PM-170 or the A4115H to the "0dBm" position (for nominal 0dB sensitivity).



Yamaha A4115H Speaker/Amplifier

speaker/amplifier system (or tape recorder).

If you use several keyboards, you may also wish to use a keyboard mixer. In any case, it's a good idea to choose these items carefully. We recommend the Yamaha PM-170, a six-input stereo output mixer with



Yamaha PM-170 mixer

VU meters and BASS and TREBLE equalization on every input. This mixer can then feed any amplifier/speaker system. Alternately, use a self-powered mixer such as the Yamaha EM-150. The keyboard outputs,



Yamaha EM-150 self-powered mixer

including the CS-80 outputs, can be fed to the mixer input, and the outputs can be connected directly to a pair of speakers such as Yamaha S4115H's.

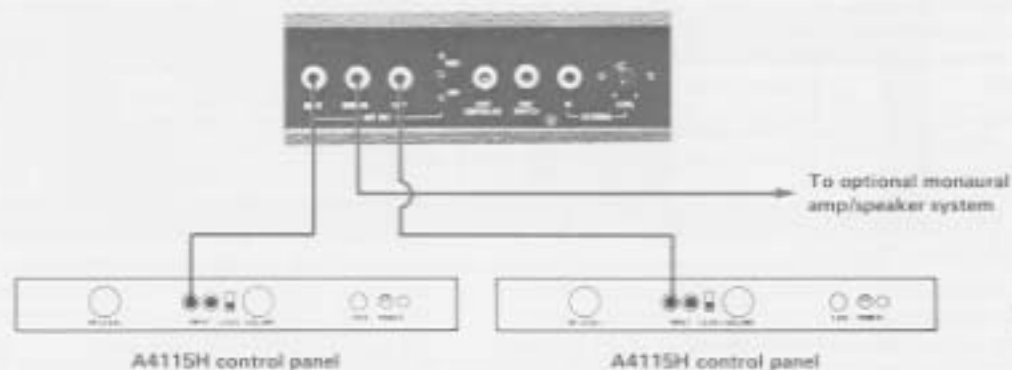

More About the A4115H

The Yamaha A4115H is a two-way speaker system with a built-in 100 watt power amp. It produces natural, accurate sound and smooth, wide dispersion. The A4115H can be driven directly from the CS-80's outputs, or from the output of a PM-170 or similar mixer. In the studio, the sound can be taken direct from the CS-80, or excellent results can be obtained by placing a microphone near the A4115H. On the stage, the A4115H's high sensitivity and high power output generate high volume levels free of audible distortion.

If you are using two A4115H's, connect a cable from the Left and Right outputs on the CS-80 to one

input on each A4115H. Set the CS-80 output HIGH/LOW switch at HIGH, set the A4115H's INPUT LEVEL switch to the "0dBm" position, and set its INPUT VOLUME as required. The speaker's HF LEVEL control sets the volume level of the high frequency horn in relation to the low frequency woofer.

NOTE: If you wish to use three A-4115H's, one may be fed by the General output. To feed more than one A-4115H from one CS-80 output, "chain" the A4115H's together; connect a phone-to-phone cable from the unused input jack of the A4115H being fed by the CS-80 to an input jack on the next A4115H, and so forth.

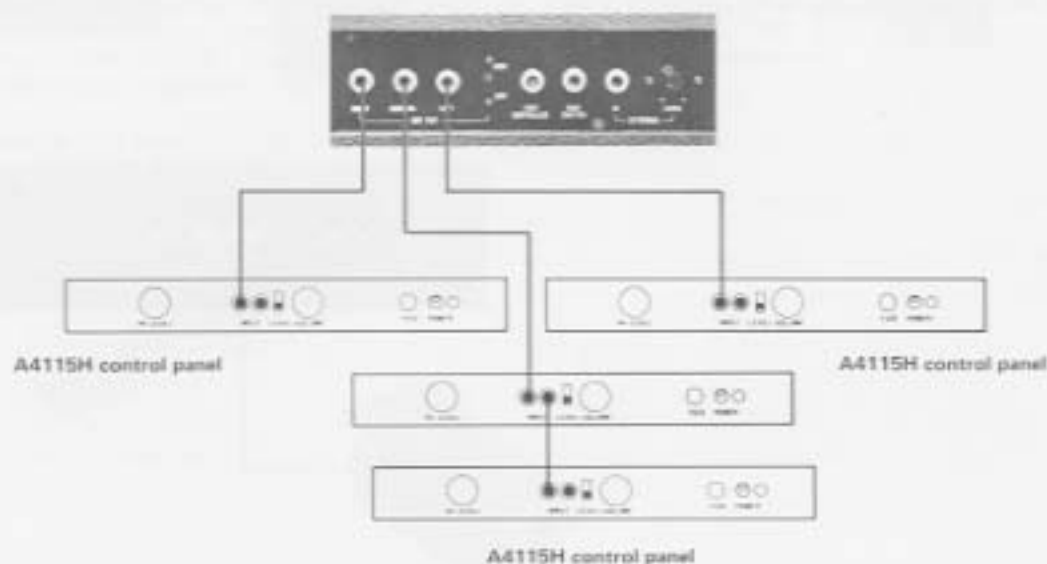

Headphones

A stereo headphone jack is provided under the keyboard on the right side. Use any 8-ohm or higher impedance stereo phones. As a rule, however, synthesizers sound best when monitored with speakers rather than phones.



Getting Sound

When all connections are made, turn ON the CS-80 and set all controls at nominal except its main VOLUME control [1], which you set minimum. Then bring up the sound system volume to a moderate setting and adjust the CS-80 volume while playing a chord. Remember, as with most multiple-oscillator synthesizers, the CS-80 requires about 10 to 30 minutes to warm up for full stability.

6 This section presents detailed information on all the CS-80's sliders, levers, switches and rotary controls, except the Panel and Memory controls, which are treated separately in Section III. We have included many diagrams to illustrate the effects of the controls, and to stimulate your own imagination. If you would like more information about synthesizers in general, refer to Section V.

Within this manual, or any manual, it would be impossible to completely describe the many sounds you can achieve with your CS-80. However, we feel that if you understand the concept of the instrument, and generally are familiar with how it works, you will be able to use the CS-80 with creativity and skill.

The CS-80 allows you to learn that your playing style has as much to do with the "realism" of a sound as does the inherent sound of the synthesizer. If you play a good recording of a clarinet note, but turn on the speaker only during the middle of the note, it might sound like a purely electronic sound because the way the tone and volume change during the note are essential to defining the clarinet character. Musical realism often depends on the musical context as well, since other instruments can mask or bring out a given sound.

With synthesizers, the word "patch" commonly describes the control setup for any given sound. Historically, there used to be physical patch cords or pegs that had to be connected for each new sound . . . some synthesizers still use this system. However, the CS-80 is a third-generation instrument, and many advances in design allow all patching to be done internally, and quickly, with no cords to handle. Still, out of tradition and for lack of a better term, we refer to each program (each sound) as a patch.

Explanatory Notes:

A. The CS-80 controls are color coded. Different color knobs suggest different types of functions, as follows:

- GREEN = general filter characteristics
- RED = filter resonance
- WHITE = pitch
- GREY = volume
- YELLOW = sustain
- BLACK = other functions

B. In this section we have indicated control knob colors in parentheses. (Button colors for the preset patches do not strictly follow the color coding scheme.)

C. All slider controls and levers on the CS-80 move in a forward-to-backward direction relative to the player. However, some controls are arranged so that maximum effect occurs nearest the player (lever down), and others give maximum effect away from the player (lever up). Therefore, in the text of this manual, settings are sometimes suggested by the words "down" or "up," which avoids confusion with "max" and "min."

D. Interspersed among the discussions of the basic sound producing and sound modifying functions, there are a number of patch examples. These examples are intended to assist you in quickly learning how each control works, and to illustrate what the control does to the sound. You are encouraged to try our examples, and to also play with other settings. Unless otherwise noted, set all controls at the "normal" or nominal settings, as shown by the photograph inside the front cover.

Controls & Switches

[1] **POWER SWITCH**—The power should be ON from 10 to 30 minutes before you play the synthesizer. While the CS-80 is 100% solid state, a "warm up" period allows internal components to stabilize, as is common with most multiple-oscillator synthesizers. A red light in the switch is illuminated when power is ON.

[2] **VOLUME CONTROL** — This adjusts the volume (output level) for the entire synthesizer. There are also other controls on the CS-80 which affect the VOLUME. If the sound is too quiet, check to be sure the FOOT CONTROLLER pedal is set for maximum level (parallel to the floor). Also, check the rear-panel HIGH/LOW switch; moving it from LOW to HIGH increases the level substantially (20dB). BRILLIANCE [7] can have a marked effect on the volume of some preset patches.



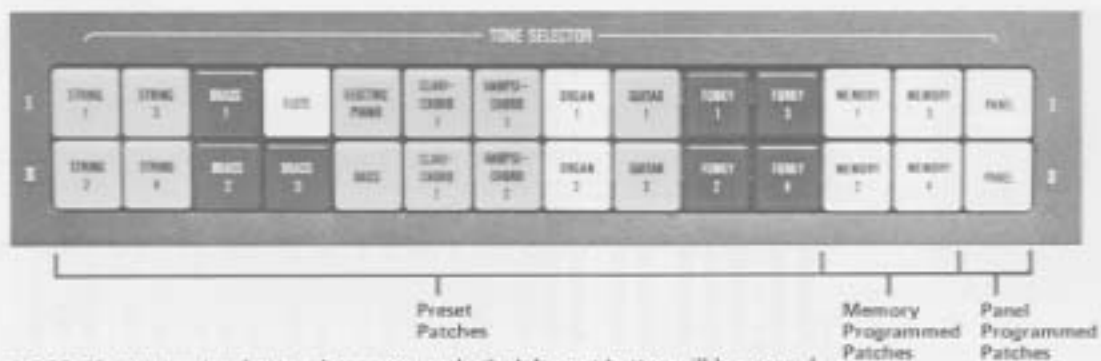

NOTE: If you press two buttons in one row, only the left-most button will be engaged.



[3] **TONE SELECTORS** – There are two rows (ranks) of selectors, each offering 11 preset patches, two memory-programmed patches and one panel-programmed patch. The preset patches let you come very close to playing the sounds indicated on the TONE SELECTOR buttons. When there is more than one patch with the same name, they sound similar, but not identical. You may select one patch from each row at the same time by lightly pressing the desired buttons. (Two sounds in the same row may not be selected simultaneously.) The MIX control [4] then sets the relative amount of sound from each row. For more information about the programmable PANELS and MEMORY, see Section III.

[4] **MIX I-II** – The CS-80 will simultaneously produce two independent sounds, I & II, whenever you play a note. These sounds are fed to the MIX I-II control lever, which serves as a balance control, adjusting the relative proportion of sound I and sound II.

Move the MIX Lever to I, and play each preset patch by touching the TONE SELECTOR [3] buttons in row I. Now move MIX to II and try all the presets in row II. Thus far, you have heard only one patch at a time. However, any two patches, one from row I and one from row II, may be mixed by setting MIX at or near center.

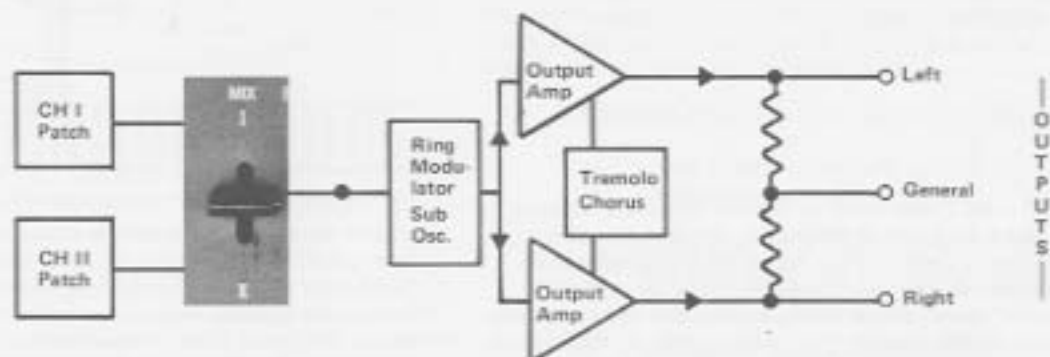

[5] **I- FEET- II** – These two detented sliders determine the pitch of the sound generated by channels I and II when a given note is played (a movable “do”). The term “Feet” is derived from standard organ stops, so the higher the number, the lower the pitch; 16’ represents the lowest pitch, and 2’ the highest pitch. The sliders do not operate in between detents. Instead, fine tuning is accomplished with a separate PITCH control [18].

The score illustrates what you will hear at the various footages when the C shown on the keyboard is depressed. If 8’ is considered normal pitch, then 16’ is one octave below, 5-1/3’ is a perfect fifth up, 4’ is one octave up, 2-2/3’ is one octave plus a perfect fifth up, and 2’ is two octaves up.

Select BRASS 1 & 2, and set FEET I at 16 and FEET II at 5-1/3. As you play, move the MIX LEVER from I to the center and down to II, listening closely. Then reset MIX in the center and move FEET I and II to various settings while playing a note. Notice that you can convert a tuba into a trombone, etc.

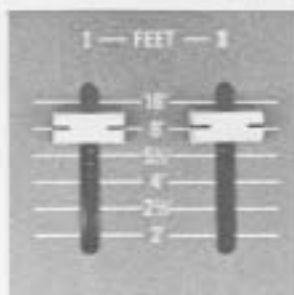

“Normal” CS-80 keyboard range (Feet Selector at 8’). Middle “C” equals B’ pipe on organ.

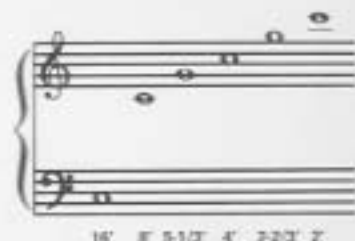

Music shows what note you hear when playing Middle “C” at different footage settings.

[6] **DETUNE CH II** – (White) This lever raises or lowers the pitch of channel II, but does not affect channel I’s pitch. Thus, when the two channels are mixed, you can get a detuned effect for a “honky-tonk” piano, deeper string sounds, etc. When the lever is centered, channel II is tuned exactly to the interval set with the FEET II slider.

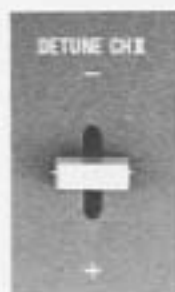

[7] **BRILLIANCE** – (Green) BRILLIANCE allows you to increase or decrease the amount of harmonics (overtones) for any sound, whether preset or patched. Setting the lever down creates a brighter sound. Setting the lever up produces a richer, more mellow sound. This lever affects the entire keyboard. The nominal lever position for all patches is centered.

[8] **RESONANCE** – (Red) RESONANCE creates special tonal effects, such as “twang” and “wah.” The exact effect of RESONANCE depends on the BRILLIANCE setting.

Set RESONANCE for maximum (down) and very gradually move the BRILLIANCE lever toward you with the other hand. Continue moving BRILLIANCE all the way forward while playing a series of notes. Repeat this exercise using several different preset patches.

Now experiment with several controls. Play a chord and set BRILLIANCE and RESONANCE. Try moving one FEET selector to 16’ and leave the other at 8’ . . . or move it to 5-1/3’ . . . whatever sounds good to you. Readjust RESONANCE and BRILLIANCE.

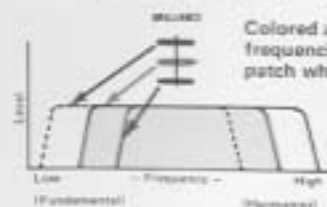

Colored area is all the frequencies in the “Raw” patch when lever at nominal.

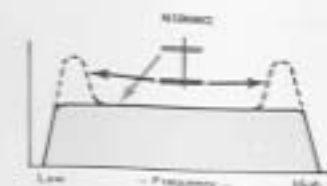



[9] **KEYBOARD CONTROL BRILLIANCE—LOW & HIGH** — (Green) BRILLIANCE LOW and BRILLIANCE HIGH allow you to balance the brightness across the keyboard range. There is no abrupt change where one lever's effect ends and the other lever's effect begins, although a transition occurs somewhere near the middle of the keyboard. In fact, the LOW and HIGH levers operate on a smooth curve (see illustration). BRILLIANCE LOW produces more effect gradually as notes further below the middle of the keyboard are played, and, conversely, BRILLIANCE HIGH produces more effect gradually as notes further above the middle of the keyboard are played. Both levers add to the effect of the overall BRILLIANCE lever [7].

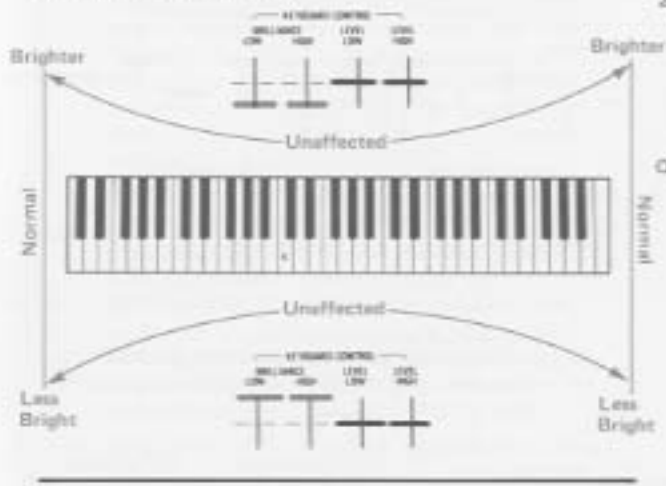

[10] **KEYBOARD CONTROL LEVEL—LOW & HIGH** — (Grey) These levers operate in a manner similar to the adjacent BRILLIANCE LOW and HIGH controls. However, rather than adjusting the brightness for the lower and upper portions of the keyboard, these levers balance the volume level across the keyboard range. Moving a lever down increases

the volume and moving a lever up reduces the volume in the corresponding portion of the keyboard.

Play clavichord, string, organ, funky and piano patches, adjusting the KEYBOARD CONTROL BRILLIANCE LOW lever. Notice that this lever affects only the lower portion of the keyboard, with more effect toward the lowest notes. Repeat the musical example, this time adjusting the BRILLIANCE HIGH lever.

Repeat the example twice more, only this time adjust LEVEL LOW and then LEVEL HIGH. When you have achieved a satisfying balance of brightness and volume across the keyboard, vary the overall tonality with the main BRILLIANCE control, and the overall level with the main VOLUME control. The typical acoustic instrument is louder and less brilliant in lower registers, while quieter and more brilliant in upper registers, as shown.

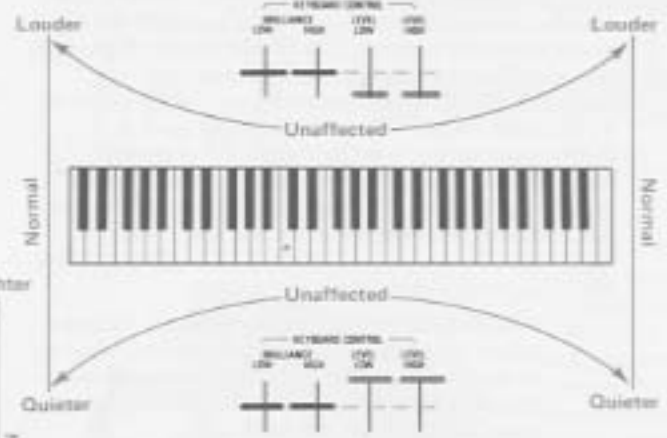

NOTE: Play a scale from the bottom to the top of the keyboard to hear the effect of each keyboard control example.



Typical setting to simulate the frequency response of an acoustic instrument.



[11] **SUB OSCILLATOR SECTION** — This section can be used to create effects such as vibrato, wah-wah, tremolo and others through modulation of the VCO, VCF and VCA.* The FUNCTION slider selects the type of modulation (the waveform) for variations in effect, and the SPEED lever determines the modulation rate. The VCO, VCF and VCA levers determine the amount of modulation, and may be used individually or in combinations; with the lever up, there is no effect, and with it down, the depth of the effect is maximum. These controls may be used to modify the sound of any of the patches, whether pre-set or of your own selection, and their effects apply equally across the entire keyboard range.

A. **FUNCTION** (black) Use this switch to select:

- ~ a sine wave (for smooth, up and down modulation).
- ∨ a sawtooth wave with rapid beginning and slow decay (for a downward sweeping special effect sound).
- ∨ an inverted sawtooth wave with slow beginning and rapid decay (for an upward sweeping effect).
- ⌊ a square wave (for angular, alternating sound, like a trumpet trill or a rapidly picked pair of mandolin strings).

NOISE white noise (for breath or a raspy sound).

EXT whatever line-level signal is applied to the external input jack will affect the VCO, VCF and/or VCA sliders (C, D & E below); if nothing is connected to the external input, this position may be used as an "off" mode for the whole sub oscillator section.

*VCO, VCF and VCA refer to Voltage Controlled Oscillator, Filter and Amplifier. These change the pitch, harmonic structure and level, respectively, as discussed further in Sections III and V.

B. **SPEED** (white) Affects the speed (rate) of the sine, sawtooth and square waves, but has no effect on noise or the external input. Set the lever up for slowest speed and down for fastest speed.

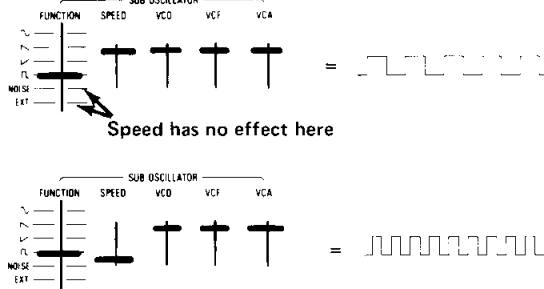

C. **VCO** (white) varies the pitch of any notes you play by modulating the Voltage Controlled Oscillator with the FUNCTION-selected waveform. At slower speeds, the sound is that of a vibrato. Faster speeds produce a sound that resembles ring modulation.

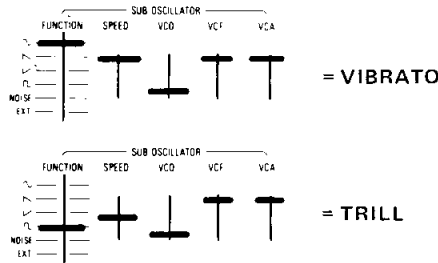

D. **VCF** (green) modulates the Voltage Controlled Filter, thereby varying the tonal character (overtones) of any notes that are played. At slower speeds, the sound is that of an automatic wah-wah. Faster speeds, particularly when a square or sawtooth wave is selected for the FUNCTION, yield unusual effects.

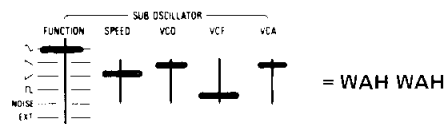

For more "wah" add Resonance [8].

E. **VCA** (grey) applies the modulation to the Voltage Controlled Amplifier, varying the volume of any notes that are played. At slower speeds, the sound is that of a tremolo. Faster speeds produce beating or pulsing effects.

NOTE: Initially, the best way to hear the effect of the Sub Oscillator is to choose a slow SPEED, pull the VCO lever down for maximum modulation, and then select each FUNCTION waveform. Repeat the same procedure for the VCF and VCA levers.

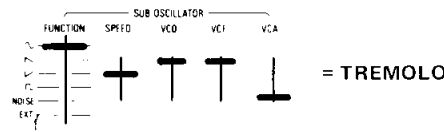

[12] **TOUCH RESPONSE SECTION** – These levers modify the sound according to how you play the keyboard (dynamic control). The three right-hand controls are related to the Sub Oscillator Section [10], as indicated. They also are pressure sensitive, as indicated by the term "After." The **PITCHBEND** lever is independent of the Sub Oscillator, and is velocity sensitive, as indicated by the term "Initial." "Initial" means that the amount of effect is determined by how fast and hard you **initially** strike the key. "After" means that the amount of effect is determined by how hard you press a key **after** it hits bottom.

A. **PITCHBEND** (white) causes the pitch to begin below the note you play and to quickly slide up to the proper pitch. **The faster and harder you strike the keys, the more the pitch bends. No effect is heard with the lever up.**

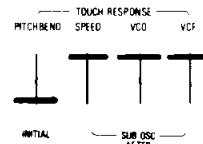

Little or no pitch bend is heard.

Pitchbend occurs.

B. **SPEED** (white) increases the speed of any VCO, VCF or VCA FUNCTION selected with the Sub Oscillator.

NOTE: SPEED also interacts with the adjacent VCO and VCF levers. SPEED has no effect if the Sub Oscillator Function is set at EXT or NOISE, since they have no set speed per se.

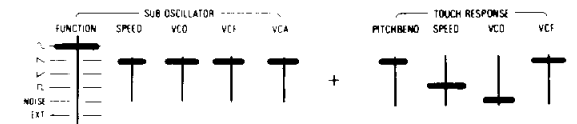
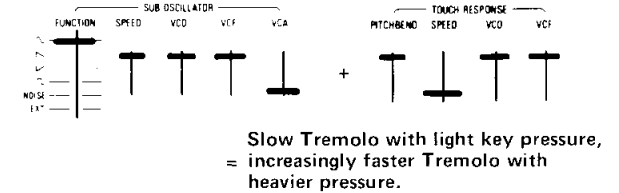

C. **VCO** (white) varies the pitch of the sound for a trill or vibrato on individual notes as you play.

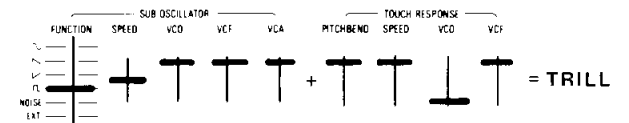
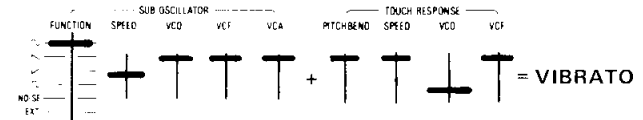

D. **VCF** (green) varies the overtones for adding a change of brightness to individual notes as you play.

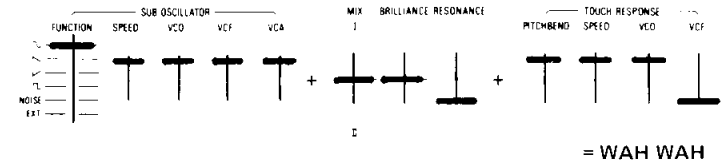

= WAH WAH

[13] **SUSTAIN SECTION** – Together, four controls affect how long the note remains after you let go of a key. The sustain can be activated by hand or with a foot switch.

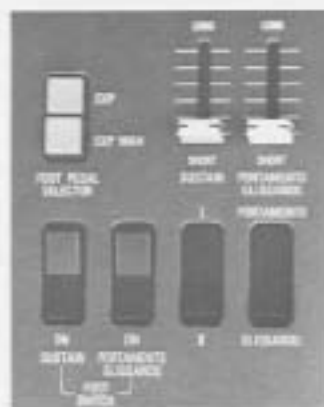

- A. **SUSTAIN SLIDER** (yellow) Adjusts how long a note sustains, from **SHORT** (no sustain) to **LONG** (about 10 seconds).
- B. **SUSTAIN I-II** (black) Two types of sustain are available with the CS-80, I and II (no relationship to channels I & II). With **SUSTAIN I**, each note struck dies independently of any others, and all have the same sustain time. In **SUSTAIN II** mode, the last note or chord played carries the sustain; if several keys are released simultaneously, they will all carry the sustain. The next chord or note played ends any previous sustain.
- C. **FOOT SWITCH PEDAL** Stepping on this **FOOT SWITCH PEDAL** turns **ON** the sustain when the **SUSTAIN FOOT SWITCH** assigner is also **ON**. The amount of sustain is set with the **SUSTAIN SLIDER**. However, releasing the pedal will immediately end any sustain, short or long. (This foot switch may also be used to control Portamento/Glissando effects; see the following section, paragraph 14 C.)
- D. **SUSTAIN FOOT SWITCH ASSIGNER** – When switched to **ON**, there is no sustain unless the **FOOT SWITCH PEDAL** is also held down. If you wish to activate the sustain with your hand, simply rock the **ASSIGNER SWITCH** back. This bypasses the **FOOT SWITCH PEDAL** and introduces that amount of sustain already set with the **SUSTAIN SLIDER**.

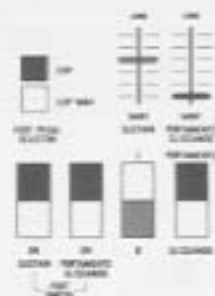
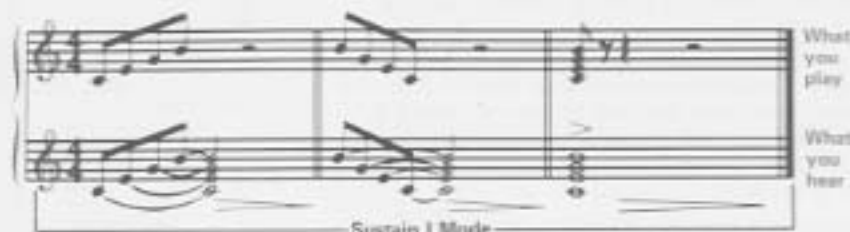
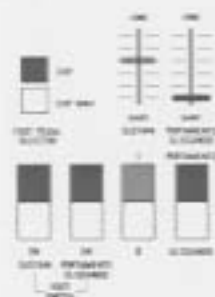

NOTE: With the **FOOT SWITCH** unplugged, the **ASSIGNER** switch does not function, so sustain is always **ON**. If you prefer not to use a **FOOT SWITCH** and you want to switch sustain **ON** and **OFF**, do it by moving the **SUSTAIN SLIDER** up and down, or insert an unwired standard phone plug in the rear-panel foot switch jack to activate the **ASSIGNER** switch.

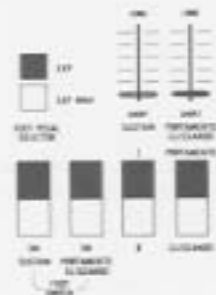

No sustain regardless of foot switch position.

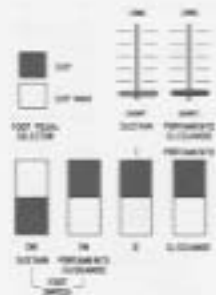

No sustain regardless of foot switch position.

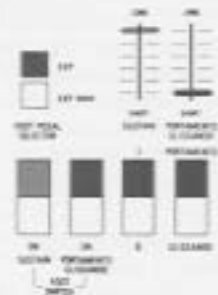

Long sustain regardless of foot switch position.

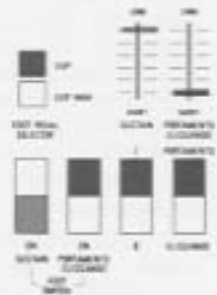

Long sustain when foot switch is down.

[14] PORTAMENTO/GLISSANDO SECTION –

Together, four controls affect the transition between successive notes or chords: the PORTAMENTO/GLISSANDO (P/G) slider, the P/G FOOT SWITCH ASSIGNER, the P/G SELECTOR SWITCH, and the FOOT SWITCH. *Portamento* is a smooth, continuous glide in pitch from the previously played note or chord to the next. Glissando is also a change in pitch from the previously played note or chord to the next, but is a stepped progression rather than a continuous slide . . . like playing a chromatic 1/2 step scale from one note or chord to the next.

A. **PORTAMENTO/GLISSANDO SLIDER** (white) Adjusts how long it takes to move from one note to the next when Portamento or Glissando is ON. Set at SHORT (up) there is no audible effect; at LONG (down) the maximum effect is obtained. With the lever at maximum LONG effect, it takes about 10 seconds for the pitch to change from the lowest to the highest note on the keyboard (about 2 seconds per octave).

B. **P/G FOOT SWITCH ASSIGNER** (black) When switched to ON, the FOOT SWITCH controls the portamento or glissando effect. If you wish to activate the P/G effect with your hand, turn off this switch; it then bypasses the FOOT SWITCH and introduces the amount and type of effect you set with the P/G SLIDER and SELECTOR SWITCH.

NOTE: With the FOOT SWITCH unplugged, the ASSIGNER switch does not function, so P/G is always ON. If you prefer not to use a FOOT SWITCH and you want to switch P/G ON and OFF, do it by moving the P/G SLIDER up and down, or insert an unwired standard phone plug in the rear-panel foot switch jack to activate the ASSIGNER switch.

C. **FOOT SWITCH PEDAL** Stepping on the FOOT SWITCH PEDAL turns ON the P/G effect only when the P/G FOOT SWITCH ASSIGNER is also ON. The amount of effect is set with the P/G SLIDER. However, releasing the pedal will immediately end the gradual transition and cause the pitch to jump to the note BEING played. (This FOOT SWITCH PEDAL may also be used to control Sustain; see the previous section, paragraph 13 C.)

D. **P/G SELECTOR SWITCH** (black) With the switch rocked back, Portamento will be activated if the appropriate P/G controls are also ON. With the switch rocked forward, Glissando will be activated instead.

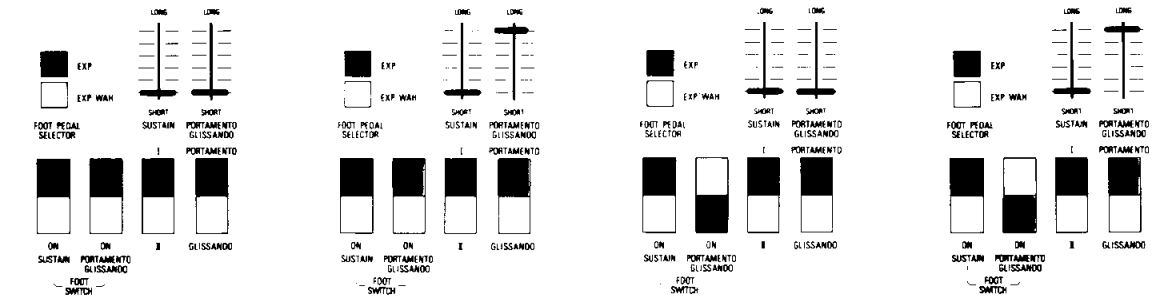
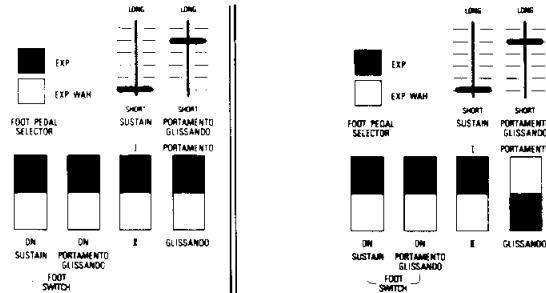

No portamento or glissando regardless of foot switch position

Long portamento regardless of foot switch position (or long glissando if P/G selector moved to "Glissando")

No portamento or glissando regardless of foot switch position

Long portamento (or glissando) when foot switch is down

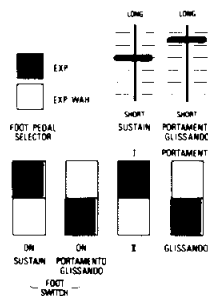

Moderate sustain on all notes, Glissando when foot switch is down

[15] **TREMOLO/CHORUS SECTION** – Five controls activate and modify a phasing-type TREMOLO on the CS-80 output. CHORUS is actually a form of tremolo, but a very slow one. When either effect is activated, three things happen: (1) the volume level alternately varies up and down in the LEFT and RIGHT outputs, (2) the phase of the signal in the LEFT and RIGHT outputs changes to create a "rotary" speaker effect, and (3) overall CS-80 output volume decreases slightly. These effects may also be heard in the mono (GENERAL) output.

- A. **ON/OFF** (black) This rocker switch activates the TREMOLO or CHORUS, as set by the adjacent rocker switches. If neither chorus nor tremolo is desired, this switch should be OFF.
- B. **CHORUS** (black) This rocker switch presets the tremolo/chorus circuit for a very slow effect range (see D & E below).
- C. **TREMOLO** (black) This rocker switch presets the tremolo/chorus circuit for a moderate to fast effect range (see D & E below).
- D. **SPEED** (black) This control adjusts the speed of the modulation for the chorus or tremolo (the speed variation is greater with tremolo). Maximum speed is at full clockwise rotation.
- E. **DEPTH** (black) This control adjusts the depth of modulation, the amount of effect. Maximum effect is at full clockwise rotation.

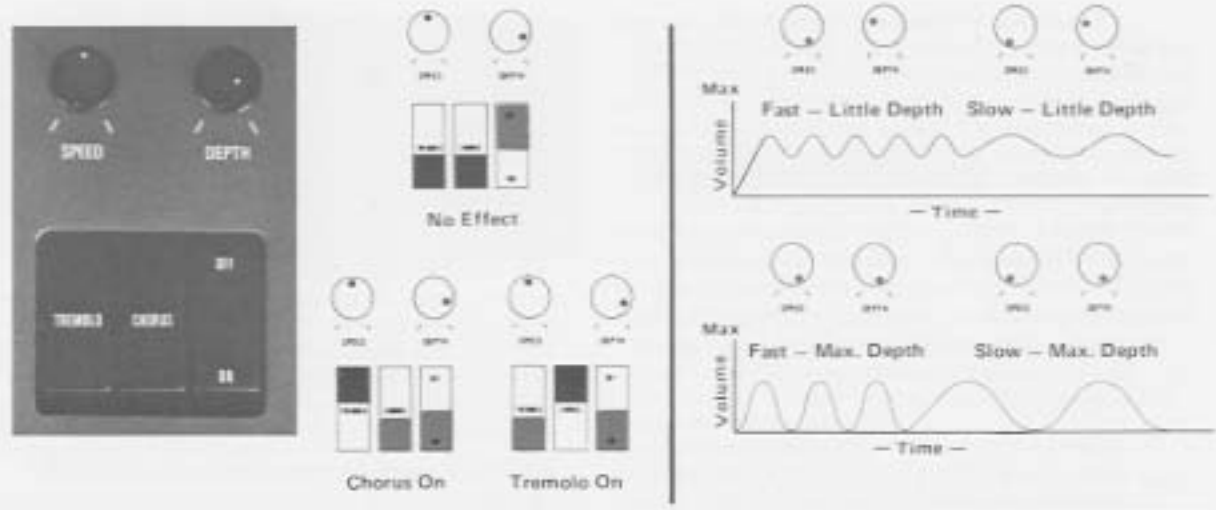

[16] **RING MODULATOR SECTION** – Ring modulation creates new frequencies, both higher and lower in pitch than the note played, but does not allow the actual note to be heard. This is accomplished by "beating" a sub oscillator against whatever input signal is fed to the ring modulator, thus producing sum and difference frequencies (the input frequency plus the sub oscillator frequency and the input frequency minus the sub oscillator frequency). The input signal is then cancelled in the output, leaving only the sum and difference of the input and sub oscillator frequencies.

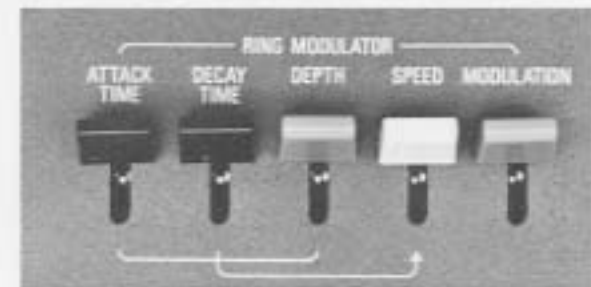

HOW THE RING MODULATOR WORKS

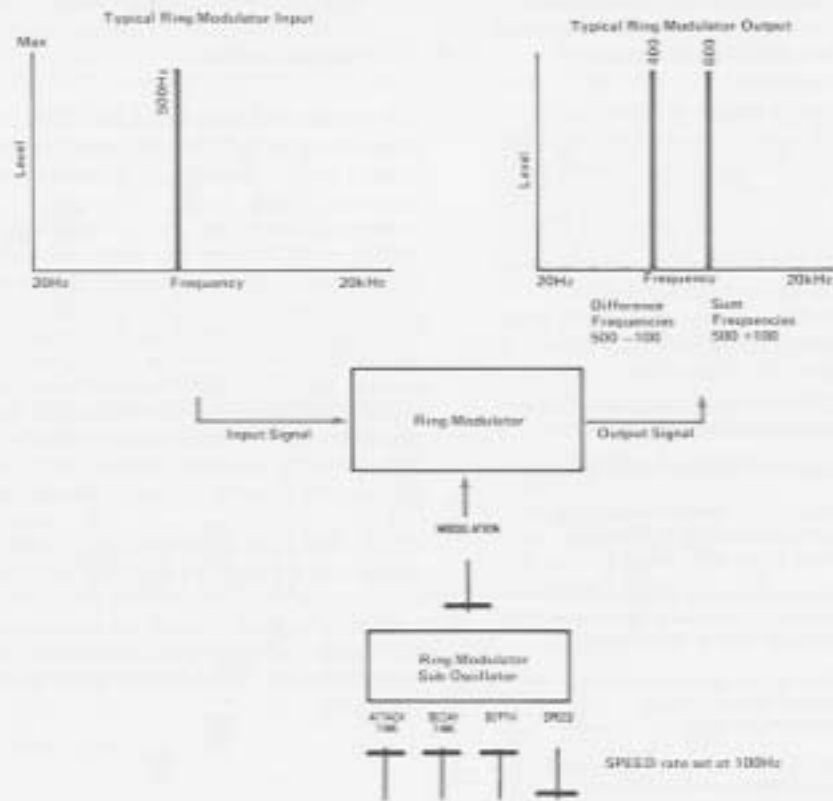

A knowledge of how the ring modulator works is not necessary to understand how it sounds. When the ring modulator's sub oscillator is set to a slow SPEED, the effect is pulsing that may resemble a tremolo. However, at faster speeds a strange gong-like ringing or non-musical dissonance will be heard. The MODULATION (amount of effect) is constant when a note is played, and so is the SPEED unless the adjacent ATTACK TIME, DECAY TIME and DEPTH levers are activated; these levers enable you to automatically speed up and slow down the ring modulator's sub oscillator whenever you play a note, for a "swooping" or "pinging" effect.

- MODULATION LEVER** (grey) Adjusts the depth of effect from no effect (up) to maximum effect (down).
- SPEED LEVER** (white) Sets the modulation speed or rate. Slowest speed is obtained with the lever up, fastest with the lever down.
- DEPTH** (grey) Sets the amount of automatic speed change created by the ATTACK & DECAY levers. (Depth does not refer to the amount of ring modulation.) With this lever up (minimum depth), the ATTACK & DECAY TIME levers do nothing.
- ATTACK & DECAY TIME LEVERS** (black) ATTACK sets the maximum SPEED obtained as the ring modulator moves up from the basic SPEED setting. DECAY sets the length of time it takes for the rate to return to the set SPEED.

NOTE: So long as you hold down one or more keys, playing additional notes will not generate another ring modulation attack. However, if you let go of all keys first, then the ring modulator will again attack and decay on the next note or chord you play.

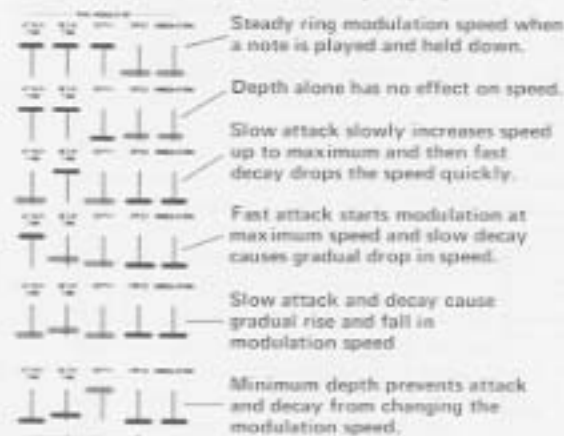

[17] FOOT PEDAL SELECTOR BUTTONS – (Grey) The FOOT PEDAL (Foot Controller) may be preset to perform two functions. When the EXP button is down, the FOOT PEDAL serves as an expression pedal; tilting the pedal forward lowers the volume. When the EXP. WAH button is down, and you rock the FOOT PEDAL, it simultaneously varies the volume (expression) and creates a Wah-Wah.



Don't press both buttons

[18] PITCH CONTROL – (Black) This is a concentric control. The outer ring is a coarse adjustment that tunes the entire keyboard up or down in pitch. The full range of adjustment is about one octave, and the ring is detented in the center for normal tuning. The inner knob is a fine pitch adjustment with a range of about one semi-tone; nominal position is centered.

NOTE: To obtain the most precise tuning to other instruments:

- Set the MIX lever [4] to "1".
- Press the "ORGAN 1" Preset [3].
- Turn off or set at minimum all Sub-Oscillator, Tremolo/Chorus, Ring Modulator, and Touch Response effects.



[19] RIBBON CONTROLLER – This is a velvet-covered strip that tunes the entire keyboard up or down in pitch. It makes no difference where you first touch the ribbon; you just move up or down from that reference point, either by sliding a finger along the ribbon, or by holding one finger in place and touching another finger elsewhere on the ribbon. Use this for expressive vibratos, string-bending effects, chord modulations, whistles or other unusual effects. When the CS-80 is in SUSTAIN I mode, the ribbon only changes the pitch while you are holding down a key. In SUSTAIN II mode, the ribbon will also change the pitch during the sustain (after you let go of the keys). Experiment to see what happens when you let go of the key and then the ribbon, and vice-versa.

NOTE: The range of upward pitch slide is approximately one octave if you start at the left of the ribbon and move to the far right. The range of downward pitch slide is much greater; by starting on the right of the ribbon and moving to the left, you can move the highest note on the keyboard down to a sub-audio frequency.



SECTION III – DESCRIPTION OF PROGRAMMABLE PANELS, MEMORY, HOW TO PROGRAM & SUGGESTED PATCHES

This section details the function of the CS-80 programmable PANELS [20-45], and how to program your own patches, creating sounds literally "from scratch." Also discussed are the MEMORY panels [46] –miniaturized versions of the larger programmable panels that are used for storing four of your own programmed patches for instant recall at the touch of a button.

What the Panel Controls Do

The PANELS let you select the waveform, harmonic structure, changes in harmonics, volume changes, and basic keyboard dynamics to program an infinite variety of sounds. The same circuits controlled by these PANELS are internally controlled to obtain the preset patches; each TONE SELECTOR button simply recalls an internally-stored pattern of PANEL settings. Thus, with the PANELS, it is possible to manually duplicate any of the presets, to vary them slightly, or to depart drastically for totally unique sounds. The two main panels, PANEL I and PANEL II, are identical. Therefore, we explain just one of them.

NOTE: To hear what effect the PANEL controls have as you read this section, set all CS-80 controls at their nominal positions (as indicated on the inside front cover), with these exceptions:

- Set the MIX I-II lever [4] at I.
- Press the PANEL button on row I of the TONE SELECTOR section [3].
- Set the BRILLIANCE lever [7] at minimum brightness (up).

We use PANEL I in these examples because it is closer to the music stand than PANEL II, hence easier to see as you read this section.

[20-25] The VCO –

WAVEFORMS: The VCO, or Voltage Controlled Oscillator section, creates the CS-80's four basic sounds: SQUARE WAVE, SAWTOOTH WAVE, WHITE NOISE and SINE WAVE. Turn ON the square wave [23] and play a note. Turn OFF the square wave and turn ON the sawtooth wave [24]. Turn OFF the sawtooth, and bring up the NOISE slider [25]. Bring down the NOISE slider, and bring up the sine wave [36]. Observe the difference between these sounds. (The sine wave slider, even though it is part of the VCO electronics, is located in the VCA section because pure sine waves have no harmonics, and would therefore not be changed by VCF processing.)

**Normally, BRILLIANCE is centered when programming, but this setting is better for initial demonstrations of filter effects.*

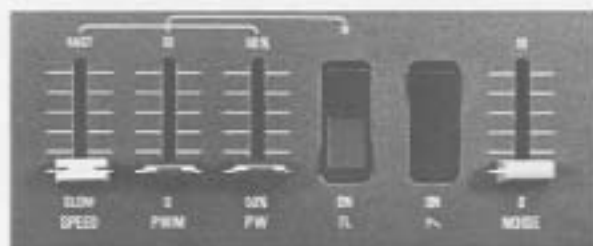

[22] **PULSE WIDTH** – The square wave [23] had a particular sound that might be described as "hollow." However, you can vary the sound of the square wave with the adjacent PW slider [22]. This slider affects only the sound of the square wave, and has no effect on the sawtooth, sine wave or noise.

With the square wave ON, play a note and very gradually push the PW slider up to 90%. This changes the Pulse Width of the square wave, which changes the harmonics for a more "nasal" sound. Now move the PW slider down to 50% again as you continue playing a note.

Try moving the PW slider back and forth (50% to 90%), doing it faster and faster as you play a note,

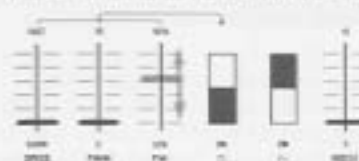

and observe the phasing-like sound. You can have the CS-80 do the same thing for you automatically, using the adjacent PWM [21] and SPEED [20] sliders.

[21] PWM (Green) & [22] SPEED (White)

PWM stands for Pulse Width Modulation. Set the PW slider at 75%, and move the PWM slider [21] up

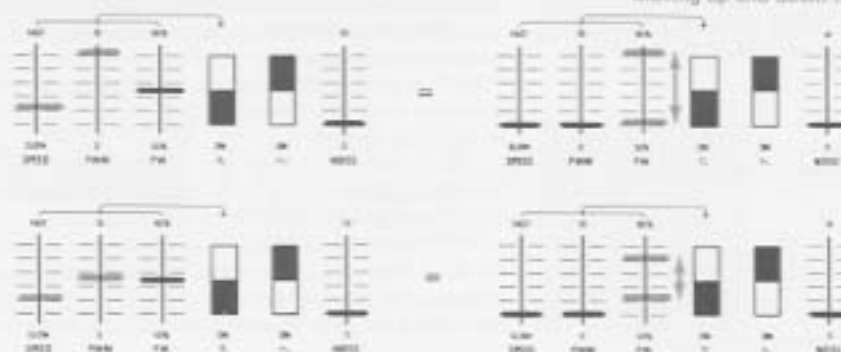

to maximum modulation (#10). Now play a note and you will hear an effect that is identical to manually moving the PW slider back and forth all the way, but very slowly. Gradually push the SPEED slider [20] from SLOW toward FAST, and notice what happens; pulse width modulation occurs faster and faster. Eventually, you will reach a speed that is much faster than you could possibly achieve by moving the PW lever back and forth with your hand. At the point when the SPEED of modulation approaches audio frequencies (20 times per second or faster), a secondary tone will be heard.

You need not use maximum effect. With SPEED at a SLOW setting, try moving the PWM slider to its mid position. This effect is like moving the PW slider only part way up, and then back down. You can also vary the basic setting of the PW slider; try setting it at mid position and then use different PWM and SPEED settings. Together, the PW, PWM and SPEED sliders are one of the keys to achieving realistic string sounds.

As you have heard, the VCO produces different basic timbres (tones), but it is equally important for it to produce pitch. Therefore, when you play various notes on the keyboard, the VCO produces different pitches. The FEET selector also affects the VCO pitch, just as it did with the preset patches.

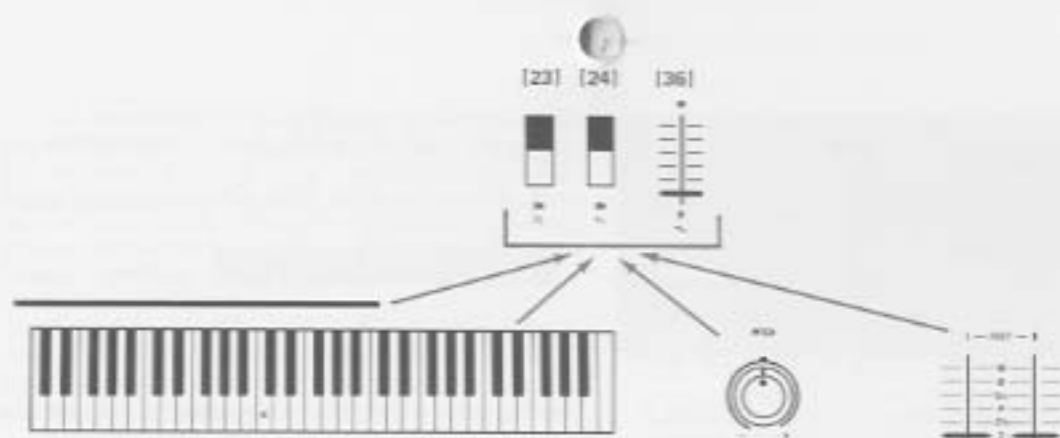

Four "Controls" set the pitch of the wave you select on the VCO.

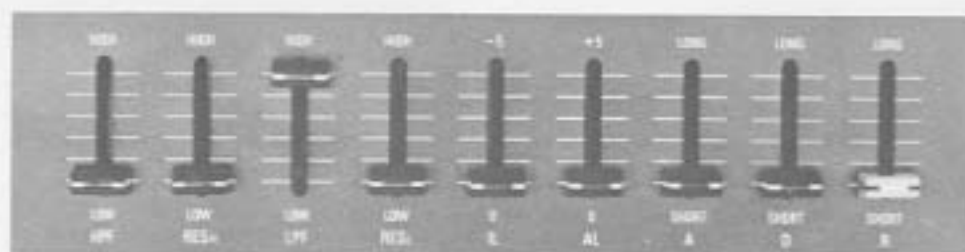

[26-34] **VCF** – The **Voltage Controlled Filter** section (**VCF**) lets some of the frequencies generated by the VCO be heard and cuts out others; hence the term **filter**. The action of the filter modifies the timbre (tone) by altering the harmonic structure of the basic sounds.

All the sounds created by the VCO, except sine wave, are immediately processed by the VCF section. Of the basic sounds available from the VCO, **NOISE** is the richest in harmonics. White noise is actually a combination of all audio frequencies . . . all harmonics and fundamentals occurring in a continuous, random pattern. Thus, noise makes an excellent sound with which to demonstrate the effects of the VCF.

[28] **LPF** – (Green) Bring up the **NOISE** slider [25] to maximum (#10), and play any key. Gradually move the **LPF** slider down (**HIGH** to **LOW**). The **LPF (Low Pass Filter)** cuts the high frequencies and allows lower frequencies to be heard; hence the term low pass filter. Notice how the sound becomes more "dull" as you move the slider down.

[26] **HPF** – (Green) Return the **LPF** slider to **HIGH**, thus allowing all noise frequencies to get through the VCF section. Now gradually move the **HPF** slider up from **LOW** to **HIGH**. The **HPF (High Pass Filter)** cuts the low frequencies (fundamental and lower harmonics) and allows higher frequencies to be heard; hence the term high pass filter. Notice how the sound becomes "thin" as you move the slider up. This useful filter, standard with the Yamaha CS-80, is seldom included in other synthesizers.

Together, the **HPF** and **LPF** sliders create a **bandpass filter**; that is, only frequencies above the **HPF** cutoff and below the **LPF** cutoff are heard.

This lets you "focus" or emphasize a narrow range of frequencies, perhaps only a few harmonics without the fundamental, or a wide range of frequencies, depending on how you set the **HPF** and **LPF** sliders.

NOTE: Think of the **HPF** and **LPF** sliders as a pair of curtains that let you "see" the sound. Certain settings of the sliders (the "curtains") can "narrow" the bandpass "window" to nothing—no frequencies can pass through the filters. If you are adjusting these sliders and the sound goes away, move **HPF** lower and/or **LPF** higher to "open" the bandpass so sound can come through. (See illustrations on next page.)

Bring down the **NOISE** slider, and turn on a sawtooth wave [24]. Starting with the **HPF** slider at **LOW** and the **LPF** slider at **HIGH**, gradually move the **LPF** slider up and down. Then move the **HPF** slider up and down. You are probably beginning to grasp how the VCF's two filters, **HPF** and **LPF**, affect the sound.

The **HPF** and **LPF** sliders each set one of two basic filter characteristics, the cutoff frequency. The other basic filter characteristic is **RESONANCE**. Rather than explain resonance at this point, it is easier to just demonstrate the effect. (Further explanations of filter characteristics are presented in Sections IV and V of this manual.)

[27 & 29] **RES** – (Red) High Pass Filter **RESONANCE** is set with the **RESH** slider [27], and Low Pass Filter **RESONANCE** is set with the **RESL** slider [29]. Move both these sliders up to **HIGH** for maximum resonance effect, and then gradually move the **HPF** and **LPF** sliders back and forth, one at a time, while playing a series of notes. Observe the "twang" or "wah" provided by the resonance. A "wah-wah" pedal lets you do the same thing with your foot instead of your fingers.

There are additional sliders in the VCF Section [30-34], but it will be easier to demonstrate their purpose if we first explain what the VCA Section does.

Musical examples of filter action. Shaded areas are NOT audible because they are blocked by the filters. Edge of shaded areas represent filter cutoff point.

HPF & LPF filters wide open.

Fundamental Note Overtones (Harmonics)

HPF completely closed
LPF wide open

No sound gets through.

HPF wide open
LPF partially closed

Upper overtones are eliminated (less bright sound).

HPF partially closed
LPF partially closed

Narrow bandpass effect – Some harmonics only.

HPF wide open
LPF completely closed

Some fundamental may still be heard.

HPF wide open with no resonance
LPF partially closed with maximum resonance

LPF Resonance

Resonance emphasizes the frequency at cutoff.

HPF partially closed
LPF completely closed

No sound gets through (no bandpass).

HPF partially closed with maximum resonance
LPF wide open with no resonance

HPF Resonance

Resonance emphasizes the frequency at cutoff.

HPF partially closed
LPF wide open

Fundamental and lower overtones eliminated.

HPF partially closed with maximum resonance
LPF partially closed with maximum resonance

Narrow bandpass with resonance (move BRILLIANCE [7] for a "wah-wah").

[35-41] **VCA** – The VCA, or Voltage Controlled Amplifier, sets the volume (loudness) of the sound. The reason for using a VCA rather than a volume control, however, is that it automatically changes the volume when you play a note. This is a natural characteristic of any instrument, and is therefore important to the realism or effect of the sounds you program.

Consider the sound of a harpsichord, for example. When you play a note, the strings are plucked, so sound starts at maximum loudness (fast attack) and then falls off (decays) fairly quickly. When you blow into a trombone, the note slowly builds to maximum loudness (slow attack) as the air passes through the many feet of tubing; the sound remains at maximum loudness (high sustain level) as long as you have breath, and then it dies somewhat more quickly than it began as the vibrating column of air collapses (fast release time). These changes in loudness over a period of time are unique for each different instrument and they are known as the amplitude or volume **envelope**. The VCA is used to create an amplitude envelope for whatever sound you have generated with the VCO and modified with the VCF.

[41] **LEVEL** – (Gray) Play a note, and move the VCA LEVEL slider between #10 (maximum) and #0 (minimum). Notice that this is exactly the same as adjusting the CS-80's main VOLUME control [2].

[37-40] **VCA ENVELOPE GENERATOR** – We explained that the VCA is an amplifier that automatically changes the volume; the Envelope Generator (EG) is the circuit that controls the VCA's volume (amplitude) when you play the keyboard. (No sound goes through the envelope generator itself.) The VCA's envelope generator happens to have four independently adjustable characteristics: attack time, decay time, sustain level, and release time. These are set with the **Attack**, **Decay**, **Sustain** and **Release** sliders (A-D-S-R).

[37] **ATTACK** – (Black) **ATTACK TIME** defines how fast the VCA turns on to a maximum volume when you first play a key.

[38] **DECAY** – (Black) **DECAY TIME** defines how long it takes for the VCA to lower the volume as you continue to hold down the key.

[39] **SUSTAIN** – (Black) **SUSTAIN LEVEL** defines how loud the note remains while you continue holding down the key.

[40] **RELEASE** – (Yellow) **RELEASE TIME** defines how quickly the note dies out after you let go of the key.

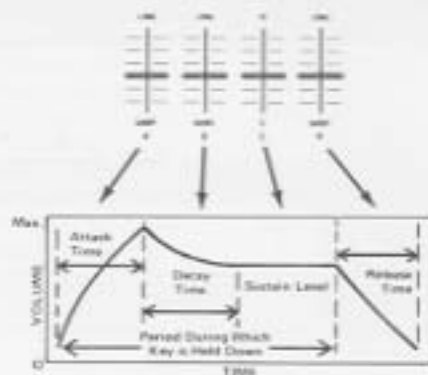
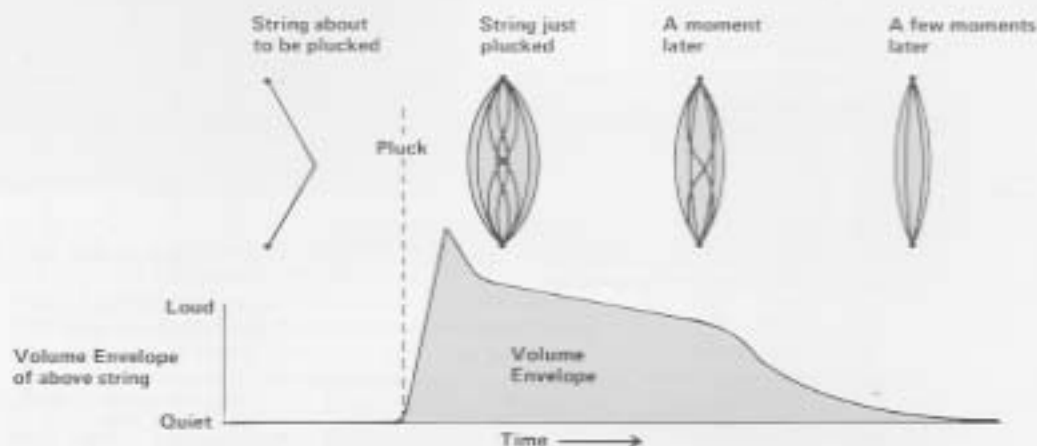
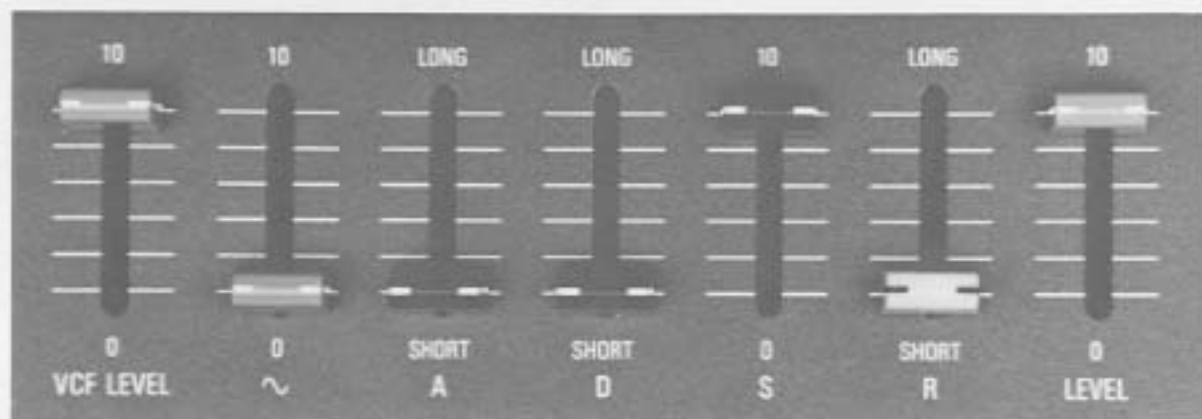

More About VCA Envelopes

It may be easier for some players to understand the envelope in musical terms rather than with graphs or charts. The illustration to the right demonstrates how different settings of the VCA's A, D, S & R levers affect the sound. Play these examples and listen to the effect of each lever. The examples are not intended to sound like any particular instruments.

NOTE: Upper line represents the notes played.
Lower line represents what you hear.

Four VCA lever settings (A, D, S, R) are shown at the top. Below them are two staves of music. The upper staff shows notes with different attack and decay shapes. The lower staff shows the resulting sound envelope, which is a large crescendo.

Four VCA lever settings (A, D, S, R) are shown at the top. Below them are two staves of music. The upper staff shows notes with different attack and decay shapes. The lower staff shows the resulting sound envelope, which is a large decrescendo.

Four VCA lever settings (A, D, S, R) are shown at the top. Below them are two staves of music. The upper staff shows notes with different attack and decay shapes. The lower staff shows the resulting sound envelope, which is a complex shape.

20 [35] **VCF LEVEL** – (Grey) This slider determines how much of the sound generated by the VCO then processed by the VCF will be introduced to the VCA. #0 (down) shuts off all sound from the VCF, and #10 (up) feeds maximum VCF output to the VCA.



No pure sine wave; maximum sound from VCF enters the VCA.



No sound from VCF; pure sine wave enters the VCA.



Blend of sine wave and sound from VCF enters the VCA.

[36] **SINE WAVE** – (Grey) This slider determines how much of the pure, unfiltered sine wave generated by the VCO will be introduced to the VCA. In fact, this slider may be used together with the VCF LEVEL slider to mix pure sine wave with whatever sound is coming from the VCF.

[30-34] **VCF ENVELOPE GENERATOR** – Loudness is not the only thing that can change when you play a note; the tone may also change. When you pluck a guitar string, for example, the sound starts out brilliant and becomes more mellow as the note dies out. To duplicate this effect, it is often desirable to change the filter characteristics as well as the volume with an envelope.

The VCF envelope is similar to the VCA envelope (ADSR), but it affects the tone rather than the volume. Also, instead of ADSR sliders, the VCF envelope has INITIAL LEVEL, ATTACK LEVEL, ATTACK TIME, DECAY TIME and RELEASE TIME sliders (IL-AL-A-D-R).

In essence, the VCF envelope automatically moves the HPF and LPF sliders each time you play a note, thus changing the filter cut off and the amount of harmonics and/or fundamental frequency you hear. The exact effect of the envelope depends entirely on the actual settings of HPF and LPF, as well as RES_H and RES_L.

NOTE: To hear what the VCF envelope controls do as you read the following descriptions, begin by setting up the PANEL (I) as illustrated to the right.

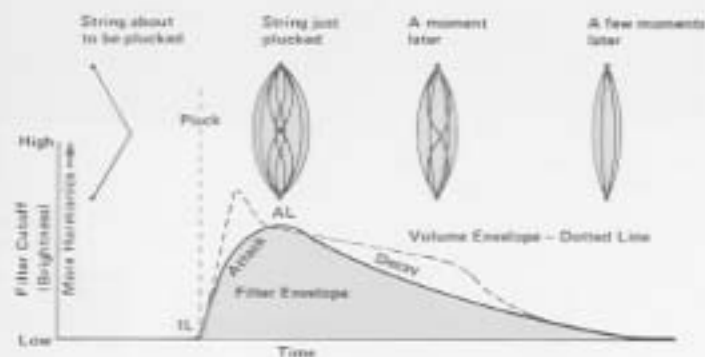

[30] **INITIAL LEVEL** – (Black) With IL set at #0 (down) there is no effect. Moving IL up to -5 and then playing a note causes the sound to start out "mellow" (more fundamental and less harmonics) and to then move into the sound you have set with HPF and LPF sliders. It is as though you began by moving the HPF and LPF sliders a bit lower and then moved them up together as you play the note until they reach the "steady" setting.

Play a note with the controls as below.



What you hear is equivalent to this



When you first hit the key

When you've been holding the key

[31] **ATTACK LEVEL** – (Black) With **AL** set at $\neq 0$ (down) there is no effect. Moving **AL** up to +5 and then playing a note causes the sound to get “thinner” (less fundamental and more harmonics) and to then move back to the sound you have set with the **HPF** and **LPF** sliders. It is as though you moved the **HPF** and **LPF** sliders up past the “steady” setting and then brought them down together.

[32] **ATTACK TIME** – (Black) The **A** slider adjusts how long it takes for the filter envelope to move from the “fattest” sound to the “thinnest” sound (these points being set by the **IL** and/or **AL** sliders). **SHORT** (slider down) causes a fast move that sounds like a “blip,” whereas **LONG** (slider up) causes a gradual change in tone.

[33] **DECAY TIME** – (Black) The **D** slider adjusts how long it takes for the filter envelope to move from the “thinnest” sound to the “steady” sound set with the **HPF** and **LPF** sliders.

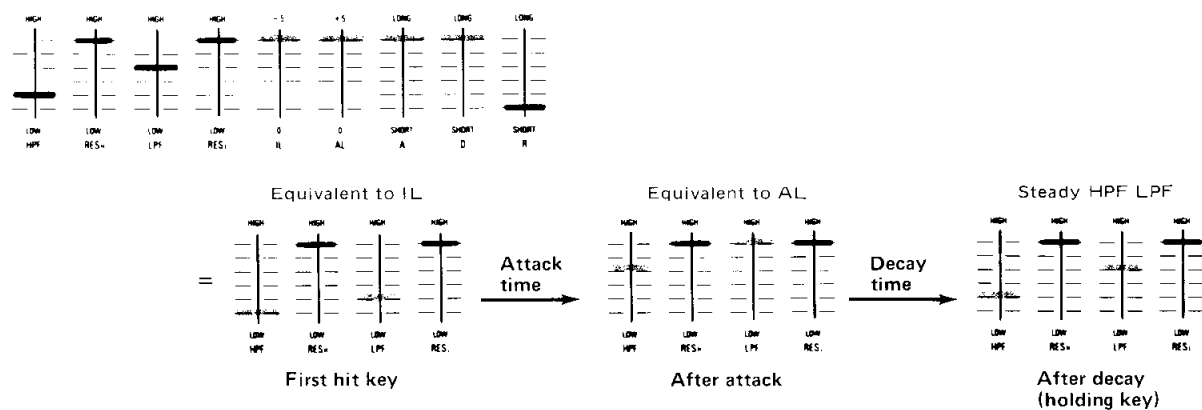
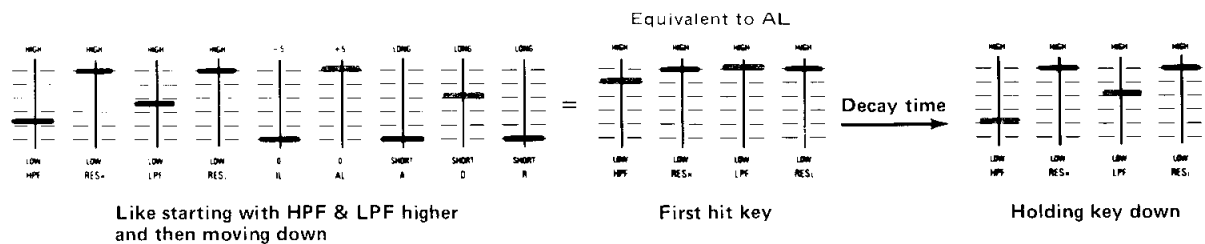

[34] **RELEASE TIME** – (Yellow) The **R** slider adjusts how long it takes for the filter to return to the **IL** setting after you let go of the key or keys. If the **IL** slider is set at $\neq 0$ (down), then **R** sets how long it takes for the filter to return to the “steady” setting after you release the key. If **IL** and **AL** are both at $\neq 0$, then **R** has no effect.

By experimenting with the **VCF** envelope, you will find that many useful effects can be achieved, including whistle and rushing wind. Brass sounds are greatly enhanced by the use of **IL** and **AL** with moderate attack and decay times. To get a very sharp “blip” for extremely percussive sounds, set **AL** up to +5 and set attack and decay at the shortest time (down). You will also find that the **VCF** envelope and **VCA** envelope can be manipulated together to get still more variations in effect.

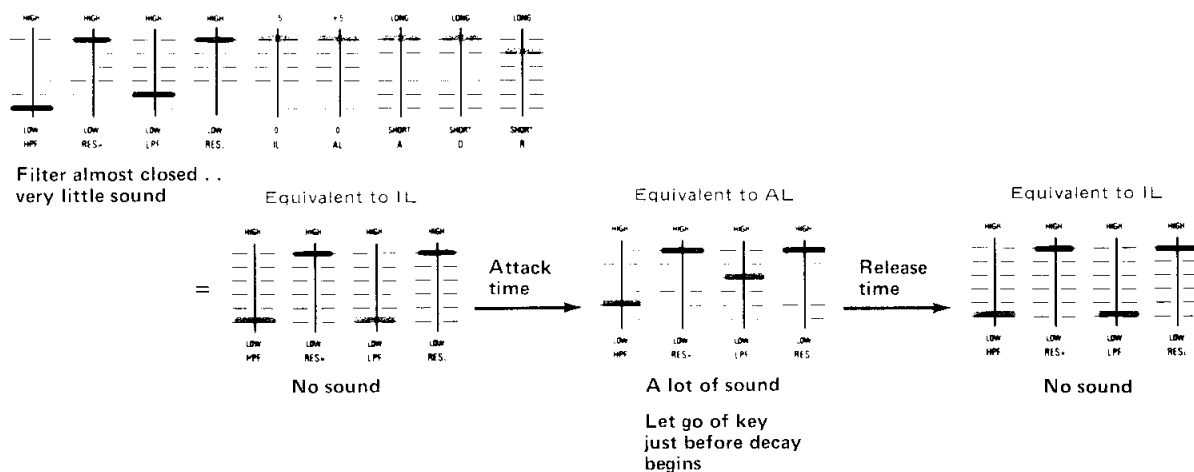

The musical examples provide an alternative to the preceding charts for understanding the VCF envelope. (Switch on the VCO's sawtooth wave when playing the examples.)

NOTE: In these illustrations, hairpins represent changes in filter response, not level. The VCA envelope settings are shown below the VCF settings to save space.

(Continued)

The image shows a musical score with two staves. The top staff is labeled "What you play" and the bottom staff is labeled "What you hear". Above the staves are two sets of control panel diagrams. The left set shows sliders for TOUCH RESPONSE (RES.), INITIAL BRILLIANCE (ILL), INITIAL LEVEL (LEV), AFTER BRILLIANCE (RES.), AFTER LEVEL (LEV), and TOUCH RESPONSE (RES.). The right set shows sliders for TOUCH RESPONSE (RES.), INITIAL BRILLIANCE (ILL), INITIAL LEVEL (LEV), AFTER BRILLIANCE (RES.), AFTER LEVEL (LEV), and TOUCH RESPONSE (RES.). The word "OR" is placed between the two sets of diagrams. Below the staves are several musical symbols, including a double bar line, a fermata, and various note values.

[42-45] **TOUCH RESPONSE** – Touch response (keyboard dynamics) allows you to achieve the ultimate in realistic musical expression. This section allows you to change the **LEVEL** (volume) and the **BRILLIANCE** (harmonics) by playing the keyboard differently. With the sliders down at #0, there is no touch response, while up at #10 the effect is maximum.

INITIAL – “Initial” means that the amount of effect is determined by how fast and hard you **initially** strike the key. **INITIAL BRILLIANCE** [42] makes the notes brighter the harder you hit the key, and **INITIAL LEVEL** [43] makes the notes louder the harder you hit the key.

AFTER – “After” means that the amount of effect is determined by how hard you press a key **after** it hits bottom. Thus, **AFTER BRILLIANCE** [44] and **AFTER LEVEL** [45] are similar to **INITIAL BRILLIANCE** and **LEVEL**, but are sensitive to key pressure rather than key stroke velocity.

Some instruments are not touch sensitive, such as a harpsichord. Thus, you would keep these sliders at minimum to simulate realistic playing. Other instruments change more in level than in tone when you play harder, such as a piano. Still other instruments change as much in tone as in level, such as wind instruments. To simulate tightening the embouchure on a reed, you might use **AFTER BRILLIANCE**.

[46] **MEMORIES** – The memories are beneath a hinged cover which bears a simplified block diagram of the CS-80. (A detailed block diagram and a copy of the simplified block diagram may be found in Section V.)

Memories 1 through 4 are miniaturized versions of programmable panels I & II, minus the detailed labeling. Once you develop a patch you want to save, you can transfer the settings to a memory by visually lining up the memory’s sliders and switches as closely as possible to those on the Panel. “Fine tuning” the memory patch against the panel-programmed patch is easier if you follow this guideline:

1. If you are using **PANEL II**, transfer it to **MEMORY 1** or **2**.
2. If you are using **PANEL I**, transfer it to **MEMORY 3** or **4**.
3. Press the **TONE SELECTOR** buttons [3] corresponding to the **PANEL** and **MEMORY** involved.
4. Compare the two patches by moving the **MIX** lever [4] from I to II.

HOW TO USE PROGRAMMING TO GET A SOUND

If you've read the previous section and experimented with the PANEL controls, you probably understand what they do, but how do you go about programming a specific sound you want to hear?

There are many approaches to getting a sound, and the one we suggest here is no better or worse than others; if another technique works for you, use it. Before you attempt to program a given sound, turn off all effects not on the Programmable panel . . . that is, begin with the nominal settings pictured in the cover illustration.

General Approach

First, think of a sound . . . get it in your mind. Once you "hear" it in your head, you can begin to analyze what basic musical elements make up that sound, and therefore how to set up the same basics with the synthesizer.

Three basic elements make up any musical sound: pitch, timbre and volume. These correspond to the VCO, VCF and VCA sections. If you want to get a sound resembling an acoustic instrument, consider how that instrument generates sound.

What is the basic pitch, the playing range? Use the FEET selector [5] to set the keyboard to an appropriate pitch range.

What is the basic waveform or tone? You set this with the VCO. If the sound resembles woodwinds (reed instruments), use the SQUARE WAVE [23] and try different PULSE WIDTH [22] settings. For strings, add PULSE WIDTH MODULATION [20 & 21] or use SAWTOOTH [24]. SAWTOOTH is also useful for brassy sounds. NOISE [25] alone is good for wind, thunder, sizzle and other special effects. It can be mixed sparingly with other VCO sounds to add breath. Use SINE WAVE [36] for colorless or "pure" sounds.

What is the timbre, the tone color? This is set with the VCF. An "open" sound with lots of harmonics,

like clarinet, suggests the HPF [26] is LOW and the LPF [28] is HIGH. A sound with body but less brilliance, like piano, suggests the HPF is still LOW, but LPF is closed down partially. A very rich, but muted sound, like a string bass, suggests the HPF is still LOW, but LPF is closed down quite a ways toward LOW.

Step-by-Step Examples of Programming

We have presented a handful of patches for you to try, along with very brief explanations of why the controls are set as they are. Because everyone conceives of and plays sounds differently, and because normal component tolerances make it impossible to give "absolute" control settings, you'll want to vary the settings to "fine tune" the sound to your taste. Become aware of what each control does to the patch, and you will soon find that you don't need to write down patches . . . you'll instinctively know how to set all the controls. Remember that the overall BRILLIANCE control [7] and RESONANCE control [8] may be used to further change a patch once it has been set.

NOTE: The patches shown for Strings, Harpsichord, Flute, and other sounds which also appear as Preset Patches are non-identical to the presets. There are many different ways to "get a sound," and the programming examples shown here were chosen because they fall in a logical progression with a minimum change of control settings. Orchestral instruments are used only because they provide a good frame of reference; the CS-80 can be used to make an infinite variety of unique sounds once the basic principles are understood.

NOTE: All panel settings remain unchanged from one patch to the next, unless otherwise noted. Those settings which do change from the previous patch are marked in color on the patch diagrams.

Clarinet

A square wave [23] with 50% pulse width [22] is used because it simulates a single reed instrument by generating odd-order harmonics (3rd, 5th, etc.). The LPF slider [28] should be set so the sound is clarinet-like; wide open would be too bright, and mid way up is about right. VCF envelope [30-34] is used because VCA envelope alone [37-40] would sound too much like a calliope or a keyboard instrument. Moderate VCA envelope Attack [37] and Release [40] times simulate the gradual build up and collapse of the air column in a true clarinet. Vibrato is provided by modulating the VCO with a sine wave in the Sub Oscillator [11]. The VCO lever should first be fully engaged so the maximum effect can be heard while the speed is set. After the desired vibrato speed is achieved, the VCO modulation should be reduced for a more realistic effect (excess vibrato often leads to a synthetic sound). You may wish to advance the Touch Response Section [42-45] Initial or After Brilliance and Level sliders, in which case it is probably a good idea to lower the LPF slider slightly.

Trumpet

Change from square wave to sawtooth wave [24] to include even-order harmonics for a richer sound. The rest of the patch is almost identical to the clarinet, except the VCF envelope's IL [30] and AL [31] sliders are moved all the way up; this starts the filter cutoff at a lower frequency and moves it to a higher frequency than before. The result is a wider change in harmonic content which is more trumpet like. For brass sounds that are "darker" than this trumpet, use slightly longer attack [32 & 37] and release times [34 & 40], and lower the LPF slider [28] somewhat. For more of a coronet or "wah" sound, raise the RESL control [29].

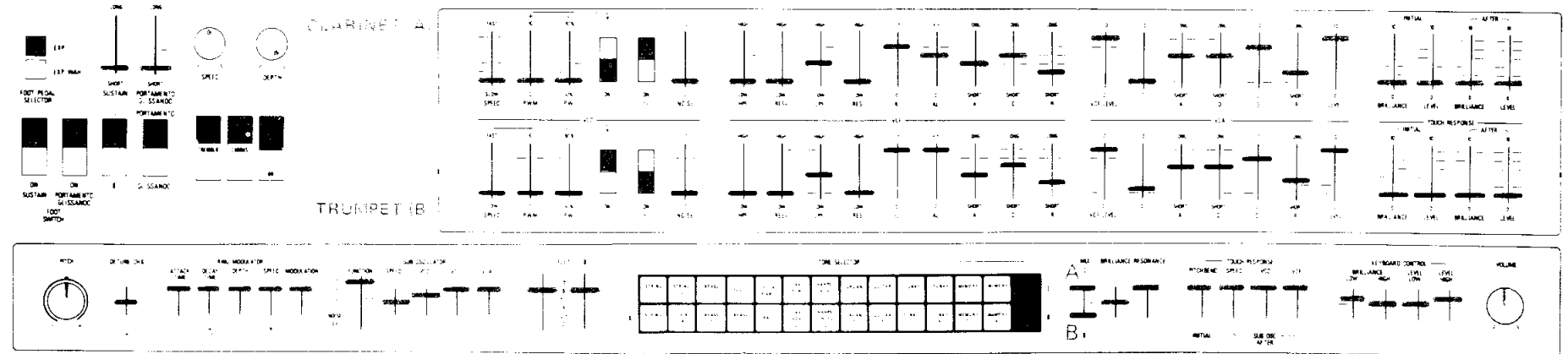

Flute

The sawtooth is still an appropriate waveform, but fewer harmonics are desired, so the LPF slider [28] should be lowered. As harmonics are cut out by lowering the LPF filter cutoff, the waveform actually begins to resemble a sine wave. It is necessary to turn up the overall Volume [2] because much of the sound is being filtered out. VCA envelope is used exclusively, so the IL [30] and AL [31] sliders are lowered all the way to "turn off" the filter envelope (A, D & R then have no effect, and may be left in position for other patches). The major distinction between the trumpet and flute,

other than filter cutoff frequency, is the change in Sub Oscillator modulation [11]; VCO modulation should be greatly reduced or turned off altogether, and instead replaced by VCF modulation.

Another way to program a flute is to completely ignore the VCO and VCF Sections, lower the VCF slider [35] and use sine wave [36] instead. VCA envelope then defines the note exclusively. However, no instrument is quite as perfect as the sine wave, and this patch tends to sound artificial. The quasi-sine wave generated with a heavily filtered sawtooth wave tends to be more realistic.

Solo Violin

This patch is almost identical to the flute patch, with the addition of VCO modulation. Overall tone may be changed somewhat with the Brightness lever [7]. The sub oscillator with sine wave VCF modulation, plus Touch Response VCO, give realistic vibrato only on those notes when it is needed.

NOTE: Consider the foregoing patches and what changes occurred in the sound as relatively few changes were made on the programming panel. Observe that a different waveform or IL-AL setting account for the most dramatic changes.

Oboe

Turn off the sawtooth wave and switch to the square wave [23]. Use 90% pulse width [22] which eliminates specific harmonics, as would be the case with a double-reed instrument. The LPF slider [28] is raised slightly to allow higher harmonics to be heard, and HPF [26] is also raised to obtain a thinner sound by attenuating some of the fundamental frequency (this creates a narrow bandpass). IL and AL [30 & 31] are raised to introduce some filter envelope which simulates tonal changes that occur due to changing embouchure. Some low pass resonance [29] may be added if desired, but AL [31] should then be lowered to avoid a "wah" sound.

Multiple Strings

Temporarily turn off the Sub Oscillator VCF modulation [11] and Touch Response VCO [12] so that the rate of pulse width modulation can be easily heard. Reduce the pulse width [22] to about 70%, and set pulse width modulation [21] at maximum so that the speed [20] can be determined. Once the speed is set, reduce the amount of PWM to taste. Now vibrato can be reintroduced by means of the sub oscillator VCO lever [11]. The mixture of these two types of modulation, PWM and sub oscillator VCO, give the effect of more than one instrument playing. For even richer strings, repeat this same patch on the second panel, setting one panel's Feet slider [5] at 16' and the other at 8', and detuning channel II slightly [6]. On the channel set at 16', the amount of PWM [21] and its speed [20] should be lowered because lower pitched strings do not have as much modulation as shorter strings. The VCF and VCA attack times [32 & 37] and release times [34 & 40] are lengthened to simulate the bowing of strings as opposed to the quicker initiation of sound in an oboe.

OBOE (A)

MULTIPLE STRINGS (B)

Clavichord

Lower the PWM slider [21] all the way, and raise the pulse width to 90% [22]. Remove all sub oscillator modulation. VCF and VCA envelope Attack times [32 & 37] are both set at minimum for a plucked sound. While either VCF or VCA attack could be used alone, together they provide a more natural sound, simulating the change in harmonics that occurs as a string is plucked and then settles down (VCA envelope alone sounds more synthetic). Resonance [29] may be added, but the AL should then be lowered somewhat to avoid a "wah" sound.

Bells & Gongs

Move the pulse width [22] back to 50%, and fully engage the Ring Modulator [16] Speed and Modulation controls. If desired, add sub oscillator [11] modulation of the VCA, and/or Chorus [15]; with Chorus, use only moderate Depth. For bells, the Feet selector [5] should be set at a higher pitch, 4' or above; 8' or below is useful for gong sounds (Brilliance [7] should also be adjusted for gongs).

NOTE: In the last four patches, the filter cutoff settings have remained approximately the same (band-pass filter). The vast majority of changes in sound were due to changes in square wave duty cycle (pulse width) and in envelope settings.

CLAVICHORD (A)

BELLS & GONGS (B)

Timpani

Two voices are used at once for this patch (and the next one), so program panels I and II. Panel I is for the initial "mallet" sound. Instead of the waveform used in bells above, turn off square and sawtooth, and use only Noise [25]. The Ring Modulator [16] should also be turned off. HPF and LPF [26 & 28] are set to give a narrower bandpass, and AL [3] is lowered to avoid letting the sound get too thin. The VCF and VCA Release time [34 & 40] are longer, and VCA Sustain level [39] is lowered to simulate the die away of the mallet sound. Panel II is used for the "drum" sound. Sine wave [36], sawtooth [24] and a square wave [23] are used together, and the square wave is set at

75% pulse width [22] with moderate pulse width modulation [21] at a slow speed [20]; the several waveforms give a richer sound, with the sine wave emphasizing the fundamental. Set Feet II [5] at 16' (the Noise in Panel I is not affected by the Feet setting). The filter cutoffs are the same as Panel I, but resonance is added and the VCF envelope is changed. The entire VCA envelope is different, since the head resonates long after the mallet is gone. The addition of sub oscillator VCA modulation [11] to the pulse width modulation on Panel II emulates the reverberant sound of the drum body. This 2-voice effect could be simulated with just one channel.

Pizzicato & Legato

This patch simulates the effect of one instrument playing quickly (pizzicato) using fast attack and decay times, and of a second instrument playing slowly (legato) using slower attack and decay times. The

patches can be seen clearly on the diagram. Observe that Panel II uses sine wave [36] and VCA exclusively. Notice when you play that quick key strokes give a "plucked" sound, and holding keys down longer a second, completely different voice to develop.

USING THE PROGRAMMABLE PANELS TO DUPLICATE THE PRESET PATCHES

As stated elsewhere in this manual, the preset patches were all derived from settings of the programmable panels. Normally, there would be no need to duplicate the presets by programming the panels. However, setting up the panels to emulate the presets can serve as a good point of departure for developing your own patches.

The following diagrams of programmable panel settings correspond to the 22 preset patches. Some settings are very critical, and a slight change of adjustment can make the difference between a poor match or a perfect match with the equivalent preset's sound. The fine tuning of controls necessary to match the preset is very relevant to making your own entirely unique patches because you experience how to subtly manipulate the controls for specific effects.

Bear in mind that there are several ways to "A-B" compare the presets to the sounds you program. For greatest accuracy, we suggest using the panel which is on the same channel as the preset you wish to duplicate. For instance, if you want to program the Flute, use the Channel I panel; for Bass, use Channel II, etc. This means that the same 8 oscillators, filters and envelope generators will be producing the sound. If you use a Channel I preset with a Channel II panel,

or vice-versa, a completely different set of oscillators, filters and envelope generators are creating each sound.

A few patches are more difficult to fine-tune than the others, due to a combination of a critical pulse width adjustment, HPF and LPF settings that yield a bandpass filter, and VCF envelope. The "tricky" patches are: Clavichord 1, Guitar 1 & 2, and Funky 1 & 3; it is probably a good idea to return to these after you have worked through the other patches.

1. Tune the patches using the middle of the keyboard (FEET selector [5] at 8'). This allows you to hear the fullest spectrum of overtones for more accurate adjustments.
2. If the setting involves adjustment of Pulse Width [22], first adjust that control for the closest sound match.
3. Adjust the filter settings [26-29]: LPF, HPF, RESL and RESH. Press the keys slowly and lightly so that any Touch Response effects do not commence. (NOTE: If VCF envelope [30-34] is in use, also see Step 4 below.) If Touch Response After-Level [44] and After-Brilliance [45] are used, press the keyboard lightly when first setting the filter. Then press the keys harder and set After-Level and After-Brilliance accordingly. It may then be necessary to retouch the filter settings.

4. If VCF envelope (IL and/or AL) is in use, hold down a key until the filter settles to a steady, unchanging cutoff. Then adjust the filter LPF [28] and HPF [26] controls.
5. If VCF AL [31] is used alone without IL, adjust it to produce the brightest sound obtained in that patch; then readjust the LPF [28] and HPF [26] sliders as required.
6. If Initial-Brilliance [42] and Initial-Level [43] are used, strike the keys quickly to determine whether the effects are identical in the preset and programmed patch; adjust as required.
7. If the program and panel patches are the same, then they should react identically to exaggerated settings of the overall Brilliance [7] and Resonance [8] controls. One at a time, set these two controls all the way up, and all the way down, comparing the patches. If differences in sound are observed at extreme settings, adjust the corresponding controls on the Panel to re-match the preset and programmed sounds: RESH and/or RESL at extreme Resonance settings; HPF and/or LPF at extreme Brilliance settings.

STRING 1

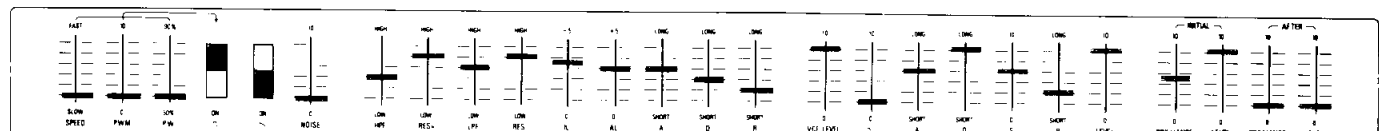

STRING 2

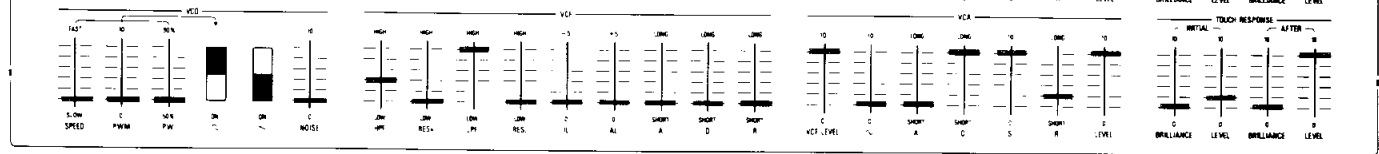

STRING 3

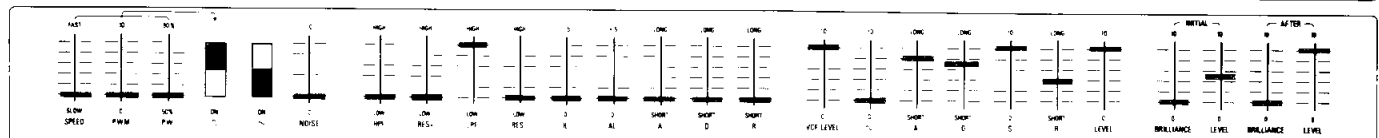

STRING 4

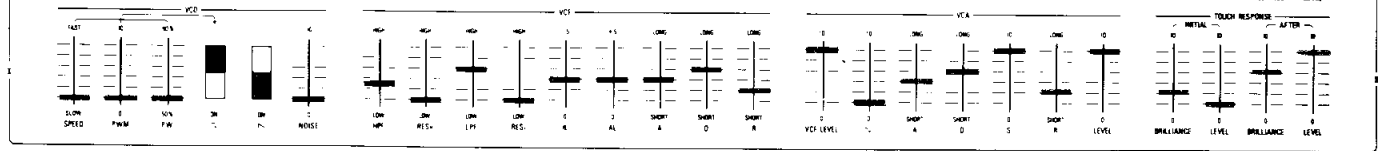

Sections II & III provide adequate information to understand all CS-80 controls and functions. You need not read this section to know how to play your synthesizer. However, Section IV does offer alternative and more comprehensive explanations for the benefit of experienced synthesists.

Overall Picture

The CS-80 is an eight note polyphonic synthesizer. However, there are really 16 main oscillators divided into two ranks (two channels), both of which are operated simultaneously by the keyboard. When you play one key, two voices are always generated, and a mix control then lets you select any blend of the two voices to feed the mono (General) output. A phasing-type tremolo/chorus circuit splits the General output and feeds it to two different jacks, Left and Right, for rotary speaker effects. Each channel contains eleven factory preset patches, one programmable panel and two miniature versions of the panel that serve as memories for additional voices you wish to store. Thus, when you have programmed the panels and memories, you can select from 28 basically different sounds at the touch of a finger.

The keyboard, and all controls other than the programmable panels and memories, affect both channels simultaneously.

The Programmable Panels

Since PANEL I and PANEL II [20-45] are identical, we use both in the following examples. By moving the MIX lever [4] between I to II, you can quickly hear the differences in similar patches programmed on PANEL I and II. If you wish to hear what the PANEL controls do as you read about them, set the MIX control [4] at the I or II (depending on which PANEL you are using), press the PANEL buttons on the Tone Selector [3], turn up the VOLUME [2], and be sure the FOOT CONTROLLER is flat (maximum volume).

NOTE: Before starting, it is advisable to set all other controls at their nominal positions, as shown, because many controls and functions are interrelated.



VCO (Voltage Controlled Oscillator)

[20] **SPEED** – Adjusts the rate of pulse width modulation of the square wave, provided the PWM lever is moved away from its “0” position.

[21] **PWM** – Adjusts the depth of Pulse Width Modulation (the deviation in square wave duty cycle). A “0” setting yields no modulation.

[22] **PW** – Sets the basic duty cycle of the square wave from a symmetrical wave (50%) to a narrow pulse (90%).

[23] **SQUARE WAVE** – Turns ON the square wave generating circuits when the switch is rocked forward.

[24] **SAWTOOTH WAVE** – Turns ON the sawtooth wave generating circuits when the switch is rocked forward.

[25] **NOISE** – Introduces white noise into the VCO output as the slider is moved up (#10 is maximum noise).

NOTE: The numbers above the notation to the right indicate the overtone number. All notes (except pure sine wave notes) have overtones which are not heard separately, but which give the note its tonal character. The first overtone is the second harmonic of the fundamental (i.e., twice its frequency), etc. To hear the individual overtones, set RES_H [27], RES_L [29] and RESONANCE [8] at maximum, and gradually move LPF [28] down.

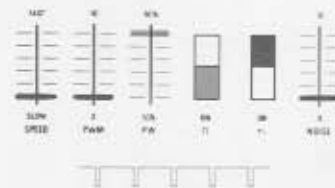

90% Square Wave Pulse Width

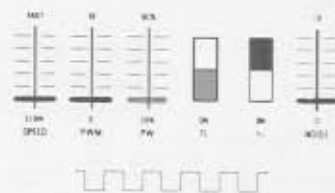

50% Square Wave Pulse Width

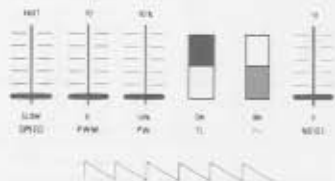

Sawtooth Wave



Noise

*NOTE: The fundamental (C) is the note played, and the smaller notation to the right suggest the harmonics (overtones) of that note, all of which are simultaneously generated by the VCO.

VCF (Voltage Controlled Filter)

[26] **HPF** – Sets the cutoff point of the High Pass Filter (low cut filter). With the slider at **LOW**, the cut-off frequency is lowest (filter wide open), and at **HIGH** the cutoff frequency is highest (filter closed).

[27] **RES_H** – Sets the Resonance (Q) at the cutoff point of the High Pass Filter. The **HIGH** setting gives maximum resonance.

[28] **LPF** – Sets the cutoff point of the Low Pass Filter (high cut filter). With the slider at **LOW**, the cut-off frequency is lowest (filter closed), and at **HIGH** the cutoff frequency is highest (filter wide open).

[29] **RES_L** – Sets the Resonance (Q) at the cutoff point of the Low Pass Filter. The **HIGH** setting gives maximum resonance.

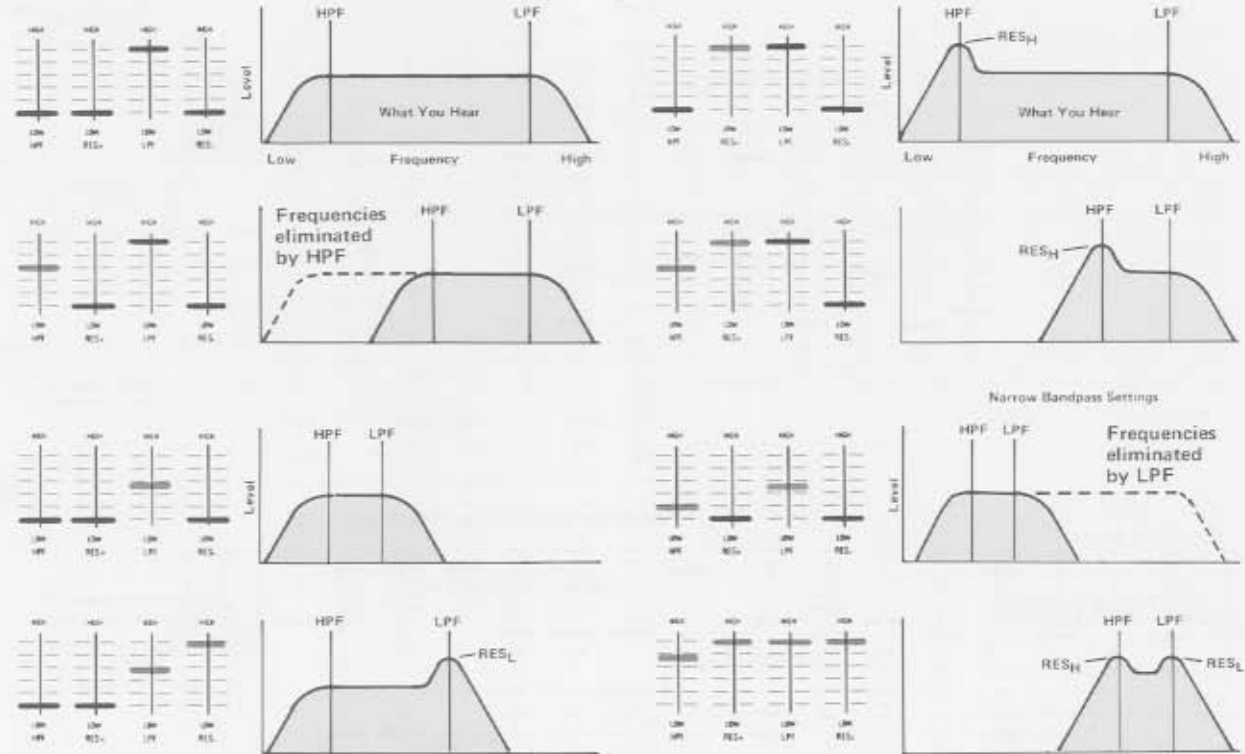

VCF Envelope Generator

NOTE: Yamaha's filter envelope generator, with "IL-AL-A-D-R," is unique among synthesizers.

[30] **IL** – (Initial Level) Lowers the initial filter cut-off points of the high pass and low pass filters (when a note is first played) relative to the "steady" levels set with the HPF and LPF sliders. Moving IL up toward "5" is like starting with HPF and LPF lower than their sustained cutoff points and then moving them together to their sustained levels.

[31] **AL** – (Attack Level) Raises the filter cutoff points when a note is first played. The AL rise occurs while you hold a key down, beginning from the "steady" cutoffs set with the HPF and LPF sliders, going to the maximum frequency set with AL slider, and then returning to the "steady" cutoffs.

[32] **A** – (Attack Time) Adjusts how long it takes for the filters to move from the minimum IL to the maximum AL cutoff frequencies when either or both of these sliders is moved up from "0". Attack Time has no effect if IL and AL are both at "0".

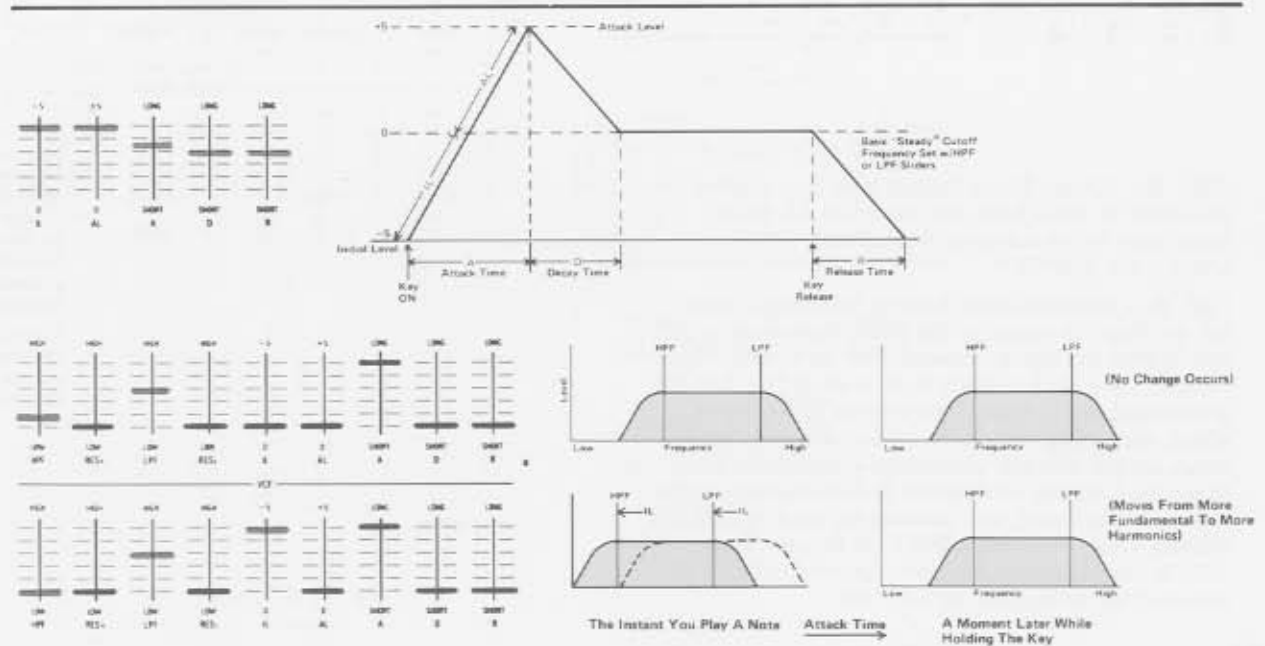

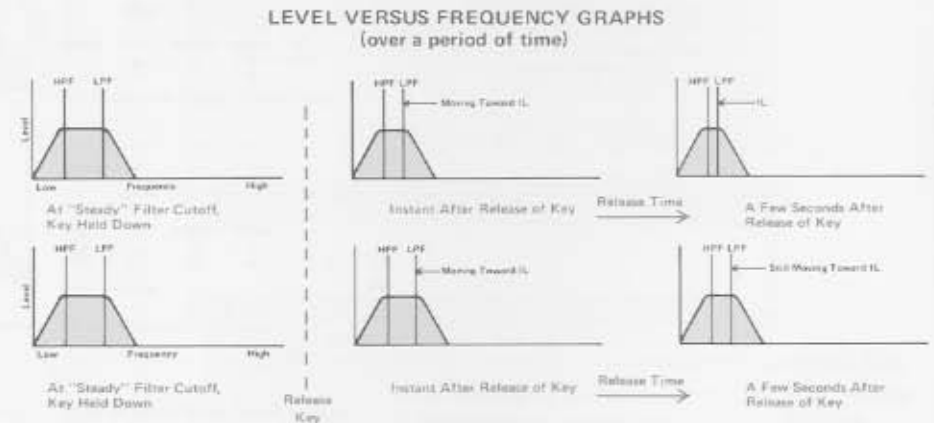
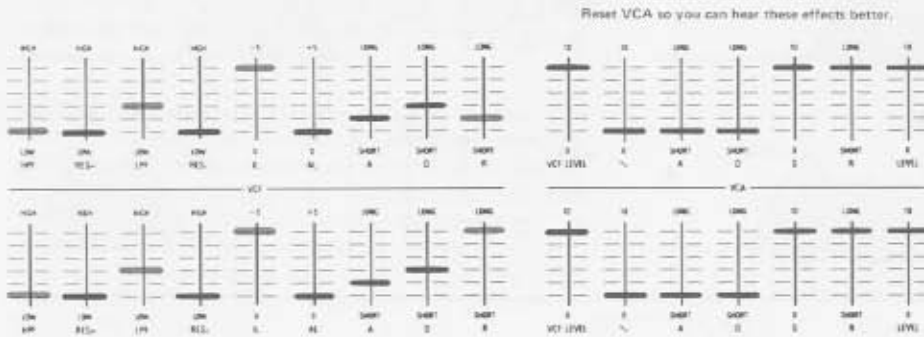
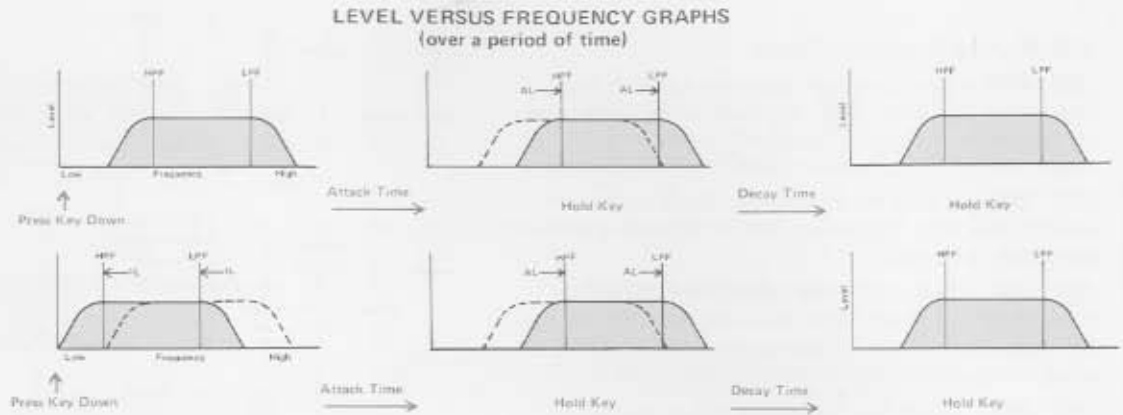
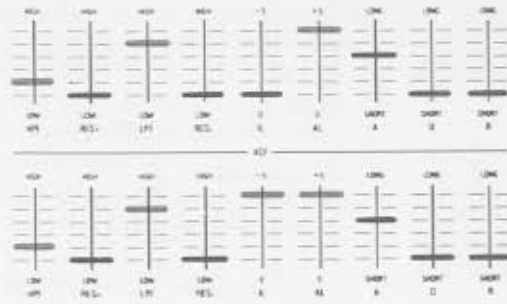

[33] **D** – (Decay Time) Adjusts how long it takes for the filters to move from the maximum AL cutoff point back to the sustained level. Decay Time has no effect if AL is at “0.”

[34] **R** – (Release Time) Adjusts how long it takes for the filters to return to the set IL frequency cutoff points after the key is released. With no IL and AL, Release Time has no effect. If IL is set at “0,” but AL is provided, the Release Time setting may have an effect, depending on how fast the attack and decay times are and whether you release a key before the filters have already settled into their sustained cutoffs. (Note: In any event, you cannot hear the effect of this Release Time slider unless the VCA Release Time [40] is relatively long also, or unless a long Sustain is provided by the Sustain section [13].

Play a series of rapid staccato notes and several long chords for each of these patches.

NOTE: In the lower illustrations, the HPF slider is wide open, so the lower filter cutoff (shown by the HPF lines) cannot move any lower. Therefore, only the upper cutoff (shown by the LPF lines) moves, the rate of motion being determined by the release time.

From left to right the graphs are only a few samples of filter characteristics at specific times; relative to release of the key. The filter changes actually occur gradually.

VCA (Voltage Controlled Amplifier)

[35] **VCF LEVEL** – Adjusts the amount of input to the the VCA provided by the VCO's square wave, sawtooth wave and/or noise generators and filtered by the VCF.

[36] **SINE WAVE LEVEL** – Adjusts the amount of input to the VCA provided by the VCO's sine wave generator. Since the sine wave does not go through the VCF, it may be mixed in any proportion with the VCF-processed signals as it enters the VCA.

[37] **A** – (Attack Time) adjusts how long it takes for the level to increase to a maximum each time a note is played.

[38] **D** – (Decay Time) Adjusts how long it takes for the level to decrease from a maximum to a steady (sustained) level each time a note is played.

[39] **S** – (Sustain Level) Adjusts the fixed level of a note that is steady (after attack and decay) so long as a key is held down.

[40] **R** – (Release Time) Adjusts how long it takes for the level to die to silence after you release a key. The effect is like the sustain time provided by the controls in [13].

[41] **LEVEL** – (VCA Level) Sets the highest level attained by the VCA, thus affecting the sustain level and the maximum attack level. If VCF LEVEL [35] and SINE WAVE LEVEL [36] are thought of as input mixing controls, then this slider serves as the VCA's master output control.

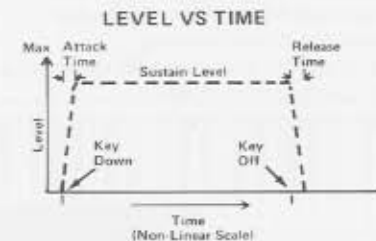
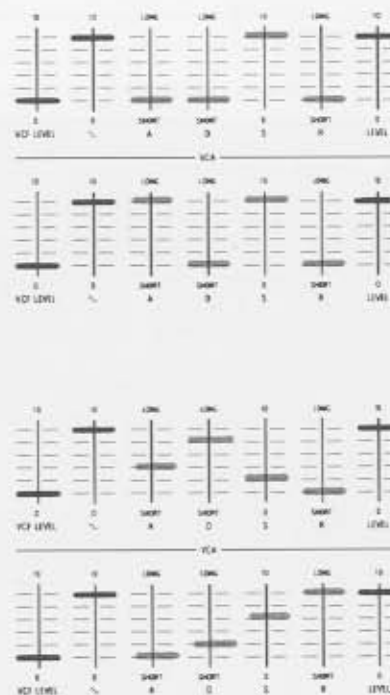
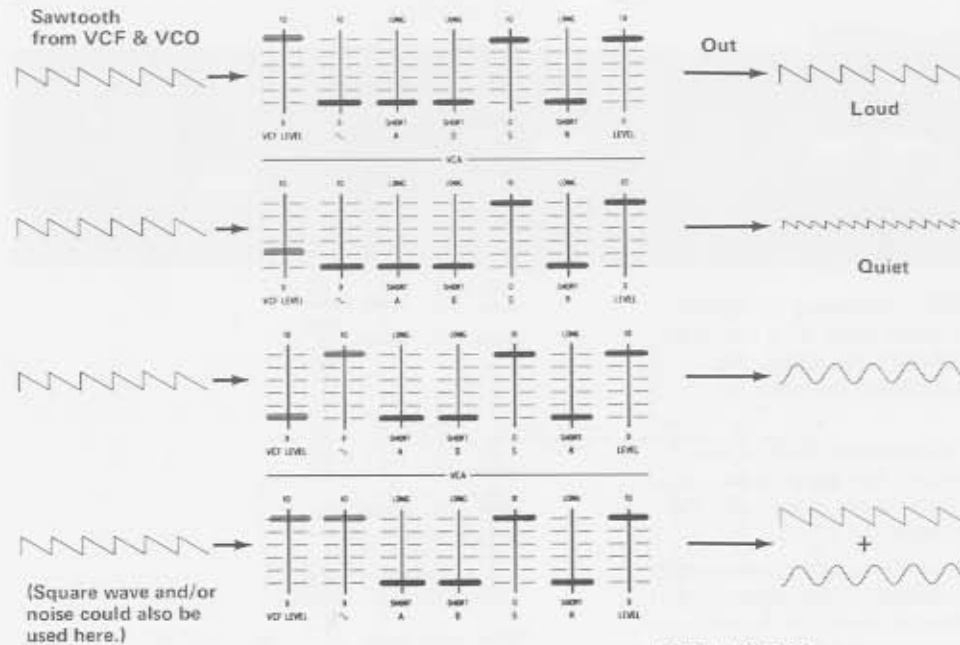

Note: Maximum level set by Sustain & Level

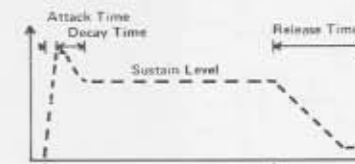
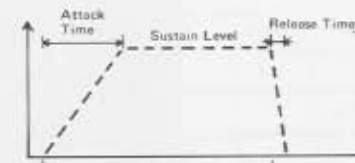

Touch Response (Keyboard Dynamics)

[42] **INITIAL-BRILLIANCE** — Increases the brightness of any note when you play harder; the faster you strike a key initially, the brighter the note. Raising the slider increases the effect.

[43] **INITIAL-LEVEL** — Increases the level of any note when you play harder; the faster you strike a key initially, the louder the note. Raising the slider increases the effect.

[44] **AFTER-BRILLIANCE** — Increases the brightness of any note when you press down on a key after it hits bottom; the more pressure you apply, the brighter the note. Raising the slider increases the effect.

[45] **AFTER-LEVEL** — Increases the level of any note when you press down on a key after it hits bottom; the more pressure you apply, the louder the note. Raising the slider increases the effect.

[46] **MEMORIES 1-4** — Four miniaturized versions of the same controls found in Programmable Panels I & II may be used to patch additional sounds or to keep favorite patches protected from accidental lever movements. To hear a Memory, press the corresponding Memory Tone Selector [3] and set the MIX lever [4] accordingly. You can transfer patches from PANEL to MEMORY by eye, and then "fine tune" the memory by ear.

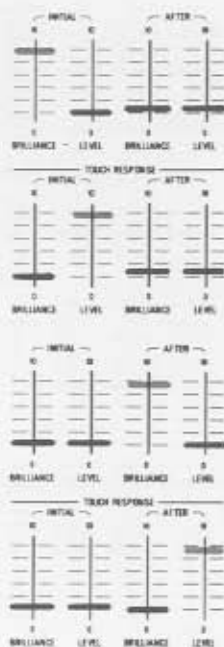

Access to the Memories using the Tone Selector Buttons and the Mix Lever

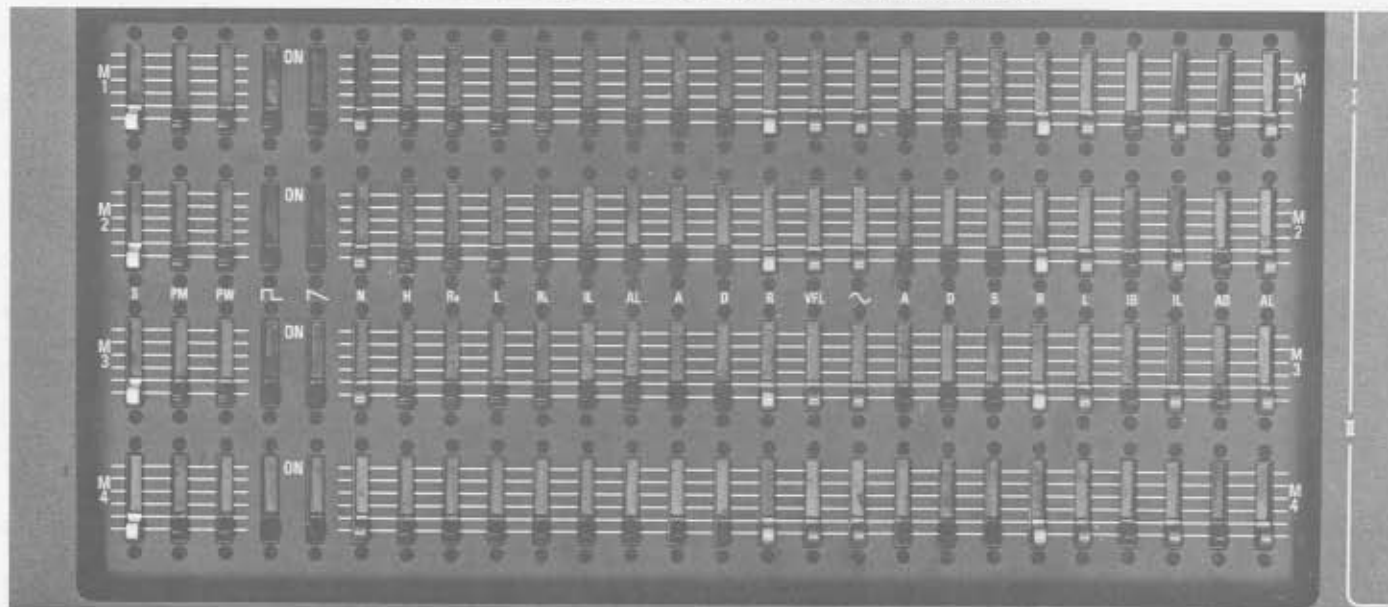
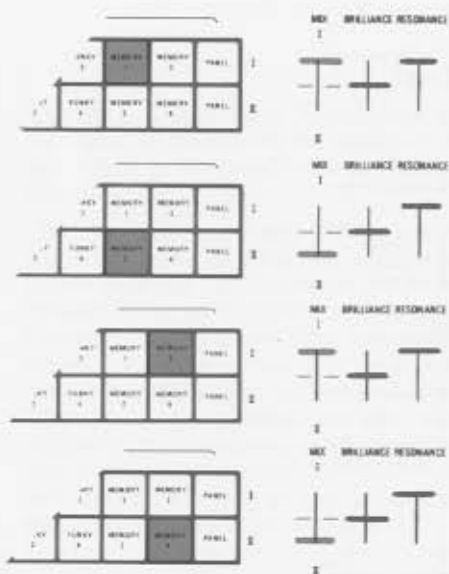

Other Selectors & Sound Modifiers
(from Left to Right)

[18] **PITCH** – Tunes the entire keyboard. The outer ring is a coarse adjustment, the inner ring a fine adjustment. Center both controls for “normal” pitch.

[6] **DETUNE CH II** – Detunes channel II sharp or flat with respect to channel I.

[16] **RING MODULATOR** – Processes both channels I and II. **MODULATION** is a depth of effect control, **SPEED** sets the modulation rate. **ATTACK TIME** & **DECAY TIME** serve as an attack-release envelope for the ring modulation speed; **DEPTH** sets the amount of envelope effect.

[11] **SUB OSCILLATOR** – Processes both channels I and II. **FUNCTION** selects a waveform: sine, sawtooth, inverted sawtooth, square wave, white noise, or an external input. (A line level signal connected to the Ext In jack on the rear panel will modulate the Sub Oscillator in EXT mode). **SPEED** sets the frequency of the sine, sawtooth or square wave. **VCO**, **VCF** and **VCA** are modulation depth controls that apply the selected signal to the control inputs of their respective voltage controlled circuits (oscillator, filter and/or amplifier).

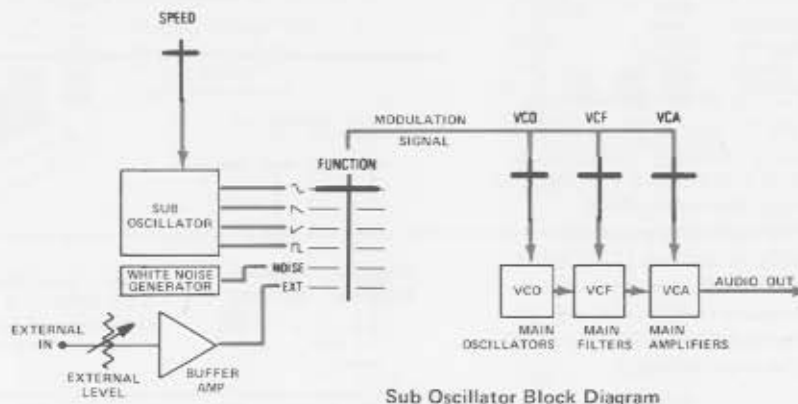

[5] **I – FEET – II** – Two slide switches set the keyboard range for their respective channels, row I and II of the Tone Selectors [3]. Feet refers to equivalent organ footages, where 8' is normal pitch, 16' an octave below, 5-1/3' a perfect fifth above, etc.



Set PITCH & FEET as shown for true middle “C”.

[3] **TONE SELECTOR** – Two rows of momentary pushbutton switches select two voices that sound simultaneously when you play any key (the MIX control [4] sets the balance between the two voices). Preset patches, memory-programmed patches or panel-programmed patches may be selected. The buttons light up to show which voices have been selected; only one voice per row at any one time. (Preset sound quality depends largely on the setting of the BRILLIANCE lever [7].)

[4] **I – MIX – II** – Assigns tones selected in channel I, II or a combination of the two, to the synthesizer output: a balance or blend control.



[7] **BRILLIANCE** — Adds voltage to the VCF's high pass and low pass control inputs, thus shifting up the cutoff frequencies and brightening the sound as the lever is pulled down. Nominal setting is centered, but there is a considerable change in sound when you adjust this for different patches.

[8] **RESONANCE** — Adds voltage to the VCF's resonance control inputs, thus increasing the resonance and adding twang as the lever is pulled down. Nominal setting is always with the lever up for minimum additional resonance.



Moving Brilliance Up (minimum) is like moving HPF & LPF Down (& vice-versa) for preset or programmed patches.

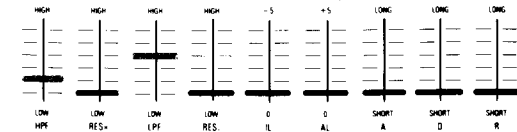

Moving Resonance Down (maximum) is like moving RES_H & RES_L Up for preset or programmed patches.

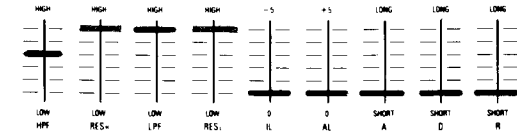

[12] **TOUCH RESPONSE** — The PITCHBEND lever, when pulled down, causes the VCO to begin at a lower pitch and slide up to the note played. PITCHBEND is velocity sensitive, so the faster you strike a key initially, and the farther down the lever, the more effect. SPEED, VCO and VCF do the same thing as their counterparts in the Sub Oscillator section [11], using its set FUNCTION and basic SPEED. However, these levers make the keyboard pressure sensitive so the farther down you pull a lever and the harder you press a key after it hits bottom, the more effect.

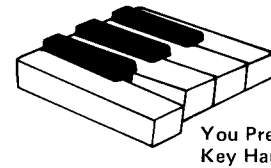
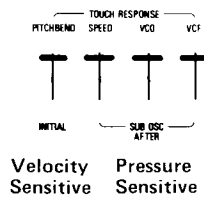

Moving down the "after" levers (Speed, VCO or VCF) is like moving down the same levers in Sub oscillator when you press hard on a key.

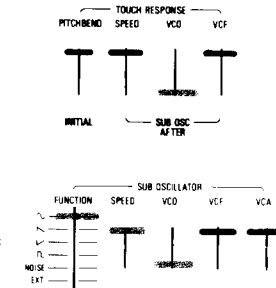

[2] **VOLUME** — This is the main volume control that sets the level of all three CS-80 outputs (Left, Right & General). Overall volume is also affected by the rear-panel HIGH/LOW switch and the FOOT PEDAL (Expression Controller).

[9] **KEYBOARD CONTROL-BRILLIANCE** — The LOW and HIGH levers separately adjust the brilliance of the lower and upper sections of the keyboard (by subtracting from or adding to the voltage applied to the HPF and LPF control inputs in the VCF). Instead of a "split keyboard," the levers gradually add or subtract increasing amounts of brightness as you approach the ends of the keyboard (levers are centered at nominal position). Use in conjunction with the overall BRILLIANCE control [7] to balance the timbre.

[10] **KEYBOARD CONTROL-LEVEL** — The LOW and HIGH levers separately adjust the volume of the lower and upper sections of the keyboard. The function is similar to the adjacent BRILLIANCE LOW & HIGH levers, except these levers are used to balance the volume across the keyboard.

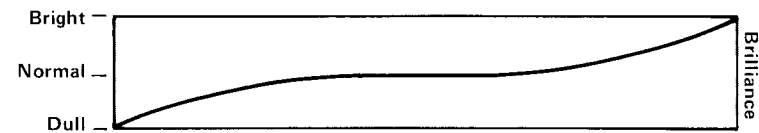
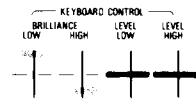

Color shows adjustment range, solid line shows actual setting.

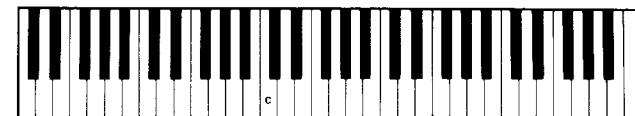
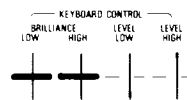
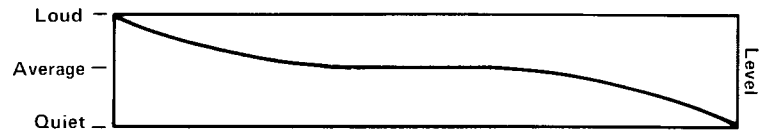

[17] **FOOT PEDAL SELECTOR** – Pushbuttons select what function the foot pedal (controller) will play. EXP makes it an expression pedal that adjusts the volume. EXP/WAH makes it an expression/wah-wah pedal that simultaneously adjusts the volume and sweeps the HPF & LPF cutoff points while adding resonance.

[13] **SUSTAIN SECTION** – The SUSTAIN slider adjusts the die-away of a note after you release a key (maximum of about 10 seconds). The SUSTAIN FOOT SWITCH assigner, rocked forward (ON), enables you to turn sustain ON & OFF with the Foot Switch; rocked back sustain is always ON. (If the Foot Switch is not plugged in, sustain is always ON regardless of the assigner switch setting). SUSTAIN I-II selects the type of sustain and **has no relationship to channels I & II**; I sustains each note individually and II ends the sustain of previous notes each time a new note or chord is played.

[14] **PORTAMENTO/GLISSANDO SECTION** – The PORTAMENTO/GLISSANDO (P/G) slider adjusts length of time it takes to change pitch from the previously played note or chord to the next. The P/G FOOT SWITCH assigner, rocked forward (ON), enables you to turn the effect ON & OFF with the Foot Switch; rocked back P/G is always ON. (If the Foot Switch is not plugged in, P/G is always ON regardless of the assigner switch setting). PORTAMENTO/GLISSANDO changes the way the frequency moves between notes; PORTAMENTO is a continuous slide, whereas GLISSANDO is a series of discrete, half-step notes (like a chromatic scale). GLISSANDO stops when you let go of a key unless you have selected SUSTAIN II mode, in which case the effect continues until the note dies away.

[15] **TREMOLO SECTION** – The ON/OFF switch activates whatever effect is preset with the two adjacent switches; CHORUS is a slower version of TREMOLO. Either effect may be varied in rate using the SPEED control, or in amount of modulation using the DEPTH control. There is a phasing as well as an amplitude modulation which, when used with the CS-80's LEFT and RIGHT outputs, is similar to a "rotary speaker" effect. (The CS-80 output level drops slightly when you turn ON this section.)

THE KEYBOARD – Is pressure and velocity sensitive, depending on the nature of the preset patch selected, and on the setting of the TOUCH RESPONSE sections [12] and [42-44].

[1] **POWER** – Switches the AC power. A red light in the switch is illuminated when power is ON.

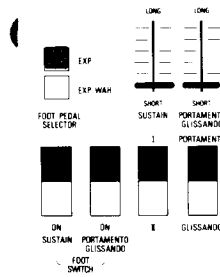

Foot controller is now an EXPression pedal.

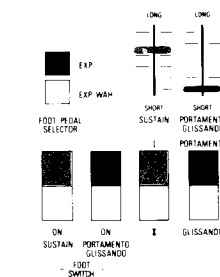

Sustain is now "ON" regardless of foot switch position. (No Portamento)

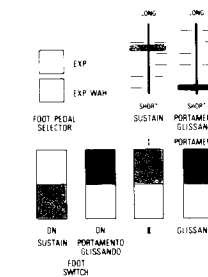

Sustain is "ON" only when foot switch is down. (No Portamento)

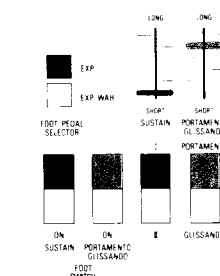

Portamento is now "ON" regardless of foot switch position. (No Sustain)

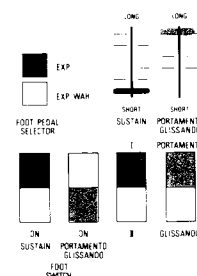

Portamento is now "ON" only when foot switch is down. (No Sustain)

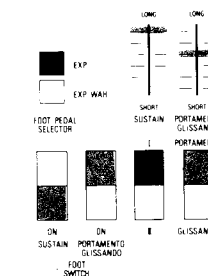

Sustain now turns "ON" when foot switch is down, while Portamento remains "ON".

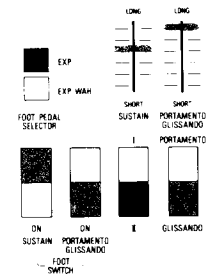

Glissando now turns "ON" when foot switch is down, while Sustain remains "ON". (NOTE: In II Mode, with Sustain, Glissando continues after you release the key.)

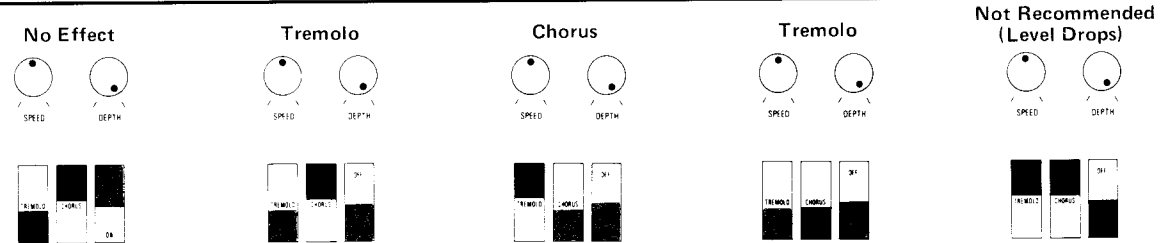

No Effect

Tremolo

Chorus

Tremolo

Not Recommended (Level Drops)

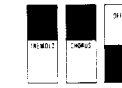
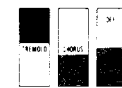
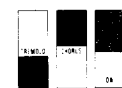
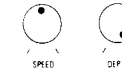
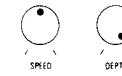
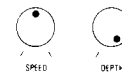
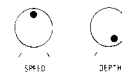
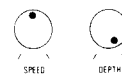

This section first deals with several basic conceptual questions about synthesizers. While we have distilled the information as much as possible, some topics have philosophical or complex origins that do not lend themselves to simple explanations. The balance of the section provides an overview of how the CS-80 operates, much of which can also apply to other synthesizers.

What is a Synthesizer

A synthesizer is an audio processor that has a built-in sound generator (oscillator), and that alters the envelope of the sound with voltage controlled circuitry.

Synthesizers can produce familiar sounds and serve as musical instruments, or they can create many unique sounds and effects of their own. The synthesizer operates by creating each basic element of sound and then providing you with separate controls for each element.

You don't have to use all the many controls on the synthesizer to create a complete sound. In fact, often only a handful of the available controls need be used, depending on the sound you wish to achieve.

The Difference Between Synthesizers & Electric Organs

An electric organ offers a wide variety of preset sounds at the touch of a finger. Synthesizers usually offer no presets, or very few of them, instead providing an infinite variety of adjustable sounds. The CS-50, CS-60 and CS-80 offer many presets and infinitely adjustable sounds as well.

Organs utilize different means to generate sound than do synthesizers. Because of this, most organs are polyphonic, meaning that you can play many notes simultaneously, whereas most conventional synthesizers allow you to play only one note at a time. The CS-Synthesizers, however, incorporate additional circuitry that allows you to play several notes at a time (4 on the CS-50 and 8 on the CS-60 and CS-80).

Why Use a Synthesizer

Many of the sounds that can be created with a synthesizer would be either impossible or highly impractical to create with acoustic instruments. Also, the synthesizer can give you common acoustic sounds with much greater convenience than would otherwise be possible. For instance, you can adjust the controls to "stretch" a common instrument, like gradually transforming a piccolo to a Bass flute, or even to a 20' long flute, if there were such a thing. Similarly, the synthesizer allows instant or gradual transitions from the sound of one instrument to another.

The Elements of a Synthesizer

One section, the VCO, establishes the pitch or frequency of the note, as well as the basic tone (timbre). Another section, the VCF, shapes the tone or emphasizes portions of it. Another section, the VCA, affects the loudness of the notes. Either the VCF, the VCA, or both may be used to "turn on" and "turn off" the sound in a controlled pattern, forming the notes as you play the keyboard. The control that forms the notes is provided by Envelope Generators (EG), one for the VCA and one for the VCF. The synthesizer also houses many other functions to modify the basic sounds for a variety of effects.

Yamaha CS-series synthesizers, because they are polyphonic, are actually equipped with several VCO's, VCF's, VCA's and EG's: 16 sets on the CS-80 for creating each of the 8 notes times 2 voices that can be played simultaneously.

Why Voltage Controlled Circuits are used in Synthesizers & How They Work

You can set up voltage controlled circuits to make changes automatically. Suppose you have a sub oscillator that produces a continuously changing voltage (AC), such as the slow sine wave from the CS-80's Sub Oscillator. If you apply that voltage to the control input of a Voltage Controlled Amplifier, the sound passing through that amplifier will go up and down in level—creating a tremolo effect. (This is exactly what happens when you move down the VCA lever in the Sub Oscillator Section.) At this point you are listening to one sound source that is being **modulated** or controlled by something else, a sine wave. If you increase the SPEED of the Sub Oscillator, the rapid changes in control voltage will make the sound level change so fast that beating occurs, producing secondary tones.

You can also adjust a voltage controlled circuit manually, if you wish, just like any conventionally controlled circuit. For example, you might achieve the same slow-speed tremolo effect by continuously moving a Volume control up and down, if you had the fingers free to do it. However, you could not possibly move that volume control fast enough or smoothly enough by hand to produce secondary tones. Thus, voltage controlled circuits enable you to do things that could not be readily accomplished with purely manually controlled circuits.

Amplifiers (VCA's) are not the only voltage controlled circuits in a synthesizer; filters and oscillators may also be voltage controlled. In all instances, the

amount of change in the sound is proportional to the voltage applied to the control circuit. The same sine-wave voltage from the Sub Oscillator that created tremolo in the VCA when applied to the control input of a VCF would create wah-wah, or when applied to a VCO would create vibrato.

It is not at all important for a player to understand about voltages and control circuits to program and play the CS-80. When you set the controls and levers so the sound is "right," you are probably adjusting control voltages.

The synthesizer consists of sound producing and sound modifying circuits, all related by a number of signal paths and control circuits. Oscillators and Noise Generators produce the raw ingredients for sounds. Wave Shape Converters, Filters, Amplifiers, a Ring Modulator, a Tremolo, and sub oscillators further modify the sound (the audio signals). These circuits, plus the distinction between audio and control functions, are detailed below. While voltages are discussed, it is not really necessary to understand how voltages work; when you move the controls and knobs, you are adjusting voltages inside the synthesizer.

Audio Signals & Control Voltages

Electric currents that flow through synthesizers can be thought of in two categories: audio signals and control voltages. The audio signals constitute the actual sound as it is generated, modified, and ultimately fed to the output. The control voltages themselves are never heard, but are instead used to adjust the circuits which process the audio.

Audio signals are alternating currents (AC) with frequencies in the audible range which, as you probably know, covers about 10 octaves from 20 cycles per second (Hz) to 20,000 cycles per second (Hz). Audio signal voltages vary at different points in the synthesizer, but they average about 0.775 volts at the output when the rear panel HIGH/LOW switch is at HIGH position (0dBm into 600 ohms).

Control voltages are usually 10 volts or less, and may be dc (direct current) or AC (alternating current). AC control voltages vary in frequency from very low, sub-audio frequencies (1/2Hz) up to the audio frequency range (as high as 500Hz or more). The effect produced by a voltage controlled circuit will vary in proportion to the control voltage applied. For example, a VCA (voltage controlled amplifier) will cause the audio signal to be higher in volume when the control voltage is higher in level. If a steady dc control voltage is applied to the VCA, the volume of sound coming out of the VCA will increase by a proportionate amount and will remain at that level. If an AC control voltage is applied to the same VCA, then the volume will vary up and down, corresponding to the variations of the AC voltage; this is AM, or amplitude modulation.

When a dc voltage is applied to a VCO (voltage controlled oscillator), the oscillator increases its frequency. When an AC control voltage is applied to a VCO, the frequency varies up and down, producing an effect known as vibrato or FM (frequency modulation). Similarly, when AC or dc voltages are applied to VCF's (voltage controlled filters), the filter characteristics change; the cutoff points move up or down. Refer to the programming block diagram on this page,

which represents the functions of one of the programmable panels. This is the same diagram appearing on the memory panel cover, and is often helpful as a reminder of how the panel functions are related to one another. A key to the block diagram symbols is shown below the diagram. Audio signal paths run from left to right, as shown by the horizontal lines that join the blocks (colored lines). All vertical lines that point to the blocks represent control voltage paths. The block diagram is divided into three sections which correspond to the VCO, VCF and VCA sections of the panel; the TOUCH RESPONSE section is diagrammed as being part of the VCF and VCA sections, since it actually effects both of these functions.

A more complete block diagram of the full synthesizer is shown below. Like the simplified block diagram, audio signal flows from left to right. However, unlike the simplified block diagram, vertical and horizontal lines do not distinguish control and audio signals; audio signals are still shown by the colored lines and control signals are shown by the black lines.

Programmable Panel Block Diagram

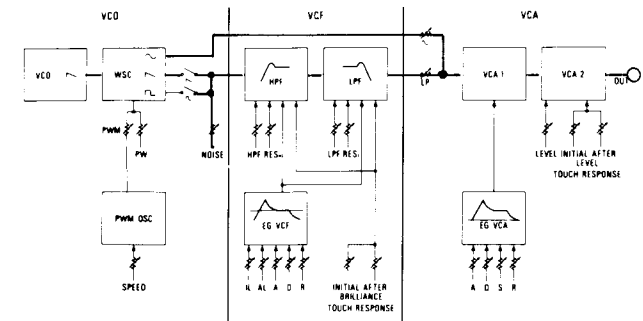

- A = Attack Time
- AL = Attack Level
- AMP = Amplifier
- D = Decay Time
- EG = Envelope Generator
- EXT IN = External Input
- HPF = High Pass Filter
- LPF = Low Pass Filter
- PW = Pulse Width
- R = Release Time
- S = Sustain Level
- TUNE = Pitch Controls
- AFTER = After Touch Response (Pressure)
- INITIAL = Initial Touch Response (Velocity)
- LFO = Low Frequency Oscillator
- M1-M8 = Main Sound Generating Circuit Boards
- MOD = Modulation or Modulated Signal
- PWM = Pulse Width Modulation
- PWM OSC = Pulse Width Modulation Sub Oscillator
- RES_H = High Pass Filter Resonance
- RES_L = Low Pass Filter Resonance
- VCA = Voltage Controlled Amplifier
- VCF = Voltage Controlled Filter
- VCO = Voltage Controlled Oscillator
- WSC = Wave Shape Converter (Part of VCO)

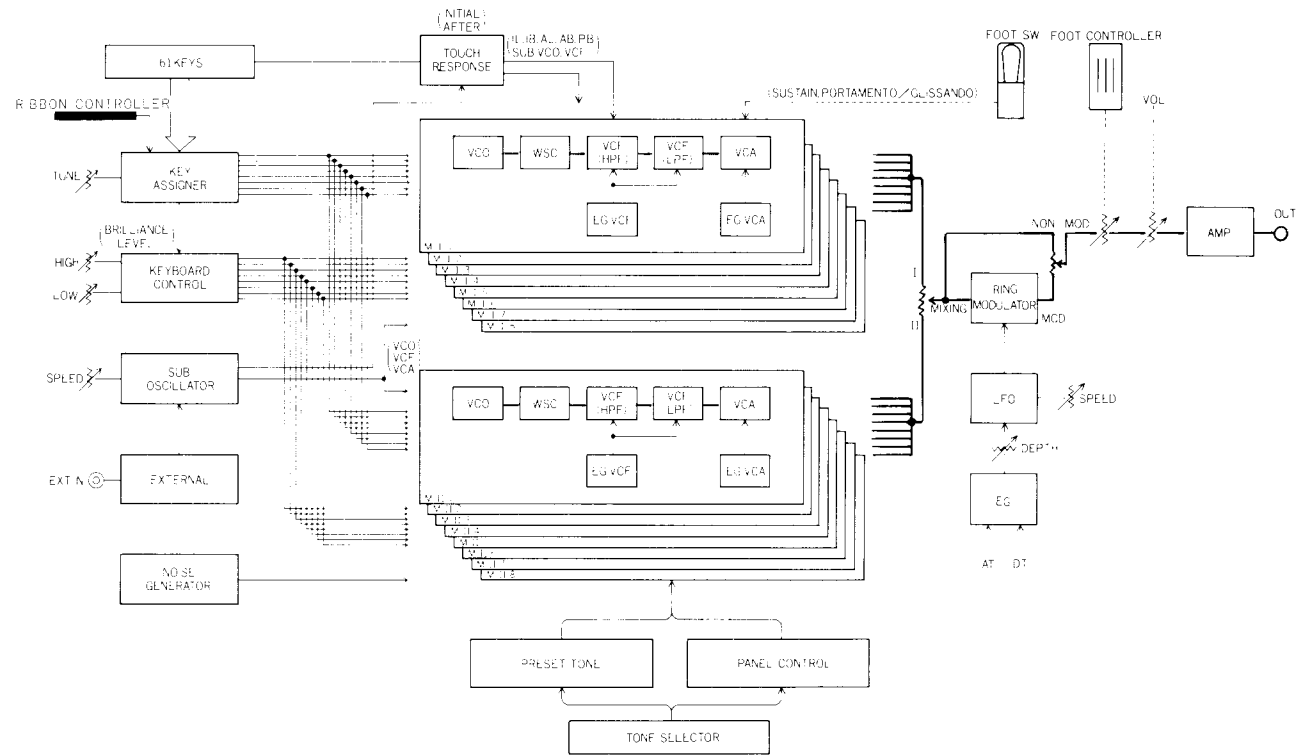

Overall Synthesizer Block Diagram

Oscillators

An **oscillator** is a circuit that produces AC voltage, generating voltages which go up and down in level according to some regular, defined pattern (waveform) and at some defined rate (frequency). There are many types of oscillators, some for very low frequencies and others for audio frequencies. Oscillators that operate in the audio frequency range are generally used as sources of sound.

The **VCO** is a voltage controlled oscillator. The CS-80 has sixteen main VCO's, one VCO for each of 8 notes times the two voices. Any main VCO is capable of producing all the notes, but only one note at a time. When you play the keyboard, special digital circuitry assigns different control voltages to the available VCO's so that the desired notes are produced.

Wave Shape Converters

The CS-80's main VCO's produce sawtooth waves. These waves may be used, unaltered, as the sound source, but they can also be processed by the **wave shape converter** (WSC) to form square waves or sine waves, as desired. The WSC's are considered to be part of the VCO's.

Noise Generator

A **noise generator** is like an oscillator that is constantly and rapidly changing its frequency and its waveform so that the output appears to be a random mixture of all sounds simultaneously. White noise is a type of noise that has equal level, on the average, across the full audio spectrum. The noise generator is not voltage controlled, but is included in the VCO section of the programmable panels because it introduces noise at the same point in the circuit as the VCO's: just before the filters.

Filters

A **filter** is a circuit that allows some frequencies to pass through it, but eliminates other frequencies. In the CS-80, there are two types of audio filters, high pass (HPF) and low pass (LPF). (Many synthesizers have only a low pass filter.)

A **low pass filter** blocks all audio signals above its cutoff frequency (cutoff point). When the LPF cutoff point is set at a high frequency, it is said to be "wide open" because the fundamental note and all its harmonics (overtones) are below the cutoff point and will pass through the filter. As the LPF cutoff point is lowered, more and more of the harmonics and then the fundamental are eliminated, and the filter is said to be "closed down."

A **high pass filter** blocks all audio signals below its cutoff frequency. When the HPF cutoff point is set at a low frequency, it is said to be "wide open" because the fundamental note and all its harmonics are above the cutoff point and will pass through the filter. As the HPF cutoff point is raised, the fundamental is blocked, then the lower harmonics, and eventually all harmonics, so the filter is said to be "closed down."

A **VCF** is a voltage controlled filter. It can be an HPF or an LPF. In fact, the CS-80's VCF's actually consist of two filter sections each, an HPF and an LPF, as described above. Thus, the CS-80 has 16 VCF's (32 filter sections), one for each of the 16 main VCO's. The cutoffs can be changed automatically by the Filter envelope (IL-AL-A-D-R) or manually by moving a filter slider (HPF or LPF).

When you play a note on the CS-80, the sound generated by a VCO goes through the HPF section of the VCF, then through the LPF section of the VCF. The VCF cutoff frequencies "track" the note played, moving up in frequency as you move up the keyboard, so that the tonal spectrum of the notes remains consistent. Recall that the LPF is wide open when its cutoff point is high, yet the HPF is wide open when its cutoff point is low.

Together, the HPF and LPF sections of the VCF may be considered to be a **bandpass filter** because a defined band of frequencies is allowed to pass between the two filter cutoff points. As the HPF cutoff point is raised and/or the LPF cutoff point is lowered, the width of the bandpass is decreased until there is no bandpass (no sound). Thus, we can speak of the VCF as being a bandpass filter, even though no such label appears on the panels. If either of the two filter sections is completely closed down, then it will block all sound, and the position of the other filter section makes no difference because you won't hear anything.

The HPF and LPF filters each have a **resonance** slider. These controls only have an effect if their corresponding HPF or LPF slider is partially closed. As the resonance of a given filter is increased, a narrow range of frequencies is boosted (increased in level)—the frequencies centered just at the cutoff point—because the cutoff point is resonating.

Resonance has no effect when a filter is wide open because the cutoff point is well beyond the limit of the fundamental or overtones, so the boost falls in an area where no signal is present. However, as a filter is closed down, the effect of resonance becomes more noticeable; resonance will tend to emphasize a given harmonic or the fundamental, depending on the filter cutoff (HPF or LPF setting). Resonance also causes

additional phase shift which can be heard if the filter cutoff point is changed while a note is being played.

Amplifiers

An amplifier is a device that increases the volume or the power of a signal. Some amplifiers, especially VCA's, also can be used to decrease the power or volume. When an amplifier decreases the volume to inaudibility, it is turning the sound OFF; conversely, when an amplifier increases the volume to audibility, it is turning the sound ON.

Most of the amplifiers in the CS-80 are **VCA's** (voltage controlled amplifiers), and they generally operate at medium line levels. Thus, external power amplifiers, such as a PA system or guitar amplifier head, are required to boost the power sufficiently to drive loudspeakers.

VCA's offer several advantages for synthesizers in addition to their ability to attenuate (lower) the volume as well as increase it. With conventional type amplifiers, audio signals must be routed through complex paths and it may be necessary to have a separate amplifier to achieve each effect—volume control, tremolo, note definition by an envelope, and so forth. With a VCA, on the other hand, numerous control voltages can be mixed together and fed to one amplifier, producing all the desired effects with a minimum of amplifiers. Thus, VCA's enable the circuitry to be simplified while reducing the potential for noise and distortion.

There are two VCA's for each of the 16 main VCO/VCF sound sources. These VCA's are used to "define" notes—to turn them on, vary their volume, and turn them off—as each note is played; this is done by a control signal from the amplitude envelope generator, as described in subsequent text. The VCA's will also vary the volume in a regularly modulated fashion when they are provided with an AC control signal from the sub oscillator.

Sub Oscillators

A **sub oscillator** generates AC voltages which are used to modify existing audio signals. The CS-80 has an overall SUB OSCILLATOR [11] and several other sub oscillators. For example, the PULSE WIDTH MODULATION (PWM) available on the panels and memory is produced by sub oscillators. The TREMOLO/CHORUS effect also includes a sub oscillator, as does the RING MODULATOR.

To understand how a sub oscillator is used, one should recognize that AC and dc control voltages are often mixed (summed) for combined functions. For example, the VCA's level (volume) control input is

fed by several sources of AC and dc voltages. The level can be varied up and down for a tremolo effect by applying an AC control voltage which is produced by the SUB OSCILLATOR section [11]. The depth of the tremolo effect would be adjusted by applying more or less of the AC voltage produced by the sub oscillator to the VCA. The speed of the effect would be adjusted by changing the sub oscillator's frequency. The average volume around which the tremolo is centered is adjusted by changing the dc control voltage, using the LEVEL slider [41].

Pulse width refers to the amount of time a square wave is OFF, and is also known as "duty cycle." A perfectly symmetrical square wave would have a 50% duty cycle (OFF as much as ON), and a narrow pulse width square wave might have a 90% duty cycle (which sounds the same as a 10% duty cycle—ON 10% of the time). The PW control [22] applies a dc control voltage to the WSC circuit which sets the basic pulse width (duty cycle) of the square wave at any point between 50% and 90%. The PWM control [21] applies an AC control voltage to the same point in the WSC (wave shape converter) circuit, thereby varying (modulating) the pulse width. That PWM signal is created by a sub oscillator, and the SPEED [20] of pulse width modulation is actually changed by adjusting the frequency of the PWM sub oscillator.

The sub oscillators in the RING MODULATOR and TREMOLO/CHORUS sections function similarly to the main SUB OSCILLATOR and the PWM sub oscillators described above. Changing the amount of AC voltage applied varies the depth of the effect, and changing the frequency of the sub oscillator varies the speed of the effect.

Envelope Generators

An envelope generator is a circuit which produces a single, carefully defined waveform — a one-shot voltage pattern — when the generator is stimulated by a pulse (trigger impulse) from the keyboard. The envelope itself is a changing dc voltage which rises from zero (no voltage) to some maximum point, and eventually falls back to zero in a pattern which is varied by using the envelope generator's controls.

No sound goes through the envelope generator itself. Instead, the envelope generator's output is fed to the control input of a VCF or a VCA. There are actually 16 envelope generators for the VCF's and another 16 for the VCA's.

Envelope generators (EG) which control VCF's are known as filter envelope generators. In the CS-80, the filter EG's are unique envelope generators, having 5 sliders: Initial Level (IL), Attack Level (AL), Attack

Time (A), Decay Time (D) and Release Time (R). These sliders all change the "shape" of the envelope, which in turn creates changes in HPF and LPF filter cutoff points each time a note is played. When all the filter EG sliders are set at minimum, there is no output from the EG, hence no change in filter characteristics.

Envelope generators which control the VCA's are known as amplitude envelope generators. In the CS-80, the amplitude EG's have 4 sliders: Attack Time (A), Decay Time (D), Sustain Level (S) and Release Time (R). These sliders change the "shape" of the envelope, which in turn creates changes in the volume (amplitude) of the sound when you play a note. When all amplitude EG sliders are set at minimum, there is only a very brief pulse of output voltage from the EG, hence only a brief "blip" of sound can be heard.

Conventional synthesizers sometimes have simplified EG's, with only Attack Time (A) and Release Time (R) sliders; the same A-R effect can be achieved on the CS-80 by setting the VCA Decay Time (D) and Sustain Level (S) sliders at maximum, and using only the A and R sliders.

The Keyboard & Related Circuits—General

As suggested in the preceding paragraphs, each channel of the CS-80 has eight sets of note-generating circuit components, each set consisting of a VCO, WSC, VCF and VCA, and two EG's. When you move any one of the panel programming controls, it actually affects all 8 sets of note-generating components on the corresponding channel. While there is 8 note simultaneous capability, there are 61 keys on the keyboard. Thus, there has to be a way of assigning the keys you play to those 8 different note generating circuits. This is the function of the Key Coder and Key Assigner circuits.

The Key Coder & Key Assigner

The key coder and key assigner are digital circuits, a sort of micro-computer. The key coder produces a digital "word" that describes the note (or notes) played. The key assigner "looks" to see which, if any, of the note-generating circuits is available and, at the same time, it continuously monitors the key coder to see which notes are being played. The assigner then feeds the digital word for each note to one of the note-generating circuits. If a ninth key is depressed while 8 other keys are already being played, the assigner cannot do anything with that additional information, so no new note will be heard until one of the first 8 keys is released.

If you play only one key, and play it 8 times in

succession, the key assigner will successively feed the "word" for that note to each of the 8 note-generating circuits. Since each circuit's VCO, VCF and VCA will differ slightly from the next due to normal component tolerances, the 8 notes will not be identical. This is how the CS-80 produces such natural sound, rather than a mechanical, "too perfect" sound.

D-to-A Converters

The note-generating circuits each have a D-to-A Converter (digital to analog) which changes the digital code for a note into a corresponding dc voltage. That dc voltage level is fed to the VCO, which reacts to set the pitch (frequency) of the note. The voltage is also fed to the VCF, which reacts by moving the HPF and LPF filter cutoff frequencies so they maintain the desired relationship to the frequency of the note (so they track).

Trigger Output

The instant a key is depressed, the keyboard produces a trigger output, in addition to the digital word. The trigger is a brief voltage pulse that occurs once, and it is routed to two envelope generators, the filter EG in the VCF section and the amplitude EG in the VCA section. The amplitude EG reacts to the trigger and generates a one-shot waveform to "shape" the volume of the note according to the preset or programmed A-D-S-R characteristics. The filter EG reacts to the trigger and produces a one-shot waveform which changes the tone of the note if the IL-AL-A-D-R controls are appropriately programmed (or if VCF envelope is part of the preset patch).

Touch Sensitivity

To understand how the touch sensitivity works, it is necessary to understand the method by which the keyboard itself functions. The CS-80 keyboard has a proprietary, patented technique for switching a note ON when you strike a key, plus a secondary system for adding effects by pressing harder after the key hits bottom.

Velocity Sensitivity

At the rear of each key, there is a single pole/double throw leaf switch. When you begin to press down a key, the first set of switch contacts open. Then, as the key nearly hits bottom, the second set of switch contacts close. The closing of the second set of contacts activates the key coder, key assigner, and subsequent circuits to generate the note. However, the time interval between the opening of the first contact pair and the closing of the second contact pair is used by another circuit to produce a control signal.

The Key Timing Circuit utilizes sophisticated logic

that converts the time interval between switch contact opening and closing into a brief output voltage pulse. The faster a key is pressed down, the shorter the time of switch contact action, and the higher the voltage level of the pulse. The key timing circuit pulse is used to create various initial touch sensitivity (velocity sensitive) effects, depending on how the presets, programming, and TOUCH RESPONSE sections are set.

PITCHBEND [12] is an initial touch sensitivity effect whereby the timing circuit pulse is reversed in polarity and applied to the VCO. Thus, the frequency of the VCO is initially forced lower by the negative voltage pulse from the Key Timer Circuit, and then comes up to the note's designated frequency as the pulse dies out.

The INITIAL LEVEL lever [43] in the programming panel applies the key timing pulse to the VCA, thus increasing the volume of the note for the duration of the pulse. The faster you strike a key, the higher the voltage pulse and the higher the volume. This effect is programmed into some of the preset patches. Similarly, the INITIAL BRILLIANCE lever [42] applies the key timing pulse to the VCF, thus raising the cutoff frequency of both filters. This increases the amount of high frequencies which can pass through the VCF by an amount proportional to the voltage of the timing pulse, and only for the duration of the pulse.

Pressure Sensitivity

A sensor beneath the front of each key is used for the AFTER (pressure sensitive) effects. The harder you press a key after it first touches bottom, the higher the voltage allowed to get through a variable pad in the key's sensor. Various effects are produced by the voltage, depending on how the presets, programming, and TOUCH RESPONSE sections are set; the keyboard's after voltage is applied to the control input of the appropriate voltage controlled circuits.

Keyboard Control

The keyboard control HIGH and LOW levers affect the upper and lower portions of the keyboard separately, with increasing effect toward the ends of the keyboard. This is done for LEVEL and for BRILLIANCE. The effect is actually achieved by a digital circuit which interprets the position of each note played on the keyboard and produces a proportional amount of dc voltage. With the HIGH levers, the higher the note, the higher the voltage. With the LOW levers, the lower the note, the higher the voltage. If a BRILLIANCE lever is engaged, the extra voltage is added to the VCF, raising the cutoff point for a more brilliant sound. If a LEVEL lever is engaged, the

extra voltage is added to the VCA, increasing the volume of the note. (BRILLIANCE and LEVEL are decreased by reversing the polarity of the keyboard control voltage.)

Portamento/Glissando

The glissando effect is produced by a digital circuit which "looks at" the last note played and at the note being played. Instead of allowing the voltage fed to the VCO to jump instantly to the voltage called for by the note being played, the glissando circuit gradually moves the voltage from that of the previous note to the currently played note. A digital circuit causes the voltage to increase or decrease in quantized increments that correspond to half-step increments (a chromatic scale).

The portamento effect is actually produced by the same circuit that produces the glissando, except that an additional circuit element is added. This element "integrates" the steps of voltage, smoothing the transition from one note to the next. Thus, the change is continuous rather than stepped.

Ribbon Controller

The ribbon controller is a felt strip beneath which is located a flat resistive pad and a conductive cord. When you press down on the felt, the cord contacts the pad and establishes a given resistance. Voltage passes through the pad and the cord, the value varying in proportion to where the strip is pressed down. The actual voltage produced when the ribbon is first pressed down is not important; it serves only as a reference point. The output from the ribbon circuit then becomes proportional to the difference between the reference point and any other point touched on the ribbon.

A comparator circuit "looks at" the change in voltage and produces a positive dc output when the second point touched on the ribbon is to the right of the reference point. A negative dc output is produced when the second point is to the left of the reference point. The further away the second point from the reference point, the higher the voltage output (positive or negative).

No voltage output is produced if only one point is touched. It is necessary to move a finger along the ribbon, or to hold one finger in a given point and then touch another finger elsewhere on the ribbon in order to achieve an effect.

The voltage output from the ribbon controller is fed to the main VCO's, thus changing the pitch of any note or notes being played; a positive voltage would raise the pitch, and a negative voltage would lower the pitch.

Pitch Control & Detune CH II Control

The pitch control adds more or less voltage to "bias" the VCO control inputs, thus raising or lowering the frequency produced when a given key is depressed. The pitch control feeds both channels an equal amount of voltage. The coarse pitch control merely produces a greater range of voltage variation than the fine pitch control. The Detune CH II control really does the same thing as the fine pitch control, but it is connected only to channel II. Thus, only the pitch of channel II changes.

Ring Modulator

A Ring Modulator blends two signals together in a special way, "beating" a sub oscillator against whatever input signal is fed to the modulator input. The output does not contain the input signal frequency (or frequencies), but it does contain what are known as sum and difference frequencies. Sum and difference simply means that the sub oscillator frequency is added to the input frequency, and is also subtracted from the input frequency. (Actually, the mathematics that describe the modulation are somewhat more complex because two times the sub oscillator frequency is subtracted from and added to the input, three times the sub oscillator frequency, etc.). The effect may resemble "ringing," although the term "ring modulator" is believed to be derived from the configuration of the diodes which comprise such modulators; they are wired in a circle.

The sub oscillator frequency is set with the SPEED lever, and the amount of sub oscillator voltage fed to the ring modulator is set with the MODULATION lever. An envelope generator is provided for the sub oscillator, and may be used to change the speed when a note is played. The ATTACK TIME lever and DECAY TIME lever respectively speed up and slow down the effect from whatever speed is set with the SPEED lever to some higher value, and back to the set speed. The amount of change in speed—the amount of envelope voltage fed to the sub oscillator—is set with the DEPTH lever.

Panels, Memories & Preset Patches

The main programmable panels provide a means for the player to adjust the many VCO, VCF and VCA characteristics, as well as touch response characteristics, that together comprise a basic "patch" or sound. The memories are miniaturized versions of the programming panels, and are used in exactly the same way. The preset patches (PRESET TONES) were all derived from actual settings of the main programmable panels. Once a given patch was derived, the resistance value or switch position of each panel control was measured.

A fixed component of the same value was then built into the instrument, creating a kind of internal memory that is recalled whenever the corresponding preset patch is selected. You can always duplicate a preset patch by using the programmable panels, as is suggested by some of the patch charts included in this manual. You may wish to do so, and to then vary one or more controls to obtain variations from the presets.

Foot Switch & Foot Controller

The Foot Switch is just that—an ON-OFF switch which is housed in an assembly designed for foot actuation. The switch can be used to activate the portamento/glissando effect and/or the sustain, depending on the setting of front-panel assignment switches. When the Foot Switch is not plugged into the synthesizer, the jack automatically closes the circuit so the unit acts as though the Foot Switch were pressed down.

The Foot Controller contains more complex circuitry, including a light and a photosensor. As the pedal is rocked back and forth, an aperture varies the amount of light reaching the photosensor. In turn, the sensor varies its resistance, and hence varies the voltage output from the circuit. Depending on the setting of the front panel FOOT PEDAL SELECTOR buttons, the voltage from the Foot Controller is applied to either the VCA (in EXP mode) or to the VCA and the VCF (in EXP/WAH mode).

The Foot Switch has a standard (tip/sleeve) phone plug, whereas the Foot Controller, because it contains more circuitry, requires a stereo (tip/ring/sleeve) phone plug.

Tremolo/Chorus

The tremolo/chorus effect varies the volume of the output signal, and also introduces a phase shift. Together, these effects simulate a rotating speaker when used with a stereo sound system. The volume change is produced by feeding a sub oscillator output to a pair of VCA's. Selecting the CHORUS effect sets a sub oscillator to its very slow speed range (about 1/2 to 5Hz), whereas TREMOLO sets the same sub oscillator to a faster speed range (about 5 to 20Hz); the exact speed is set with the SPEED control. The phase shift is produced by using an analog delay line, changing the delay in a regular fashion with a clocking circuit, and mixing delayed and non-delayed audio together. The amount of tremolo or chorus effect is set with the DEPTH control.

WHERE'S THE SOUND

A Brief Troubleshooting Guide

Many times the unit will be connected and basically adjusted properly, yet there may not be sound. The difficulty can be caused by a playing technique that is inappropriate for a given patch; it can sometimes be cured by a change in playing style or by minor adjustment of one or two control settings.

1. Be sure all equipment is plugged in and the POWER is ON, and all controls are set a nominal, as shown by the inside cover illustration.
2. Play one or more notes, and continue to play notes, holding the key(s) down for a few seconds rather than playing staccato.
3. Check the sound system to verify it is properly connected, turned on, and working. If the rear-panel HIGH/LOW switch is at LOW, try the HIGH position (if that doesn't help, switch HIGH/LOW back to LOW). It may be necessary to check the sound system with a sound source other than the CS-80, or use headphones to check the CS-80.
4. Check the EXPRESSION pedal and VOLUME control settings.
5. Use a preset patch rather than a memory or panel-programmed patch, and play in the middle of the keyboard.
6. If you hear nothing, check the setting of the BRILLIANCE control [7]. If sound dies only at the upper and/or lower extremes of the keyboard, center the KEYBOARD CONTROL levers.
7. Check to be sure the FEET selector sliders [5] are set at a detented position and not in between settings.
8. If the sound goes away only with a panel or memory programmed patch, check the following:
 - a. A basic waveform or noise level must be turned ON in the VCO section [23, 24, 25] and VCF level in the VCA section [35] must be up or sine wave [36] in the VCA section must be up.
 - b. If the LPF slider [28] is set at the same height or below the HPF [26] slider, it may be necessary to raise LPF or lower HPF [26].
 - c. VCA LEVEL [41] must be up.
 - d. Some envelope must be up (Sustain [39] and/or Decay [38]). If a long Attack Time is used [37], then you may have to hold a key for a second or more before you begin to hear the sound.

TIPS ON RECORDING

In any recording situation, the levels are extremely important. The CS-80 has very low inherent noise, high output capability, and hence a large usable dynamic range. If you use a lot of expression and touch sensitivity to create very wide playing dynamics, the recording engineer will be forced to use compression and/or limiting to avoid severe distortion on the tape and, ultimately, on the record. If you want to have the recorded sound be very similar to what you play in the studio, then you can hold back your playing dynamics so that less compression and limiting are needed. You might also reduce the amount of Initial Level or After Level touch sensitivity in your programmed patches.

The synthesizer output is capable of driving low impedance studio console or tape machine inputs, but it is unbalanced. Where long cable runs are required, it may be a good idea to use a balancing transformer or direct box at the synthesizer output, since this will help to reduce susceptibility to hum, noise and radio frequency interference. The LOW/HIGH switch should be set at HIGH and the VOLUME control at 12 o'clock or higher, whenever possible, so that signal levels between the synthesizer and recording equipment are as high as possible. In most cases, the level can then be turned down (attenuated) at the console input.

As you know, with overdubbing the first track recorded is the one against which the rest of the music is played. Therefore, make it clean and rhythmically precise. For large multi-track machines, you might use a click track (metronome), or a rhythm line with a pair of bass and piano tracks. On the other hand, with 4-track machines, it is usually better to start with a rhythm sound that is as close to the midrange as possible. This avoids excess high frequency loss or low frequency irregularities that might occur after multiple "sound-on-sound" transfers. (Head bumps, a very common tape machine characteristic, produce irregular low frequency response that would be emphasized more by a bass track than by a mid-range track.)

The following suggestions apply to all orchestration, whether you are playing with a large band, overdubbing one synthesizer on multiple tracks of a tape machine, or not using any synthesizer at all. There is sometimes a trade off between clarity of voices and richness of sound, often because too much music is being played in one frequency band. To avoid competition between voices, try to make a sound full and complete as possible, but keep it within a given frequency range. The secret to a richer sounding orchestration is to use a variety of waveforms, counter

lines, envelopes and sub oscillator frequencies for the different voices; try not to layer many voices that are nearly identical. This principle of distinct voices and frequency bands is useful, but it does not mean that frequencies should never be duplicated by two or more voices; it is only a guide line. If two sounds are played in the same register, a slight detuning of one sound can make the mix more dense.

TIPS ON LIVE PERFORMANCE

When rehearsing, try to set up a logical progression of patches—logical in that a given patch is changed slightly to achieve the next sound. You never need to start "from scratch" because you can start with a preset patch and adjust the sub oscillator, touch sensitivity, ring modulator, etc. to modify that sound. In a live performance, you can then quickly get another sound by selecting a different preset, or by readjusting one or more of the modifying circuits.

Two different approaches can be taken with regard to use of programmed patches. In one instance, you may wish to program a unique and different sound on each panel and memory. These would essentially add to the variety of existing preset patches. However, you may instead wish to pre-program two or more very similar patches, patches that differ only slightly, but in areas where control settings are critical. Then, the different sounds can be pushbutton selected without concern about instantly getting sliders and levers "just right."

The preset patches make it easy to get different sounds quickly and with excellent repeatability. However, a very wide range of variation can be achieved within any given preset by merely changing the Brightness lever [7]. Use of the keyboard control section, the sustain foot switch, the Feet selectors, and various sub oscillator functions will add even more possibilities to each preset. Therefore, instead of switching from preset to preset, it is often more interesting and exciting to explore the full scope available within a single preset patch.

Yamaha polyphonic synthesizers enable you to get a very wide range of keyboard dynamics, plus further dynamic control via the expression pedal. Thus the playing level can change quite dramatically depending on what voices you have programmed and how you play. Therefore, be sure to check levels for a specific patch ahead of time so that when you come on stage to play the first notes, they are at the right volume level.

If one of your programmed patches doesn't work

and you suspect some control(s) was accidentally moved, don't panic; just go to a preset while you check the panel levers and switches.

TIPS ON AUXILIARY SIGNAL PROCESSING

Phasers, echo boxes, reverbs, digital delay lines, parametric equalizers, fuzz boxes, wah-wah pedals, graphic equalizers, etc. are all auxiliary signal processing devices that may be used with a synthesizer. The synthesizer output is higher in level than most electric guitar pickups, but it can still be plugged into many guitar-type pedals and boxes if the HIGH/LOW switch is at LOW and the Volume control is set at a moderate level. On the other hand, it may be better to use an external attenuation pad to match the level of the synthesizer output to a high-sensitivity (low level) effects device. Signal processing equipment made to interface with studio equipment can usually be driven directly from the synthesizer output with the HIGH/LOW switch in HIGH position. In all cases it is a good idea to check the level (sensitivity) specifications for the auxiliary signal processing unit against the synthesizer specifications.

Many of the sounds you might wish to achieve with an outboard effects device can actually be achieved with controls and circuits that are built into the synthesizer. For example, tremolo, vibrato and wah-wah can all be obtained using the sub oscillator. Where practical, use the built-in capability of the synthesizer, since the sound will be going through fewer circuits and will therefore have the lowest noise and best frequency response.

Many patches are greatly enhanced by auxiliary signal processing. The realism of "acoustic" instrument patches can be very much heightened by using reverb.

The synthesizer's External input can afford some interesting effects. To obtain strange "vocal" effects, plug in a source of a very pure, high-frequency sound, such as a 10kHz or higher sine wave oscillator.* Then engage the VCF (filter) on the sub oscillator, and add a lot of Resonance [8 and/or 27 & 29]. The External input is not made for use with guitars or microphones, and even if a preamplified guitar or mic is used, the results could be disappointing. Some preamplified (electric) instrument outputs will produce interesting results when connected to the External input.

*The purer the sine wave fed to the external input, the better-sounding the result will be.

DIRECT BOX

A "direct-box" is a type of adapter. In some cases, rather than connect the CS-80 directly to a mixer, one could connect the synthesizer to an instrument amp. The direct box would then be used to interface the instrument amplifier's speaker output (guitar amp, P.A. amp, etc.) with the mic or line level mixer input, thus including the amplifier's reverb, tremolo, brightness and other effects in the mix. Another application for a direct box is to achieve grounding isolation between an unbalanced line level output and a balanced mic or line level input.

The CS-80 output has a low source impedance so that it will drive a low impedance (600-ohm) or high impedance input without adapters. The CS-80 output is unbalanced, meaning that the signal, which flows through a single-conductor shielded cable, is grounded on one side (the shield) and ungrounded on the other side (the center conductor). This arrangement is perfectly suitable for cables of up to 3 m (10') in length. When a longer distance separates the CS-80 output from the mixer input, it is desirable to use a balanced line rather than an unbalanced line for better rejection of potential hum, noise and interference. In a balanced line, the cable shield is grounded, but carries no audio signal; two center conductors, neither of which is grounded, carry the signal. Provided the mixer input is balanced (transformer isolated), a balanced line will be obtained by connecting a direct box at the CS-80 output.

If two or more CS-80 outputs are connected to one mixer, it is a good idea to use a direct box on each output so that the ground to all but one of the inputs can be interrupted without breaking the signal path. This avoids so called "ground loops," multiple grounding circuits between the mixer and the synthesizer that might otherwise introduce hum.

The direct box illustrated can be used in three ways, as indicated below, and its three switches should be set as required. The **ground** switch breaks the ground (shield connection) in the XLR output, and should be set for minimum hum. The **Pad** drops the signal level so that high level outputs do not overdrive lower level mixer inputs. The **Filter**, which only works when the Pad is switched IN, simulates the high frequency roll off of a typical guitar amp's speaker. Since clipping distortion in a guitar amp often creates high frequency harmonics, the filter switch, by lowering high frequency response, also cuts distortion.

Assemble the unit in a small metal mini-box, and keep the phone jacks isolated from the chassis of the box. Also keep the box away from the chassis of the instrument amplifier or any other grounded object. If you chose a transformer other than the JE-DB-D, it should have similar characteristics: an impedance ratio of 20k-ohms (primary) to 150-ohms (secondary), dual faraday shields, very low capacitance on the primary winding, and full audio spectrum response.

A commercial direct box may be purchased, or a qualified technician can build one from the schematic diagram shown here. The design, courtesy of Deane Jensen (Hollywood, CA), is included in this manual for the benefit of the synthesizer user, and does not represent an endorsement by Yamaha of the specific products mentioned. This direct box also works well with electric guitars, maintaining good high frequency response because the pickup is not loaded.

The JE-DB-D transformer is available directly from:

Jensen Transformers
1617 North Fuller Avenue
Hollywood, CA 90046

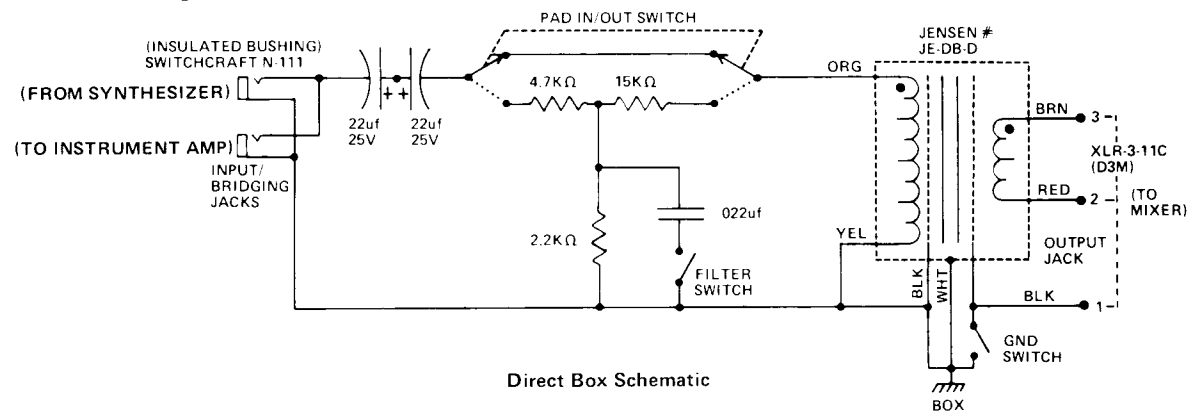

Direct Box Use Chart

	PAD*	GROUND†	FILTER
1. Between any of the three CS-80 outputs and a mixer line input.	IN	IN/OUT	OUT
2. Between any of the three CS-80 outputs and the input of an instrument amplifier, while also feeding a mixer line input.	IN	IN/OUT	OUT
3. Between the speaker output of an instrument amplifier and a mixer line input.	IN	IN/OUT	IN/OUT

**We recommend setting the CS-80 output HIGH/LOW switch to HIGH, and using the direct box pad to reduce the signal level. This protects the transformer from saturation and the mixer input from overdrive. (It is possible to set the HIGH/LOW switch to LOW, and to switch OUT the direct box pad. This does present a much lower impedance to the direct box transformer, causing some transient distortion. While the resulting sound will be brighter and less accurate, there is no harm if you like it.) ALWAYS USE THE PAD WHEN YOU CONNECT A SPEAKER LEVEL OUTPUT TO THE DIRECT BOX.*

†Set for minimum hum and noise. If in doubt, leave IN.

TRAVEL CASE

The CS-80 is built into a durable plywood case, with a removable cover, which is suitable for light duty traveling, such as in a station wagon or van. For heavy cartage (i.e., commercial trucking or air freight), we recommend you use an additional travel case. If you buy a custom built case, it should meet "ATA-300" specifications (ATA=Air Transport Authority). The case should be lined with 3-inch thick foam on all sides; 3/4" plywood or its equivalent is recommended for adequate strength. Consult the specifications for inside case dimensions.

SPECIFICATIONS

Keyboard

61 Keys, C through c: (5 octaves).

Transposition

FEET selector for each channel. Nominal 8' setting, range from 1 octave below nominal (16') to 2 octaves above (2').

Available Fundamental Frequency Range (*Harmonics higher than these specified frequencies may be present, although not specified.*)

32Hz to 8kHz (from 16' and lowest note on keyboard to 2' and highest note on the keyboard, PITCH controls centered and ribbon controller not in use).

0Hz to 11kHz (approx.) using the PITCH controls and ribbon controller to extend the lowest and highest keyboard pitches.

Pitch Tuning Range

COARSE TUNE: approximately 1 octave (-500 cents to +700 cents).

FINE TUNE: approximately ± 1 semi-tone (± 30 cents).

DETUNE CH II: channel II may be offset in pitch from channel I by approximately ± 1 semi-tone.

Simultaneous Notes

Up to 8 notes may be played simultaneously. However, since each note played can cause separate voices to be generated by the two channels, up to 16 notes actually may be heard at once.

Simultaneous Voices

Two independent voices may be generated, one on channel I and one on channel II; a MIX control assigns either voice, or any blend of the two, to additional synthesizer circuitry and ultimately to the outputs.

Total Number of Voices

Each channel is provided with 11 different preset patches, two memory-programmable patches, and one panel programmable patch.

Preset Patches (*Preset Tones*)

STRING (1, 2, 3 & 4), BRASS (1, 2 & 3), FLUTE, ELECTRIC PIANO, BASS, CLAVICHORD (1 & 2), HARPSICHORD (1 & 2), ORGAN (1 & 2), GUITAR (1 & 2), FUNKY (1, 2, 3 & 4)

Envelope Generator Time Ranges (*VCF-EG & VCA-EG*)

Attack Time: 1 millisecond (min.), 1 second (max.).

Decay Time: 10 milliseconds (min.), 10 seconds (max.).

Release Time: 10 milliseconds (min.), 10 seconds (max.).

Glissando/Portamento Time Range

10 seconds maximum to change oscillator frequency from the lowest to the highest note on the keyboard.

Ring Modulator

Simultaneous, sine-wave ring modulation of all outputs.

Variable SPEED, depth of MODULATION. Envelope Generator for varying the speed of the Ring Modulator has variable ATTACK TIME, DECAY TIME, and DEPTH of speed change.

Sub Oscillator Functions

Sine wave, sawtooth wave, inverted sawtooth, square wave, white noise, or an external input can be used to modulate any combination of the following: VCO, VCF, VCA. Modulation is applied equally to both voices and all notes played. SPEED (frequency) range is adjustable from 0.7Hz to 60Hz.

Velocity Sensitive Touch Response (*"INITIAL" effects*)

Individual channel programming controls increase the LEVEL (volume) and/or BRILLIANCE (filter cutoff frequencies) as keys are pressed faster; control to increase the amount of PITCHBEND (oscillator pitch change) for any voices being played.

Pressure Sensitive Touch Response (*"AFTER" effects*)

Individual channel programming controls increase the LEVEL (volume) and/or BRILLIANCE (filter cutoff frequencies) as keys are pressed down harder; controls to increase the sub oscillator SPEED (frequency), the amount of sub oscillator modulation of the VCO, or the amount of sub oscillator modulation of the VCF for any voices being played.

External Input Characteristics

Unbalanced, standard 1/4" phone jack. 50-kohm actual impedance (for low or high impedance sources). Nominal sensitivity 10 millivolts rms (30mV peak-to-peak) with EXT IN level at maximum; i.e., 10mV rms sine wave external input would produce the same amount of sub oscillator modulation as the maximum from the built-in sub oscillator.

Output Characteristics — Same for LEFT, RIGHT or GENERAL (mono) out.

HIGH range, 0dBm (0.775 volts rms) or LOW range, -20dBm (7.75 millivolts rms); nominal output when playing four notes, all volume or level controls at maximum.

Unbalanced, standard 1/4" phone jacks. Actual 600-ohm output source impedance. (Will drive low impedance or high impedance loads.)

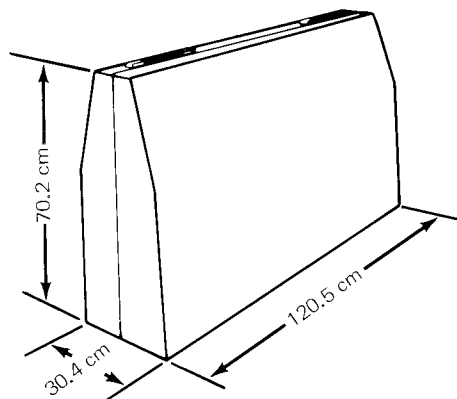

Headphone Output

250 millivolts rms nominal. Unbalanced, Tip/Ring/Sleeve 1/4" phone jack for stereo headphones (8-ohm or higher impedance). Located on bottom panel.

Circuitry

All solid state; keyboard and note assigning circuitry is digital; all audio circuitry is analog, with voltage controlled oscillators, amplifiers, filters and envelope generators.

AC Power

AC, 50 or 60Hz, 180 watts.

Power cord stores in covered compartment beneath synthesizer.

Finish

Black leatherette with metal-reinforced corners; walnut veneered side panels.

Dimensions

In Case: 120.5 cm wide x 30.4 cm high x 70.2 cm deep (47-1/2 x 12 x 27-5/8"); (not including leg/accessory bag). Assembled: 120.5 cm wide x 96.5 cm high x 70.2 cm deep (47-1/2 x 38 x 27-5/8"); Keyboard Height: 84.2 cm (33-1/8").

Weight

100 kg (220.5 lbs.) including all standard accessories.

Standard Accessories

Detachable hard cover.

Transparent music rest (stores in hard cover).

Detachable casters.

Foot Controller (expression or expression/wah pedal).

Foot Switch Pedal (sustain and/or portamento ON-OFF).

Vinyl carrying bag for legs, pedal, controller and casters.

Yamaha Key Cleaner Creme.

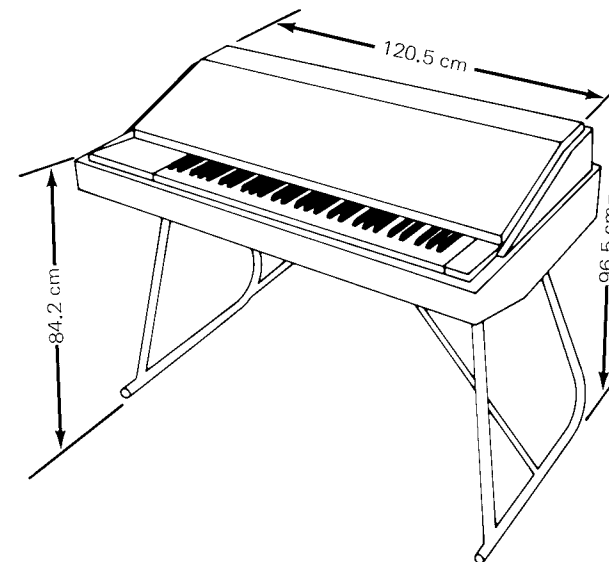

Specifications subject to change without notice.

These blank patch diagrams are provided for your convenience. Copies may be made of page 51 and filled in according to your own requirements. We suggest using a bright-colored felt-tipped pen, as shown in the example below.

EXP **EXP MAN** **FOOT PEDAL SELECTOR** **ON SUSTAIN** **ON PORTAMENTO GLISSANDO** **FOOT SWITCH** **SHORT SUSTAIN** **SHORT PORTAMENTO GLISSANDO** **SPEED** **DEPTH** **ATTACK TIME** **DELAY TIME** **RING MODULATOR** **DEPTH** **SPEED** **MODULATION** **FUNCTION** **SPEED** **SUB OSCILLATOR** **VCO** **VCA** **FEED - B** **TONE SELECTOR** **INITIAL** **BRILLIANCE** **RESONANCE** **PITCHBEND** **SPEED** **VCO** **VCF** **KEY TRACKING CONTROL** **LEVEL LOW** **LEVEL HIGH** **VOLUME**

MELLOW STRINGS

The patch diagrams are organized into four rows. Each row contains a set of control knobs and sliders on the left, a central grid of 24 tone selector buttons, and a set of control knobs and sliders on the right. The 'MELLOW STRINGS' patch is the first one shown, with several parameters marked with an 'X' to indicate they are active or set to a specific value.

EXP EXP MAX

FOOT PEDAL SELECTOR

SHORT SUSTAIN PORTAMENTO GLISSANDO

ON SUSTAIN PORTAMENTO GLISSANDO FOOT SWITCH

SPEED DEPTH

FAST 0 100% ON ON NOISE

SLOW SPEED PWM PW NOISE

VCO

LOW HIGH HIGH HIGH V +3 LONG LONG LONG

AMP RES- LP RES. K AL SHORT SHORT SHORT

VCF LEVEL VCA

INITIAL TOUCH RESPONSE AFTER

BRILLIANCE LEVEL BRILLIANCE LEVEL

PITCH DETUNE CH3

ATTACK TIME DELAY TIME RING MODULATOR DEPTH SPEED MODULATION

FUNCTION

SUB OSCILLATOR SPEED VCO VCF VCA

FEET - 8

1 2 3 4 5 6 7 8

9 10 11 12

13 14 15 16

17 18 19 20

21 22 23 24

25 26 27 28

29 30 31 32

33 34 35 36

37 38 39 40

41 42 43 44

45 46 47 48

49 50 51 52

53 54 55 56

57 58 59 60

61 62 63 64

65 66 67 68

69 70 71 72

73 74 75 76

77 78 79 80

81 82 83 84

85 86 87 88

89 90 91 92

93 94 95 96

97 98 99 100

BRILLIANCE RESONANCE TOUCH RESPONSE VCF VCF

PITCHBEND SPEED

INITIAL TOUCH RESPONSE AFTER

KEYBOARD CONTROL

BRILLIANCE LOW HIGH LEVEL LOW HIGH

VOLUME

EXP EXP MAX

FOOT PEDAL SELECTOR

SHORT SUSTAIN PORTAMENTO GLISSANDO

ON SUSTAIN PORTAMENTO GLISSANDO FOOT SWITCH

SPEED DEPTH

FAST 0 100% ON ON NOISE

SLOW SPEED PWM PW NOISE

VCO

LOW HIGH HIGH HIGH V +3 LONG LONG LONG

AMP RES- LP RES. K AL SHORT SHORT SHORT

VCF LEVEL VCA

INITIAL TOUCH RESPONSE AFTER

BRILLIANCE LEVEL BRILLIANCE LEVEL

PITCH DETUNE CH3

ATTACK TIME DELAY TIME RING MODULATOR DEPTH SPEED MODULATION

FUNCTION

SUB OSCILLATOR SPEED VCO VCF VCA

FEET - 8

1 2 3 4 5 6 7 8

9 10 11 12

13 14 15 16

17 18 19 20

21 22 23 24

25 26 27 28

29 30 31 32

33 34 35 36

37 38 39 40

41 42 43 44

45 46 47 48

49 50 51 52

53 54 55 56

57 58 59 60

61 62 63 64

65 66 67 68

69 70 71 72

73 74 75 76

77 78 79 80

81 82 83 84

85 86 87 88

89 90 91 92

93 94 95 96

97 98 99 100

BRILLIANCE RESONANCE TOUCH RESPONSE VCF VCF

PITCHBEND SPEED

INITIAL TOUCH RESPONSE AFTER

KEYBOARD CONTROL

BRILLIANCE LOW HIGH LEVEL LOW HIGH

VOLUME

EXP EXP MAX

FOOT PEDAL SELECTOR

SHORT SUSTAIN PORTAMENTO GLISSANDO

ON SUSTAIN PORTAMENTO GLISSANDO FOOT SWITCH

SPEED DEPTH

FAST 0 100% ON ON NOISE

SLOW SPEED PWM PW NOISE

VCO

LOW HIGH HIGH HIGH V +3 LONG LONG LONG

AMP RES- LP RES. K AL SHORT SHORT SHORT

VCF LEVEL VCA

INITIAL TOUCH RESPONSE AFTER

BRILLIANCE LEVEL BRILLIANCE LEVEL

PITCH DETUNE CH3

ATTACK TIME DELAY TIME RING MODULATOR DEPTH SPEED MODULATION

FUNCTION

SUB OSCILLATOR SPEED VCO VCF VCA

FEET - 8

1 2 3 4 5 6 7 8

9 10 11 12

13 14 15 16

17 18 19 20

21 22 23 24

25 26 27 28

29 30 31 32

33 34 35 36

37 38 39 40

41 42 43 44

45 46 47 48

49 50 51 52

53 54 55 56

57 58 59 60

61 62 63 64

65 66 67 68

69 70 71 72

73 74 75 76

77 78 79 80

81 82 83 84

85 86 87 88

89 90 91 92

93 94 95 96

97 98 99 100

BRILLIANCE RESONANCE TOUCH RESPONSE VCF VCF

PITCHBEND SPEED

INITIAL TOUCH RESPONSE AFTER

KEYBOARD CONTROL

BRILLIANCE LOW HIGH LEVEL LOW HIGH

VOLUME

