

Auto Rhythm Section

Yamaha Electone model B-10BR incorporates an auto rhythm section. This section provides a variety of rhythm accompaniments, from latin beats to today's popular rock rhythms, at the simple push of a selector button.

In addition, the system employs the exclusive Yamaha Synchro-start, which automatically begins the rhythm accompaniment when the first lower manual or pedal note is struck. These features assure extra versatility from a virtual built-in rhythm band.

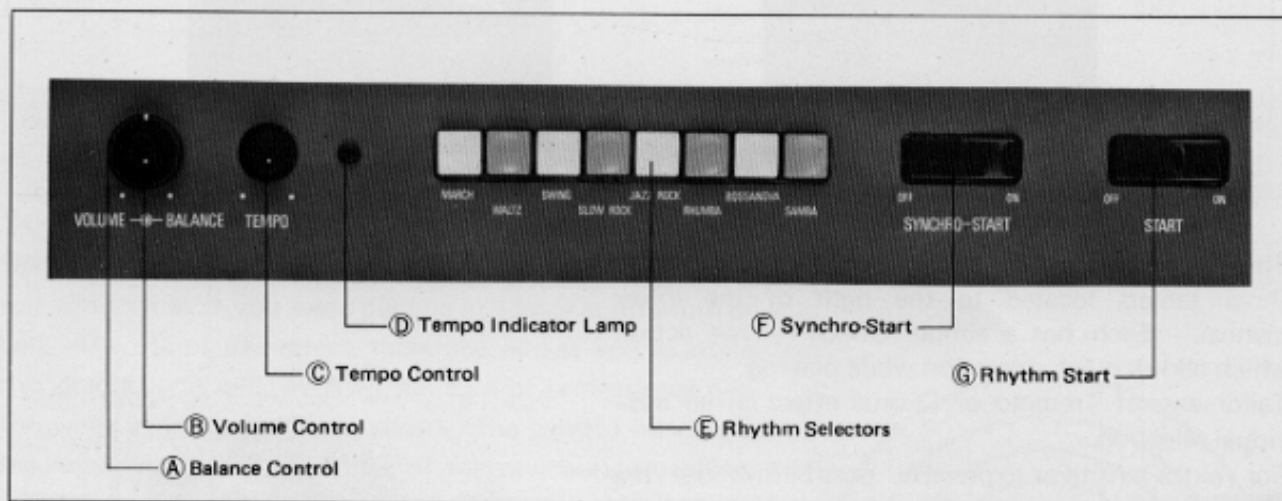

How to Use the Auto Rhythm Section

- 1) Push the rhythm selector (E) of your choice. To change rhythms, just push another button.
- 2) Press the Rhythm Start tablet (G) and the rhythm will immediately begin. Then use the Balance (A) Volume (B) and Tempo (C) controls to regulate. The tempo indicator lamp (D) flashes the first beat of every rhythm.
- 3) Then, when ready to play, switch on the Rhythm Start tablet (G) and begin your selection after the beat is fixed in your mind. Use the tempo indicator lamp as a guide.
- 4) For more advanced players, use the Synchro-start tablet (F) instead. This permits the selection to begin first, providing a more impressive performance that can begin with a beat-free upper melody. This Yamaha exclusive is the world's first of its kind, and will assure more professional-sounding selections for any advanced player.
- 5) At the end of the selection, turn the Rhythm Start or Synchro-start tablet off.
- 6) This B-10BR incorporates a Rhythm Start/Stop Switch on the left side of expression pedal. By moving the toe of foot controlling the expression pedal toward left, you may stop the Auto Rhythm with Rhythm Start/Stop Switch. By the same action; you may start the Auto Rhythm.
- 7) Indicator lamp is incorporated in the Auto Rhythm Section. Regardless of Rhythm Selector is on or not, lamp keeps on if the Switch mentioned in (6) works at Rhythm Start side remaining the state of Start Switch is pressed. If either of both is at the side of Rhythm Stop, almp does not work.

Other Controls

Knee Lever : (P)

The metal lever folded horizontally under the keybed is the Knee Lever. This lever, when pulled down for use, allows control of Reverb effect in conjunction with Reverb Control (20). (See page 12.)

Reverb Control is used for maximum setting, while the Knee Lever is operated with the right knee for passage-by-passage or even phrase-by-phrase reverb control precision during the performance.



Master Volume Control : (J)

The knob determines the maximum volume obtained from the Electone and can be varied as desired.

Expression Pedal : (Q)

Expressive shading within each phrase, and accenting of individual notes can be achieved with this pedal, within the overall range set by the Master Volume Control. A full explanation will appear on page 23.

Rhythm Stop / Start Foot Switch : (R)

This reversible switch on the left side of expression pedal can be worked by pushing to left.

Stunning furniture design, roll-top fallboard

The cabinet artistry of the B-10BR blends with even the most impeccable decorator surroundings, especially when the rolltop fallboard is down. Close it to protect the keyboard from dust and scratches, keep out unauthorized hands.



To Fully Enjoy Your Electone . . .

Besides many tone levers and effect controls through which almost infinite varieties of voice and expression can be obtained, the Yamaha Electone B-10BR offers you some extra special features to further enhance your playing pleasure.

Headphone Jack

Plug a headphone set (optional accessory) into the jack under the keyboard and you can play with the volume as high as you like without disturbing anyone, even in the middle of the night.



Recording and Playback

You can record your Electone selections via the headphone jack, then play them back via Ext. In. jack.

For recording, your tape recorder must be equipped with a high impedance input jack, for Electone headphone output signal is 40 Vp-p (output resistance 390 ohm). When recording, it must be remembered that the signal to the Electone speaker will be cut off, so sound monitoring must be done via the tape recorder monitor system.

Playback by connecting the tape recorder output jack to the Electone Ext. In. jack. In this case a special phone type plug must be used.

External Input Jack

This jack is located at the lower lefthand corner of the back of the Electone (See photo right above). It allows you to connect a tape recorder, record player or radio directly, using the amplifier and Natural Sound speaker of the Electone. Thus these external inputs will come to life under Natural Sound reproduction and give you an opportunity to broaden your musical experience. Since their tones are not controlled by the expression pedal, you can play a tape recording or record of an orchestral concert and 'sit in' yourself on the Electone.

Alternatively, you can record yourself playing a piano or the Electone, replay the tape, and be your own duet partner.

In addition, the 'Minipops', a rhythm cabinet distributed by Yamaha, may be connected here for even more advanced percussion effects.

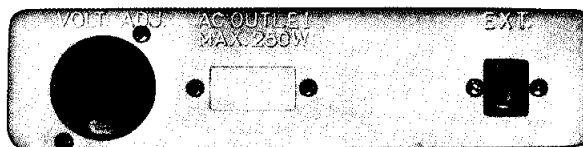

Note:

1. Connect the EXT. IN Jack and the output jack of a tape recorder with shielding wire. Use a spare plug inserted in the EXT. IN Jack.
2. Volume setting for playback tends to differ with the make or model of tape recorder.
3. Adjust the volume of the Electone and the tape recorder to avoid distortion of the sound quality.
4. Make absolutely sure never to touch or otherwise interfere with the circuits or internal elements of the Electone.

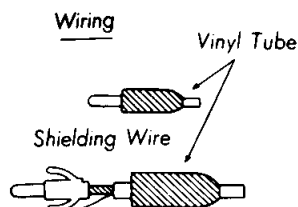

A Word about Yamaha's Exclusive Natural Sound Speaker

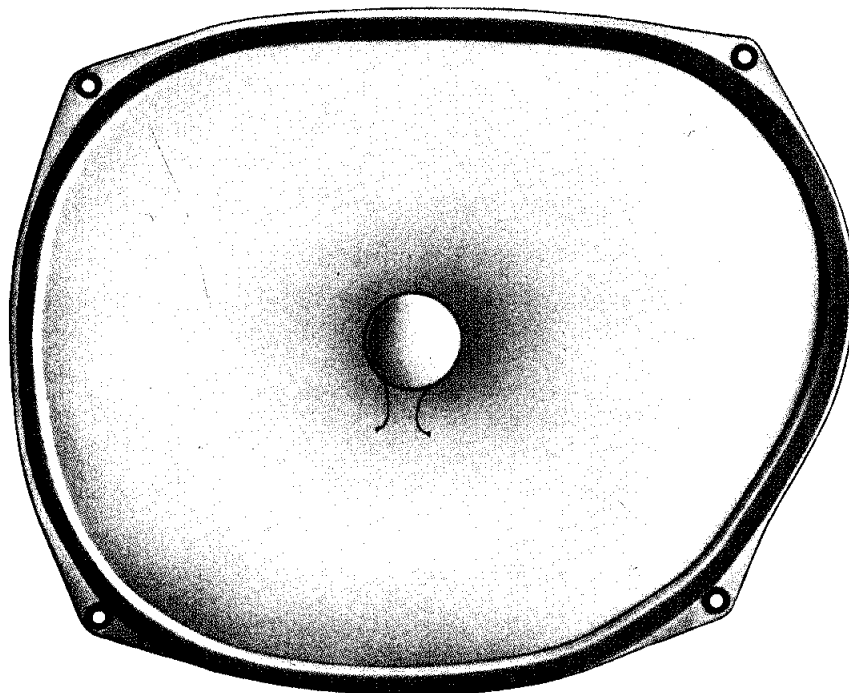

Natural Sound Speaker

The first real speaker news since the cone speaker was born decades ago. Providing an incredible frequency response down to 32Hz, it gives you all the harmonic overtones usually missed in conventional types. What's more, it pro-

jects as well to the front and back, and its all-new synthetic base assures years of trouble-free, living performance in any room, with tonal beauty perfectly attuned to the human ear.

SPECIFICATIONS OF MODEL B-1OBR

KEYBOARDS

Upper Manual	44 keys f ~ c ₄ (3 3/4 octaves)
Lower Manual	44 keys F ~ c ₃ (3 3/4 octaves)
Pedals	13 keys C ₁ ~ C (1 octave)

TONE LEVERS

Upper Manual	Flute	16'
	Flute	8'
	Brass	8'
	Oboe	8'
	String	8'
	Flute	4'
Lower Manual	Flute	2 3/4'
	Wood	8'
	Horn	8'
	Cello	8'
	Wood	4'
Pedals	Bass	16'
	Bass	8'

EFFECT LEVERS

Vibrato
Percussive 4' (Upper)
Percussive 2 3/4' (Upper)
Percussive Length (Upper)
Repeat Speed (Upper)
Pedal Sustain

EFFECT CONTROLS

Brilliance
Reverb
Reverb Balance
Manual Balance

TREMOLO SELECTORS

Voice (Main/Tremolo)
Tremolo
Chorus

AUTO RHYTHM SECTION*

Rhythm Selectors	
Swing	Bossanova
Waltz	Rhumba
Slow Rock	Beguine
Jazz Rock	Cancel
Rhythm Controls	
Rhythm Start	
Synchro-Start	
Tempo	
Volume	
Tempo Indicator Lamp	

OTHER CONTROLS

Master Volume
Expression Pedal
Knee Lever
Power Switch
Pilot Lamp

OTHER FITTINGS

Headphone Jack
External Input Jack
Music Rest
Roll-top Fallboard
Matching Bench with Music Storage Space

NATURAL SOUND SPEAKERS

Main:	JA-5101 59 x 48 cm (23 3/4 x 14 1/2")
Tremolo:	JA-1701 16 x 23 cm (6 1/2 x 9")
	Electro-control 2-speed with continuous tremolo speed control

CIRCUITRY

Solid State (Incl. ICs and FET)
Main Amplifier: OCL System
Output Power: 30 Watts
Power Consumption: 90 Watts
100/110/117/125/220/240V AC
50/60Hz

DIMENSIONS

Width:	111 cm (43 3/4")
Depth:	56 cm (22")
Height:	90 cm (35 1/2")

WEIGHT 64 kg (140 lbs.)

* B-10AR only Specifications subject to change without notice.

Care of Your Electone

In general you should treat your Electone with the same care you would give any fine musical instrument. However, the following points are suggested to assure optimum enjoyment.

1. Be sure to use your Electone only on the correct voltage. If it is necessary to change the voltage of the Electone, please consult your Yamaha Electone service agent.
2. If any trouble develops, contact your Yamaha Electone service agent. In any case make absolutely sure never to touch or otherwise interfere with the circuits or the internal elements of the Electone.
3. When you have finished playing, be sure to turn off the power switch.
4. In order to clean the plastic keys, tabs, etc., use a damp cloth. Never apply organic solvents such as alcohol as it may result in damage to the plastic materials used.
5. Do not expose the Electone cabinet to the direct rays of the sun, as this may result in bleaching of the finish or separation along the joints of the wood.
6. Be absolutely sure never to strike or scratch the surface of the organ cabinet with a hard stuff.
7. It is also advisable to place the Electone in such a way that it is not exposed to excessive humidity or currents of heated air.
8. In opening and closing the fallboard, grasp the handle with both hands and slide the fallboard gently in its groove. Never attempt to raise the fallboard directly upwards and do not place heavy objects on it.
9. During a thunderstorm turn off the Electone power switch by all means. Unplug the unit if possible.



Do not Be Alarmed If...

1. A note should sound the instant you turn on the switch.

This merely indicates normal operation consequent to a flow of electricity in the main amplifier.

2. Only one note is produced even when two pedals are depressed simultaneously..

When the pedal sustain effect is used, notes overlap following notes. In order to achieve tonal clarity, the Electone is designed so that a note is electronically suppressed the instant the next note is struck. If two pedals are struck simultaneously, only the higher one sounds.

3. Flute $2\frac{2}{3}$ ' voice is not obtainable from keys above F in the highest octave.

This means that the highest note which the Electone B-10A can produce is cs. (See the Compass chart on page 7.)

4. Neighboring objects resonate.

Since the Electone produces a continuous stream of sound, windows, china or other such objects may be found to resonate. To prevent this, reduce the volume of the Electone or take steps to remove resonance.

5. Occasional unpleasant static.

In the majority of such cases, the cause can be traced to the turning on or off of refrigerators, washing machines, electric pumps or other household appliances. Electrical fault in a neighboring outdoor neon sign may also be to blame.

When the cause is a home appliance, connect the Electone to an outlet as far as possible away from the offending appliance. This phenomenon, although perhaps annoying, poses no danger to the Electone's circuitry.

If the cause is a fault in neon or fluorescent lighting fixtures, the fault should be repaired. When the cause is unknown, or in case of doubt, contact your Yamaha dealer.

6. The Electone reproduces radio or TV sound signals.

This kind of phenomenon can occur when there is a powerful radio or TV transmitter, or an amateur radio operator located in the vicinity. If this situation is distracting, contact your Yamaha dealer.

HOW TO SET UP THE BENCH

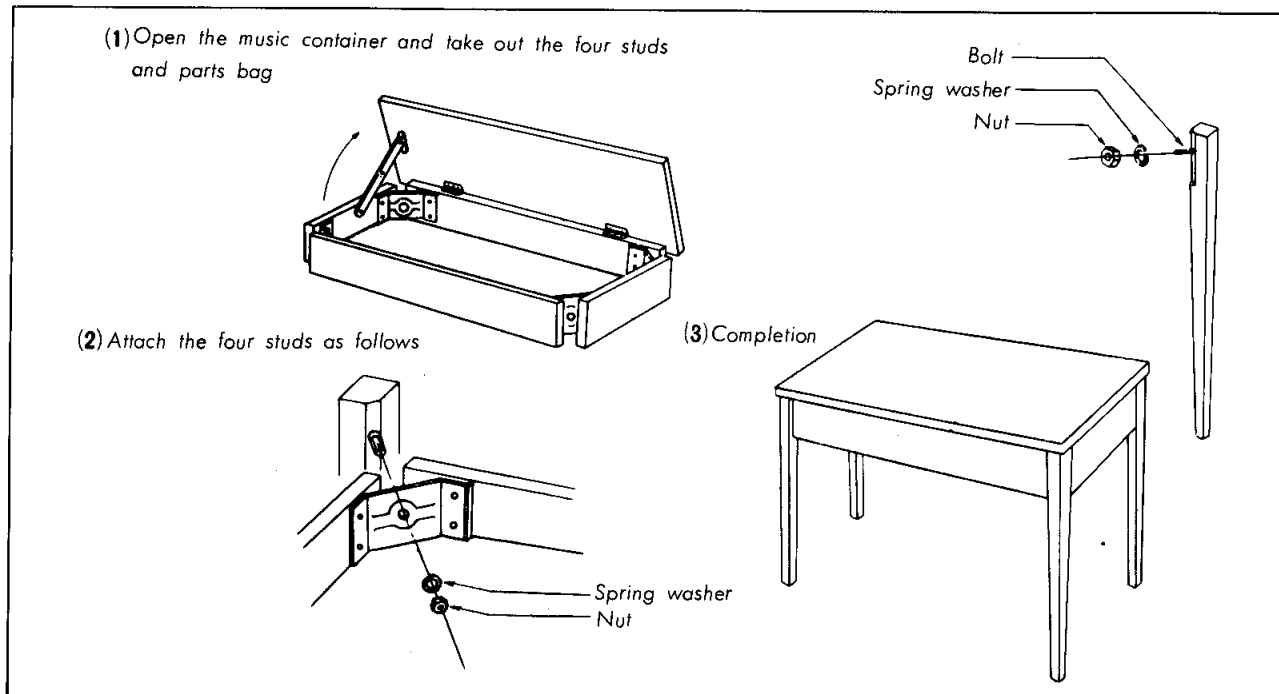

Playing the Yamaha Electone

Posture

- 1.** Sit in the middle of the seat somewhat towards the front. The weight should be shifted slightly to the right in order to allow the left leg greater freedom of movement.
- 2.** The right hand generally fingers the upper manual (*melody*) and the left hand fingers the lower manual (*harmony*) while the pedals (*rhythm*) are played with the left foot. Check that you can reach all the keys on the three keyboard conveniently.



- 3.** Relax the muscles of the left leg, and with the knee joint loose, move the foot left and right. Keeping the ankle loose, push the pedals just short of the black pedals.

- 4.** Relax the right ankle and place the full length of the foot onto the Expression pedal. Check that you can push the pedal down fully with comfort, and that you are equally comfortable at all positions of the Expression pedal.



Technique

How to Play the Manuals

Clench both fists and then relax extending the fingers naturally. This form allows the fingers to move more quickly and easily, and is therefore applicable to all keyboard instruments.

Correct use of the fingers is essential to play a beautiful Electone music. The melody part should in general be played with *the organ legato touch*. In order to achieve the legato playing it is necessary to poise the finger in readiness above the key to be struck next. Many rules may be applied to the correct fingering, but in any case a most economical and rationalized use of the fingers is desirable.

Legato

1. It is important to practice to achieve the organ touch that will produce a smoothly continued legato without distracting overlap.
2. The melody part should in general be played legato. But in order to emphasize the legato it is necessary to take "breaths" at the ends of phrases.
3. Passages involving duet harmony often require difficult modification of legato fingering. In this case it will be useful to practice these parts separately.

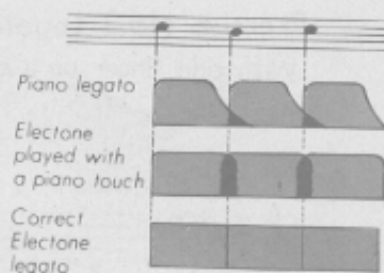

Staccato

1. Since the duration of the note can be regulated very easily by the length of time the key is depressed, it is possible to obtain a wide variation in staccato treatment.
2. Generally a rhythm accompaniment with the left hand should be played staccato. A shorter staccato will generally be suited to rhythmical compositions while longer one to slow pieces. You should always try to choose the precise length that fits the work best.

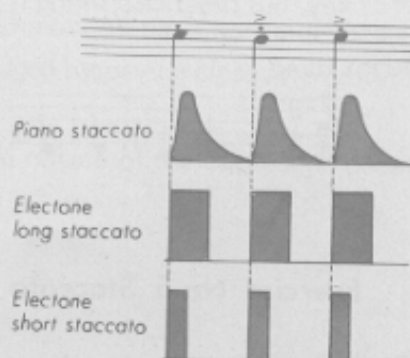

Note : The habit should be formed early of holding the hands correctly, and striking the keys to the bottom of their travel.

- * In order to play *Legato* and *Staccato*, the following techniques are often used and should be learned.

Exercise No.1 Legato (normal fingering)

Right Hand 1 2 3 4 5 4 3 2 1 3 5 3 1

Left Hand 5 4 3 2 1 2 3 4 5 3 1 3 5

Exercise No.2 Legato (finger substitution)

While depressing a key, you keep one key activated without stopping by quickly substituting the finger on the key with another finger.

1 1 2 3 4 2 3 5 4 3 2 5 1 3 4 - 1 5 4 3 2 3

Exercise No.3 Legato (finger passing)

With one finger on a key, bring another finger over or under the first and depress the next key.

5 2 1 2 1 2 3 1 2 5 2 1 2 1 2 3 5 1 2

Exercise No.4 Depressing the same key successively several times

When you strike the same key repeatedly, don't remove your finger completely from the key, but practice striking it repeatedly as soon as the sound stops.

Right Hand 1 2 1, 3 4 5 2, 3 1 2 1

Exercise No.5 Staccato

Right Hand 1 3 5 3 4 2 1 2

Left Hand 5 3 1 3 2 3 5 4

How to play the Pedals

1. Sitting always in the right and same position will enable you to play the correct pedal notes without looking at the pedals. (See 'Posture' on page 24).
2. The best approach to the pedals is to allow the lower leg to swing freely from the knee.
3. Pedals should be struck with the light movement of the ankle.
Be careful not to beat them with unnatural movement of your whole leg.
4. Do your best to achieve pedal playing without looking at the pedals as soon as possible.
5. Before commencing actual performance, it will be very effective to practice rhythm and scale on the pedals. In pedal exercises, it will be helpful to give slightly greater tone lever emphasis to the pedals.
6. Flat and light shoes are desirable. It is not good to play pedals with high-heel.



How to use the Expression Pedal

The Expression Pedal controls the volume of the Electone during performance within the overall range set by the Master Volume Control. It should be depressed gently for *crescendo* released gradually for *diminuendo*. Please be careful to use this pedal with discretion. The expression should follow the natural course of the work, and should never be intrusive.

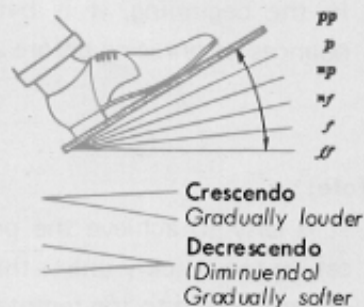

In Phrasing

1. Natural phrasing usually indicates a soft entry to a passage and a subsequent softening at the end.
2. Variety of phrasing is attained with gradual, not sudden, movements of the Expression pedal.
3. The melody requires a 'songful' expression which can best be judged by paying close attention to the melodic line.
4. It is relatively easy to achieve a gradual *crescendo*, but the gentle release of the Expression pedal in *diminuendo* requires more care.

Exercise No.6



Throughout a Composition

1. Each musical composition is composed of a number of phrases. A phrase marked *f* would be played somewhat more loudly; one marked *p* more softly. It is important to keep the overall balance in mind.
2. The full range of the Expression pedal should be used, but not so excessively that it becomes intrusive or unnatural.

1st phrase. 2nd phrase 3rd phrase 4th phrase

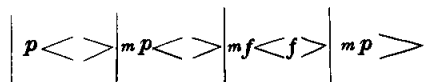

Note: Unnatural sounds are the result of not using the right foot smoothly enough. Listen closely as you progress to eliminate these undesirable distractions.

Accent

1. Suddenly depressing the Expression pedal and then partially releasing it will add accent.
2. If accent is used too freely, its effectiveness will be diminished.
3. The pedal should be released smartly.
4. In the beginning, it is better to master the nuances of phrasing before attempting accent.

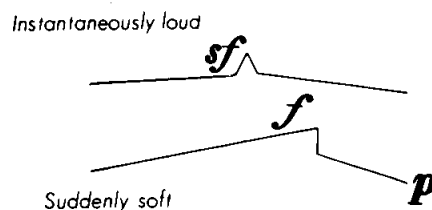

Note:

1. It is easy to achieve the proper crescendo when depressing the pedal, but it has a tendency to return too quickly unless this is prevented by careful use of the foot.
2. Do not give in to the temptation to accent one beat in every bar.
3. Crescendo passages should peak at the point where notation indicates.
4. At first, it is necessary to give conscious attention to expression, but practice is not sufficient until this aspect is entirely automatic and instinctive.
5. Even the same composition may require differing expressive treatment depending on the tempo at which it is played.
6. Rhythmical works will be enhanced with a little accent.
7. Expressive treatment can be truly effective only when the organist has truly grasped the essence of the composer's musical intention.

How to reset Levers, Controls and Selectors

When the notation calls for resetting the tone levers, effect levers, effect controls, etc. midway through a piece, this should be accomplished with either hand as convenient, in such a way as not to interrupt the melodic line.

Changes in tone lever settings may influence the relative volume of the upper and lower manuals. This can be corrected using the Manual Balance Control.

SINCE 1887



YAMAHA

NIPPON GAKKI CO., LTD. HAMAMASTU, JAPAN