

# Technics

DIGITAL PIANO

SX-PX665



**WARNING:**

**TO REDUCE THE RISK OF FIRE, ELECTRIC SHOCK OR PRODUCT DAMAGE, DO NOT EXPOSE THIS APPLIANCE TO RAIN, SPLASHING, DRIPPING OR MOISTURE.**

BEFORE YOU PLAY, PLEASE READ THE CAUTIONARY COPY APPEARING ON PAGE 4.

**CAUTION:**

This equipment has been tested and found to comply with the limits for a Class B digital device, pursuant to Part 15 of the FCC Rules. These limits are designed to provide reasonable protection against harmful interference in a residential installation. This equipment generates, uses and can radiate radio frequency energy and, if not installed and used in accordance with the instructions, may cause harmful interference to radio communications. However, there is no guarantee that interference will not occur in a particular installation. If this equipment does cause harmful interference to radio or television reception, which can be determined by turning the equipment off and on, the user is encouraged to try to correct the interference by one of the following measures:

- Reorient or relocate the receiving antenna.
- Increase the separation between the equipment and receiver.
- Connect the equipment into an outlet on a circuit different from that to which the receiver is connected.
- Consult the dealer or an experienced radio/TV technician for help.

Any unauthorized changes or modifications to this equipment would void the user's authority to operate this device.

This device complies with Part 15 of the FCC Rules. Operation is subject to the following two conditions: (1) This device may not cause harmful interference, and (2) this device must accept any interference received, including interference that may cause undesired operation.



**CAUTION**

**RISK OF ELECTRIC SHOCK  
DO NOT OPEN**



**CAUTION:** TO REDUCE THE RISK OF ELECTRIC SHOCK, DO NOT REMOVE SCREWS. NO USER-SERVICEABLE PARTS INSIDE. REFER SERVICING TO QUALIFIED SERVICE PERSONNEL.



The lightning flash with arrowhead symbol, within an equilateral triangle, is intended to alert the user to the presence of uninsulated "dangerous voltage" within the product's enclosure that may be of sufficient magnitude to constitute a risk of electric shock to persons.



The exclamation point within an equilateral triangle is intended to alert the user to the presence of important operating and maintenance (servicing) instructions in the literature accompanying the appliance.

The model number and serial number are found underneath the keyboard.

Please note the model and serial numbers in the space provided below and retain this sheet as a permanent record of your purchase to aid identification in the event of theft.

MODEL NUMBER \_\_\_\_\_

SERIAL NUMBER \_\_\_\_\_

# Technics

## OWNER'S MANUAL

### Before you play

For long and pleasurable use of this instrument, and to gain a thorough understanding of your **PX665** Digital Piano, it is strongly recommended that you read through this Owner's Manual once.

The Owner's Manual is comprised of the following parts.

#### **Preparative**

This part includes an explanation of how to set up to play the instrument and basic knowledge for playing.

#### **Various Functions**

This part comprises a detailed explanation of sound, effect, rhythm, **SEQUENCER**, Disk Drive and MIDI.

#### **REFERENCE GUIDE (separate booklet)**

Reference guide for the contents of the **SOUND**, MIDI Implementation Chart, etc.

# Important Safety Instructions

## WARNING

When using electric products, basic precautions should always be followed, including the following:

- Read all the instructions before using the product.

## Safety

- **Power Source**—The product should be connected to a power supply only of the type described in the operating instructions or as marked on the product.
- **Polarization**—This product may be equipped with a polarized line plug (one blade wider than the other). This is a safety feature. If you are unable to insert the plug into the outlet, contact an electrician to replace your obsolete outlet. Do not defeat the safety purpose of the plug.
- **Periods of Non-use**—The power-supply cord of the product should be unplugged from the outlet when left unused for a long period of time.

## Installation

- **Water and Moisture**—Do not use this product near water—for example, near a bathtub, washbowl, kitchen sink, in a wet basement, or near a swimming pool, or the like.
- **Cart/Stand**—This product should be used only with a cart or stand that is recommended by the manufacturer.
- **Ventilation**—The product should be located so that its location or position does not interfere with its proper ventilation.
- **Heat**—The product should be located away from heat sources such as radiators, heat registers, or other products that produce heat.
- **Foreign Material**—Care should be taken so that objects do not fall and liquids are not spilled into the enclosure through openings.

## Listening caution

This product, either alone or in combination with an amplifier and headphones or speakers may be capable of producing sound levels that could cause permanent hearing loss. Do not operate for a long period of time at a high volume level or at a level that is uncomfortable. If you experience any hearing loss or ringing in the ears, you should consult an audiologist.

## Service

- **Damage Requiring Service**—The product should be serviced by qualified service personnel when:
  - a. The power-supply cord or the plug has been damaged; or
  - b. Objects have fallen, or liquid has been spilled onto the product; or
  - c. The product has been exposed to rain; or
  - d. The product does not appear to operate normally or exhibits a marked change in performance; or
  - e. The product has been dropped, or the enclosure damaged.
- **Servicing**—Do not attempt to service the product beyond that described in the user-maintenance instructions. All other servicing should be referred to qualified service personnel.

## Maintenance

- Be sure to switch this unit off after use, and do not switch the unit on and off in quick succession, as this places an undue load on the electronic components.
- To maintain the luster of the keys and buttons, wipe with a clean, damp cloth, and polish with a soft, dry cloth. Polish may be used, but do not use thinners or petro-chemical-based polishes.
- A wax-based polish may be used on the cabinet, although you will find that rubbing with a soft cloth will suffice.

**SAVE THESE INSTRUCTIONS**

# Contents

---

Important Safety Instructions .....	4
<b>Preparative</b>	
Getting started .....	6
Listen to the demonstration .....	7
Controls and Functions .....	8
About the display .....	10
<b>Various Functions</b>	
<b>Part I Sounds and effects</b> .....	11
Selecting sounds .....	11
Touch Sensitivity .....	12
Effects .....	12
Mixing two sounds (DUAL) .....	14
Assigning different sounds (SPLIT) .....	15
Transpose .....	18
Metronome .....	19
<b>Part II Sequencer</b> .....	20
Record your performance .....	20
Sequencer playback .....	22
Sequencer settings .....	23
<b>Part III Disk Drive</b> .....	27
Outline of the Disk Drive function .....	27
Disk play .....	28
Saving data .....	30
<b>Part IV Control functions</b> .....	33
<b>Part V MIDI</b> .....	35
MIDI .....	35
Setting the MIDI functions .....	36
Connections .....	39
Symptoms which appear to be signs of trouble .....	40
Initialize .....	41
Assembly .....	42
Error messages .....	44
Specifications .....	45
Demo Performance List .....	46

**Supplied accessory**

Please check the supplied accessory.



**AC cord**

# Getting started

1 Plug the power cord into an outlet.

2 Press the **POWER** button to turn it on.

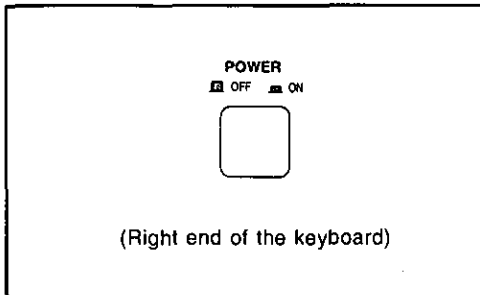

- The indicator lamp at the left on the front of the piano lights up when the power is turned on.

3 Play the keyboard.  
• Set the **MAIN VOLUME** to an appropriate level with the sliding control.

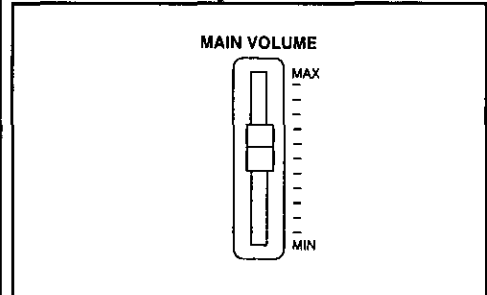

- No sound will be heard when the sliding control is set to **MIN**.

## Tuning

Unlike an acoustic piano, your Digital Piano never needs tuning.

- The pitch of this instrument can be adjusted when playing along with other instruments. (Refer to page 34.)

## Keyboard cover

Open and close the cover slowly.

- Be careful not to pinch your fingers when opening or closing the cover.

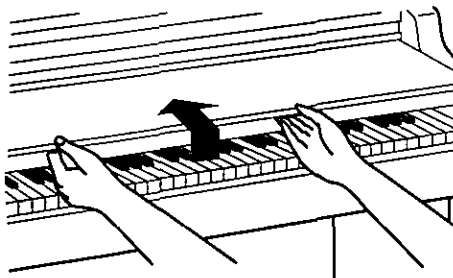

## Music stand

To set up the music stand, gently raise it from its folded down position. It will lock into place automatically.

To lower the music stand, first fold in the metal support at the rear of the stand and then lower the stand gently, as shown in the figure.

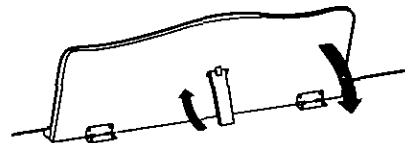

# Listen to the demonstration

Automatic performances which introduce you to the sounds are stored in the memory of this piano.

1 Press the **DEMO** button.

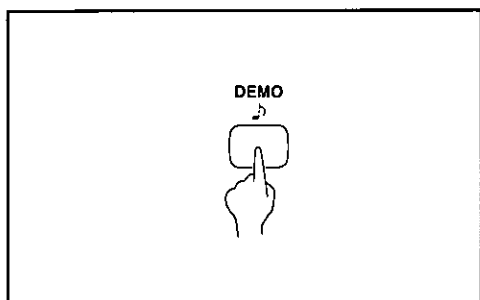

- The indicators for the **SOUND** buttons flash.
- The display changes to the DEMO PLAY display.

3 When you have finished listening to the demonstration performances, press the **DEMO** button again.

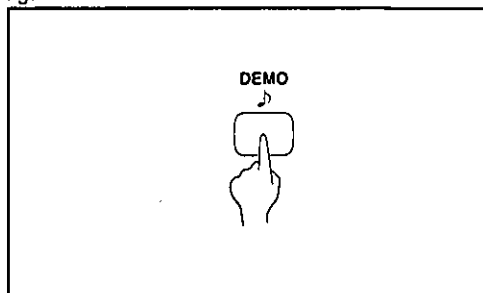

## Listen to all the demonstration tunes in order.

2 Select a sound you wish to hear.

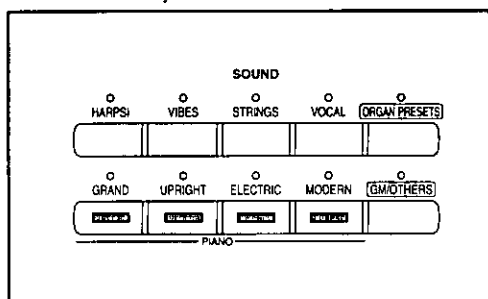

- The demonstration tune starts.
- The indicator of the selected **SOUND** button flashes and the other indicators go out.
- If the button for the current demo is pressed, the demonstration performance stops.
- Listen to the demonstration tunes for the other sounds in the same way.

■ **GRAND, ORGAN PRESETS, GM/OTHERS**  
Several demonstration tunes are available for **GRAND, ORGAN PRESETS** and **GM/OTHERS**. Press one of these buttons and then select one of the buttons with a flashing indicator.

Press and hold the **DEMO** button for a few seconds.

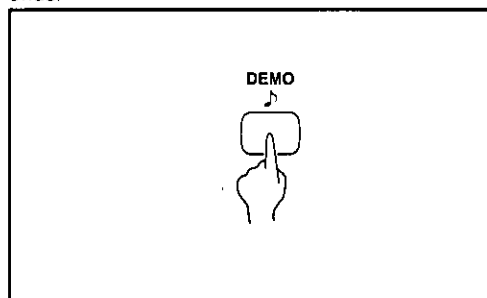

- All the demonstration tunes are automatically played in order.
- If you press the button with the flashing indicator during the demonstration performance, the current tune stops and the next tune begins.
- You can also first press the **DEMO** button and then the **PLAY** button to play the tunes in order.
- The tunes are repeated in order until the **DEMO** button or **STOP** button is pressed again.

- You can play the keyboard while the demonstration performances are playing.
- Some of the buttons do not function while the demonstration performances are being played.

- The demonstration performance data cannot be output as MIDI data.

# Controls and Functions

## SOUND

Press one of the **SOUND** buttons, and then use the **SOUND VARIATION** buttons to select the desired sound. (Refer to page 11.)

Each sound features Touch Response, which increases the volume when the keyboard is played harder.

- The sounds can be mixed when two **SOUND** buttons are pressed simultaneously. (Refer to page 14.)
- You can split the keyboard into right and left sections and assign a different sound to each section. (Refer to page 15.)
- On this piano, the maximum number of notes which can sound simultaneously is 64. (Lower range notes have priority over higher range notes.)

## DISPLAY

Displays performance information, function settings and other messages. (Refer to page 10.)

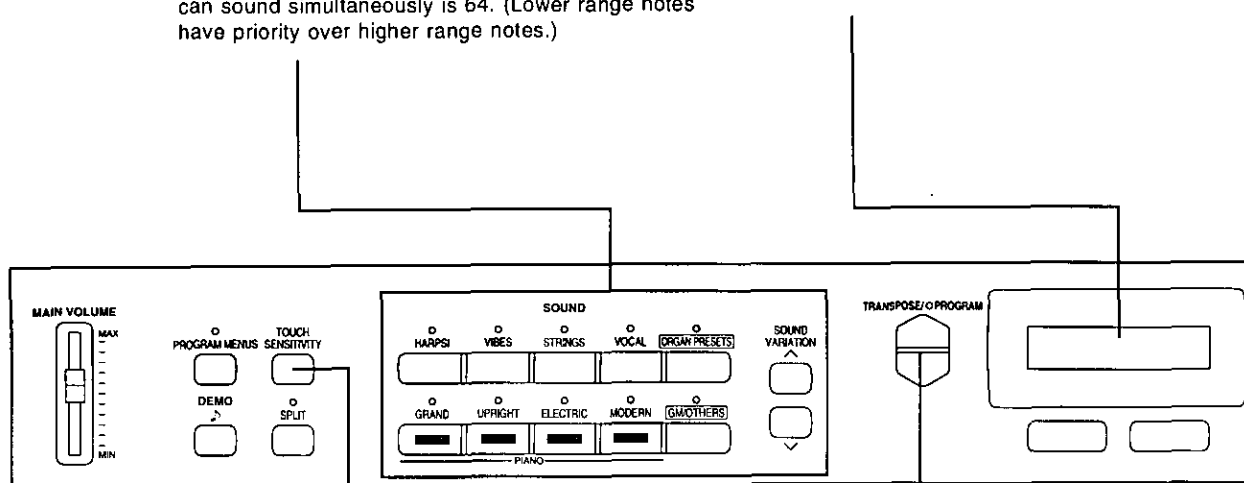

## TOUCH SENSITIVITY

The keyboard touch (Touch Response) can be changed to match your type of playing. (Refer to page 12.)

## TRANPOSE

Raise or lower the key of the entire keyboard. (Refer to page 18.)

## Sostenuto pedal

The middle pedal is used as a sostenuto pedal. If the pedal is pressed while the keys are pressed, a sustain effect is applied to those notes only.

- For sustained-type sounds (**ORGAN PRESETS, STRINGS, VOCAL, etc.**), the notes sound for as long as the pedal is depressed.

## Soft pedal

The left pedal can be used as a soft pedal. When the pedal is depressed, the sound is softer.

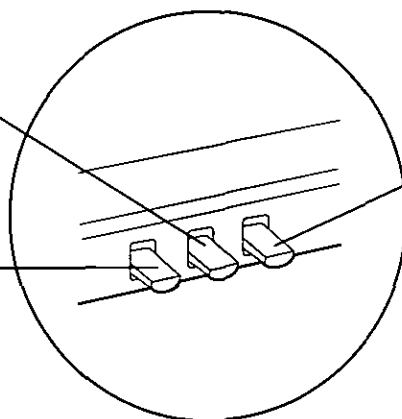



## EFFECT

Add various effects to the sounds.  
(Refer to page 12.)

## METRONOME

Perfect your playing by practicing in time with the metronome. (Refer to page 19.)

## DISK DRIVE

You can store your recorded songs on a floppy disk, as well as play back commercial song disks.  
(Refer to page 27.)

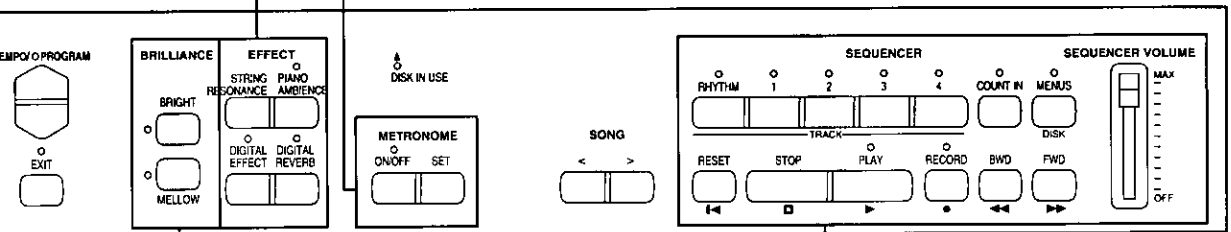

## BRILLIANCE

The **BRILLIANCE** allows you to select the brightness of the sound from 5 settings. (Refer to page 14.)

## SEQUENCER

Record your performance and have it automatically played back. (Refer to page 20.)

## Sustain pedal

The right pedal allows you to use sustain. When a key is released while this pedal is depressed, the sound is sustained so that it lingers and slowly fades out.

- String resonance is added to some sounds. (Refer to page 14.)

## About the backup memory

The instrument settings (except recorded song data) is retained for about one week after the power is turned off.

To save your recorded song data, please store it on a floppy disk before turning off the power. (Refer to page 30.)

- This instrument's recorded song data is retained for about one minute after the power is turned off.

# About the display

The display serves to show various information, such as the names of the sounds you select, and also works as a setting display when you adjust the functions and settings of your instrument.

- The display contrast can be adjusted (Refer to page 34.)

## Normal display

The information below is shown on the normal display.

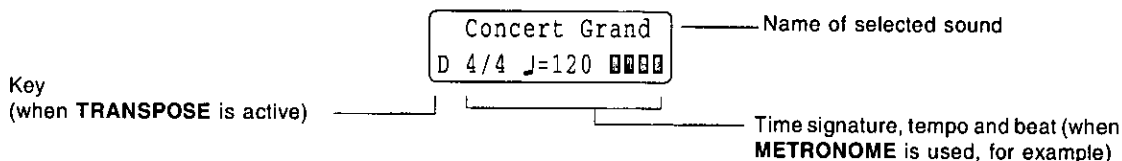

- **TRANSPOSE** is explained on page 18.
- **METRONOME** is explained on page 19.

## Setting display

The display is used to set various functions.

### Example: METRONOME setting display

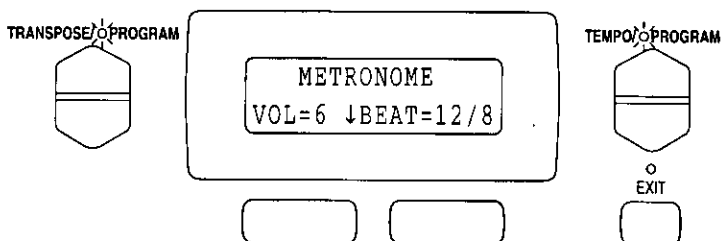

When the instrument is in the function-setting mode, the **TRANSPOSE/PROGRAM** and **TEMPO/PROGRAM** buttons to the left and right of the display become function-setting buttons and are used to select functions and adjust their values. In the function-setting mode, the **PROGRAM** indicators for these buttons are lit.

- The two buttons below the display are sometimes used for function-setting. In these cases, arrows (↓) are shown on the display.
- When the **TEMPO/PROGRAM** indicator flashes, it indicates that you should press the button to execute the procedure (OK).

### Example: INITIALIZE display

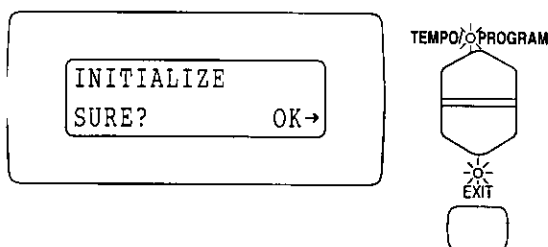

## EXIT

To cancel the function-setting mode, press the **EXIT** button. The display returns to the previous display.

- The **EXIT** button is effective whenever its indicator is flashing.

# Part I Sounds and effects

## Selecting sounds



Select one of the several sounds for your performance.

### SOUND

1. In the **SOUND** section, press a button to select a sound category.

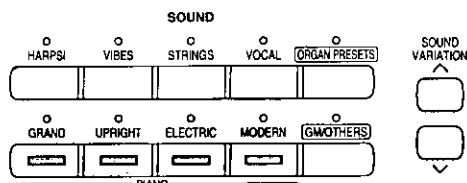

2. Use the **SOUND VARIATION** buttons to select the desired sound from the display.

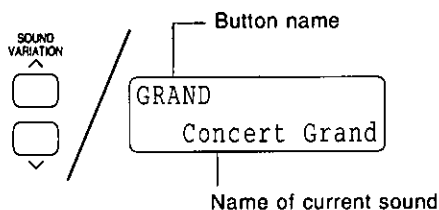

- A few seconds after the setting is changed, the display returns to the normal display.
- Each time either **SOUND VARIATION** button is pressed, a different sound is indicated.
- The **ORGAN PRESETS** and **GM/OTHERS** buttons represent group names rather than sound names. (See the following section.)
- The non-pitched sounds of the **DRUM KIT** group, etc. are accessed with the **GM/ OTHERS** button.
- For information about GM (GENERAL MIDI), refer to page 36.
- The sound you select is memorized and recalled whenever the same **SOUND** button is pressed.
- A list of sounds can be found in the separate sheet.

### ORGAN PRESETS, GM/OTHERS

Because the number of sounds accessed with the **ORGAN PRESETS** and **GM/OTHERS** buttons is so many, you find a sound by first selecting a sound group, and then selecting the desired sound. The procedure is as follows.

1. Press the **ORGAN PRESETS** button or the **GM/OTHERS** button for a few seconds.

- The indicator flashes to show that the setting mode is active.
- The display looks similar to the following.

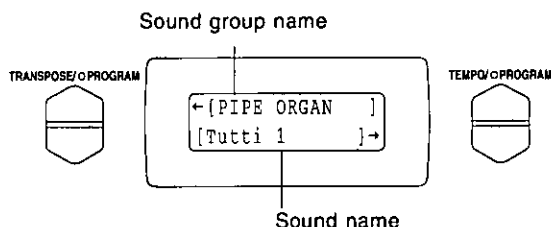

2. Use the **TRANPOSE/PROGRAM** buttons to select a sound group. Then use the **TEMPO/PROGRAM** buttons to select a sound in that group.

- The **SOUND VARIATION** buttons can also be used to select a sound.

3. After you have selected the desired sound, press the **EXIT** button.

# Touch Sensitivity

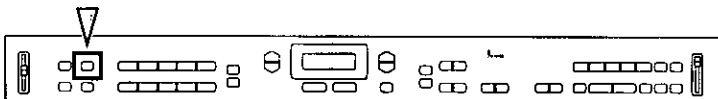

Adjust keyboard touch response.

1. Press the **TOUCH SENSITIVITY** button.



• The display looks similar to the following.

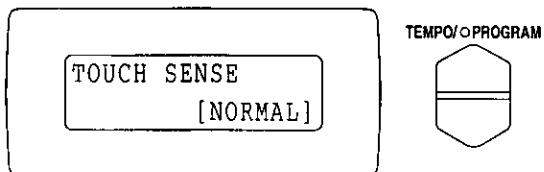

2. Use the **TEMPO/PROGRAM** buttons to adjust the setting.

- Select from **HEAVY**, **NORMAL** and **LIGHT**.

3. When you have finished adjusting the settings, press the **TOUCH SENSITIVITY** or **EXIT** button.

# Effects

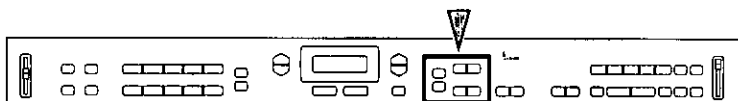

You can achieve even fuller and stirring sounds by adding various effects.

## DIGITAL EFFECT

**DIGITAL EFFECT** gives the sound richness and enhances your performance.

Press the **DIGITAL EFFECT** button to turn it on.



- The on or off status of the **DIGITAL EFFECT** is preset for each sound.
- This effect does not work for the sounds in the **DRUM KITS (GM/OTHERS)** sound group.
- This effect may not work for some sounds.
- This button is used to switch the speed of the tremolo effect for the **ORGAN PRESETS** sounds (except for Pipe Organ type sounds). Turn it on for the faster tremolo speed and off for the slower speed.

## DIGITAL REVERB

**DIGITAL REVERB** applies a reverberation effect to the sound.

Press the **DIGITAL REVERB** button to turn it on.



- This effect is applied to all the sounds of the keyboard.
- The on/off status, type and depth settings are memorized separately for each **SOUND** button.

### □ Type and depth settings

1. Press and hold the **DIGITAL REVERB** button for a few seconds.
  - The indicator flashes to show that the setting mode is active.
  - The display changes to the following.

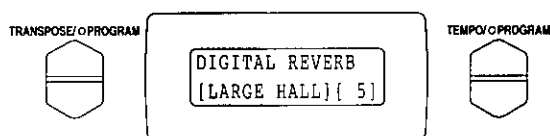

2. Use the **TRANSCOPE/O PROGRAM** buttons to select the type.
  - Select from ROOM, PLATE, CONCERT, DARK, BRIGHT, LARGE HALL, LIVE STAGE, STADIUM and SNGL (SINGLE) DELAY.

3. Use the **TEMPO/O PROGRAM** buttons to adjust the depth of the reverb (1 to 10).
  - If the upper and lower buttons are pressed at the same time, the effect returns to the standard setting.

4. When you have finished changing the settings, press the **DIGITAL REVERB** button or the **EXIT** button.

## PIANO AMBIENCE

**PIANO AMBIENCE** is a special effect which recreates the resonance that occurs naturally in an acoustic piano, as well as other spatial effects beyond the scope of the **DIGITAL REVERB**.

Press the **PIANO AMBIENCE** button to turn it on.



### □ Type and level settings

1. Press and hold the **PIANO AMBIENCE** button for a few seconds.
  - The indicator flashes to show that the setting mode is active.
  - The display looks similar to the following.

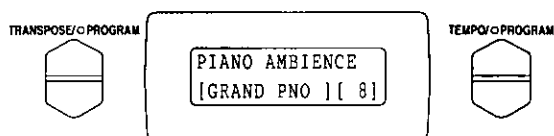

2. Use the **TRANSCOPE/O PROGRAM** buttons to select the type.
  - Select from GRAND PNO, EP.STACK, STANDARD, PERCUSSIVE and SYMPHONIC.

3. Use the **TEMPO/O PROGRAM** buttons to select the level (1 to 10).
  - If the upper and lower buttons are pressed at the same time, the effect returns to the standard setting.

4. When you have finished changing the setting, press the **PIANO AMBIENCE** button or the **EXIT** button.

### BRILLIANCE

The **BRILLIANCE** allows you to select the brightness of the sound from 5 settings.

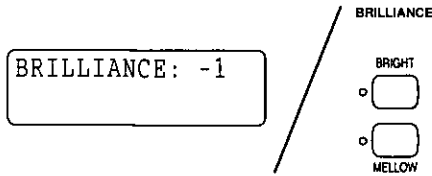

Pressing the **BRIGHT** button increases the brightness; when the **MELLOW** button is pressed, the sound becomes mellower. During setting the brightness is shown on the display (-2 to 2).

- Press both buttons at the same time to return the brightness to 0.
- A short time after the setting is completed, the display will return to the previous display.
- If the **BRILLIANCE** has been set to a number other than 0, one of the indicators remains lit
- This setting is memorized separately for each **SOUND** button.

### String resonance

String resonance is the sound heard in an acoustic piano when the struck strings produce a sympathetic resonance of the other unstruck strings. For piano-type sounds, string resonance is produced as long as the sustain pedal is depressed. The amount of string resonance can be adjusted.

1. Press the **STRING RESONANCE** button.



- **STRING RESONANCE** is shown on the display.

2. Use the **TEMPO/PROGRAM** buttons to adjust the amount of resonance (0 to 10).

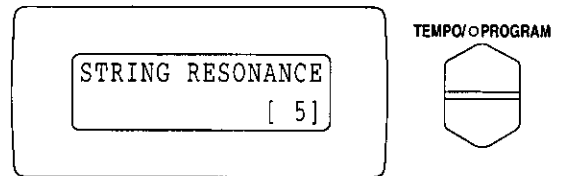

- The higher the number, the greater the amount of resonance.
- When set to 0, there is no string resonance.
- This effect does not work for the left part when the keyboard is split.
- This effect does not work when the **DIGITAL REVERB** is on.
- When you have finished changing the setting, press the **EXIT** button.
- You can also access this display by pressing and holding the **GRAND** button for a few seconds.

## Mixing two sounds (DUAL)

You can play two different sounds at the same time, thus obtaining a composite sound having a depth not possible in a single sound. The volume balance for each of the sounds can also be adjusted.

### Mixing sounds

1. Press two **SOUND** buttons at the same time.

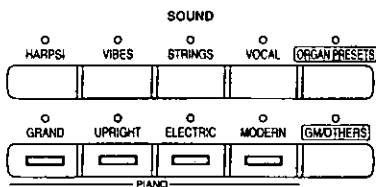

- The sound for each button should be selected beforehand.
- Two sounds in the same **SOUND** button cannot be mixed.

2. Press any key on the keyboard to hear the mixed sound.

- The on/off status of the **DIGITAL EFFECT** is effective for each sound. In addition, the **BRILLIANCE** and **DIGITAL REVERB** settings are memorized for each combination of **SOUND** buttons.

## Volume balance

1. Press the two **SOUND** buttons continuously for a few seconds.
  - The indicators for the two sounds flash, and the current volume balance is shown on the display.
2. Use the **TEMPO/PROGRAM** buttons to adjust the volume balance.

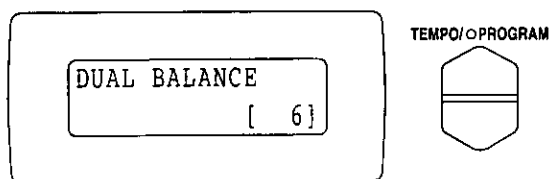

- Each time the upper button is pressed, the volume of the upper or right-side **SOUND** button increases, and each time the lower button is pressed, the volume of the lower or left-side **SOUND** button increases. Play the keyboard to hear the volume balance.
  - If the two **TEMPO/PROGRAM** buttons are pressed at the same time, the volume is equally balanced.
  - On the display, the volume of the upper or right-side **SOUND** button is louder when a number from 1 to 10 is shown, and the volume of the lower or left-side **SOUND** button is louder when a number from -1 to -10 is shown.
3. When you have finished adjusting the volume balance, press any **SOUND** button or the **EXIT** button.

## Assigning different sounds (SPLIT)



You can split the keyboard into right and left sections (**SPLIT**), and assign a different sound to each section.

### SPLIT

1. Select the sound and effects you wish to play on the right section of the keyboard.
  - The sounds can be mixed.
2. Press the **SPLIT** button to turn it on.
  - The **SPLIT** button is always off when the power is turned on.
  - In the initialized state, the keyboard split point is the G key (G2) to the left of middle C (C3). You can change the split point by selecting a different key while depressing the **SPLIT** button.
3. Play the keyboard.
  - The right and left sections of the keyboard produce different sounds.
  - In the initialized state (when shipped from the factory), the "Acoustic Bass" sound is assigned to the left part. You can select a different sound, as well as change the settings for the right and left parts. (Refer to the following section.)
  - The name of the sound selected for the left part is shown in the lower line of the display.

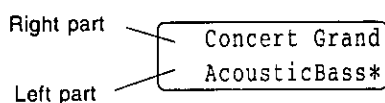

## Setting the Split functions

The settings when the keyboard is split into right and left sections can be changed.

### □ Outline of the setting procedure.

1. Press and hold the **SPLIT** button for a few seconds.



- The indicator flashes to show that the setting mode is active.

2. Use the **TRANSPOSE/PROGRAM** buttons to select an item.

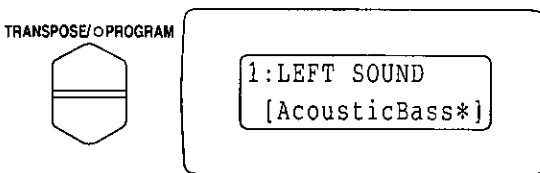

- Select from the following items.
  - 1: LEFT SOUND  
Settings for the-left part sound.
  - 2: SPLIT POINT  
Keyboard split point, where it is divided into left and right parts.
  - 3: LEFT VOLUME  
Volume for the left part.
  - 4: LEFT OCTAVE  
Octave setting for the left part.
  - 5: RIGHT OCTAVE  
Octave setting for the right part.
  - 6: SUSTAIN PEDAL  
Sustain pedal enable/disable setting.
- When an item is selected, the display changes to the corresponding setting display.

3. Follow the procedure to change the setting for the selected item. (See below.)

4. Repeat steps 2 and 3 for each item as desired.

5. When you have finished changing the settings, press the **SPLIT** button or the **EXIT** button.

- All settings, except for SPLIT POINT, are memorized for each combination of left-part and right-part **SOUND** buttons. When the same **SOUND** buttons are again combined and the **SPLIT** button turned on, these same settings are recalled. (In case of a DUAL right sound part, the right part of the combination is based on the lower or left-side **SOUND** button of the mixed sounds.) For this reason, if a different **SOUND** button is pressed when the keyboard is split, the octave setting for the left and right parts or other settings may change.



## LEFT SOUND

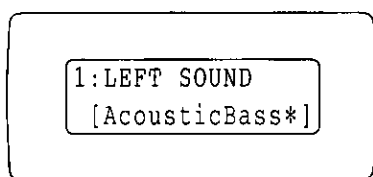

Use the **SOUND** and **SOUND VARIATION** buttons to select a sound for the left part.

- The BASS sounds are grouped with the **GM/OTHERS** sounds.

## LEFT OCTAVE

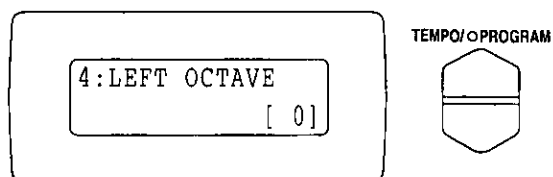

Use the **TEMPO/PROGRAM** buttons to specify the octave of the left-part sound (0 to 2).

- For example, if you specify 1, the pitch of the left-part sound becomes one octave higher.

## SPLIT POINT

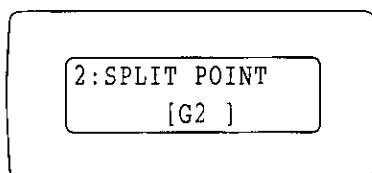

Press the key to specify the point you wish to divide the keyboard into right and left parts.

- The name of the note is shown on the display.
- The key you pressed becomes the lowermost key of the right part.
- You can also specify the split point by specifying a key while you depress the **SPLIT** button.

## RIGHT OCTAVE

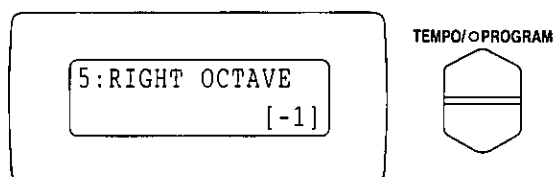

Use the **TEMPO/PROGRAM** buttons to specify the octave of the right-part sound (-2 to 0).

- For example, if you specify -1, the pitch of the right-part sound becomes one octave lower.

## LEFT VOLUME

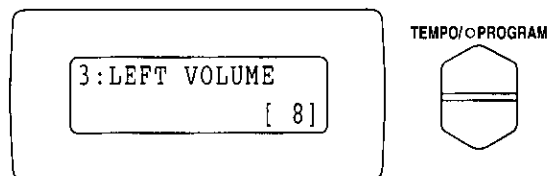

Use the **TEMPO/PROGRAM** buttons to adjust the volume of the left part (1 to 10).

- When set to 10, the volumes for the left part and right part are the same.
- If the upper and lower buttons are pressed at the same time, the volume returns to the standard setting.

## SUSTAIN PEDAL

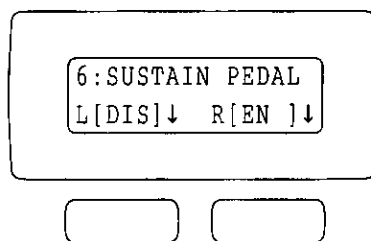

Use the left and right buttons below the display to enable (EN) or disable (DIS) the sustain pedal for the respective left (L) and right (R) parts.

- For example, if you specify L[DIS] and R[EN], when the sustain pedal is pressed during your performance, the sustain effect is applied only to the right sound part.

# Transpose

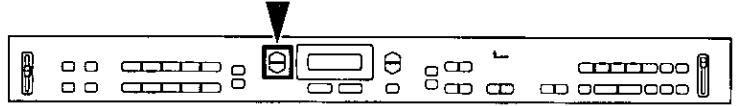

The **TRANSPOSE** buttons are used to change the key of the entire instrument in semi-tone steps across an entire octave.

Suppose you learn to play a song—in the key of C, for example—and decide you want to sing it, only to find that it's either too high or too low for your voice. Your choice is to either learn the song all over again in a different key, or to use the **TRANSPOSE** feature.

Adjust the key with the **TRANSPOSE** buttons.

<Example: transposed to D>

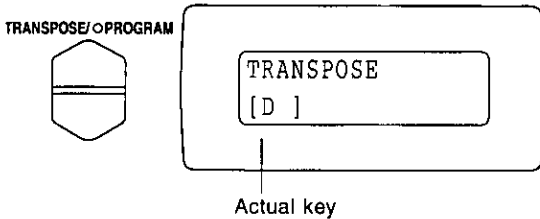

- Each press of the + button changes the key as follows: D<sup>b</sup> → D → E<sup>b</sup> → E → F → F<sup>#</sup>. Each press of the - button changes the key as follows: B → B<sup>b</sup> → A → A<sup>b</sup> → G.
- If the two buttons are pressed at the same time, the key returns to C.
- When the **TRANSPOSE** function is active, the transposed key is shown on the normal display.
- When the **PROGRAM** indicator is lit, the **TRANSPOSE** buttons work as function-setting buttons and cannot be used to change the key of the instrument. If you wish to change the key, first exit the setting mode, by pressing the **EXIT** button, for example.

Played keys

C major

Notes that sound

D major

# Metronome



You can play in time with the metronome sound, and you can add an accent to the metronome sound.

## METRONOME sound

1. Press the **METRONOME ON/OFF** button to turn it on.

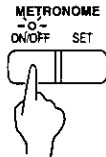

- The metronome sound begins.
2. Adjust the tempo with the **TEMPO** buttons.

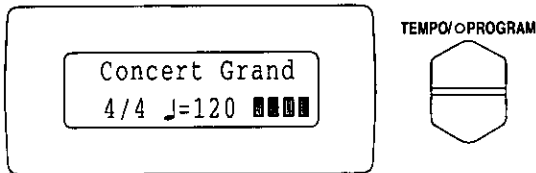

- Each time the lower button is pressed, the tempo slows down, and each time the upper button is pressed, the tempo speeds up.
  - The tempo can be adjusted to  $\downarrow = 40\text{--}300$  and is shown on the display.
  - Press and hold either **TEMPO** button to change the tempo quickly.
  - Pressing both **TEMPO** buttons at the same time returns the tempo to the standard  $\downarrow = 120$ .
  - The bars to the right of the tempo display indicate the beat.
3. Press the **METRONOME's ON/OFF** button again to turn off the metronome sound.

## Metronome volume and time signature

1. Press the **METRONOME's SET** button.
  - The display looks similar to the following.

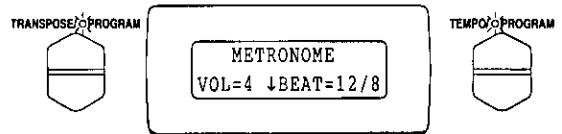

2. Use the **TRANSPOSE/PROGRAM** buttons to specify the metronome volume (1 to 9).
3. Use the **TEMPO/PROGRAM** buttons to select a time signature.
  - Select from OFF, 2/2, 2/4, 3/4, 4/4, 5/4, 6/4, 7/4, 3/8, 6/8, 9/8, and 12/8.
  - The first beat of the selected time signature is accented. Select OFF if you want a metronome sound with no accented beat.
  - If both buttons are pressed at the same time, the setting returns to the standard setting.
  - For compound rhythms (6/4, 6/8, 9/8, 12/8), pressing either button below the display will bring up a display similar to the following. You can then use the buttons below the display to select a note length indicating the type of metronome beat you want. (An asterisk on the display (\*) indicates your selection.)

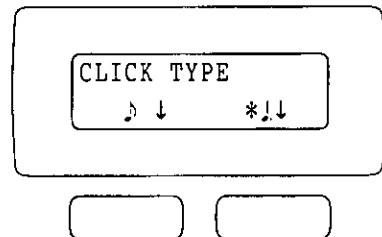

4. When you have finished changing the settings, press the **EXIT** button.

# Part II Sequencer

## Record your performance

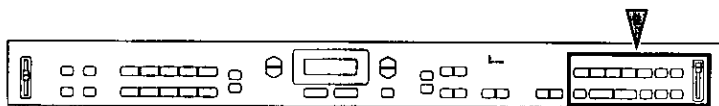

Your performance can be recorded in this instrument's **SEQUENCER** and then played back.

### Easy Record

Use this method to simply record your performance as you play the keyboard, including **DUAL** and **SPLIT** modes.

- Note that this procedure will erase any previously recorded contents of the **SEQUENCER**. To retain the **SEQUENCER** contents, refer to page 30.

1. Set up the sounds and effects for your performance.
  - Do not select the **DRUM KIT** sounds in the **GM/OTHERS** button for either part.
2. In the **SEQUENCER** section, press and hold the **RECORD** button for a few seconds.

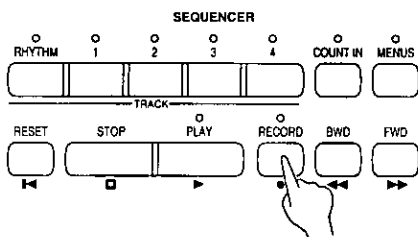

- The display looks similar to the following.

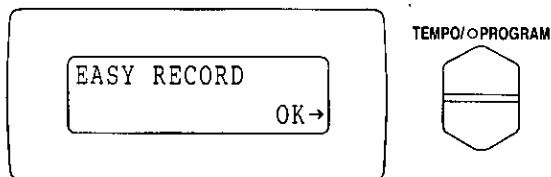

3. Press either **TEMPO/PROGRAM** button (OK).
  - Press the **EXIT** button if you wish to cancel the operation instead.
4. Begin playing.
  - Actual recording begins when you start to play the keyboard.
  - You can also begin recording by pressing the **PLAY** button. You will hear a two-measure count, after which recording automatically begins. The **TEMPO** buttons are used to adjust the count tempo.

5. When you have finished playing, turn off the **RECORD** button.

- You can also press the **STOP** button to end the recording.

6. Your performance is played back when the **PLAY** button is pressed.

- For more information about playback, refer to page 22.

- With this recording method, your performance is recorded in tracks 1, 3 and 4 as follows.

#### TRACK 1:

The mixed sound part when the **DUAL** mode is active.

#### TRACK 3:

Left sound part when the **SPLIT** mode is active.

#### TRACK 4:

Normal performance parts (right sound part when the **SPLIT** mode is active).

### Recording each track

You can use several tracks for a multitrack recording

- Only one track can be recorded at a time

1 In the **SEQUENCER** section, press the **RECORD** button to turn it on

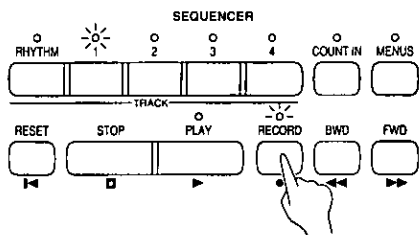

- You can press the **RECORD** button again if you wish to stop the recording

2 Select a **TRACK** number to record

- The indicator for the selected **TRACK** button flashes
- The **RHYTHM** track is reserved for recording the rhythm. When you select this track, the keyboard keys produce percussion sounds

3 Set up the sounds and effects for the track

- The **DRUM KIT** sounds in the **GM/OTHERS** button are available only when the **RHYTHM** track is selected

4 Begin playing

- Actual recording begins when you start to play the keyboard
- You can also begin recording by pressing the **PLAY** button. You will hear a two-measure count, after which recording automatically begins. The **TEMPO** buttons are used to adjust the count tempo
- The basic tempo can also be modified after you finish recording (Refer to page 24)
- If you turn the **METRONOME ON/OFF** button on and then press the **PLAY** button, you will hear a two-measure count, after which the metronome sounds and recording begins
- During recording, the display looks similar to the following

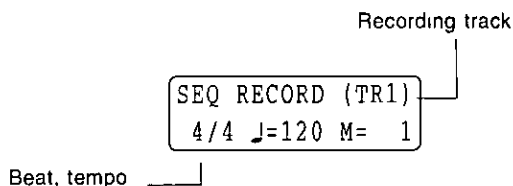

- The measure indication (M=) changes in accordance with the tempo and metronome time signature settings that are currently active

5 When you have finished recording, turn off the **RECORD** button

- You can also press the **STOP** button to end the recording
- The indicator for the track you recorded remains lit

### □ Multitrack recording

Use the following procedure to record a track while listening to the track or tracks already recorded

1 Follow the procedure to record the first track

2 Turn on the **RECORD** button

3 Press a **TRACK** button to select the track you wish to record next

4 Set up the sounds and effects for the track

5 Press the **PLAY** button

- After the count, the previously recorded track or tracks are played back, and you can record in time with this

6 When you have finished playing, turn off the **RECORD** button

7 Repeat steps 2 to 6 as necessary to record the other tracks

### Notes

- The following are recorded in your **SEQUENCER** performance: beginning tempo and time signature settings, your keyboard performance and pedal operation, sound settings and changes, **DIGITAL EFFECT** on/off operation, volume balance when the dual mode is active, volume setting, etc. for the left part
- The total number of notes that can be recorded in all the tracks combined is about 20,000 notes (Pedal operation, etc., is also included in this count). When the remaining recording capacity becomes 20% or less, it is indicated on the display. When the memory capacity is reached, "MEMORY FULL!" appears on the display and recording automatically ends
- If the recording procedure is used to record in tracks already recorded, the contents recorded previously are erased
- Recording can be started only from the beginning of the song
- Data received through the **MIDI** terminals cannot be recorded
- The **SEQUENCER** contents are deleted approximately one minute after the power is turned off. If you wish to retain the performance data, you can store the **SEQUENCER** contents on a floppy disk (Refer to page 30)
- The nuance of effects that are controlled by the sustain pedal may sound different during playback
- You can assign a name to your recorded song (Refer to page 24)

## Track Clear

Follow the procedure below to erase all data from specified tracks.

1. While pressing the **RESET** button, press the button for the track you wish to erase.

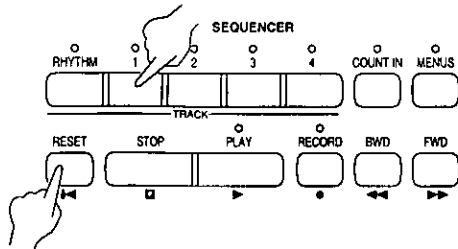

- The display looks similar to the following.

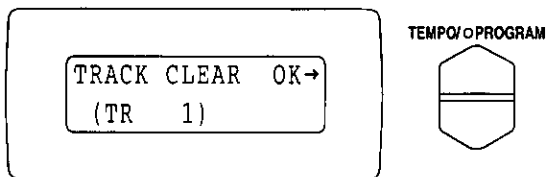

2. Press either **TEMPO/PROGRAM** button (OK).
  - If you wish to cancel the clear procedure, press the **EXIT** button.
  - The data is deleted from the specified track, and "Completed!" appears on the display.
  - To erase more than 1 track, repeat steps 1 and 2.
- You can also erase all the data for one song. (Refer to page 26.)

## Sequencer playback

Listen to the song recorded in the **SEQUENCER**.

- The buttons function in the same way as when playing back disk data. (Refer to page 28.)

### Playback procedure

1. Confirm that the indicators for the tracks you recorded are lit.
2. Press the **RESET** button.
3. Press the **PLAY** button to turn it on.

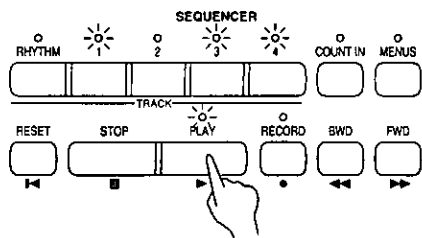

- Playback begins.
- If you turn on the **COUNT IN** button before pressing the **PLAY** button, a two-measure count is heard, after which playback begins. If playback is begun in the middle of a measure, the count begins from the beginning of the previous measure.
- Playback data cannot be transmitted through the **MIDI** terminals.
- During playback or playback standby, the song name, time signature, tempo and number of measures are shown on the display. To return to the normal display, press the **EXIT** button.

### Button functions

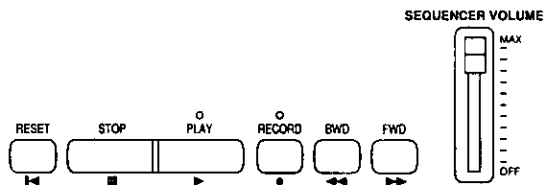

#### RESET:

When playback is stopped, pressing this button returns the song to the first measure.

#### STOP:

Stops playback (pause).

- When playback is stopped in the middle of a song, you can press the **PLAY** button to continue playback from the same point.

#### PLAY:

Begins playback.

#### BWD:

Rewind (by measures)

#### FWD:

Fast forward (by measures)

- After **BWD** or **FWD** is pressed, playback starts from the beginning of the indicated measure.

**SEQUENCER VOLUME**

During playback you can lower the volume of all the playback parts with the **SEQUENCER VOLUME** sliding control. When you play the keyboard along with the stored recording, for example, you can easily adjust the volume balance between your keyboard performance and the playback performance.

- Use this control to lower the playback volume when it is too loud.
- At **MAX** the volume as it was recorded is played back, and at **OFF** the playback is inaudible.
- This control is normally left at the **MAX** setting.

# Sequencer settings

You can adjust the various settings of the **SEQUENCER**, such as the part settings.

## Parts

The performance parts are assigned to each track as shown in the table below. When recording in this instrument, five parts are used; however, when playing back commercially recorded disks, up to 16 parts may be generated.

**Track assign**

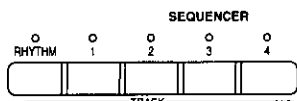

Track	Part (channel)
RHYTHM	10 (reserved for DRUM KIT sounds)
1	1 (DUAL part)
2	2, 5, 6, 7, 8, 9, 11, 12, 13, 14, 15, 16 (fixed to 2 when recording)
3	3 (left part of split keyboard)
4	4 (normal performance, right part of split keyboard)

## Outline of setting procedure

1. Press the **MENUS** button to turn it on.

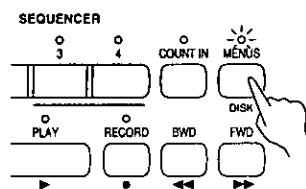

- The display changes to the following.

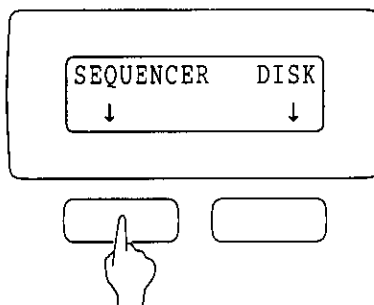

2. Press the left button below the display (**SEQUENCER**).
3. Use the **TRANPOSE/PROGRAM** buttons to select an item.

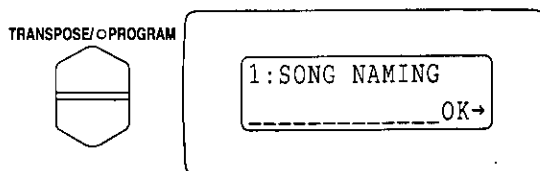

*(continued on the next page)*

- Select from the following items.
    - 1:SONG NAMING  
Specify a name for the song data currently in the **SEQUENCER**.
    - 2:TEMPO WRITE  
Beginning tempo setting.
    - 3:PANEL WRITE  
Store the following part settings at the beginning of the song.
    - 4:PART VOLUME  
Volume setting for each part.
    - 5:PART PAN  
Stereo balance setting for each part.
    - 6:PART REVERB  
Reverb depth setting for each part.
    - 7:PART CHORUS  
Chorus depth setting for each part.
    - 8:FIXED TEMPO  
You can specify a fixed playback tempo when recorded tempo change data is played back.
    - 9:SONG CLEAR  
Erase the recorded contents of all the **SEQUENCER** tracks.
  - When an item is selected, the display changes to the corresponding setting display.
- 4.Follow the procedure to change the setting (see below).
  - 5.Repeat steps 1 (2) to 4 as necessary for each item you wish to change.
  - 6.When you have finished adjusting the settings, press the **MENUS** button or the **EXIT** button.

## SONG NAMING

- 1.Press either **TEMPO/PROGRAM** button (OK).

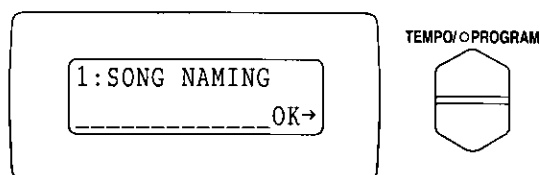

- The display looks similar to the following.

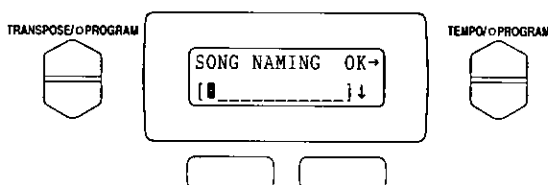

- 2.Use the two buttons below the display to move the cursor (■).
- 3.Use the **TRANPOSE/PROGRAM** buttons to select the alphanumeric character.
- 4.Repeat steps 2 and 3 for each character position in the name (maximum 12 characters).
- 5.When you have finished assigning the name, press either **TEMPO/PROGRAM** button (OK).
  - The name is assigned to the song, and "Completed!" appears on the display, after which the instrument returns to the normal performance mode.

## TEMPO WRITE

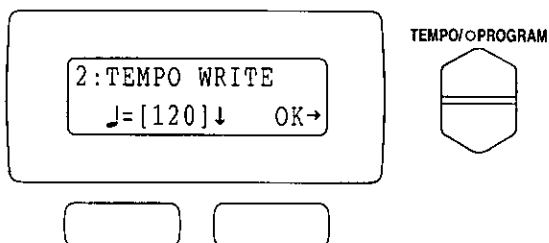

- 1.Use the two buttons below the display to adjust the beginning tempo.
- 2.Press either **TEMPO/PROGRAM** button (OK).
  - The tempo is stored at the beginning of the song, and "Completed!" appears on the display, after which the instrument returns to the normal performance mode.
  - This setting does not work if the song begins from the third or a succeeding measure.



**PANEL WRITE**

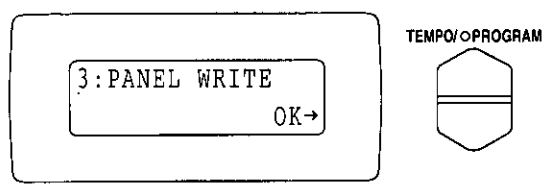

1. Adjust the settings for each part (see below).
2. Press either **TEMPO/PROGRAM** button (OK).
  - The settings for each part are stored at the beginning of the song, and "Completed!" appears on the display, after which the display changes to the SEQ PLAY display.
  - This setting does not work if the song begins from the third or a succeeding measure.

**PART VOLUME**

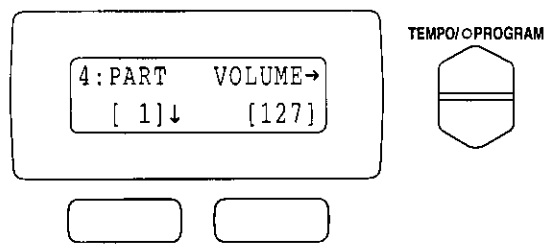

1. Use the two buttons below the display to select a part (1 to 16).
2. Use the **TEMPO/PROGRAM** buttons to adjust the volume for the part (0 to 127).
3. Repeat steps 1 and 2 for each part as necessary.
  - If you wish to store the setting at the beginning of the song, follow the **PANEL WRITE** procedure.

**PART PAN**

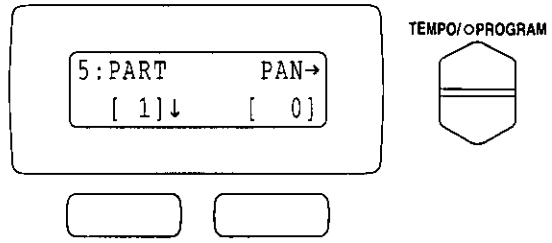

1. Use the two buttons below the display to select a part (1 to 16).
2. Use the **TEMPO/PROGRAM** buttons to adjust the balance for the part.
  - At L64, the sound is completely to the left, at 0 in the center, and at R63 completely to the right.
3. Repeat steps 1 and 2 for each part as necessary.
  - If you wish to store the setting at the beginning of the song, follow the **PANEL WRITE** procedure.

**PART REVERB**

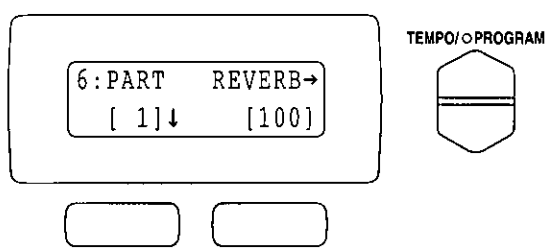

1. Use the two buttons below the display to select a part (1 to 16).
2. Use the **TEMPO/PROGRAM** buttons to adjust the reverb depth for the part (0 to 127).
3. Repeat steps 1 and 2 for each part as necessary.
  - If you wish to store the setting at the beginning of the song, follow the **PANEL WRITE** procedure.

## PART CHORUS

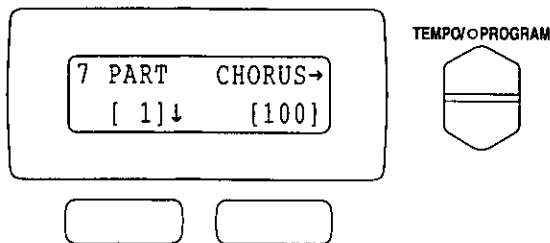

- 1 Use the two buttons below the display to select a part (1 to 16)
- 2 Use the **TEMPO/PROGRAM** buttons to adjust the chorus depth for the part (0 to 127)
- 3 Repeat steps 1 and 2 for each part as necessary
  - If you wish to store the setting at the beginning of the song, follow the **PANEL WRITE** procedure

## SONG CLEAR

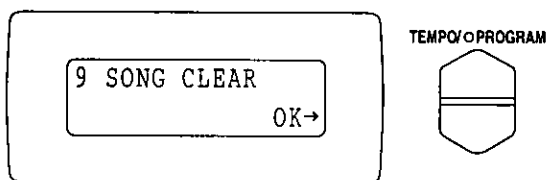

- 1 Press either **TEMPO/PROGRAM** button (OK)
  - The display changes to the following

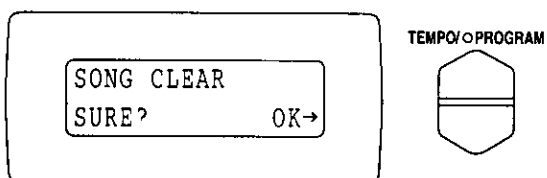

- 2 Press either **TEMPO/PROGRAM** button (OK)
  - If you wish to cancel the clear procedure, press the **EXIT** button
  - All the recorded contents of the **SEQUENCER** are erased, and "Completed!" appears on the display, after which the instrument returns to the normal performance mode
  - You can also specify which tracks to erase (Refer to page 22)

## FIXED TEMPO

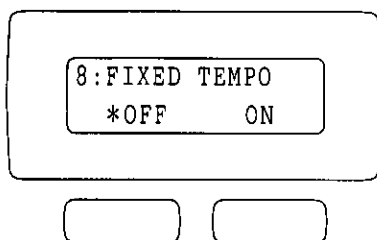

- Use the buttons below the display to select ON or OFF
- An asterisk on the display (\*) indicates your selection

**ON**  
When recorded song data with tempo changes is played back, the tempo changes are ignored (The song is played back at a fixed tempo)

- When set to ON, "\*" is shown to the right of the tempo value on the playback display

**OFF**

Tempo changes as they were recorded in the song are played back

- The ON setting is convenient, for example, when you wish to play along with recorded song data at an easy tempo during practice

# Part III Disk Drive

## Outline of the Disk Drive function

The Disk Drive enables you to save the song recorded in the **SEQUENCER** on a floppy disk for playback later, as well as play commercial song disks.

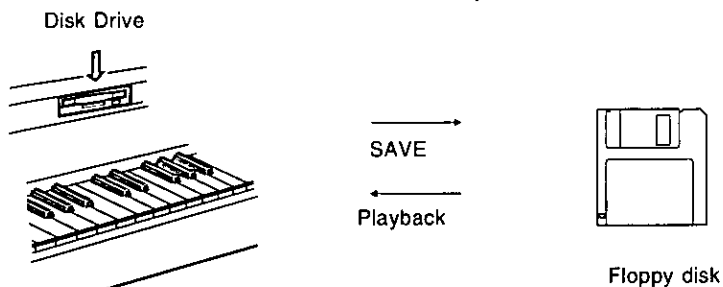

### Main parts of the Floppy Disk Drive

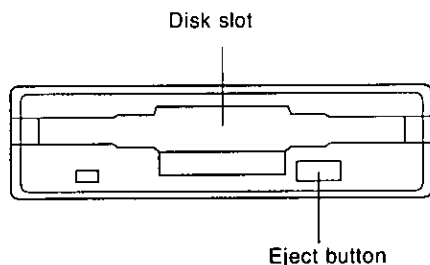

#### Eject button

Press to remove the disk from the Disk Drive.

- You can use 3.5 inch 2DD (720 KB) or 2HD (1.44 MB) floppy disks; however, 2HD disks formatted as 2DD cannot be used.

### DISK IN USE



This indicator lights when data is being loaded or saved.

- To prevent data loss, do not eject the disk or turn off the power while this indicator is lit.

This indicator is lit continuously as long as the power is on.

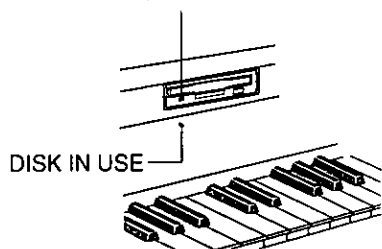

### Commercial song disks

You can listen to commercial song disks and use them to help your practicing.

- The procedure is explained on the next page.

The following commercially sold song disks can be played back on this instrument:

Standard MIDI File FORMAT (0/1)
DISK ORCHESTRA COLLECTION™ (DOC) (playback only)
PianoDisc™ (playback only)

- All product and company names are trademarks or registered trademarks of their respective owners.
- DISK ORCHESTRA COLLECTION is a trademark of the YAMAHA Corporation.

### About Standard MIDI Files

"Standard MIDI File" (SMF) is a standardized data format which makes it possible for music data to be exchanged among different sequencers. Data stored in this format on sequencers of different models can be played back on this instrument, and vice versa. Note, however, that Standard MIDI Files ensure the compatibility of data such as NOTE data (keyboard performance data), VELOCITY (how hard the keyboard is played), PROGRAM NUMBER data (voice number data), etc. Because it does not guarantee 100% faithful reproduction of recorded music which is replete with such data, it may be necessary for you to adjust the settings to your satisfaction.

- Only files with the ".MID" extension can be loaded.
- Standard MIDI File FORMAT 1 can be loaded, but not saved.
- This instrument's **SEQUENCER** data can be saved to a disk in Standard MIDI File (FORMAT 0) and can be used by other equipment.

## Save your SEQUENCER performances

The recorded contents of the **SEQUENCER** are deleted approximately 80 minutes after the power is turned off. However, the Disk Drive enables you to save your performance on a floppy disk for playback anytime. Several songs can be stored on one floppy disk, making it easy to keep and organize your performances.

### Basic outline of how to save your performances

- 1 Record your performance in the **SEQUENCER** (Refer to page 20)
- 2 Format a floppy disk if necessary (Refer to page 30)
- 3 Perform the procedure to save your recording to the floppy disk (Refer to page 31)
- 4 Play back the song from the floppy disk anytime you like

## Disk play



Here is how to play back a song saved to a floppy disk

**Note** Because the song on the floppy disk is played back using the **SEQUENCER**, any song data currently recorded in the **SEQUENCER** will be erased by this procedure. If you wish to retain this song data, save it to a floppy disk before beginning the disk play procedure (Refer to page 30)

### Procedure

- 1 Insert the disk with the song data into the Disk Drive

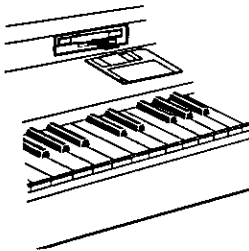

- Make sure the disk is inserted correctly, and push it all the way in until you hear a click
- After a few seconds, the display changes to the **SONG SELECT** display

- 2 Use the **SONG** buttons to select the song you wish to play back

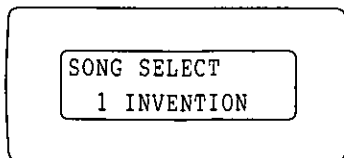

- The song number and song name are shown on the display
- If **ALL REPEAT** is selected, all the disk's songs are played back in order
- If **RANDOM** is selected, the disk's songs are played in random order

- 3 Press the **PLAY** button

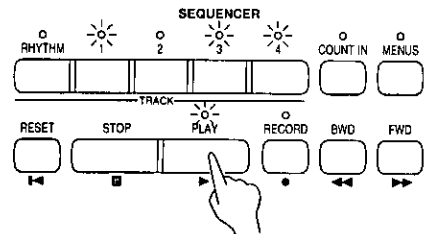

- Playback begins after a few seconds
- When the **SEQUENCER** currently contains data that you have recorded or edited, a confirmation display appears. If it is OK to erase the data, press either **TEMPO/PROGRAM (OK)** button, and then follow the playback procedure
- You can press the **BWD** button to go back and the **FWD** button for fast forward (Refer to page 22)

- If you turn on the **COUNT IN** button before pressing the **PLAY** button, a two-measure count is heard, after which playback begins. If playback is begun from the middle of a measure, the count begins from the beginning of the previous measure.
- When you play the keyboard along with the stored recording, for example, you can use the **SEQUENCER VOLUME** control to easily adjust the volume balance between your keyboard performance and the playback performance. (Refer to page 22.)
- The settings for each part can be adjusted. (Refer to page 25.)

## Adjusting the tempo

During disk playback, the **TEMPO** buttons can be used to set the tempo to the rate you like. If tempo change data is recorded in the song, all the tempo changes are effected in direct proportion to the tempo you set.

- To return to the original tempo, press both **TEMPO** buttons at the same time.
- When a different song is selected, the tempo change is canceled, and the tempo conforms to the tempo data for the selected song.
- The tempo does not return to the original tempo even if the **RESET** button is pressed.
- To play back the song at a steady tempo, set the **FIXED TEMPO** to **ON**. (Refer to page 26.) The recorded tempo changes will be ignored.

## Minus One performance

By turning off a **TRACK** button, you can mute the sound for that specific part. This is convenient when you wish to play the keyboard in time with the recorded song.

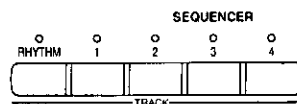

### ■ TRACK 2 mute

When you play back song data that uses many channels (parts), several channels are assigned to track 2 (2, 5 to 9, 11 to 16). You can specify the channels in track 2 that you wish to turn on or off.

- The channel numbers and part numbers of this instrument are the same.
1. Press and hold the **TRACK 2** button for a few seconds.
    - The indicator flashes to show that the setting mode is active.
    - The display looks similar to the following.

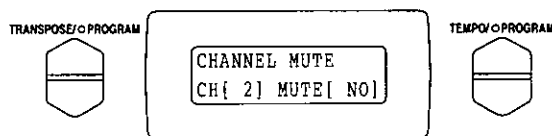

2. Use the **TRANPOSE/PROGRAM** buttons to select a channel. Use the **TEMPO/PROGRAM** buttons to set the channel to **YES** or **NO**.
  - Channels which are set to **MUTE [YES]** will not sound.
  - Repeat this step for the other parts, as desired.
  - If all the parts are set to **YES**, the **TRACK 2** indicator goes out. If the button is then pressed to turn it on, all the channels are reset to **NO**.
3. When you have finished making the settings, press the **TRACK 2** button or the **EXIT** button.
  - These settings are cancelled when another song is selected for playback.

# Saving data

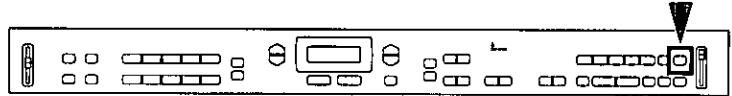

The recorded data and panel settings of this instrument can be saved on a disk.

## Floppy disks

You can use 3.5 inch 2DD (720KB) or 2HD (1.44MB) disks.

- How to distinguish the two disk types:

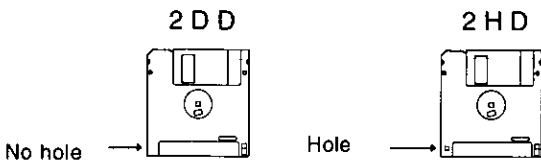

- When saving data to the disk, the write-protect tab must be closed.

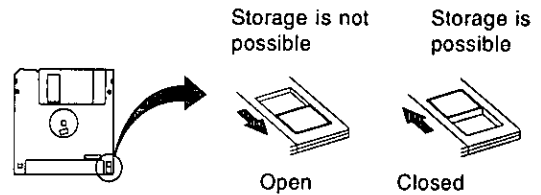

- Although 2HD disks can hold more data and are convenient for quick loading and saving, some models may be able to read only 2DD disks. Therefore, you may not be able to use your 2HD disk data with other musical instrument models.

## FORMAT

Floppy disks which are used for the first time with this instrument have to be formatted through the following procedure.

- Note that this procedure clears any data which is currently stored on the disk.

1. Insert an unformatted disk into the Disk Drive slot.
2. Press the **MENUS (DISK)** button to turn it on.

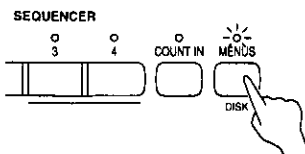

3. Press the right (DISK) button below the display.
- The display looks similar to the following.

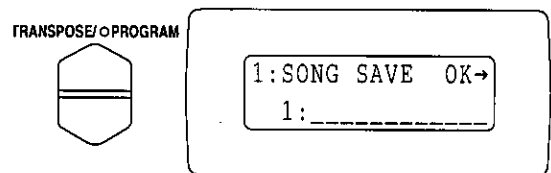

- The display looks similar to the following.

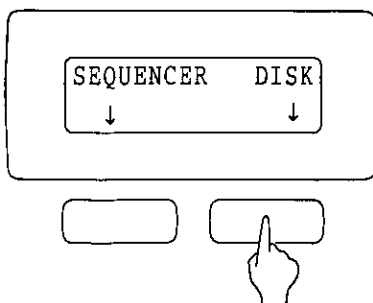

4. Use the **TRANSPPOSE/PROGRAM** buttons to specify 3: DISK FORMAT.

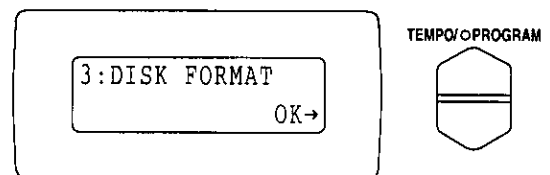

5 Press either **TEMPO/PROGRAM** button (OK)

- The display looks similar to the following

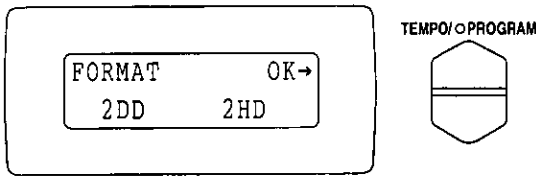

6 Use the buttons below the display to select the type of disk which is inserted (2DD or 2HD)

- An asterisk (\*) on the display indicates your selection

7 Press either **TEMPO/PROGRAM** button (OK)

- The display changes to the following

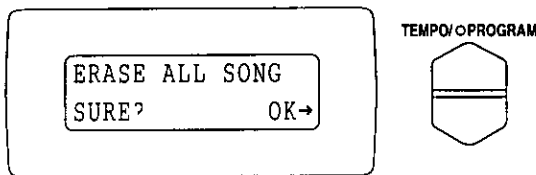

## Save procedure

Follow the save procedure to save your recorded **SEQUENCER** performance on a floppy disk

- This instrument's **SEQUENCER** data is saved on disks in the "Standard MIDI File" format (FORMAT 0)

1 Record a performance in the **SEQUENCER** (Refer to page 20)

2 Insert a formatted disk into the Disk Drive slot

3 Press and hold the **MENUS (DISK)** button for a few seconds

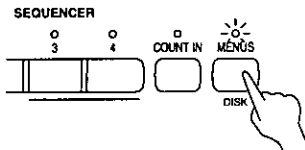

8 Press either **TEMPO/PROGRAM** button (OK)

- Note that the disk format procedure clears any data which may be currently stored on the disk. If you wish to cancel the format procedure, press the **EXIT** button.
- After a few minutes, formatting is completed, and "Completed" appears on the display, after which the instrument returns to the normal performance mode.
- If an unformatted disk is inserted into the Disk Drive slot and you attempt to save song data, the **FORMAT** display automatically appears.

- The display looks similar to the following

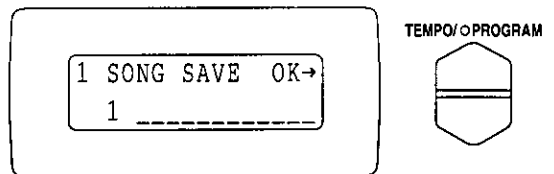

4 Press either **TEMPO/PROGRAM** button (OK)

- The display changes to the **SONG NAMING** display, similar to the following

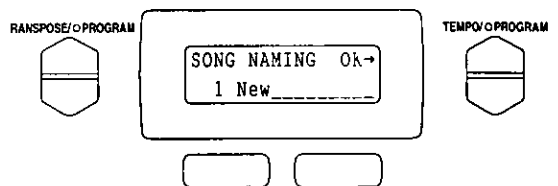

(continued on the next page)

5. Use the two buttons below the display to move the cursor to the desired character position.
6. Use the **TRANPOSE/PROGRAM** buttons to select the alphanumeric character.
  - If you wish to clear the current song name, press both **TRANPOSE/PROGRAM** buttons, and on the resulting confirmation display press either **TEMPO/PROGRAM** (OK) button.
7. Repeat steps 5 and 6 for each character position in the name (maximum 12 characters).
  - If there is other song data on the disk, the last song number is incremented by one and becomes the song number of the saved song. If you wish to assign a number which already contains song data, move the cursor to the number indication, and use the **TRANPOSE/PROGRAM** buttons to specify the number. An asterisk next to a song number indicates that song data is currently saved for that number. In this case, the SURE display appears in step 8; you can press either **TEMPO/PROGRAM** button to overwrite the existing song data on the disk (OK), or **EXIT** to cancel the procedure.

8. Press either **TEMPO/PROGRAM** button (OK).
  - The save operation begins.
  - When the operation is completed, "COMPLETED!" appears on the display, after which the instrument returns to the normal performance mode.
  - If data from a commercial disk has been loaded in the **SEQUENCER**, it may not be possible to save data to a disk.
  - Up to 99 songs can be stored on one disk. (Note that the number of songs which can be stored decreases depending on the length of the songs.)
  - The SONG SAVE display can also be accessed by turning on the **MENUS (DISK)** button and then pressing the right button below the display (DISK).

### Erasing song data

You can specify the songs you wish to erase from the disk.

1. Insert the disk with the data you wish to delete into the Disk Drive slot.
2. Press the **MENUS (DISK)** button to turn it on. Press the right button below the display (DISK).
3. Use the **TRANPOSE/PROGRAM** buttons to specify 2:SONG DELETE.
  - The display changes to the following.

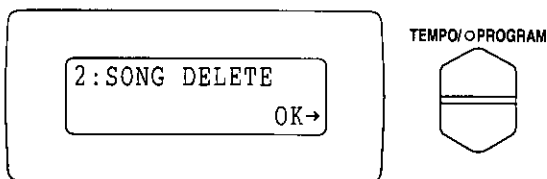

4. Press either **TEMPO/PROGRAM** button (OK).
  - The display looks similar to the following.

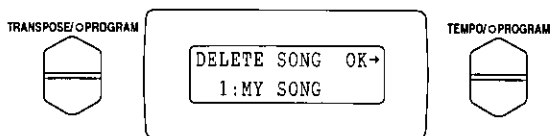

5. Use the **TRANPOSE/PROGRAM** buttons to select the song number you wish to delete. Press either **TEMPO/PROGRAM** button (OK).
  - The display changes to the following.

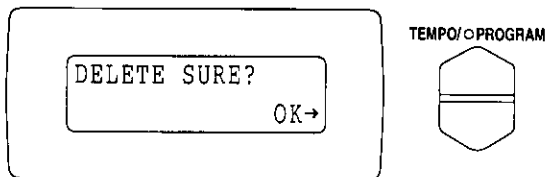

6. Press either **TEMPO/PROGRAM** button (OK).
  - If you wish to cancel the erase procedure, press the **EXIT** button.
  - The specified song data is deleted from the disk, and "Completed!" appears on the display, after which the instrument returns to the normal performance mode.
  - When a song is erased, the song numbers following are moved up.



# Part IV Control functions

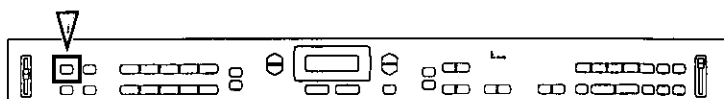

The control functions can be set to maximize your enjoyment of this instrument.

## Outline of the setting procedure

1. Press the **PROGRAM MENUS** button to turn it on.



• The display changes to the following.

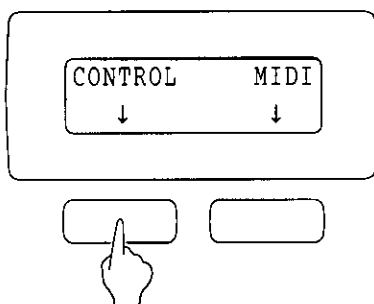

2. Press the left button below the display (**CONTROL**).

3. Use the **TRANSPOSE/PROGRAM** buttons to select the item you wish to set.

TRANSPOSE/PROGRAM

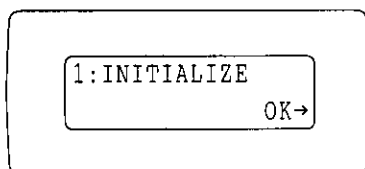
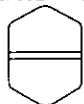

• Select from the following items.

- 1: INITIALIZE  
Return this instrument to the factory-preset status.
- 2: MASTER TUNING  
Fine-tune the pitch of the entire instrument.
- 3: KEY SCALING  
Specify the type of tuning for this instrument.
- 4: PIANO TUNING  
Set the piano tuning to on or off.
- 5: MINIMUM RANGE  
Specify whether or not sound is generated when the keys are pressed very softly.
- 6: REVERB CONTROL  
Specify whether the reverb is controlled by the **SEQUENCER** data or by the panel buttons.
- 7: LCD CONTRAST  
Adjust the display contrast.

• When an item is selected, the display changes to the corresponding setting display.

4. Follow the procedure to change the setting for the selected item. (See below.)

5. Repeat steps 3 and 4 for each item as desired.

6. When you have finished changing the settings, press the **PROGRAM MENUS** button or the **EXIT** button.

## INITIALIZE

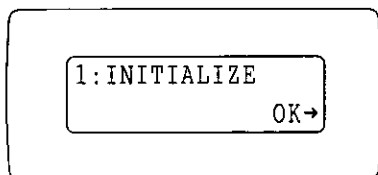

TEMPO/PROGRAM



1. Press either **TEMPO/PROGRAM** button (OK).

• The display changes to the following.

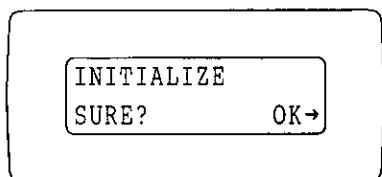

TEMPO/PROGRAM

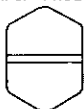

2. Press either **TEMPO/PROGRAM** button (OK).

• Note that the INITIALIZE procedure erases the recorded contents of the **SEQUENCER** and returns all function settings to their factory-preset status. If you wish to cancel the INITIALIZE procedure, press the **EXIT** button at this time.

• The instrument is initialized, and "Completed!" appears on the display, after which the instrument returns to the normal performance mode.

• You can also initialize the instrument with the following procedure: Turn off the power to this instrument once, Then, while pressing the keyboard key labeled **INITIAL**, turn the power on again.

## MASTER TUNING

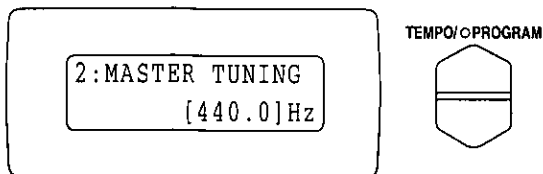

Use the **TEMPO/PROGRAM** buttons to adjust the pitch within a range of 427.3 to 453.0 Hz.

- The decimal can be set to 0, 3 or 6.
- If the two buttons are pressed at the same time, the pitch returns to the standard frequency (440.0 Hz).

## KEY SCALING

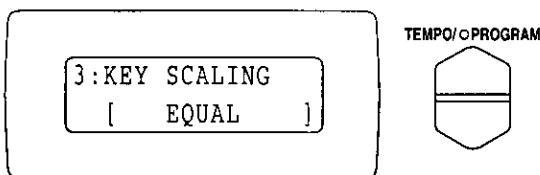

Use the **TEMPO/PROGRAM** buttons to select the desired type of scaling (tuning).

- Select from EQUAL, WERCKMEISTER and KIRNBERGER.
- The factory-preset setting is EQUAL (equal temperament).

## PIANO TUNING

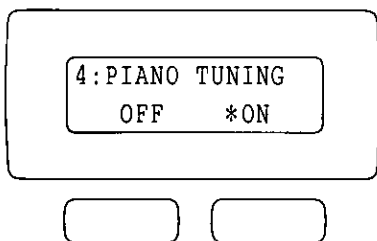

Use the two buttons below the display to select ON or OFF.

- An asterisk on the display (\*) indicates your selection.

ON:

Standard acoustic piano tuning, in which the lower pitches are tuned slightly lower and the higher pitches are tuned slightly higher (factory preset).

OFF:

Standard equal temperament

- If a type other than EQUAL is selected, please set **KEY SCALING** to OFF.
- This setting is effective only for acoustic piano-type sounds.

## MINIMUM RANGE

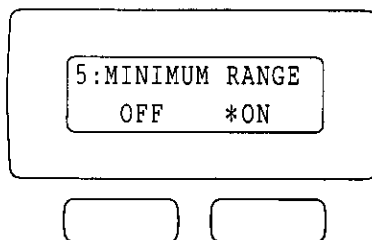

Use the buttons below the display to select ON or OFF.

- An asterisk on the display (\*) indicates your selection.

ON:

No sound is produced when a key is played extremely softly (factory preset).

OFF:

Sound is produced regardless of how softly the keys are pressed.

## REVERB CONTROL

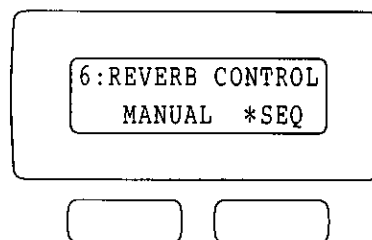

Use the buttons below the display to select MANUAL or SEQ.

- An asterisk on the display (\*) indicates your selection.

MANUAL:

The reverb setting is always controlled by the **DIGITAL REVERB** button.

SEQ:

Reverb settings during **SEQUENCER** playback follow the reverb data as they were recorded in the performance (factory preset).

## LCD CONTRAST

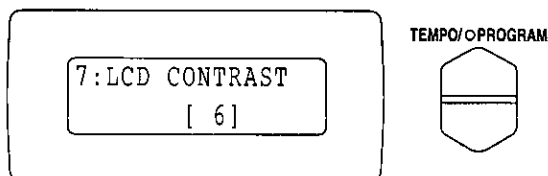

Use the **TEMPO/PROGRAM** buttons to adjust the contrast (1 to 10).

## MIDI

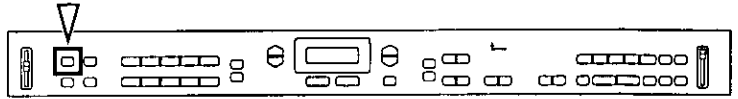

MIDI (Musical Instrument Digital Interface) is the international standard for digital communication of electronic musical instrument data. This means that any equipment which has a MIDI terminal—such as electronic musical instruments and personal computers—can easily exchange digital data with other MIDI equipment without resorting to complicated conversions or connections.

### About the MIDI terminals

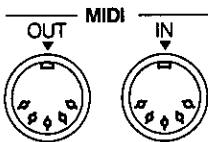

- IN:** The terminal by which this instrument receives data from other equipment.
- OUT:** The terminal that transmits data from this instrument to other equipment.

- For these connections, use a commercially available MIDI cable. Contact your Technics dealer for more information.
- Exchange of normal data through these terminals is enabled only when the **COMPUTER** terminal switch is set to **MIDI**. (Refer to page 39.)

### Connection examples

To generate sound from a connected instrument by playing this instrument

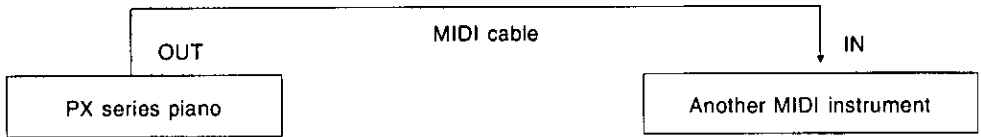

To generate sound from this instrument by operating a connected MIDI sequencer

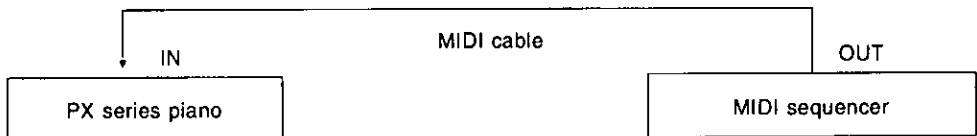

### MIDI channels

A single MIDI cable is used to transmit 16 channels of MIDI data. Transmitting and receiving MIDI data is enabled when the channels on the transmission side match the channels on the receiving side. This makes it possible to specify that data from specific channels be transmitted to specific sound generators, and to have each of multiple sound generators reproduce different parts of the performance data.

#### □ The following kinds of data can be transmitted/received.

- Key note on/off data (keyboard performance data)
- Pedal on/off data
- DIGITAL EFFECT** on/off data
- PROGRAM CHANGE** (sound selection change) data, etc.

- **SEQUENCER** and **DEMO** performance data cannot be transmitted.
- Data received through the **MIDI** terminals cannot be recorded in the **SEQUENCER**.

# Setting the MIDI functions

This procedure is used to set various functions related to MIDI operation

## Outline of setting procedure

1 Press the **PROGRAM MENUS** button to turn it on



The display changes to the following

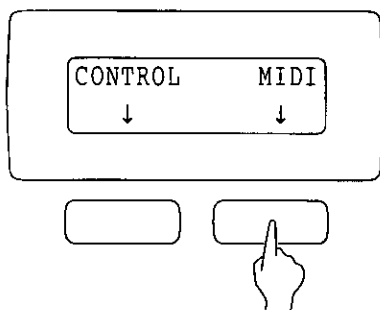

2 Press the right button below the display (MIDI)

3 Use the **TRANSPPOSE/PROGRAM** buttons to select an item

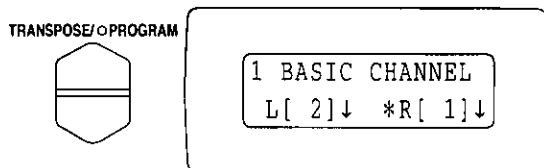

Select from the following items

- 1 **BASIC CHANNEL**  
This instrument's MIDI channel settings (right/left part)
- 2 **LOCAL CONTROL**  
Specify whether or not the sound is reproduced by this instrument
- 3 **TRANSPPOSE OUT**  
Specify whether or not this instrument's **TRANSPPOSE** data is transmitted
- 4 **PROGRAM CHANGE**  
Specify whether or not program (sound) change data is transmitted/received

5 **PEDAL ON/OFF**

Specify whether or not pedal operation data is transmitted/received

6 **EFFECT ON/OFF**

Specify whether or not **DIGITAL EFFECT** on/off data is transmitted/received

7 **PROG CHNG OUT**

Transmit specific program change numbers

When an item is selected, the display changes to the corresponding setting display

4 Follow the procedure to change the setting for the selected item (See below)

In the setting mode, no sound is produced from this instrument

5 Repeat steps 3 and 4 for each item as desired

6 When you have finished changing the settings, press the **PROGRAM MENUS** button or the **EXIT** button

## GENERAL MIDI

**GENERAL MIDI (GM)** is the standard which enables MIDI data exchange between different models or equipment of different manufacture. Program change numbers and their corresponding sounds, percussion instrument sounds, note numbers, etc. are data-compatible between equipment using this standard. Song data created on the equipment of one manufacturer can be played back on the equipment of a different manufacturer, as long as both conform to the **GENERAL MIDI** standard. This instrument conforms to this standard and can be used as a **GENERAL MIDI** sound generator.

Equipment which conforms to **GENERAL MIDI** standards is indicated by the following logo



**GM/OTHERS** sounds with a "\*" mark are **GENERAL MIDI** compatible

## BASIC CHANNEL

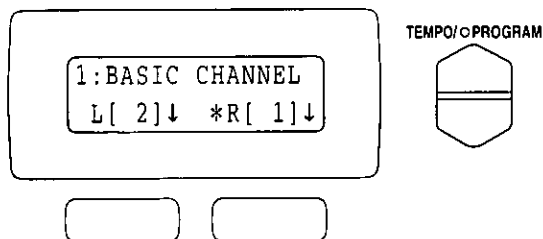

- Use the two buttons below the display to select a part (L: left; R: right).
  - An asterisk (\*) on the display indicates your selection.
- Use the **TEMPO/PROGRAM** buttons to select a channel number for the part (1 to 16).
  - The factory-preset settings are R[1] and L[2].

## LOCAL CONTROL

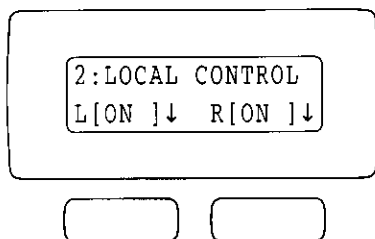

Use the two buttons below the display to set the respective left and right local controls to ON or OFF.

ON:

Performance data from this instrument is transmitted as MIDI data and also sounds from this instrument (power-on preset).

OFF:

Performance data from this instrument is transmitted as MIDI data but does not sound from this instrument.

## TRANPOSE OUT

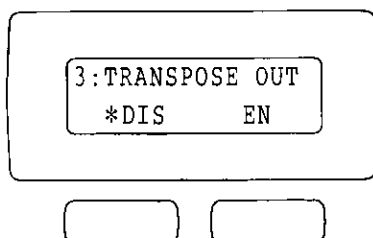

Use the two buttons below the display to disable (DIS) or enable (EN) the transmission of **TRANPOSE** data.

- An asterisk (\*) on the display indicates your selection.

EN:

The note numbers of the transposed notes (after they are transposed) are transmitted.

DIS:

Transpose data is ignored, and the note numbers of the played keys are transmitted (factory preset).

## PROGRAM CHANGE

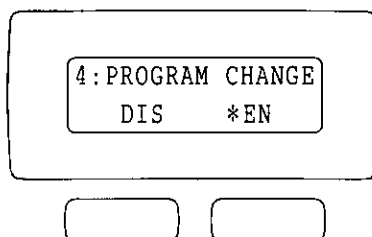

Use the two buttons below the display to disable (DIS) or enable (EN) the exchange of sound change data.

- An asterisk (\*) on the display indicates your selection.

EN:

Program (sound) change data is transmitted/received (factory-preset).

DIS:

Program (sound) change data is not transmitted/received.

- Please refer to the separate **REFERENCE GUIDE** provided for the program change number of each sound.

## PEDAL ON/OFF

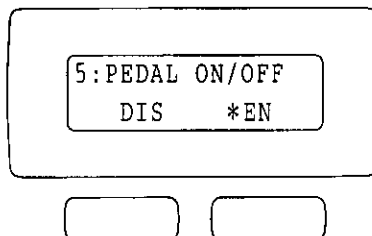

Use the two buttons below the display to disable (DIS) or enable (EN) the exchange of pedal data.

- An asterisk (\*) on the display indicates your selection.

EN:

Data of each pedal's operation is transmitted/received (factory-preset).

DIS:

Data of each pedal's operation is not transmitted/received.

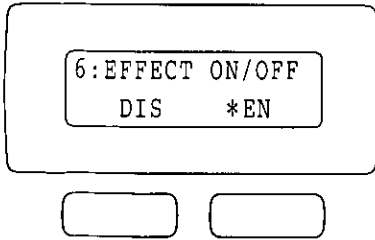
**EFFECT ON/OFF**

Use the two buttons below the display to disable (DIS) or enable (EN) the exchange of **DIGITAL EFFECT** on/off data.

- An asterisk (\*) on the display indicates your selection.

EN:

**DIGITAL EFFECT** on/off data is transmitted/received (factory-preset).

DIS:

**DIGITAL EFFECT** on/off data is not transmitted/received.

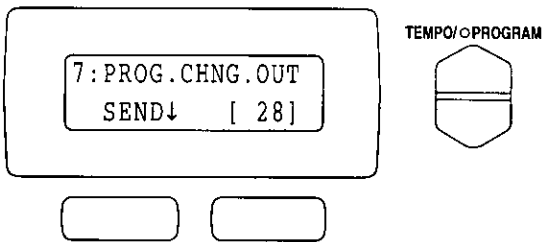
**PROGRAM CHANGE OUT**

1. Use the **TEMPO/PROGRAM** buttons to specify the program change number to send.

2. Press the left button below the display (SEND).

- The specified data is transmitted on the R (right) channel.

# Connections

(on the rear panel)

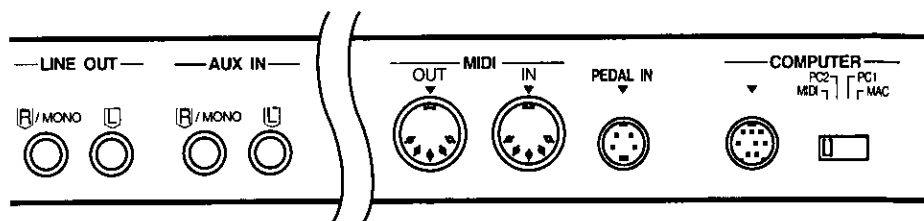

## AUX IN (input level 0.5 Vrms, 6 kΩ)

Other instruments such as a sound generator can be connected to this terminal, and the sound will be output from this instrument's speakers.

- To receive monaural sound, connect the other instrument to the **R/MONO** terminal. (Do not connect the **L** terminal.)

## LINE OUT (output level 1.5 Vrms, 600 Ω)

By connecting an external high-power amplifier, the sound can be reproduced at a high volume.

- To output monaural sound, connect the external equipment to the **R/MONO** terminal. (Do not connect the **L** terminal.) However, there are some cases where the sound quality may deteriorate depending on the sound.

## MIDI

These terminals are for connection to another MIDI instrument. (Refer to page 35.)

## HEADPHONES (phones) ×2

(Beneath the keyboard, on the left side)

For silent practice headphones may be used. When plugged in, the speaker system is automatically switched off, and sound is heard only through the headphones.

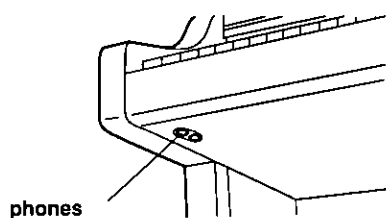

## COMPUTER

By connecting this terminal to the serial port of a computer, performance data can be exchanged. Use the switch to select the type of computer.

- Be sure that the power to this instrument is turned off when connecting to a computer or when changing the switch setting.

### Caution:

Failure to turn off the power before changing the switch setting may result in malfunction.

- The new switch setting is effective the next time the power is turned on.
- When no computer is connected, or when a MIDI interface is used, the switch should be set to **MIDI**.

### Connection to a Macintosh series computer

Use an **ACCESSORY CABLE (SZ-JJAP1: sold separately)** to connect the **COMPUTER** terminal of this instrument to the modem port or printer port of a Macintosh Series computer. Set the switch to **MAC**.

- Set the MIDI interface clock of the Macintosh software to 1 MHz.
- Do not remove the core at either end of the cable.

### Connection to a PC

Use an **ACCESSORY CABLE (SZ-JJAT1: sold separately)** to connect the **COMPUTER** terminal of this instrument to the RS232C terminal of a PC. Set the switch to **PC2**.

- The MIDI driver included with the cable should be installed in the computer. (Refer to the manual accompanying the cable.) This MIDI driver is not compatible with Windows NT or Windows 2000.
- Do not remove the core at either end of the cable.

\* All product and company names are trademarks or registered trademarks of their respective owners.

# Symptoms which appear to be signs of trouble

The following changes in performance may occur in this instrument but do not indicate trouble.

	Phenomenon	Remedy
Sounds and effects	The buttons, keys, etc. malfunction.	<ul style="list-style-type: none"> <li>• Turn off the <b>POWER</b> button once, then turn it on again. If this procedure is not successful, turn off the <b>POWER</b> button once. Then, while pressing the <b>INITIAL</b> key, turn the <b>POWER</b> button on again. (Note that, in this case, all programmable settings, functions and memories return to their factory-preset status.)</li> </ul>
	No sound is produced when the keys are pressed.	<ul style="list-style-type: none"> <li>• The <b>MAIN VOLUME</b> is at the minimum setting. Adjust the volume with the <b>MAIN VOLUME</b> control.</li> <li>• The <b>LOCAL CONTROL</b> for a part performed on the keyboard is set to OFF. Set the <b>LOCAL CONTROL</b> to ON. (Refer to page 37.)</li> </ul>
	Only percussive instrument sounds are produced when the keyboard is played.	<ul style="list-style-type: none"> <li>• The <b>DRUM KITS</b> sounds in the <b>GM/OTHERS</b> button is selected.</li> </ul>
	The volume is very low when the keyboard is played.	<ul style="list-style-type: none"> <li>• The volume setting in the <b>SEQUENCER</b> contents is very low. Follow the <b>INITIALIZE</b> procedure to reset the settings. (Refer to page 41.)</li> </ul>
	The sustain does not work even when the sustain pedal is depressed.	<ul style="list-style-type: none"> <li>• The sustain pedal is not connected. Connect the pedal cord firmly to the <b>PEDAL IN</b> terminal on the back of the instrument.</li> </ul>
SEQUENCER	Storage is not possible.	<ul style="list-style-type: none"> <li>• The remaining memory capacity of the <b>SEQUENCER</b> is 0. Follow the <b>SONG CLEAR</b> or <b>TRACK CLEAR</b> procedure to erase the memory. (Refer to pages 22, 26.)</li> </ul>
Disk Drive	The Disk Drive produces a noise during recording or playback.	<ul style="list-style-type: none"> <li>• This occurs when the Disk Drive is reading a disk. It does not indicate a problem.</li> </ul>
	When the procedure to play back a song from the disk is performed, the contents of the instrument's memory are erased.	<ul style="list-style-type: none"> <li>• When performing the operation to play back a song from a disk, this instrument's memory is overwritten by the data from the disk. If you wish to preserve a song which is stored in this instrument's memory, save it to a disk before performing the disk playback procedure. (Refer to page 30.)</li> </ul>
MIDI	Data cannot be exchanged through MIDI terminals.	<ul style="list-style-type: none"> <li>• The switch for the <b>COMPUTER</b> terminal is not set to <b>MIDI</b>. Turn off the power to this instrument and set the switch to <b>MIDI</b>. (Refer to page 39.)</li> <li>• Match the channels on the transmitting side and the receiving side. (Refer to page 37.)</li> </ul>
	The sound quavers or is distorted.	<ul style="list-style-type: none"> <li>• When the <b>COMPUTER</b> terminal or both the <b>MIDI IN</b> and <b>OUT</b> terminals are connected to a computer, depending on the computer software the received data may be sent back to the instrument just as it is. Because of this the sound generated from the keys and the sound generated from the returned data are both produced, causing undesirable effects, such as the sounds canceling each other out, for example. In this case, either change the software settings to prevent received data from being returned, or set the <b>MIDI LOCAL CONTROL</b> to off.</li> </ul>



Phenomenon		Remedy
Other	Noise from a radio or TV can be heard.	<ul style="list-style-type: none"> <li>• This sometimes occurs when electrical equipment such as a radio or TV is used near the instrument. Try moving such electrical equipment further away from the instrument.</li> <li>• The sound may be coming from a nearby broadcast station or amateur radio station. If the sound is bothersome, consult your dealer or service center.</li> </ul>
	The cabinet becomes warm during use.	<ul style="list-style-type: none"> <li>• This instrument has a built-in power source that heats the cabinet to some degree. This is not an indication of trouble.</li> </ul>

## Initialize

All of this instrument's settings can be reset to the factory-preset status.

1. Turn off the power to this instrument.

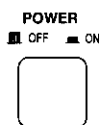

2. While pressing the keyboard key labeled **INITIAL**, turn the power on again.

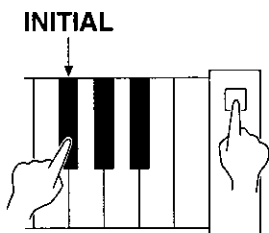

- The initialize operation is executed (ALL INITIAL is shown on the display).
- Another initialize procedure is explained in the section on CONTROL functions. (See INITIALIZE on page 33.)

### ■ Settings that are initialized by this procedure

SEQUENCER contents (The song data recorded in this instrument is erased.)

All function settings (reset to their factory-preset settings or values)

### ■ About the backup memory

The instrument settings (except recorded song data) is retained for about one week after the power is turned off.

To save your recorded song data, please store it on a floppy disk before turning off the power. (Refer to page 30.)

- This instrument's recorded song data is retained for about one minute after the power is turned off.

### ■ Power on settings

When the **POWER** button of this instrument is turned on, the settings below are automatically set to those suitable for piano performance.

Sound:

R = Concert Grand

L = Acoustic Bass

SPLIT: Off

LOCAL CONTROL: On

etc.

# Assembly

Follow the steps below to assemble your Technics piano. Make sure you are using the correct parts and that they are in the correct direction.

- At least 2 people are required for assembly
- To disassemble the piano, reverse the procedure

1 Remove the packing and take the parts out of the carton. Confirm that all the parts on the printed list are present.

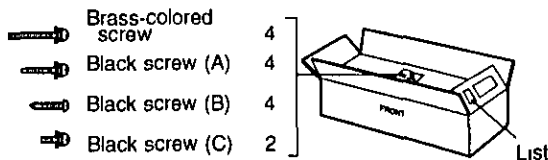

2 Affix the right and left side planks to the pedal box.

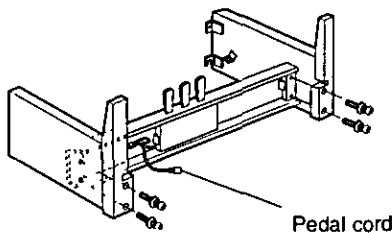

(1) Use the 4 brass-colored screws to secure the planks.

(2) Be sure to insert the screws straight.

- If a screw is inserted crookedly, it may be damaged.

(3) Insert each of the 4 screws partway, lightly securing each one little by little. After confirming that the screws are all correctly inserted, tighten each one securely.

- If each screw is tightened securely before all the screws are inserted, the last screw may be very difficult to insert.

(4) Extend the pedal cord, stowed on the inner side of the pedal box.

3 Affix the rear panel.

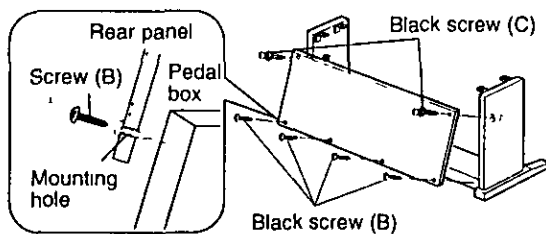

- For the brown wood grain model, affix the rear panel so that the wood grain surface is facing the front.

(1) Insert the 2 black screws (C) partway in the upper part of the rear panel, securing them only lightly. Do not tighten the screws completely at this time.

- If the screws are tightened securely at this time, it may be difficult to affix the lower part of the rear panel.

(2) Insert the 4 black screws (B) through the mounting holes in the lower part of the rear panel and tighten the screws fully.

- Run the screws directly into the pedal box as there are no rough holes in the pedal box.

(3) Tighten the 2 black screws (C) in the upper part of the rear panel completely.

4 Place the piano body on the stand.

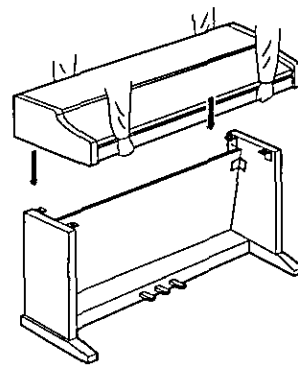

## WARNING

Avoid pinching your fingers.

## Note 1

Holding the piano body at least 10 cm in from the edge, place it on the stand so that it does not fall off.

## Note 2

If the piano body is placed too far to the right or left, or to the front or back, it will become unstable.

5 Secure the piano body to the stand.

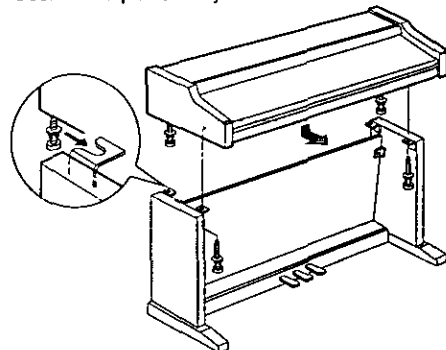

(1) Insert 2 black screws (A) in the 2 rear screw holes on the underside of the piano body, and turn each screw 5 or 6 times. Push the piano body forward so that the screws are fully inserted in the cutout of the metal piece on either side plank. (This enables you to easily position the piano body on the stand.)

- (2) Adjust the piano body so that the right and left sides project evenly over the stand.

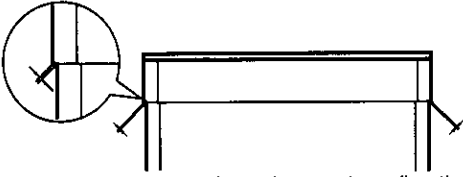

- (3) Positioning the piano body on the stand, confirm that the 4 back screws (A) can easily be inserted.

- (4) Tighten the 4 screws securely.

6. Connect the pedal cord and power cord to the terminals.

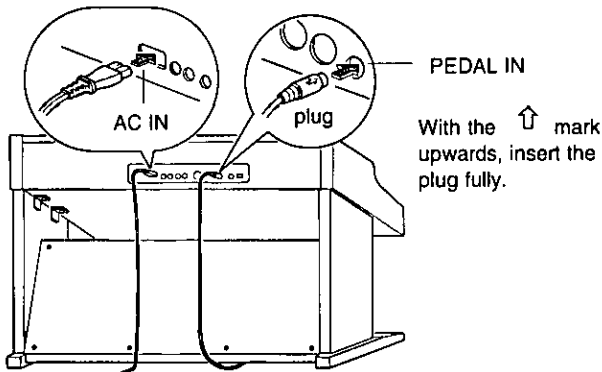

- Plug the pedal cord and power cord into the terminals on the rear of the piano.

### Confirm

After assembling, check these points.

- Are any parts left over?
    - Check the assembly procedure again.
  - Does the piano rattle when it is rocked?
    - Make sure all the screws are securely tightened.
  - Is the power cord firmly inserted?
    - Check again.
  - Is the plug of the pedal cord inserted as far into the connector terminal as it will go?
    - If it is not completely inserted, the sustain and other pedal functions may not work.
- When the piano has been moved or transported, re-tighten the screws securely.

# Error messages

No.	Contents
00: WRONG DISK!	The data on the disk that you are using is for a different product.
01: LOAD ERROR! TRY AGAIN!	An error has occurred while the disk was loading. Please try again!
02: NO DISK	There is no disk in the Disk Drive.
03: FILE EMPTY!	The file that you tried to play is empty.
04: SAVE ERROR! TRY AGAIN!	An error has occurred while the disk was saving. Please try again!
05: WRITE PROTECTED!	The disk that you are using is write protected. Please remove the write protection and try again.
06: DISK FULL!	The disk that you are using is full. Please use another disk.
07: FORMAT ERROR	An error has occurred while the disk was formatting. The disk that you are using may be faulty. Please try formatting another disk.
08: COPY PROTECTED!	You attempted to save a song which is based on copyrighted song data. Such data cannot be saved.
09: NO SEQUENCER DATA!	The song you are trying to save is empty.
10: UNFORMAT DISK	The disk you are using has not been formatted. Format the disk before using it.
11: SEQUENCER DATA ERROR!	An error occurred during playback. Playback is not possible.
12: MEMORY FULL!	The recording memory is full. Further recording is not possible.
13: ONLY FOR PLAY	This song data is for playback only. Recording or saving to a disk is not possible.
14: DRUM KIT ONLY FOR RHYTHM TR	DRUM KIT sounds ( <b>GM/OTHERS</b> ) can be recorded only in the <b>RHYTHM</b> track. It is not possible to record these sounds in other tracks.

# Specifications

	<b>SX-PX665</b>
KEYBOARD	88 KEYS
SOUND GENERATOR	PCM
MAX. POLYPHONY	64 NOTES
SOUND	350 SOUNDS: GRAND PIANO, UPRIGHT PIANO, ELECTRIC PIANO, MODERN PIANO, HARPSI, VIBES, STRINGS, VOCAL, ORGAN PRESETS, GM/OTHERS
SPLIT	LEFT SOUND, SPLIT POINT, LEFT VOLUME, LEFT OCTAVE, RIGHT OCTAVE, SUSTAIN PEDAL
PEDAL	SUSTAIN, SOSTENUTO, SOFT
EFFECT	DIGITAL EFFECT, PIANO AMBIENCE, DIGITAL REVERB, STRING RESONANCE
BRILLIANCE	MELLOW, BRIGHT (5 STEPS)
TOUCH SENSITIVITY	LIGHT, NORMAL, HEAVY
TRANPOSE	G-C-F#
METRONOME	BEAT: OFF, 2/2, 2/4, 3/4, 4/4, 5/4, 6/4, 7/4, 3/8, 6/8, 9/8, 12/8, TEMPO
SEQUENCER	TRACK: 1-4, RHYTHM STORAGE CAPACITY: APPROX. 20000 NOTES, RECORDING MODE: REAL TIME COUNT IN, SEQUENCER VOLUME, RESET, STOP, PLAY, RECORD, BWD, FWD MENUS: SONG NAMING, TEMPO WRITE, PANEL WRITE, PART SETTING, FIXED TEMPO, SONG CLEAR, TRACK CLEAR
DISK DRIVE	3.5inch FLOPPY DISK DRIVE for 2HD (1.44MB), 2DD (720kB) SONG SELECT MENUS: SONG SAVE, SONG DELETE, DISK FORMAT
CONTROL	INITIALIZE, MASTER TUNING, KEY SCALING, PIANO TUNING, MINIMUM RANGE, REVERB CONTROL
MIDI	BASIC CHANNEL, LOCAL CONTROL, TRANPOSE OUT, PROGRAM CHANGE, PEDAL ON/OFF, EFFECT ON/OFF, PROGRAM CHANGE OUT
DISPLAY	LCD (16 CHARACTER x 2 LINES)
DEMO	○
TERMINALS	LINE OUT (R/MONO, L), AUX IN (R/MONO, L), MIDI (IN, OUT), COMPUTER, PEDAL IN, PHONESx 2
OUTPUT	120W (60W x 2)
SPEAKERS	14 cm x 2, 6.5 cm x 2
POWER REQUIREMENT	135 W/180 W (NORTH AMERICA AND MEXICO)
	AC 120/220/240 V 50/60 Hz AC 120V 60 Hz (NORTH AMERICA AND MEXICO) AC 230-240V 50/60 Hz (EUROPE, AUSTRALIA, NEW ZEALAND, SINGAPORE AND PHILIPPINES)
DIMENSIONS (WxHxD)	142 cm x 106.7 cm x 51.4 cm (55-29/32" x 42" x 20-1/4")
NET WEIGHT	55 kg (121.3 lbs.)
ACCESSORIES	AC CORD

- In some markets, one of the models may not be available.
- Design and specifications are subject to change without notice.

# Demo Performance List

SOUND				
<input type="radio"/> HARPSI	<input type="radio"/> VIBES	<input type="radio"/> STRINGS	<input type="radio"/> VOCAL	<input type="radio"/> ORGAN PRESETS
5	6	7 A	8 B	9
<input type="radio"/> GRAND	<input type="radio"/> UPRIGHT	<input type="radio"/> ELECTRIC	<input type="radio"/> MODERN	<input type="radio"/> GM/OTHERS
	1 C	2 D	3 E	4
PIANO				

SOUND NAME	#	SONG TITLE	COMPOSER
<b>GRAND</b>	1	Polonaise Heroique	Chopin
	2	Clair de Lune (Suite bergamasque)	Debussy
	3	from Sonata A major (K 331)	Mozart
	4	Military March	Schubert
	5	Technics Original	
	6	Danny Boy	Traditional
	7	Beautiful Dreamer	Foster
	8	Swanee River	Traditional
	9	Dynamic Acoustic feature demo*	Technics Original
<b>UPRIGHT</b>		My Lady's-Ride (25 Easy Studies Op 100)	Burgmuller
<b>ELECTRIC</b>		Amazing Grace	Traditional
<b>MODERN</b>		Technics Original	
<b>HARPSI</b>		Prelude in C# major No 3 from Book 1 of 48 Preludes & Fugues (BWV 848)	Bach
<b>VIBES</b>		La Paloma	Traditional
<b>STRINGS</b>		Technics Original	
<b>VOCAL</b>		Ave Maria	Burgmuller
<b>ORGAN PRESETS</b>	A	Courante from Suite No 5 in G major (BWV 816)	Bach
	B	The House of the Rising Sun	Traditional
<b>GM/OTHERS</b>	C	Technics Original	
	D	Technics Original	
	E	from Piano Concerto No 21 2nd Movement	Mozart

\* This demo highlights the New Dynamic Acoustic system PCM sound generator of this piano. It exhibits Total Sound reproduction, created by the addition of the Hammer Sound and String Resonance to the basic sound.



**PANASONIC CONSUMER ELECTRONICS COMPANY**  
**DIVISION OF MATSUSHITA ELECTRIC CORPORATION OF AMERICA**  
One Panasonic Way, Secaucus, New Jersey 07094

Printed in Japan

[Consumerproducts@Panasonic.com](mailto:Consumerproducts@Panasonic.com)

**ENGLISH**

**M Se020180 QQTG0840A**