

Technics

DIGITAL PIANO

SX-PX662

SX-PX664

SX-PX663



WARNING:

TO REDUCE THE RISK OF FIRE, ELECTRIC SHOCK OR PRODUCT DAMAGE, DO NOT EXPOSE THIS APPLIANCE TO RAIN, SPLASHING, DRIPPING OR MOISTURE.

BEFORE YOU PLAY, PLEASE READ THE CAUTIONARY COPY APPEARING ON PAGE 4.

CAUTION:

This equipment has been tested and found to comply with the limits for a Class B digital device, pursuant to Part 15 of the FCC Rules. These limits are designed to provide reasonable protection against harmful interference in a residential installation. This equipment generates, uses and can radiate radio frequency energy and, if not installed and used in accordance with the instructions, may cause harmful interference to radio communications. However, there is no guarantee that interference will not occur in a particular installation. If this equipment does cause harmful interference to radio or television reception, which can be determined by turning the equipment off and on, the user is encouraged to try to correct the interference by one of the following measures:

- Reorient or relocate the receiving antenna.
- Increase the separation between the equipment and receiver.
- Connect the equipment into an outlet on a circuit different from that to which the receiver is connected.
- Consult the dealer or an experienced radio/TV technician for help.

Any unauthorized changes or modifications to this equipment would void the user's authority to operate this device.

This device complies with Part 15 of the FCC Rules. Operation is subject to the following two conditions: (1) This device may not cause harmful interference, and (2) this device must accept any interference received, including interference that may cause undesired operation.



CAUTION

**RISK OF ELECTRIC SHOCK
DO NOT OPEN**



CAUTION: TO REDUCE THE RISK OF ELECTRIC SHOCK, DO NOT REMOVE SCREWS. NO USER-SERVICEABLE PARTS INSIDE. REFER SERVICING TO QUALIFIED SERVICE PERSONNEL.



The lightning flash with arrowhead symbol, within an equilateral triangle, is intended to alert the user to the presence of uninsulated "dangerous voltage" within the product's enclosure that may be of sufficient magnitude to constitute a risk of electric shock to persons.



The exclamation point within an equilateral triangle is intended to alert the user to the presence of important operating and maintenance (servicing) instructions in the literature accompanying the appliance.

The model number and serial number are found underneath the keyboard. Please note the model and serial numbers in the space provided below and retain this sheet as a permanent record of your purchase to aid identification in the event of theft.

MODEL NUMBER _____

SERIAL NUMBER _____

Technics

OWNER'S MANUAL

Before you play

For long and pleasurable use of this instrument, and to gain a thorough understanding of your **PX664** Digital Piano, it is strongly recommended that you read through this Owner's Manual once

The Owner's Manual is comprised of the following parts

Preparative

This part includes an explanation of how to set up to play the instrument and basic knowledge for playing

Various Functions

This part comprises a detailed explanation of sound, effect, rhythm, **SEQUENCER**, Disk Drive and MIDI

REFERENCE GUIDE (separate booklet)

Reference guide for the contents of the **SOUND**, MIDI Implementation Chart, etc

Supplied accessory

Please check the supplied accessory



AC cord

Music Stand

Important Safety Instructions

WARNING

When using electric products, basic precautions should always be followed, including the following;

- Read all the instructions before using the product.

Safety

- **Power Source**—The product should be connected to a power supply only of the type described in the operating instructions or as marked on the product.
- **Polarization**—This product may be equipped with a polarized line plug (one blade wider than the other). This is a safety feature. If you are unable to insert the plug into the outlet, contact an electrician to replace your obsolete outlet. Do not defeat the safety purpose of the plug.
- **Periods of Non-use**—The power-supply cord of the product should be unplugged from the outlet when left unused for a long period of time.

Installation

- **Water and Moisture**—Do not use this product near water—for example, near a bathtub, washbowl, kitchen sink, in a wet basement, or near a swimming pool, or the like.
- **Cart/Stand**—This product should be used only with a cart or stand that is recommended by the manufacturer.
- **Ventilation**—The product should be located so that its location or position does not interfere with its proper ventilation.
- **Heat**—The product should be located away from heat sources such as radiators, heat registers, or other products that produce heat.
- **Foreign Material**—Care should be taken so that objects do not fall and liquids are not spilled into the enclosure through openings.

Listening caution

This product, either alone or in combination with an amplifier and headphones or speakers may be capable of producing sound levels that could cause permanent hearing loss. Do not operate for a long period of time at a high volume level or at a level that is uncomfortable. If you experience any hearing loss or ringing in the ears, you should consult an audiologist.

Service

- **Damage Requiring Service**—The product should be serviced by qualified service personnel when:
 - a. The power-supply cord or the plug has been damaged; or
 - b. Objects have fallen, or liquid has been spilled onto the product; or
 - c. The product has been exposed to rain; or
 - d. The product does not appear to operate normally or exhibits a marked change in performance; or
 - e. The product has been dropped, or the enclosure damaged.
- **Servicing**—Do not attempt to service the product beyond that described in the user-maintenance instructions. All other servicing should be referred to qualified service personnel.

Maintenance

- Be sure to switch this unit off after use, and do not switch the unit on and off in quick succession, as this places an undue load on the electronic components.
- To maintain the luster of the keys and buttons, wipe with a clean, damp cloth, and polish with a soft, dry cloth. Polish may be used, but do not use thinners or petro-chemical-based polishes.
- A wax-based polish may be used on the cabinet, although you will find that rubbing with a soft cloth will suffice.

SAVE THESE INSTRUCTIONS

Getting started

- 1 Plug the power cord into an outlet.

- 2 Press the **POWER** button to turn it on.

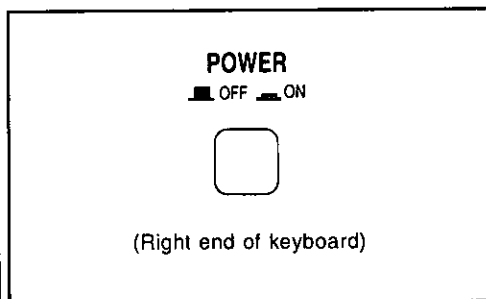

- The power indicator in the left front of the body is lit.

- 3 Play the keyboard.
- Set the **MAIN VOLUME** to an appropriate level with the sliding control.

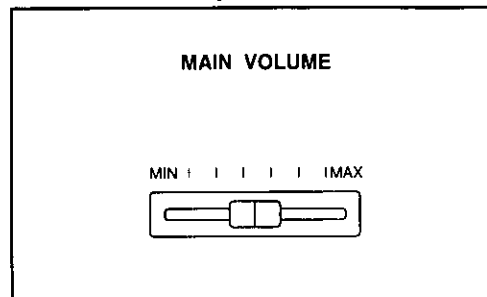

- No sound will be heard when the sliding control is set to **MIN**.

Keyboard cover

Open and close the cover slowly.

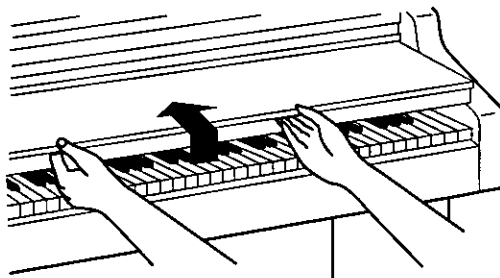

- **PX662**: The cover can be set at a point where only the keys are visible.

Music stand

Insert the music stand in the two holes as shown in the diagram.

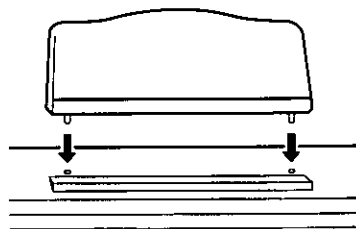

Tuning

Unlike an acoustic piano, your Digital Piano never needs tuning.

- The pitch of this instrument can be adjusted when playing along with other instruments. (Refer to page 11.)

Listen to the demonstration

Automatic performances which introduce you to the sounds are stored in the memory of this piano.

Grand piano demonstration performance

1 Press the **DEMO** button.

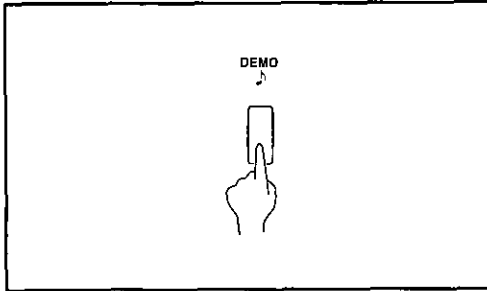

- The indicators for the **SOUND** buttons flash.
- The display changes to the [- -] display.

2 Select **GRAND (PX662)/ CONCERT GRAND (PX664)**.

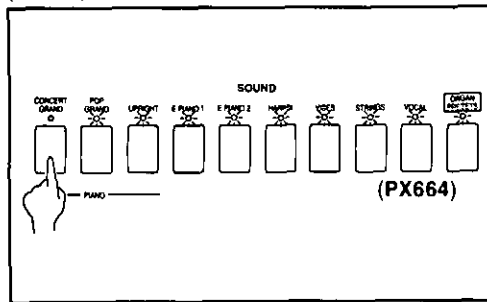

- The **SOUND** buttons which contain **GRAND** piano demonstration tunes are shown by the flashing indicators.

3 Select a **SOUND** button (other than **GRAND**) whose indicator is flashing.

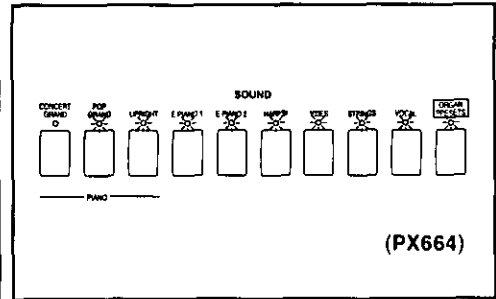

- The demonstration tune starts.
- The indicator of the selected **SOUND** button flashes.
- If the button for the current demonstration tune is pressed, the demonstration performance stops.
- Listen to the other **GRAND** piano demonstration tunes in the same way.

4 When you are finished listening to the demonstration tunes, press the **DEMO** button again.

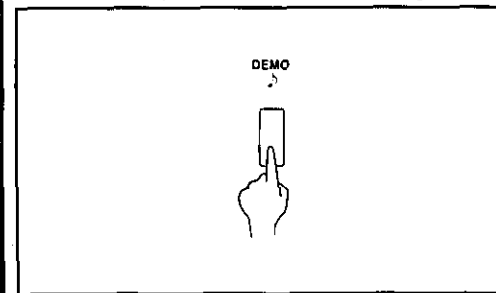

- The display turns off.

Demonstration performances for other sounds

1 Press the **DEMO** button.

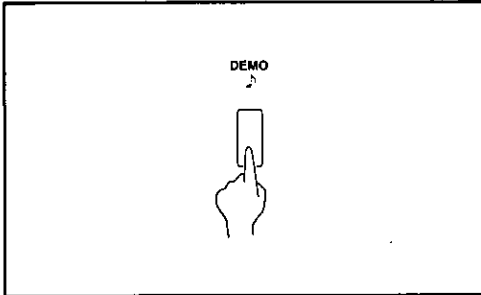

- The indicators for the **SOUND** buttons flash.
- The display changes to the [- -] display.

2 Select a sound (other than **GRAND**) you wish to hear.

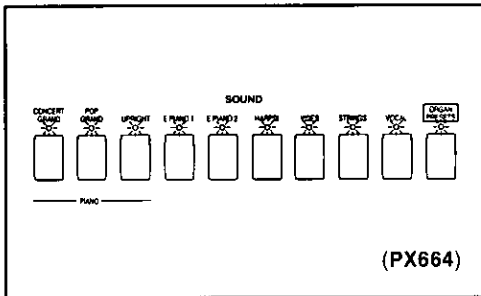

- The demonstration tune starts.
- The indicator of the selected **SOUND** button flashes and the other indicators go out.
- If the button for the current demo is pressed, the demonstration performance stops.
- Listen to the demonstration tunes for the other sounds in the same way.
- **PX664**: Two different demonstration tunes are available for the **ORGAN PRESETS**. Press the **ORGAN PRESETS** button and select one of the buttons with a flashing indicator.

3 When you have finished listening to the demonstration performances, press the **DEMO** button again.

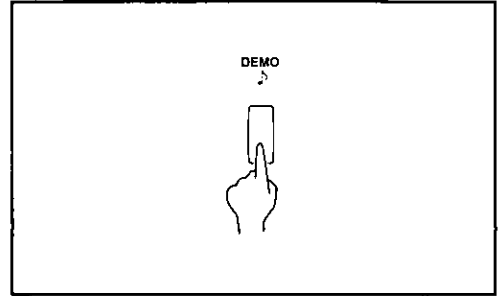

- The display turns off.

Listen to all the demonstration tunes in order.

Press and hold the **DEMO** button for a few seconds.

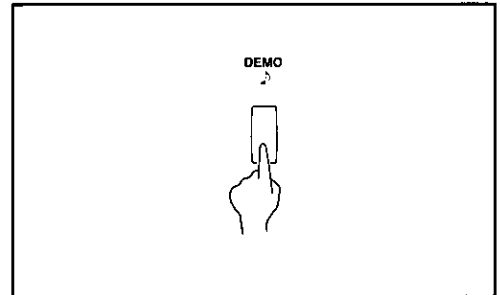

- All the demonstration tunes are automatically played in order.
- If you press the button with the flashing indicator during the demonstration performance, the current tune stops and the next tune begins.
- You can also first press the **DEMO** button and then the **START/STOP** button to play the tunes in order.
- The tunes are repeated in order until the **DEMO** button or **START/STOP** button is pressed again.

- You can play the keyboard while the demonstration performances are playing.
- Some of the buttons do not function while the demonstration performances are being played.

Sounds and effects

SOUND

Press one of the **SOUND** buttons to select the desired sound.

Each sound features Touch Response, which increases the volume when the keyboard is played harder.

- The sounds can be mixed when two **SOUND** buttons are pressed simultaneously. (Refer to page 10.)
- **PX664**: If the **ORGAN PRESETS** button is pressed, organ sounds are produced. (Refer to page 10.)
- On this piano, the maximum number of notes which can sound simultaneously is 64.

DIGITAL REVERB

DIGITAL REVERB applies a reverberation effect to the sound. Select from four echo types—**ROOM**, **STAGE**, **HALL** and **CONCERT**.

- The type and depth of the **DIGITAL REVERB** can be set for each sound. (Refer to page 12.)

DIGITAL EFFECT

A celeste effect can be applied to give the sound greater depth.

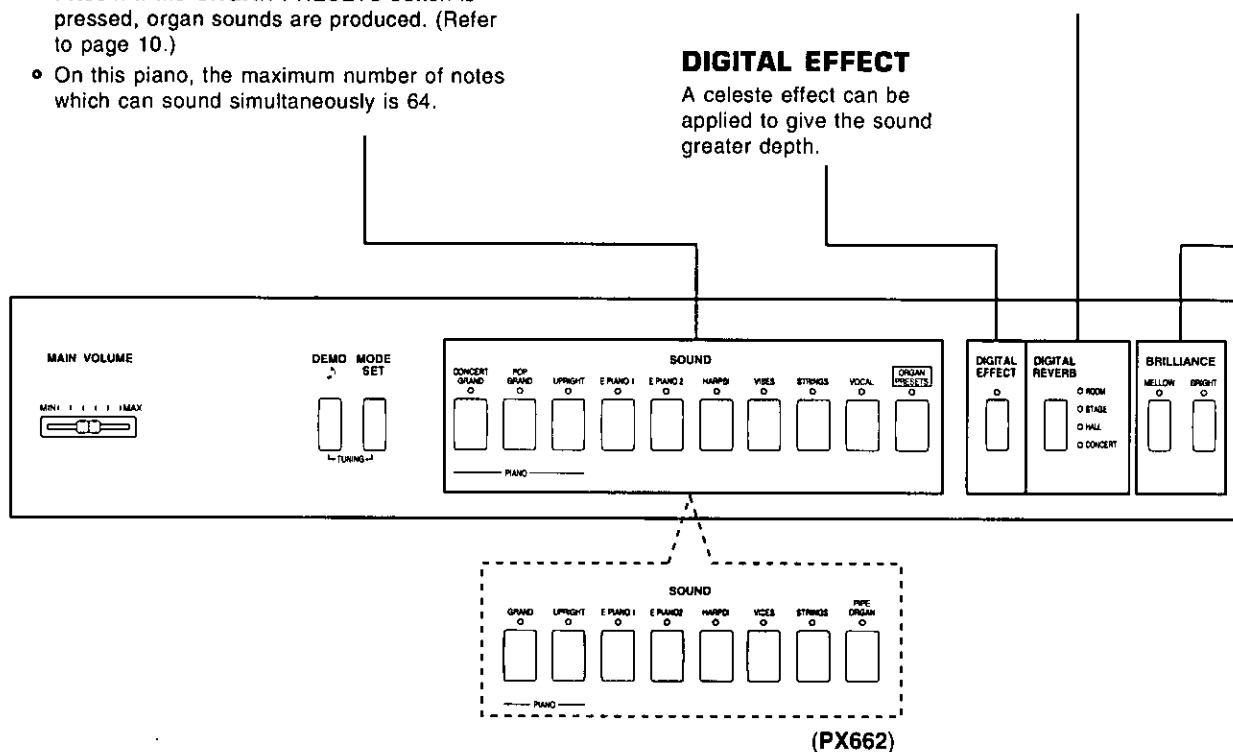

Sostenuto pedal

The middle pedal is used as a sostenuto pedal. If the pedal is pressed while the keys are pressed, a sustain effect is applied to those notes only.

- For sustained-type sounds (**ORGAN**, **STRINGS** and **VOCAL [PX664]**), the notes sound for as long as the pedal is depressed.

Soft pedal

The left pedal can be used as a soft pedal. When the pedal is depressed, the sound is softer.

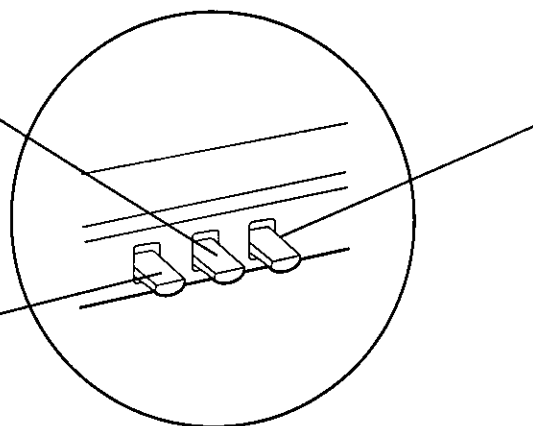

BRILLIANCE

The **BRILLIANCE** allows you to select the brightness of the sound from 5 settings

If either of the buttons is pressed once, the current setting value will appear on the display, and it can then be changed

Pressing the **BRIGHT** button increases the brightness, when the **MELLOW** button is pressed, the sound becomes mellower. During setting the brightness is shown on the display (-2 to 2)

- Press both buttons at the same time to return the brightness to 0
- A short time after the setting is completed, the display will return to the turned-off condition
- If the **BRILLIANCE** has been set to a number other than 0, one of the indicators remains lit

TOUCH SENSITIVITY

The keyboard touch (Touch Response) can be changed to match your type of playing

- Choose from **LIGHT**, **NORMAL** and **HEAVY**

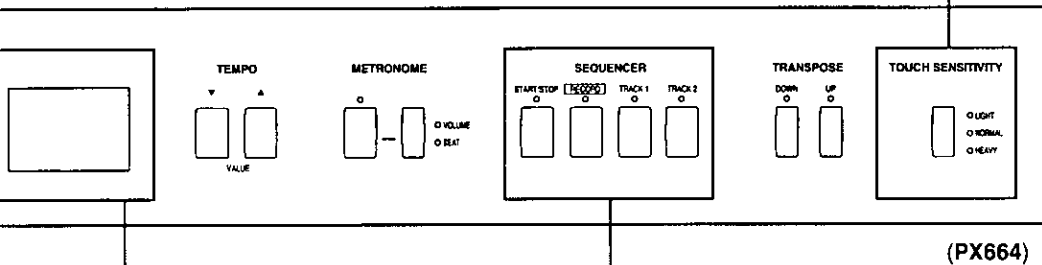

Display

The display shows a variety of different setting values, and also the **SEQUENCER** and **METRONOME** tempos

- During normal playing, it is turned off

SEQUENCER

Record your performance and have it automatically played back (Refer to page 14)

Sustain pedal

The right pedal allows you to use sustain. When a key is released while this pedal is depressed, the sound is sustained so that it lingers and slowly fades out

- String resonance is added to some sounds (Refer to page 12)

Setting the effects for each sound

The **DIGITAL EFFECT**, **BRILLIANCE** and **DIGITAL REVERB** are stored independently for each sound. When a **SOUND** button is pressed, the effect settings for the selected sound are recalled.

Organ Presets (PX664)

You can produce organ sounds when the **ORGAN PRESETS** button in the **SOUND** section is on. There are 9 different organ sounds provided for you to choose from.

To produce organ sounds

1. Turn on the **ORGAN PRESETS** button.

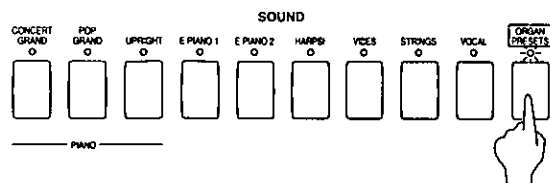

2. Press any key on the keyboard to hear the organ sound.

To select a sound

1. Press and hold the **ORGAN PRESETS** button for about 3 seconds.

- The indicator flashes.

2. Use the **TEMPO** buttons to select an organ sound.



- The name of the sound is shown on the display.
C-1 to C-4: CLASSICAL (PIPE) ORGAN sounds
J-1 to J-5: JAZZ ORGAN sounds
- Play the keyboard to hear the selected sound.
- To quickly select a sound, while pressing the **ORGAN PRESETS** button, use the **TEMPO** buttons to select the sound.
- When a **JAZZ ORGAN** sound is selected, the **DIGITAL EFFECT** button is used to switch the tremolo speed (on=fast; off=slow).

Mixing two sounds

You can play two different sounds at the same time, thus obtaining a composite sound having a depth not possible in a single sound. The volume balance for each of the sounds can also be adjusted.

Mixing sounds

1. Press two **SOUND** buttons at the same time.

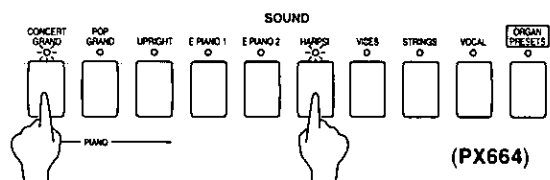

2. Press any key on the keyboard to hear the mixed sound.

- The on/off status of the **DIGITAL EFFECT** is effective for each sound. In addition, the **BRILLIANCE** and **DIGITAL REVERB** settings are memorized for each combination of sounds.

Volume balance

1. Press the two **SOUND** buttons continuously for 2 or 3 seconds.

- The indicators for the two sounds flash, and the current volume balance is shown on the display.

2. Use the **TEMPO** buttons to adjust the volume balance.

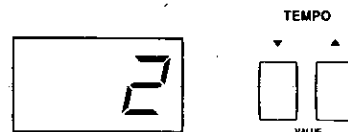

- Each time the **▲** button is pressed, the volume of the right-side sound increases, and each time the **▼** button is pressed, the volume of the left-side sound increases. Play the keyboard to hear the volume balance.
- If the two **TEMPO** buttons are pressed at the same time, the volume is equally balanced.
- On the display, the right-side sound is louder when a number 1 to 10 is shown, and the left-side sound is louder when a number -1 to -10 is shown.

3. When you have finished adjusting the volume balance, press any **SOUND** button.

Transpose

Suppose you learn to play a song—in the key of C, for example—and decide you want to sing it, only to find it's either too high or too low for your voice. Your choice is to either learn the song all over again, in a different key, or to use the **TRANSPOSE** feature.

Use the **TRANSPOSE** buttons to adjust the key.

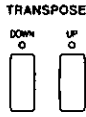

- If either of the buttons is pressed once, the current setting value will appear on the display, and it can then be changed.
- When setting the key, the current key is shown on the display.

- If the two buttons are pressed at the same time, the key returns to C.
- If either of the **TRANSPOSE** indicators remains lit, it indicates that the piano is set to a key other than C.

Each press of the DOWN button:		Each press of the UP button:
G [-G] ← A [♯] [-A [♯]] ← A [-A] ← B [♭] [-B [♭]] ← B [-B] ← C [C]		→ D [♯] [-D [♯]] → D [D] → E [♯] [-E [♯]] → E [E] → F [F] → F [♯] [-F [♯]]

[] shows the indication on the display.

Tuning

The pitch of the instrument can be adjusted. This capability is useful, for example, for ensemble playing.

1. Press the **DEMO** and **MODE SET** buttons simultaneously.

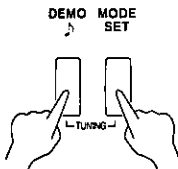

- The current tuning is shown on the display.

2. Use the **TEMPO** buttons to adjust the pitch.

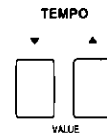

- Press the Δ button to raise the pitch and press the ∇ button to lower the pitch (427.3–440.0–453.0 Hz).
- Press and hold either **TEMPO** button to change the pitch quickly.
- The 100's digit (4) is not shown on the display. The decimal can be set to 0, 3 or 6.
- If both **TEMPO** buttons are pressed at the same time, the pitch returns to 440.0 Hz.

3. When you have finished adjusting the pitch, press either the **DEMO** button or the **MODE SET** button.

Reverb depth

The type and depth of the **DIGITAL REVERB** can be adjusted for each sound.

1. Select a sound.
2. Select a type of **DIGITAL REVERB**.
4. Use the **TEMPO** buttons to adjust the depth of the reverb.

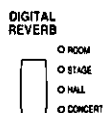

3. While pressing the **MODE SET** button, press the **DIGITAL REVERB** button.

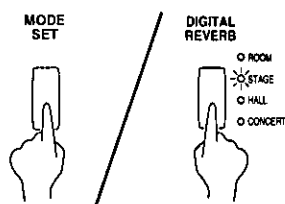

- The indicator for the selected type flashes.



- The current reverb depth (1–10) is shown on the display.
 - Each press of the **▲** button increases the reverb depth, and each press of the **▼** button decreases the reverb depth.
 - To return instantaneously to the standard reverb depth, press the two **TEMPO** buttons at the same time.
5. When you have finished adjusting the reverb depth, press either the **MODE SET** button or the **DIGITAL REVERB** button.

String resonance

String resonance is the sound heard in an acoustic piano when the struck strings produce a sympathetic resonance of the other unstruck strings. For the **GRAND (PX662)/ CONCERT GRAND (PX664)**, **UPRIGHT** and **POP GRAND (PX664)** sounds, string resonance is produced as long as the sustain pedal is depressed. The amount of string resonance can be adjusted, and is common for all the sounds.

- When the **DIGITAL REVERB** is on, there is no string resonance.

1. Press and hold the **GRAND (PX662)/ CONCERT GRAND (PX664)** button for about 3 seconds.

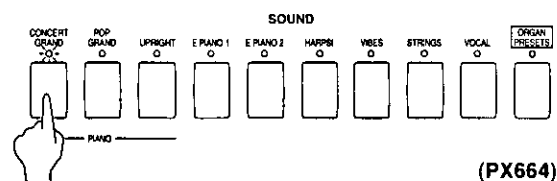

2. Use the **TEMPO** buttons to adjust the amount of resonance (0–10).



- Each time the **▲** button is pressed, the resonance increases. Each time the **▼** button is pressed, the resonance decreases.
 - When set to 0, there is no string resonance.
 - Pressing both buttons at the same time will return the instrument to the standard resonance.
3. When you have finished adjusting the string resonance, press the **GRAND** button again.

Metronome

You can play in time with the metronome sound, and you can add an accent to the metronome sound.

METRONOME sound

1. Press the **METRONOME** button to turn it on.

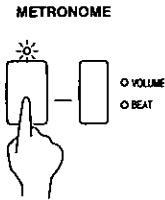

• The metronome sound begins.

2. Adjust the tempo with the **TEMPO** buttons.



- Each time the ∇ button is pressed, the tempo slows down, and each time the Δ button is pressed, the tempo speeds up.
- The tempo can be adjusted to $\text{♩} = 40\text{--}300$ and is shown on the display.
- Press and hold either **TEMPO** button to change the tempo quickly.
- Pressing both **TEMPO** buttons at the same time returns the tempo to the standard $\text{♩} = 120$.

3. Press the **METRONOME** button again to turn off the metronome sound.

METRONOME volume

1. Press the **VOLUME BEAT** button so that the **VOLUME** indicator lights.

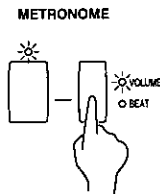

2. Use the **TEMPO** buttons to adjust the volume.

- Each press of the Δ button increases the volume, and each press of the ∇ button decreases the volume.
- The volume can be adjusted to a setting from 1 to 9.
- If the two buttons are pressed at the same time, the volume returns to the standard setting.

3. When you have finished making the setting, press the **VOLUME BEAT** button twice so that the indicators go out.

Accented METRONOME sound

1. Press the **VOLUME BEAT** button so that the **BEAT** indicator lights.

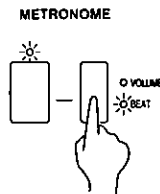

2. Use the **TEMPO** buttons to select the time signature.

- Select a time signature from OFF, 2/4 [2-4], 3/4 [3-4], 4/4 [4-4], 5/4 [5-4] and 6/8 [6-8].
- An accent is added to the first beat of each measure of the selected time signature.

• The accent is shown on the display.



- If OFF is selected, the beat is not accented.
- Pressing both **TEMPO** buttons at the same time returns the time signature to the standard 4/4 time.

3. When you have finished making the setting, press the **VOLUME BEAT** button once so that the indicators go out.

Sequencer

You can store your performance in the **SEQUENCER** and have it played back. There are two **SEQUENCER** tracks, each of which can be recorded independently (multi-track recording) and played back separately or together.

How to use the SEQUENCER

Record your performance just as you play it.

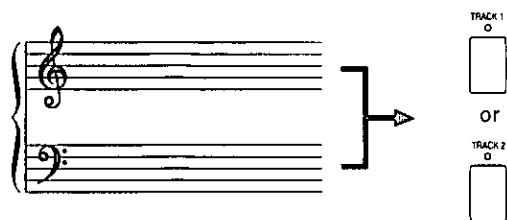

Record each of the two parts separately (multi-track recording).

1. Record part 1 in **TRACK 1**.

Part 1

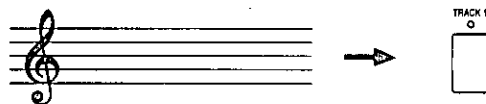

2. While playing back part 1, record part 2 in **TRACK 2**.

Part 2



Record, for example, the right-hand part in **TRACK 1** and left-hand part in **TRACK 2**.

The performance data, pedal operation, beginning sound and sound selection changes (for both the left and right parts), **DIGITAL EFFECT** on/off operation and the volume balance of mixed sounds are all recorded in the **SEQUENCER**.

Recording

Follow these step-by-step instructions to record the example below in the **SEQUENCER**.

<TRACK 1>
GRAND

<TRACK 2>
ORGAN

A musical score for two tracks. The top staff is labeled '<TRACK 1> GRAND' and contains a treble clef with a melody of eighth and sixteenth notes. The bottom staff is labeled '<TRACK 2> ORGAN' and contains a bass clef with a bass line of chords and notes. The music spans four measures.

A continuation of the musical score for two tracks. The top staff is labeled '<TRACK 1> GRAND' and contains a treble clef with a melody of eighth and sixteenth notes. The bottom staff is labeled '<TRACK 2> ORGAN' and contains a bass clef with a bass line of chords and notes. The music spans four measures.

■ Record TRACK 1.

1. Select the sound and set the **DIGITAL EFFECT** to on or off.

2. Press the **RECORD** button to turn it on.

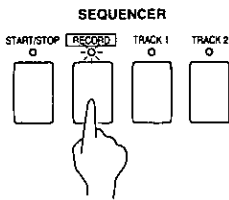

- The **TRACK 1** and **2** indicators flash rapidly.
- The tempo setting will appear on the display.

3. Press the **TRACK 1** button.

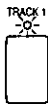

- The **TRACK 2** indicator goes out and the **TRACK 1** indicator flashes slowly.

4. Play the **TRACK 1** part.

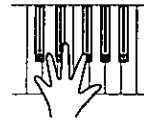

- Recording starts when you begin to play the keyboard.
- Recording will also begin if the **START/STOP** button is pressed. In this case recording begins after a one-measure count.

5. When you have completed recording the **TRACK 1** part, press the **RECORD** button to turn it off.



- Recording will also stop if the **START/STOP** button is pressed.
- The indicator for the recorded track changes from flashing to the lit condition.

■ Record TRACK 2.

1. Select the sound and set the **DIGITAL EFFECT** to on or off.

2. Confirm that the **TRACK 1** indicator is lit.

- If it is not lit, press the **TRACK 1** button to turn it on.

3. Press the **RECORD** button to turn it on.

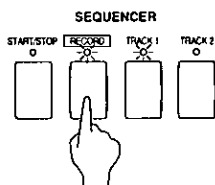

- The **TRACK 2** indicator flashes rapidly.

4. Press the **TRACK 2** button.



- The **TRACK 2** indicator flashes slowly.

5. Play the **TRACK 2** part.

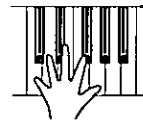

- Because the part already recorded in **TRACK 1** is played back automatically, you can play the **TRACK 2** part in time with it.
- Recording will also begin if the **START/STOP** button is pressed. In this case recording begins after a one-measure count.

6. When you have completed recording the **TRACK 2** part, press the **RECORD** button to turn it off.



■ More about SEQUENCER recording

- Expressed in terms of notes, the total number of notes which can be recorded in both **SEQUENCER** tracks is about 4500. (The number of notes may be reduced if operations such as depressing the pedal are carried out.)
- When the remaining **SEQUENCER** storage capacity becomes 20% or less, it is indicated on the display as %.
- When an error tone sounds and "FuL" appears on the display, the memory is full and the recording mode stops automatically.
- If you perform the procedure to record on a track that is already recorded, the previous contents of the track will be erased.
- You cannot record both tracks at the same time.
- The **VOLUME** and **BEAT** settings of the count are those which are set for the **METRONOME**. (Refer to page 13.)
- You can use the **METRONOME** while recording.
- For difficult tunes, for example, you can record at a slow speed and play back at a higher speed without changing the pitch.

Playback

1. Confirm that the indicators are lit for the tracks you wish to have played back.

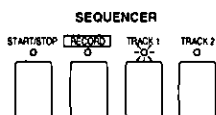

- Tracks whose indicators are not lit will not be played back.
- The tempo setting will appear on the display.

2. Press the **START/STOP** button.



- The recorded tune is played back from the beginning.
- If the **METRONOME** is on, playback begins with a one-measure count.
- You can adjust the playback speed with the **TEMPO** buttons.
- If the recording procedure was not performed correctly, "Err" will appear on the display when you attempt to play back the tune.

Erasing a track

While pressing the **MODE SET** button, press the button for the track you wish to erase until a beep tone sounds (about 2 or 3 seconds).

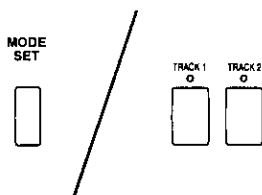

- The contents of the track are erased, and "cLr" appears on the display.
- You can erase both tracks at the same time by pressing the two track buttons simultaneously.
- You cannot erase a track by this method when the **RECORD** button is on.

The contents of the **SEQUENCER** remain in the memory for about one week after the **POWER** is turned off.

Setting the functions

You can set various functions, for example, the type of tuning, or how the sound is produced when the keys are pressed very slowly.

Settings which can be adjusted

Function	on (when indicator is lit)	off (when indicator is not lit)
PIANO TUNING	Standard acoustic piano tuning, in which the lower pitches are tuned slightly lower and the higher pitches are tuned slightly higher (default setting).	Standard equal temperament.
MINIMUM RANGE	No sound is produced when a key is played extremely softly (default setting).	Sound is produced regardless of how softly the keys are pressed.

Procedure

While pressing the **MODE SET** button, turn the desired function on or off by pressing the relevant button.

- When changing the settings, the panel buttons function as shown in the illustrations.

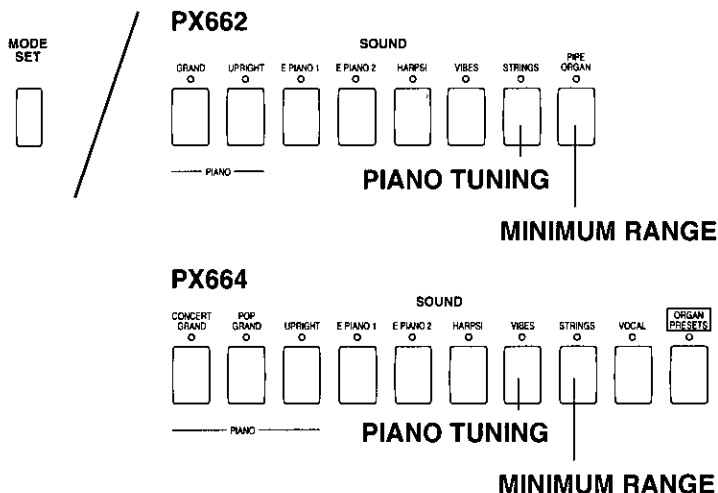

- While the **MODE SET** button is depressed, the keyboard keys do not produce sound.
- When the **MODE SET** button is pressed, the MIDI CHANNEL number (refer to page 18) is shown on the display.

Initialization

If the **INITIAL** key on the keyboard is pressed while the **MODE SET** button is depressed, all settings return to their default status.

- The **TRANSCOPE** indicators will flash at this time.
- Note that when you perform the initialization procedure, the tracks which have been memorized by the **SEQUENCER** will also be cleared.

MIDI

MIDI (Musical Instrument Digital Interface) is the international standard for digital communication of electronic musical instrument data. This means that any equipment which has a MIDI terminal—such as electronic musical instruments and personal computers—can easily exchange digital data with other MIDI equipment without resorting to complicated conversions or connections.

About the MIDI terminals

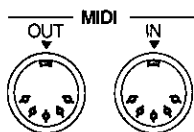

- IN:** The terminal by which this instrument receives data from other equipment.
- OUT:** The terminal that transmits data from this instrument to other equipment.

- For these connections, use a commercially available MIDI cable. Contact your Technics dealer for more information.

The following kinds of data can be transmitted/received.

- ❑ Key note on/off data (keyboard performance data)
- ❑ Pedal on/off data
- ❑ **DIGITAL EFFECT** on/off data
- ❑ **PROGRAM CHANGE** (sound selection change) data*, etc.

* Refer to page 21 regarding data transmission.

- **SEQUENCER** and **DEMO** performance data cannot be transmitted.

Assigning the MIDI CHANNEL (MIDI CH)

You can assign a MIDI CHANNEL number (1–16) to this instrument.

- Data can be exchanged only when the channel on the transmitting side matches the channel on the receiving side.
- The default channel setting is 1.

While pressing the **MODE SET** button, use the 16 lower-most keys (see illustration) to assign the desired MIDI CHANNEL number.

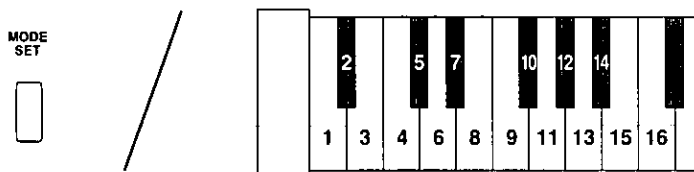

- The selected MIDI CHANNEL number is shown on the display.

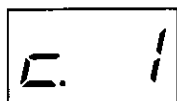

The following MIDI functions can be set.

The **DIGITAL EFFECT** button and some of the **SOUND** buttons, when used in conjunction with the **MODE SET** button, serve to set the following MIDI functions.

Function	on (when indicator is lit)	off (when indicator is not lit)																																			
MULTI TIMBRE	The piano can be used as a multiple sound generator, and data can be received on each MIDI channel.	<ul style="list-style-type: none"> This piano cannot be used as a multiple sound generator. Data can be received only on the set MIDI basic channel. In this case, the produced sound corresponds to the selected sound as indicated on the panel (default status). 																																			
	<ul style="list-style-type: none"> In the initialized state, the MIDI channel and sound assignment that can be used on this instrument is as shown below (PX664: the ORGAN PRESETS becomes the sound that is selected at that time). 																																				
	<div style="text-align: center;"> <p>PX662</p> <p style="margin-left: 100px;">SOUND</p> <table style="margin-left: 100px; border-collapse: collapse;"> <tr> <td style="text-align: center; padding: 2px;">GRAND ○</td> <td style="text-align: center; padding: 2px;">UPRIGHT ○</td> <td style="text-align: center; padding: 2px;">E. PIANO 1 ○</td> <td style="text-align: center; padding: 2px;">E. PIANO 2 ○</td> <td style="text-align: center; padding: 2px;">HARPSI ○</td> <td style="text-align: center; padding: 2px;">VIBES ○</td> <td style="text-align: center; padding: 2px;">STRINGS ○</td> <td style="text-align: center; padding: 2px;">PIPE ORGAN ○</td> </tr> <tr> <td style="text-align: center; border: 1px solid black; width: 30px; height: 30px;">1</td> <td style="text-align: center; border: 1px solid black; width: 30px; height: 30px;">2</td> <td style="text-align: center; border: 1px solid black; width: 30px; height: 30px;">3</td> <td style="text-align: center; border: 1px solid black; width: 30px; height: 30px;">4</td> <td style="text-align: center; border: 1px solid black; width: 30px; height: 30px;">5</td> <td style="text-align: center; border: 1px solid black; width: 30px; height: 30px;">6</td> <td style="text-align: center; border: 1px solid black; width: 30px; height: 30px;">7</td> <td style="text-align: center; border: 1px solid black; width: 30px; height: 30px;">8</td> </tr> </table> <p style="margin-left: 100px;">PIANO</p> <hr style="border-top: 1px dashed black;"/> <p>PX664</p> <p style="margin-left: 100px;">SOUND</p> <table style="margin-left: 100px; border-collapse: collapse;"> <tr> <td style="text-align: center; padding: 2px;">CONCERT GRAND ○</td> <td style="text-align: center; padding: 2px;">POP GRAND ○</td> <td style="text-align: center; padding: 2px;">UPRIGHT ○</td> <td style="text-align: center; padding: 2px;">E. PIANO 1 ○</td> <td style="text-align: center; padding: 2px;">E. PIANO 2 ○</td> <td style="text-align: center; padding: 2px;">HARPSI ○</td> <td style="text-align: center; padding: 2px;">VIBES ○</td> <td style="text-align: center; padding: 2px;">STRINGS ○</td> <td style="text-align: center; padding: 2px;">VOCAL ○</td> <td style="text-align: center; padding: 2px;">ORGAN PRESETS ○</td> </tr> <tr> <td style="text-align: center; border: 1px solid black; width: 30px; height: 30px;">1</td> <td style="text-align: center; border: 1px solid black; width: 30px; height: 30px;">2</td> <td style="text-align: center; border: 1px solid black; width: 30px; height: 30px;">3</td> <td style="text-align: center; border: 1px solid black; width: 30px; height: 30px;">4</td> <td style="text-align: center; border: 1px solid black; width: 30px; height: 30px;">5</td> <td style="text-align: center; border: 1px solid black; width: 30px; height: 30px;">6</td> <td style="text-align: center; border: 1px solid black; width: 30px; height: 30px;">7</td> <td style="text-align: center; border: 1px solid black; width: 30px; height: 30px;">8</td> <td style="text-align: center; border: 1px solid black; width: 30px; height: 30px;">9</td> <td style="text-align: center; border: 1px solid black; width: 30px; height: 30px;">10</td> </tr> </table> <p style="margin-left: 100px;">PIANO</p> </div>		GRAND ○	UPRIGHT ○	E. PIANO 1 ○	E. PIANO 2 ○	HARPSI ○	VIBES ○	STRINGS ○	PIPE ORGAN ○	1	2	3	4	5	6	7	8	CONCERT GRAND ○	POP GRAND ○	UPRIGHT ○	E. PIANO 1 ○	E. PIANO 2 ○	HARPSI ○	VIBES ○	STRINGS ○	VOCAL ○	ORGAN PRESETS ○	1	2	3	4	5	6	7	8	9
GRAND ○	UPRIGHT ○	E. PIANO 1 ○	E. PIANO 2 ○	HARPSI ○	VIBES ○	STRINGS ○	PIPE ORGAN ○																														
1	2	3	4	5	6	7	8																														
CONCERT GRAND ○	POP GRAND ○	UPRIGHT ○	E. PIANO 1 ○	E. PIANO 2 ○	HARPSI ○	VIBES ○	STRINGS ○	VOCAL ○	ORGAN PRESETS ○																												
1	2	3	4	5	6	7	8	9	10																												
<ul style="list-style-type: none"> When the power is turned on or when this instrument is initialized, the sounds for each channel that were changed by receiving PROGRAM CHANGE numbers return to the sounds indicated on the panel. 																																					
OMNI ON	Data is received for all MIDI channels.	Data is received only on MIDI channels which are matched (default status). <ul style="list-style-type: none"> For assigning this instrument's MIDI channels, refer to page 18. 																																			
PROGRAM CHANGE	PROGRAM CHANGE data is transmitted/received (default status). <ul style="list-style-type: none"> You can also transmit data for any PROGRAM CHANGE number. (Refer to page 21.) Please refer to page 21 for information about the program change number of each sound button. 	PROGRAM CHANGE data is not transmitted/received.																																			
PEDAL	Pedal operation data is transmitted/received (default status).	Pedal operation data is not transmitted/received.																																			
EFFECT	The DIGITAL EFFECT on/off status is transmitted/received (default status).	The DIGITAL EFFECT on/off status is not transmitted/received.																																			
TRANSCOPE	When this instrument's TRANSCOPE function is active, note numbers of the transposed notes are transmitted.	When this instrument's TRANSCOPE function is active, note numbers of the played keys (non-transposed notes) are transmitted (default status).																																			
LOCAL CONTROL	The performance from this instrument also sounds from this instrument (default status). <ul style="list-style-type: none"> When the POWER is turned on, the LOCAL CONTROL is set to on. 	The performance from this instrument does not sound from this instrument. Set to off when this instrument is to be used only to transmit data to connected equipment.																																			

- MULTI TIMBRE and OMNI ON cannot both be turned on at the same time.

Procedure

While pressing the **MODE SET** button, turn the desired function on or off by pressing the relevant button

- When using the MIDI functions, the panel buttons function as shown in the illustrations

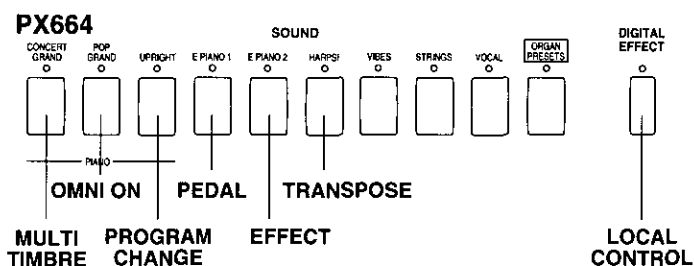
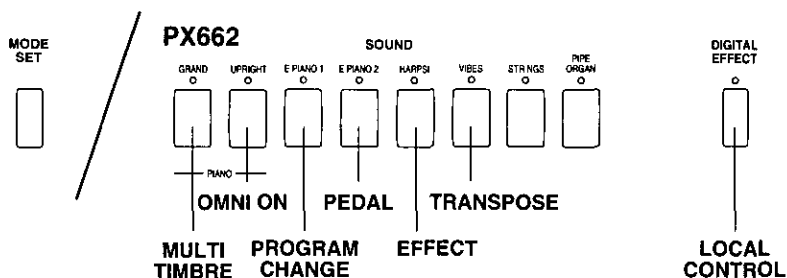

- While the **MODE SET** button is depressed, the keyboard keys do not produce sound

■ Initialization

If the **INITIAL** key on the keyboard is pressed while the **MODE SET** button is depressed, all settings return to their default status

- The **TRANSPOSE** indicator flashes
- Note that when you perform the initialization procedure, the recorded contents of the **SEQUENCER** are erased

Keyboard and MIDI note number

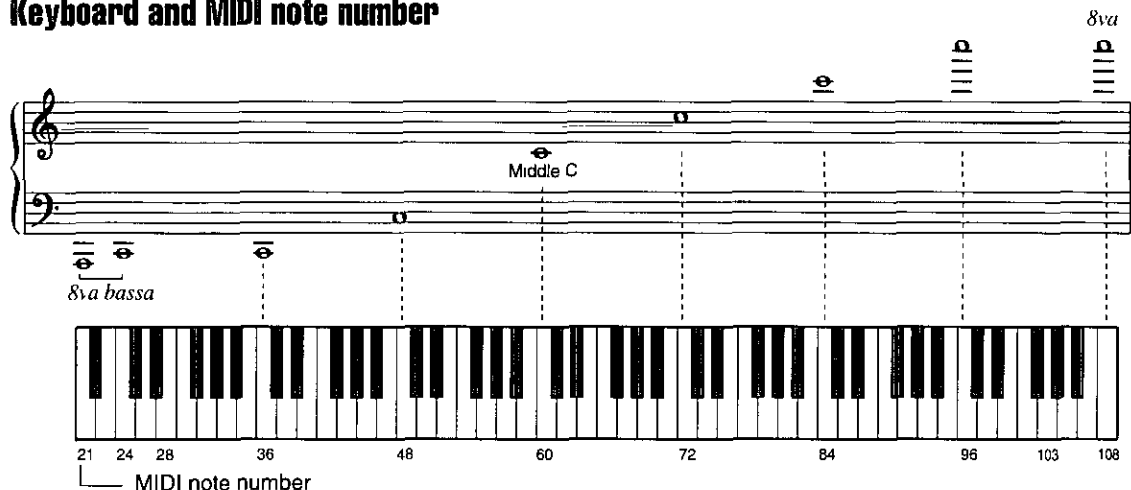

Transmitting PROGRAM CHANGE numbers

This piano can be used to transmit desired PROGRAM CHANGE numbers to the connected instrument.

While pressing the **MODE SET** button, using the numbers on the keyboard illustration below for reference, press a black key to specify the **BANK** and a white key to specify the **NUMBER**. (Refer to the PROGRAM CHANGE number table.)

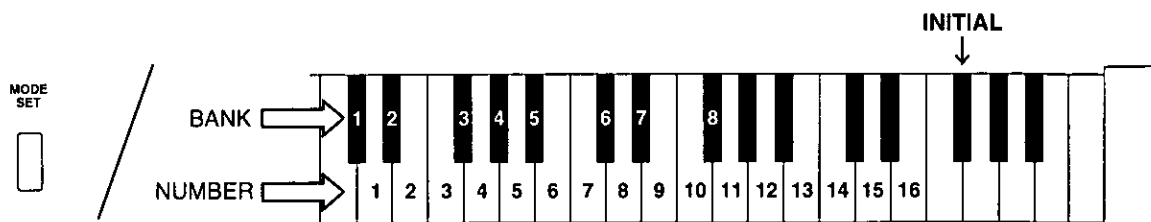

- PROGRAM CHANGE numbers are transmitted by combining a BANK and NUMBER to specify the desired PROGRAM CHANGE number 0–127.
- The selected PROGRAM CHANGE number is shown on the display.

PROGRAM CHANGE number table

BANK \ NUMBER	1	2	3	4	5	6	7	8	9	10	11	12	13	14	15	16
1	0	1	2	3	4	5	6	7	8	9	10	11	12	13	14	15
2	16	17	18	19	20	21	22	23	24	25	26	27	28	29	30	31
3	32	33	34	35	36	37	38	39	40	41	42	43	44	45	46	47
4	48	49	50	51	52	53	54	55	56	57	58	59	60	61	62	63
5	64	65	66	67	68	69	70	71	72	73	74	75	76	77	78	79
6	80	81	82	83	84	85	86	87	88	89	90	91	92	93	94	95
7	96	97	98	99	100	101	102	103	104	105	106	107	108	109	110	111
8	112	113	114	115	116	117	118	119	120	121	122	123	124	125	126	127

- You can also use the sound buttons to specify the PROGRAM CHANGE number.

PX664: The **ORGAN PRESETS** are assigned numbers 9 to 17 in the CLASSICAL, JAZZ numerical order and change depending on the sound selected at that time.

PX662

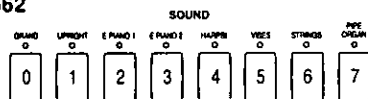

PX664

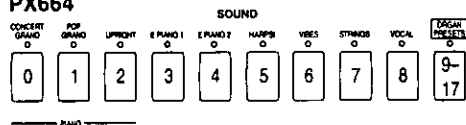

Connections

(On the back of piano)

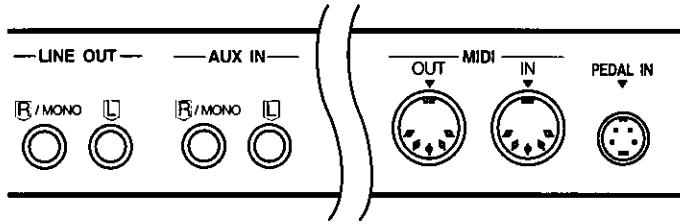

PEDAL IN

Connect the cord from the included stand to this terminal.

AUX IN (input level 0.5 Vrms, 6 kΩ)

Other instruments such as a rhythm machine or sound module can be connected to the piano so that the sound is output from the piano. To receive monaural sound, connect instruments to the **R/MONO** terminal.

LINE OUT (output level 1.5 Vrms, 600 Ω)

By plugging into a high-power amplifier, the sound can be reproduced at high volume. (Use the **R/MONO** terminal when outputting monaural sound. However, there are some cases where the sound quality may deteriorate depending on the sound.)

HEADPHONES (phones) ×2

(Beneath the keyboard, on the left side)

For silent practice headphones may be used. When plugged in, the speaker system is automatically switched off, and sound is heard only through the headphones.

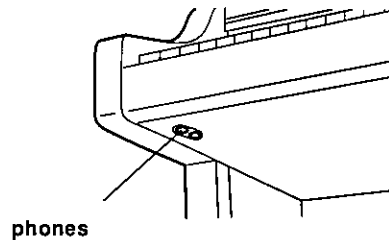

Symptoms which appear to be signs of trouble

Phenomenon	Remedy
No sound is produced when the keyboard is played.	<ul style="list-style-type: none"> No sound is produced if the MAIN VOLUME is set to MIN. Use the sliding control to set the volume to an appropriate level. If the MIDI LOCAL CONTROL is set to off, set it to on. (Refer to page 19.)
Nothing is shown on the display.	<ul style="list-style-type: none"> The metronome, SEQUENCER tempo, etc. are indicated on the display. During normal performance, however, the display is off.
Data cannot be exchanged through MIDI terminals.	<ul style="list-style-type: none"> Match the channels on the transmitting side and the receiving side. (Refer to page 18.)
The sound quavers or is distorted.	<ul style="list-style-type: none"> When both the MIDI IN and OUT terminals are connected to a computer, depending on the computer software the received data may be sent back to the instrument just as it is. Because of this the sound generated from the keys and the sound generated from the returned data are both produced, causing undesirable effects, such as the sounds canceling each other out, for example. In this case, either change the software settings to prevent received data from being returned, or set the MIDI LOCAL CONTROL to off.

Assembly

Follow the steps below to assemble your Technics piano. Make sure you are using the correct parts and that they are in the correct direction.

- At least 2 people are required for assembly.
- To disassemble the piano, reverse the procedure.

1. Remove the packing and take the parts out of the carton. Confirm that all the parts on the printed list are present.

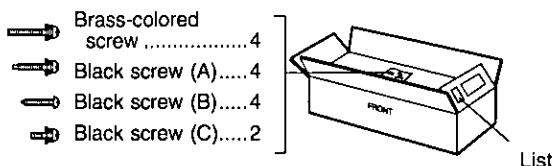

2. Affix the right and left side planks to the pedal box.

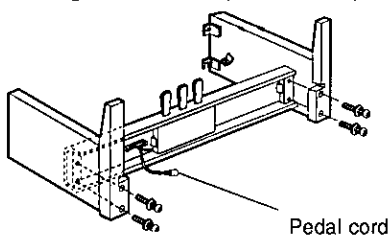

(1) Use the 4 brass-colored screws to secure the planks.

(2) Be sure to insert the screws straight.

- If a screw is inserted crookedly, it may be damaged.

(3) Insert each of the 4 screws partway, lightly securing each one little by little. After confirming that the screws are all correctly inserted, tighten each one securely.

- If each screw is tightened securely before all the screws are inserted, the last screw may be very difficult to insert.

(4) Loosen the pedal cord, stowed on the inner side of the pedal box, and extend it.

3. Affix the rear panel.

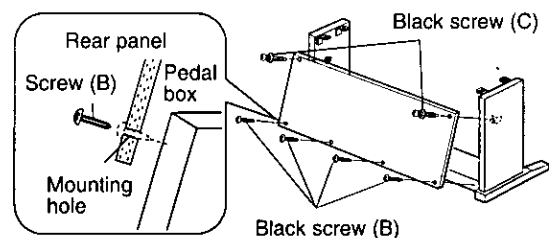

- For the brown wood grain model: affix the rear panel so that the wood grain surface is facing the front.

(1) Insert the 2 black screws (C) partway in the upper part of the rear panel, securing them only lightly. Do not tighten the screws completely at this time.

- If the screws are tightened securely at this time, it may be difficult to affix the lower part of the rear panel.

(2) Insert the 4 black screws (B) through the mounting holes in the lower part of the rear panel and tighten the screws fully.

- Run the screws directly into the pedal box as there are no rough holes in the pedal box.

(3) Tighten the 2 black screws (C) in the upper part of the rear panel completely.

4. Place the piano body on the stand.

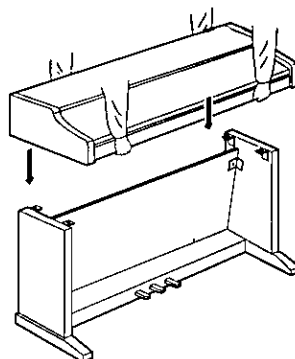

WARNING:

Avoid pinching your fingers.

Note 1

Holding the piano body at least 10 cm in from the edge, place it on the stand so that it does not fall off.

Note 2

If the piano body is placed too far to the right or left, or to the front or back, it will become unstable.

5. Secure the piano body to the stand.

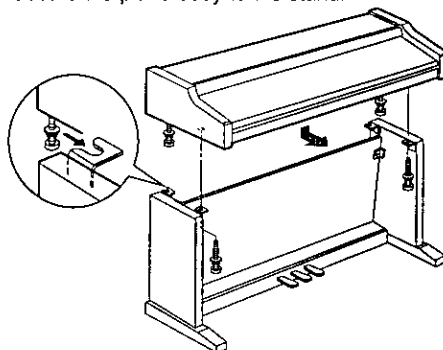

(1) Insert 2 black screws (A) in the 2 rear screw holes on the underside of the piano body, and turn each screw 5 or 6 times. Push the piano body forward so that the screws are fully inserted in the cutout of the metal piece on either side plank. (This enables you to easily position the piano body on the stand.)

- (2) Adjust the piano body so that the right and left sides project evenly over the stand.

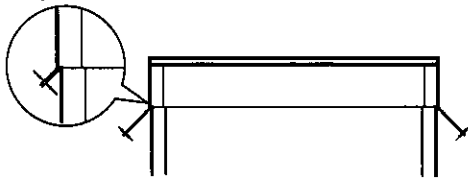

- (3) Positioning the piano body on the stand, confirm that the 4 back screws (A) can easily be inserted.

- (4) Tighten the 4 screws securely.

6. Connect the pedal cord and power cord to the terminals.

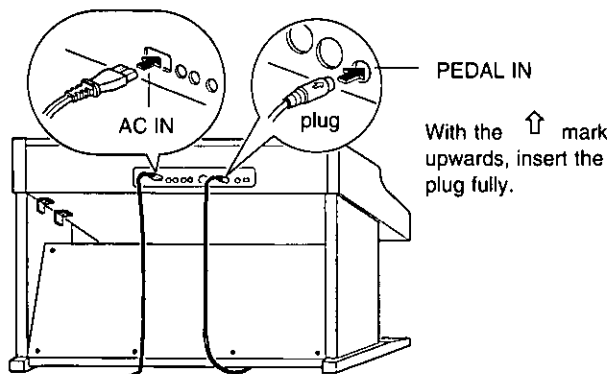

- Plug the pedal cord and power cord into the terminals on the rear of the piano.

Confirm

After assembling, check these points.

- Are any parts left over?
 - Check the assembly procedure again.
 - Does the piano rattle when it is rocked?
 - Make sure all the screws are securely tightened.
 - Is the power cord firmly inserted?
 - Check again.
 - Is the plug of the pedal cord inserted as far into the connector terminal as it will go?
 - If it is not completely inserted, the sustain and other pedal functions may not work.
- When the piano has been moved or transported, re-tighten the screws securely.

■ About the backup memory

The selected sound and various functions, MIDI settings and **SEQUENCER** contents remain in the memory for about one week after the **POWER** is turned off.

- The backup memory will not function until the **POWER** has been on for about 10 minutes.
- If you wish to return all memories and settings to their initialized status, while pressing the **MODE SET** button, press the **INITIAL** key on the keyboard. Or you can turn on the **POWER** while pressing the **INITIAL** key.
- When the **POWER** is turned on, the **MIDI LOCAL CONTROL** is set to on.
- If you wish to retain the memory for longer than one week, before one week has elapsed, turn on the power and leave it on for about 10 minutes before turning it off again. The settings will remain in the memory for about one week from this time.

MIDI Implementation Chart

Digital piano [SX-PC662] [SX-PC664]

Function		Transmitted	Recognized	Remarks
Basic Channel	Default Changed	1-16 1-16	1-16 1-16	memorized
Mode	Default Messages Altered	3 × —	1, 3 × —	memorized
Note Number	True voice	*21-108 —	0-127 *0-127	
Velocity	Note ON Note OFF	○ × (9nH: V=0)	○ ×	
After Touch	Key's Ch's	× ×	× ×	
Pitch Bend		×	○	
Control Change	01 06,38 07 10 11 64 66 67 91 93 98, 99 100,101	× × × × × ○× ○× ○× × ○× × ○× × ×	**○ **○ **○ **○ **○ ○× ○× ○× **○ ○× **○ **○ **○	modulation data entry volume (part) pan part expression sustain pedal sostenuto pedal soft pedal reverb depth digital effect NRPN LSB, MSB RPN LSB, MSB
Prog Change	True #	○× 0-127	○× 0- 7 (PX662) 0-17 (PX664)	
System Exclusive		×	×	
System Common	Song Pos Song Sel Tune	× × ×	× × ×	
System Real Time	Clock Commands	× ×	× ×	
Aux Messages	Local ON/OFF All Notes OFF Active Sense Reset	× × ○ ×	○ ○ ○ ×	
Notes	○× Whether or not the data for each of these items is transmitted or received can be set. * Changes depending on the TRANPOSE setting. ** Effective only in the MULTI TIMBRE mode.			

Mode 1: OMNI ON, POLY
Mode 3: OMNI OFF, POLY

Mode 2: OMNI ON, MONO
Mode 4: OMNI OFF, MONO

○ : Yes
× : No

Specifications

	SX-PX662	SX-PX664
KEYBOARD	88 KEYS	
MAX. POLYPHONY	64 NOTES	
SOUND	8 SOUNDS: GRAND, UPRIGHT, E PIANO 1, E PIANO 2, HARPSI, VIBES, STRINGS, PIPE ORGAN	18 SOUNDS: CONCERT GRAND, POP GRAND, UPRIGHT, E PIANO 1, E PIANO 2, HARPSI, VIBES, STRINGS, VOCAL, ORGAN PRESETS (9 SOUNDS)
PEDAL	SOFT, SOSTENUTO, SUSTAIN	
BRILLIANCE	MELLOW, BRIGHT (5 STEPS)	
DIGITAL EFFECT	○	
DIGITAL REVERB	○ (ROOM, STAGE, HALL, CONCERT)	
TOUCH SENSITIVITY	LIGHT, NORMAL, HEAVY	
TRANPOSE	G-C-F#	
TUNING	427.3 Hz-440.0 Hz-453.0 Hz	
METRONOME	○ (TIME SIGNATURE: OFF, 2/4, 3/4, 4/4, 5/4, 6/8)	
SEQUENCER	TRACK (1, 2), STORAGE CAPACITY: APPROX. 4500 NOTES, RECORDING MODE: REAL TIME	
DISPLAY	○	
DEMO	○	
MIDI	MULTI TIMBRE, LOCAL CONTROL, OMNI ON, PROGRAM CHANGE, PEDAL, EFFECT, TRANPOSE	
MODE SET	PIANO TUNING, MINIMUM RANGE	
OTHERS	POWER SWITCH, MAIN VOLUME, MIDI TERMINALS (IN, OUT), PEDAL IN, AUX IN (R/MONO, L), LINE OUT (R/MONO, L), HEADPHONES×2, AC IN, INITIAL KEY	
OUTPUT	80 W (40 W × 2)	100 W (50 W × 2)
SPEAKERS	14 cm × 2	14 cm × 2, 6.5 cm × 2
POWER REQUIREMENT	100 W 110 W (NORTH AMERICA AND MEXICO)	110 W 135 W (NORTH AMERICA AND MEXICO)
	AC 120/220/230-240 V 50/60 Hz AC 120 V 60 Hz (NORTH AMERICA AND MEXICO) AC 230-240 V 50/60 Hz (EUROPE, AUSTRALIA AND NEW ZEALAND)	
DIMENSIONS (W×H×D)	140.4 cm × 102.5 cm × 48.1 cm (55-9/32" × 40-11/32" × 18-15/16")	142 cm × 106.3 cm × 51.4 cm (55-29/32" × 41-29/32" × 20-1/4")
NET WEIGHT	46 kg (101.4 lbs.)	53 kg (116.8 lbs.)
ACCESSORIES	AC CORD, MUSIC STAND	

- In some markets, one of the models may not be available.
- Design and specifications are subject to change without notice.

Demo Performance List

■ PX662

SOUND

GRAND O	UPRIGHT D	E.PIANO 1 O	E.PIANO 2 O	HARPSI O	VIBES O	STRINGS O	PIPE ORGAN O
	1	2	3	5	7	8	9

PIANO

■ PX664

SOUND

CONCERT GRAND O	POP GRAND O	UPRIGHT O	E.PIANO 1 O	E.PIANO 2 O	HARPSI O	VIBES O	STRINGS O	VOCAL O	ORGAN PRESETS O
	1	2	3	4	5	6	7 A	9 B	10

PIANO

SOUND NAME		SONG TITLE	COMPOSER
GRAND (PX662)/ CONCERT GRAND (PX664)	1	Polonaise Heroique	Chopin
	2	Clair de Lune (Suite bergamasque)	Debussy
	3	from Sonata A major (K.331)	Mozart
	4	Military March	Schubert
	5	Technics Original	
	6	Maple Leaf Rag	Joplin
	7	Danny Boy	Traditional
	8	Beautiful Dreamer	Foster
	9	Swanee River	Traditional
	10	Loch Lomond	Traditional
POP GRAND (PX664)		Beautiful Dreamer	Foster
UPRIGHT		My Lady's-Ride (25 Easy Studies Op.100)	Burgmuller
E. PIANO 1		Amazing Grace	Traditional
E. PIANO 2		Tehncis Original	
HARPSI		Prelude in C#major No.3 from Book 1 of 48 Preludes & Fugues (BWV.848)	Bach
VIBES		La Paloma	Traditional
STRINGS		Technics Original	
VOCAL (PX664)		Ave Maria	Burgmuller
PIPE ORGAN (PX662)		Courante from Suite No.5 in G major (BWV.816)	Bach
ORGAN PRESETS (PX664)	A	Courante from Suite No.5 in G major (BWV.816)	Bach
	B	The House of the Rising Sun	Traditional

PANASONIC CONSUMER ELECTRONICS COMPANY
DIVISION OF MATSUSHITA ELECTRIC CORPORATION OF AMERICA
One Panasonic Way, Secaucus, New Jersey 07094

Printed in Japan

Consumerproducts@Panasonic.com

ENGLISH

M

S0020180 QQTG0635A