

TASCAM

TEAC Production Products

M-512/M-520

Mixing Consoles



M-512

OPERATION/MAINTENANCE

5700055500



M-520



<p>CAUTION RISK OF ELECTRIC SHOCK DO NOT OPEN</p>	<p>CAUTION: TO REDUCE THE RISK OF ELECTRIC SHOCK, DO NOT REMOVE COVER (OR BACK). NO USER-SERVICEABLE PARTS INSIDE. REFER SERVICING TO QUALIFIED SERVICE PERSONNEL.</p>
	<p>The lightning flash with arrowhead symbol within an equilateral triangle, is intended to alert the user to the presence of uninsulated "dangerous voltage" within the product's enclosure, that may be of sufficient magnitude to constitute a risk of electric shock to persons.</p>
	<p>The exclamation point within an equilateral triangle is intended to alert the user of the presence of important operating and maintenance (servicing) instructions in the literature accompanying the appliance.</p>

TABLE OF CONTENTS

The guarantee of performance that we provide for the M-512 and M-520 must have several restrictions. We say that the console will perform properly only if it is adjusted properly and the guarantee is that such adjustment will be possible. However, we cannot guarantee your skill in adjustment or your technical comprehension of this manual. Therefore, setup is not covered by the Warranty. If your attempts at internal adjustment are unsuccessful, we must make a service charge to correct your mistakes.

Recording is an art as well as a science. A successful recording is often judged primarily on the quality of sound as art, and we obviously cannot guarantee that. A company that makes paint and brushes for artists cannot say that the paintings made with their products will be well received critically. The art is the province of the artist. TASCAM can make no guarantee that the console in itself will assure the quality of the recordings you make.

Your skill as a technician and your abilities as an artist will be significant factors in the results you achieve.

INTRODUCTION TO THE MANUAL, AND HOW TO USE IT	8	CS-512 and CS-520 Pedestal	63
THE BLOCK DIAGRAM AND GAIN BLOCK DIAGRAM	10	CS-513 and CS-521 Top Board	63
INPUT SECTION	11	Professional Low Loss Cable	63
1. Mic Input Section.....	11	MORE INFORMATION IS AVAILABLE	64
2. Multi-Purpose Tape Inputs — All But The Last 4 Channels.....	12	BIBLIOGRAPHY	64
3. 2TR A&B Tape Inputs — Last 4 Channels.....	12	M-512 SPECIFICATIONS	65
4. Secondary Inputs.....	17	M-512 BLOCK DIAGRAM	67
5. 4 Secondary Multi-Purpose Line Inputs.....	17	M-520 BLOCK DIAGRAM	69
6. Trim.....	18	M-520 SPECIFICATIONS	71
7. Input Select Switch.....	18	LEVEL DIAGRAM	73
8. Extra Access Send (Pre Out) RCA Jack.....	18	VOLTAGE CONVERSION	79
9. OL (Overload) LED.....	18	NOTE FOR U.K. CUSTOMERS	80
10. Access Send-Rev Jack.....	19	MAINTENANCE	81
11. Three Section Semi-Parametric Type (Sweep) Equalizer.....	19	1. LEVEL SETTING	
12. Equalizer On Switch, LED Indicator.....	20	1-1. MIC IN → ACCESS SEND.....	82
13. PFL (Pre-Fader Listen) Switch, LED Indicator.....	20	1-2. INST IN → ACCESS SEND for Channels 1 and 2.....	82
14. Input Fader.....	20	1-3. PHONO IN → ACCESS SEND for Channels 3 and 4.....	83
15. Input Channel Buffer Amp.....	20	1-4. LINE IN → ACCESS SEND for Channels 5 through 12 (M-512) or 20 (M-520).....	83
16. Direct Out RCA Jack.....	20	1-5. TAPE IN [2TR A&B (L/R)] → ACCESS SEND.....	84
17. Channel On Switch, LED Indicator.....	22	1-6. Input Section Overload LED.....	84
18. Pan Pot (Buss Select).....	22	1-7. TAPE IN [2TR A&B (L/R)] → Direct Out.....	85
19. Solo Button, LED Indicator.....	22	1-8. PGM SUB IN → PGM OUT (Buss Out).....	85
20. Buss Assign Switches.....	23	1-9. Meter Calibration and The LED Circuit.....	86
AUX SECTION	24	1-10. SPARE SUB IN → ST MSTR A/B.....	87
21. AUX 1, 2 & 3, 4 Signal Select Switch.....	24	1-11. 2TR A/B → ST MSTR A/B.....	88
22. AUX 1, 2 or 3, 4 Mute Switch, LED Indicator.....	27	1-12. MON SUB IN → ST MSTR A/B.....	89
23. AUX 1, 2 & AUX 3, 4 Gain (Dual Concentric Control).....	27	1-13. PGM SUB IN → ST MSTR A/B.....	91
24. AUX Sub In 1 through 4 RCA Jacks.....	27	1-14. BALANCE AMP INPUT → BALANCE AMP OUTPUT.....	91
25. AUX 1 through 4 Master Faders.....	27	1-15. AUX SUB IN → AUX OUT.....	93
26. AUX Out 1 through 4 RCA Jacks.....	27	1-16. AUX SUB IN → ST MSTR A/B.....	93
BUSS MASTER SECTION	28	1-17. TAPE IN [2TR A&B (L/R)] → PGM OUT.....	95
27. Program Sub Ins, 1 through 8.....	28	1-18. SOLO Circuit and HEADPHONES Circuit.....	97
28. Master Buss 1 through 8 Combining Network and Summing Amplifier.....	28	1-19. PFL Circuit.....	97
29. PGM Access Send/Rcv RCA Jacks.....	28	1-20. TAPE IN [2TR A&B (L/R)] → AUX OUT.....	99
30. Buss Master Fader.....	28	1-21. TALKBACK Circuit.....	100
31. PGM Out RCA Jacks, 1 through 8.....	28	2. EXPLODED VIEW AND PARTS LIST	102
MONITOR SECTION	29	2-1. Exploded View-1 (Main Frame) [M-512].....	102
32. VU Meters (1 through 8 on M-512, 1 through 12 on M-520).....	29		
33. Peak LEDs.....	29		
34. M-512, Last 4 VU Meters & Function Switches — AUX (1/2 or 3/4)/ BUSS/ST MSTR (A or B).....	29		
35. M-520, Last 4 VU Meters & Function Switches — AUX (1, 2 or 3, 4)/ ST MSTR (A or B).....	30		
36. MON BUSS/II (OFF)/TAPE Signal Select Switches.....	30		
37. MON Level Control (x 8 in M-512, x 16 in M-520).....	30		
38. MON Pan Control (x 8 in M-512, x 16 in M-520).....	30		
39. MON Sub In L/R RCA Jacks.....	30		
40. Monitor Select Switch Rack.....	31		
41. Monitor Buffer Amp.....	32		
42. Headphones Volume Control.....	32		
43. Headphones Tip-Ring-Sleeve Stereo Output Jack.....	32		
44. Stereo Master Faders, A&B.....	33		
45. Monitor Buffer Amp.....	33		
46. ST MSTR A Out L/R RCA Jacks.....	33		
47. ST MSTR B Out L/R RCA Jacks.....	33		
48. +4/+8 Balance Amp Output Connectors 1 through 8.....	33		
TALKBACK SECTION	34		
49. Talkback Mic.....	34		
50. Slate Volume Control.....	34		
51. Slate/II (OFF)/Test Tone Switch.....	34		
52. Talkback Volume Control.....	34		
53. Test Tone Signal Switch.....	34		
54. Slate/Test Tone Select Switch Rack.....	34		
55. OSC Out RCA Jacks.....	34		
PATCH INTRO	35		
RECOMMENDED 8 TRACK BASIC PATCH	36		
EXPANDING SECONDARY FUNCTIONS WITH THE MODEL 1.....	37		
MINIMUM LOSS PATCH FOR MAXIMUM QUALITY IN MIXDOWN	39		
WORKING METHODS FOR THE M-512 OR M-520	40		
Simple Record Check.....	43		
Cue system.....	43		
Calibration.....	44		
Remix.....	47		
Effects Return Method.....	47		
A Caution.....	48		
A Word or Two of Reality.....	48		
Using Two Channels For More EQ.....	48		
Pre & Post EQ When Using A Limiter.....	49		
THE DB, WHO, WHAT, WHY	50		
SIMPLIFY THE DB AND ITS MANY VARIATIONS	54		
IMPEDANCE MATCHING AND LINE LEVELS.....	57		
Finding Impedance Values on Other Brands of Equipment.....	59		
REFERENCE LEVELS	59		
OTHER USEFUL ACCESSORIES	61		
The PB-64 Patch Bay.....	61		
The PB-32 Series Patch Bays.....	61		

**WARNING: TO PREVENT FIRE OR SHOCK
HAZARD, DO NOT EXPOSE THIS APPLIANCE
TO RAIN OR MOISTURE.**

This apparatus has a serial number located on the rear panel. Please record the model number and serial number and retain them for your records.
Model number _____
Serial number _____

INTRODUCTION TO THE MANUAL, AND HOW TO USE IT

The M-512 and M-520 Mixing Consoles

have been designed to satisfy the requirements of the modern multichannel recording process. The two consoles are similar in design and operation; their input channels and output sections are virtually identical, as are the connectors and levels. Both consoles have 8 primary mixing busses. The major difference is that the M-512 has 12 input channels and an 8 track monitor section, whereas the M-520 has 20 input channels and a 16 track monitor section. Either console may be used to record 4, 8 or 16 track tapes; the M-520, however, is required for convenient mixdown of 16 track tapes. In addition to the 8 or 16 track switchable (BUSS/TAPE) monitor sections, these consoles have four built-in auxiliary systems. These *Submix* sections, AUX 1, 2 and 3, 4, can be assigned and rerouted to do more than one task. They can be used to create 4 monaural mixes, two stereo mixes, or one stereo and two mono mixes for cueing, effects, remote broadcast feeds, and so forth. Complete and convenient multitrack operation usually can be accomplished directly from the top panel, without re-patching.

However, the process of multitrack recording is constantly changing, growing more complex as an art with each advance of technology. No matter how many inputs, outputs and special functions that we provide, no console can ever be built so large that it will be capable of coping with all of the switching and routing problems with a "one button" top panel solution. Someone will always be able to come up with that unique situation requiring *just one more submix*.

The design of the console recognizes the fact that your signal processing needs may require a unique arrangement of subsystems. In order to cope with these changing needs, patch points are provided throughout all signal pathways of the console. As our mixing console becomes more flexible, the amount of time needed to understand the available functions increases. The main signal path from "mic in" to "line out" is still fairly straightforward as the requirements have not changed much since the days of "mono," but the routing for effects sends, cue feeds, and stereo monitoring can be hard to visualize. It's often possible to overlook the significance of unfamiliar connections that are immediately ob-

vious to the experienced recording engineer.

If you expect to find that "extra mix" quickly, you must be prepared to study the layout of the console thoroughly. In most instances, the physical arrangement of the controls on the top panel has very little to do with the sequence of electronic parts inside. The actual "wiring order" will determine what goes where and how, so this is the information you need in order to use the console successfully. As an example, if the controls on an *Input Channel* were actually placed in the sequence of the signal flow, the top panel would look like this. We'll include the patch points from the back panel in their wiring order as well as the faders and switches. Here's the comparison:

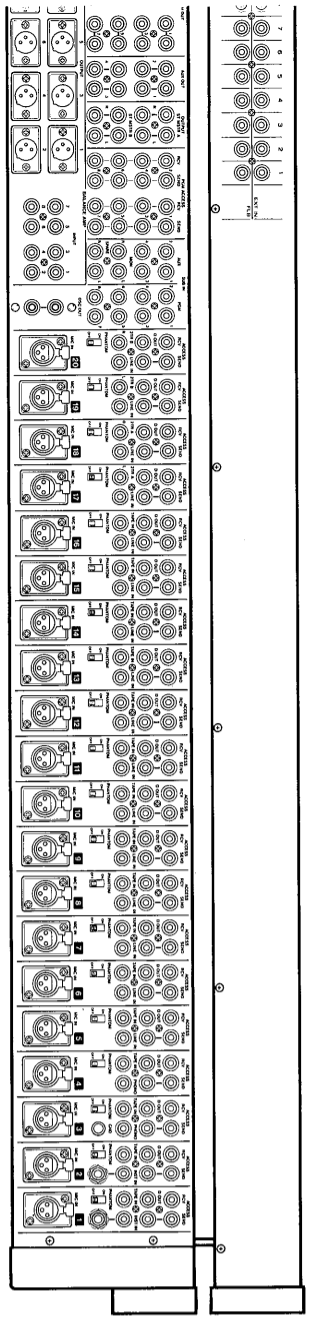
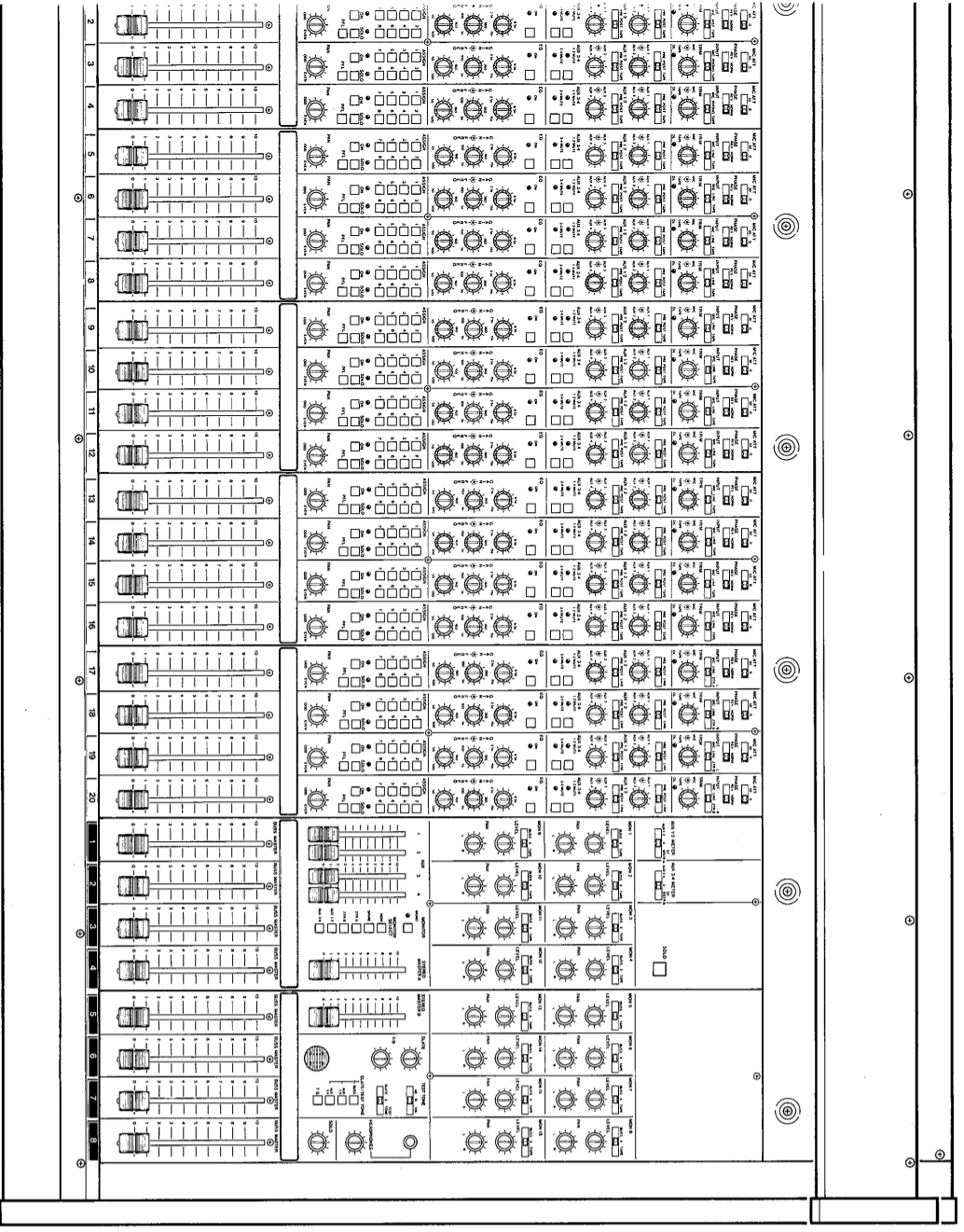
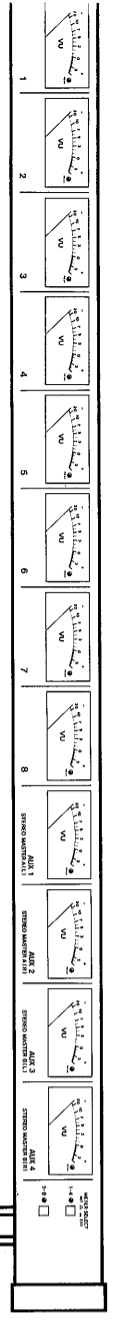
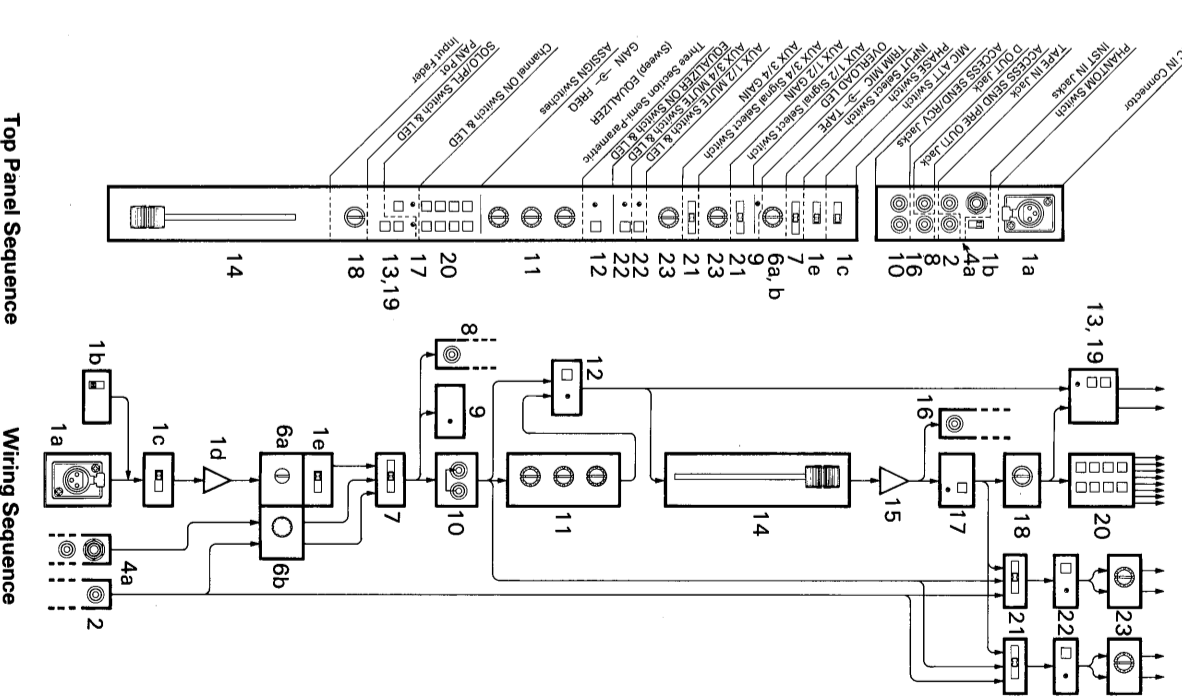

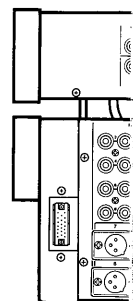
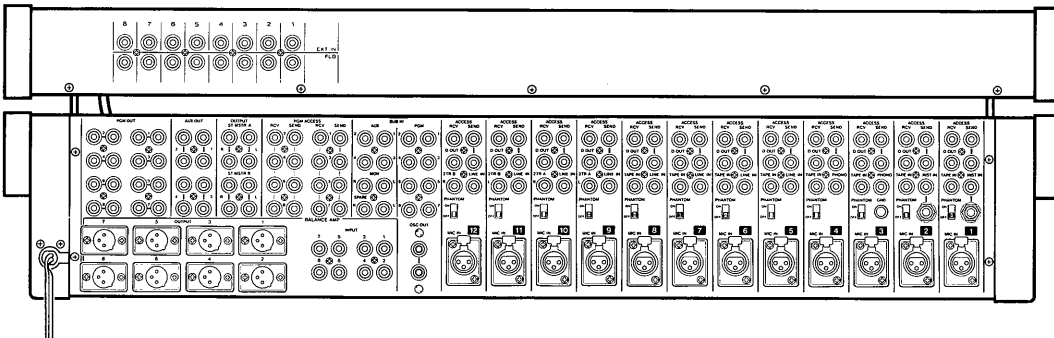
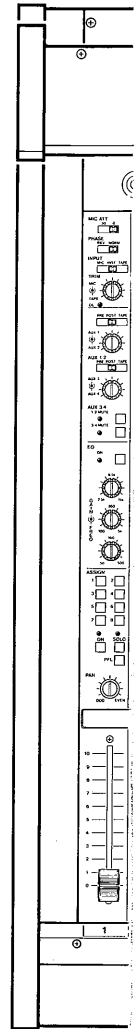
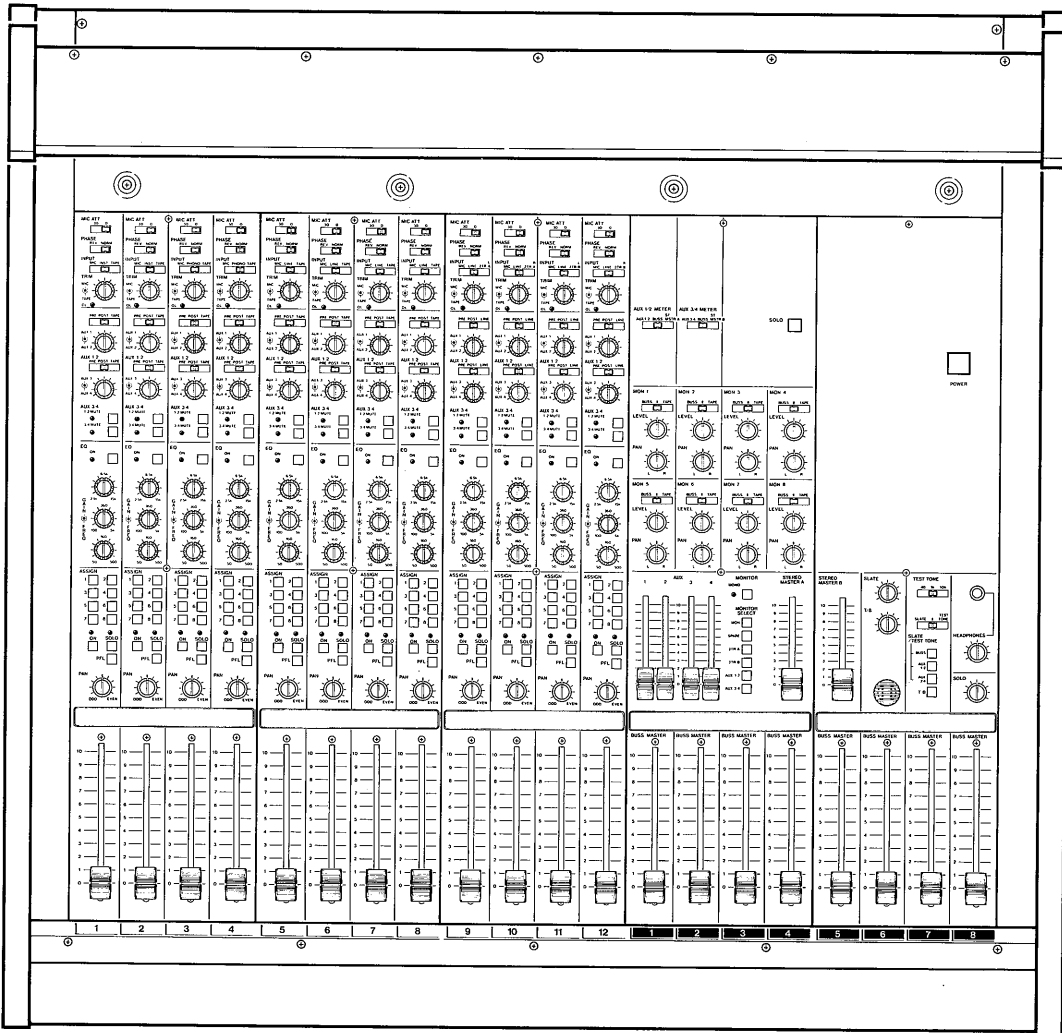
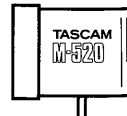
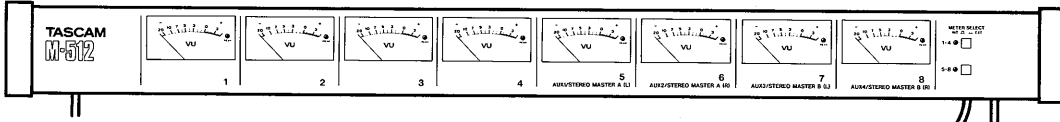

-2.	Exploded View-2 (Input Ampl.) [M-512].....	104
-3.	Exploded View-3 (Monitor Ampl.) [M-512].....	106
-4.	Exploded View-4 (Buss Ampl.) [M-512].....	108
-5.	Exploded View-5 (Meter Section) [M-512].....	110
-6.	Exploded View-6 (Mother PCBs) [M-512].....	112
-7.	Exploded View-7 (Rear Panel) [M-512].....	115
-8.	Exploded View-8 (Main Frame) [M-520].....	118
-9.	Exploded View-9 (Input Ampl.) [M-520].....	120
-10.	Exploded View-10 (Monitor Ampl.) [M-520].....	122
-11.	Exploded View-11 (Buss Ampl.) [M-520].....	124
-12.	Exploded View-12 (Meter Section) [M-520].....	126
-13.	Exploded View-13 (Mother PCBs) [M-520].....	127
-14.	Exploded View-14 (Rear Panel) [M-520].....	129
-15.	Exploded View-15 (Power Supply) [M-520].....	132

ELECTRONICS – PCB's AND

	ELECTRONIC COMPONENTS.....	134
-1.	IN/OUTPUT A PCB (1, 2) Ass'y.....	134
-2.	IN/OUTPUT B PCB (A,B, C,D) Ass'y.....	134
-3.	IN/OUTPUT C PCB (3) Ass'y.....	134
-4.	JACK PCB Ass'y.....	134
-5.	BUSS AMPL. PCB Ass'y.....	135
-6.	INPUT AMPL. PCB (A ~ G) Ass'y.....	138
	3-6-1. SW B PCB.....	138
	3-6-2. SW A PCB.....	138
-7.	MOTHER B PCB Ass'y [M-512].....	138
-8.	MONITOR AMPL. B PCB Ass'y.....	144
-9.	MONITOR A PCB (1, 2) Ass'y[M-520].....	147
-10.	LED B PCB Ass'y.....	147
-11.	LED PCB Ass'y [M-520].....	148
-12.	POWER SW PCB Ass'y [M-520].....	148
-13.	DIODE PCB Ass'y [M-520].....	148
-14.	POWER SW PCB Ass'y [M-512].....	148
-15.	MONITOR AMPL.A PCB Ass'y[M-512].....	149
-16.	TALKBACK PCB Ass'y.....	149
-17.	METER AMPL. Ass'y.....	152
-18.	MOTHER A PCB Ass'y [M-512].....	153
-19.	POWER SUPPLY PCB Ass'y [M-512]....	153

3-20.	FUSE PCB Ass'y [M-512].....	156
3-21.	SW E PCB Ass'y.....	156
3-22.	IN/OUTPUT AMPL. PCB Ass'y.....	157
3-23.	MOTHER A PCB Ass'y [M-520].....	159
3-24.	MOTHER B PCB Ass'y [M-520].....	159
3-25.	EXT LED PCB Ass'y.....	164
3-26.	EXT SW PCB Ass'y.....	164
3-27.	REGULATOR PCB Ass'y [M-512].....	164
3-28.	POWER SUPPLY PCB Ass'y [M-520]....	165

4. SCHEMATIC DIAGRAM..... 167

4-1.	In/Out Ampl. PCB/Regulator PCB.....	167
4-2.	Talkback PCB.....	169
4-3.	Mother (A) PCB [M-512].....	171
4-4.	Mother (A) PCB [M-520].....	173
4-5.	Power Supply PCB [M-512].....	175
4-6.	Power Supply Unit [M-520].....	177
4-7.	In/Out (A) PCB.....	179
4-8.	Mother (B) PCB [M-512].....	181
4-9.	Mother (B) PCB [M-520].....	183
4-10.	Meter Ampl. PCB/EXT LED PCB/ EXT SW PCB.....	185
4-11.	Monitor Ampl. (A) PCB [M-512].....	187
4-12.	Monitor (A) PCB [M-520].....	189
4-13.	Buss Ampl. PCB.....	191
4-14.	Monitor Ampl. (B) PCB.....	194
4-15.	Input Ampl. (A/B/C/D/E/F/G) PCB.....	197
4-16.	Wiring Diagram-1 [M-512].....	200
4-17.	Wiring Diagram-2 [M-512].....	203
4-18.	Wiring Diagram-1 [M-520].....	207
4-19.	Wiring Diagram-2 [M-520].....	211

BLOCK DIAGRAM [M-512]..... 214

BLOCK DIAGRAM [M-520]..... 217

To begin our manual, we'll start with some basic information about *Sound* and the numbering systems used to describe energy levels in and out of the systems. *Impedance*, what the term means and how to deal with the details when you must connect the console to other equipment. Many aspects of scientific terminology will be discussed in the most basic terms we can. Whenever possible, the scientific terms will be related to understandable common references. Understanding what is going on inside your equipment will help improve your sound. Think of this manual as a reference handbook. You won't need all of what is here to begin, and it is certainly not necessary to memorize it, but do try to find the time to read it thoroughly at least once. That way you will be familiar with its contents and if you need the numbers they will be here waiting.

Good luck with your sound.

THE BLOCK DIAGRAM AND GAIN BLOCK DIAGRAM

Before you begin reading the next section of this manual, flip out the extra fold on page 67 ~ 70. On these pages we have printed the block diagrams for both the M-512 and M-520. They show the signal flow through the consoles and represent (in simple form) the actual electronic arrangement of all the jacks, controls and gain stages from *mic-in* to *line-out*.

There is very little difference in the two block diagrams; the primary differences are in the number of input channels, the way the last 4 meters function (there are 8 in the M-512 and 12 in the M-520), and the number of controls in the monitor section (8 or 16). Because the consoles, and their block diagrams, are so similar, we will use just one model's diagram to illustrate the signal paths and control functions elsewhere in this manual.

The diagrams on page 73 ~ 78 indicate the gain of a reference signal, the noise level, and the available reserve gain or headroom at any point in the signal chain. An experienced audio engineer would be able to operate the console successfully with just these diagrams and a list of input and output specifications.

Any question about function or gain can be answered by studying the drawings. Will the accessory send signal change in level if the input fader is moved? No, the signal is shown leaving the main line before the input fader. You read these diagrams from left to right, input to output.

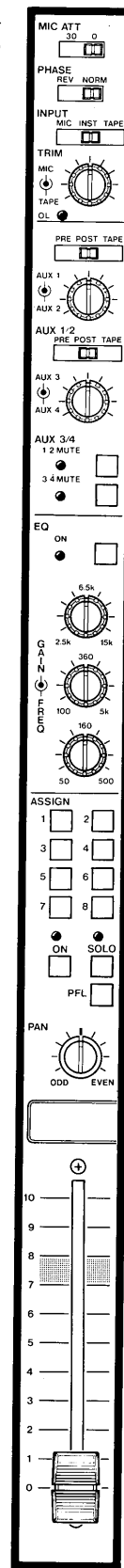

Precaution for M-520

The M-520's operating power is supplied from PS-520 Power Supply Unit of the M-520. Before you use the M-520, connect the M-520 console with the PS-520 as follows:

Connecting Cable (Supplied)

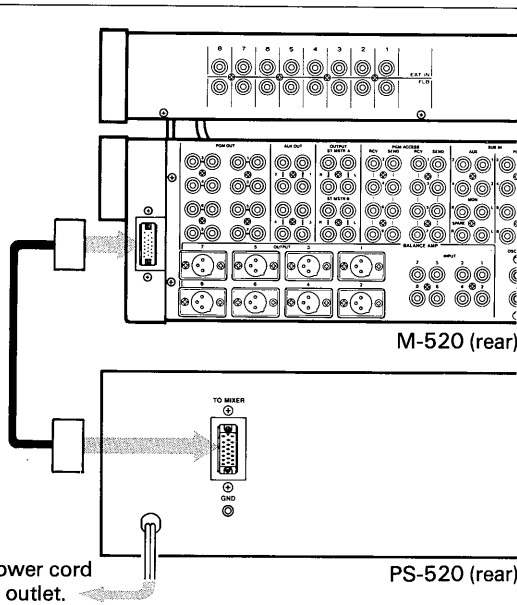

Make sure the POWER switch is OFF or disconnect power line cord of the PS-520 before making these connections.

Plug the power cord into an AC outlet.

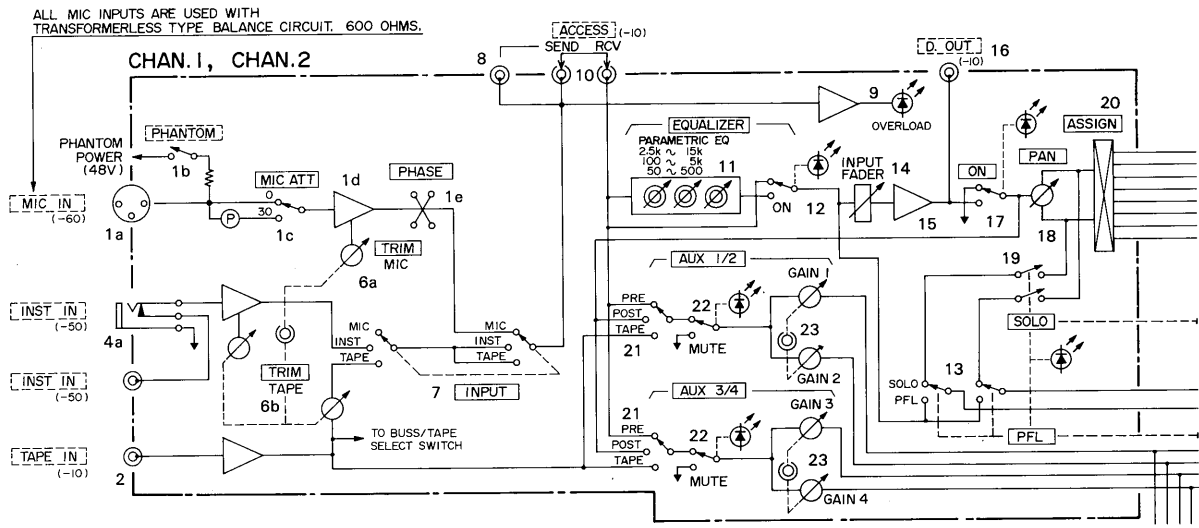

Block Diagram

While this arrangement of controls might help the first time user to understand the flow of signals in an *Input Channel*, it would be very inconvenient to operate. Still, the wiring sequence must be understood before the more complex functions of the console can be used, so along with the documentation you will need for service (schematic diagrams, mother board layouts, and mechanical disassembly information), we include a simplified electrical sequence chart called a *Block Diagram*.

This drawing shows all the controls, switches, amplifying stages, and connectors in their actual sequence. Learning to read it will provide the answers to any questions concerning "what comes where" on the inside. Things like "does the D. (Direct) OUT jack come before the EQ circuit or after it?", can be answered quickly. Yes, the Direct OUT jack is shown connected after the EQ section, so you will have EQ on any signal derived from that point.

If you have no prior experience in reading block diagrams, you can use the three illustrations we have provided here as a translator. Compare the reconstructed (as wired) *Input Channel* with legend to find out what each symbol represents. Even though the block diagram can indicate what is available in the way of extra circuit flexibility, it can't explain *why* a connection or switch has been included, or suggest a standard layout for your initial setup.

In the following sections of this manual, we do our best to describe the individual functions and controls of the console and how they can be arranged in more than one sequence. In the final analysis, your mixing needs may be best served by an arrangement of inputs and sub-systems that you work out for yourself.

Some reference to the scientific terms used by our engineers will be necessary. The console does nothing useful unless it is connected properly to quite a lot of sophisticated equipment. Mics, tape recorders, power amps, and loudspeakers all play a part in the process of mixing/recording and each piece of equipment has its own technical vocabulary. We have tried to make this reference manual as simple as technology will allow. Each section and topic will give you some basic instruction in the terminology as well as a list of "what plug" goes into "which jack".

Even though there is a substantial amount of information available to the recording engineer, much of it assumes that the reader already has an engineering or scientific background and is comfortable with "The Math."

Practical rules of thumb are not generally available, and in fact, to operate a mixer no degree in science is necessary. You don't have to build a mixer "from scratch", you just need to know how to find the right control function to get the job done.

INPUT SECTION

In multitrack recording consoles, a description of signal "sequence" or flow is made more confusing by the multiple uses of the same circuit, depending on what point in the process you are considering. Broadly speaking, multitrack recording has three stages: *Basic tracking* – recording the initial track or tracks; *Overdubbing* – adding more to the "Basic" and finally, when all recording is complete, *Remixing* to the desired final format, stereo, mono, etc. Obviously, there is no real need to duplicate functions that can use the same parts at a later stage in the process. For example, you don't need a separate EQ section for the LINE IN or TAPE IN function, a simple re-routing switch to select the input signal, MIC, LINE, or TAPE will be all that is necessary. If we were to ignore the logic of the recording process, this description of signal flow in the console would be much easier for us and we could disregard the extremely large number of different possibilities. So that you will understand why a specific jack or function was incorporated we'll tell you what we had in mind when we built the console.

To save space, we use the wiring sequence as our logical "guide" to organize this manual and we'll describe the signal flow "options" as we come to them on a "once through" basis, which means that the wiring description will be logical, but the benefit or purpose of the feature may not be in the logical sequence of multitrack work. Because these consoles will use many of the same circuits more than once in the 3 step multitrack process, we will have to talk about overdub or mixdown related features at the beginning of this section before we have completed one complete signal path through the mixer to the recorder!

This manual presumes nothing about your past experience with the multichannel process except a willingness to learn. An expert in the field might see the significance of a control or jack with just a simple statement of its location, but in this manual we will point out "the obvious".

The terms that we use in the Index may not relate the use of these consoles to the field that you already know. For example, a musician will call the beginning of the tape the "top", because it relates to the top of a piece of music paper. An Audio-Visual producer would refer to the beginning of the program as "home" as in "return home" when thinking of the rewind function. This variation in the "jargon" makes

the use of a conventional Index or Table of Contents difficult, and you have no guarantee of finding the help you need easily. Our job related sequence of instruction is self indexing to a much larger extent. It is likely that more than one person will be involved in the recording process sooner or later, but we have written this manual with the assumption that the first time user will start all alone. If you can comprehend the "solo" use of the console you should have no troubles converting the logic of the unit to accommodate extra "studio staff."

There are numerous basic signal input connectors on the M-512's 12 input channels and the M-520's 20 input channels, as shown in this chart:

CONNECTOR FUNCTION	QUANTITY	
	M-512	M-520
MIC INPUT	12	20
MULTI-PURPOSE TAPE INPUTS	8	16
2 TRACK TAPE INPUTS (A&B, L/R)	4	4
SECONDARY INPUTS (Phono, Inst) ¹	4	4
LINE INPUTS	8	16

1. Mic Input Section:

a. MIC IN Connector

A balanced three conductor transformerless microphone input circuit is provided. Any mic with an output impedance from 50 to 600 ohms will work.

b. PHANTOM Power On/Off Switch

The phantom power supply in the console conforms to the DIN standard # 45 596, 48 volts DC applied to *both* pins 2 and 3 simultaneously through a pair of current limiting resistors (6.8k ohms). Since there are many other methods that are referred to as "phantom" that require a different voltage, or a different method of applying the voltage to the pins of the MIC IN connector, we strongly recommend that you check the manuals for the mics that you plan on using. Make sure that this phantom method is correct before you plug in. For some examples that may help you "cross reference", this 48V duplex phantom power circuit is correct for:

NEUMANN 80 series, such as km84, U87, 89. SONY mics that use 48V (some use less voltage, but will work on 48V without causing problems).

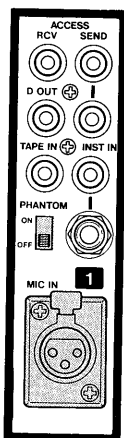

This method WILL NOT operate condenser mics with AB standard such as the Sennheiser 405, 406 or 416.

Caution: Some other phantom power microphones will ground one side of the common 48V line we provide and your 48V mics will all turn off! You *must* isolate the input that has the other standard connected!

Even though duplex 48V phantom is safe for dynamic mics in theory, in practice, your mic cables may not allow exactly 48V to get all the way up to the mic. If there is any difference in the voltage supplied to pins 2 and 3 at the mic end of the cable you will have some voltage offset in the dynamic mic that can cause damage to the sound, or damage to the mic!

TURN OFF the phantom power ON/OFF switch (on the back panel) on all the inputs that don't need it!

c. MIC ATT Switch

Two positions are provided.

- 1) Set center, there is no effect.
- 2) Set fully left, a 30dB pad is inserted (the signal is reduced by 30dB). Switch in this pad when counterclockwise rotation of the MIC TRIM (full attenuation) cannot correct an overload condition originating at the MIC IN.

d. Differential Microphone Amplifier

This transformer substitute circuit does not show on the outside, but its contribution to the system is considerable. The low power signal that the mic generates must often be protected and isolated from other low power signals in the real world. Radio, power line hum, buzz, crackles, and switching noise when motors start up. (Do you have an air conditioner on your AC line)? — all these unwanted signals must be kept out of the very high gain amplifiers that are needed to raise the mic signal to a working level. The balanced or three-wire circuit and input isolation transformer becomes one way to deal with the problem. A circuit using a single Differential amplifier can do the same thing as a transformer, cancel any signal that is the Same on both incoming lines. A difference in signal on the two inputs is amplified, a common signal (anything that is the same on both pins), is not passed, and you get only the signal provided by the mic.

e. PHASE Reverse Switch

Since the MIC IN circuit is balanced at this point, it is possible to invert the "phase" or polarity of the incoming signal. Set center, the phase is unaltered. Set left, the switch reroutes pin 2 to wire 3, and pin 3 to wire 2, and thus the polarity of the incoming signal is reversed.

When a sound source is picked up by more than one microphone, the time displacement between each microphone's "hearing" of the signal can be different enough that the microphones actually cancel or add to each other to a greater or lesser degree; i.e., the sound may appear thinner or even fatter than anticipated due to the mic placement. Should this occur, "flipping" the phase on one or more of the microphones may cure the problem and eliminate the need to re-position the mics. Also, phase reversal may help to eliminate leakage from adjacent sound sources into a given microphone. The PHASE reverse switch will affect only the MIC input circuit.

2. Multi-Purpose Tape Inputs – All But The Last 4 Channels

The TAPE INPUT provides signal to the channel's INPUT select switch and the AUX 1, 2 and AUX 3, 4 systems. The fact that the AUX 1, 2 and AUX 3, 4 systems have their own SIGNAL SELECT switch means that you may have a MIC IN selected as a source to feed the channel and also have a tape track feeding one or all four AUX systems at the same time! You may split the functions on the channel and each system can be used to do its own job.

TAPE INs 1 through 8 on the M-512 (or TAPE INs 1 through 16 on the M-520) also provide signal to their respective BUSS/(OFF)/TAPE switches in the MONITOR SECTION for monitoring the output of the 8 (or 16) track recorder without having to alter the controls or settings on the Input Channels.

3. 2TR A&B Tape Inputs – Last 4 Channels

Located on the back panel of last 4 Input Channels each of these inputs provides signal to the channel's INPUT select switch. It also provides signal to the MONITOR SELECT switch rack where 2TR A selects the 2TR A, L/R inputs from channels 9 and 10 of the M-512 (or channels 17 and 18 of the M-520), and 2TR B selects the 2TR B, L/R inputs from channels 11 and 12 of the M-512 (or channels 19 and 20 of the M-520). We suggest that you consider using these two stereo inputs to the MONITOR as a two-track master monitor during Remix or as an effects return during Overdub.

In this way it is possible to monitor the Mix-down directly from the two-track or add effects return to your MONITOR mix without recording them.

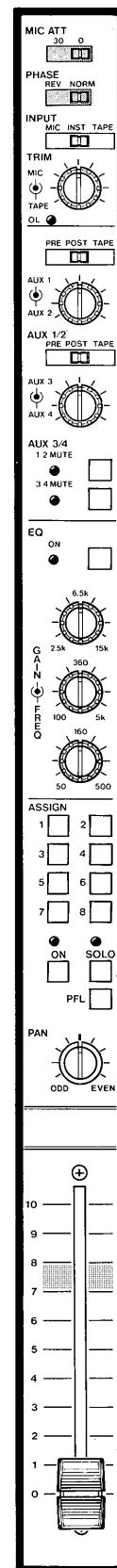

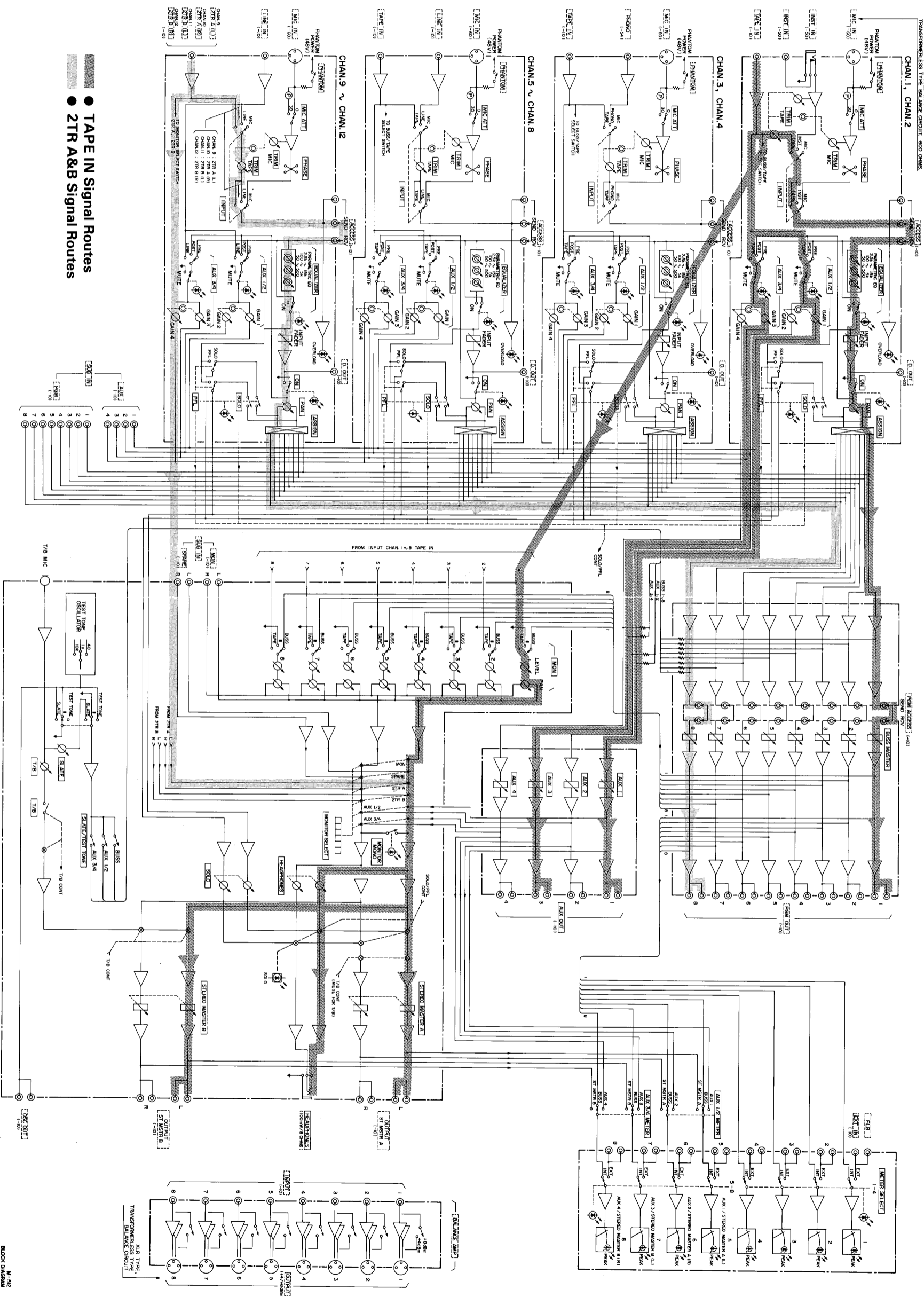
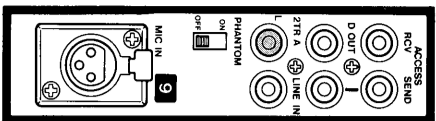
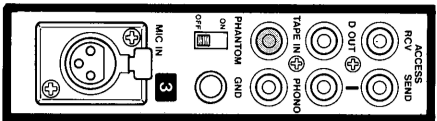

● TAPe IN Signal Routes
 ● 2TR A&B Signal Routes

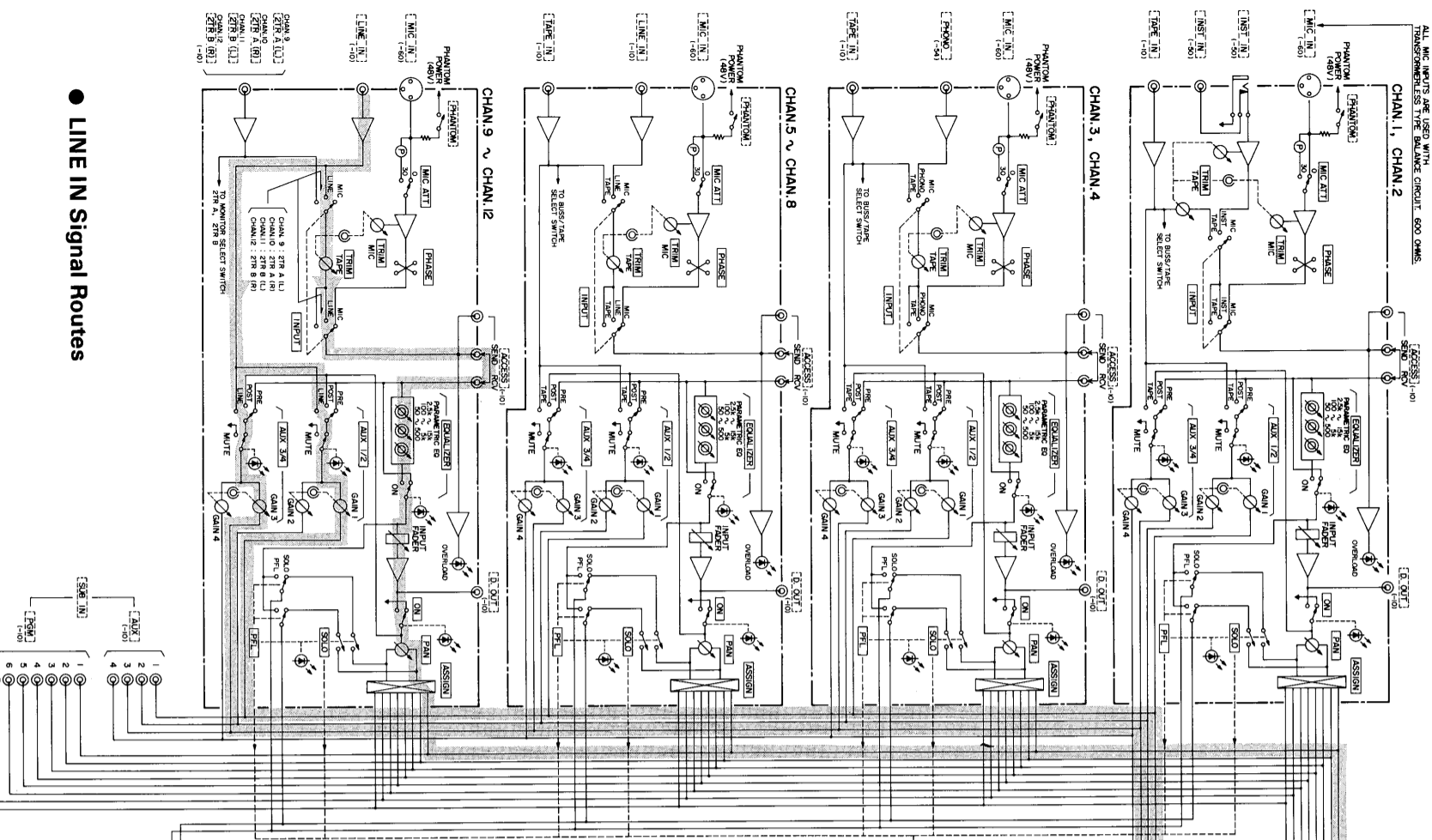

● LINE IN Signal Routes

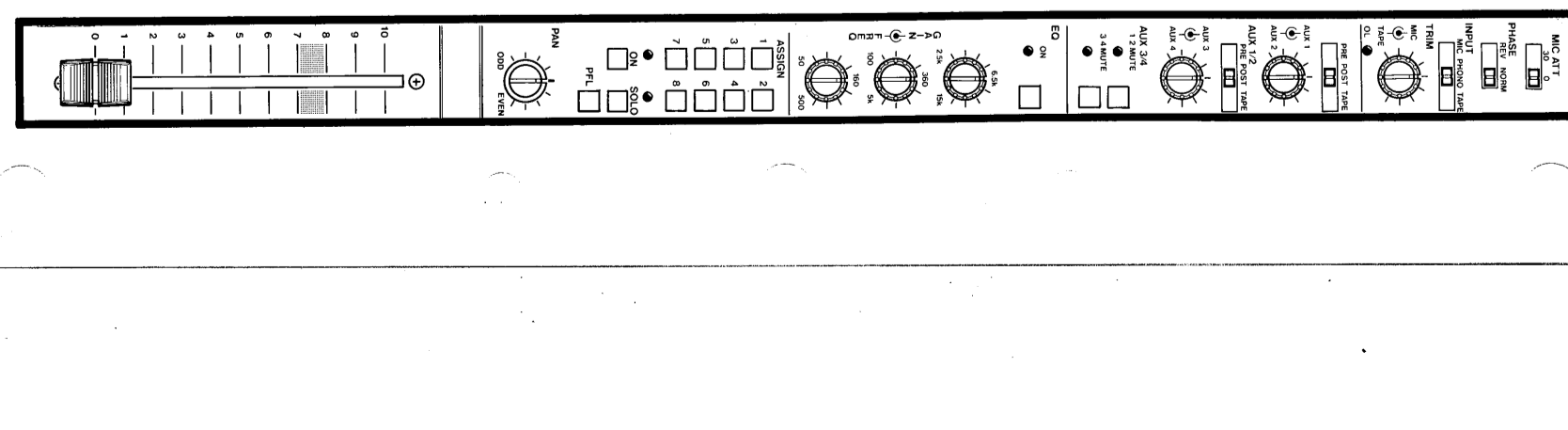
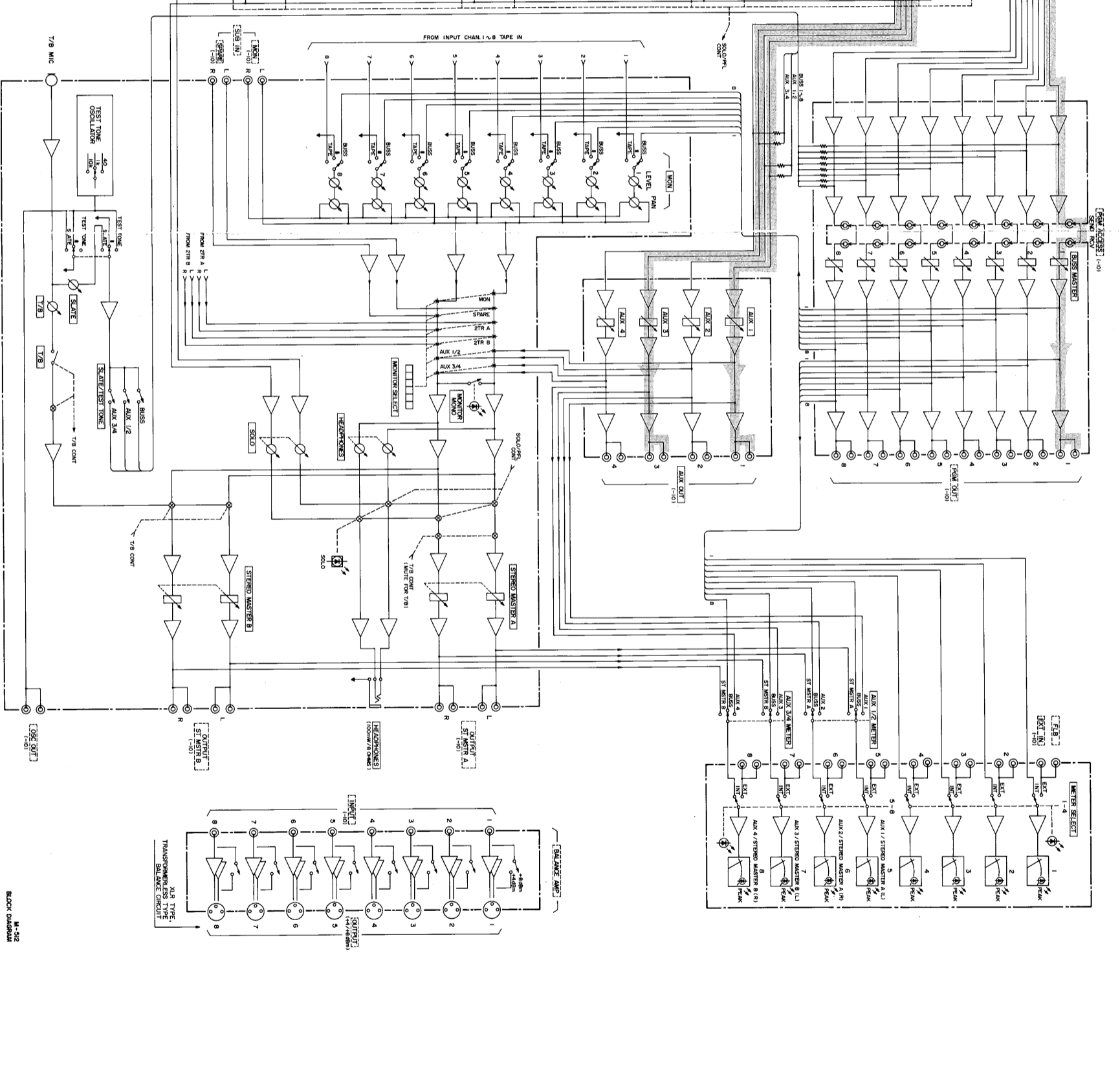

M-212
Block Diagram

4. Secondary Inputs

The term "Secondary Input" refers to an additional input connector other than the MIC and TAPE input connectors locate on *Input Channels* 1 through 8 of the M-512 (or 1 through 16 of the M-520). Functions include Instrument, Phono and Line inputs.

a. INST Input – Channels 1 and 2

Input Channels 1 and 2 each have a pair of INST IN jacks.

1) INST IN (RCA connector)

2) INST IN (1/4" phone jack)

The two jacks are parallel wired. However, when a signal source is connected to the INST IN 1/4" phone jack, the jack will disconnect the parallel INST IN RCA connector from the circuit.

The INST INs will accept the signal "direct" from most electric guitars and basses. With some "hot" pickups you may have to turn down the instrument volume control to avoid overload, or adjust the TAPE (LINE) TRIM control.

b. PHONO Input – Channels 3 and 4

The PHONO input on *Input Channels* 3 and 4 allows the use of a stereo turntable without the need for the purchase of a separate preamp. RIAA EQ is provided, and the input impedance is 50k ohms. the PHONO input has been incorporated for convenience in production which require Library materials to be incorporated; i.e., Multi-Image, Non-Sync film-work, wild track, or to check a test pressing.

c. LINE INputs – Channels 5 through 8 (or 16)
The LINE INs on *Input Channels* 5 through 8 on the M-512 (or 5 through 16 on the M-520) will accept signal from any line level source. Many electronic pianos and synthesizers are compatible with these inputs.

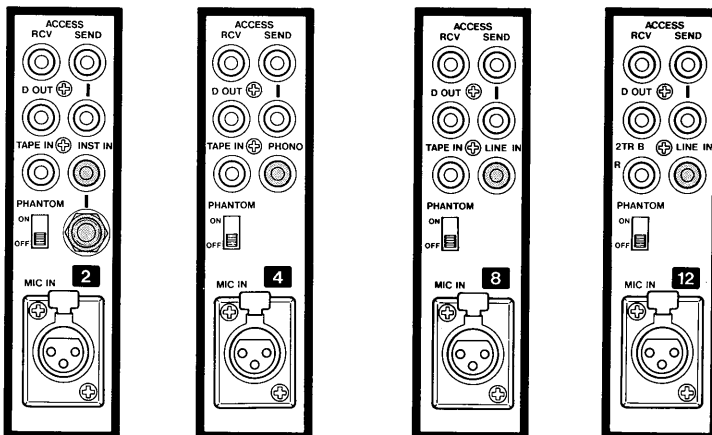
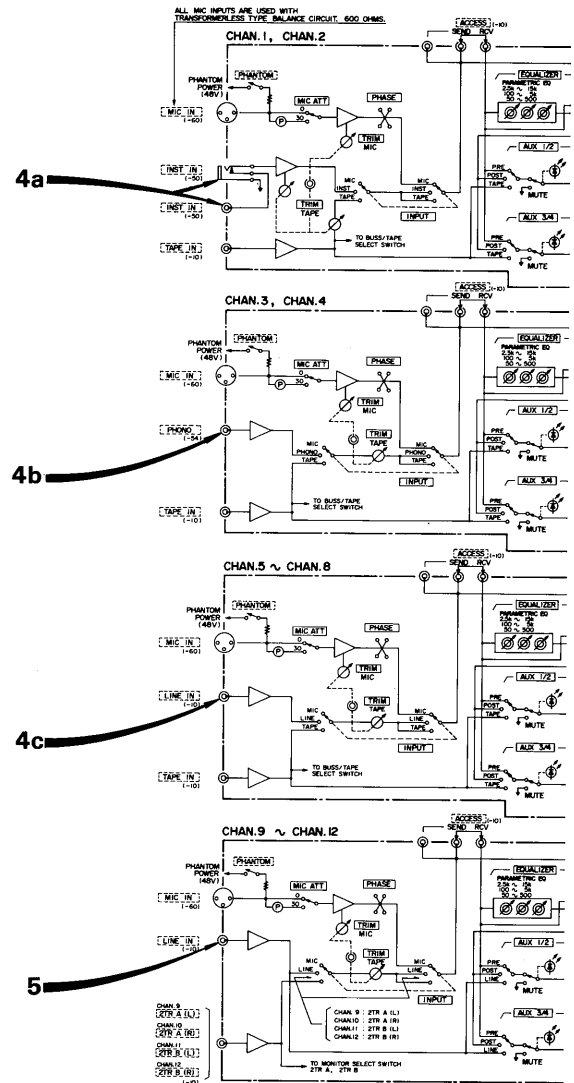

5. 4 Secondary Multi-Purpose Line Inputs

The LINE INput on channels 9 through 12 on the M-512 (or 17 through 20 on the M-520) provides signal to the respective *Input Channel's* INPUT select switch and the channel's AUX 1, 2 and 3, 4 systems. You can have either of the other two inputs (MIC IN or 2 TR input) on these channels feeding the channel and simultaneously select LINE IN to feed the AUX 1, 2 or AUX 3, 4 systems. In this way the functions on the channel may be split and each system can be used separately as required.

6. Trim

Used in conjunction with the OL (Overload) LED, TRIM will reduce the level of those *Input* signals which would otherwise overload the subsequent electronics in the signal chain. Each *Input Channel* is equipped with a MIC TRIM and a TAPE (LINE) TRIM to avoid having to reset the trim or fader when alternating between the MIC IN and another of the inputs to the channel.

a. MIC TRIM (Upper Section)

This control provides variable attenuation to signal originating at the MIC IN. If additional gain reduction is needed, insert the MIC ATT.

b. TAPE (LINE) TRIM (Lower Section)

Provides variable attenuation to signal originating at inputs to the channel other than the MIC INput.

7. Input Select Switch

This three position switch determines which input is to be routed through the channel, and the pre and post feeds to the AUX 1, 2 and 3, 4 systems.

a. Set Left

Select the MIC IN (all channels).

b. Set Right

Selects the TAPE IN; on the last 4 channels this selects the 2TR A and 2TR B TAPE IN, while all other channels it selects the MULTI-PURPOSE TAPE IN.

1) TAPE – Channel 1 through 8 of M-512 or 1 through 16 of M-520

This position provides the mixer's full control capability (EQ, effects, mixing, etc.) for final *Remix* or fine tuning of the playback of the multitrack tape.

2) 2TR A and B – Last 4 channels

Playback from the mixdown deck or any other stereo recorder requiring the mixer's full control capability would be the logical use for this position. However, we suggest you consider using this position as an effects return. You may wish to use 2TR A, L/R to return the effects and 2TR B, L/R for playback of your two-track master.

c. Set Center

Selects the SECONDARY INPUT on channels 1 through 8 of M-512 (or 1 through 16 of M-520) and the SECONDARY MULTI-PURPOSE INPUT on *Input channels* 9 through 12 of M-512 (or 17 through 20 of M-520).

1) INSTRUMENT – Channels 1 and 2

The INST INs may be considered as *direct boxes*.

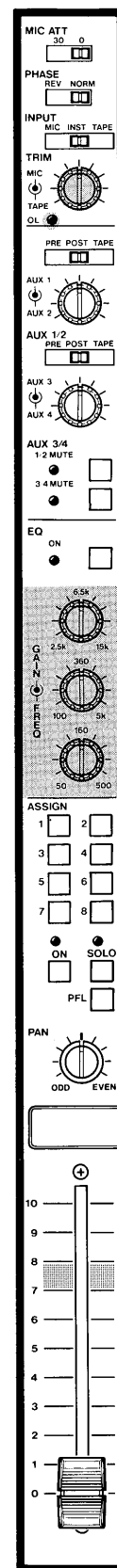
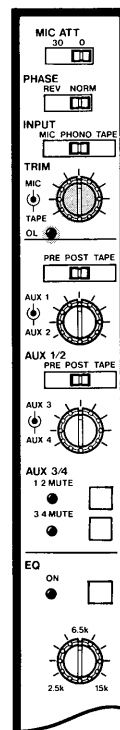
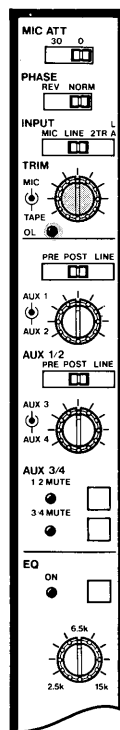

2) PHONO – Channels 3 and 4

Select this position to preamplify the output from a turntable.

3) LINE – Channels 5 through 12 (or 20)

Selects signal from the LINE IN to the channel.

8. Extra Access Send (Pre Out) RCA Jack

Is the preferred point for *Cue* mixes. A mix made from this point by adding an accessory mixer (Model 1) will not change if you move the input fader, use the mute function, or adjust the EQ. The only thing that is more frustrating to a player than having the *Cue* "jump around" in the headphones is to have the sound of a critical part disappear entirely. The pre out avoids this problem.

9. OL (Overload) LED

When signals high enough to make the ACCESS SEND (Pre Out) outputs exceed +15dB are applied to the channel, this LED will light. Adjust the appropriate gain reducing control (TRIM, or MIC ATT) until this LED remains out when signal is present. When working with extremely percussive transient material, maximum TRIM and MIC ATT may be required to prevent this LED from flashing on strong "peaks". Changing to a less sensitive mic may help.

10. Access Send-Rcv Jacks

The high gain provided by the mic preamplifier allows us to place our first "patch point" in this useful location. A limiter connected to this point in the console can be set to a range of compression that will not be altered when the input fader is moved, or the EQ is adjusted. When no accessory device is bridged from the SEND jack to the RCV jack, the jumpers provided *MUST* be in place for signal to flow to the EQ amps and on through the console. There is no "normal" or automatic internal connection when the jumpers are removed.

11. Three Section Semi-Parametric Type (Sweep) Equalizer

The classical definition of the word parameter is a variable, such as; weight, length, height, etc. In our case the term "parameter" refers to the adjustable frequency point. The "parameters" or "rules" are not fixed at any specific number, but are continuously variable. Two aspects of the circuit, the frequency center point and the "boost" or "cut" in gain are adjustable without "steps". Here are three graphs showing the control ranges of each of the three sections. Each section provides some "overlap" of the previous section in regards to the frequency range.

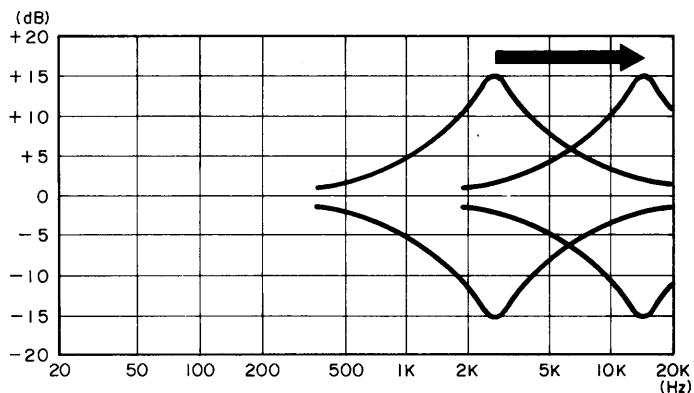
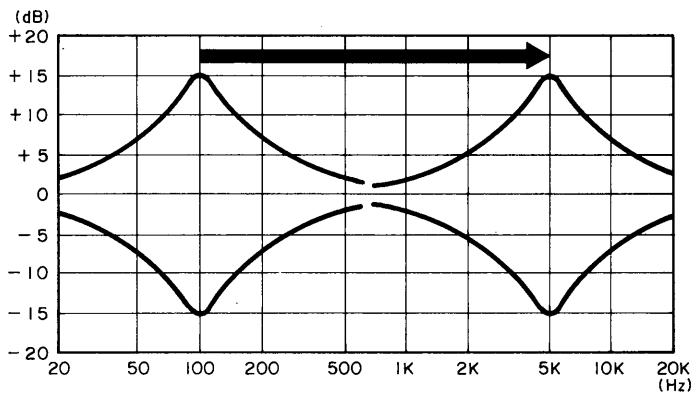
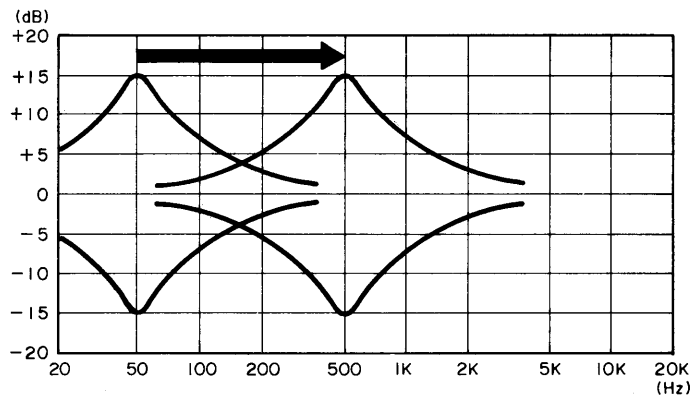
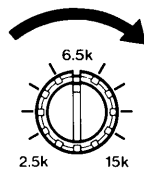
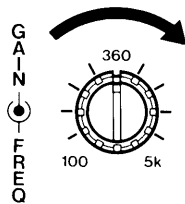
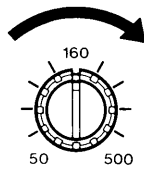
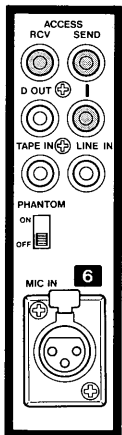

The great advantage of a parametric or continuously "tunable" equalizer over the more conventional "fixed center frequency" types is that you can adjust the frequency center point to the precise area you need and then the cut or boost you use will be more effective. You get the result needed with less rotation of the control, and this puts less "strain" on the electronics. No matter how many "frequencies" there are on a "set" type EQ it is unlikely that any one will prove to be "just right" and many more ranges are needed to do the job.

"Less" is always the best working concept in audio, so use the EQ after all other methods have been exhausted.

Move the mic, change the mic, and finally — try the "cut" functions of the EQ first.

Even experienced engineers have a tendency to forget that "cutting" the lows will have a similar effect to "boosting" the highs, and puts less of a strain on the electronics. The results are not identical but they are close enough to warrant trying. Cut bass, raise the overall gain, and see if it sounds better than just "boosting" the highs.

12. Equalizer On Switch, LED Indicator

This switch is provided to engage or bypass the channel's entire EQ section with a single control. A setting can be compared to "flat" by alternately switching in and out, or, the setting can be bypassed until needed and "dropped in" with a single action.

Up, the equalizer is bypassed.

Down, the equalizer is engaged.

When the EQ ON switch is depressed, the LED will light to remind you that the EQ has been engaged.

13. PFL (Pre-Fader Listen) Switch, LED Indicator

In radio and PA, there are many instances when it is desirable to check a signal *before* opening the fader and committing the signal to broadcast or a "House feed". Is the mic working? Do you wish to talk to an announcer before going "on the air" or do you need to ask a vocal group a question (and hear the answer) about the *Cue* balance while doing a background vocal? Use this PFL function. When this push switch is depressed, the pre-fader signal goes directly to the SOLO circuits, replacing whatever signal group or groups you have selected on the MONITOR SELECT switch

rack. PFL signal will be heard "center mono", and more than one PFL may be depressed at a time. Push to enable, push again to release. The switches latch to make a "Mix". Depressing the PFL switch will activate the channel's SOLO LED.

In addition, depressing one or more PFL switches will turn on the large SOLO LED on the upper right side of the console to warn you that the MONITOR SELECT switch rack has been bypassed. Why? If the MONITOR has been bypassed by the accidental depression of a SOLO or a PFL button, and, there is no signal in the circuit that is soloed, *THE MIXER MAY APPEAR TO BE INOPERATIVE!* No other MONITOR function or mixing control can affect the signal sent to the ST MSTR A L/R OUTs or the HEADPHONES jacks until you release the unwanted SOLO or PFL function. Even if you are positive that there *IS* signal in a soloed channel, you may forget to advance the separate SOLO volume and you will still hear nothing.

The PFL signal is affected by the EQ ON switch, which changes the signal pickoff point. You can't hear the effect of equalization if the EQ ON switch is released.

14. Input Fader

The main mixing control for individual signals on the console.

Faders, also called "pots" (potentiometers) or attenuators always cause loss in order to control signal.

15. Input Channel Buffer Amp

This amplifier has a gain of 8 dB, but its primary purpose is not really signal "boosting". It is here to isolate the input fader from the effects caused by the connection and disconnection of the circuits that follow.

16. Direct Out RCA Jack

The specifications of the console's gain stages and summing networks are as close to ideal as we can offer. However, the fewer the number of parts, amplifiers, and summing networks that the signal passes through, the lower the amount of noise and distortion. Therefore, consider using the Direct OUT (D. OUT) to feed a one mic per track signal to the recorder.

This output can also be used in combination with an outboard mixer to make up an additional *post* fader mix.

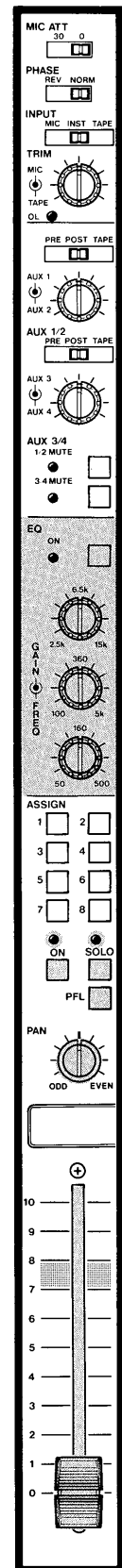

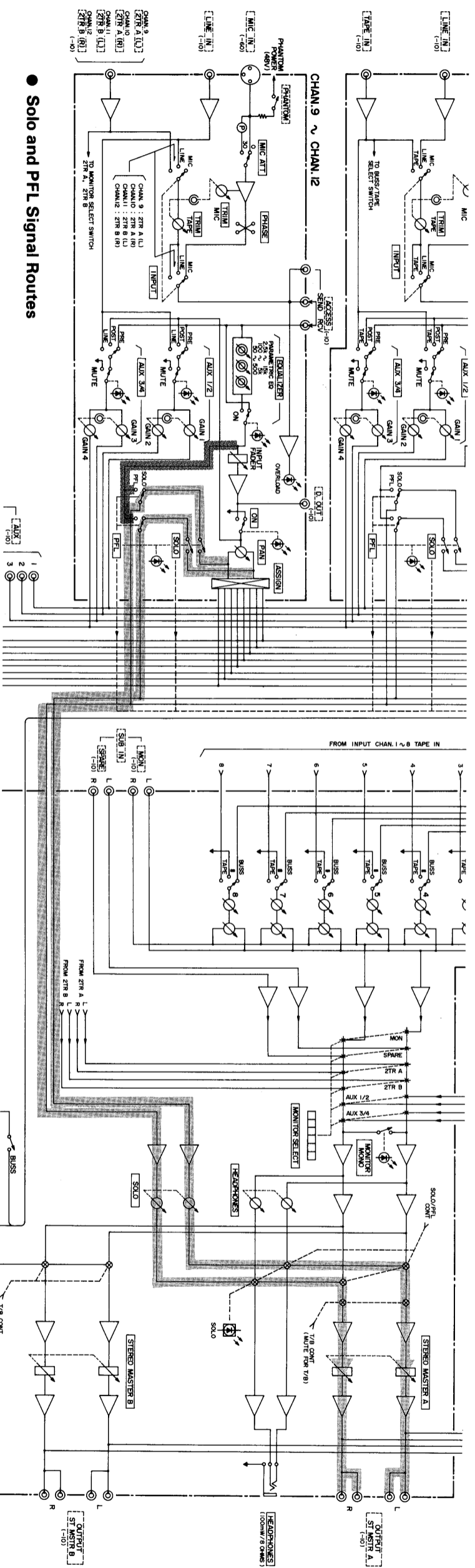

● Solo and PFL Signal Routes

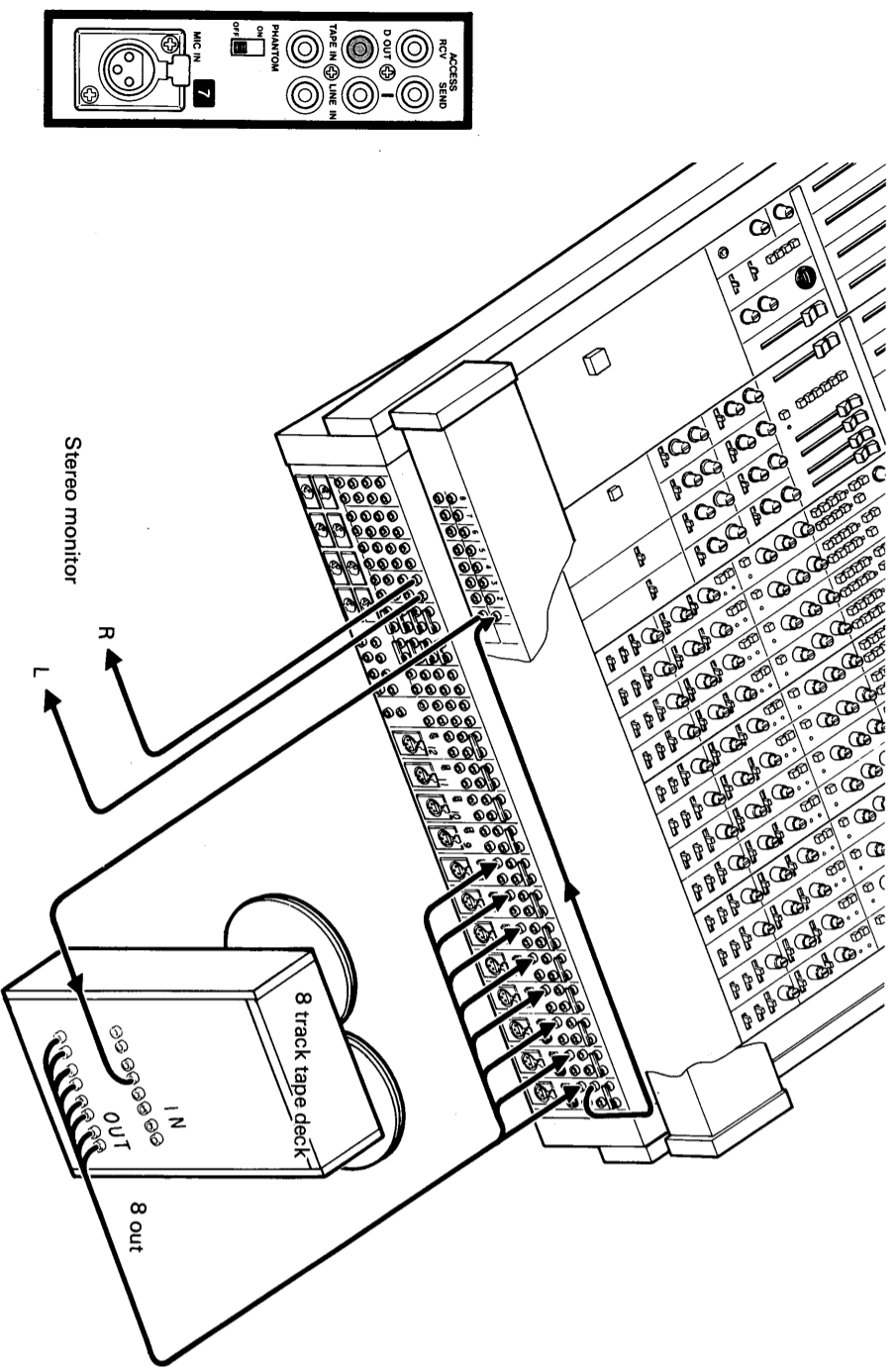

● Typical Example of Direct Out Usage

17. Channel On Switch, LED Indicator

- a. Located after the input fader in the signal chain, the Channel ON switch *simultaneously* disrupts the flow of signal to the PAN control and the POST position of the AUX 1, 2 and 3, 4 signal select switch.
- b. The Channel ON switch can be used to assign a channel that has been preset and EQ'ed without having to reset the input fader accurately when you are rushed. The LED indicator will remain lit until the Channel ON switch is released.
- c. The Channel ON switch does not affect the DIRECT OUT, ACCESS SEND, or the PRE position of the AUX 1, 2 and AUX 3, 4 signal select switch.

18. Pan Pot (Buss Select)

This knob works two rotary faders that are wired "back to back". As you rotate, one is turned up as the other is turned down, and the signal is shifted in stepless fashion from one BUSS to the other. When the control is "dead center", each fader is still reducing the signal slightly so that the signal transition through "center" does not become louder as you pan through it. Panning is possible only between odd and even numbered BUSES.

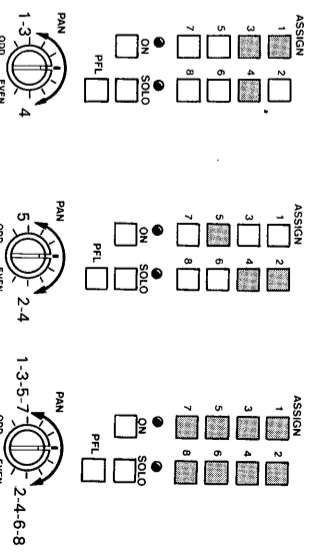

Typical examples of multichannel panning

19. Solo Button, LED Indicators

Depressing this button will cause the signal on the *Input Channel's* main line to go directly to the SOLO master volume control, and then to the ST MSTR A OUTS L&R. The SOLO signal will temporarily replace the signal selected at the MONITOR SELECT switch rack. Because the SOLO signal is taken off *after* the action of the PAN pot, this SOLO is a true stereo function and in *Remix* you will hear the effect of stereo placement as well as EQ, and level set by all other prior *Input Channel* controls.

AUX SECTION

The two AUX systems consist of four mono non-dedicated busses which can be used for HEADPHONE CUE, EFFECTS SEND, ECHO SEND, SECONDARY MONITOR, BROADCAST REMOTE FEED, and reference RECORDING busses. The busses are paired in that the AUX 1 and AUX 2 gain controls are concentric and are fed the same signal from the AUX 1, 2 Select Switch, and the AUX 3 and AUX 4 gain controls are concentric and fed from a separate AUX 3, 4 Select Switch. This enables the paired busses to be used for four discrete mono mixes, two stereo mixes, or one stereo and two mono mixes.

When only one BUSS has been selected, the PAN pot still affects the stereo SOLO. SOLO affects only the ST MSTR A OUTs L&R, the outputs from busses 1 through 8 (which, with their paralleled connectors, are labeled PGM OUT 1 through 8), AUX OUTs 1 through 4, or the channel's D. (Direct) OUT or extra ACCESS SEND output (1). The same cautions apply to the SOLO function as the PFL in regard to a possible confusion about whether the mixer is operating or not. Recall that when either SOLO or PFL is engaged on a channel that has no signal in it, you will hear nothing in the MONITOR. To warn you, there is a master SO-LO/PFL indicator on the upper right side of the

console front panel, plus a smaller LED on each channel to show when SOLOs or PFLs are active.

20. Buss Assign Switches

This rack of eight switches is arranged in two columns; odd numbered, left, even numbered, right, indicating which "side" of the PAN pot they will be assigned to. As in all TASCAM mixers before the console, it is still possible to assign a channel to a single BUSS by depressing just one switch and avoid the inevitable increase in crosstalk caused by using the PAN as a part of the basic signal assignment scheme.

21. AUX 1, 2 & 3, 4 Signal Select Switches

- a. Set Left (PRE)
Pre-fader signal is taken from the stage preceding the fader and EQ, so it is not affected by the channel's fader or EQ settings, making this setting useful for stable Cue mixes.
- b. Set Center (POST)
Selects post-fader signal from the point in the channel right after the MUTE switch. Because signal feeding this position will be subject to any adjustments to that channel's inputs fader,

this position is usually preferred for effects or echo mixes.

- c. Set Right

1) TAPE - All but the last 4 channels

Selects the MULTI-PURPOSE TAPE IN. This is the preferred position to set up the performer's Cue mix for overdubbing which requires the ability to combine the already recorded tracks with the new material. By monitoring the recorders output while in Sync mode, you will have both the new and pre-recorded material available for an independent Cue mix.

When checking the overdub, the Cue system will now be fed all of the recorded tracks at relatively the same mix levels as occurred during the recording.

2) LINE - Last 4 channels

Selects the channel's SECONDARY MULTI-PURPOSE LINE IN. This line level input can be selected to feed the AUX systems while one of the other remaining input separately feeds the channel.

The LINE setting is very useful as a way to return submixes or effects into one or all four of the AUX systems.

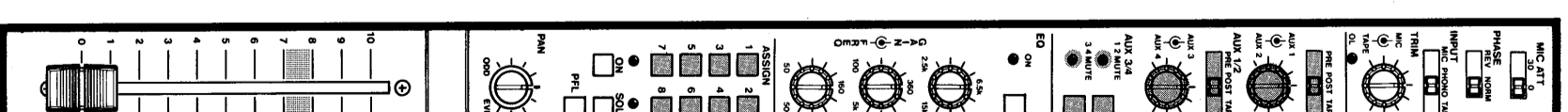
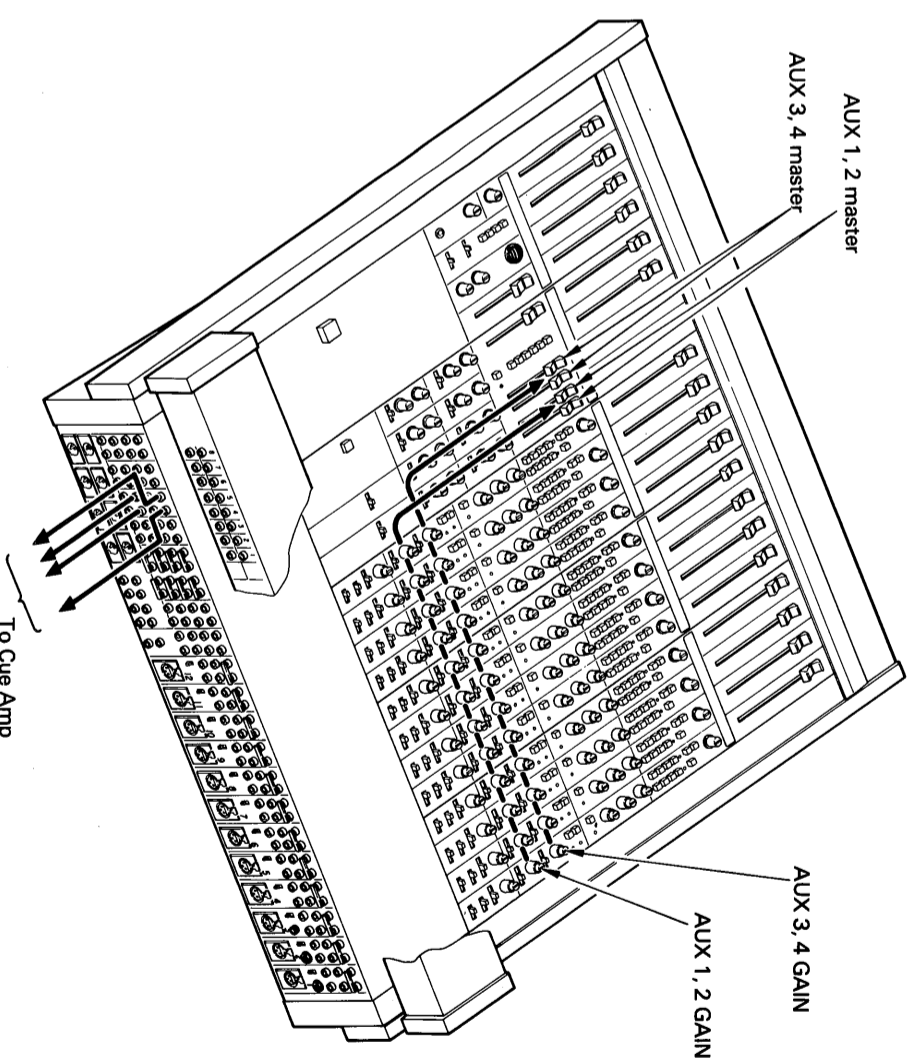
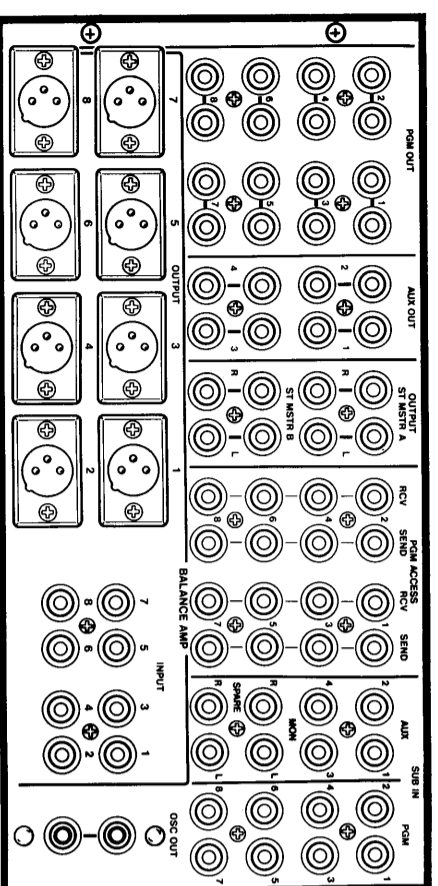

BUSS MASTER SECTION

22. AUX 1, 2 or 3, 4 Mute Switch, LED Indicator

The AUX MUTE switch will interrupt the flow of signal to the AUX GAIN controls, will turn on the LED MUTE indicator, and will affect all options of the AUX signal select switch. By pre-setting the level of the AUX GAIN and then depressing the AUX MUTE switch, a one button "drop in" can be performed by releasing the AUX MUTE switch at the desired moment.

23. AUX 1, 2 and AUX 3, 4 Gain (Dual Concentric Control)

Individual gain controls are provided for each of the four AUX busses. However, the controls are paired with AUX 1 atop AUX 2 in one dual concentric controls, and AUX 3 atop AUX 4 in the other dual concentric control.

24. AUX Sub IN 1 through 4 RCA Jacks

Any line level signal may be introduced into the AUX systems at these patch points. These inputs may be used to cascade the output from another mixer into the AUX 1 through 4 mixes.

Since there is no separate volume control just for these patch points, level control for these additions to your AUX mixes must come from the device that you have "patched in".

25. AUX 1 through 4 Master Faders

Each of these *four* straight line controls provides overall level adjustment of the AUX signal sent to its respective AUX output jacks, the AUX 1/2 or 3/4 METER select switch, and to its MONITOR SELECT switch.

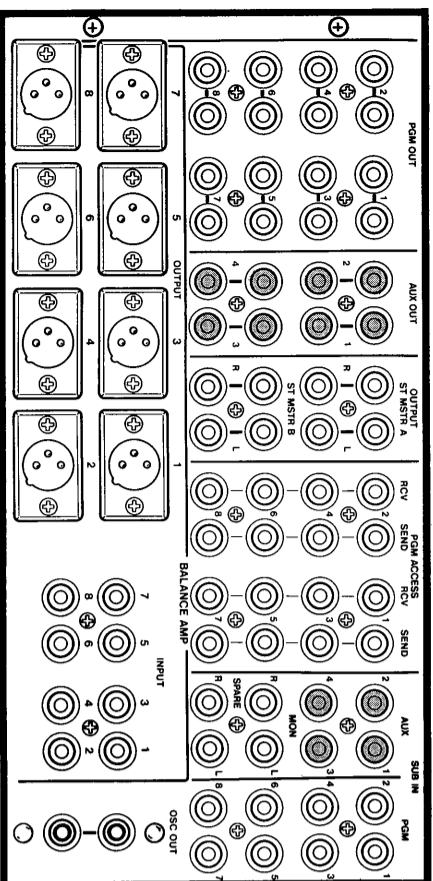

26. AUX Out 1 through 4 RCA Jacks

Each of these output jacks can be used for a variety of accessory functions; effects sends, Cues, monitor mixes, and the like. What you connect here will depend on the job you need done by the AUX systems at the time.

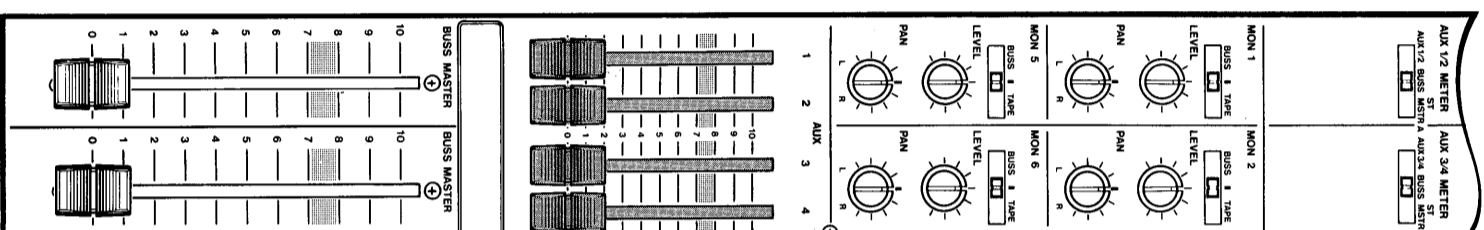

M-512

27. Program Sub Ins, 1 through 8

These inputs may be used to accept the output of another mixer or any other line level source you wish to add. Since there is no separate volume control just for this patch point, level control for additional signal introduced here must come from the device that you have "patched in".

28. Master Buss 1 through 8 Combining Network and Summing Amplifiers

These amplifiers don't show on the outside but their contribution to the system is considerable. These devices allow the all input channels to add their signals together without one channel distorting the output of another. When you wish to "combine" or "sum" two or more varying voltages that are being used to represent sounds, a simple "joining together" of the wires *will not* work. This type of circuit protecting "summing amplifier" also appears in several other places inside the console:

AUX 1, 2;

AUX 3, 4;

MONITOR, L/R.

29. PGM Access Send/Rcv RCA Jacks

This pair of jacks is used to add an accessory or effects device (echo, flanger, what have you) to the entire group of signals on a BUSS. This feature is not provided on the AUX 1 through 4 busses. When no device is "bridged" across these jacks, the jumpers *must* be in place for signal to flow, as there is no "normal" or internal connection.

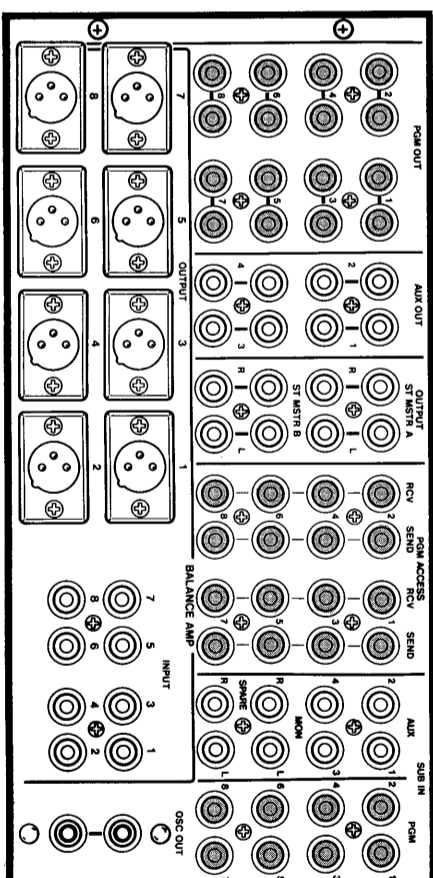

M-512

30. Buss Master Fader

There are eight of these straight line faders, one for each of the eight BUSSes. Each BUSS MASTER fader controls the output from its buss summing amplifier. It is a "grand master" for all signals that have been assigned to the BUSS, from *Input Channels*, PGM ACCESS SEND/RCV, or the PROGRAM SUB IN. Use it to simultaneously adjust these three different "feeds":

a. The level sent to the PGM OUTs 1-8.

b. The level shown on the meters when their switches are set to read BUSSes 1-8.

c. The level sent to the MONITOR control group.

31. PGM Out RCA Jacks 1 through 8

The final output of your mix. While there are 8 mixing busses, each buss is connected (in parallel) to two output jacks so that a 16 track recorder can be used without re-patching or "Y" adapters. Buss 1 feeds PGM OUT 1, Buss 2 feeds PGM OUT 2, and so forth. At this point, all functions have been applied to the signals. The only controls that remain are the sections of the mixer that allow you to see and hear what you are doing; the meters and the monitor feeds. We'll go to the block diagrams and with the outputs first (page 67-70).

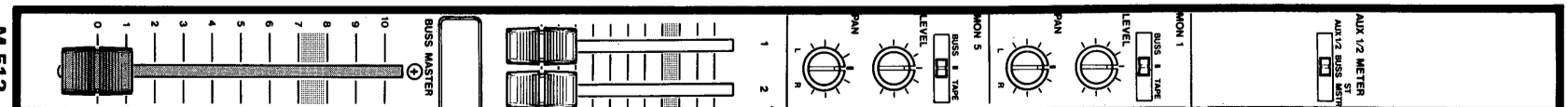

M-512

MONITOR SECTION

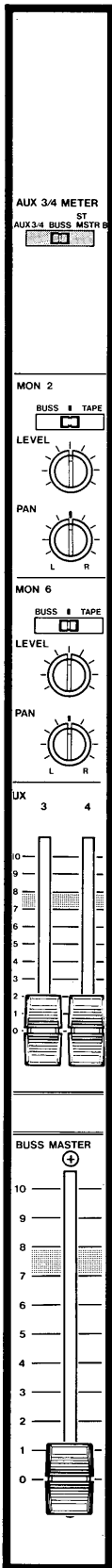

M-512

32. VU Meters (1 through 8 of M-512, 1 through 12 of M-520)

These VU meters have the standard volume unit ballistic. They respond to the *AVERAGE* level of the signal not the *PEAK* level. The 0 VU point is set to equal 0.3 volts (-10dB referenced to 1 volt). Because the signal level sent to the meter amplifier proceeds the circuits that switch the reference levels of each BALANCE AMP OUTPUT XLR connector, from +4 dBm to +8 dBm, it is not necessary to adjust the meter amps or the LED driver circuits when you wish to change balanced output reference levels.

Meters 1 through 8 may be switched, in groups of 4, to display the level of signals other than the "normal", internally routed signals. Sixteen jacks on the rear of the meter pod are provided to patch in any 8 signals you wish, and to continue that signal path; METER SELECT (Int/Ext) switches adjacent to the meters select the "normal" or externally patched signals. In this case, calibration remains the same, with 0 VU equal to -10 dBV. The external jacks may be used to monitor individual channel direct outputs, tape inputs (which is the most common use), echo/effects returns, etc.

33. Peak LEDs

These light emitting diodes will react much more quickly than the meters, and are set to "flash" 10dB above "0VU". They will show you the difference between average and peak levels. On most percussion material (kick drum, latin percussion such as castanets or the Brazilian instrument called an afuche) you will see these LEDs flash *long before* the VU meters read anywhere near zero. Short term peak distortion may be hard to detect. Use discretion and experiment with the final meter level when you see these lights flash. They are telling you the truth about the *REAL* level that is being sent to the final output and "average"

is not always a safe concept. For example, castanets should be recorded with no more than a -20 indication showing on the *averaging* VU meter. Even when the meter reads this low you may still see the LED flash. Take care and avoid overload.

It is normal for the console meters to jump when AC power is first applied, and the headphone amplifier may produce a substantial transient "pop" even if the HEADPHONES master pot is rotated fully leftwards (off). Patching in mics and accessories with the faders down will insure that you don't damage your ears, the console or any other equipment that you may be using. Take care.

34. M-512, Last 4 VU Meters & Function switches - AUX (1/2 or 3/4)/BUSS/ST MSTR (A or B)

The M-512 has a pair of 3-position function switches that permit the meters for busses 5 and 6, and busses 7 and 8, to monitor any of 3 different signals (provided the METER SELECT switch is set to INTernal position; EXT position actually selects a fourth possible source).

- a. Set Left - AUX 1/2 (Meters 5 & 6)
- AUX 3/4 (Meters 7 & 8)

Meters 5 and 6 will now indicate the signal level appearing at the AUX 1 and AUX 2 outputs, or meters 7 and 8 indicate the signal level at the AUX 3 and AUX 4 outputs, respectively.

- b. Set Center - BUSS (Meters 5 through 8)
- Meters 5 and 6 will now indicate the signal level appearing at the PGM OUTs 5 and 6, or meters 7 & 8 indicate the level at PGM OUTs 7 and 8.

- c. Set Right - ST MSTR A (Meters 5 & 6)
- ST MSTR B (Meters 7 & 8)

Meters 5 and 6 will now indicate the signal level appearing at the ST MSTR A OUTPUTs L/R (Stereo Master A), or meters 7 and 8 indicate the level at ST MSTR B OUTPUTs L/R.

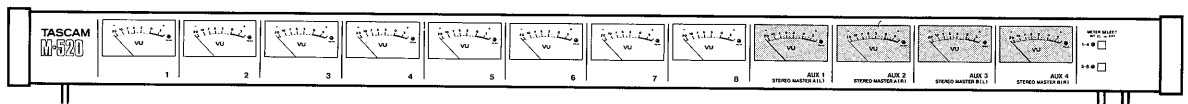
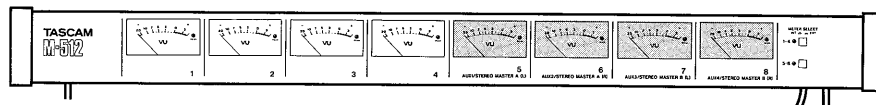

35. M-520, Last 4 VU Meters & Function Switches – AUX (1, 2 or 3, 4)/I/ST MSTR (A or B)

The last 4 meters on the M-520 can be switched; in groups of two, to indicate either of two internal sources.

- a. Set Left – AUX 1/2 (Meters 9 & 10)
– AUX 3/4 (Meters 11 & 12)

Meters 9 and 10 will now indicate the signal level appearing at the AUX 1 and AUX 2 outputs, or meters 11 and 12 indicate the AUX 3 and AUX 4 outputs respectively.

- b. Set Right – ST MSTR A (Meters 9 & 10)
– ST MSTR B (Meters 11 & 12)

Meters 9 and 10 will now indicate the signal level appearing at the ST MSTR A OUTPUTS L/R (Stereo Master A), or Meters 11 and 12 indicate the level at ST MSTR B OUTPUTS L/R.

Note: The first 8 meters of the M-520 normally indicate the level of the 8 BUSS outputs (provided the METER SELECT switch is set to INTERNAL position; EXT position actually selects a second possible source). The BUSS OUT level, indicated on these meters, actually indicates the level appearing at PGM OUT jacks 1 through 8; remember that BUSS 1 feeds PGM OUT 1, BUSS 2 feeds PGM OUT 2, and so forth.

36. MON BUSS/ I(OFF)/TAPE Signal Select Switches

These three-position switches determine which signals will be used to feed your MONITOR mix. There are 8 such switches on the M-512, and 16 on the M-520.

- a. Set Left – BUSS

Signal appearing at the BUSS OUT (PGM OUT) having the same number as the switch will be made available to the MONITOR mix via the MONITOR LEVEL and PAN controls located directly below the switch.

- b. Set Center – I(OFF)

Signal is muted.

- c. Set Right – TAPE

Routes signal from the MULTI-PURPOSE TAPE IN of the same number to the switch's corresponding MONITOR LEVEL and PAN controls.

This provides an 8 x 2 monitor mix on the M-512 or a 16 x 2 mix on the M-520.

37. MON Level Control (x8 in M-512, x16 in M-520)

This pot controls the level of signal selected to appear in the MONITOR mix by its corresponding MON BUSS/ I(OFF)/TAPE signal select switch.

38. MON Pan Control (x8 in M-512, x16 in M-520)

This pot determines the stereo placement of the signal selected by its respective MON BUSS/ I(OFF)/TAPE signal select switch and MON LEVEL control.

39. MON Sub In L/R RCA Jacks

This input is provided in order to add any appropriate signal to the MONITOR mix. Level control of this signal must come from the device that you are feeding in. There is no individual gain or pan on this input pair.

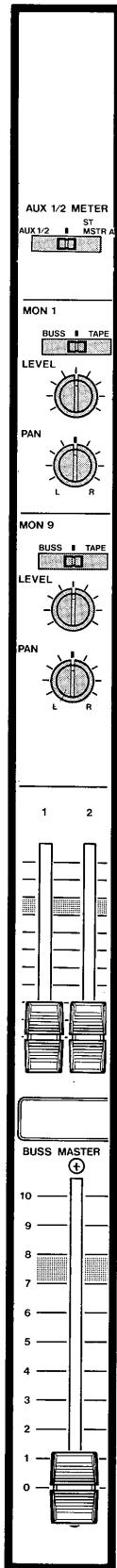
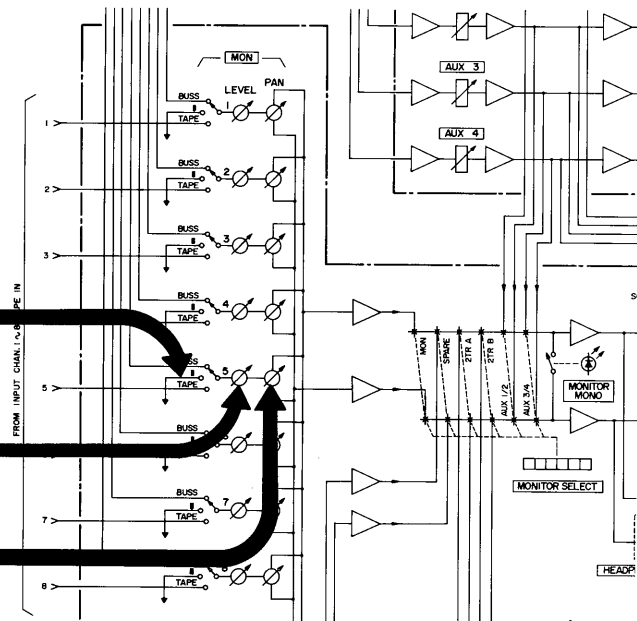
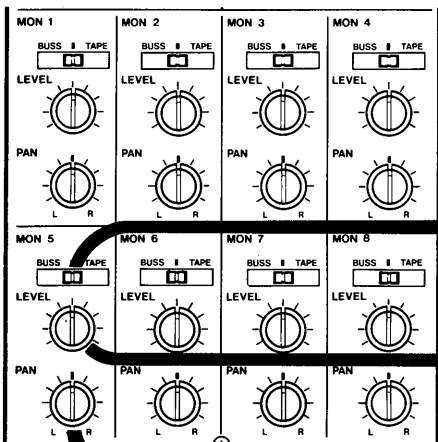

M-520

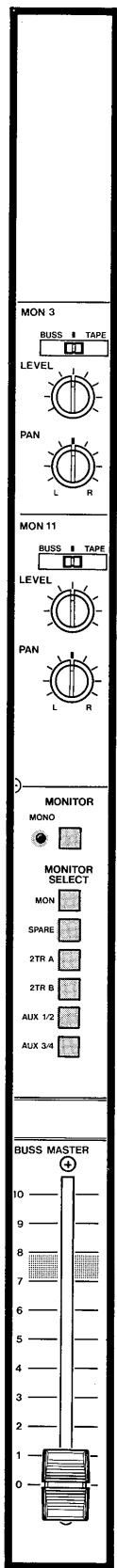

40. Monitor Select Switch Rack

If you examine the *Block Diagram* you will see that this signal select determines what will appear at both the ST MSTR A and B OUTPUT, L/R RCA jacks and the HEADPHONES tip-ring-sleeve final stereo output. There are 7 options, and since this switch rack can combine signals, any or all switches may be depressed simultaneously. There are several combinations of two or more of these switches that will solve listening problems that are common to the multitrack process, so we'll detail each option and it's benefit.

a. MON Switch

The first position selects the output of the MONITOR section (8 x 2 in the M-512, 16 x 2 in the M-520). Since this BUSS/||(OFF)/TAPE group is the *Basic* 8-track working system for the whole M-512 (8 or 16-track for the M-520), you will probably have it selected almost all of the time.

b. SPARE Switch

When depressed, selects the SPARE SUB IN L/R jacks on the rear panel. Any stereo input such as a submix or a two-track patched in to the SPARE SUB IN L/R jacks can be switched in and out of the STEREO MASTER A&B busses.

c. 2TR A Switch

Selects the 2TR A, L/R input jacks on channels 9 and 10 (M-512) or 17 & 18 (M-520). This position can be used to quickly switch the monitor to a two-track to check a mix down, or, to listen to a signal group *without* recording it as we stated in the previous section 2TR A&B, L/R input.

d. 2TR B Switch

Selects the 2TR B, L/R IN jacks at once on channels 11 and 12 (M-512) or 19 & 20 (M-520). This is basically a duplicate of the function provided by the 2TR A switch, but for the last 2 channels.

e. AUX 1, 2 Switch

Selects the AUX 1 and AUX 2 final mixes after the AUX 1 and 2 master faders. This position will allow monitoring and adjustment of these AUX mixes as they are sent out to cue amps, effects devices, and so forth. The two are switched together so they may be used for a single stereo mix, or they may be used as independent mono mixes.

f. AUX 3, 4 Switch

Selects the AUX 3 and AUX 4 final mixes after the AUX 3 and 4 master faders. Essentially, this is a duplicate of the AUX 1, 2 switch, but for AUX mixes 3 and 4.

These two switches (AUX 1, 2 and AUX 3, 4) are basic multitrack necessities. And, when any session that depends on a good *Cue* (headset) mix begins, either of these switches should be your first selection so you can listen to the *Cue* system balance, and set the rehearsal sound.

g. MONITOR MONO Switch

When the final format is *mono*, such as a radio spot, rather than force you to "center" all the MONITOR PANs, we provide this switch. It will sum together both sides, left and right, of the stereo signal present in the MONITOR SELECT switch rack and will show you what your mix will sound like *BEFORE* it is broadcast. In stereo recording for disc release, it is useful to

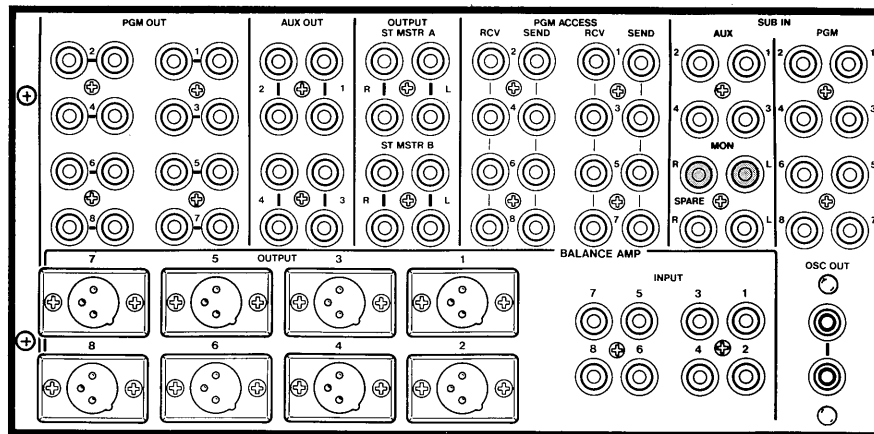

know in advance what will happen when a stereo sound is combined to mono, even though no mono mix is planned. Remember that radio is often *mono*, and much difficulty with mics wired "out of phase" or effects return added to the mix unwisely can be avoided by listening to a *mono* in the monitor while you still have a chance to change the approach. Disc cutters don't like too much out of phase stereo, and this one error can be the major cause of disappointment with a test pressing. Since a cutting tip is not capable of moving in two directions at the same time, and since two loudspeakers are truly independent systems, you can get a terrific sounding tape that makes a very poor record if you don't check for mono compatibility. What to listen for? A mix that doesn't lose most of its high or low frequency content when you select mono. Phase is a difficult subject and there are no simple repairs that we can guarantee. You will have to experiment to find solutions one at a time. Moving the mic 1/2 inch may change everything. Using the PHASE Reverse switch may also help solve this type of problem.

h. MONO LED Indicator
This LED is provided to remind you that the MONITOR MONO switch is on.

41. Monitor Buffer Amp

Isolates the MONITOR from the multiple connections that follows.

42. Headphones Volume Control

This rotary control will allow independent adjustment of the headphone volume.

43. Headphones Tip-Ring-Sleeve Stereo Output Jack

Use only stereo phones!

CAUTION! MONO (2 WIRE) HEADPHONES WILL CAUSE EVENTUAL CIRCUIT FAILURE.

If your "phones" have this connector, **DON'T** use them.



(1/4" phone 2 section connector)

To be safe, the headset connector must have three sections. We realize that in any patchable system, accidents can happen. We do build protection circuits in to assure that a momentary mis-connection will not cause instant failure, but just because the circuit seems to work OK when you try it for a moment or two, don't assume that it will work forever. Sooner or later, it **WILL** fail (2 to 3 minutes). The reason? When the "sleeve" of the 2 wire phone jack is inserted, it will connect *both* outputs together "head to head" and this is not a usable signal combining method.

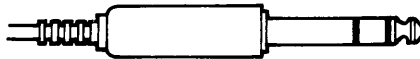

(1/4" phone 3 section connector)

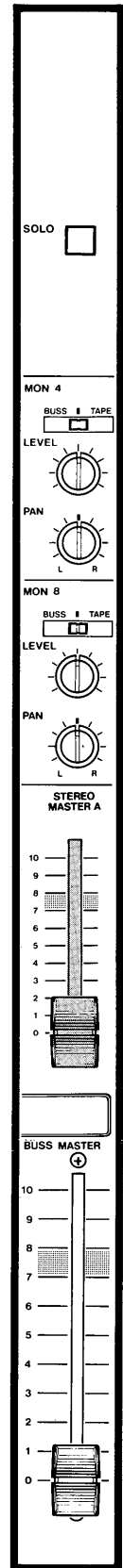
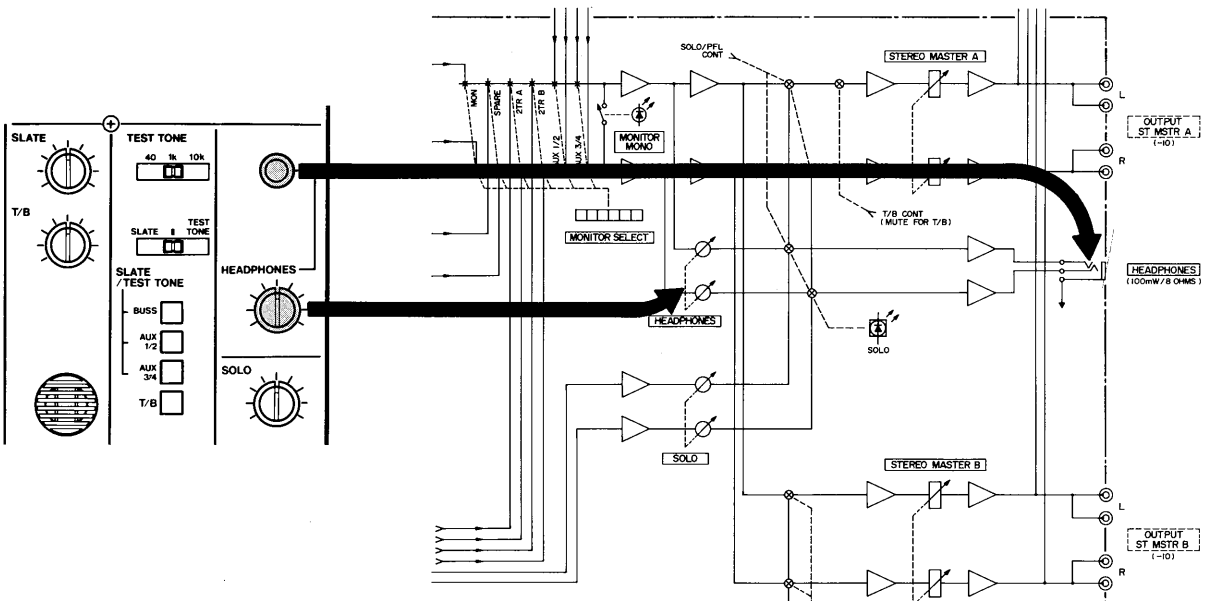

44. Stereo Master Faders, A&B

Each *dual* slide fader (stereo) adjusts the overall level of the signals selected at the MONITOR SELECT switch rack. The signal level appearing at the ST MSTR A OUTPUTs L/R is determined by the STEREO MASTER A fader while the STEREO MASTER B fader determines the signal level appearing at the ST MSTR B OUTPUTs L/R.

45. Monitor Buffer Amp

For signal isolation.

46. ST MSTR A Output L/R RCA Jacks

The expected use of this output pair is to send signal to a power amp and loudspeakers for control room monitoring. Output from the SOLO and PFL system will appear here.

47. ST MSTR B Output L/R RCA Jacks

Because output from the SOLO and PFL systems *does not* appear at this output pair, it may be used as either a studio feed or in conjunction with the balanced output amplifier as a broadcast clean feed, or as a secondary recording buss.

48. +4/+8 Balance Amp Output Connectors 1 through 8

This set of 8 outputs can be patched to convert any of the console's -10 dBV unbalanced output jacks to balanced, transformerless, +4 or +8 dBm outputs. The availability of these low impedance, balanced outputs is essential whenever long lines are to be run without high frequency signal loss or susceptibility to hum and interference. Signal may be patched into these outputs by means of the BALANCE AMP

INPUT 1 through 8 RCA connectors adjacent to the balanced XLR connectors on the rear panel. These jacks may be used for the 8 mixing busses (PGM OUT 1 through 8), for a pair of stereo outputs (ST MSTR A & B, L/R) plus the mono AUX mixes (AUX 1 through AUX 4), or any of the console outputs. In fact, these jacks can even be used for balancing the output of external line level devices (-10 dBV nominal level) such as the output of a reverb or compressor.

Switches are provided on the PC Board in the panel to set the nominal "0 VU" reference to either +4 dBm or +8 dBm.

Remove four screws (in M-512, six screws in M-520) located on front panel beneath meter bridge, then tilt the rear panel by pushing back meter bridge, so you will see these switches. (See photograph below.)

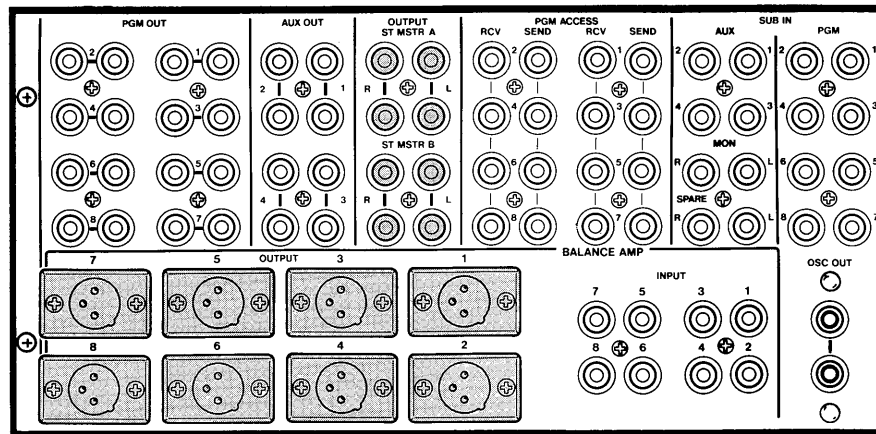
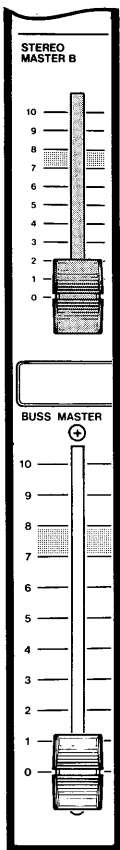
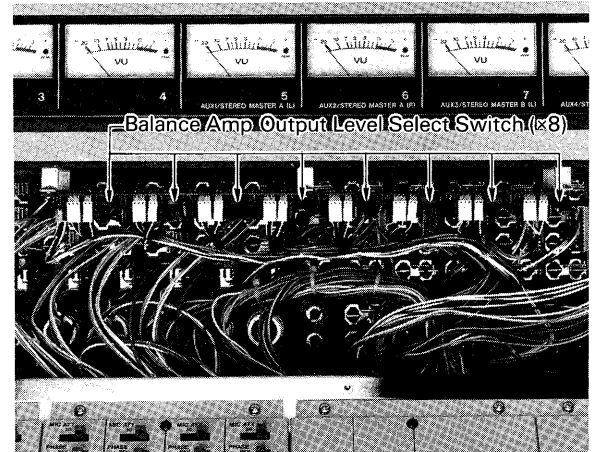

TALKBACK SECTION

49. Talkback Mic

A talkback mic is built-in, and the switches and volume controls that follow will assign it to several outputs.

50. Slate Volume Control

Controls the level of the Talkback Mic to the BUSS, AUX 1/2, and AUX 3/4 assign switches in the SLATE/TEST TONE select switch rack.

51. Slate/ (OFF)/Test Tone Switch

This switch has three positions and affects the output from the test tone oscillator and talkback mic.

a. Set left – SLATE

The talkback mic is now made available to the BUSS, AUX 1/2 and AUX 3/4 switches in the SLATE/TEST TONE select switch rack. The test tone oscillator output is not available.

b. Set Center – (OFF)

Both the talkback mic and test tone oscillator output are not available.

c. Set Right – TEST TONE

Output from the test tone oscillator is now made available to the OSC OUTs on the rear panel and SLATE/TEST TONE select switch rack.

52. Talkback Volume Control

Controls the level of the talkback mic exclusively to the T/B (Talkback) switch in the SLATE/TEST TONE select switch rack.

53. Test Tone Signal Select Switch

This three position switch will select the following frequencies:

a. Set Left – 40 Hz

This tone is useful for high speed search.

b. Set Center – 1k Hz (1000 Hz)

The basic set-up frequency, and the only correct one for aligning a dbx* unit without causing action of the noise reduction circuit.

c. Set Right – 10k Hz (10,000 Hz)

This is the standard alignment frequency that you should put on your masters if you are planning on making records. Thirty seconds of this frequency will allow the cutting room engineer to align the master recorder's playback azimuth to the same standard as your master machine, and you will retain good high frequency performance.

*dbx is the registered trademark of dbx Inc.

54. Slate/Test Tone Select Switch Rack

There are four switches in the rack.

a. BUSS Switch

When depressed, if the TEST TONE/ (OFF)/SLATE switch is in the SLATE position, signal from the built-in talkback mic will be made available to all eight BUSS (PGM) OUTs. And if the TEST TONE/ (OFF)/SLATE switch is in the TEST TONE position, output from the test tone oscillator will then be presented to all eight BUSS (PGM) OUTs and meter circuit for system calibration and tone-stripping your tapes.

b. AUX 1/2 switch

When depressed, if the TEST TONE/ (OFF)/SLATE switch is in the SLATE position, signal from the built-in talkback mic will be made available to the AUX 1, 2 OUTs. And if the TEST TONE/ (OFF)/SLATE switch is in the TEST TONE position, output from the test tone oscillator will then be presented to the AUX 1, 2 circuit.

c. AUX 3/4 switch

When depressed, if the TEST TONE/ (OFF)/SLATE switch is in the SLATE position, signal from the built-in talkback mic will be made available to the AUX 3, 4 OUTs. And if the TEST TONE/ (OFF)/SLATE switch is in the TEST TONE position, output from the test tone oscillator will then be presented to the AUX 3, 4 circuit.

d. TALKBACK Switch

When depressed, the Talkback Mic is assigned to the ST MSTR B OUTPUTs L&R.

55. OSC Out RCA Jacks

This paralleled output allows access to the TEST TONE signal so it can be patched as required when the TEST TONE/ (OFF)/SLATE switch is in the TEST TONE position.

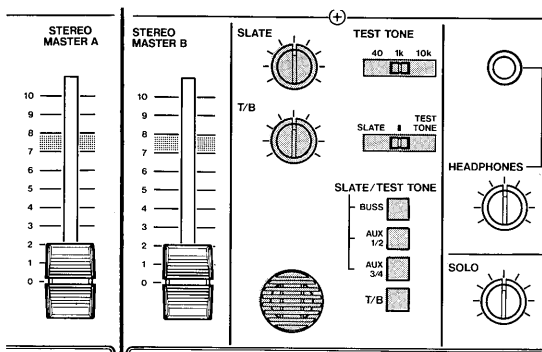

We have now reviewed and described every control and control route on the console. In the next section of this manual, you will find some suggestions for basic system layouts that make use of the controls.

PATCH INTRO

The standard patching setups described here are provided with the hope that they will stimulate your imagination when you have mixing needs that cannot be solved with a standard setup. Line level is line level, whatever the source, and the many line level inputs on the console can offer solutions to your specific problems that we have not addressed directly with a dedicated top panel control or subsystem. Patching should be used to optimize the quality of your signal by bypassing unneeded controls or by making additional control possible.

Most people tend to look for permanent connections in order to reduce complex patching logic to something that can be dealt with "under pressure." It is true that the logic of the control functions on the top panel takes some time to become familiar with, but multi-channel production has many mixing requirements. A *permanent patch* will severely restrict flexibility. If you can learn to examine the system with re-patching in mind, you can achieve significant improvements in system performance. For this reason, we suggest that you plan on access to the back panel of the mixer. Don't set up your system in such a way that you "hide all that mess" and have no access to the back panel. Leave yourself room to get at all the connectors. You will need all the options you can get.

After you have made several patches you may find that the top panel labels are no longer correct, and so we strongly suggest that you take the time to re-label each control to correspond to the new function that your re-patch is controlling. Drafting tape labels applied to each control or group will prevent accidents from happening because you have tried to operate the mixer "normally."

It is also wise to label both ends of every cable. When repatching away from "normal", a label will save endless tracing and re-tracing of the wiring.

In all patching and connecting of two-wire single ended circuits, some basic rules are worth mentioning:

1. Keep your cable runs *SHORT!* – as short as possible.

Installing a patch bay behind the engineers chair will require at least 20 foot runs out and back and is not recommended. Mounting the patch bay on the left or right side of your mixer will allow much shorter runs, and wisest of all is to use our PB-64 Patch Bay

accessory mounted on top of the meter bridge itself. This location will permit the use of the shortest lengths of cable, and will improve your sound. Incidentally, short runs cost less so you will save money as well.

The use of "professional" 3-conductor cable such as Belden 8451 should be avoided. Even though it is of excellent quality, it is not the right idea for 2-wire transformerless systems. If you are going to make up your own cables, we would suggest that you consider TASCAM low loss professional audio cable in the 500 foot rolls, or, cable such as Belden 8218. Solid core insulation and low capacitance are the important considerations in the 2-wire system. Some low capacitance cable uses soft foam insulation and is also not recommended as the center conductor will cut through the soft foam with time and the cable will short circuit. Don't use it.

TASCAM low loss, professional audio cable has less than 15 pF per foot of capacitance and uses a very durable material for its insulator. In the "made up" lengths we offer, the connector is a heavy duty RCA jack made of steel that will stand up to the demands of constant patching and re-patching without breaking down.

2. Multiple output connections always require impedance matching calculations. Make sure you are not asking too much of your output stages. Permanently connecting several cables to a single output may produce poor quality. Be certain that a multiple connection is well within safe limits. Use the section on impedance calculations in this manual, abide by the rules for 2-wire circuits we have discussed, and you will get better results.
3. Using a "Y" cable to "sum" or join two outputs in order to feed one input *WILL NOT BE POSSIBLE*. Since there is no "one way" sign on a wire, signal from one side of the "Y" will flow back into the other side as well as on to the input of the next device. Summing, or adding two signals together requires that they be properly isolated. A simple joining together of the "hot" leads will not work.

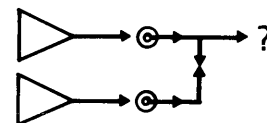

Look's OK ... but circuits are output to output. No good.

We recognize the fact that with a patchable system, accidents will occur. We have built protection circuits in to insure that a momentary mis-connection will not cause instant failure, but – just because it seems to function when you try it for a moment or two, don't assume that it will work forever. Sooner or later it *WILL* fail (2 to 3 minutes) and it is definitely not a usable method of expanding mixer flexibility. When using the STEREO HEADPHONE circuit on the console, a similar caution applies. The use of *MONO* headphones will cause circuit failure. If your "phones" have this connector, *don't* use them.



(1/4" phone 2 section connector)

The "sleeve" of the 2 section plug will connect both sides of the stereo headphone amplifier together in the "head to head" mode. To avoid this, you must have *THREE* bands on the plug. It is also a good idea to check the wiring to make sure that the three sections are actually wired individually. Look for this discrete configuration when you unscrew the protective cover on the connector.

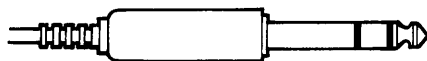

(1/4" phone 3 section connector)

RECOMMENDED 8 TRACK BASIC PATCH

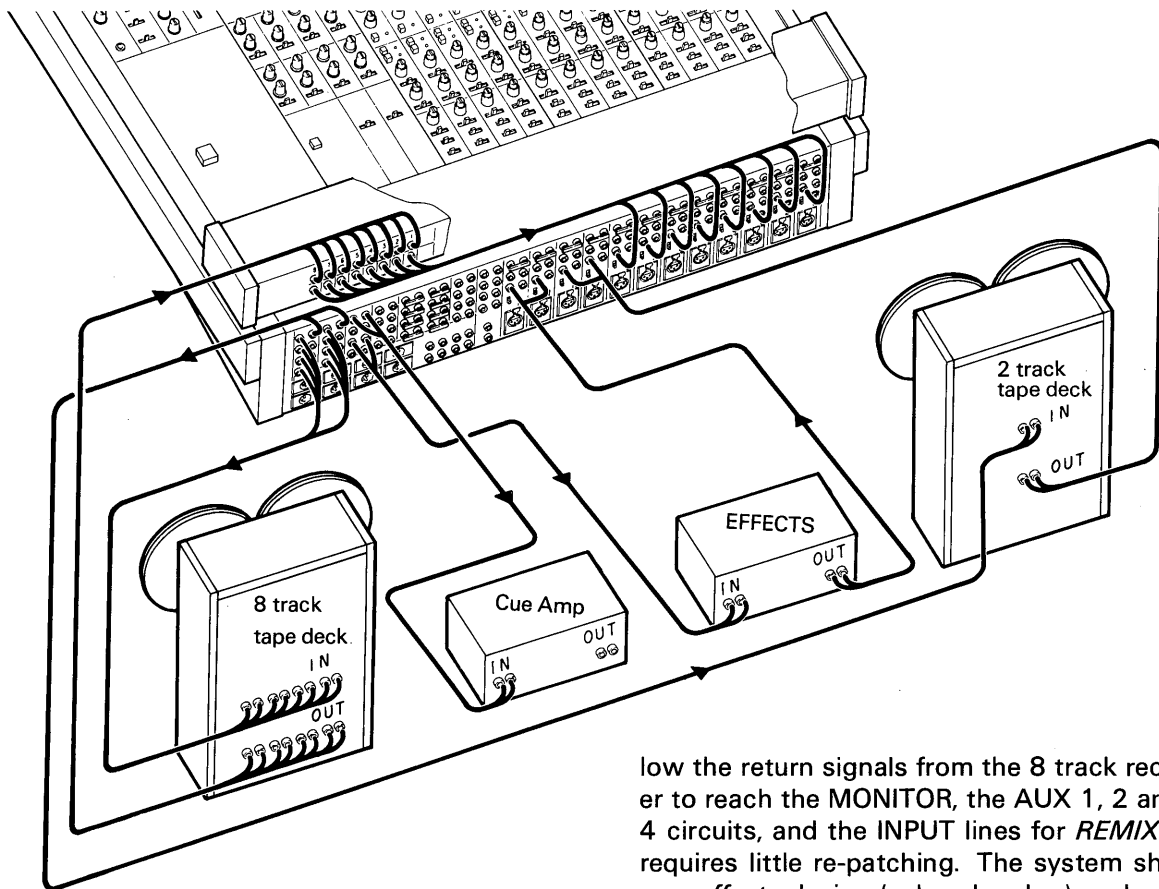

This patch makes use of the multiple function TAPE IN on *Input Channels* 1 through 8 to al-

low the return signals from the 8 track recorder to reach the MONITOR, the AUX 1, 2 and 3, 4 circuits, and the INPUT lines for *REMIX* and requires little re-patching. The system shows one *effects* device (echo chamber) and one 2 track recorder, and is the basic system most applications will require for 8 track production.

EXPANDING SECONDARY FUNCTIONS WITH THE MODEL 1

Although the console has four separate mono AUX circuits, there are times in multitrack production when another separate stereo mix may be required in addition to the AUX mixes. Here, we show the location of the available outputs that can be used to feed an *accessory mixer* from the M-512 or M-520, and the possible uses for which each patch point is best

suited. For each application, we suggest a method of return to the appropriate "mix" so the expansion can be included in the process. First, let's examine the back panel of the M-1, so you can understand the "pass through" method that allows the use of the signal in more than one M-1, or to continue an important feed to a second location.

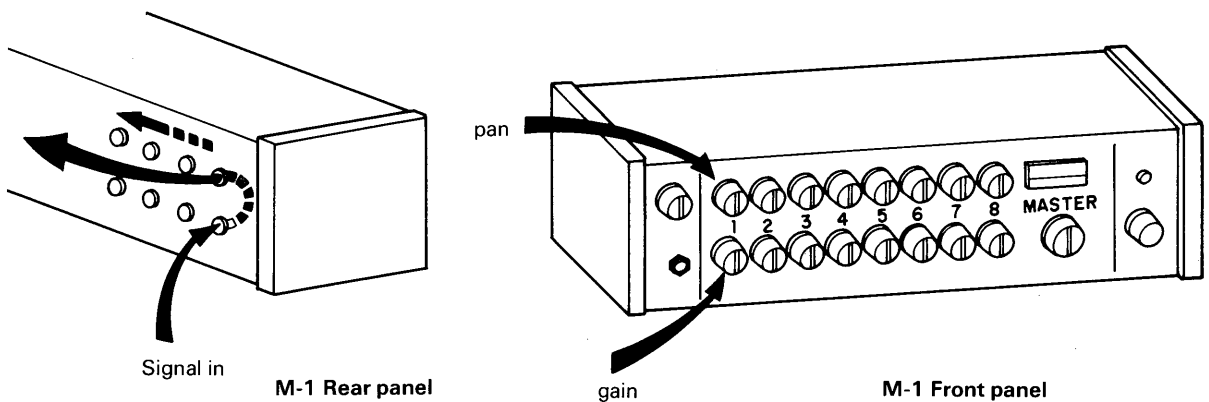

On the back panel of the M-512 or M-520 there are three places that allow the addition of M-1s and each jack can drive two without loss of signal quality.

To monitor these mixes, we connect the M-1 outputs to the SPARE SUB IN on the console that can be assigned to the MONITOR. This connection will allow you to hear what signal balance is present in this mix *before* it is sent to the effect.

1. Direct Out

This source of signal is *POST* fader and EQ. The M-1 will allow you to use *all four AUX* mixes.

DIRECT OUT
as source
allows further
use of unmixed signal

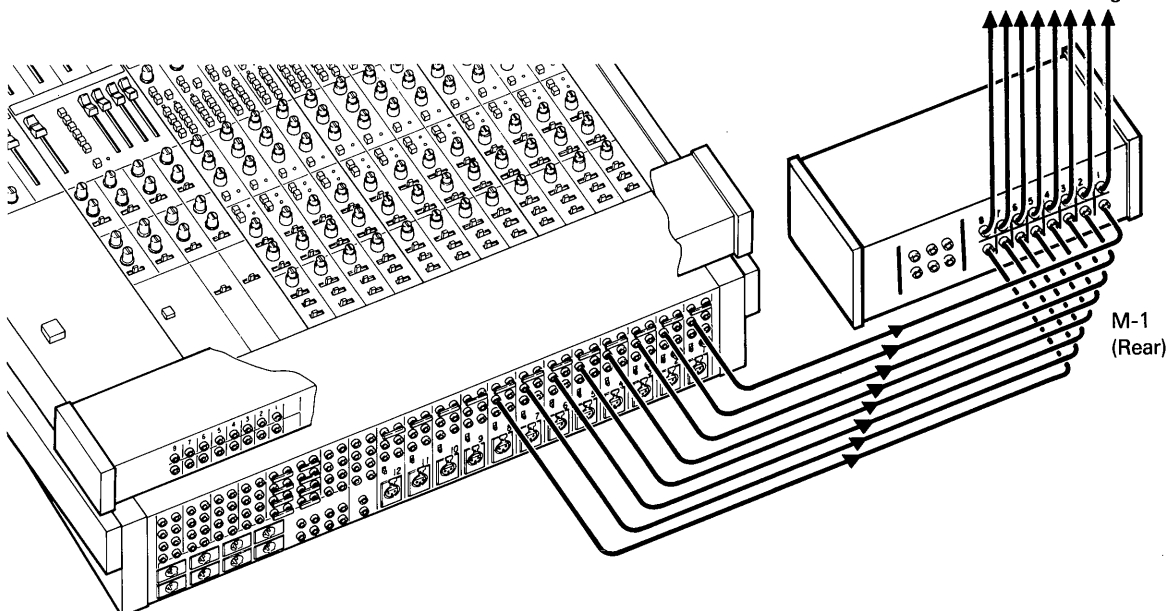

2. Extra ACCESS SEND (I; Pre Out)

Using this connection will provide a second source for pre-fader signals. A possible use for these connections might be this: because the AUX 1, 2 and 3, 4 systems may be needed to CUE tape returns in 8 track production, a CUE of MIC signals in these *Input Channels* will not

be available. Adding a M-1 via this output will give you 8 x 2 submix to add to the AUX buss that has the CUE system job.

Use the AUX SUB IN patch point to add the M-1.

To add the M-1 to your AUX Buss CUE system, simply patch into that AUX SUB inputs.

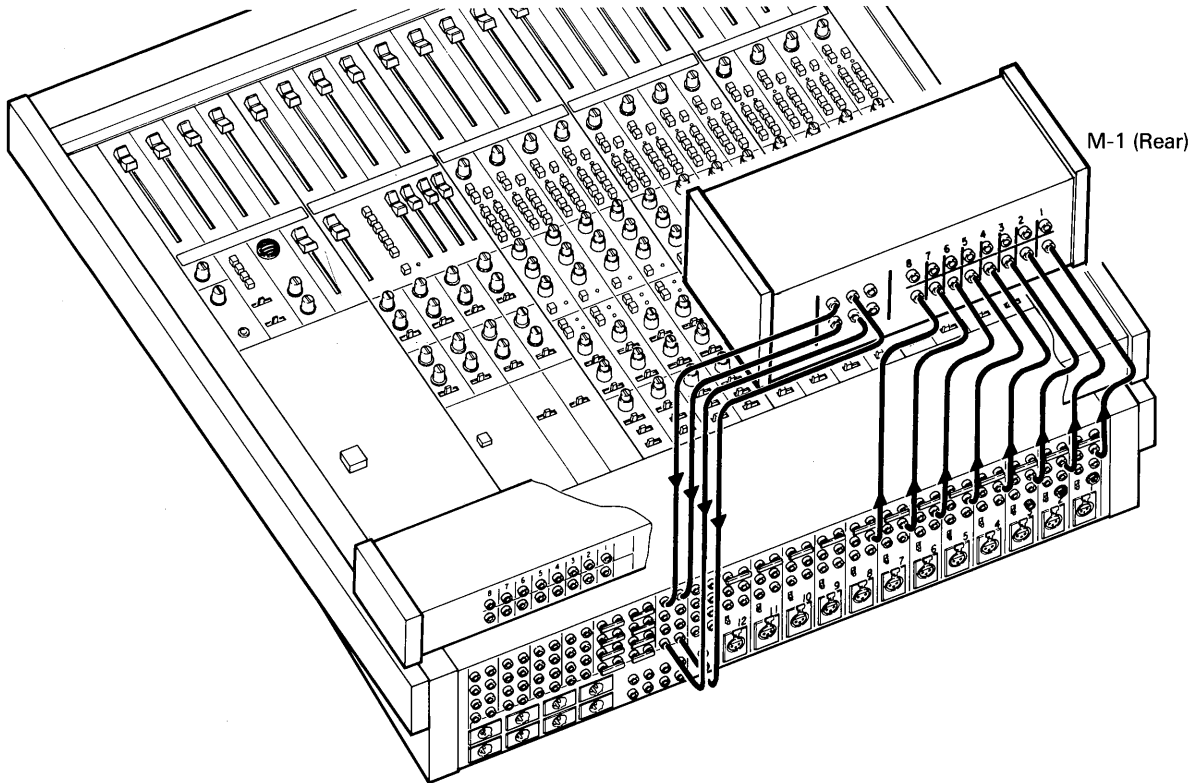

3. ACCESS SEND/RCV

This point is usable as an additional patch for a Model 1 if the "pass through" style of connection is used, but since it is the same signal point as the ACCESS SEND (I), we suggest

that you use this extra one instead. If your requirements for extra subsystems exceed the two per output that we consider safe, then use this patch to safely expand your subsystems.

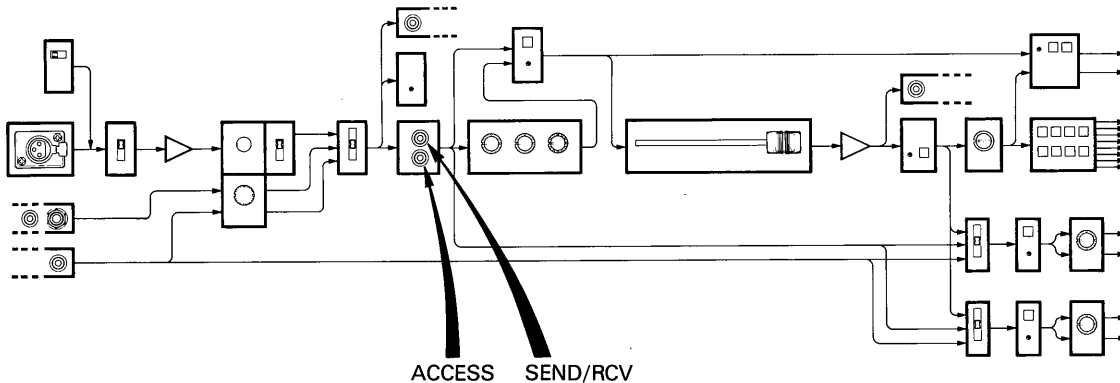

4. Expanding the 2 Track Return Inputs

Occasions may arise where the switch selection of this pair of *Input Channels* needs to accept more inputs than the possibilities we provide. Connect a Model 1 to the TAPE INs and

then you will be able to select 4 possible stereo sources instead of one. Route them to the busses for recording or to the MONITOR for listening.

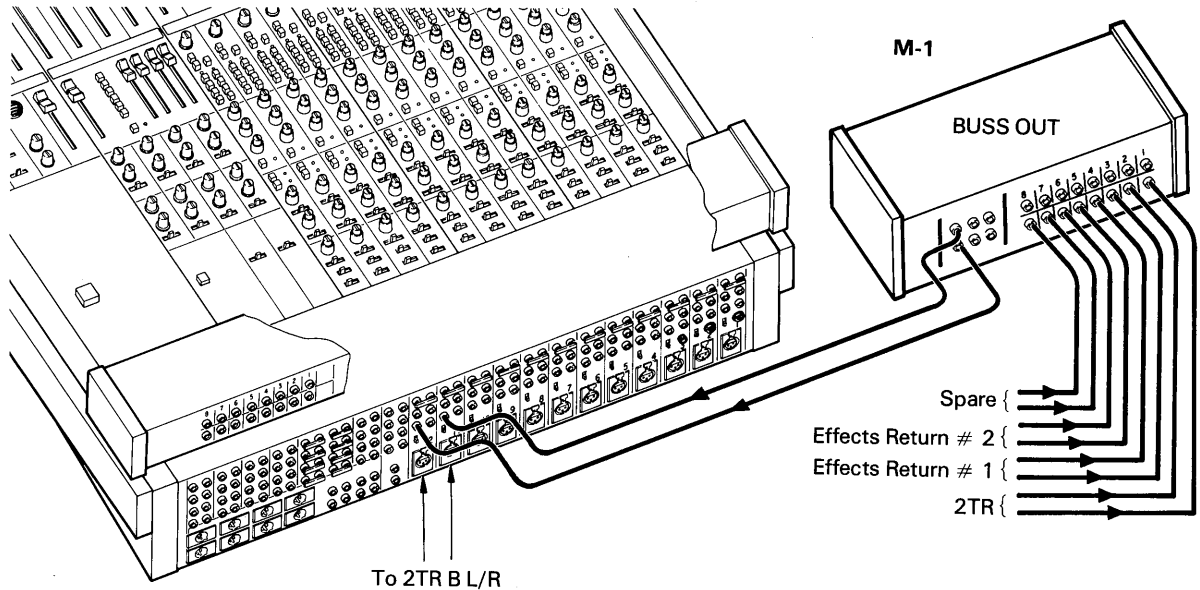

MINIMUM LOSS PATCH FOR MAXIMUM QUALITY IN MIXDOWN

Since *ALL* the line level controls on the *Input Channels* appear after the ACCESS SEND/RCV jacks, the ACCESS RCV jacks may be used as a line level input in order to bypass the first amplifier in the console. Bypassing amps wherever possible improves signal quality. The functions lost are the OVERLOAD indicator, use of the TRIM. Most of these functions may not be needed in mixdown, but if you con-

sider PREFADER a necessary part of your mix, use a "Y" adapter and plug in one section to ACCESS RCV and the other to TAPE IN, and you will have the benefit of bypassing the input preamplifier without losing any function except the TRIM. With this arrangement, the TRIM will adjust only the TAPE IN signal to the AUX 1, 2 & 3, 4 (signal select switch) systems. This separation may prove useful.

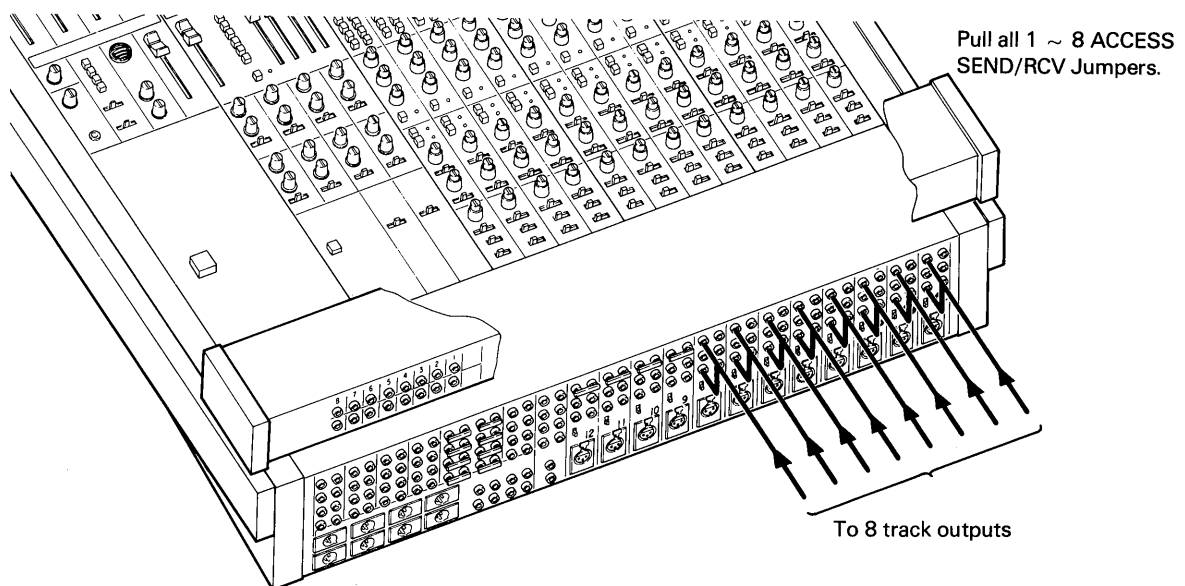

WORKING METHODS FOR THE M-512 OR M-520

Now that we have explained the available input signals, the switches and jacks, we can discuss the jobs.

We assume that any multichannel recorder has only one set of playback outputs. We will have at least three basic jobs to do that will use the playback signal:

1. Simple playback to judge a performance, requiring no corrective EQ. In short, what did you record?
2. Simple playback into a cueing system so partially completed tapes can be finished. This function should somehow combine the playback signals with "new" mic signals so musicians may hear a balance of both when overdubbing.

3. Final remix, when the full control capability of the system (EQ, effects, etc) can be used to "fine tune" the completed multichannel master.

Three basic tasks. One playback tape signal. To avoid resetting all the controls on the *Input Channels* and loosing the EQ and record level settings that have taken much time to get "just right" every time you change from record to play, you use the multi-purpose TAPE INPUTS instead of the LINE INPUTs. A perspective drawing may help you to visualize the routing. We show one channel only so the wiring can be seen clearly.

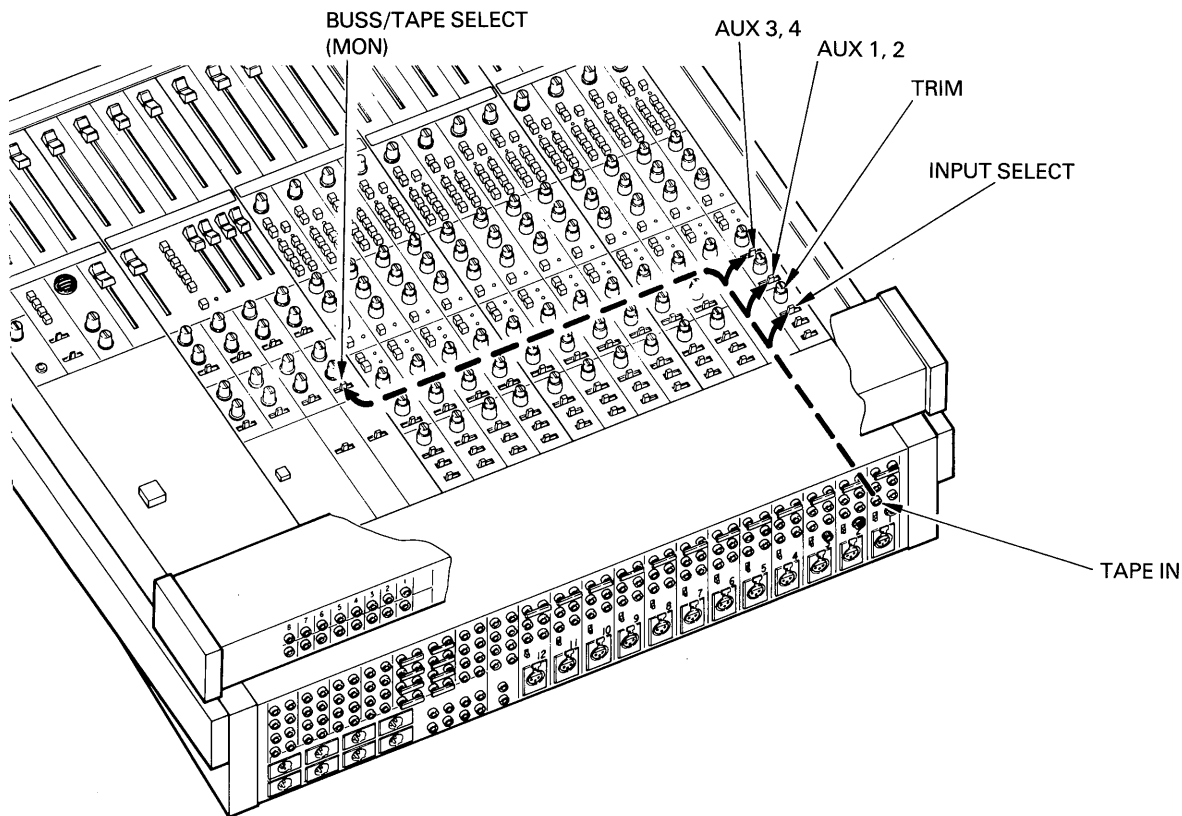

All these "routes" can be active at the same time. The *Block Diagram* shows all four systems. Since the size of the page in this manual forces us to reduce the *Block Diagram* a lot, we suggest that you use this block as an index in order to find the area

we are discussing on the large separated version which will be easier to read.

Now that we have the signal routed to the right places, we'll keep going and use some more drawings to show you the rest of the signal pathway for each job.

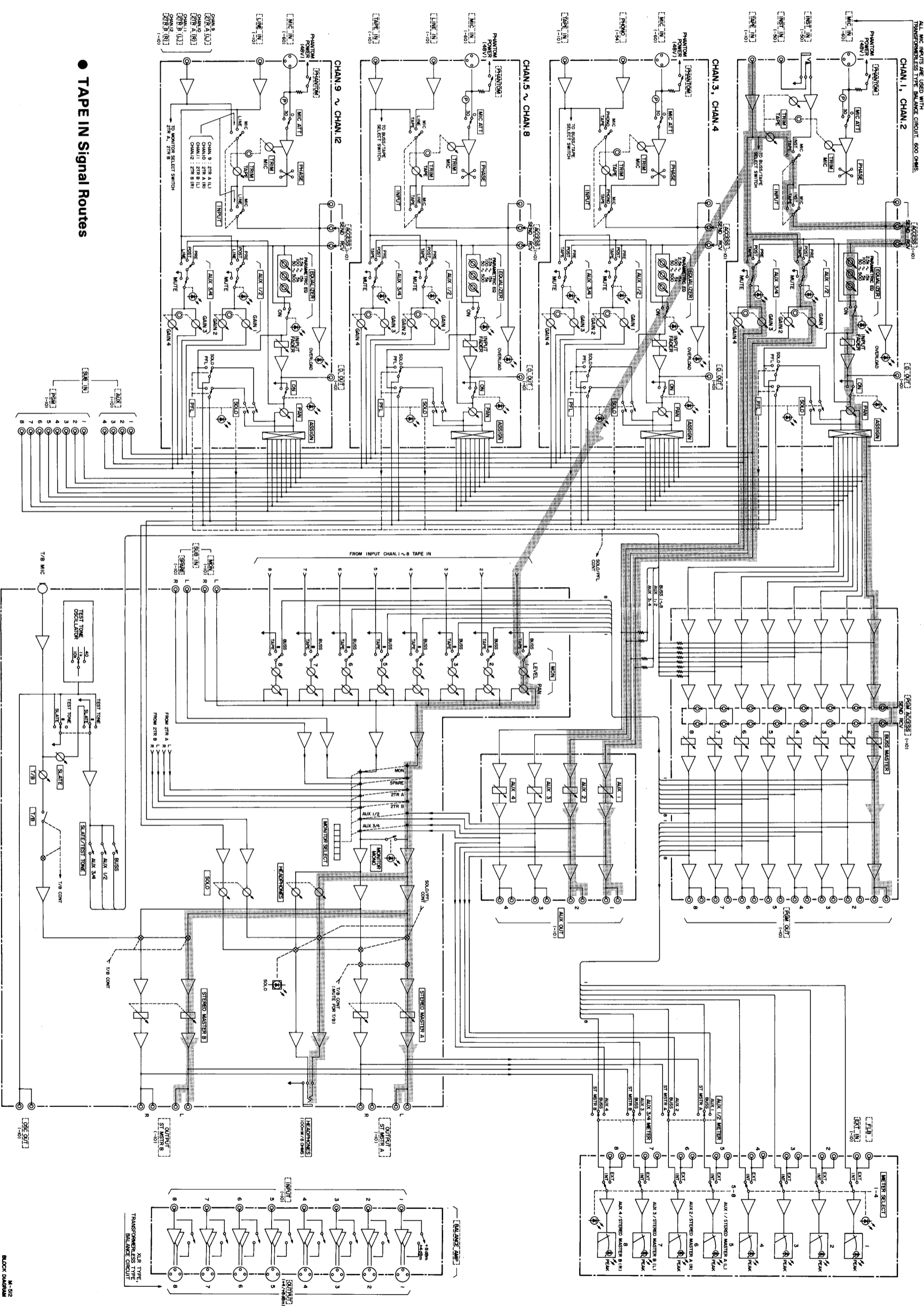

● TAPE IN Signal Routes

Play the tape of the 1 kHz tone and adjust the TAPE TRIM controls for a "0" reading on the console meters. Your mixer and recorder are now calibrated so you can make all subsequent record level adjustments from the mixer. The term "dBV", by international agreement, refers to 1 volt. Therefore, 0 dBV = 1 volt. The console and all other TASCAM mixers and recorders reference dBV to 1 V with -10 dBV (0.316 V) corresponding to a TASCAM meter reading of 0VU. If the equipment you are using references dB to 0.775 V rather than 1 V (i.e., 0 dBu or 0 dBm in a 600 ohm circuit), a correction factor of +2.2 dB (or VU) will have to be used to compensate for the difference; i.e. 0 dBV (TASCAM +10 VU) = 1.0 volt = +2.2 dBu, or, -10 dBV (TASCAM 0 VU) = 0.316 V = -7.8 dBu.

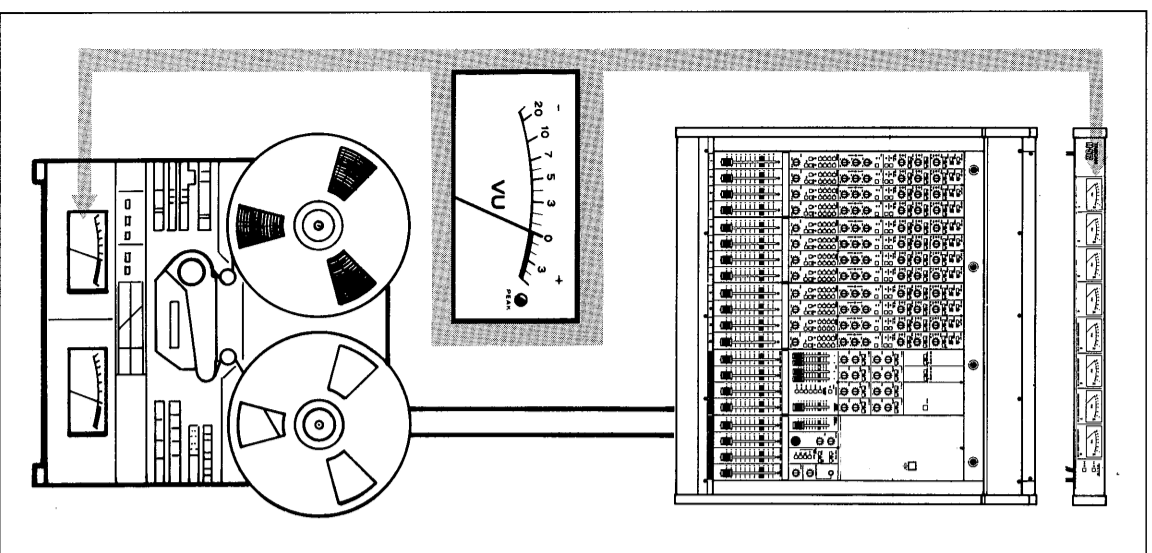

REMIX (Tape)

When an INPUT select switch (on any but the last 4 channels) is set to its rightmost position (TAPE), the channel's TAPE IN jack provides the mixer's full control capability (EQ, effects, mixing, etc.) for final *Remix* or fine tuning of the output of the corresponding track of the multichannel recorder. Lets assume you have plugged the recorder's outputs into correspondingly numbered console input channels 1 - 4 would be switched to TAPE for a 4-track tape, or channels 1 - 8 for an 8-track tape. In the M-520, channels 1 - 16 would be switched to TAPE for a 16-track tape.

Selecting *Tape* will not disable the functions of cue and monitor that we have discussed in the two prior sections. TAPE IN signal will be available to the AUX 1 through 4 mixes, the MONITOR mix and input channel EQ/PAN/BUSS ASSIGN function at the same time. There are several advantages offered by this multiple feed that are added to the necessary cue and monitor functions. With *Tape* selected, the cue function is not needed, so those AUX mixes can be used instead as an extra effects send.

During the course of normal multitrack production, a good "take" may be acceptable in every way except one: some doubt may arise as to the "mixability" of one track.

Since the *Remix* function may be selected one channel at a time, a single track may be routed through the EQ section and a correction tried out to make sure that re-recording is not required. This checkout will only require the readjustment of one channel. Many other consoles force you to switch the whole system to *Remix* just to check one channel.

Effects Return Method

Use the *Input Channels* that don't have mics plugged in. Much of multitrack production is done on a "one mic per track" basis and will leave you with unused *Input Channels*. You can take advantage of the functions that they provide to do things to the return signal. Separate EQ can be used to improve the "sound" of the effect. The AUX 1 through 4 outputs can be used to feed one device per jack and the remaining "spare" *Input Channels* (whose quantity depends on the number of tracks in the recorder and whether you have the M-512 or M-520 console) can be used to independently control the selection and balance of each signal returned. This method is not restricted to the "one mic per track" jobs. Even *stereo* returns, is possible.

This approach works because there should always be at least 4 "unused" channels (assuming an 8-track recorder with the M-512 or a 16-track with the M-520 console); there may be as many as 16 "unused" channels if a 4-track recorder is used with the M-520.

A Caution

These complex patches can lead to a circular assignment, or *FEEDBACK LOOP*. To use these setups successfully, the AUX MUTE on the "effects return" *Input Channels* should be depressed (muted), or, the AUX 1, 2 & 3, 4 signal select switches on the "effects return" *Input Channels* must not be set to PRE or POST. Make sure that you don't assign the processed signal return *BACK OUT TO THE EFFECTS DEVICE* by accident.

A Word or Two of Reality

The first time user may say, at this point, that these "extras" are so *hard to grasp* that the benefits are not worth the risks ... or the effort. The M-512 and M-520 are new. There are what seem like a thousand knobs, and the manual, at first, seems to be describing logics that are so sophisticated that they only make sense to a "pro" 20 year's experience.

WE AGREE! These mix patches are complex and their routing is not easy to visualize. We will not insult your intelligence by saying otherwise. The M-512 and M-520 are Tools, not a toys. Like any good tool, good results depend on practice and understanding. You will find a use for the more "deluxe patches" when your art is in need of the control that they can provide.

Using Two Channels For More EQ

Because of the adjustable frequency point provided by a sweep control, the use of more than one *Input Channel* on a single sound offers a benefit that is not possible with a "set" point equalizer. On difficult signals such as electric bass or voice work in commercials or sound tracks, you can set the lower section of each dual concentric (frequency select point) to a different point in the frequency range and get six *different* boost or cut points instead of just an increase in the amount of adjustment. Here's how.

Patch from the DIRECT OUT of one channel to the spare LINE IN of an unused channel and then use the assign buttons or the DIRECT OUT on the second (final) channel to go on.

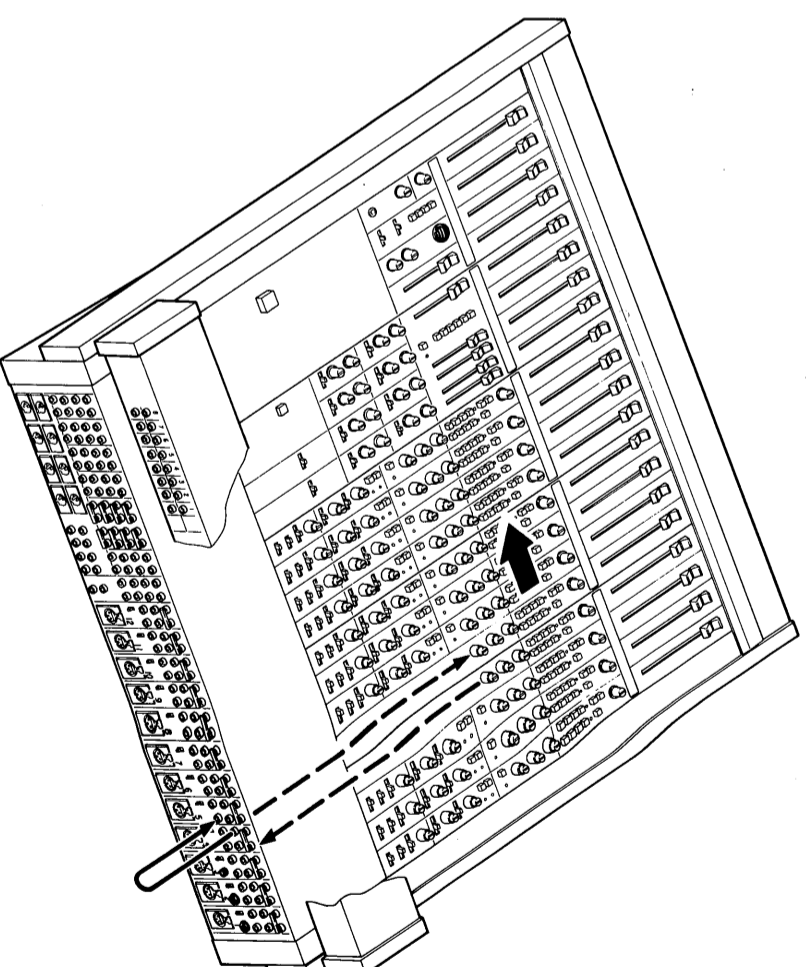

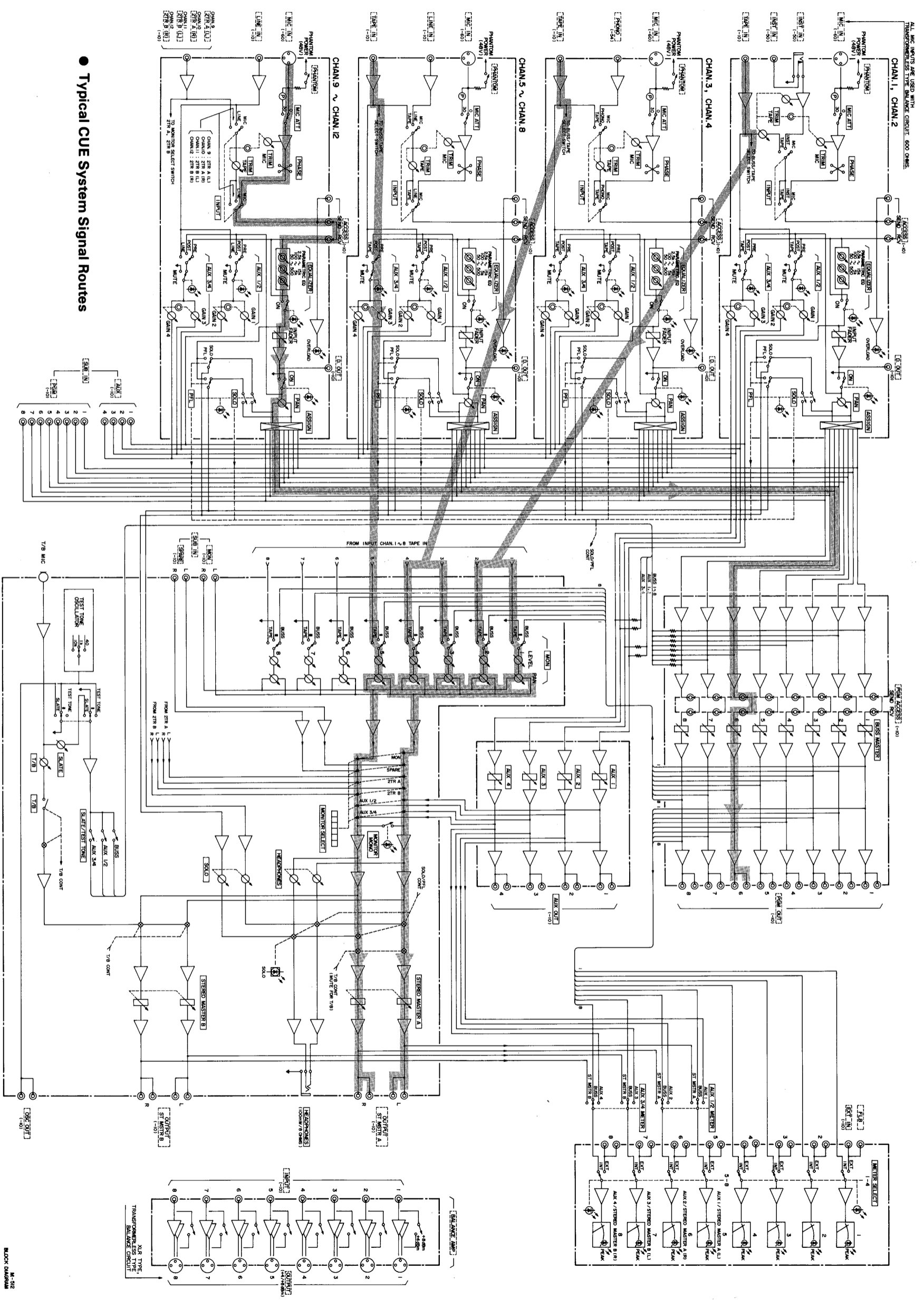

● Typical CUE System Signal Routes

M-52
BLACK OAKSOUND

Pre & Post EQ When Using A Limiter

Many engineers like to EQ the low end before limiting to help avoid excessive "pumping" of the signal. If this is what you want to do, and, you have another channel free, do this: Take the DIRECT OUT from the first *Input Channel*, go to the limiter, use the first channel for your send, and *Don't Assign The First Channel To Any Output!*

It is not going to have all of your signal control modifications and will not be limited. To reach a BUSS, patch from the limiter out to the second *Input Channel's* ACCESS RCV jack. Now you can set the limiter input level with the first channel's TRIM and fader, do part of your EQ, and run your final signal with the second channel's fader. You will have EQ available both before and after the limiter with the minimum of electronic stages. This "patch" is also recommended when pre & post EQ are desired for use with any signal processing unit and will also give you "double EQ" using the smallest possible electronic package for those stubborn processing jobs that only brute force will fix.

A Final Word of Mixdown Advice:

All finished tapes must be balanced – one sound and its tone judged by blending with others. Don't depend on EQ in "solo" to set up a "perfect" tone, because the minute you add your perfect sound back to the "mix" the tone may not be so "perfect". Always try to get the levels as close to "right" as possible before using EQ. If the mix is close, you will know which tracks need fine EQ tuning to be heard. Less EQ means less distortion and full boost at 5K on every pot will also boost the noise in your mix as well as the signal.

1. If your console faders always wind up like this, you are likely to be over-loading your summing amps. Pull down the inputs and raise the master.

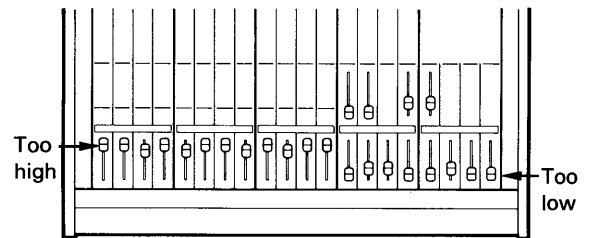

2. Conversely, if this is what you usually have, you are getting too much gain from your master. Your mix is clean, but noisy.

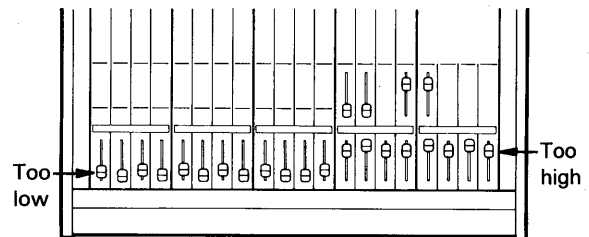

3. This picture is a reasonable compromise, and is probably better all around.

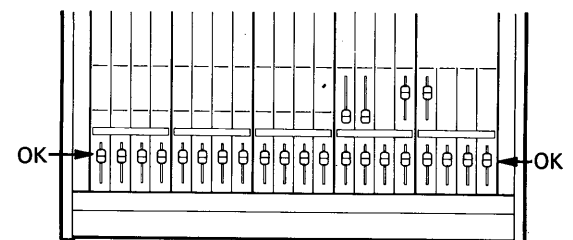

THE DB; WHO, WHAT, WHY

No matter what happens to the signal while it is being processed, it will eventually be heard once again by a human ear. So the process of converting a sound to an electrical quantity and back to sound again must follow the logic of human hearing.

The first group of scientists and engineers to deal with the problems of understanding how the ear works were telephone company researchers, and the results of their investigations form the foundation of all the measurement systems we use in audio today. The folks at Bell Laboratories get the credit for finding out how we judge sound power, how quiet a sound an average person can hear, and almost all of the many other details about sound you must know before you can work with it successfully.

From this basic research, Bell Labs developed a system of units that could be applied to all phases of the system. Sound traveling on wires as electrical energy, sound on tape as magnetic energy, sound in air; anyplace that sound is, or has been stored as energy until some future time when it will again be sound, can be described by using the human ear-related system of numbers called "bels" in honor of Alexander Graham Bell, the inventor of the telephone.

What is a bel and what does it stand for?

It means, very simply, twice as loud to the human ear. Twice as loud as what? An obvious question. The bel is always a comparison between two things. No matter what system of units of measure you are working with at the time, you must always state a value as a reference before you can compare another value to it by using bels, volts, dynes, webers - it doesn't matter, a bel, or ear-related statement of "twice as loud" is always a ratio, not an absolute number. Unless a zero, or "no difference" point is placed somewhere, no comparison is possible.

There are many positive and definite statements of reference in use today. But before we go over them, we should divide the "bel" into smaller units. "Twice as loud" will be a little crude to be used all the time. How about one tenth of a bel? Okay, the decibel it is, and 0 means "no difference, same as the reference".

It seldom means "nothing". Now, if you double the power, is that twice as loud? No, it is only 3 dB more sound. If you double an electrical voltage, is it twice as loud? No, it is only 6 dB more sound. The unit quantities must follow nonlinear progressions to satisfy the ears' demand.

Remember, decibels follow the ears. All other quantities of measure must be increased in whatever units necessary to satisfy the human requirements, and may not be easy to visualize. Sound in air, our beginning reference, is the least sound the human ear (young men) can detect at 1000 to 4000 Hz. Bell Labs measured this value to be .0002 microbar, so we say 0 dB = .0002 microbars and work our way up from the bottom, or "no perceivable sound to humans" point. Here is a chart of sounds and their ratings in dB, using .0002 microbar pressure change in air as our reference for 0 dB spl (Sound Pressure Level).

Sound and Music Reference

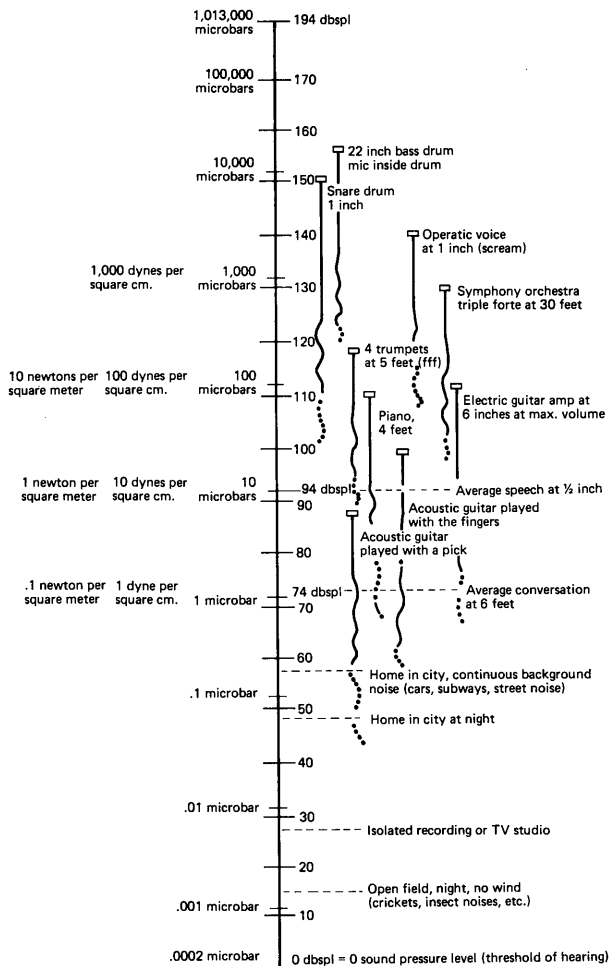

Since the reference is assumed to be the lowest possible audible value, dB spl is almost always positive, and correctly written should have a + sign in front of the number. But it is frequently omitted. Negative dB spl would indicate so low an energy value as to be of interest to a scientist trying to record one cricket at 1,000 yds. distance, and is of no significance to the multichannel recordist. Far more to the point is the question "What is a microbar?" It is a unit of measurement related to atmospheric pressure and although it is extremely small, it must be divided down quite a lot before it will indicate the minimum pressure change in air that we consider minimum audible sound. This will give you a better idea of the sensitivity of the human ear.

One whole atmosphere, 14.70 pounds per square inch, equals 1.01325 bars. So one whole atmosphere in microbars comes out to be 1,013,250. One microbar of pressure change is slightly less than one millionth of an atmosphere, and you can find it on our chart as 74 dB spl. It is not terribly loud, but it is certainly not hard to hear. As a matter of fact, it represents the average power of conversational speech at 6 feet. This level is also used by the phone company to define normal earpiece volume on a standard telephone. Now think about that minimum audible threshold again:

0.0002 microbar.

That's two ten thousandths of a millionth part of one atmosphere!

This breakdown of one reference is not given just to amaze you, or even to provide a feel for the quantity of power that moderate levels of sound represent. Rather it is intended to explain the reason we are saddled with a ratio/logarithm measurement system for audio. Adding and subtracting multi-digit numbers might be easy in this age of pocket calculators, but in the 1920's when the phone company began its research into sound and the human ear, a more easily handled system of numbers became an absolute necessity. Convenience for the scientist and practical engineer, however, has left us with a system that requires a great deal of complex explanation before you can read and correctly interpret a "spec sheet" for almost any piece of gear.

Here are the formulae for unit increment, but they are necessary only for designers. And unless you build your own gear, you won't have to deal with them. For power (watts) increase or loss, calculate by the following equation:

$$10 \text{ LOG}_{10} \frac{P2}{P1} = N \text{ (dB)}$$

For voltage, current or pressure calculations:

$$20 \text{ LOG}_{10} \frac{V2}{V1} = N \text{ (dB)}$$

Once we have this chart, we can see the difference between the way humans perceive sound and the amount of force it takes to change air pressure. Unfortunately, the result is not a simple "twice as much pressure" of sound to be heard as "twice as loud". If you plot decibels as the even divisions on a graph, the unit increase you need is a very funny curve.

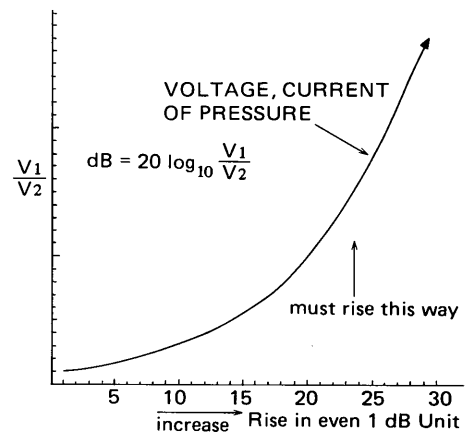

This is how the ear works, and we must adapt our system to it. We have no choice if we expect our loudspeaker to produce a sound that resembles the original sound we begin with. The high sensitivity to sound of the human ear produces a strong "energy" illusion that has confused listeners since early times. How powerful are the loudest sounds of music in real power? Can sound be used as a source of energy to do useful work, such as operating a car? For any normally "loud" sound, the answer is, regrettably, no! Perhaps not so regrettably, consider what would happen if one pound of pressure was applied not to your head, but directly to your inner ear. One pound of air pressure variation is 170 dB spl! This amount of "power" might do some useful work – but not much, it's still only one pound and to

make use of it you will have to stand one mile away or you will go deaf immediately.

If we reduce our sound power to realistic musical values, we will not be injured, but we will have almost nothing (in real power terms) to run the mic with! This low available energy is the reason that high gain amplifiers are required for microphones.

When we take a microphone and "pick up" the sound, we do have some leeway in deciding how much energy we must have in order to operate the electrical part of our system. If we can decide that we don't have to truly hear the signal while we are processing it from point to point and we can wait until the electronic devices have done all their routing and switching before we need audible sound, we can lower the power of the signal. What is a good value for a reference here? Well, we need to have enough energy so that the signal is not obscured by hiss, hum, buzz or other unpleasant things we don't want, but not so high that it costs a fortune in "juice" or electrical power. This was a big consideration for the telephone company.

They now have the world's biggest audio mixing system, and even when they started out, electricity was not free. They set their electrical power signal reference as low as was practical at the time, and it has lowered over the years as electronic equipment has gotten better. In 1939 the telephone company, radio broadcasting, and recording industry got together and standardized 1 milliwatt of power as 0 dBm, and this is still the standard of related industries. Thus, a 0 dBm signal at a 600 ohm line impedance will present a voltage of 0.775 volts.

Once again, we owe you an explanation. Why does it say *ZERO* on the meter? What is an ohm? Why 600 of them and not some other value? What's a volt? Let's look at one thing at a time.

1. The logic of *ZERO* on the meter is another hangover from the telephone company practice. When you start a phone call in California, the significant information to a telephone company technician in Boston is - did the signal level drop? If so, how much? When the meter says *ZERO* it indicates

(to the phone company) that there has been no loss in the transmission, and all is well. The reference level is one milli-watt of power, but the gain or loss is in the information the meter was supposed to display, so the logic of *ZERO* made good sense, and that's what they put on the dial. We still use it even though it's not logical for anything else, and the idea of a reference level described as a "no loss" *ZERO*, no matter what actual power is being measured is so firmly set in the minds of everyone in the audio world that it is probably never going to change.

2. One ohm is a unit of resistance to the passage of electrical energy. The exact reasons for the choice of 600 ohms as a standard are connected to the demands of the circuits used for long distance transmission and are not simple or easy to explain. Suffice it to say that the worst possible thing you can do to a piece of electronic equipment is to lower the resistance it is expected to work into (the load). The lower the number of ohms, the harder it is to design a stable circuit. When you think about "load", the truth is just the opposite of what you might expect! 0 ohms is a "short circuit", no resistance to the passage of signal. If this condition occurs before your signal gets from California to Boston, you won't be able to talk - the circuit didn't "get there", it "shorted out". Once again, telephone company logic has entered the language on a permanent basis. Unless the value for ohms is infinity (no contact, no possible energy flow) you will be better off with a higher value, and many working electronic devices have input numbers in the millions or billions of ohms.

3. A volt is a unit of electrical pressure, and by itself is not enough to describe the electrical power available. To give you an analogy - that may help, you can think of water in a hose. The pressure is not the amount of water, and fast flow will depend upon the size of the hose (impedance or resistance) as well. Increase the size of the pipe (lower the resistance, or *Z*) and pressure (volts) will drop unless you make more water (current) available to keep up the demand. This analogy works fairly well for DC current and voltage, but alternating current asks you to

imagine the water running in and out of the nozzle at whatever frequency your "circuit" is working at, and is harder to use a mental aid. Water has never been known to flow out of a pipe at 10,000 cycles per second.

This reference level for a starting point has been used by radio, television, and many other groups in audio because the telephone company was the largest buyer for audio equipment. Most of the companies that built the gear started out working for the phone company and new audio industries, as they came along, found it economical to use as much of the ready-to-hand stuff as they could, even though they were not routing signals from one end of the world to the other.

Must we use this telephone standard for recording? Its use in audio has been so widespread that many people have assumed that it was the only choice for quality audio. Not so.

A 600 ohm, 3-wire transformer-isolated circuit is a necessity for the telephone company, but the primary reason it is used has nothing to do with audio quality. It is noise, hum and buzz rejection in really long line operation (hundreds and hundreds of miles).

Quality audio does not demand 600 ohm, 3-wire circuitry. In fact, when shielding and isolation are not the major consideration, there are big advantages in using the 2-wire system that go well beyond cost reduction. It is, as a system, inherently capable of much better performance than 3-wire transformer-isolated circuits.

Since TASCAM mixing console is designed to route a signal from a mic to a recorder, we think that the 2-wire system is a wise choice. The internationally accepted standard (IEC) for electronics of this kind uses a voltage reference without specifying the exact load it is expected to drive. The reference is this:

$$0 = 1 \text{ volt}$$

This is now the preferred reference for all electronic work except for the telephone company and some parts of the radio and television business. Long distance electronic transmission still is in need of the 600-ohm standard.

If your test gear has provision for inserting a 600 ohm load, be sure the load is not used when working on TASCAM equipment.

Now that we have given a reference for our "0" point, we can print the funny curve again, with numbers on it, and you can read voltages to go along with the changes in dB.

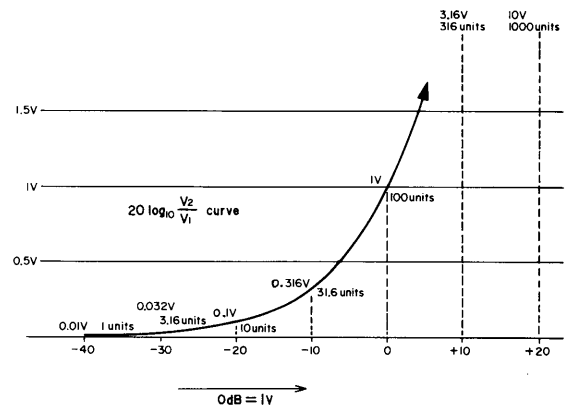

SIMPLIFY THE DB AND ITS MANY VARIATIONS

When it comes to describing the level of audio signal in a circuit, the whole issue of "dB's" may seem very complicated to anyone but a mathematically skilled engineer. However, by comparing audio signals to water flowing through a pipe (a "circuit"), we can simplify the concept of dB and audio level so that it is less "magic" and more understandable (we hope). First, let's define our terms for this comparison:

VOLTAGE:

It is similar to *WATER PRESSURE*. If voltage were truly water pressure, we would express it in pounds per square inch. Actually, another term for voltage is "EMF," which stands for "electromotive force," which really is the pressure on the electrons which causes them to flow through a circuit.

IMPEDANCE:

It is similar to the *RESISTANCE OF THE WATER PIPE TO THE FLOW OF WATER*. Electrically, impedance "impedes" or works against the flow of electrons in an AC circuit, so the restriction to water flow caused by the pipe's diameter and internal surface friction is like impedance. Electrical "resistance," while similar to impedance, applies to DC current. A speaker, for example, may have a 3 ohm DC resistance, but an 8 ohm impedance at 1 kHz.

POWER:

It is similar to the *AMOUNT OF WATER THAT FLOWS THROUGH THE PIPE*. If we were actually measuring water level, we might use a unit of volume such as liters, milliliters, gallons, quarts, ounces, etc. With electrical circuits, we use a unit of power – the watt, 1/1000 watt (the milliwatt).

We can consider the pipe to be the electrical input or output circuit. The pipe's *diameter* determines its *resistance to water flow*; a smaller diameter pipe (wire) has a higher resistance (analogous to impedance) because it makes it more difficult for the water (electrons) to flow.

If we aim the pipe up in the air and measure the height of water column that emerges from the end of the pipe, we have a level (power). With a pipe of a given diameter (impedance), the amount of water flowing is proportional to the water pressure (voltage). If you increase the pressure, you increase the height of the water stream emerging from the pipe.

Look at Figure 1. Note that a 0.775 volt "pump pressure" pushing water through a 600 ohm "pipe" causes the water "level" to reach 1 milliwatt in height. We'll call that level of water (1 milliwatt of power) a level of 0 dBm.

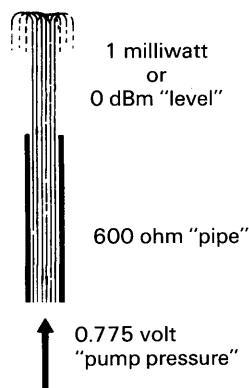

Figure 1.

AN ESSENTIAL POINT TO REMEMBER: 0 dBm IS ALWAYS EQUAL TO ONE MILLIWATT. It doesn't matter how much water pressure (voltage) it took to achieve that level, or what pipe diameter (impedance) the water had to flow through ... if the water level reaches 1 milliwatt, the level is 0 dBm. Any other dBm value is merely a relative power level expressed in reference to the 1 mW level.

Look at Figure 2. Here the same 0.775 volt "pump pressure" is pushing water through a pipe of 1200 ohm impedance. Since less water can flow through the smaller pipe, the water level emerging from the pipe is cut in half: 1/2 milliwatt – half the power. Since, with regard to power, half the level is a decrease of 3 dB, the level is now -3 dBm, not 0 dBm. As you can see, **WHEN YOU INCREASE THE IMPEDANCE WITHOUT CHANGING THE VOLTAGE, YOU GET LESS POWER** (fewer dBm). Conversely, if you decrease the impedance (large pipe), you'll increase the power (more dBm).

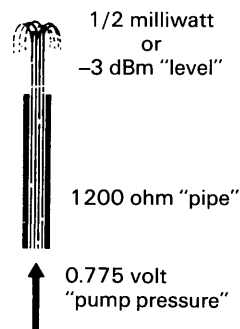

Figure 2.

FORGET THE NOTION THAT dBm REQUIRES A 600 OHM "PIPE". While dBm results from a combination of impedance and voltage, it refers only the end result ... The power (water column height).

Look at Figure 3. Notice that we can obtain a "level" of 0 dBm with a 1200 ohm pipe ... it simply takes more pump pressure than with a 600 ohm pipe. Since we doubled the impedance relative to Figure 1 (from 600 to 1200 ohms), we also have to increase the voltage to 1.1 volts (multiplying 0.775 V by 1.414, which is the square root of 2). The end result is the same, 1 milliwatt of power (water), which is 0 dBm.

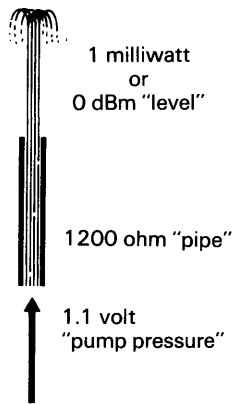

Figure 3.

It should now be clear that defining a level in dBm only defines the *power*. If you want to use dBm to describe a *voltage*, you'll have to specify a particular impedance or resistance (pipe), which is *typically given as 600 ohms, but could be any impedance or resistance. IF YOU HAVE A CIRCUIT WHICH DOES NOT USE MUCH POWER, BUT IS INSTEAD SENSITIVE TO VOLTAGE, EXPRESSING LEVEL IN dBm IS NOT PARTICULARLY USEFUL.* For this reason, other "dB" terms have been devised.

A high impedance input will not draw much power from a circuit unless the voltage is increased to a very high level. Why? Remember that the greater the impedance or resistance (the smaller the pipe), the less current can flow. Today, most mixers, power amplifiers, and other signal processors are no longer designed for 600 ohm input impedance. Instead, they have high impedance inputs which are sensitive to the voltage (pressure) of the input signal, not the power (water level).

When you double the level voltage-wise, you increase it 6 dB, whereas if you double the level power-wise, you increase it by 3 dB. The reason for this apparent discrepancy is not all that complex, but it involves some mathematics that we'll omit here to avoid getting too technical. Suffice it to say that the difference has to do with the fact that power is proportional to voltage squared, and "dB" is a logarithmic quantity. To keep the terms and numbers more appropriate to a voltage sensitive circuit, not a power sensitive one, a "dB" term which refers to voltage was developed - "dBV." The "V" in "dBV" denotes "voltage." (The "m" in "dBm" denotes "milliwatt.")

The 0 dBV reference is 1 volt. It was chosen because it's easier to work with than 0.775 volts when manipulating equations. 0 dBV is always associated with 1 volt, regardless of the impedance. It so happens that 0 dBV (voltage) will produce 0 dBm (power) only in a circuit with 1,000 ohms impedance (assuming voltage and current are in phase). Refer to Figure 4.

NOTE: The "purist" engineers among you will recognize the fact that all dB numbers always refer to a power level, but in practical terms, dBV is used to describe voltages, regardless of the actual circuit impedance.

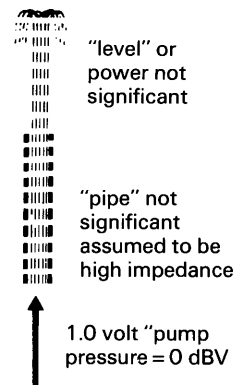

Figure 4.

TASCAM input and output levels have traditionally been rated in dBV because the equipment has high impedance circuitry which senses voltage, not power. There's only one slight complication in our practice of using dBV values, and it comes up when you interface a piece of TASCAM equipment to equipment which another manufacturer rated using an assumed 600 ohms impedance. The equipment will usually work properly, but the level calibration may be slightly inaccurate due to

the differences between the dBm and dBV "0 dB" references.

Let's look at a practical example.

Refer to Figure 5. Suppose the TASCAM output is rated at 0 dBV, and the other equipment's input to which the TASCAM output is connected is rated at 0 dBm. Guess what happens. The 0 dBV output (1 volt), upon encountering a lower impedance (600 ohms rather than 1,000 ohms), causes more power to flow ... +2.2 dBm instead of 0 dBm. It's not a big difference, and it can usually be adjusted with a level control – assuming the output circuit is capable of driving 600 ohms (which may or may not be the case). However, the level which causes a "0" indication on the TASCAM output meter will drive the input meter to "+2.2" since it is calibrated based on a 0.775 volt "zero" into 600 ohms assumed impedance.

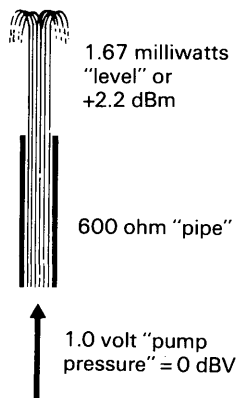

Figure 5.

Look at Figure 6. To avoid the possible error of 2.2 dB, the term "dBv" was introduced. Like "dBV", "dBv" is used to describe voltage, not power, but 0.775 volts is the "0 dBv" reference. The only difficulty with "dBv" was that many people ignore capitalization and confuse dB "big V" with dB "small v," so the 2.2 dB error persists. For this reason, we are now changing to "dBu" instead of "dBv." They're

the same term (0 dBu = 0.775 volts), but hopefully people won't confuse a "u" with a "V".

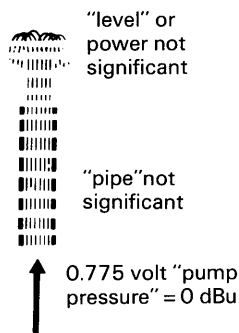

Figure 6.

If a TASCAM output is rated at 0 dBu, it means it puts out 0.775 volts into a high impedance (it may also do so into a low impedance, if so specified). Connect a 0 dBu output to a 0 dBm nominal input, and the meters should match one another.

Different correction factors:

0 dBV = 1V	Voltage	0 dBm = 0.775V/ 600 Ω 0 dBu = 0.775 V/ higher than 600 Ω
+6 dB	2V	+8.2dB
+1.78 dB	1.228 V	+4 dB
0 dB	1V	+2.2 dB
1-2.2 dB	0.775 V	0 dB
-6 dB	0.5 V	-3.8 dB
-8.2 dB	0.388 V	-6 dB
-10 dB	0.316V	-7.8 dB
-12 dB	0.250 V	-9.8 dB
-12.2 dB	0.245V	-10 dB
-20 dB	0.1 V	-17.8 dB

Note:

The "u" in "0 dBu" stands for "unbalanced".

IMPEDANCE MATCHING AND LINE LEVELS

All electronic parts, including cables and non-powered devices (mics, passive mixers and such), have impedance, measurable in ohms (symbol Ω or Z). Impedance is the total opposition a part presents to the flow of signal, and it's important to understand some things

about this value when you are making connections in your mixing system. The outputs of circuits have an impedance rating and so do inputs. What's good? What values are best? It depends on the direction of signal flow, and in theory, it looks like this:

OUTPUTS —————→ **plug into** —————→ **INPUTS**

It is generally said that the output impedance (Z) should be as low as possible. 100 ohms, 10 ohms. The lower, the better, in theory. A circuit with a low output impedance will offer a low resistance to the passage of signal, and thus will be able to supply many multiple connections without a loss in performance or a voltage drop in any part of the total signal pathway. Low impedance values can be achieved economically by using transistors and integrated circuits, but other considerations are still a problem in practice, such as:

1. The practical power supply is not infinitely large. At some point, even if the circuit is capable of supplying more energy you will run out of "juice".
2. Long before this happens, you may burn out other parts of the circuit. The output impedance may be close to the theoretically ideal "ohms" but many parts in the practical circuit are not. Passing energy through a resistance generates heat and too much current will literally burn parts right off the circuit card if steps are not taken to prevent catastrophic failure.
3. Even if the circuit does not destroy itself, too high a demand for current may seriously affect the quality of the audio. Distortion will rise, frequency response will suffer, and you will get poor results.

Inputs should have very high impedance numbers, as high as possible (100,000 ohms, 1 million ohms, or more if it can be arranged).

A high resistance to the flow of signal at first sounds bad, but you are not going to build the gear. If the designer tells you his input will work properly and has no need for a large amount of signal, you can assume that he means what he says. For you, a high input impedance is an unalloyed virtue. It means that the circuit will do its job with a minimum of electrical energy as a beginning. The most "economical" electronic devices in use today have input impedances of many millions of ohms, test gear for example, voltmeters of good quality must not draw signal away from what they are measuring, or they will disturb the proper operation of the circuit. A design engineer needs to see what is going on in his design without destroying it, so he must have an "efficient" device to measure with.

SOURCE (output) —————→ **plugs into** —————→ **LOAD (input)**

The classic procedure for measuring output impedance is to reduce the load's impedance until the output voltage drops 6 dB (half the original power) and note what the load value is. In theory, you now have a load impedance that is equal to the output impedance. If you

gradually reduce the load (increase the input impedance), the dB reading will return slowly to its original value. How much drop is acceptable? What load will be left when an acceptable drop is read on the meter?

Traditionally, when the load value (input Z) is approximately seven times the output impedance, the needle is still a little more than 1 dB lower than the original reading.

Most technicians say, "1 dB, not bad, that's acceptable." We at TASCAM must say that we do not agree. We think that a seven-to-one ratio of input (7) to output (1) is not a high enough ratio, and here's why:

1. The measurement is usually made at a mid-range frequency and does not show true loss at the frequency extremes. What about the drop at 20 Hz or 30 kHz?
2. All outputs are not measured at the same time. Most people don't have twenty meters, we do. Remember, everybody plays together when you record and the circuit demands, in practice, are simultaneous. All draw power at the same time.

Because of this widely misunderstood rule of thumb – the seven-to-one ratio, we will give you the values for output impedance.

True Output Impedance

Even though the true output impedance may be low, say 100 ohms, it takes a lab to check the rule of thumb, so for the practical reasons we have explained, the use of the ratio method of impedance calculation must be changed to a higher ratio. We prefer 100:1 if possible and we consider 50:1 to be the minimum ratio that we think safe. Because of this, we will give you a number for ohms that you can match, Minimum Load Impedance. No calculations, we have made them already.

Minimum Load Impedance

MAKE CERTAIN THAT YOU CONNECT NO TOTAL LOAD IMPEDANCE LOWER (numerically) THAN THESE FIGURES.

PGM Output/AUX 1, 2, 3, 4 Output	2k ohms
Monitor Output (ST MSTR A/B)	2k ohms
Monitor Output (Balance type)	600 ohms
Direct Output	2k ohms
Access Send Output	2k ohms

Nominal Load Impedance

Our specifications usually show 10,000 ohms as a Nominal Load Impedance. This load will assure optimum performance. Remember, any

Impedance lower than 10,000 ohms is more load.

Input Impedance

Input impedance is more straightforward and require only one number. Here are the values for the M-520 and M-512:

Mic Input	2k ohms
Instrument Input	100k ohms
Tape [2TR A/B (L/R)] Input	47k ohms
Phono Input	47k ohms
Line Input	100k ohms
Program Sub Input	22k ohms
Aux Sub Input	22k ohms
Monitor Sub Input	22k ohms
Access Receive Input (Input)	220k ohms
Access Receive Input (Buss)	22k ohms
Spare Sub Input	100k ohms

If one output is to be "Y" connected to two inputs the total impedance of the two inputs must not be lower than the minimum load impedance, mentioned above, and if it becomes necessary to increase the number of inputs with slight reduction of the load specifications, you must check for a drop in level, a loss of headroom, low frequency response, or else suffer from a bad recording. If one input is 10,000 ohms, another of the same 10,000 ohms will give you a total input impedance (load) of 5,000 ohms. To avoid calculations you can do the following when you have two inputs to connect to one output.

Take the lower value of the two input impedances and divide it in half. If the number you have is greater than the minimum load impedance, you can connect both at the same time. Remember, we are not using the true output impedance we are using the adjusted number, the minimum, output load impedance.

If you must have exact values here is the formula for dissimilar 2 loads or inputs:

$$RX = \frac{R1 \times R2}{R1 + R2}$$

When you have more than two loads (inputs), just dividing the lowest impedance by the number of inputs will not be accurate unless they are all the same size. But if you still get a safe load then the minimum load impedance by this method, you can connect without worry.

If you must have exact values, here is the formula for more than 2 loads or inputs:

$$RX = \frac{1}{\frac{1}{R1} + \frac{1}{R2} + \frac{1}{R3} + \dots + \frac{1}{Rn}}$$

$$RX = \text{Value of Total Load}$$

Finding Impedance Values on Other Brands of Equipment

When you are reading an output impedance specification, you will occasionally see this kind of statement:

Minimum load impedance = X ohms

or

Maximum load impedance = X ohms

These two statements are trying to say the same thing, and can be very confusing. The minimum load impedance says: Please don't make the *NUMBER* of ohms you connect to this output any lower than X ohms. That's the lowest *NUMBER*. The second statement changes the logic, but says the exact same thing.

Maximum load impedance refers to the idea of the *LOAD* instead of the number, and says: please don't make the *LOAD* any heavier. How do you increase the load? Make the number lower for ohms. Maximum load means minimum ohms, so read carefully.

When the minimum/maximum statement is made, you can safely assume that the manufacturer has already done his calculations, and the number given in ohms does not have to be multiplied. You can *MATCH* the value of your input to this number of ohms successfully; but as always, higher ohms will be okay (less load).

Occasionally, a manufacturer will want to show you that 7 times the output Z is not quite the right idea and will give the output impedance and the correct load this way, they will call the output impedance the True Output Impedance and then will give the recommended minimum *LOAD* impedance. It may be a higher or lower ratio than 7 times and will be whatever the specific circuit in question requires.

REFERENCE LEVELS

We should talk about one more reference, a practical one.

Anyone who has ever watched a VU meter bounce around while recording knows that "real sound" is not a fixed value of energy. It varies with time and can range from "no reading" to "good grief" in less time than it takes to blink. In order to give you the numbers for gain, headroom and noise in the console, we must use a steady signal that will not jump around. We use a tone of 1,000 cycles and start it out at a level of -60 dB at the mic input, out beginning reference level. All levels after the mic input will be higher than this, showing that they have been amplified, and eventually we will come to the last output of the console - the line-out and the reference signal there will be -10 dB, our "line level" reference.

From this you can see that if your sound is louder than 94 dB spl, or your mic will produce more electricity from a sound of 94 dB spl than -60 dB, all these numbers will be changed. We have set this reference for mic level fairly low. If you examine the sound power or sound pressure level (spl) chart on page 8 you will see that most musical instruments are louder on the average than 94 dB spl, and most commercial mics will produce more electricity than the -60 dB for a sound pressure of 94 dB, so you should have no problems getting up of "0 VU" on your recorder.

We should also make a point of mentioning that the maximum number on this chart represents "peak power" and not average power. The reason? Consider if even some momentary part of your recording is distorted, it will force a re-recording and it is wisest to be prepared for the highest values and pressure even if they only happen "once in a while". On this point, statistics are not going to be useful, the average sound pressure is not the whole story. The words themselves can be used as an example. Say the word "statistics" close to the mic while watching the meters and the peak LED level detector. Then say the word "average". What you are likely to see are two good examples of the problems encountered in the "real world" of recording. The strong peaks in the "s" and "t" sounds will probably cause the LED's to flash long before the VU meter reads

anywhere near "zero" while the vowel sounds that make up the word "average" will cause no such drastic action.

To allow peaks to pass undistorted through a chain of audio parts, the individual gain stages must all have a large reserve capability. If the average is X then X, + 20 dB is usually safe for speech, but extremely percussive sounds may require as much as 40 dB of "reserve" to insure good results. Woodblocks, castanets, latin percussion (guido, afuche) are good examples of this short term violence that will show a large difference between "LED flash" and actual meter movement. When you are dealing with this kind of sound, believe the LED, it is telling you the truth.

If you are going to record very loud sounds you may produce more electrical power from the mic than the console can handle as an input. How can you estimate this in advance? Well, the spl chart and the mic sensitivity are tied together on a one-to-one basis. If 94 dB spl gives -60 dB (1 mV) out, 104 dB spl will give you -50 dB out, and so forth. Use the number, on our chart for sound power together with your mic sensitivity ratings to find out how much level, then check that against the maximum input levels for the various jacks on the console. If your mic is in fact producing -10 dB or line level, there is nothing wrong with plugging it into the line level connections on the mixer. You will need an adaptor, but after that it will work!

Most mic manufacturers give the output of their mics as a minus-so-many-dB number, but they don't give the loudness of the test sound in dB, it's stated as a pressure reference (usually 10 microbars of pressure). This reference can be found on our sound chart. It is 94 dB spl, 10 microbars, 10 dynes per cm² or 1 Newton per square meter. For mics, the reference "0" is 1 volt (dB). So, if the sound is 94 dB spl, the electrical output of the mic is given as -60 dB, meaning so many dB less than the reference 0 = 1 volt. In practice, you will see levels of -60 dB for low level dynamics, up to about -40 dB or slightly higher for the better grade of condenser mics available today. TASCAM recorders and mixers work at a level of -10 dB referenced to 1 volt (0.3 volt) so, for 94 dB spl, a mic with a reference output of -60 dB will need 50 dB of amplification from your console or recorder in order to see "0 VU" (-10 dB) on your meter. Now, if the sound you want to record is louder than 94 dB spl, the output from the mic will be more powerful and you will need less amplification from your console to make the needles on your recorder read "0 VU".

OTHER USEFUL ACCESSORIES

In addition to the Model 1, we also offer these valuable additions to your system.

The PB-64 Patch Bay

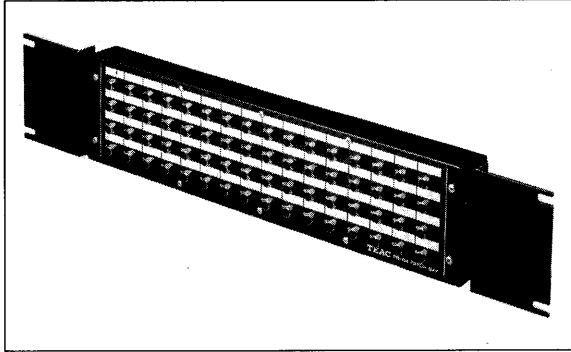

When your system begins to expand beyond the basic, sorting out where things go can take much time away from the recording process. This accessory will allow you to speed things up and get back to what you really want to do. Sixty-four RCA pins on a panel. So you can bring all those jacks to where you are. It will get you off the floor and back to recording. Connect all your inputs and outputs to the back, and you can reroute your signals with short jumpers quickly.

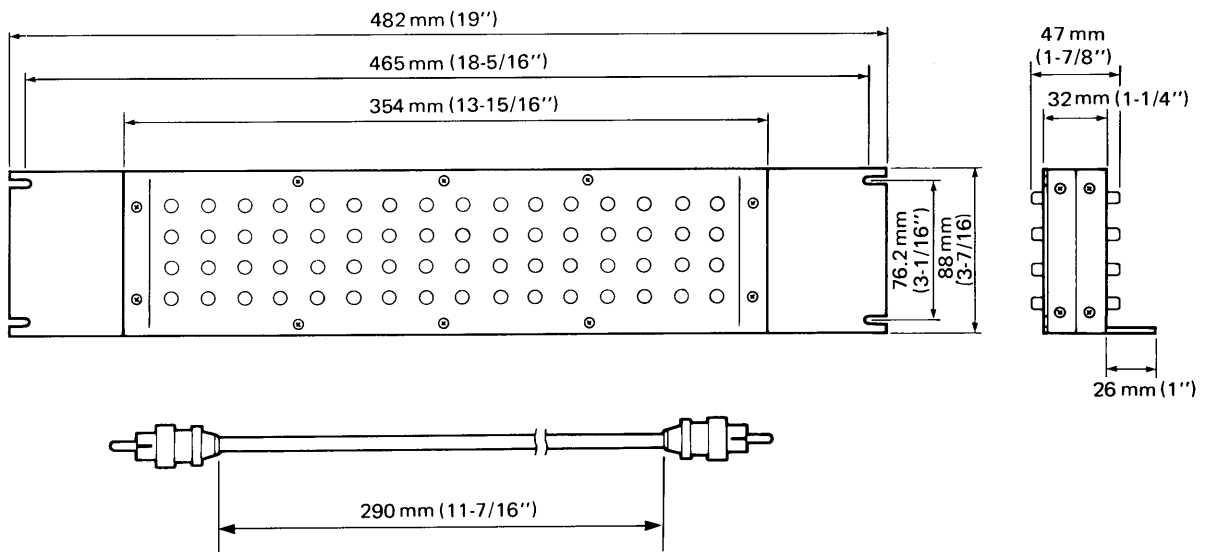

TESCAM PB-32 Series Patch Bays

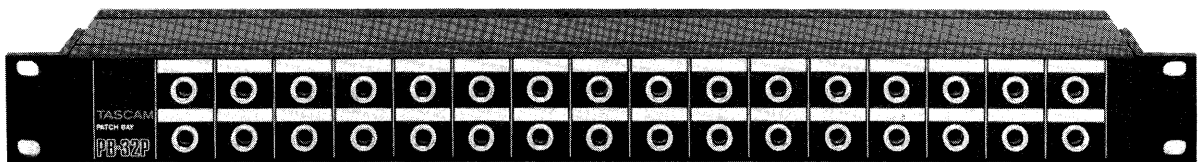

(Model PB-32P)

The PB-32 Series Patch Bays are ideal for any application in multitack recording process. They are available in four basic configurations listed below, and can be mounted in 19" EIA

rack. They also features "normalled" connections to provide the maximum in patching convenience without the need to patch through unused circuits.

Specifications

Number of channels: 16
 Type of jacks: RCA pin jacks and/or 1/4" phone jacks
 Front jacks with switches: white
 Rear jacks without switches: red
 Dimensions (W x H x D): 482 x 44 x 75 (19" x 1-3/4" x 3")
 Weight: 1.3 kg (2-14/16 lbs.)

Model name	Type of jacks	Internal circuit connection	
		(FRONT)	(REAR)
PB-32P	1/4" phone jack (front and rear)	Upper	
		Lower	
PB-32R	RCA pin jack (front and rear)	Upper	
		Lower	
PB-32H	1/4" phone jack (front) RCA pin jack (rear)	Upper	
		Lower	
PB-32W	1/4" phone jack (leftmost 12 jacks, front and rear) RCA pin jack (rightmost 20 jacks, front and rear)	Leftmost 12 jacks (same as PB-32P) Upper	
		Lower	
		Rightmost 20 jacks (same as PB-32R) Upper	
		Lower	

External Dimensions

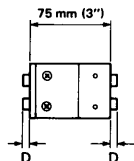
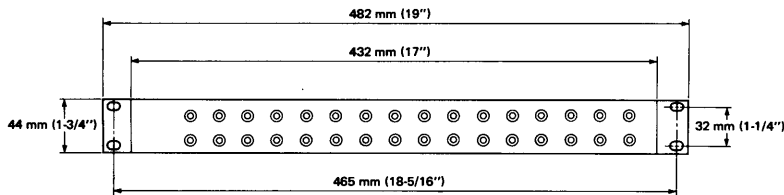

D: 2 mm (1/16") (1/4" phone jacks)
 7 mm (1/4") (RCA pin jacks)

CS-512 and CS-520 Pedestal

CS-512 (for M-512)
CS-520 (for M-520)



M-520 with CS-520

CS-513 and CS-521 Top Board

CS-513 (for M-512)
CS-521 (for M-520)



M-520 with CS-520 and CS-521

Professional Low Loss Cable

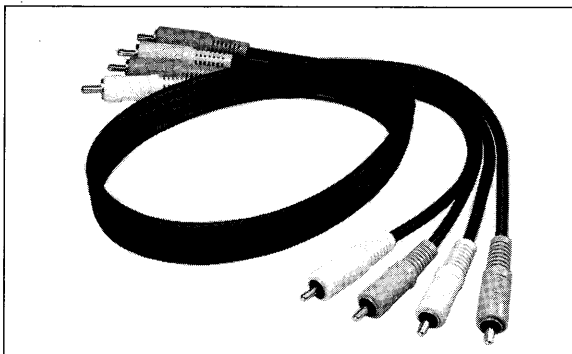

There are vast differences in cable design and performance, and those differences can make or break an otherwise excellent sound system. When you're investing in the kind of high quality audio equipment represented by the TASCAM Studio Series, it makes sense to use TASCAM professional audio cables. Anyone who's switched to them will tell you they're worth every cent.

LOW CAPACITANCE CABLE

Our cables feature very low capacitance under 15 picofarads per foot, so they don't act as high-frequency roll-off filters as do typical cables of 100 or 300 pF/foot. In addition, our cables use an ultra-high density bare-copper braided shield (99% coverage), so electrostatic noise (Buzz or hum) and RFI (CB or broadcast signals) are kept out of your program.

Low capacitance is important, and so is consistent capacitance; that is, you want the electrical coupling of center conductor-to-shield to remain the same throughout the cable, even if it is sharply bent, crushed, flexed, or tugged. Should the local cable capacitance change, noise and/or signal losses often result. We utilize the unique dielectric known as Datalene. This special insulation keeps the stranded signal conductor perfectly centered within the shield. Datalene is about as flexible as foam core dielectrics but far more resistant to extreme heat or cold, and it has a "memory", so it retains its shape after flexing. Datalene also acts as a mechanical shock absorber, guarding against external impacts which, in other cables, might sever the center conductors and cause intermittent contact.

When we join the connector to the cable, we insert the cable's stranded center conductor all the way into the pin and then fill the pin with solder. The braid is wrapped and soldered a full 120° around the shell, not tacked at one spot, so you get maximum shielding and strength.

Note: If TASCAM professional audio cables are not obtainable in your area, use an equivalent cable.

MORE INFORMATION IS AVAILABLE

We've tried to give you representative examples of some of the things you can do to get started, and you'll discover many more – some by way of happy coincidence, others after long

hours of concentration. If you're just getting into recording and want to expand your knowledge, more information is available.

BIBLIOGRAPHY

Beranek, Leo L.
ACOUSTICS
McGraw-Hill Book Co., Inc.
New York, New York
1954

More concerned with exact formulae, but still very readable. It is not necessary to do calculations to gain knowledge from this textbook.

Beranek, Leo L.
MUSIC ACOUSTICS AND ARCHITECTURE
John Wiley & Sons, Inc.
New York, N. Y.
1962

A technical survey on concert halls with much documentation. Worth reading. This author has many useful stories to tell about the interface of science and art.

Clifford, Martin
MICROPHONES: HOW THEY WORK AND HOW TO USE THEM
Tab Books
Blue Ridge Summit, Pa.
1977

An excellent lowcost book for the beginner on microphone types, history and construction. The explanations given assume no prior knowledge and are very complete. Recommended.

Everest F. Alton
ACOUSTIC TECHNIQUES FOR HOME AND STUDIO (3rd. Printing)
Tab Books
Blue Ridge Summit, Pa.
1978

Low-cost basic book. This book on studio acoustics is the easiest to read and understand of all the textbooks on the subject, and comes closest to dealing with the actual problems encountered in the home studio.

Everest F. Alton
HANDBOOK OF MULTICHANNEL RECORDING
Tab Books
Blue Ridge Summit, Pa.
1976

A survey volume containing good information on all topics. Very clearly written and recommended for a beginner.

Nisbett, Alec
THE TECHNICS OF THE SOUND STUDIO FOR RADIO, TELEVISION AND FILM
Hastings House Publishers, Inc.
New York, N. Y.
1976

Although not specifically written for the tape recordist, this 500-page book is well worth its cost. Very useful practical advice if you are working with speech (drama, commercial announcing, etc.)

Nisbett, Alec
THE USE OF MICROPHONES
Hastings House
New York, N. Y.
1976

The author's point of view is basically radio, but his ability to communicate difficult concepts is very good. Well illustrated.

Olsen, Harry F.
ACOUSTICAL ENGINEERING
D. Van Nostrand Company
New York, N. Y.
1957

and

Olsen, Harry F.
MUSICAL ENGINEERING
D. Van Nostrand Company
New York, N. Y.
1959

Anything you can find by this writer is worthwhile, and the latter book in particular will give scientific answers to musical questions (what frequency is the note Db above middle C?) and can be used to translate one "language" into another. Extremely valuable.

Rettinger, Michael
ACOUSTIC DESIGN AND NOISE CONTROL, VOL. 1
Chemical Publishing Company
New York, N. Y.
1977

Although this book is highly technical, the writing is very lucid and many examples are given to go along with the math. This writer is not afraid to draw conclusions and give his reasons for doing so in simple language.

Runstein, Robert E.
MODERN RECORDING TECHNIQUES
Howard W. Sams and Co.
Indianapolis, Indiana
1974

The first low-cost book on studio practice. The equipment dealt with is somewhat outdated, but the theory is still the same. Excellent basic survey.

Tremaine, Howard M.
THE AUDIO CYCLOPEDIA
Howard W. Sams and Co.
Indianapolis, Indiana
1976

This 1,700-page reference work is sure to contain the answer to almost any technical question you can think of. The writing assumes much prior knowledge and this book should be used with others that are more basic in their writing style if you are new to the field of scientific audio.

SOME MAGAZINES OF INTEREST:

"db" – THE SOUND ENGINEERING MAGAZINE
1120 Old Country Road
Plainview, N. Y. 11803

"MODERN RECORDING"
14 Vanderventer Avenue
Port Washington, N. Y. 11050

"RE/P" – RECORDING ENGINEER/PRODUCER
1850 Whitley Street, Suite 220
Hollywood, Ca. 90028

STUDIO SOUND And Broadcast Engineering
Link House Publications PLC
Linc House, Dingwall Avenue
Croydon CR9 2TA, Great Britain