



DUNE 2



User's Manual



Copyright © Synapse Audio Software 2014.
All rights reserved.

Concept and Manual: Richard Hoffmann
Graphic Design: Marcin Lezak
Programming: Richard Hoffmann, Marcin Lezak
Sound Design: See Appendix

All technical specifications in the product described in this manual are subject to change without notice. The document may not be changed, particularly copyright notices may not be removed or changed. VST is a registered trademark of Steinberg Media Technologies GmbH. All other trademarks are property of their respective owners, and do not imply owner's endorsement of this product, or guarantee full compliance with owner's standards.

Contents

1 Introduction	5		
1.1 Installation	5		
1.2 Compatibility	6		
1.3 System Requirements	6		
1.4 New features in Dune 2	7		
1.4.1 Oscillators	7		
1.4.2 Filter	7		
1.4.3 Graphical Envelopes	8		
1.4.4 Unison	8		
1.4.5 Arpeggiator	8		
1.4.6 Master Effects	8		
1.4.7 Patch Management	8		
1.4.8 Audio-Rate Modulation	9		
1.4.9 Multi-threaded processing	9		
2 Basic Operation	10		
2.1 Overview	10		
2.2 Controlling parameters	11		
2.3 MIDI Learn	11		
2.4 Adjusting Polyphony	11		
2.5 Pitch Bend and Modulation Wheel	12		
3 The Center Screen	13		
		3.1 Main	13
		3.2 Settings	15
		3.3 Mod Matrix	18
		3.4 Arpeggiator	19
		4 Sound Parameters	22
		4.1 Patch Structure	22
		4.2 Oscillators 1+2	24
		4.2.1 Common parameters	24
		4.2.2 Synthesis types	25
		4.3 Oscillator 3	27
		4.4 Noise Generator	28
		4.5 Ring Modulator	28
		4.6 Mixer	29
		4.7 Filter Section	29
		4.7.1 Filter Parameters	29
		4.7.2 Filter Models	31
		4.7.3 Filter Effect	33
		4.7.4 Filter Envelope	36
		4.8 Amplitude Envelope	37
		4.9 Unison Voices	38
		4.10 Voice Edit/Common	39
		4.11 Master	40
		4.12 MSEGs	41
		4.13 LFOs	43
		4.14 Effect Bus 1+2	46
		4.14.1 Distortion	46
		4.14.2 EQ 1	47
		4.14.3 EQ 2	48

4.14.4	Phaser	48	8	Troubleshooting	74
4.14.5	Chorus	50	8.1	Notes click when pressing or releasing a key	74
4.14.6	Delay 1+2	51	8.2	Patches do not recall	74
4.14.7	Reverb	52	8.3	Parameters change unexpectedly	74
4.14.8	Compressor	54	8.4	The sound is distorted	74
5	Modulation Matrix	57	8.5	MIDI messages are not received	75
5.1	The differential unison engine (DUNE)	58	8.6	The CPU usage is very high	75
5.2	List of Sources	59	9	Legal Information	76
5.3	List of Destinations	63	9.1	Trademarks	76
5.3.1	Common	63	9.2	End User License Agreement (EULA)	76
5.3.2	Oscillator 1, 2, 3	63			
5.3.3	Ring mod/Noise	65	Appendix		78
5.3.4	Filter	66			
5.3.5	Amplifier	67			
5.3.6	MSEG	67			
5.3.7	LFO	67			
5.3.8	Mod Matrix	68			
5.3.9	FX Bus 1+2	68			
6	MIDI Reference	70			
7	Optimizing performance	72			
7.1	Optimizing your system	72			
7.2	Optimizing patch settings	72			
7.2.1	Polyphony	72			
7.2.2	Modulation Rate	72			
7.2.3	Patch structure	73			

1 Introduction

Thank you for choosing Dune 2!

Dune 2 is an advanced polyphonic synthesizer VST/AU plugin, designed for creating music on a computer, or playing live on stage.

The design goal was to develop a synthesizer which offers yet higher sound quality and more flexibility than its predecessor, Dune 1. Fast vector processing as well as support for multiple processor cores allow the plugin to run with a moderate CPU load on modern systems.

Dune 2 was tested by music producers to guarantee its ambitious design goals were met. It comes with high quality sounds, created by experienced sound designers.

1.1 Installation

Important note for Dune 1 users: Dune 2 is a new synthesizer which is not compatible with Dune 1 in any way. Both run fine in parallel, there is no need to uninstall Dune 1 prior to installing Dune 2.

Installation PC

Unzip "Dune20win.zip" and run SETUP.EXE to commence with the installation process. The installer will guide you through the necessary steps. You will be asked to select the location of your VstPlugins directory. Make sure to choose the correct directory for your host software. Refer to your host software's manual if you are unsure about where the host software's VstPlugins directory is located. The plugin file "Dune 2.DLL" and the manual will be placed in the chosen directory. Presets, MIDI files and wavetables will be placed in your user documents directory (Synapse Audio/Dune 2). The next time you start your host software, Dune 2 will appear in the VST instrument list.

If you use a 64-bit host such as Orion 64, be sure to provide the proper VstPlugins path for the 64-bit edition of Dune 2.

Installation Mac

Download and open the file named "dune20mac.dmg". Afterwards, double-click on the installer icon to begin the installation process. The installer will guide you through the necessary steps. The next time you start your host software, Dune 2 will appear in the AU and/or VST instrument list, depending on which format your host software supports.

1.2 Compatibility

Dune 2 should run on any VST or AU-compatible host and comes with both 32-bit and 64-bit versions.

If you encounter any compatibility issues with your host software, do not hesitate to contact us (service@synapse-audio.com).

1.3 System Requirements

In order to maximize sound quality, Dune 2 employs complex DSP algorithms that are rather CPU demanding. Optimized SSE-2 vector processing, as well as support for multiple processor cores allow Dune 2 to perform very well despite its high complexity, however. To achieve such performance, a modern computer is required:

- **Macs** require OS X 10.6 or later, and should be equipped with a 2 GHz quad core processor or better. PPC processors are not supported.
- **PCs** require Windows XP or later, and should be equipped with a 2 GHz quad core CPU or better. Most importantly, Windows must be optimized for realtime audio, in order to maximize the benefits of Dune 2's multi-threaded engine. Too many software packages or services running

in the background can severely degrade performance.

Furthermore, it is important to choose a good audio buffer size. We recommend to use between 128 and 512 samples (at 44.1 / 48 kHz sample rate). On most systems, this should give the ideal balance between low-latency, realtime feel and CPU performance. Note that using less than 128 sample buffers will disable multi-threaded processing, as the thread synchronisation overhead becomes significant.

The memory requirement of Dune 2 is approximately 50 mb per instance, plus some memory shared by all instances. If you plan to run many Dune 2 instances, your system should be equipped with sufficient memory.

1.4 New features in Dune 2

This section provides an overview of the most important changes since Dune 1 — new users can skip this section.

Since Dune 2 is a new synthesizer rewritten from scratch, there is many changes compared to Dune 1. What both synthesizers have in common, however, is the differential unison engine (hence, "DUNE") with its unique modulation system. If you are familiar with this system, making the transition to Dune 2 should be relatively easy.

1.4.1 Oscillators

- **Oscillators 1+2** now both form oscillator stacks with up to 32 oscillators each (previously, there was only a "Fat" mode which used 7 fixed oscillators). Each oscillator stack can be set to use Virtual-Analog (VA), Wavetable or FM synthesis. The oscillator stacks operate in stereo and offer detune and pan spread.
- **Oscillator 3** is no longer a sub oscillator, but can use arbitrary semi and fine tuning, for increased flexibility.
- **Wavetable Synthesis** now allows to set arbitrary positions within the wavetable, for example in between two waveforms. Modulating the

wavetable position is now much smoother than previously (in fact perfectly smooth when choosing a proper modulation source, such as a triangular or sinusoidal LFO).

- **FM Synthesis** offers classic 3-operator frequency modulation. In contrast to Dune 1, using FM does not compromise the ability to use the full oscillator stacks. This means when both oscillator stacks are set to 32 oscillators in FM mode and all 8 unison voices are enabled, Dune 2 will render 1536 FM operators per key press (64x8x3 operators). At maximum polyphony, this is 24576 FM operators running simultaneously!
- The **Noise Generator** operates in stereo with adjustable stereo width, and offers lowpass as well as highpass filters for increased versatility.

1.4.2 Filter

- **Zero-Delay Feedback Filters:** Dune 2 introduces zero-delay feedback filters, which more closely mimic the behavior of analog hardware. A drive parameter allows to adjust the saturation characteristic (important when using strong resonance). Most filters can reach self-oscillation and have proper resonant tuning.

- **Filter Effect:** Some filter modes in Dune 1 offered extra gimmicks, such as a distortion or bitcrush effect. Dune 2 offers a separate filter effect section with a variety of such effects as well as auxiliary filters. The filter effect section can be applied pre- or post-filter.

1.4.3 Graphical Envelopes

Dune 2 introduces four multiple segment envelope generators (MSEG). MSEGs can be used to draw precise custom envelopes, or they can be used in loop mode tempo sync'ed to the host, which allows to create rhythmic effects such as the well-known "trance gate" effect.

1.4.4 Unison

One of the most important changes in Dune 2 is the ability to edit all 8 unison voices directly, turning Dune into a multi-part synthesizer. This allows to stack completely different sounds, using different synthesis models (VA, FM, Wavetable), a different filter, etc.

1.4.5 Arpeggiator

The arpeggiator now offers the classic up/down/random modes known from many synthesizers, and works better when playing live via a MIDI keyboard. The step

sequencer adds a slide feature and allows to import MIDI files. Polyphonic sequences can be played back as well.

1.4.6 Master Effects

The new version of Dune features two master effect busses, each containing 9 effects rather than 6. The new effects offer higher quality and more parameters than previously. Individual unison voices can be routed to either effect bus or both.

1.4.7 Patch Management

The patch management in Dune 2 is now entirely based on files and folders. Each patch is a single file (FXP), folders represent banks and categories. When launching Dune 2, all available banks will be scanned automatically. This greatly simplifies using third party content, as it is no longer necessary to explicitly load banks. Sound design becomes easier, as the file-based system allows to duplicate, remove, and rename patches, and to sort them in arbitrary categories. Additional functions like Initialize and Revert Patch speed up the workflow.

1.4.8 Audio-Rate Modulation

The new engine can be set to audio-rate modulation mode, allowing all synthesizer parameters (except the master effects) to be modulated at audio-rate. Audio-rate modulation is very CPU-intensive, but allows to develop new sounds with rapid modulations previously not possible.

1.4.9 Multi-threaded processing

Most DSP algorithms employed in Dune 2 are a magnitude more complex than previously, in order to achieve a yet higher sound quality. This also means a much higher computational load, at least in theory. In practice the optimized SSE vector code, as well as the multi-threaded engine lower the processor load substantially. On modern, optimized quad-core or better systems, Dune 2 can even outperform Dune 1 in some cases.

2 Basic Operation

2.1 Overview

The Dune 2 interface can be divided into four parts (see fig. 2.1).

- The center screen (A) hosts the patch management, global and patch settings, the modulation matrix and the arpeggiator. The center screen is covered in chapter 3.
- The right side (B) contains the master section with global volume and the polyphony setting, as well as the unison voice controls. In contrast to its predecessor, Dune 2 allows to directly edit the eight unison voices, either all at once or individually. This makes Dune 2 a multi-part synthesizer which facilitates synthesizing more complex sounds.
- The gray switch buttons (C) toggle the bottom view between the keyboard, effect busses, LFOs, and four graphical envelopes (MSEG).
- The remaining knobs and sliders (D) are Dune's main sound parameters: The oscillator stacks, mixer, filters, and ADSR envelopes. The layout roughly follows classic synthesizers, with the oscillators on the left, followed by the filter in the middle and the envelopes on the right. Each unison voice has its own set of sound parameters. All sound parameters are covered in chapter 4.

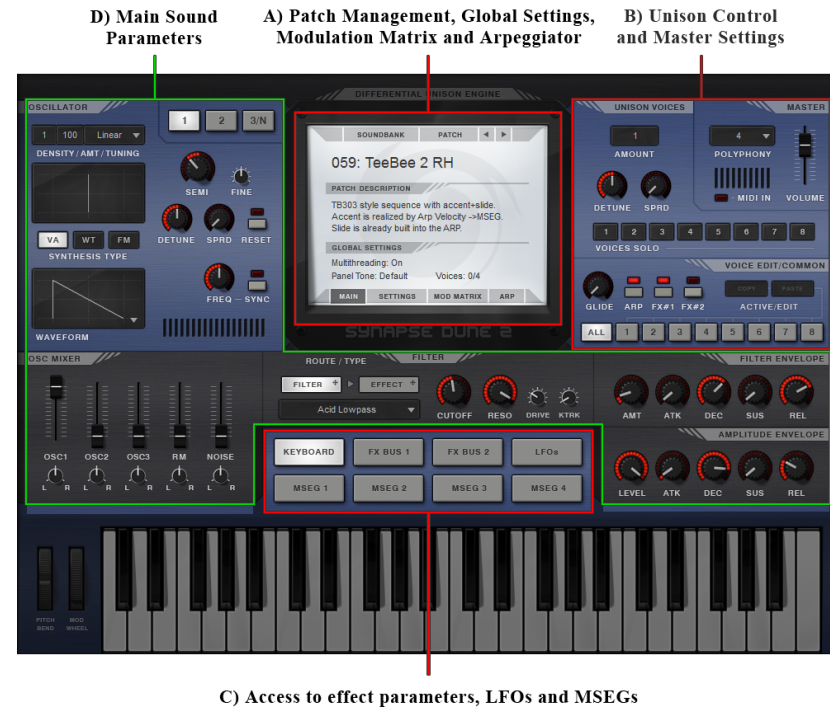

Figure 2.1: Interface overview.

2.2 Controlling parameters

Knobs, faders, and numerical displays are controlled by left-clicking on them, then dragging the mouse up or down in vertical direction (see fig. 2.2).

Hold down Shift while turning knobs to slow down the movement, in order to set precise values. Use Ctrl+Click to set knobs to their default position.



Figure 2.2: Controlling parameters.

The **mouse wheel** is a very useful tool to speed up your workflow, and works on almost every parameter. Use the mouse wheel on numerical displays to increase or decrease the current value. Use the mouse wheel on drop-down lists, to select the previous or next parameter in the list. Knobs and faders can be fine tuned using the mouse wheel, in the graphical envelope editors it zooms the view.

2.3 MIDI Learn

Right-click on a parameter then choose "Learn" to link it to a particular MIDI controller. Afterwards, turn any knob or fader on your MIDI gear to link it to that parameter. Unlink controllers by right-clicking on a parameter then choosing "Forget". Note that without any assignments, Dune 2 uses a default MIDI controller map (see chapter 6).

2.4 Adjusting Polyphony

Dune 2 allows you to play multiple notes at the same time. The "Polyphony" drop-down menu in the master section on the right adjusts the number of notes that can be played simultaneously.

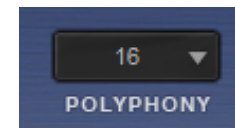

Each note you play triggers one or more unison voices (the number of active voices are displayed in the MAIN section of the center screen). Since each voice costs processor time, it is a good idea to limit the polyphony as much as possible.

When choosing Mono or Legato, only one note can be played at a time. Legato allows to smoothly go from one note to another without retriggering the envelopes.

This can be useful for bass and lead sounds, particularly in combination with the glide knob. It creates a unique playing feel and sound which can be better for monophonic lines. Using mono or legato modes also results in the smallest CPU usage possible.

Note that the voice polyphony can be adjusted per patch. While all patches should employ an adequate setting out of the box, your individual playing style or usage of sounds may require adjusting the polyphony parameter at times.

2.5 Pitch Bend and Modulation Wheel

At the bottom left of the user interface, the pitch bend and modulation wheels are located. The pitch bend wheel is used to temporarily shift the pitch up- or downwards. When released, it automatically snaps back to center position. The modulation wheel typically controls vibrato type effects, but can be used to modify other sound parameters as well. It remains in whatever position it was set to.

3 The Center Screen

This chapter explains all parameters inside the center screen. The center screen hosts the patch management, global settings, patch settings, the modulation matrix and the arpeggiator.

3.1 Main

Selecting a patch

Each musical sound that you can play is called a Patch. A patch is selected by clicking on the patch name in the center screen:

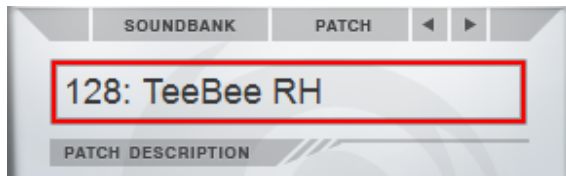

Alternatively click on the left/right arrow buttons to go to the previous/next patch inside the current bank.

Dune 2 comes with 300 patches, sorted into categories like Bass, Lead, Pads, Special FX etc. The default bank shown is "Showcase", a collection of some of

our favorite patches. Click on **Soundbank** to choose a different bank/category.

Soundbanks and Patches are stored in the following directory:

- **Mac OS X:**
Music/Synapse Audio/Dune 2/Soundbanks
- **Windows:**
User/Documents/Synapse Audio/Dune 2/Soundbanks

Each patch is a single Cubase .FXP file, a common format for storing patches. Any directory within the Soundbanks directory represents a bank. Thus you can easily organize your patches and banks within the Soundbanks directory.

Below the patch name, the patch description section gives some information about the currently selected patch, for example what the modulation wheel does to the sound, or whether the patch is intended for a particular tempo.

Important note for Dune 1 users:

Dune 2 keeps the active patch in memory, not the entire bank. Always save patches you edit, switching to a different patch will lose your edits!

Patch menu

The patch menu is invoked by clicking on "Patch":

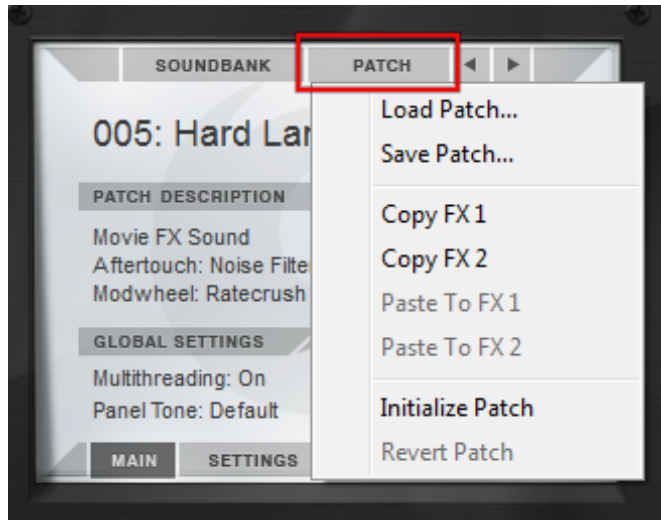

- **Load Patch** loads a particular patch from disk. This can be useful to browse patches outside of Dune's Soundbanks folder. Most of the time, however, you should store patches in your Soundbanks folder, in order to be able to browse a whole bank quickly.
- **Save Patch** allows you to save the current patch to disk. Always save your changes before switching to a different patch or closing your host application, otherwise you will lose your changes.

Of course you can also simply save the project in your host sequencer, this will automatically save the active patch as well.

Any patch that has been modified is marked with an asterisk (*), after saving the patch, the asterisk is removed.

- **Copy FX 1/2** copies all effect bus 1/2 parameters into the clipboard, in order to apply them to a different patch or to a different Dune 2 instance.
- **Paste FX 1/2** pastes all effect parameters from the clipboard into effect bus 1/2.
- **Initialize Patch** resets the current patch to default settings. When designing new patches from scratch, it is useful to start with a "minimal" patch, i.e. a patch with an empty modulation matrix, all effects turned off, etc., which is what the Initialize Patch function does. Note that your current patch will be lost, so be sure to save it first if necessary.
- **Revert Patch** allows you to restore the current patch from disk, in case you are unhappy with changes made to the patch.

Multithreading

Dune 2 can take advantage of up to six processor cores for synthesizing sounds. Enabling multithreading is strongly recommended in most cases, as it can substantially reduce the CPU usage. Refer to chapter 7 for more details on how to optimize performance.

Skin

Click on Skin to choose between the different skins available. Note that skins are located in the following directory:

- **Mac OS X:**
Music/Synapse Audio/Dune 2/Skins
- **Windows:**
User/Documents/Synapse Audio/Dune 2/Skins

Since all skins come with all necessary bitmap files as well as a Configuration file defining the skin, you can create your own skins as well. The easiest way to get started is to simply duplicate one of the existing subfolders, then start to modify its files.

Midi Smoothing

Incoming Pitch bend, Modulation wheel and Aftertouch messages can be smoothed. Strong smoothing

is useful in a setup where the MIDI hardware and/or host sequencer sends too few messages, thus causing a steppy response. The downside of smoothing is latency and lower accuracy on rapid movements. By default, only a little smoothing is applied, which should work best in most setups.

For special applications, smoothing can be turned off entirely. This is useful if you want to e.g. automate one or more parameters via the modulation wheel and an instantaneous response without any latency is required.

3.2 Settings

This tab controls various patch settings such as velocity, pitch bend and the modulation rate.

Velocity

Each MIDI note transmits a velocity value, which can be connected to any sound parameter using the modulation matrix. Since velocity is often used to control the volume or brightness of a sound, the velocity section allows for a few common direct connections.

- **Volume** adjusts how much velocity affects the volume of a patch. Set to zero, velocity has no

effect on volume. Positive values cause higher velocities to increase volume, negative values invert the effect — higher velocities decrease volume.

- **Pan** adjusts how much velocity affects the stereo position. Set to zero, velocity has no effect on pan. Positive values move the sound to the right as velocity increases, negative values do the opposite.
- **Filter** adjusts how much velocity affects the filter cutoff. Set to zero, velocity has no effect on the filter. Positive values cause higher velocities to increase filter cutoff, negative values invert the effect.
- **Env Amount** adjusts how much velocity affects the envelope amount. Set to zero, velocity has no effect on the filter envelope amount. Positive values cause higher velocities to increase envelope amount, negative values invert the effect.

Velocity Curve

Using the velocity curve setting, you can change the effect the MIDI Velocity has on the selected patch. To change the velocity curve, left-click on the curve, then drag the mouse up or down in vertical direction.

By default, all MIDI velocity values control the destination in a linear manner (1:1). For example, an

incoming velocity value of 80 has twice the effect compared to a velocity of 40. By setting the curve parameter, you can change this 1:1 mapping to a nonlinear behavior. A value of zero corresponds to the default, linear scale.

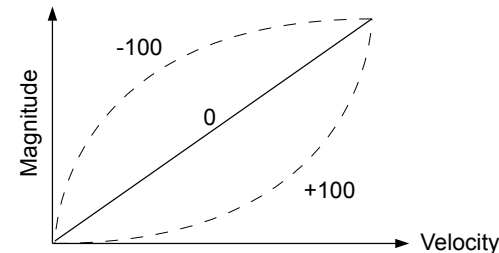
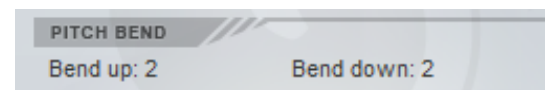

Figure 3.1: MIDI velocity curve.

The curve parameters is useful to fine tune the velocity response towards your personal playing style, as well as to your MIDI keyboard.

Pitch Bend

The Bend up/down parameters specify by how many semitones a sound is pitch shifted up or down, when the pitch bend wheel is turned all the way up or down.



Click on the numbers and drag the mouse up or down to increase/decrease the pitch bend range.

If a MIDI keyboard is hooked up to your computer, turning the physical pitch bend or modulation wheel should turn the same wheel in Dune automatically. If this is not the case, then the required MIDI information is not transmitted to the plugin, and you should refer to your host software's manual to address the issue.

Modulation rate

The modulation rate determines how frequently the modulation matrix is evaluated.

- **Normal** rate is almost always sufficient, and the best choice for most sounds.
- **Fast and Very fast** rates are useful when you use rapid LFO modulations (>100 Hz), or when you use MSEGs with very fast envelopes.
- **Audio Rate** mode processes the entire synth engine sample by sample. This allows to e.g. use oscillators as modulation sources and modulate any (!) sound parameter with them accurately.

Note that audio rate modulation is very CPU-intensive and should be only used when really needed. Also note that a higher modulation rate does not equal better sound — if you cannot hear a difference, do not use a higher modulation rate, this will just waste precious CPU cycles.

Plugin Kb

This control allows you to set the key range the graphic keyboard at the bottom responds to. By default, the graphic keyboard uses the C2-C6 range.

Sync

All LFOs and MSEGs have an option to slave them to the host tempo, a feature very useful for rhythmic effects. DUNE 2 offers two ways to sync LFOs and MSEGs to the host sequencer:

- **Internal** Tempo-synced LFOs and MSEGs are retriggered whenever a note is played.
- **Host** Tempo-synced LFOs and MSEGs are slaved to the host's current transport position.

Both modes will use the host tempo in BPM as a reference. The difference between both modes is apparent during sequencing, however. Host Sync is useful if you sequence a number of notes, while a slow, tempo-synced LFO or MSEG modulates the entire sequence. Internal mode should be used whenever each individual note played is to be modulated.

Note that some hosts may not support host sync correctly. In this case, use internal mode.

3.3 Mod Matrix

The modulation matrix is accessed by clicking on the Mod Matrix button (see fig. 3.2). The purpose of a modulation matrix is to connect MIDI controllers, LFOs, and envelopes with Dune's sound parameters. In a nutshell, the modulation matrix is largely responsible for making sounds come alive.



	SOURCE	AMT	DESTINATION	VOICE
1	LFO 1	+100	Amp Level	---
2	---	---	---	---
3	---	---	---	---
4	---	---	---	---
5	---	---	---	---
6	---	---	---	---
7	---	---	---	---
8	---	---	---	---

Figure 3.2: The modulation matrix.

Click anywhere in the source column to choose the modulation source, and anywhere in the destination column to select the sound parameter to modulate. In the amount column, click and drag vertically to change

the modulation amount for a specific slot. In the example above (fig. 3.2), LFO-1 modulates the amplitude with an amount of 100%, giving a tremolo effect.

The voice column on the right allows to limit the modulation to specific unison voices. By default, all voices are modulated, the column is empty ("—").

To get the most out of the modulation matrix, it is required to first understand how LFOs and envelopes work, and what the sound parameters do. Hence, the modulation matrix with all its source and destination parameters is described more thoroughly in chapter 5, after the sound parameter chapter.

3.4 Arpeggiator

An arpeggiator (short: ARP) is a module that generates melodic or rhythmic patterns from one or more keys pressed. This is achieved with the help of a little step sequencer containing note length, velocity and pitch information. For additional flexibility, standard MIDI files can be loaded as well. The arpeggiator is enabled or disabled using the **ARP** switch in the voice edit section, individually per unison voice. The arpeggiator parameters are accessed by choosing ARP in the center screen (see fig. 3.3).

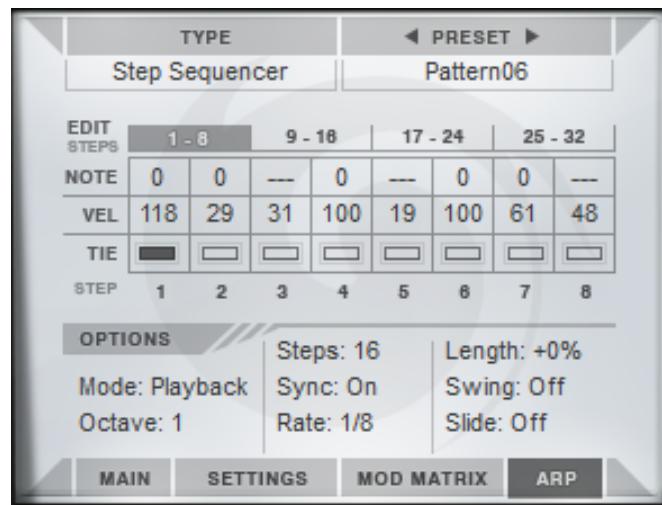

Figure 3.3: Arpeggiator screen.

Type

The arpeggiator can use either the built-in step sequencer or midi files as a basis, which can be chosen using the TYPE popup field in the top left of the monitor.

In **Step Sequencer** mode, monophonic patterns of up to 32 steps can be programmed directly within Dune. Click on buttons 1-8, 9-16, 17-24 or 25-32 to edit eight steps simultaneously.

Each step has three parameters, note, velocity, and tie. A nonzero note value transposes a step up or down by the given number of semitones, e.g. +12 corresponds to one octave up. The velocity value is transmitted to the modulation matrix, where it can be used as a modulation source ("Arp Velocity") in order to change the volume or timbre of each step. The tie button glues two steps, which allows to either slide from one note to another seamlessly, or to simply increase its length. A rest can be programmed by turning down the note value all the way down, until three dashes ("—") appear.

The **Midi** mode allows to use standard MIDI files as a basis. The files should contain only a single track, and they should be monophonic. An exception is when the "Playback" mode is chosen, in this mode polyphonic MIDI files can be played back too.

Arpeggiator Modes

The arpeggiator module in Dune comprises 9 different modes described below.

- **Up** mode successively triggers notes for all keys currently pressed, from the lowest to the highest note, then repeats the sequence starting with the lowest note again.
- **Down** mode does the same, but in reverse order.
- **Up/Down** mode triggers all keys pressed from the lowest to the highest note, then back.
- **Down/Up** works like Up/Down, except in reverse order.
- **Alt Up** is an alternative to Up mode, employing a different pattern when moving up.
- **Alt Down** mode is identical to Alt Up, except it operates in reverse order.
- **Random** mode traverses through all keys pressed, in random order.
- **Chord** mode chops up a chord into a rhythmic pattern, according to what is programmed in the step sequencer or MIDI file.
- **Playback** mode simply plays back the sequencer notes (or MIDI file), transposed according to the current MIDI key pressed. Pressing more than one key simultaneously has no effect in this mode. Playback mode is the only mode that allows to play back polyphonic MIDI files.
- **Dynamic** mode plays back a monophonic sequence similar to Playback mode. Dynamic mode allows the performer to change the sequence in realtime, however, by pressing more than one key at a time. Which notes are changed is programmed using velocity. Velocities between 0 and 31 do not change a note, while velocities between 32 and 63 affect the second key pressed, velocities between 64 and 95 the third, and velocities above 96 the fourth. A simple application of the Dynamic mode is to let the user turn a sequence written in minor to a sequence in major, or vice versa.
- **Silent** is a special mode in which the arpeggiator does not trigger any notes. The purpose of this mode is to use the arpeggiator exclusively for modulation, by choosing "Arp Note", "Arp Velocity" or both as a source in the modulation matrix.

Octaves

This parameter specifies how many octaves the arpeggiated sequence spans. Set to one octave, the arpeggiator will use exactly the keys pressed. Set to two octaves, the arpeggiator will use all keys pressed, plus the very same keys one octave higher, etc.

Steps/Bars

When in Step Sequencer mode, this parameter sets the pattern length in steps. When the arpeggiator reaches the end of the pattern, it will automatically jump to the beginning and start over. When MIDI mode is selected, this parameter sets the number of bars to use, up to 32 bars are possible. The arpeggiator loops MIDI sequences, too.

Rate

Adjusts the tempo in which the arpeggiator generates sequences from incoming MIDI notes. When **SYNC** is enabled, the tempo is slaved to the host sequencer and can be specified in musical intervals such as 8th note, 16th notes, dotted notes (*), triplets (T) etc. When SYNC is disabled, the rate is specified in Hz.

Length

Using the length parameter, the duration of all notes in the sequencer can be increased or decreased. Turned to the left, the notes get a staccato feel, while the opposite direction yields smoother sounding sequences.

Swing

This control shuffles the position of every other 16th note by the specified amount. This parameter can be used to obtain a typical swing feel with a setting of +33% and above. In the step sequencer, the shuffled notes are located at positions 2, 4, 6, 8, ..., 32.

Slide

This control adjusts the time it takes from the beginning of a slid note to reach its target pitch. In order to get any audible effect, TIE must be used on a note, and at least two different note numbers must be used during the note.

Note that Slide only works in Step Sequencer mode, not in MIDI mode.

4 Sound Parameters

This section describes how a patch is constructed, the operation of all front panel knobs and switches, the effect section and the arpeggiator.

4.1 Patch Structure

The structure of a Dune 2 patch is shown in fig. 4.1. The block diagram shows the basic working principle of the entire synthesizer without taking into account the modulation matrix (which will be covered in detail in chapter 5).

Whenever a MIDI note is played, one or more voices are triggered to synthesize that note. Each voice has the exact same structure shown, but may use different parameters. The voices are summed and fed into the effects unit to further refine the sound with equalization, delay, reverb etc.

Each voice comprises three major building blocks, an oscillator block ("OSC 1-3"), a filter block ("Filter") and a volume control block ("Amp"). The blocks emulate the three basic properties of a sound: Pitch, Timbre and Volume. The oscillator block controls the pitch and basic timbre of a sound by generating one

or more periodic waveforms. The resulting signal is typically very bright. To further refine the timbre, the signal is processed by the filter block, which attenuates frequencies specified by the user; usually, high frequencies are removed. Hence, this type of synthesis is commonly called "subtractive". The final block controls the volume of the signal.

On their own, the three basic building blocks synthesize a completely static sound. This is in contrast to acoustic sounds, where pitch, timbre and volume change over time. In order to obtain this possibility in a synthesizer, so called envelopes are used to add dynamic variation to a sound. The most important envelope is the amplitude envelope ("Amp Env"), which is essential to fade in and fade out notes and thus to make a synthesizer playable like a real instrument in the first place. Also important is the filter envelope ("Filter Env"), which dynamically controls the brightness and thus the timbre of a sound over time. The modulation envelope ("Mod Env") can be freely assigned to any sound parameter, and is typically used to change the pitch progression.

While envelopes nicely control the overall progression of a sound, it is sometimes desirable to add periodic modulations. Such modulations can mimic vibrato or tremolo effects known from acoustic instruments, and can be added by using one or more of the low frequency modulation ("LFO") blocks.

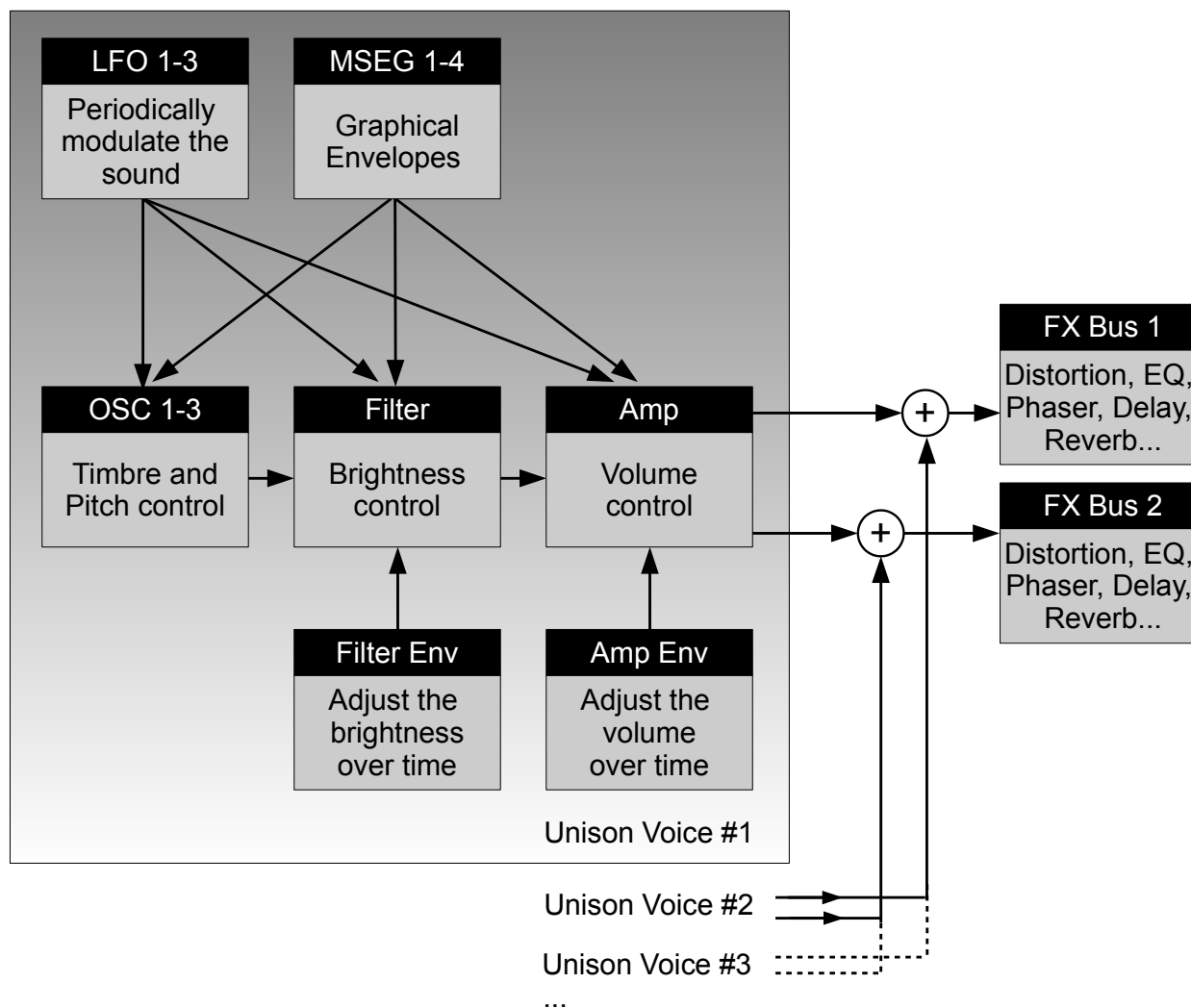

Figure 4.1: Structure of a Dune 2 patch.

4.2 Oscillators 1+2

An oscillator generates a periodic waveform and forms the basic building block of the majority of synthesizers. The most common waveforms are illustrated in fig. 4.2. Dune offers three oscillators and a separate noise generator. This corresponds to how many traditional synthesizers work. In Dune, however, the first two oscillators are actually stacks of up to 32 oscillators each, with adjustable detune and stereo spread. This allows to obtain thick pad, bass or lead sounds with just one oscillator alone. With Dune's 8 unison voices, up to 520 oscillators per key can be synthesized.

Dune's oscillator controls can be found in the top left section of the user interface labelled "Oscillator".

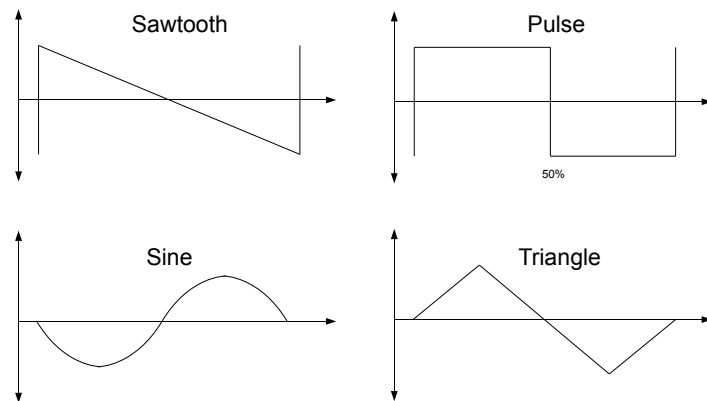

Figure 4.2: Basic oscillator waveforms.

4.2.1 Common parameters

Density

The number of oscillators can be changed by left-click/drag on the Density field in the top-left. When set to zero, the oscillator stack is turned off, which saves processor time.

Amount

When choosing more than two oscillators using the density control, the amount (AMT) parameter allows to modify the level of the oscillators. The meaning of this parameter depends on the selected tuning mode, but usually adjusts the level of the oscillators around the center (which always remains at maximum).

Tuning Mode

The chosen tuning mode affects the overall tuning and volume of the oscillator stack.

- Linear mode tunes all oscillators around the center with equal spacing.
- Nonlinear mode moves some oscillators closer to the center.

- Gaussian mode uses a gaussian distribution on the volume of the oscillators, which can be fine-tuned by the amount parameter.
- Alternate mode lowers every other oscillator in volume when changing the amount parameter.
- Random uses a random tuning for all oscillators, whenever a new key is pressed.

Semi

The control labelled SEMI adjust the coarse tuning of the oscillator stack, in semitones. The range spans +/- 36 semitones. A larger range can be obtained by using the modulation matrix, if required. This will be covered in chapter 4.

Fine

This parameter adjusts the fine tuning of the oscillator stack in cents. A value of +/- 100% corresponds to half a semitone.

Detune

When two or more oscillators are active in the stack, the detune parameter allows to spread their pitch around the center frequency.

Spread

When two or more oscillators are active in the stack, the SPRD knob allows to spread the oscillators in the stereo field, around the center. Turned fully left, the oscillator stack will be mono.

Reset

When reset is enabled, all oscillators in the stack start at the same initial phase (by default zero, this can be changed in the modulation matrix). Setting the initial oscillator phase can be useful to obtain better control of the transient of a sound, for instance. When using more than one or two oscillators, note however that reset will create strong phasing effects. It is thus usually better to keep reset turned off when using multiple oscillators.

4.2.2 Synthesis types

Three different synthesis types, Virtual-Analog (VA), Wavetable (WT) and Frequency Modulation (FM) are available per oscillator. When using more than one voice, it is furthermore possible to specify different types for different voices.

VA mode

The virtual-analog (VA) mode synthesizes three basic waveforms- sawtooth, pulse and triangle. Click on the waveform drawing to switch between the three different types. When the pulse waveform is chosen, you may additionally adjust its pulse width (see fig. 4.3). The default is 50%, corresponding to a square wave.

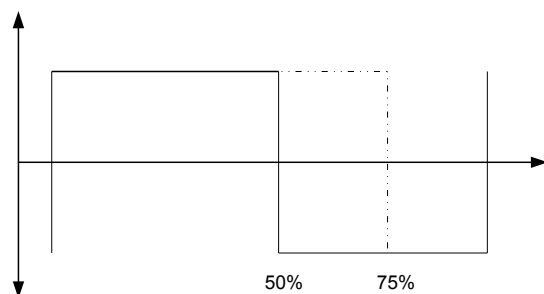

Figure 4.3: Pulse Width.

All three waveforms offer oscillator synchronisation, which is enabled by pressing the SYNC switch. Oscillator sync causes an oscillator to get periodically reset to zero phase, using a second "master" oscillator. Whenever the master oscillator has completed a cycle, it resets the "slave" oscillator. If the master oscillator has a lower frequency than the slave, the result is a new timbre, as the slave oscillator is not always able to complete a full cycle.

In contrast to traditional synthesizers, no extra oscillator is needed to perform oscillator sync in Dune. When sync is enabled, Dune automatically generates a virtual master oscillator needed to perform the synchronisation. The frequency of this oscillator is adjusted by the frequency knob (FREQ), relative to the given pitch. The sync frequency can be modulated using the modulation matrix.

WT mode

The Wavetable (WT) mode allows to choose an arbitrary periodic waveform from a wavetable. The waveform is selected by clicking on the waveform drawing in the same manner as in VA mode. Another way of setting the waveform is by changing the position knob. The position knob traverses the entire wavetable and allows to specify positions in between two waveforms for yet more versatility. The waveform position can also be modulated via the modulation matrix, to obtain complex, dynamic timbres with constantly changing waveforms.

By clicking on the wavetable popup, different wavetables can be selected. Wavetables can have a varying amount of waveforms stored in them, between 3 and 64 waveforms. Note that you can select different wavetables for different unison voices.

FM mode

Frequency modulation (FM) is a form of synthesis which can create a wide variety of sounds, but is especially known for bell type sounds. The FM mode uses three sine waves as a basis for sound generation, each sine wave is commonly referred to as an operator. Two operators "A" and "B" modify the frequency of operator "C". Two algorithms are available to choose from:

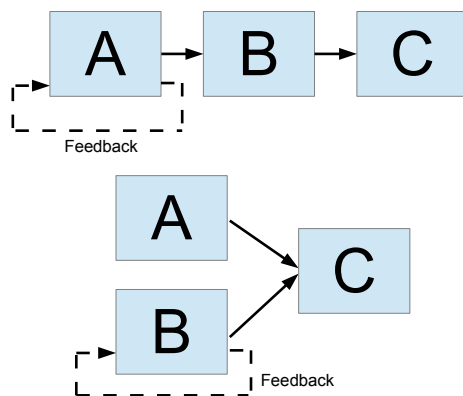

Figure 4.4: FM Algorithms.

In the first algorithm, operator A modulates the frequency of operator B, and the output of this operation modulates the frequency of operator C.

In the second algorithm, both operator A and B modulate the frequency of operator C.

Both algorithms have a feedback path, marked with a dashed line. Applying feedback creates more interesting timbres. The amount of feedback is controlled with the FBK knob.

In order to create interesting FM sounds, it is important to change the operator levels "A" and "B" over time. This can be accomplished by routing one or more MSEG curves on the destination labelled FM Amt A and FM Amt B. A slow, decaying envelope routed on the operator levels A or B will create sounds that start with a bright timbre, then become increasingly darker. A fast decaying envelope can create punchy sounds.

4.3 Oscillator 3

The third oscillator generates a simple periodic waveform, which can be chosen by clicking on the waveform display.

Semi

The control labelled SEMI adjust the coarse tuning of the third oscillator, in semitones. The range spans +/- 36 semitones. A larger range can be obtained by using the modulation matrix, if required. This will be covered in chapter 5.

Fine

This parameter adjusts the fine tuning of the oscillator in cents. A value of +/- 100% corresponds to half a semitone.

Reset

When reset is enabled, the oscillator will always start at the zero phase when a new key is pressed. When disabled, the oscillator starts with a random initial phase. A specific phase angle to start with can be set within the modulation matrix.

4.4 Noise Generator

All three oscillators generate periodic waveforms with a certain pitch. Sometimes it is useful, however, to spice up a sound with a random element that has no fixed pitch. This can be useful to synthesize percussive sounds, to recreate the behavior of wind or plucked string instruments during transients or to synthesize nature sounds such as fire, water or wind. For such sounds, Dune offers a white noise generator. White noise is a type of noise which contains an equal distribution of all frequencies.

Lowpass

The white noise emitted by the noise generator passes through a low-pass and high-pass filter, to further shape the timbre of the noise. The LP knob controls the cutoff frequency of the low-pass filter. Lower values cause a darker timbre.

Highpass

The HP knob controls the cutoff frequency of the high-pass filter. When set to zero it has no audible effect, at higher values the sound becomes increasingly thin and bright.

Width

Since the noise generator operates in stereo, it can emit noise for the left and right channels separately. The width parameter adjusts the stereo width — set to minimum the noise appears monophonic, set to maximum both channels have independent noise sources, resulting in a wide stereo image.

4.5 Ring Modulator

A further interesting effect that can be applied to the oscillator stacks 1 and 2 is to multiply them with each

other. This can be seen as one oscillator modulating the other in its amplitude (see fig. 4.5).

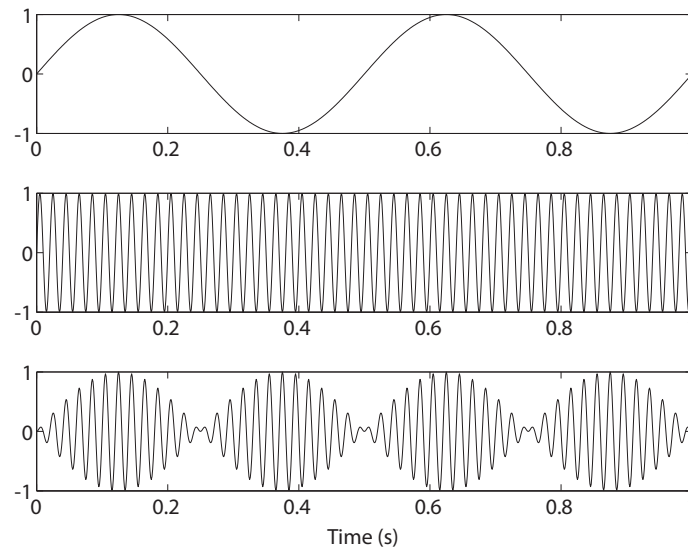

Figure 4.5: Ring modulation of two sine waves.

The effect depth can be controlled using the **RM** fader in the mixer section. Set to zero, the ring modulator output is disabled.

Mathematically, the result of ring modulation is that the sums and differences of both signal's frequencies are generated. If the oscillators are detuned, this will lead to very inharmonic, metallic sounds.

4.6 Mixer

The mixer section allows to control the level and panorama of oscillators 1-3, the ring modulator and the noise generator, before they enter the filter. All mixer parameters can be controlled via the modulation matrix too. This allows to fade in or out an oscillator, cross-fade between oscillators, modulate the panorama position, etc.

4.7 Filter Section

4.7.1 Filter Parameters

The raw sound coming from the oscillator sections is typically too bright to be useful. While many natural instruments like a flute or guitar start with a short, bright transient, they decay quickly to a much darker timbre. This behavior can be modelled by using a time-varying filter. The filter section is located in the middle of the user interface below the monitor.

Cutoff

Perhaps the most important filter parameter is the **CUTOFF** knob. It sets the corner frequency where the filter operates. Its meaning depends on the filter type chosen:

- For low-pass (LP) filter types, frequencies above the cutoff frequency are damped:

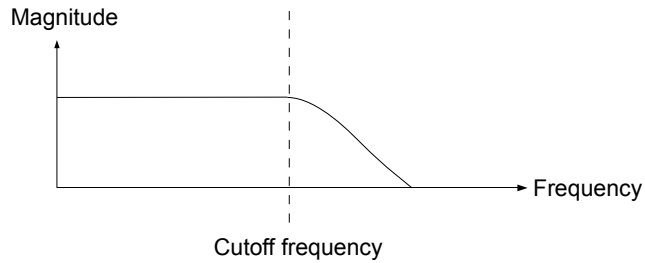

- A band-pass (BP) filter damps frequencies around the cutoff frequency. As a result, bass and treble get attenuated.

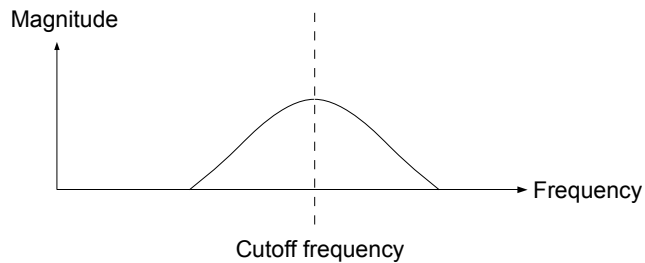

- A notch filter rejects frequencies around the cutoff frequency and passes everything else.

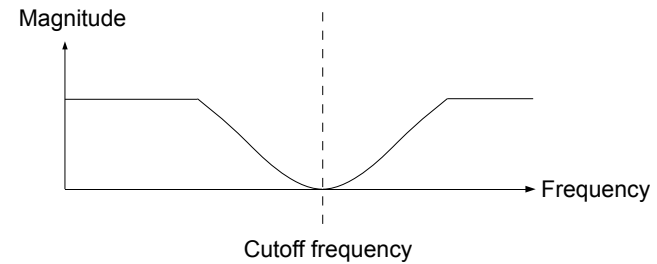

- A high-pass (HP) filter attenuates all frequencies below the cutoff frequency and passes the higher frequencies unchanged.

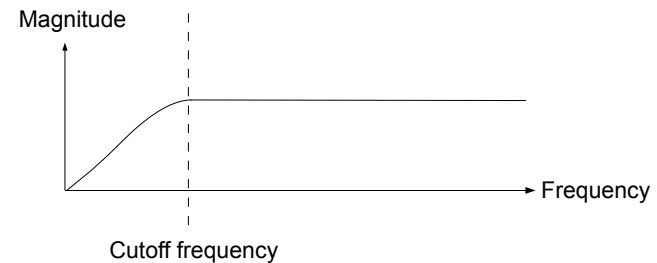

The filters described above form the basic filters encountered in most synthesizers. The low-pass filter is the most common, as it fully preserves the bass frequencies and allows the natural progression from a bright to a dark timbre when being modulated.

To modulate the cutoff frequency and produce a dynamically changing timbre, the MSEGs, LFOs and the filter envelope can be used. The most common way to control cutoff is the filter envelope, discussed later in this chapter.

Resonance

If the output of a filter is fed back to its input, resonance occurs, which is a sinusoidal oscillation near the cutoff frequency (see fig. 4.6). The RESO knob controls the depth of this effect. At lower settings, resonance can be used to add presence to a sound. Using higher settings, the sinusoidal oscillation gets strong enough to use the filter in a similar fashion as an oscillator. This property can be useful to create special effect sounds such as laser guns, electronic bass drums etc.

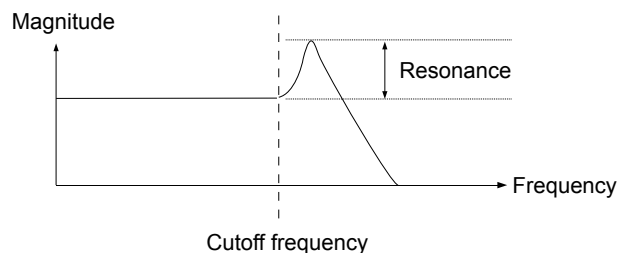

Figure 4.6: Response of a resonant low-pass filter.

Drive

The DRIVE knob sets the input gain of the filter. When using strong resonance, drive controls the mix between the filtered signal and the resonant peak. The lower the drive setting, the stronger the resonant peak. When using any of the transistor ladder filter models

(see below), drive will additionally saturate the signal, regardless of resonance.

Keytrack

The KTRK knob determines how much the cutoff frequency is affected by the MIDI key number. Set to zero, all notes share the very same cutoff frequency as specified by the **CUTOFF** parameter. Nonzero values move the cutoff according to the key pressed, with higher keys corresponding to higher cutoff frequencies. At low settings, this parameter is useful to create subtle timbre variations when different notes are played. At higher settings, key tracking can be used to simulate the properties of acoustic instruments that have a varying timbre dependent on the note played.

4.7.2 Filter Models

Dune 2 features a number of different filter models to choose from. All filters except the legacy Dune 1 filters are zero-delay feedback designs, which more closely resemble the response of analog filters. Furthermore, most filters can reach self-oscillation when turning up the resonance.

Clean Multi-Mode

The clean filter models resemble analog filters with a largely clean direct path, such as OTA-based ladder filters. Only the feedback path contains mild saturation, in order to prevent the resonance from ramping to infinity at high resonant levels. The clean nature of the filters and their moderate CPU usage makes them an excellent choice for many sounds.

- **CL Lowpass 2p**

A two-pole lowpass filter, with 12 dB attenuation per octave above the cutoff frequency.

- **CL Lowpass 3p**

A three-pole lowpass filter, with 18 dB attenuation per octave above the cutoff frequency.

- **CL Lowpass 4p**

A four-pole lowpass filter, with 24 dB attenuation per octave above the cutoff frequency.

- **CL Bandpass 2p**

A two-pole bandpass filter, with 6 dB attenuation per octave around the cutoff frequency.

- **CL Bandpass 4p**

A four-pole bandpass filter with 12 dB attenuation per octave around the cutoff frequency.

- **CL Highpass 2p**

A two-pole highpass filter, with 12 dB attenuation per octave below the cutoff frequency.

- **CL Highpass 4p**

A four-pole highpass filter, with 24 dB attenuation per octave below the cutoff frequency.

Transistor Ladder

The transistor ladder filters are exclusively low-pass types and resemble analog transistor-based designs. The key feature of those filters is that they contain saturation in all stages, thus coloring incoming signals even without any resonance applied. The transistor filters require substantially more CPU than the multi-mode filters, and thus should be only used where necessary. When choosing the 2, 3 or 4-pole variants, it is a good practice to compare the result with the corresponding clean filter, to see whether the sound is really better.

- **TR Lowpass 2p**

A two-pole lowpass filter, with 12 dB attenuation per octave above the cutoff frequency.

- **TR Lowpass 3p**

A three-pole lowpass filter, with 18 dB attenuation per octave above the cutoff frequency.

- **TR Lowpass 4p**

A four-pole lowpass filter, with 24 dB attenuation per octave above the cutoff frequency.

- **TR Lowpass 5p**

A five-pole lowpass filter, with 30 dB attenuation per octave above the cutoff frequency.

- **Acid Lowpass**

This special filter mimics a four-pole transistor network with unbuffered filter stages. The result is a rather dark timbre, unlike any of the other filter types.

Sallen-Key

The Sallen-Key filters are two-pole, multi-mode filter designs. What makes them special is the sound of the resonance, which is very different from all other filter models. The resonance is highly distorted, yielding a very aggressive sound.

- **SK Lowpass 2p**

A two-pole lowpass filter, with 12 dB attenuation per octave above the cutoff frequency.

- **SK Bandpass 2p**

A two-pole bandpass filter, with 6 dB attenuation per octave on either side around the cutoff frequency.

- **SK Highpass 2p**

A two-pole highpass filter, with 12 dB attenuation per octave below the cutoff frequency.

Dune

Dune 2 incorporates two filter types from Dune 1 ("Lowpass 12dB" and "Lowpass 24dB"), to facilitate creating patches that sound similar to Dune 1 patches.

- **Dune 2p**

A two-pole low-pass filter, with 12 dB attenuation per octave above the cutoff frequency.

- **Dune 4p**

A four-pole low-pass filter, with 24 dB attenuation per octave below the cutoff frequency.

4.7.3 Filter Effect

Dune 2 features a filter effect section, which allows to perform additional processing in series with the main filter. The filter effect can be processed before or after the filter. Click-and-drag either the filter or the effect box to change the order of processing. The order

of processing is particularly important when applying distortion to the signal.

- **Light Distortion**

Performs a mild distortion on the input signal. The input gain is adjustable using the AMOUNT knob, and determines the amount of distortion. The output of the distortion stage passes through a low-pass filter with adjustable cutoff frequency. Both the amount of distortion and the low-pass filter cutoff frequency can be modulated via the modulation matrix.

- **Hard Distortion**

A stronger distortion effect than the light distortion, with more gain and a different timbre.

- **Foldback**

Foldback is a special kind of distortion, where the signal is distorted along a bipolar curve such as a triangle or sine wave. The result is a rather extreme distortion. The sound of foldback distortion is often very digital and creates strong artifacts, so this effect must be used with some care.

- **Bitcrush**

The bitcrush effect reduces the dynamic range of the signal. The amount of reduction is controlled

using the AMOUNT knob. If the signal range is reduced to 2 bits, for instance, each sample passing through the filter is reduced to only 4 different states. Strong reduction makes the result sound somewhat similar to a square wave, and creates very strong digital artifacts. To tame the artifacts a little, the lowpass filter on the output can be used to roll off high frequencies.

- **Ratecrush**

Ratecrush is another effect which creates strong digital artifacts. Rather than reducing the dynamic range, Ratecrush employs a sample-and-hold circuit to reduce the sample rate.

- **Halfrect**

The half-wave rectifier effect nulls the negative half-wave of the incoming signal. Note that the signal level should be 0 dB for this effect to work best, otherwise a temporary DC offset may occur which results in a short audible "thump" noise when pressing a key.

- **Fullrect**

The full-wave rectifier effect mirrors the negative half-wave of the incoming signal, such that it becomes positive. Note that the signal level should be 0 dB for this effect to work best, otherwise a temporary DC offset may occur which results in

a short audible "thump" noise when pressing a key.

- **Low Cut with Keytrack**

A low cut filter which is tuned to the MIDI note played. The result is a filter which will attenuate the fundamental frequency of a sound, as well as the first few overtones. The amount knob controls how strong this attenuation is.

- **Lowpass 1p**

A basic one-pole lowpass filter with 6 dB attenuation per octave. The cutoff frequency is controlled via the AMOUNT knob, and can be modulated via the modulation matrix. The extra filter can be used to fine-tune the response of the main filter, for example a 2-pole bandpass filter could be turned into a 3-pole filter. Another option is to apply different modulation to the main filter and the extra filter.

- **Lowpass 2p**

A two-pole lowpass filter with 12 dB attenuation per octave.

- **Highpass 1p**

A one-pole highpass filter with 6 dB attenuation per octave.

- **Highpass 2p**

A two-pole highpass filter with 12 dB/oct attenuation.

- **Notch**

A two-pole notch filter.

4.7.4 Filter Envelope

An envelope controls a sound parameter over time, starting from the instant a key is pressed (see fig. 4.7). The filter envelope is designed specifically to control the filter cutoff frequency, but can be used to control other parameters too via the modulation matrix.

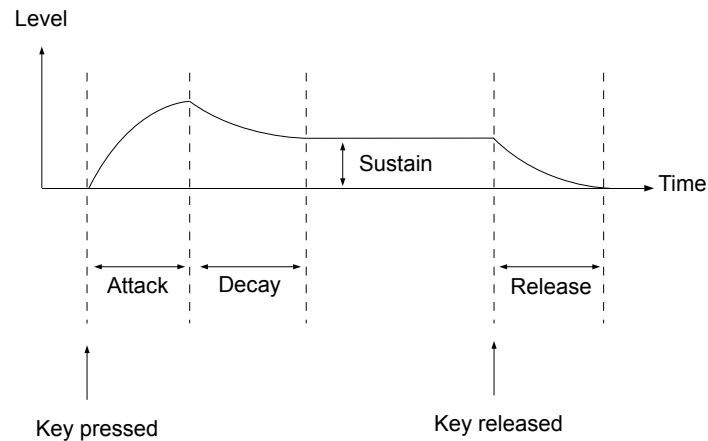

Figure 4.7: The filter envelope.

Amount

The AMT knob controls how much the filter envelope affects the cutoff frequency. Set to zero, the filter envelope has no effect on the cutoff frequency. At 100%, the envelope spans the entire cutoff range from the

minimum to the maximum value. Most sounds will use a low-pass filter with an envelope amount setting in between the two extremes and the envelope attack and sustain set to their minimum values. This creates the most common timbre which is a bright start followed by a darker sustain stage, a property shared by many acoustic instruments. Note that when a dual filter is used, the filter envelope affects both filters simultaneously.

In rare cases, you may also want to set the envelope amount to a negative value. This can be helpful to create sounds which become bright when releasing a key. A negative envelope amount can be set using the modulation matrix, with the envelope amount knob set to zero.

Attack

The ATTACK parameter specifies the duration it takes for the envelope to reach its maximum value. Most sounds use a setting near the minimum in order to start bright.

Decay

After reaching the peak, the decay stage commences. During the decay stage, the envelope falls back to a lower level, the sustain level. The DECAY control

specifies the duration of the decay stage, i.e. how long it takes to fall back to the sustain level.

Sustain

This parameter specifies the sustain level that is reached after the decay stage ends. The sustain stage lasts as long as a key is pressed.

Release

The final release stage is triggered whenever a key is released. The release parameter specifies the duration it takes the envelope to hit zero. Note that when the sustain level is set to zero, the release parameter may have no effect if the envelope has previously reached zero already.

4.8 Amplitude Envelope

Located below the Filter envelope, the amplitude envelope controls the progression of the volume of a sound (see fig. 4.8). It works in the same manner as the filter envelope.

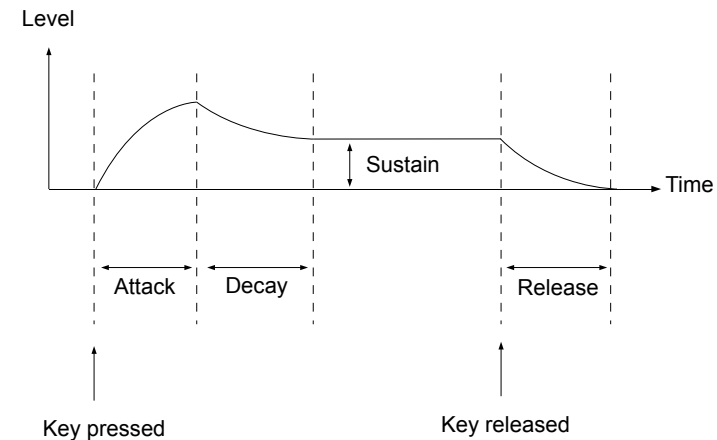

Figure 4.8: The amplitude envelope.

Level

Controls the level of the amplitude envelope, which simply boils down to the overall level of the current voice. If you wish to modulate the volume of a patch, this is usually the right destination parameter to choose.

Attack

The ATTACK parameter specifies the duration it takes for the amplitude envelope to go from zero to its maximum level.

Decay

The DECAY parameter specifies the duration of the decay stage, i.e. how long it takes the amplitude to fall back to the sustain level.

Sustain

This parameter specifies the sustain level that is reached after the decay stage ends. The sustain stage lasts as long as a key is pressed.

Release

The final release stage is triggered whenever a key is released. The release parameter specifies the duration it takes the envelope to hit zero. Note that when sustain is set to zero, the release parameter may have no effect if the envelope has previously reached zero already.

4.9 Unison Voices

The unison voices section is located at the top right of the interface, between the monitor and the master section.

Dune allows to use multiple voices for any note played. This is useful to for a variety of tasks, the

most common being to create the illusion of many instruments playing simultaneously (e.g. a string section). Another useful application is to stack different sounds.

In order to cause an audible change, multiple voices must differ in one or more sound parameters. The most common change is to slightly detune the stacked voices, resulting in thick chorus-type effects, as well as to stereo-spread the voices to make sounds more spatial. To increase ease of use, both detune and spread can be performed directly via the knobs in the unison section. Other sound parameters can be modified per voice either by using the modulation matrix (see chapter 5), or by editing the voices separately (section 4.10).

Amount

This parameter sets the number of voices to use for each note played. When set to two voices, for instance, each key press will trigger two unison voices. Note that the CPU usage doubles as the number of unison voices is doubled, since two voices per key mean twice the processing. In contrast to Dune 1, the number of unison voices does not affect the polyphony in any way — so two unison voices at a polyphony of four means that up to eight voices will be needed. The MAIN monitor displays the current number of active voices, as well as the maximum possible.

Detune

This parameter detunes the unison voices. Higher settings correspond to more variation. A minimum of two voices is necessary to get an audible change. The detuning is centered around the main note pitch. When playing e.g. A4 (440 Hz) and detuning two voices by 1 Hz, the two pitches would be 339 Hz and 441 Hz, thus still creating the sensation of a 440 Hz note.

Spread

Spreads the unison voices in the stereo field. A minimum of two voices must be dialed in to create an audible effect. At maximum position, the voices will be fully spread in the stereo field — in the case of using two voices, one voice will be panned hard left and the other one hard right. In case of three voices, one voice will be panned hard left, one dead center and one hard right, etc.

Solo

Allows to solo individual voices. Note that only voices that are actually in use can be solo'ed. Pressing solo on the 4th voice of a 3-voice patch will thus lead to silence.

4.10 Voice Edit/Common

The voice edit section is located just below the unison voice section. This section allows to edit all unison voices combined (ALL), or to select individual voices. Each unison voice has its own set of parameters, which means you can stack up to 8 different sounds. The sound parameters available per voice include all oscillator parameters, the mixer, filter, filter effect, as well as the filter and amplitude envelope (see fig. 4.9).



Figure 4.9: Voice parameters.

To copy a unison voice, choose one of the unison voices 1-8, then press COPY. Choose the destination voice, then hit PASTE to overwrite its settings.

Glide

The glide knob controls the pitch glide effect for successive notes. Turned fully to the left, there is no glide. Towards higher settings, the pitch glide time increases. Each unison voice can have its own glide time.

Arp

The arp button enables or disables the arpeggiator. Each unison voice can have the arpeggiator enabled or disabled for increased versatility.

FX 1

Enabling this button sends the voice through the first FX Bus. The FX bus can be enabled or disabled for each voice separately.

FX 2

Enabling this button sends the voice through the second FX Bus. The FX bus can be enabled or disabled for each voice separately.

4.11 Master

The Master section contains basic performance parameters and allows to set the global volume.

Polyphony

The polyphony popup menu allows to specify how many notes can be played simultaneously. The main purpose of limiting the polyphony is to limit the CPU usage, as less voices need to be rendered.

A polyphony of 4 means that 4 keys can be held down simultaneously, pressing a fifth key will cut one of the existing voices. Note that when sounds have long release times (e.g. pads, strings), it is a good idea to choose a polyphony of 12 or 16 even when only playing a few notes at a time. Otherwise, old notes get cut which can lead to clicks.

When choosing Mono or Legato, only one note can be played at a time. Legato allows to smoothly go from one note to another without retriggering the envelopes. This can be useful for bass and lead sounds, particularly in combination with the glide knob. It creates a unique playing feel and sound which can be better for monophonic lines. Using mono or legato modes also results in the smallest CPU usage possible.

Volume

Sets the overall volume of the entire synthesizer.

MIDI In

This red indicator lights up on incoming MIDI note events, as well as MIDI controller messages.

4.12 MSEGs

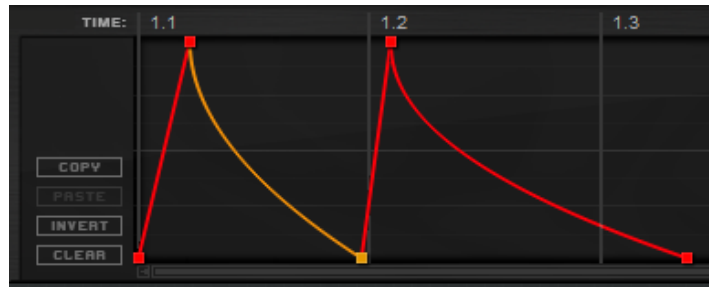

Dune 2 introduces four graphical envelopes called MSEG (Multiple Segment Envelope Generator). Graphical envelopes allow precise and customizable adjustment of sound parameters over time, and thus serve as an important modulation source. MSEGs can be looped, which allows to create rhythmic gate effects (for instance the classic "trance" gate sound), or they can act as low-frequency oscillators with custom shapes.

Using the editor

- Create new points either with the left mouse button (double-click), or with the middle mouse button (single-click).
- Delete points with the right mouse button.
- Move points by clicking on them with the left mouse button, then moving them in any direction.
- Change the curve shape of a segment by clicking on it with the left mouse button, then drag the mouse up or down.
- Set precise values by holding down shift when dragging the mouse up or down.

Four buttons are located on the left side of the editor:

- **Copy** copies the MSEG into the clipboard.
- **Paste** replaces the current envelope with an envelope stored in the clipboard.
- **Invert** mirrors all points vertically.
- **Clear** deletes all points in the envelope.

Mode

MSEGs can be used in four different modes:

- Note On starts the MSEG when pressing a key, then traverses the envelope until the last point is reached. Note that MSEGs are polyphonic in this mode when modulating voice parameters (such as pitch), ie each voice keeps its own envelope position.
- Note Off triggers the MSEG when releasing a key. MSEGs are polyphonic in this mode too.
- Key On mode is identical to Note On, except when the arpeggiator is enabled. Note On will react to every note that is triggered by the arpeggiator, while Key On will only react to actual MIDI keys pressed. Key On mode thus allows modulation of an arpeggiated sequence as a whole, for example the mode can be used to fade in an arpeggiated sequence.
- Loop mode periodically loops through the envelope. MSEGs are monophonic in this mode, ie all MSEG destinations receive the same signal. This is important when using the envelope for trance gate and other rhythmic effects, synchronized to the song tempo.

Sync

When the sync switch is off, the envelope operates in seconds. The time line shows seconds, and the maximum length can be adjusted in seconds.

If the sync switch is on, the MSEG operates in sync with the host tempo. The time line is switched to a musical notation in the format "bars.quarters" (e.g. 4.2 means the second quarter note in the fourth bar).

Rate

Adjusts how fast the envelope is traversed. When the **SYNC** switch is disabled, the rate knob simply scales the entire envelope from 1/10th to 10 times the duration. Set to center, the envelope time is unaffected by the rate knob — an envelope spanning 1 second takes exactly 1 second to complete.

When sync is on, the envelope duration is scaled with musically meaningful values, in order to keep the sync with the host tempo. Setting the rate knob to half a bar (1/2) will traverse the envelope twice as fast as the default of one bar (1/1), for instance. For more sophisticated effects, Triplet (T) and dotted (*) values can be dialed in.

The MSEG rate can be modulated via the modulation matrix. Note that this only works when sync is disabled.

Length

The maximum duration of the envelope. The meaning depends on the rate knob and the sync switch. If sync is disabled and rate set to center, the maximum duration is given in seconds.

Velocity

With the Velocity knob, the envelope amount can be varied according to the velocity of the MIDI key pressed. At default center position, the velocity has no effect. Set to negative values, low velocities will have a stronger effect than high velocities. Set to positive values, higher velocities increasing the envelope amount.

Making envelope amounts velocity-dependent is particularly important for FM sounds. Low velocities typically correspond to low envelope amounts (resulting in a soft sound), while high velocities typically correspond to high envelope amounts (causing a brighter, more aggressive sound).

Keytrack

The key track knob allows to make the envelope rate dependent on the MIDI key number pressed. Usually key tracking is set to zero, so the MIDI key number has no effect on the envelope. The higher the key track

value, the shorter the envelope when pressing higher keys. The purpose of key tracking is to imitate the behavior of acoustic instruments such as the guitar — high notes on the guitar decay more quickly than low notes.

Key tracking requires the sync switch to be turned off, otherwise it has no effect.

4.13 LFOs

Using oscillators, the filter and envelopes, it is possible to control the basic properties of a sound, such as timbre, volume and pitch. For bass and percussive sounds this may be enough to get good results, but for pad or lead type sounds, the sustain stage can still sound dull. This is because the pitch, filter cutoff and volume are steady in this stage and do not change.

This is where LFOs (low frequency oscillators) come into play. LFOs work similar to ordinary oscillators, and usually generate a periodic signal using similar waveforms (see fig. 4.10). LFOs are inaudible, however, their only purpose is to continually change one or more aspects of the sound. The most typical applications are modulating the volume, cutoff or pitch, resulting in a vibrato or tremolo effect. Dune's three LFOs are much more capable than that, however, as almost any sound parameter can be used as a modulation destination. Additionally, LFOs can modulate

each other in volume or frequency to obtain yet more interesting variations.

The three LFOs are accessed by clicking on the LFOs tab. Assigning destinations to LFOs and adjusting the modulation depth is performed in the modulation matrix, which is covered in the fourth chapter of this manual.

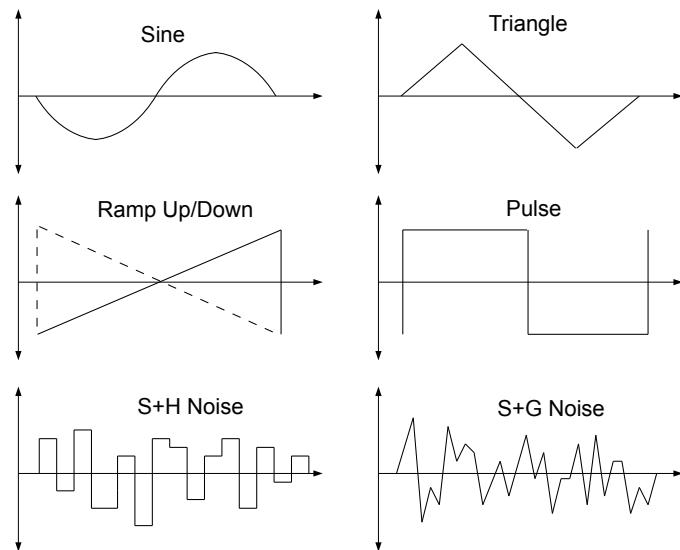

Figure 4.10: LFO waveforms.

Shape

Clicking on the shape popup menu allows to select one of the waveform shapes depicted in fig. 4.10.

Ramp, Pulse, Triangle and Sine are periodic waveforms, while S+H noise (Sample-and-Hold), as well as S+G noise (Sample-and-Glide) are random signals. Random modulation signals are useful for special effects or to simulate the behavior of old analog hardware, by choosing a very slow and subtle modulation.

Rate + Sync

By default, LFOs run at a constant rate specified in Hz, independent of the MIDI note played. Typical settings are between 3-6 Hz for vibrato or tremolo effects. When the **SYNC** switch is enabled, the rate is specified in units of the current song tempo, such as quarters, eighths or sixteenths notes, with either their standard durations, or in triplet (T) or dotted (*) form. Examples:

- 1/4 specifies the duration of a quarter note.
- 1/8+ sets the modulation rate to a dotted eighth note.
- 1/16T sets the modulation rate to a sixteenth triplet.
- 1/1 sets the modulation rate to span one bar.
- 2/1 sets the modulation rate to span two bars.

Poly

By default LFOs operate in a global fashion, ie all voice destinations receive the same LFO signal. When the **POLY** switch is enabled, however, each voice uses its own, local LFO. This allows to set up modulations which always start at zero phase, for instance.

Fade-in

Usually modulations start immediately when a key is pressed and last for the entire duration of the sound. Sometimes, however, strong modulation can be objectionable in the early attack stage of the sound. To preserve the transients, the fade-in parameter can be used to gradually increase the modulation from zero to its maximum value, for a duration specified in seconds.

Amount

This knob adjusts the amount of LFO modulation that takes place. This is useful to fine-tune the overall amount of modulation in combination with the modulation matrix. Furthermore, the amount knob itself can be modulated via the modulation matrix. This allows to vary the modulation amount over time, for instance with a second LFO or an envelope.

4.14 Effect Bus 1+2

Dune 2 offers two effect busses with nine effects in each to further enhance the sound. All of them may be used simultaneously, and most units offer several sub-types to further increase their versatility. Note that all effects are global, that is all voices enabled for a specific effect bus are first summed and then processed by the effect bus.

The effects are processed from left to right in the order they appear. By default, the distortion is applied first and reverb last. You can modify the effect order, however, by dragging the individual sections. When you click on an effect label (e.g. "Delay") a red border will appear. Keep the mouse button pressed, and move the effect into any spot you like. Note that changing the effect order is not necessarily audible. The most significant change usually occurs when moving an active(!) distortion or compressor effect to a different position.

4.14.1 Distortion

A distortion effect changes the signal in a nonlinear manner, which creates new overtones and usually results in a harsher sound. Dune 2 offers a variety of different distortion types:

Type

- **Crunch** simulates a typical guitar pedal distortion effect.
- **Overdrive** simulates a typical guitar overdrive effect.
- **Grunge** is a distortion effect which specifically simulates the vintage DS-1 pedal, popularized by its usage in Grunge music.
- **Triode Amp** models a typical valve-based guitar amplifier head.
- **Hard Clip** boosts then simply hard-clips the signal at 0 dB.
- **Bitcrush** reduces the dynamic range of the signal to a low bit depth.
- **Ratecrush** reduces the sample rate of the signal, using a sample-and-hold circuit.
- **Exciter** is an effect which distorts only the high frequencies of the signal, leaving other frequencies largely unaffected.

Note that the Hard Clip, Bitcrush and Ratecrush effect can sound very digital and harsh at high drive settings, so those effects should be used with some care.

Tone

Tone usually controls the mid frequencies of the output signal, with the center position resulting in a largely neutral sound. The implementation differs dependent on which distortion type is chosen, however, so the effect can vary.

Dry/Wet

Blends between the dry and processed signal. For guitar-type distortion effects, this parameter should be typically set to 100%. For all other types, it is often a good idea to try much smaller values.

4.14.2 EQ 1

An equalizer (EQ) is used to boost or attenuate a certain frequency range. This is useful to e.g. add more bass to a sound, increase its presence, or to achieve formant-type effects. Dune features a classic 3-band equalizer:

- The **Low Shelf EQ** amplifies or attenuates frequencies below the chosen frequency.

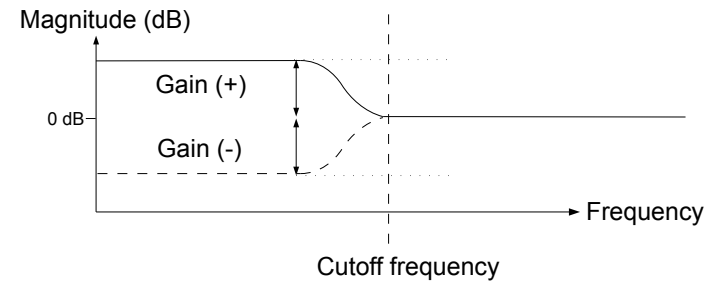

Two parameters are available, the frequency of operation and the gain. Gain specifies how much to attenuate or boost the chosen frequency. At center position (0 dB) the signal is not affected in any way.

- The **Peaking EQ** amplifies or attenuates the region around the chosen frequency.

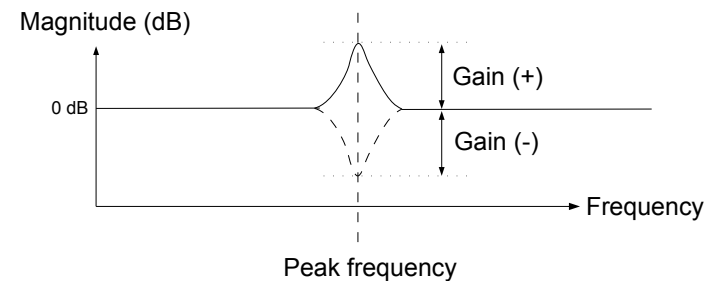

The peaking EQ offers a frequency and gain parameter like the Low Shelf EQ, additionally a

"Q" parameter to control the steepness of the curve:

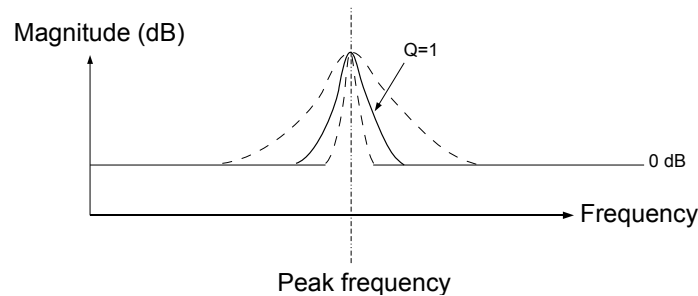

- The **Hi Shelf** EQ with a frequency and gain parameter amplifies or attenuates frequencies above the chosen frequency.

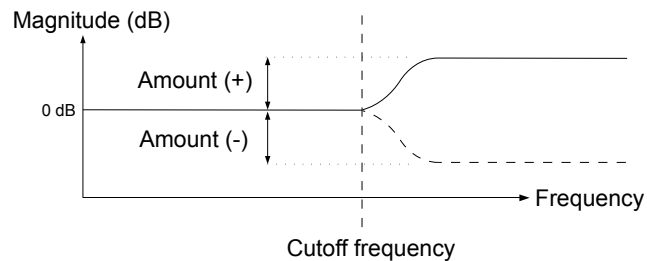

4.14.3 EQ 2

This section is identical to EQ 1 and allows further processing of the signal. For example, two different

frequency regions can be boosted. Another application is to move one EQ to the left side of the distortion and one to the right. This allows to control the sound both pre- and post-distortion, which is useful to fine-tune the overall timbre.

4.14.4 Phaser

A phaser modifies the phase of the signal around some frequency, then adds it back to the original signal. The result is a notch in the frequency spectrum. By varying the operation frequency periodically with a LFO, the typical sweeping sound of a phaser is achieved.

Type

The phaser can use between 2 and 12 stages. Each pair of stages produces one notch in the frequency spectrum, so e.g. two stages produce one notch. More stages result in more notches, which increases the phasing effect.

Rate + Sync

Sets the modulation rate of the effect in Hertz (Hz). When the **SYNC** switch is enabled, the rate is specified in units of the current song tempo, such as quarters, eighths or sixteenths notes, with either their stan-

standard durations, or in triplet (T) or dotted (*) form. Examples:

- 1/4 specifies the duration of a quarter note.
- 1/8+ sets the modulation rate to a dotted eighth note.
- 1/16T sets the modulation rate to a sixteenth triplet.
- 1/1 sets the modulation rate to span one bar.
- 2/1 sets the modulation rate to span two bars.

Spread

Adjusts the width of the notches produced by the phaser. Usually 100% sounds best.

Feedbk

The output of the phaser can be fed back to its input, creating a resonant sweep. Both positive and negative feedback is possible, at center position there is no feedback.

Freq

Sets the lowest frequency the Phaser . For the Chorus/Flanger types, this parameters specifies the fre-

quency range to include. Usually this should be set to 100% to include the entire frequency spectrum.

Depth

Sets the modulation depth of the LFO. Set to zero, there is no modulation and thus no sweeping effect, the sound will be static. When increasing the modulation depth, the phaser operates on a larger frequency region, which increases the sweeping effect.

LR Offset

Since the phaser operates in stereo, both channels have their own LFO. With the offset knob, the relative phase difference between both channels can be adjusted from 0 to 180 degrees. Set to zero, both channels produce an identical sweep. Set to nonzero, both channels will operate on different frequency regions, making the effect more spatial.

Dry/Wet

Mixes the dry and processed signal. Since the phasing effect is achieved by mixing the original and processed signal, the mix ratio should be typically around 50%. Lower values can be useful to make the effect more subtle, however, and higher values can be useful with strong feedback.

4.14.5 Chorus

A chorus or flanger effect is obtained by summing a signal with a delayed copy of itself. When the delay is continuously varied with a low-frequency oscillator and separately for the left and right channel, the sound becomes thicker and more spatial. Using smaller delay times and adding feedback results in a flanging effect.

Mode

- **Single** simulates a standard chorus effect with one delay line for each channel.
- **Dual** uses two delay lines per channel, to obtain a yet thicker sound.

Offset

Adjusts the minimum delay time. Medium to high settings are useful to create a typical chorus affect, while low values are useful for flanging.

Rate

Sets the modulation rate of the effect in Hertz (Hz).

Depth

Sets the modulation depth of the LFO. Set to zero, there is no modulation and thus no sweeping effect, the sound will be static.

LR Offset

Since the chorus operates in stereo, both channels have their own LFO. With the offset knob, the relative phase difference between both channels can be adjusted from 0 to 180 degrees. Set to zero, both channels produce an identical sweep, while nonzero values make the chorus effect more spatial.

Feedbk

The output of the chorus delay lines can be fed back to their input, creating a resonance effect. Both positive and negative feedback is possible, at center position there is no feedback. For a classic chorus sound, the feedback should be set to zero. For flanging effects, use strong positive or negative feedback.

Dry/Wet

Mixes the dry and processed signal. Since the chorus effect is achieved by mixing the original with a delayed copy of itself, the mix ratio should be typically around

50%. Lower values can be useful to make the effect more subtle, however, and higher values can be useful with strong feedback.

4.14.6 Delay 1+2

A delay effect produces a series of echoes — the duration of the echoes is usually locked to the host tempo. A total of five delay programs are available. Two delay instances allow to obtain more complex echo patterns, in particular when both delay instances are set to different rates or use different programs.

Type

- **Simple** creates a series of echoes centered in the stereo field.
- **Simple+Offset** is identical to the Simple delay, except that the right channel is delayed. When both channels use the same delay time, this sounds like a ping-pong delay except for a missing first echo.
- **Ping-Pong** creates echoes alternating between the left and right channels.
- **Dual Ping-Pong** uses two ping-pong delay units, one for each channel. The result is a pair

of echoes alternating between the left and right channel.

- **Diffuse** works similar to the Simple delay, except that each echo becomes increasingly diffuse.
- **Tape** works similar to the Simple delay, except that each echo becomes increasingly distorted.

L/R-Rate + Sync

The delay time can be specified independently for the left and right channels. By default the delay times are synced to the host tempo and are thus specified in quarters, eighths, sixteenths etc., optionally in triplet (T) or dotted (*) form. Examples:

- 1/4 specifies an echo duration of a quarter note.
- 1/8+ sets the duration to a dotted eighth note.
- 1/16T sets the duration to a sixteenth triplet.
- 1/1 sets the duration to span an entire bar.

Turning off **SYNC** allows to specify the delay time in milliseconds (ms), for each channel separately. When using very short delay times (e.g. 1 ms), the ear can no longer perceive the individual echoes as such. The result is a comb-filter effect which can sometimes sound interesting. Turning off sync also allows to modulate

the delay time via the modulation matrix, useful to obtain special effects.

Low Cut

The echoes can be processed by a 6 dB/oct lowpass filter, making each subsequent echo darker. Set to zero, the lowpass filter is disabled.

High Cut

The echoes can be processed by a 6 dB/oct highpass filter, making each subsequent echo brighter than the previous one. Set to zero, the highpass filter is disabled.

Width

By default, all delay programs operate in full stereo. When using the ping-pong delay, for instance, the generated echoes will alternate between the left and right speakers, with no signal in the center. If this effect feels too strong, the width knob can reduce the stereo image, all the way down to mono.

Feedbk

The feedback parameter adjusts how long the echoes are repeated. The percentage specifies the level change

from one echo to the next, so 100% creates an infinite series of echoes, 50% cuts the level of each subsequent echo in half etc.

Mod-Rate

All delay programs allow to modulate the delay time with a LFO. The modulation rate parameter adjusts the LFO rate in Hertz (Hz).

Mod-Amt

The amount knob adjusts the modulation depth. Set to zero, no modulation takes place, the echoes sound rather static. Small modulation amounts cause the delay to sound slightly more organic, as the delay constantly varies a little over time. Large modulation amounts cause a noticeable strong pitch modulation, which can be used for special effects.

Dry/Wet

Blends between the dry and processed signal.

4.14.7 Reverb

A reverb effect is used to create the illusion of a sound being played back in a spatial environment such as a

living room, hall or cathedral. Six different algorithms are offered in Dune 2:

Type

- **Ambience** is a program useful for subtle reverbs of short to medium duration, e.g. 1-2 sec.
- **Big Room** simulates a large room, designed for a reverb time around 1 sec.
- **Chapel** simulates a larger chapel, good for reverb times of 2-3 sec.
- **Gated Room** is a special-purpose program giving the impression of a very small space, ending abruptly. This program is limited to a maximum reverb time of approximately 0.5 seconds and should be used with some predelay for best effect.
- **Plate** is a highly diffuse reverb program, it does not simulate a particular space.
- **Hall** simulates a hall of various sizes (Small/Medium/Large). The algorithm works well with reverb times of 3-5 seconds and above.
- **Slapback Hall** simulates a hall with strong early reflections occurring after a few milliseconds.

- **Stadium** simulates a very large reverberant space.

Predelay

Adjusts the onset of the reverberated signal. When set to zero, the reverberated signal commences almost immediately. Higher settings delay the signal, which can be useful to change the perception of the room size.

Time

This parameter adjusts the reverb time in seconds. Reverb time is defined as the time it takes the wet signal to reach -60 dB. Note that the displayed value is an approximation, and that other parameters like high-frequency damping can shorten the perceived reverb time.

HF Damp

The high-frequency damp parameter changes the simulated room's wall materials. Low settings correspond to reflective walls (bright, uncolored sound), high settings to very absorbent walls (progressively darker timbre).

Low Cut

The low-cut filter in the reverb effect can be used to remove unwanted low frequencies from the processed signal. This is useful for sounds containing strong bass frequencies, such as bass drums etc. Note that the dry signal is not affected by this parameter, only the reverberated signal.

Color

The color parameter can be used to equalize the mid frequencies of the reverberated signal. At center position the reverberated signal is unaffected. Turning the knob to the left cuts the mid frequencies, turning it to the right boosts the mid frequencies.

Mod-Amt

All reverbs in Dune 2 employ modulation, to generate a rich timbre. The modulation amount parameter adjusts how strong this modulation is. At low s

Dry/Wet

Blends between the dry and processed signals.

4.14.8 Compressor

The purpose of a compressor is to reduce the dynamic range of a signal, which increases the perceived loudness and can reduce clipping problems in a digital environment. A compressor performs dynamic range reduction by lowering the level of loud passages. What is considered "loud" is specified by the user, in form of a threshold level given in decibel (dB).

Type

Two compressor types are available:

- **Air** is a good general-purpose compressor. This compressor is very transparent for low compression ratios and works on a wide range of input signals.
- **Vintage** simulates a vintage analog broadband compressor, which saturates the signal. Good for bass sounds.

Input

Adjusts the input level. The input level affects the amount of compression, and should be adjusted such that the level meter peaks around 0 dB.

Ratio

Ratio tells the compressor how much to lower those passages that are louder than the threshold. A ratio of 1:1, for example, means that the sound comes out 1 to 1 - as it is - the compressor does not do anything. At a ratio of 2:1, the loud passages will be lowered by a factor of 2 — they will come out only half as loud as they were when they came in. At a ratio of 4:1, they will come out 4 times softer, and so on. So the Ratio setting effectively decides how much the passages above the threshold will be compressed.

Refer to the image below for a graphical representation of the compression input/output ratio. The image shows ratios 1:1, 2:1 and 100:1. At the highest setting 100:1, the compressor will act as a limiter, and will not pass any signal levels above the threshold.

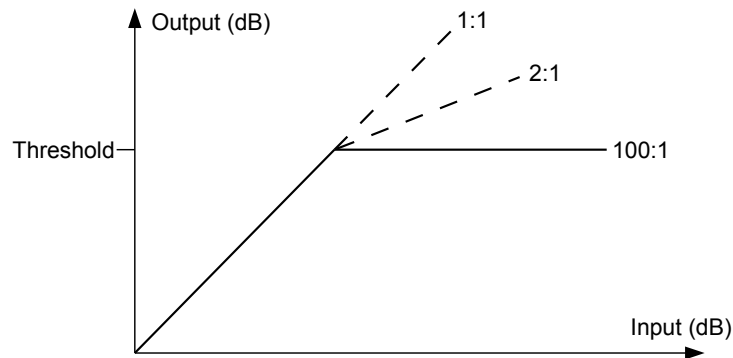

Threshold

The threshold knob sets the level at which a passage is considered "loud" — that's the point at which the compressor will start working. For example, if you set the threshold to -16 dB, then everything below that level will pass straight through, while anything above -16 dB will be attenuated according to the ratio setting.

Attack

The attack parameter adjusts the time it takes for the compressor to react to a signal exceeding the threshold. The attack time involves a trade-off: Short attack times usually sound more transparent, but can also cause distortion artifacts on some signals when the compressor reacts too quickly. Long attack times usually do not cause distortion problems, but fast transients pass through uncompressed which sometimes sounds objectionable.

Release

The release parameter adjusts the time it takes for the compressor to recover when the threshold is no longer exceeded.

Output

Adjusts the compressor output level in decibel (dB).

Dry/Wet

Blends between the dry and processed signals. While a compressor is traditionally used 100% wet, mixing in the dry signal has become a popular trick known as "parallel" or "New York" compression.

5 Modulation Matrix

One of the biggest strength of subtractive synthesizers is their ease of use. The pitch, timbre and volume of a sound and its progression over time can be controlled in a simple and straightforward way. The simplicity is achieved by employing a fixed structure with a limited set of parameters, however.

In order to create more complex patches, modern synthesizers offer a modulation matrix, where you can choose from a set of sources and link them to almost any sound parameter:

	SOURCE	AMT	DESTINATION	VOICE
1	Filter Env	+27	Pitch Semi	1
2	Const	0	Osc 1 KeyTrack	1+2+3
3	Filter Env	+3	Osc 1 Semi	2
4	MSEG 1	+100	Amp Level	1
5	MSEG 2	+86	Amp Level	2
6	MSEG 3	+48	Amp Decay	3
7	Random	+36	Osc 1 Semi	4
8	MWheel	+100	Amp Level	4

The modulation matrix in Dune is located in the center of the interface, and accessed by clicking on the Mod Matrix button. Up to 32 source/destination combinations are possible per patch.

Most importantly, the sources comprise the LFOs. The ability to link a LFO to any sound parameter makes the traditional LFO destination parameter obsolete and offers far greater flexibility. Classic destination parameters include Pitch (to obtain a vibrato effect), Volume (to obtain a tremolo effect) as well as Filter Cutoff. Further sources include the graphical envelopes (MSEG 1-4), which also must be assigned to a destination in the modulation matrix to work. Typical destinations for the graphical envelope generators include pitch, volume, or the amount of frequency modulation (FM) when using FM synthesis.

The modulation matrix is also used to assign MIDI performance controllers to sound parameters. The modulation wheel or expression pedal, for instance, can be chosen as a source and linked to any destination parameter. The effect of note velocity is also controlled from within the modulation matrix. While typically linked to volume, it can be easily set to affect the filter cutoff frequency or other sound parameters.

Advanced users will appreciate the ability of the modulation matrix to modulate itself, by choosing any of the 32 modulation slots as a destination.

5.1 The differential unison engine (DUNE)

Traditionally, unison on synthesizers means "playing all voices simultaneously". In unison mode, a classic synthesizer with 8 voices simply fires all 8 voices simultaneously when pressing a key. The different voices are slightly detuned, which provides a chorus type effect and thus an overall fat sound, when playing a note. Unfortunately, firing all voices at once means that polyphonic play is no longer possible, as all available voices are in use. Hence, modern synthesizers use a more sophisticated unison mode, which allows to set an arbitrary number of unison voices that is only a subset of the total number of available voices. For example, a synthesizer with a maximum of 32 voices may offer the option to trigger 4 unison voices simultaneously. This still allows to play 8 notes at the same time ($32 / 4 = 8$). Another feature that is very common in today's synthesizers is the ability to specify an arbitrary detuning and stereo spreading of all unison voices. A synthesizer which employs 2 unison voices may detune both and spread them to the left and right side of the stereo panorama, which creates a very spacious effect. The Synapse Audio WASP is such a synthesizer.

The idea behind Dune is to make the power of the unison mode accessible to sound designers. Why re-

strict the unison mode to just detuning or panorama changes? In Dune, any sound parameter can be changed in any unison voice, relative to the basic parameter settings. This is accomplished by the modulation matrix. Apart from the classic source, amount and destination parameters, Dune adds the "Voice" parameter, which allows to restrict the modulation to one or more unison voices. This concept is best explained by a simple example matrix:

	SOURCE	AMT	DESTINATION	VOICE	
1	LFO 1	+50	Filter Cutoff	--	▲
2	LFO 2	+89	Amp Pan	2	
3	LFO 3	+24	Amp Level	3	

In this example, we have assigned all three LFOs to three different destinations: Filter Cutoff, Pan (Panorama) and Volume. In the first row, the Voice field is left blank, which simply means to apply the modulation to all unison voices in use. If the number of unison voices is set to e.g. five voices, then the filter cutoff will be modulated in the same manner for all five voices. The second and third column, set to modulate the volume and panorama, are restricted to affect the second and third unison voice, respectively. As a result, only those voices will be modulated. To experiment with and understand the unison engine, try the example above (or something similar) on an empty

patch (use the "Initialize Patch" function in the Patch menu). Make sure that the number of unison voices is set to at least three. The number of unison voices can be set from the Unison panel, located above the modulation matrix. Use the SOLO switches in the same panel to toggle between individual unison voices and see how the modulation affects them.

A further example will demonstrate how to set two unison voices to different settings, and conclude the introduction of the differential unison engine:

	SOURCE	AMT	DESTINATION	VOICE
1	Const	+50	Filter Cutoff	2
2	Const	+27	Filter Reso	2
3	---	---	---	---

Here we modulate two parameters, filter cutoff and filter resonance. The modulations are set to affect the second unison voice. As a source, we chose "Const", which means constant. The result of those modulations is to simply adjust the two filter parameters relative to the knob settings. For example, if the Cutoff knob is set to 50%, the second voice will have a cutoff setting corresponding to 100% (50% + 50%).

Note that in Dune 2, there is two ways to change the parameters of unison voices. You can use the modulation matrix as described in the second example above, or you can simply edit the voice parameters directly,

by using the Voice Edit section. By editing voice parameters directly, you perform **absolute** changes to the unison voices. This is required if you want to use different filter types, different synthesis models or different wavetables in the unison voices, and is generally a good idea if you want to stack completely different sounds. Using the modulation matrix instead, you perform **relative** changes to the unison voices. This is great to keep common controls: Suppose you build a C-minor chord stab with three unison voices using the modulation matrix, then all voices can still be edited together. Tweaking the cutoff knob or changing pitch will always affect the entire chord and not just a single voice.

5.2 List of Sources

The following section lists all available modulation sources with a brief explanation. All sources, whether it is MIDI data or synth parameters, are converted to the same range, which is [0,+1] for unipolar and [-0.5,+0.5] for bipolar sources. The LFOs, tze Pitch bend wheel, and the Random modifier are bipolar sources, all other sources are unipolar.

The current value of a source is **multiplied** with the amount value [-100 to +100] in the same modulation slot. The result of the multiplication is then **added** to the selected destination parameter.

Velocity

The MIDI Note-On velocity information, which is transmitted once at the instant a key is pressed. The harder a key is hit, the higher the transmitted value.

Vel>100

Emits maximum value if the MIDI key velocity is greater than 100, and zero otherwise. This source can be used to obtain additional effects when a key is hit hard, for example an extra layer could be triggered.

Keytrack

The MIDI Note number becomes the source of modulation, relative to C0. This means low keys emit a low value while high keys emit a high value. This source can be used to make a patch key-dependent, for instance shorten the envelopes when pressing a higher key.

Freqtrack

Identical to keytrack, except that this source is based on the pitch of the MIDI key, rather than its note number.

MWheel

The MIDI modulation wheel data (controller #01).

PWheel

The MIDI pitch wheel data. Note that the pitch bend wheel always changes the pitch up or down dependent on the Bend up/down setting in the main panel. Set both to zero if you wish to use the pitch wheel exclusively for a different purpose.

ATouch

Quality MIDI keyboards not only transmit velocity, but send pressure information as well. This parameter is called **Aftertouch**. In contrast to velocity, the aftertouch information is sent permanently and for the entire keyboard, not per key. It is transmitted for as long as any key(s) are being pressed. Note that there is a few keyboards which support sending pressure information per key. This is called polyphonic aftertouch. While polyphonic aftertouch is supported by the MIDI standard, such keyboards are very rare and never found wide usage. Hence, polyphonic aftertouch is not supported.

Const

This source simply sends a constant value of 1. Hence, the amount setting is directly added to the destination parameter. This can be useful for a wide range of tasks, for instance to offset a parameter for a specific unison voice or to set parameters only available in the modulation matrix.

Random

Sets a random value whenever a voice is triggered. Very useful with pan as a destination, or to add subtle pitch modulations simulating the behavior of acoustic instruments or vintage analog synthesizers (both of which have a slightly inconsistent pitch each time a note is played).

Arp Note

The note information sent from the arpeggiator. This is a special purpose parameter, which should be used in combination with Pitch Semi as a destination and with the Arp Mode set to "Silent". This will result in direct pitch changes within a voice, an effect common in old computers such as the C64. The resulting sound is different from the regular arpeggiator, which constantly triggers and releases voices.

Arp Velocity

The velocity information sent from the arpeggiator. This can be used to modulate any parameter rhythmically, and sync'd to the host tempo if desired.

Breath

MIDI Breath controller (#02).

Foot

MIDI Foot controller (#04).

Expr

MIDI Expression controller (#11).

Osc 1

The output of oscillator 1. When using this source, make sure to adjust the modulation rate to "Fast" or "Audio-Rate".

Osc 2

The output of oscillator 2. When using this source, make sure to adjust the modulation rate to "Fast" or "Audio-Rate".

Osc 3

The output of oscillator 3. When using this source, make sure to adjust the modulation rate to "Fast" or "Audio-Rate".

Noise Gen

The output of the noise generator. When using this source, make sure to adjust the modulation rate to "Fast" or "Audio-Rate".

LFO-1

Current value of LFO-1.

LFO-2

Current value of LFO-2.

LFO-3

Current value of LFO-3.

LFO*MW

The value of LFO-1, LFO-2 or LFO-3 multiplied by the modulation wheel data. Use this to create vibrato or tremolo effects with the depth controlled by the modulation wheel.

LFO*AT

The value of LFO-1, LFO-2 or LFO-3 multiplied by the aftertouch data. Useful to create vibrato type effects when applying pressure on the keyboard.

Voice

The unison voice number counting from zero, i.e. the first unison voice sends 0, the second voice sends 1, the third 2, and so on. This source can be useful to quickly set a parameter of each unison voice to a different value.

Filter Env

Current value of the filter envelope.

Amp Env

Current value of the amplitude envelope.

MSEG 1

The output of envelope generator 1.

MSEG 2

The output of envelope generator 2.

MSEG 3

The output of envelope generator 3.

MSEG 4

The output of envelope generator 4.

5.3 List of Destinations

The destinations of the modulation matrix comprise almost all sound parameters DUNE has to offer (as described in the third chapter), plus most effect parameters and a few helper functions not available on the front panel.

5.3.1 Common

Pitch Semi

The overall tuning of in semitones. An amount value of +1 corresponds to one semitone, +12 transposes the oscillator one octave up, -12 transposes one octave down etc.

Pitch Fine

The overall fine tuning in cents. Cents are a fraction of a semitone (+50 equals half a semitone, +100 a full

semitone). Modulate this parameter using a LFO as a source in order to obtain vibrato effects. For strong vibratos spanning a larger pitch range, use Pitch Semi as a destination instead. The modulation can be restricted to specific voices if desired. For example, you could have a static, low-pitched sine wave on the first voice and a vibrating sawtooth on the second.

5.3.2 Oscillator 1, 2, 3

This section describes all oscillator destinations. Note that oscillator 3 has fewer parameters, only the first six parameters are available here.

Osc Semi

The tuning of the oscillator in semitones. An amount value of +1 corresponds to one semitone, +12 transposes the oscillator one octave up, -12 transposes one octave down etc.

In the context of the differential unison engine, choosing Osc Semi as a destination allows you to specify arbitrary tunings for each voice. For example, if you long for a fourth or fifth oscillator having a different pitch than the first three oscillators, you could simply increase the number of unison voices and set the oscillator pitch of that voice only.

Osc Fine

The fine tuning of the oscillator in cents. Cents are a fraction of a semitone (+50 equals half a semitone, +100 a full semitone). Modulate this parameter using a LFO as a source in order to obtain vibrato effects. For strong vibratos spanning a larger pitch range, use Osc 1/2 Semi as a destination instead. The modulation can be restricted to specific voices if desired. For example, you could have a static, low-pitched sine wave on the first voice and a vibrating sawtooth on the second.

Osc Volume

The mixer volume of the oscillator.

Osc Pan

The mixer panorama of the oscillator.

Osc Init Phase

This parameter sets the absolute starting phase of the oscillator whenever a note is triggered. As a consequence, it will no longer be in free-run mode. Set to zero, the specified oscillators starts at zero phase. An amount of +50 corresponds to a +180 degree phase shift, an amount of +100 to +360 degrees, etc. While

the human hearing is largely insensitive to the starting phase of a single oscillator, the relative phase difference between both oscillators can matter in some cases, for example when both oscillators share the exact same frequency.

Osc Keytrack

This parameter sets the key tracking of the oscillator and is only available in the modulation matrix. An amount of +100 corresponds to the regular key tracking, where each MIDI key number corresponds to one semitone. By changing this parameter to values other than +100, you can either realize strange tunings or turn off key tracking entirely by setting Keytrack to 0. This is often done for drum sounds, which have no defined pitch.

Osc 1+2 Init Phase

This parameter sets the absolute starting phase of both oscillator 1+2 combined.

Osc Detune

Modifies the detune parameter of the oscillator stack. Oscillator density must be higher than 1 for this to work.

Osc Amount

Modifies the amount parameter (located next to "Density" on the top left). Oscillator density must be higher than 1 for this to work.

Osc Spread

Modifies the spread parameter. Oscillator density must be higher than 1 for this to work.

Osc VA Pulse Width

When the oscillator is set to "Pulse" in VA mode, this parameter changes the pulse width.

Osc VA Sync Freq

When the oscillator is set to VA mode with Sync enabled, this parameter changes the synchronisation frequency.

Osc WT Position

When the oscillator is set to WT mode, this parameter sets the Wavetable position. This allows to sweep through the wavetable by applying a LFO or MSEG.

Osc FM Amt A

When the oscillator is set to FM mode, this changes the amount of operator A.

Osc FM Amt B

When the oscillator is set to FM mode, this changes the amount of operator B.

Osc FM Amt C

When the oscillator is set to FM mode, this changes the amount of operator C.

Osc FM Feedbk

When the oscillator is set to FM mode, this changes the amount of operator feedback.

5.3.3 Ring mod/Noise

Ring Mod Volume

Adjusts the mixer volume of the ring modulator.

Ring Mod Pan

Adjusts the mixer panorama position of the ring modulator.

Noise Volume

Adjusts the mixer volume of the noise generator.

Noise Pan

Adjusts the mixer panorama position of the noise generator.

Noise Lowpass

Changes the low-pass filter of the noise generator.

Noise Highpass

Changes the high-pass filter of the noise generator.

Noise Width

Changes the stereo width of the noise generator.

5.3.4 Filter

This section describes the filter destinations.

Filter Cutoff

Adjusts the filter cutoff frequency relative to the front panel knob and using the same value range.

Filter Reso

Adjusts the filter resonance relative to the front panel knob, using the same value range.

Filter Env Amount

Adjusts the filter envelope amount relative to the front panel knob, using the same value range.

Filter Keytrack

Sets the key tracking for the filter, which specifies how much the cutoff frequency changes according to which MIDI note number a voice is playing. The parameter works in the same manner as the front panel knob, however you may specify negative values, too. Negative values cause low keys to have a higher cutoff frequency than high keys.

Filter Drive

Adjusts the filter drive parameter.

Filter FX Amount

Changes the filter effect's "Amount" knob.

Filter FX LP Cutoff

Most filter effects (esp. distortion), are followed by a low-pass filter to roll off unwanted high frequencies. This destination allows you to modulate this parameter. The slope of the low-pass filter is 12 dB, making it steep enough to be useful as a second filter, in addition to the main filter.

Filter Attack, Decay, Sustain, Release

Adjusts the filter envelope parameters relative to whatever is set on the front panel. This allows you to specify different filter envelopes for different voices or to dynamically vary those parameters for each note.

5.3.5 Amplifier

This section describes the amplifier destinations.

Amp Attack, Decay, Sustain, Release

Adjusts the amplitude envelope parameters relative to whatever is set on the front panel. This allows you to specify different amplitude envelopes for different voices or to dynamically vary those parameters for each note.

Amp Level

Adjusts the amplitude envelope level.

Amp Pan

Adjusts the panorama position of the amplitude envelope. This parameter has no corresponding knob on the front panel; it allows you to control the panorama of the entire voice.

5.3.6 MSEG

This section describes the available destinations for the graphical envelopes, MSEG 1-4.

MSEG Rate

Adjusts the rate of the MSEG. Note that MSEG Sync must be turned off for rate modulation to work.

5.3.7 LFO

This section describes the available destinations for low frequency oscillators 1-3.

LFO Amount

Adjusts the amount of the specified LFO.

LFO Rate

Adjusts the rate of the specified LFO.

LFO Init Phase

Adjusts the initial phase of the specified LFO when a new voice is started. This parameters works just like oscillator init phase.

5.3.8 Mod Matrix

MM Amount 1-32

The MM Amount destinations allow you to change the modulation amount of any modulation slot. This feature can be useful to build complex modulations. For instance, if LFO 1 modulates the noise level using MM slot 1, then you could have LFO 2 modulate that slot by choosing LFO 2 as a source, and MM Amount 1 as a destination.

Another useful application is to make modulations dependent on a MIDI controller, e.g. you program a modulation envelope and wish to have the modulation depth controllable by the modulation wheel. In that case you would choose Mod Wheel as a source and the MM slot(s) containing the modulation envelope as a destination.

You may also have one MM slot modulate another

MM slot, which in turn modulates another MM slot etc. For such modulations to work properly, you must ensure that the MM Amount numbers occur in ascending order.

5.3.9 FX Bus 1+2

This section describes the effect destinations. Almost all destinations correspond to their front panel knobs (refer to chapter 3 for a detailed description of the parameters), only differences will be explained here.

Dist

Adjusts the corresponding distortion parameters.

EQ 1/2

Since the mid band of the equalizer offers the most flexibility, its parameters can be modulated by choosing the Freq, Q or Gain parameter, respectively. The low- and high shelving filters can not be chosen as destinations.

Phaser

Adjusts the corresponding phaser parameters.

Chrs

Adjusts the corresponding chorus parameters.

Del

Adjusts the corresponding delay parameters. When delay sync is turned off, the delay time may be modulated, relative to the L/R times specified with the front panel knobs.

Rev

Adjusts the corresponding reverb parameters. All parameters except pre-delay can be modulated.

Comp

Adjusts the corresponding compressor parameters.

6 MIDI Reference

Most knobs and buttons on the front panel can be remote controlled via MIDI. Dune's default controller assignments follow common conventions and the MIDI standard as much as possible. The number of sound parameters Dune offers, however, is higher than the amount of available MIDI controllers. Most effect parameters and large parts of the modulation matrix are thus not assigned to any MIDI controller.

To override the default MIDI assignment, right-click on a knob and select "MIDI Learn", then move your hardware controller knob. To remove an assignment, choose "MIDI Forget". Once you close Dune, the changes will be made persistent and apply to any future instance of Dune.

Dune Parameter	CC #	MIDI Ctrl Name
Common		
Modulation Wheel	1	Modulation Wheel
Glide	5	Portamento Time
Sustain Pedal	64	Sustain Pedal
Volume	111	

Dune Parameter	CC #	MIDI Ctrl Name
Unison		
Detune	53	
Pan Spread	54	
Oscillators		
Osc 1 Detune	102	
Osc 1 Spread	30	
Osc 1 Semi	77	Sound Controller 8
Osc 1 Fine	24	
Osc 1 PW	70	Sound Controller 1
Osc 1 Level	75	Sound Controller 6
Osc 2 Detune	103	
Osc 2 Spread	31	
Osc 2 Semi	78	Sound Controller 9
Osc 2 Fine	34	
Osc 2 PW	71	Sound Controller 2
Osc 2 Level	76	Sound Controller 7
Osc 3 Semi	105	
Osc 3 Level	106	
Noise LP	107	
Noise HP	108	
Noise Width	109	
Noise Level	110	
Ring Mod Level	79	Sound Controller 10
Arpeggiator		
Arp On	47	
Arp Rate	50	
Arp Note Length	52	

Dune Parameter	CC #	MIDI Ctrl Name
LFOs		
LFO 1 Rate	14	
LFO 1 Waveform	15	
LFO 1 Sync	16	
LFO 1 Fade In	18	
LFO 2 Rate	19	
LFO 2 Waveform	20	
LFO 2 Sync	21	
LFO 2 Fade In	23	
LFO 3 Rate	80	
LFO 3 Waveform	81	
LFO 3 Sync	82	
LFO 3 Fade In	84	
Filter		
Filter Attack	38	
Filter Decay	39	
Filter Sustain	40	
Filter Release	41	
Filter Cutoff	74	Brightness
Filter Reso	42	
Filter Env Amt	43	
Filter Key Track	46	

Dune Parameter	CC #	MIDI Ctrl Name
Amp Envelope		
Amp Attack	73	Attack Time
Amp Decay	36	
Amp Sustain	37	
Amp Release	72	Release Time
Effects (Bus 1)		
EQ 1 Mid Gain	89	
EQ 2 Mid Gain	90	
Reverb Dry/Wet	91	Effect 1 Depth
Delay Dry/Wet	92	Effect 2 Depth
Chorus Dry/Wet	93	Effect 3 Depth
Distortion Dry/Wet	94	Effect 4 Depth
Phaser Dry/Wet	95	Effect 5 Depth
Mod Matrix		
MM Amount 1	112	
MM Amount 2	113	
MM Amount 3	114	
MM Amount 4	115	
MM Amount 5	116	
MM Amount 6	117	
MM Amount 7	118	
MM Amount 8	119	

7 Optimizing performance

The most important switch to boost performance is to enable the multi-threading switch (located in the MAIN section of the center screen). Additional performance gains can be achieved by optimizing your system or by adjusting the patch settings.

7.1 Optimizing your system

If you use a Windows-based system, often many services run in the background which can degrade performance — check if you really need all of them. If you run Dune 2 on a modern quad-core or better CPU with multi-threading enabled, you should see a substantial reduction in CPU usage, especially when playing pad/string-type sounds with a high polyphony and voice count. If you do not experience a significant performance boost with multi-threading, then either your host's audio buffer size is too small (the minimum is 128 samples), or your system is not optimized enough for realtime audio playback.

7.2 Optimizing patch settings

The two most important patch settings affecting CPU usage are polyphony (how many notes can be active simultaneously), and the modulation rate.

7.2.1 Polyphony

The polyphony can be adjusted on the top right of the user interface, inside the MASTER section. Set the polyphony as low as possible. If you start to hear clicks, you have two options:

- Shorten the amplitude envelope release time. This will reduce the overlap of successively played notes, and thus lower the required polyphony.
- Increase the polyphony again, until the clicks disappear.

7.2.2 Modulation Rate

The modulation rate can be adjusted in the SETTINGS tab, inside the center screen. Set the modulation rate to "Normal" for best performance. Use "Fast" or higher only if you are certain the patch requires this rate, and if you can really hear a difference. Audio-rate modulation needs a lot of CPU, as the entire synth engine, plus all modulation sources

(e.g. LFOs, MSEGs, ...) are processed sample by sample, rather than in blocks.

7.2.3 Patch structure

If you design sounds from scratch, here is a few tips that will help you reduce CPU usage:

- Oscillator stacks 1+2 can be turned off by setting the oscillator count to zero. This is strongly recommended if you do not need them.
- Avoid using more unison voices than necessary. For example, using 8 unison voices with a single oscillator per voice is much more CPU intensive than using a single unison voice with a stack of 8 oscillators in it. In contrast to its predecessor, Dune 2 has stereo oscillators with pan + pan spread, it is thus no longer necessary to use multiple unison voices to achieve a stereo sound.
- Set the filter to "Off" for patches that do not require a filter.
- Use the transistor ladder lowpass filters only if you really need them. They use much more CPU than the corresponding multi-mode lowpass filters.
- Keep the amplitude envelope release time as short as possible.

8 Troubleshooting

If Dune does not work as expected, check the following points. If your problem is not listed here, do not hesitate to contact us at service@synapse-audio.com, we are happy to assist you.

8.1 Notes click when pressing or releasing a key

Check the amplitude attack and amplitude release time, and increase both if necessary. Furthermore, check the polyphony setting (top right of the user interface) and increase the polyphony if necessary.

8.2 Patches do not recall

The most likely reason is that you have the demo version installed, which does not save. If you have purchased the full version, make sure to uninstall the demo version then install the full version, and be sure to provide your proper serial number.

8.3 Parameters change unexpectedly

Check your MIDI setup. While Dune uses a controller map designed to not react on controllers such as bank change or volume (which may be sent by some hosts), it is possible that your gear sends other controller messages that Dune will respond to. The default controller assignments are given in chapter 6.

8.4 The sound is distorted

Lower the master volume, and watch out for the clipping indicator in your host sequencer. If this does not help, check your audio driver settings and the CPU load — if the CPU load is too high, clicks or other artifacts will occur. Refer to chapter 7 for tips on how to reduce the CPU usage.

If none of the above helps, check if the active patch intentionally uses distortion, e.g. by switching to other patches and comparing the output. There is many ways to intentionally add distortion to a patch. The most obvious way is the distortion effect in one of the master effect busses. The filter, filter effect as well as the compressor can distort, too, however.

8.5 MIDI messages are not received

Check the MIDI IN indicator, located on the top right of Dune's user interface. If this indicator never lights up, Dune does not receive any MIDI messages. Check the MIDI setup of your host sequencer, as well as the setup of your hardware.

8.6 The CPU usage is very high

Check if your system meets the minimum system requirements. Also read chapter 7, "Optimizing performance".

9 Legal Information

9.1 Trademarks

VST is a trademark of Steinberg Soft- und Hardware GmbH. All other trademarks and trade names are the properties of their respective owners, and do not imply owner's endorsement of this product, or guarantee full compliance with owner's standards.

9.2 End User License Agreement (EULA)

By installing, copying, or otherwise using this software or any files provided with it, you agree to be bound by all of the terms and conditions of this license agreement. If you are not the original purchaser of the Software, or if you do not agree with the License Agreement, you must promptly remove the software from your computer, and cease any and all use of it. If you are accepting the License Agreement on behalf of an other legal entity, the use of the terms "you" and "your" in the License Agreement shall refer to such entity.

Grant of license

You are granted a personal, non-exclusive, non-transferable and limited license to install and use the Software for the purposes set forth herein. Unless you have purchased additional licenses, you may only install and use a single copy of the Software on a computer, and/or move the software to another computer, provided that you are the only individual using the software. If you are an entity, you may appoint one individual within your organization to have the right to use the Software under the terms of this License Agreement. This software, including all of its components and any additional files included with the distribution, is protected by copyright law and international copyright treaties. The total number of copies of the software used by you, may not exceed the number of licensed copies paid for by you, except that you may make one copy of the software solely for archival or backup purposes. The term of this license is perpetual, unless terminated under the conditions provided in the License Agreement. Except as provided in the agreement, you receive no rights to transfer, rent, lease, lend, copy, modify, market, transmit or reverse engineer the software, any component hereof, or any file provided with the distribution. The software, and any files included with the distribution, including sampled sounds, presets and demonstration songs, is licensed but not sold to you, for use in music production. If

you have purchased this software as an upgrade from a previous version, this constitutes a single licensed product, to be used under the terms of this License Agreement.

Disclaimer

The software, any component hereof, and any files distributed with the software, is provided "as is", and there is no warranty of any kind, either express or implied - including, but not limited to, the implied warranties of merchantability and fitness for any particular purpose. The risk as to the quality and performance of the program is with you, and the licensor will not be held responsible for any damage or loss, to your person or property, as incidental or consequential result of installing or using this software.

Termination

Your license to use the software is effective from the date you agree to the terms and conditions of this License Agreement. Your license is automatically terminated if you fail to comply with the limitations described in the License Agreement, and no notice shall be required from the licensor to effectuate such termination. Upon termination of this License Agreement for any reason, you shall make no further use of the

software, and shall destroy all copies hereof, and shall not be entitled to any claims or refunds.

Appendix

Sound Design Reference

The last two characters of every patch name are the author's initials. The following table lists all sound designers who contributed patches or wavetables, and a website where you can learn more about their work.

Ab.	Author Name	Email or Website
AS	Adam Szabo	http://www.adamszabo.com
AZ	Aiyin Zahev	http://www.aiynzahev-sounds.com/
EDT	Ed Ten Eyck	http://www.edtaudio.com
EX	Daniel Thiel (eXode)	https://soundcloud.com/exodesound
GW	Vincent Bastiat	http://ghostwaveaudio.com
IW	Ingo Weidner	ingo_weidner@web.de
JB	Junebug	http://www.electronicounds.com
MH	Mark Holt	https://soundcloud.com/markholt
MK	Michael Kastrup	http://www.xsynth.com
KS	Kevin Schroeder	https://www.facebook.com/DejaVuSound
RH	Richard Hoffmann	http://www.synapse-audio.com
RL	Rob Lee	http://www.roblee-music.com
sT	Satya Choudhury	http://satyatunes.com
ST	Solidtrax	http://www.solidtrax.nl