

Roland®

24 TR / 24-bit / 96 kHz DIGITAL STUDIO WORKSTATION

VS-2400 CD

Appendices



Before using this unit, carefully read the sections entitled: "IMPORTANT SAFETY INSTRUCTIONS" (Owner's Manual p. 2), "USING THE UNIT SAFELY" (Owner's Manual p. 3), and "IMPORTANT NOTES" (Owner's Manual p. 5). These sections provide important information concerning the proper operation of the unit. Additionally, in order to feel assured that you have gained a good grasp of every feature provided by your new unit, Owner's Manual, and Appendices should be read in its entirety. These manuals should be saved and kept on hand as a convenient reference.

Copyright © 2002 ROLAND CORPORATION

All rights reserved. No part of this publication may be reproduced in any form without the written permission of ROLAND CORPORATION.

Roland International Web Site: <http://www.Roland.com>

Roland US Web Site:

<http://www.RolandUS.com>

Contents

About MIDI	4
Troubleshooting	5
Q&A	8
BASIC FUNCTIONS	8
EFFECTS	9
CD-R/RW DRIVE	10
DIGITAL I/O	11
MIDI DEVICES	12
DATA COMPATIBILITY WITH OTHER VS MODELS	12
OTHERS.....	13
How to Record with External Effects Devices Connected	14
Error Messages	16
Glossary	18
Shortcut Key Operations	21
Parameter List	25
Preset Patch List	39
Algorithm List	45
MIDI Implementation	100
Track Sheet	145
About the Demo Performances	148
SPECIFICATIONS	149
Index	151

About MIDI

This section explains the basic concepts of MIDI, and how the VS-2400CD handles MIDI messages.

What is MIDI

MIDI stands for **Musical Instrument Digital Interface**. It is a worldwide standard that allows electronic musical instruments and personal computer to exchange musical performance data and messages such as sound selections. Any MIDI-compatible device can transmit musical data (as appropriate for the type of device) to any other MIDI-compatible device, regardless of its manufacturer or model type.

MIDI connectors

MIDI messages (the data handled by MIDI) are transmitted and received using the following three types of connectors. On the VS-2400CD, MIDI OUT and MIDI THRU are handled by a single connector, which can be switched to act as the desired connector.

- MIDI IN:** This receives MIDI messages from external MIDI devices.
- MIDI OUT:** This transmits MIDI messages from the VS-2400CD.
- MIDI THRU:** This re-transmits all MIDI messages that were received at MIDI IN, without modifying them.

MIDI channels

MIDI is able to send information over a single MIDI cable independently to two or more MIDI devices. This is made possible by the concept of MIDI channels. You can think of MIDI channels as being somewhat similar in function to the channels on a television. By changing the channel of a TV set, you can view a variety of programs being transmitted by different broadcast stations. This is because data is received only from the transmitter whose channel is selected on the receiver.

In the same way, a MIDI device whose receive channel is set to "1" will receive only the data being transmitted by another MIDI device whose transmit channel is also set to "1."

MIDI messages

The VS-2400CD uses the following types of MIDI message.

Note messages:

These messages are used to play notes. On a keyboard, these messages transmit the key (note number) that was pressed, and how strongly it was pressed (velocity). On the VS-2400CD, these messages are used when you use a MIDI sound source to play the metronome sound.

Control Change messages:

In general, these messages are used to transmit information such as vibrato, hold, and volume etc., that makes a performance more expressive. The various functions are differentiated by a controller number from 0–127, and the controller number is defined for each function. The functions that can be controlled on any given device will depend on that device.

On the VS-2400CD, these messages can be transmitted to external MIDI devices by V.Fader function.

Exclusive messages:

Unlike note messages and control change messages, exclusive messages are used to transmit settings that are unique to a particular device. On the VS-2400CD, they can be used to control VS-2400CD mixer parameters, when it receives exclusive messages.

Exclusive messages intended for different units are distinguished by their Device ID, rather than by MIDI channel. When exclusive messages are to be transmitted or received, you must set the Device ID of both units to a matching setting.

MIDI Implementation Chart

MIDI allows a variety of electronic musical instruments to communicate with each other. However it is not necessarily the case that all devices will be able to communicate using all types of MIDI message. They can only communicate using those types of MIDI message that they have in common.

Each owner's manual for a MIDI device includes a MIDI Implementation Chart. This chart shows you at a glance the types of MIDI message that can be transmitted and received. By comparing the implementation charts of two devices, you will be able to see the types of message with which they will be able to communicate.

Troubleshooting

When the VS-2400CD does not perform the way you expect, check the following points before you suspect a malfunction. If this does not resolve the problem, Contact your dealer or a qualified Roland Service Center.

Recording and Play back

No Sound

- The power of the VS-2400CD and the connected devices is not turned on.
- The audio cables are not connected correctly.
- The audio cables are broken.
- The volume is turned down on the connected mixer or amp.
- Some of these of the VS-2400CD are turned down.
 - Channel fader
 - Master fader
 - MONITOR knob
 - PHONES knob
- The output jacks which are connected are different than the output jacks selected in the master section of the mixer.
- Short phrases less than 0.5 seconds cannot be played back.
- The volume level of the instrument connected to the VS-2400CD is too low.
 - Could you be using a connection cable that contains a resistor? Use a connection cable that does not contain a resistor.
- I can't record or play back, even when I press **[PLAY]**.
 - Does the he PLAY indicator just blink green? The VS-2400CD is receiving MTC receive standby messages from the external MIDI device. Operate the external MIDI device or press **[STOP]**.
 - When "POWER OFF/RESTART" appears in the display it means that the shutdown procedure is being performed. Hold down **[SHIFT]** and press **[PLAY (RESTART)]**. This restarts the VS-2400CD.

A specific channels does not sound

- The input mixer or the track mixer section has not been selected correctly.
- The volume level of the channel is turned down.
- The track status is off (the STATUS indicator is off).
- The Solo or Mute function is being used.
- A project with a recording mode of "M16" or "CDR" is selected.
 - When "M16" is selected, the VS-2400CD will function as a 16 track recorder. When "CDR" is selected, the VS-2400CD will function as an eight-pair stereo recorder (channel link is on: track 1/2, 3/4-). Track 17-24 cannot be used.
For details refer to the "Main feature: Disk Recorder Section" (Owner's Manual).

Cannot record

- The recording track has not been selected (the STATUS indicator is not blinking red).
- Recording source tracks, play back tracks, or effects have not been assigned.
- The disk drive has insufficient capacity.
- The project has an insufficient number of events.
- The number of tracks which can be simultaneously recorded will decrease.
 - Depending on the organization of the song data or the disk drive performance etc., the number of tracks which can be simultaneously recorded or played back may be limited.
 - When the recording mode is "M16" or "CDR," up to 16 tracks can be recorded simultaneously.
 - When the Sample Rate is set to higher than "64 kHz" or the Vari Pitch is "On," the number of tracks which can be simultaneously recorded may be limited.
For details refer to the "Main feature: Disk Recorder Section" (Owner's Manual).

Cannot record digitally

- The CD player's digital connection is not accepted.
- The **MASTER CLOCK** is set to "INT".
- The DIGITAL IN connector (optical/coaxial/R-BUS) was not properly selected.
- The sampling rate of the recording destination project is different than the sampling rate of the digital audio device.
 - Match the sample rate setting of the digital audio device to the setting of the project. If it is not possible to change the sample rate of the digital audio device, create a new project with that sample rate.
- The digital signal is not being transmitted from the digital audio device.
 - Some digital audio devices do not output a digital signal unless they are in play mode. If this is the case, put your digital audio device in standby (pause) mode before putting the VS-2400CD into record mode.
- The digital signal format is different.
 - Some digital audio devices may use a special digital signal format. Please connect to a digital audio device that is compatible with S/P DIF.

Noise and distortion appear in the recorded sound

- Input sensitivity settings are incorrect.
 - If input sensitivity settings are too high, the recorded sound will be distorted. Conversely, if they are too low, the recorded sound will be obscured by noise. Adjust the SENS knobs so that the level meters move at as high a level as possible, within the range of -12 dB to 0 dB.
- The equalizer is being used with the input mixer.
 - Some equalizer settings may cause the sound to distort even if the channel's peak indicator does not show clipping. Readjust the equalizer.
- "ATT" (Attenuator) setting is incorrect.
 - If noise or distortion occurred as a result of track bouncing, the track output levels were too high.

The play back pitch is strange

- The Vari-Pitch function is turned on (the VARI PITCH icon is appears in the display).
- The time compression/expansion function is being used.

Disk drive problems

The internal hard disk is not being recognized

- The hard disk has not been installed correctly.
- The "Partition" settings are not right.
 - We recommend setting the partition size to "10GB."
- Although the Region Erase operation is finished, the available recording time is not increased.
 - The audio data is erased by Region Cut, RegionErase or Phrase Delete etc., the data that is no longer played back is not actually erased from the hard disk. If you wish to increase the available recording time, please read "If "Disk Full!" appears in the display (Project Optimize)" .

Internal Effects

Effects cannot be used

- The VS8F-2 has not been installed correctly.
- Only one VS8F-2 has been installed (when EFFECT 3 and 4 cannot be used).
- You are attempting to select the algorithm for Reverb, Gated Reverb, Vocoder2 (19), Voice Transformer or Mastering Tool Kit with FX2 or FX4.
- You have already selected Vocoder 2 (19), Voice Transformer or Mastering Tool Kit with FX1 or FX3 and therefore cannot use FX2 or FX4.
- I'd like to change the order of an effect algorithm.
 - The connection orders cannot be altered. They can only be turned on or off. For more detailed information on what goes on with the algorithm orders, please refer to the "Algorithm List" (p. 45).

CD-RW Drive Problems

I made an audio CD on the CD-R/RW drive, but it doesn't play on a consumer CD player.

- The disc was not finalized. When making audio CDs, set "FINALIZE" to "On" or "OnlyFin."
- Audio CD's created using a CD-RW disc cannot be played on a conventional CD player. Please use a CD-R disc.

Cannot write to CD-R discs

- The project's sample rate is set to something other than 44.1 kHz.
- The internal IDE hard disk does not have sufficient free disk space.
- The CD-R disc does not have sufficient free space.
- You are trying to write to a commercial CD software disc.
- You are trying to write to a CD-R disc that has been finalized.

MIDI Devices Problems

With the VS-2400CD as master, the MIDI sequencer does not respond to commands

- The MIDI cable is not connected correctly.
- The MIDI cable is broken.
- The MIDI OUT/THRU switch is not set to "Out".
- "MIDI OUT SYNC Gen." (the MIDI out sync generator) is not set to the appropriate synchronization method (MTC, MIDI Clock, Sync Track).
- The EXT indicator is blinking ("SYNC MODE" is set to "EXT").
- The two devices are not set to the same type of MTC (during MTC synchronization).
- The MIDI clock data has not been recorded on the sync track (if you are using the sync track for synchronization).
- The settings of the MIDI sequencer are not correct.
- The MIDI sequencer is not ready to play back.

When synchronizing using a MIDI sequencer as the master, the VS-2400CD does not respond to the sequencer messages

- The MIDI cable is not connected correctly.
- The MIDI cable is broken.
- You are trying to synchronize using the MIDI clock.
 - The VS-2400CD cannot be run in slave mode using a method other than MTC.
- The EXT indicator is off ("SYNC MODE" is set to "INT").
- The two devices are not set to the same type of MTC (during MTC synchronization).
- The settings of the MIDI sequencer are not correct.

- The VS-2400CD is not in play back standby mode (with the PLAY indicator blinking).
- The MTC signal is not strong or has errors.
 - Setting the **ERROR LEVEL** to "5" or higher may improve conditions.

Other problems

Data on the disk drive was not saved properly

- The VS-2400CD's power was turned off without performing the shutdown process.
- The power was turned off while the disk drive was operating.
- A strong shock was applied to the disk drive.
 - Do a physical format of the drive and recreate the partitions. Also, we recommend that you execute Surface Scan as well.

BASIC FUNCTIONS

Q: What are the main differences between VS-2400CD and VS-1880/1824?

A: Main differences from VS-1880/1824 are as follows.

- Accommodates 96kHz sampling rate
- 24-bit linear recording
- An R-BUS port
- Newly developed pre-amp circuit on analog input
- 13 motorized faders
- Mouse operation on VGA screen
- 3.5" hard disk drive installed with expanded partition size to 10GB
- Dynamics processor (Compressor/Expander) equipped on every mixer channel
- 4-band EQ
- Surround panning function

Q: About the Recording Mode

A:

- M24 (Mastering 24bit)
Audio from the analog inputs that passes through the VS-2400CD's 24-bit A/D converter, and audio data from the 24-bit digital inputs will be recorded and played as linear data.
When this mode is selected, the VS-2400CD will function as a 16-track recorder (tracks 1–16). When sampling frequency is more than 64kHz, the VS-2400CD will function as a 8-track recorder.
- MTP (Multi Track Pro)
Audio from the analog inputs that passes through the VS-2400CD's 24-bit A/D converter, and audio data from the 24-bit digital inputs will be recorded and played using proprietary Roland coding technology (R-DAC). Normally you should select this mode.
- CDR (CD-R Writing):
This mode allows you to directly create a CD image file on your hard disk – this file can later be burned onto a CD-R. Recording and play back will occur using 16-bit linear data similar to that of a CD player or DAT recorder. In CDR mode, Tracks 1–8 are linked in odd/even fader pairs, with their levels controlled by the odd-numbered fader. Track 17–24 cannot be used.
- M16 (Mastering 16bit):
Recording and play back will occur using 16-bit linear data similar to that of a CD player or DAT recorder. When this mode is selected, the VS-2400CD will function

as a 16-track recorder (tracks 1–16). When sampling frequency is more than 64kHz, the VS-2400CD will function as a 8-track recorder.

- MT1 (Multi Track 1):
This recording mode provides approximately twice the recording time of M16 mode.
- MT2 (Multi Track 2):
This recording mode provides even longer record times than MT1.
- LIV (Live 1):
This mode is appropriate when your hard disk lacks free space or when recording live performances where the total recording time is unknown.
- LV2 (Live 2):
This mode provides the longest recording time. This mode is appropriate for live recordings of speeches, and recordings made for reference purposes. Use this mode if you have very little drive space left or you aren't sure how long the recording will be.

Q: Is it possible to mix down even when all the 24 tracks are occupied?

A: Yes. In the Mastering Room, you can mix down to the empty V-tracks on tracks 23/24 while playing back 24 tracks.

Q: How long is the recording time?

A: Recording time in each recording mode and sampling rate is as shown in the following table. (unit: minute)

	96kHz	88.2kHz	64kHz
M24	658	716	987
MTP	1,977	2,152	2,966
CDR	988	1,076	1,483
M16	988	1,076	1,483
MT1	1,977	2,152	2,966
MT2	2,635	2,866	3,953
LIV	3,163	3,442	4,744
LV2	3,954	4,304	5,932

	48kHz	44.1kHz	32kHz
M24	1,316	1,433	1,975
MTP	3,954	4,305	5,932
CDR	1,977	2,152	2,966
M16	1,977	2,152	2,966
MT1	3,954	4,305	5,932
MT2	5,271	5,732	7,907
LIV	6,326	6,885	9,489
LV2	7,909	8,609	11,864

Q: How many tracks can I record/play back simultaneously?

A: Maximum simultaneous recording/play back tracks in each recording mode and sampling rate are as shown in the following table.

Recording Mode	96/88.2/64kHz	48/44.1/32kHz
M24/M16/CDR	Recording:8 Play back:8	Recording:16 Play back:16
MTP/MT1/ MT2/LIV/LV2	Recording:8 Play back:12	Recording:16 Play back:24

Q: Is "Track Copy" possible between different projects?

A: Yes. You can import the tracks from a Project which uses the same recording mode and sampling rate.

Q: Is it possible to record the fader location? Is it possible to record the SENS knob value?

A: You can memorize the fader location in the scene memory up to 100 patterns per Project or by using automation. But you cannot memorize the values for SENS, PHONES and MONITOR knobs.

Q: Is it possible to monitor any one of the bus sources via headphones?

A: No. A headphone jack is always tied to the monitor bus. However, you can assign any different bus signal to the monitor bus.

Q: How many locators can I recall at once?

A: One at once, but you can memorize 100 locators (10 points x 10 banks) per Project.

Q: Is it possible to undo/redo automix?

A: Yes. One level undo/redo is possible for automix writing/editing on VS-2400CD.

Q: Is it possible to record the effect parameters in the automix?

A: No. It is impossible to record real time changes in effect parameters, but patch changes can be changed in real time.

Q: Is it possible to use VS-2400CD simply as an audio mixer?

A: Yes.

EFFECTS

Q: Are the effects pre-installed? Is it possible to use the effect board from the previous VS-series?

A: VS-2400CD is shipped with one VS8F-2 effect expansion board installed, and you can start working with two stereo effects. Plus you can add one more optional VS8F-2 for four stereo effects in total.

NOTE

VS8F-1 is exclusively for VS-880 and cannot be used with any other VS models.

Q: Which microphones can be used for mic modeling?

A: Roland dynamic microphone DR-20, and AKG C3000B condenser microphones can be used.

Q: Are 31-band graphic equalizer and real time spectrum analyzer available as found on the VM-7000 digital mixer?

A: When the sampling rate is 48/44.1/32kHz, the spectrum analyzer can be used. Also the generators for white noise, pink noise and the sine wave can be used simultaneously. However, there is no 31-band graphic equalizer in the VS-2400CD.

Q: Is it possible to assign different mic modeling settings to each signal from INPUT 1-8?

A: Mic modeling algorithm is 2 in/2 out configuration, and you can set each channel differently. If you install four VS8F-2, you can have eight effects running simultaneously for eight channels of different mic modeling settings.

Q: Is there any pitch correction effect for vocals, etc?

A: Pitch shifter algorithm is available but there is no function to correct pitch on any particular syllable.

Q: Is it possible to insert the external effect processor to the channel?

A: Insert connector is not equipped on VS-2400CD but it is possible to use the external effect processors. Please refer to the this manual "How to Record with External Effects Devices Connected (p. 14)" for the setting details.

From the point of view of sound quality, noise and operational ease, using the internal effects on VS-2400CD is recommended.

CD-R/RW DRIVE

Q: Is it possible to use the CD-R/RW drive which were used with the previous VS models?

A: No, they cannot be used. Please use the built-in CD-R/RW drive.

Q: Can the built-in CD-RW drive be exchanged?

A: No, it cannot be exchanged.

Q: Which type of disc can be used with the CD-R/RW drive?

A: There is no particular restriction but sometimes problems may result due to the bad quality of the media or bad affinity between the drive and one brand of discs. Before you purchase many discs of one kind, please test one to be sure that it can be used with your drive.

80-minute discs are not recommended because of their thinner grooves for recording.

8cm CD-R disc (18-minute) can be used.

For your important project, we recommend you to backup in multiple discs. Also, CD-R/RW disc is a delicate medium and please handle and store with care according to the precaution notes which come with the disc.

Q: If I write an additional project to the CD-R disc which is not finalized, will there be a silent gap between the songs?

A: If you write in "Track at Once" mode, approximate 2 seconds of silence will be inserted in between automatically.

Q: Is it possible to do "CD Write/CD Backup" in eight times speed?

A: No matter how fast the drive is, writing speed to CD-R/RW is limited to four times.

Q: When creating audio CD with "CD Write," is it possible to write the copyright bit?

A: No. Copyright bit is off when writing to CD-R.

Q: Is it possible to use the audio CD which is written on VS-2400CD as a master disc for mass duplication?

A: There are "Disc at Once" and "Track at Once" methods for audio CD burning. Disc created with "Disc at Once" method can be a press master.

Q: Is it possible to backup additional Projects to a disc which already contains one Project backup?

A: Project backups to CD-R, always use the Disc at Once mode which finalizes the disc at the end of backup. So additional writing of the data is impossible even if the disc has room.

If you try to write another Project on CD-RW disc, you need to first erase the entire disc.

Q: How long does it take backup the Project on CD-R/RW?

A: A 600MB Project is equivalent to a CD-R/RW disc. To backup this with four times speed, it will take about 15 minutes and another 15 minutes to verify the result, 30 minutes in total. This may vary by the Project data configuration and performance of the hard disk.

Q: What type of PQ signals can I record?

A: P and Q sub channel information is not generated by the VS-2400CD, but the CD-R/RW drive automatically generates these in accordance with the CUE sheet from the VS-2400CD. In other words, the required markers for an audio CD such as TNO (track number), INDEX (index number), P-Time (program time) and A-Time (absolute time) are recorded when a CD is written and finalized.

Q: Is it possible to backup a 1GB Project on the CD-R/RW disc?

A: Yes. You can backup using multiple discs.

Q: Is it possible to capture audio signals from an audio CD in the CD-R/RW drive?

A: Yes.

Q: Is it possible to directly play back the Project data in the CD-R/RW disc?

A: No, such function is not supported.

DIGITAL I/O

Q: Is it possible to connect two VS-2400CD's in cascade via R-BUS to transfer audio data, various control messages and synchronization?

A: Yes. VS-2400CD can transfer eight channel audio data, MIDI Time Code (MTC) for synchronization and MIDI Machine Control (MMC) via R-BUS.

At this moment, control messages which came in via R-BUS cannot be sent out through R-BUS. To synchronize three VS-2400CD's (or more), MIDI should be used simultaneously.

Q: Is an R-BUS connector supplied with the VS-2400CD? Are R-BUS cables sold separately?

A: VS-2400CD is equipped with one R-BUS connector.

An R-BUS cable does not come with VS-2400CD. Please use the cable which is attached to the external R-BUS devices, or order the following cables.

- RBC-1 (1-meter)
- RBC-3 (3-meters)

NOTE

The RBC-5 (discontinued) does not support the use of 64 kHz or higher sampling frequencies.

When using sampling frequencies of 64 kHz or higher, please use the RBC-1 (1-meter) or RBC-3 (3-meters) R-BUS cable.

NOTE

Operation may be unstable when using the RBC-5 with the DIF-AT or AE-7000.

Use the RBC-1 (1-meter) or RBC-3 (3-meters) when using these devices.

Q: Is it possible to output the multi-channel audio via Coaxial/Optical just like DTS and Dolby Digital?

A: VS-2400CD does not have any multi-channel digital audio encoding function such as the DTS format. And do not input DTS signals or any other this kind of signals to the digital input on VS-2400CD. Please use an external encode/decode device.

Q: What digital devices can be used when sampling rate is set to 96kHz?

A: Devices such as the Roland VS-2480/2480CD can be connected.

Q: Is it possible to use two digital in connectors simultaneously?

A: No. You must select whether to use the optical or the coaxial connectors, not both.

Q: Is it possible to output two different signals from each of the two digital out connectors?

A: No. You cannot both operate at the same time, however just with the same signal.

MIDI DEVICES

Q: Is it possible to use a digital input when the VS-2400CD is an MTC slave?

A: Yes. But if the discrepancy between the MTC and the digital master clock gets large, the VS-2400CD may stop play back.

Q: Is it possible to assign any MIDI parameters to faders to control the external device?

A: With "V-fader" function, you can transmit MIDI control change messages from the MIDI OUT using the 12 faders.

Q: Is it possible to do 5.1 surround mixing with VE-7000 or J.L. Cooper MCS Panner?

A: By connecting VE-7000 via MIDI, you can remote control each channel parameter. Joystick controls the surround panning.

Other control devices will be supported with the future update.

Q: Is it possible to control the VS-2400CD mixer from external software on a computer via MIDI?

A: Yes. You can control the VS-2400CD mixer with external MIDI information.

DATA COMPATIBILITY WITH OTHER VS MODELS

Q: Is there any compatibility of VS-2400CD data with the other VS models?

A: Yes. You can import and export the VS-880/880EX/890/1680/1880/1824/1824CD/2480/2480CD and VSR-880's project (song).

NOTE

Data export to VS-840 series is not supported.

Q: Is it possible to use a hard disk which is used by other VS models?

A: No.

Q: Is it possible to recover a DAT backup song from another VS model?

A: No. VS-2400CD does not have DAT backup/recover function.

Q: Is it possible to recover VS-2400CD's CD-R backup data onto the other VS models?

A: No. It is impossible.

OTHERS

Q: Is it possible to display the information that is on the LCD in the external VGA and operate the VS using a VGA display?

A: Separate information such as playlist and channel settings can be displayed in the external VGA. VGA display can show more information at once with 256 colors and four times more resolution than the LCD. You can control the VS-2400CD's functions using the external VGA display.

Q: What type of VGA monitor can be used?

A: There is no limitation of the size of display. On the VS-2400CD, you can select the refresh frequency including 60/66/70/75Hz, and you can adjust the image position. Use a CRT or LCD-style monitor with VGA (640x480 dot) capability, and the above refresh frequencies.

NOTE

If you have connected an LCD-type VGA monitor, the displayed image may be blurred on some types of monitor. This is caused by the "smoothing function" or "zoom function" of the VGA monitor.

Sometimes this can be solved by adjusting the refresh rate, but if no improvement occurs, turn off this function on your LCD-type VGA monitor. However, in this case, the image may appear rougher, or the displayed area may become smaller.

Q: Is it possible to use a pen tablet or track ball instead of the attached mouse?

A: Mouse port conforms to PS/2 but Roland does not officially support other devices than the attached mouse.

Q: Is it possible to write the Project in Wave format for Windows or AIFF format for Macintosh?

A: You can write the wave format for Windows (linear .WAV format) to the CD-R/RW disc.

Q: Is it possible to handle the VS-2400CD Project on the computer?

A: No. It is impossible to use VS-2400CD-formatted hard disk, Zip disk or CD-R/RW disc on the computer.

Q: Is there DAT backup/recover function?

A: No.

Q: Is there a data compatibility with ProTools?

A: No. However, data can be exchanged via WAV format.

Q: How much can I magnify the waveform display?

A: You can magnify the waveform display of the recorded audio data to a sample level and set the edit point. But minimum unit of the time designation is 16 samples.

Q: Is it possible to synchronize with video equipment?

A: Since MIDI connectors are provided, synchronized operation is possible if your video device is able to output MIDI messages.

Q: Is it possible to convert the sample rate on digital input/output?

A: No.

Q: Do the faders have touch sensors to recognize the current position?

A: No. To record the automix, you should set AUTOMIX STATUS to WRITE.

Q: Is there Vari-phrase function?

A: No.

Q: One of the stereo-linked faders does not move as fast as another one.

A: This is just the movement of the physical fader. The audio levels of both channels precisely follow the movement of the fader you are moving.

Q: The volume level of the instrument connected to ANALOG INPUT is too low.

A: Could you be using a connection cable that contains a resistor? Use a connection cable that does not contain a resistor.

How to Record with External Effects Devices Connected

There are two possible ways to carry out recording when you have external effects devices connected; you can use the track direct outs, or you can use the DIR path.

Using the track direct outs allows up to twelve tracks to be output simultaneously in parallel, while with the DIR path you can simultaneously output up to eight tracks in parallel (including the R-BUS output).

Using Track Direct Outs

Sounds recorded to Tracks 9–16 are output from ANALOG MULTI OUTPUT 1–8, external effects are added, and the sounds are returned to inputs in the VS-2400CD and recorded to Tracks 1–8.

Externally Outputting Tracks 9–16

1. Press **[TR1-12]**.
2. Press **[CH EDIT]** on Track Mixer Channel 9. The display switches to the Channel View screen.
3. Press **[◀][▶][▼][▲]** to move the cursor to “MIX.”
4. Rotate the TIME/VALUE dial to switch the setting to “OFF.” The sounds on Track 9 are now not sent to the MIX bus.
5. Press **[MASTER EDIT]**. The display switches to the Master Edit screen.
6. Press **[F3 (OUTPUT)]**. The display switches to the Output Assign screen.
7. Press **[◀][▶][▼][▲]** to move the cursor to “TRACK DIRECT OUT.”
8. Rotate the TIME/VALUE dial to switch the setting to “ON.” The VS-2400CD switches to Track Direct Out mode.
9. Press **[◀][▶][▼][▲]** to move the cursor to “A.MULTI 1/2.”
10. Rotate the TIME/VALUE dial to connect “A.MULTI 1/2” and “TR 9/10.” The sounds on Tracks 9 and 10 are output from ANALOG OUTPUT 1 and 2.
11. Use the same process to assign “TR 11/12” to A.MULTI 3/4, “TR 13/14” to A.MULTI 5/6, and “TR 15/16” to A.MULTI 7/8. The sounds on Tracks 11, 12, 13, 14, 15, and 16 are output from ANALOG MULTI OUTPUT 3, 4, 5, 6, 7, and 8, respectively.

MEMO

You can also make the Output Assign settings in the EZ ROUTING Output Assign screen (**[EZ ROUTING]**→**[F3 (OUTPUT)]**).

12. Connect each output to the external effects.

Using the DIR path

The sounds recorded to Tracks 9–12 are output using AUX A/B OUTPUT, external effects are added, and then the sounds are returned to inputs in the VS-2400CD and recorded to Tracks 1–4.

Externally Outputting Tracks 9–12

1. Press **[TR1-16]**.
2. Press **[CH EDIT]** on Track Mixer Channel 9. The display switches to the Channel View screen.
3. Press **[◀][▶][▼][▲]** to move the cursor to “DIR 1.”
4. Rotate the TIME/VALUE dial to switch “DIR 1” to “ON” (highlighted).
5. Press **[◀][▶][▼][▲]** to move the cursor to “MIX.”
6. Rotate the TIME/VALUE dial to switch the setting to “OFF.” The sounds on Track 9 are now not sent to the MIX bus.
7. In the same way, turn on DIR 2 for Track 10, and DIR 3 for Track 11.

MEMO

You can press **[ENTER]** with “DIR” at this point to show the DIR usage status.

8. Press **[MASTER EDIT]**. The display switches to the Master Edit screen.
9. Set DIR 1–4. You can set the level and the point from which the signals are sent from the channel (Pre/Pst).
10. Press **[F3 (OUTPUT)]**. The display switches to the Output Assign screen.
11. Press **[◀][▶][▼][▲]** to move the cursor to “AUX A L/R.”
12. Rotate the TIME/VALUE dial to connect “AUX A L/R” and “DIR 1/2.”

The sounds on Tracks 9 and 10 are output from AUX A.

13. Use the same process to assign “DIR 3/4” to “AUX B L/R.” The sounds on Tracks 11 and 12 are output from AUX B.

MEMO

You can also make the Output Assign settings in the EZ ROUTING Output Assign screen ([EZ ROUTING]→[F3 (OUTPUT)]).

14. Connect each output to the external effects.

Recording the Sounds Output from the External Effects to the Tracks

1. Connect the outputs of the external effects to ANALOG INPUT 1–8 (if using track direct outs as mentioned above).
2. Hold down [SHIFT] and press [EZ ROUTING (PATCH BAY)]. The display switches to the Patch Bay screen.
3. Press [◀][▶][▼][▲] to move the cursor to “INPUT MIXER 1 2.”
4. Rotate the TIME/VALUE dial to connect ANALOG INPUT 1 2. ANALOG INPUT 1 and 2 are input to the Input Mixer Channels 1 and 2.
5. In the same way, connect “ANALOG INPUT 3 4” to “INPUT MIXER 3 4,” “ANALOG INPUT 5 6” to “INPUT MIXER 5 6,” and “ANALOG INPUT 7 8” to “INPUT MIXER 7 8.” ANALOG INPUT 3, 4, 5, 6, 7, and 8 are input to the Input Mixer Channels 3, 4, 5, 6, 7, and 8, respectively.
6. Press [IN 1–12].
7. Hold down [CLEAR] and press [CH EDIT] for Input Mixer Channel 1. The level for Input Mixer Channel 1 is set to 0 dB.
8. In the same way, set the levels for Inputs 2–8 to 0 dB.
9. Press [PLAY] to play back the project, and confirm that sound from Inputs 1–8 is being output.
10. Press [MASTER EDIT].
11. Hold down [REC] and press [STATUS] for Input Mixer Channel 1. Track 1 enters recording standby mode (light flashing in red).
12. In the same way, put Tracks 2–8 into recording standby mode (light flashing in red).
13. Hold down [STATUS] for Input Mixer Channel 1. The display switches to the Quick Routing screen.
14. Press [F4 (AIIcIr)]. All track assignments are cleared.
15. Press [IN 1–16 (SOLO)].

16. Press [SELECT] for Input Mixer Channel 1. Input 1 is assigned to Track 1.
17. Press [STATUS] for Channel 2.
18. Press [SELECT] for Channel 2. Input 2 is assigned to Track 2.
19. In the same way, assign Inputs 3, 4, 5, 6, 7, and 8 to Tracks 3, 4, 5, 6, 7, and 8, respectively.
20. Press [HOME]. The VS-2400CD switches to Home condition.
21. Press [REC]. The VS-2400CD enters recording standby mode.
22. Press [PLAY]. Recording begins.
23. Press [STOP]. Recording stops.

Error Messages

Aborted Command!

Illegal Request!

This disk drive cannot be used by the VS-2400CD.

Arbitration Failed!

Check Condition!

Drive Status Error!

The disk drive could not be accessed. Make sure that the disk drive is connected correctly.

Blank Disc

The CD in your drive is blank. Insert a CD or CD-R/RW that contains recorded material.

Can't Communicate!

Drive Time-out!

Message Error!

Phase Mismatch!

Undefined Sense!

Unknown Drive Error!

There is a problem with your disk drive connection. Make sure the disk drive is connected correctly.

Cannot write in "Track at Once" format on CD-RW Disc!

You have tried to write the audio data in "Track at Once" format with a CD-RW disc in the drive.

Can't record CD!

Digital recording from a CD player is not enabled. Please read "CD Digital Parameter" and "Changing the Routing (EZ Routing Condition)" (Owner's Manual).

Can't Set Marker!

Track number markers must be at least four seconds apart.

DIGITAL In Lock

R-BUS Lock

The sample rate reference clock is set by the digital signal received at the DIGITAL IN connector as shown above. You can now record the digital signal.

DIGITAL In Unlock Change to Internal Clock?

R-BUS Unlock Change to Internal Clock?

You cannot yet record the incoming digital audio because it is not being received by the DIGITAL IN connector as shown above, or because the project sample rate and the sample rate of the digital device connected to the DIGITAL IN are different.

Switch the sample rate reference clock to the VS-2400CD's internal clock by pressing [ENTER/YES]. After checking to make sure that all digital devices are properly connected and that the sample rates for all of the devices match, try this operation again.

Drive Busy!

If this message appears when you first begin using a disk drive with the VS-2400CD, the disk drive is not fast enough. You may still be able to use this disk with projects that have a lower sample rate or use a different recording mode.

If this message appears after you have been using a disk drive with the VS-2400CD, the data on the disk drive has become fragmented. This will unacceptably slow down the reading and writing of data. Try bouncing the current track to re-record its data onto another track, or optimize your project. If this message still appears after these measures have been taken, copy the project data to another disk drive and initialize the disk drive that experienced the problem.

Drive Not Ready!

The disk drive is not yet ready. Please wait a moment.

Exceeding limit of RSS PAN Channels!

You have reached the maximum number of channels for which RSS pan can be used.

Finalized CD!

The CD is a commercial CD or a CD-R/RW disc you have already finalized. Replace the disc with a blank disc or one that has not yet been finalized.

Found Illegal Track Pair!

Found Illegal Phrase Pair!

Illegal Track Pair!

Illegal Phrase Pair!

You are trying to Region Edit or Phase Edit (Copy, Move, or Exchange etc.) between a V-Track recorded using CDRRecMode and a V-Track recorded using some other recording mode. Use V-Tracks that were recorded using the same recording mode.

FX Board for RSS PAN is not installed!

When a project or scene was loaded, the effect board necessary for using RSS pan was not found.

Hardware Error!

There is a problem with the disk drive. Contact the disk drive's manufacturer or dealer.

Illegal Track!

You are trying to create a new phrase using a V-Track recorded in CDRRecMode and a V-Track recorded using some other recording mode. Please use V-Tracks that were recorded using the same recording mode.

AUTOMIX: Event Memory Full!**Event Memory Full!**

The project already contains all of the events it can hold. Delete unneeded automix data or perform a Project Optimize operation.

Lack Of Event!

You have tried to undo or redo when the remaining number of free project events is less than 200. This operation cannot be performed.

Disk Memory Full!**Lack of IDE Memory!**

There is insufficient free space on the disk. Erase unneeded data or select a different disk drive. The current disk partition already contains 200 projects, the maximum number of projects it can hold. Delete unneeded projects or select a different disk drive.

CD-RW Memory Full!

There is not enough room on the CD-R/RW disc.

MARKER Memory Full!

The project already contains 1000 markers, the maximum number it can hold. Delete unneeded markers.

Medium Error!**Track 0 Not Found!****Medium Error!**

There is a problem with the disk drive media or CD. This disk cannot be used by the VS-2400CD. In some cases, data in the disk drive can be recovered using the Drive Check operation.

Invalid Disc!

It is not the ISO9660 format CD.

No Data on the Source Tracks!

The project you have selected contains no data.

Not 44.1 kHz Project!

The project's sample rate is not 44.1 kHz. Only 44.1 kHz audio can be written to a CD-R/RW disc.

Operation Failed!

Processing was halted due to insufficient memory or due to an error that occurred in the disk drive itself. Check your connections and verify the reliability of your hard drive.

Project Protected!

Since Project Protect is on, the operation cannot be executed.

TOC Error!

An error occurred while reading the CD-R/RW disc. There is a problem with the Roland CD recorder (CD-R/RW drive) or the CD-R/RW disc.

Too Many Index!

The CD already has 98 markers, the maximum number of markers it can hold.

Drive Unformatted!

The disk drive has not yet been initialized by the VS-2400CD. Initialize the disk drive.

If the disk drive has already been initialized by the VS-2400CD, there is a problem with its connections. Make sure that the disk drive is properly connected.

Operation Canceled!

You have aborted the procedure by pressing [EXIT/NO].

Write Protected!

The disk drive is write-protected.

Glossary

Analyzer

A device that divides the frequency spectrum into narrow bands, and displays a level meter for each function band to analyze the frequency distribution.

ATA

This is an interface for PC hard disks, and is the official standard for the interface known as IDE. It provides various improvements over the older IDE, such as increased transfer speed.

ATAPI

This is a specification that was developed in order to allow devices other than hard disks (such as CD-ROM drives) to be connected using the ATA specification.

CD-R

Short for **Compact Disc Recordable**. This is a system for reading and writing discs in the same format as that used for CDs (CD-ROMs and music CDs). A specialized CD-R drive allows one-time only writing of discs.

However, as long as the data has not been finalized and there is sufficient capacity remaining on the disc, the CD-R drive can be used for multiple additions to, and changes in the material.

Sometimes they are referred to as "Write Once CD," "CD-Write Once," or something similar.

CD-RW

Short for **Compact Disc ReWritable**. This is a system allowing creation of discs that can be read using the same format as regular CDs (CD-ROMs and Music CDs). While resembling the CD-R system in that it uses a special CD-RW drive, these discs can be rewritten any number of times.

Compressor

An effect that suppresses volume fluctuations. When the input signal exceeds a specified level (threshold), the gain is reduced as the input signal rises, thus suppressing signal overload. The same algorithm can also be used as a limiter (an effect that instantaneously suppresses peaks).

Of the effects in this system, only the compressor included in guitar multi 1–3 simulates a compact compressor for guitar, and works differently from a limiter. (It suppresses signal overloads, and also evens out the volume by raising low-level signals.)

COSM

Stands for **Composite Object Sound Modeling**. This is "a technology which combines multiple sound models to create new sounds," which was first used on the Roland's VG-8 V-Guitar System. For example, sounds created on the VG-8 are the result of a variety of sound models (elements) such as the pickup, the body of the guitar, the guitar amp, mic, and speaker etc.

Current Project

The project currently being recorded, played back, or edited is referred to as the current project.

DAT

Short for **Digital Audio Tape**. This refers both to the system of recording digitized sound to magnetic tape, as well as to the tapes themselves. Besides digital audio signals, all song information is recorded on the tape, including starts and track data, information to allow or prevent copying, etc.

Dynamics (effect)

Effects that compressor expand the range of volume changes. These effects are used to reduce noise when recording to tape, or to increase the dynamic range of a tape or wireless mic. Dynamics effects provided on this system include Enhancer, Expander, Compressor, and Limiter.

DSP

An abbreviation for **Digital Signal Processing**. Technology that uses dedicated circuitry or software calculations to process digitized audio or video signals in order to implement the functionality of a mixer, filter, or effect processor. By extension, DSP is also used to collectively refer to effect devices and effect functionality that uses such technology.

Expander

An effect that increases (by a fixed ratio) the difference in loud and soft volume levels, by making low-level signals softer, and high-level signals louder.

Finalize

This is the operation that writes the TOC to a prepared audio disc. Whereas additions and changes can be made to discs that have not yet been finalized, such discs are not playable on regular CD players.

Formants

A formant is an important element which determine the character of a vocal sound. It is a fixed overtone whose location is determined by the size of the vocal chords.

Conventional pitch shifters modify the pitch in a way that changes even the location of the formants (which by nature do not change). For example when a conventional pitch shifter raises the pitch, a "duck voice" is produced as if the vocal chords had shrunk, and when the pitch is lowered a "giant voice" is produced as if the vocal chords had expanded.

The Voice Transformer modifies the basic pitch and the formant separately, allowing a variety of voice characters to be created.

Frame

Similar to the individual frames in a roll of movie film, the numerous still pictures that are displayed in rapid succession to create a moving video image are also known as “frames.” About thirty of these frames are shown each second. When hard disk recorders, sequencers, and other such equipment are synchronized with video, it is generally assumed that there should be one frame every 1/30th of a second.

GUITAR (Hi-Z)

A high-impedance input jack for directly connecting electric guitars.

GPI

GPI stands for **General Purpose Interface**. This is a control jack provided on professional and consumer video devices such as video editors and title superimposers. By connecting this control jack to the foot switch jack of the VS-2400CD and setting the Foot Switch Assign to “GPI,” the connected device will be able to play back/stop the VS-2400CD.

IDE

IDE stands for **Integrated Device and Electronics**. This is the standard data transmission method used by the hard disk drives of recent personal computers. Currently, IDE complies with the formal standard known as ATA. The internal hard disk drives are IDE compatible.

IEC

The signals that are transferred via the digital input/output of this device comply with the IEC60958 and IEC958 (consumer) formats.

Limiter

An effect that works similarly to a compressor. When the input signal rises beyond a specified level (threshold), a limiter instantly lowers the gain to limit the output level. The degree of compression is specified by the Ratio. In general, ratios of 1:10 or less are referred to as compression, in distinction to limiting.

MMC

MMC is an acronym for **MIDI Machine Control**. This is rule that defines how MIDI system exclusive message can be used to control multiple recording devices from a single device. The VS-2400CD supports MMC. In addition to song play back, stop and fast-forward, you can also select the tracks for recording, etc.

MTC

MTC stands for **MIDI Time Code**. This is a group of messages which are transmitted and received between MIDI devices to synchronize their operation. Unlike MIDI Clock messages, MTC specifies an absolute time. Like SMPTE time code, MTC also supports a variety of frame rates. If you wish to use MTC to synchronize the operation of two devices, both devices must be set to the same frame rate.

NTSC Format

Color television format used in Japan, the United States, and other countries. Tapes recorded in the NTSC format cannot be played back on video decks utilizing the SECAM/PAL formats.

Oscillator

A device that generates an alternating signal. On this system, the term refers to the internal oscillator used to sound a reference tone for measurement by the spectrum analyzer. It is able to produce a 20 Hz–20 kHz sine wave, pink noise and white noise.

- Analyzer
- Sine wave
- Pink noise
- White noise

Phantom Power

This is a method of providing electric power to condenser mics via the mic cables. Generally, a mixer’s internal phantom power source supplies 6–48 volts (DC). Supplying phantom power to dynamic mics, audio play back devices, or other such equipment may result in damage to the equipment. Turn the phantom power switch on only when connecting condenser mics which need phantom power; otherwise, leave it switched off.

Pink noise

Noise that contains equal amounts of energy in each octave of the frequency spectrum. On this system, the internal oscillator can be used to generate pink noise in the audio bandwidth.

- Oscillator
- Analyzer

PS/2 Keyboard, PS/2 Mouse

This keyboard and mouse can be connected to the connectors furnished on PS/2 computers developed by IBM in the United States. The VS-2400CD allows you to use a PS/2 keyboard, input names, and perform operations using the PS/2 mouse.

R-BUS

Roland's digital communication specification developed to allow audio and control data to be exchanged between devices. Multi-channel audio signals, word clock, and MIDI-compatible operation data and synchronization signals can be exchanged. A single R-BUS connector allows simultaneous bi-directional transfer of eight channels of digital audio data. The connector is a DB-25 type, and uses a special cable for connections. It should NOT be connected to other types of ports that use similar connectors!

RSS

RSS stands for **Roland Sound Space**. This is an effect which allows a sound source to be placed in three-dimensional space when played back on a conventional stereo system. The sound can be placed not only in front of the listener, but also directly to the side, above, below, and behind the listener.

SCMS

SCMS stands for **Serial Copy Management System**. This is a function that protects the rights of copyright holders by prohibiting recording via a digital connection for more than two generations. When digital connections are made between digital recorders that implement this function, SCMS data will be recorded along with the audio data. Digital audio data which contains this SCMS data cannot again be recorded via a digital connection.

SECAM Formats/PAL Formats

Color television formats used in Europe and other areas. Tapes recorded in the SECAM or PAL formats cannot be played back on video decks designed for the NTSC format.

Shutdown

In order to turn the power off safely, you must first make sure that the performance has been saved to hard disk, and that the hard disk heads are parked. This procedure is referred to as Shutdown.

Sine wave

A sinusoidal waveform. This is the simplest waveform, and contains only a specific frequency without any other frequency components. On this system, the internal oscillator can generate a sine wave at any desired frequency in the range of 20 Hz–20 kHz.

SMPTE time code

This is a signal format defined by the American organization SMPTE (Society of Motion Picture and Television Engineers) which is used to synchronize the operation of video or audio devices. SMPTE specifies "hours:minutes:seconds:frames" to indicate the address of each frame of a video image. For this reason, there are a variety of frame rates.

TOC

Short for Table of Contents. This is the region on the CD-R disc that handles information such as song times, end times, sequence, and so on. Although the songs on a disc and their playing time can be displayed when an audio CD is placed in a CD player, this is because they can be read automatically from the TOC. The TOC is recorded differently than music data, with its main characteristic being disc access, such as the ability to go to the start of any song instantly.

Track Minutes

The amount of available recording time that is called for a standard unit corresponding to the time of one continuous monaural signal recorded to one track.

VGA

Although developed by IBM in America as a graphics system with a resolution of 640 x 480 pixels able to display sixteen colors, various companies have further developed VGA-compatible modes, enabling high-resolution multi color displays. Today, rather than designating a particular graphics system, VGA has instead come to mean a standard of high-resolution graphics. The VS-2400CD is equipped with a VGA output connector, allowing you to connect a VGA monitor and display the information with a resolution of 640 x 480 pixels in 256 colors.

White noise

Noise that contains equal energy at all frequencies. On this system, the internal oscillator can be used to generate white noise in the audio bandwidth. Perceptually, and when observed on a spectrum analyzer, the level will appear to rise as you move toward the higher range.

- Analyzer
- Oscillator

Shortcut Key Operations

Here is a list of the functions that can be performed by pressing multiple buttons, or using the **TIME/VALUE** dial in conjunction with a button.

CH EDIT/SELECT/AUTOMIX STATUS buttons

[AUTOMIX] + [AUTOMIX STATUS] (*1)	Switch the Automix status of each channel (when Automix is "on")
[SHIFT] + [CH EDIT]	Adjust the each channel faders to set the "0 dB," and the PAN knobs to set the "Center."
[CH EDIT] + [CH EDIT] (*2)	Channel Link mode on/off

(*1) INPUT1-12, INPUT13-16, AUX1-8 MST, TRACK1-12, TRACK13-24, FX1-4 RTN

(*2) Hold down the [CH EDIT] button of an odd-numbered channel, and press the [CH EDIT] button of the next highest-numbered (even-numbered) channel.

TRACK STATUS buttons

Hold [STATUS]	To select the source to be recorded to the destination track (Quick Routing).
(When using the Quick Routing screen) [TRACK STATUS] + [CLEAR]	All track assignments are canceled.

Transport Control buttons

[SHIFT] + [ZERO (STORE)]	Store current song data to the disk drive
[SHIFT] + [STOP (SHUTDOWN)]	Shutdown
(after shutdown) [SHIFT] + [PLAY (RESTART)]	Restart
[SHIFT] + [REW (PROJECT TOP)]	Moves to the first recorded audio of the project.
[SHIFT] + [FF (PROJECT END)]	Moves to the last recorded audio of the project.
[REC] + [TRACK STATUS] (1-24)	Switch the status to REC (REC indicator blinks red)
[STOP] + [TRACK STATUS] (1-24)	Switch the status to PLAY (PLAY indicator lights green)

Shortcut Key Operations

LOCATOR/SCENE buttons

[LOCATOR] → [CLEAR] + [0]—[9]	Clear the setting of locators
[SHIFT] + [LOCATOR (BANK)] → [0]—[9]	Switch the locator bank
[SCENE] → [CLEAR] + [0]—[9]	Clear the setting of scenes
[SHIFT] + [SCENE (BANK)] → [0]—[9]	Switch the scene bank
[CLEAR] + [TAP]	Erase a marker
[SHIFT] + [CLEAR] + [TAP] → [ENTER/YES]	Erase all markers
[AUTOMIX] + [TAP (SNAPSHOT)]	Stores a snapshot (When Automix is “on”)
[AUTOMIX] + [REC]	Automix real time recording (when Automix is “on.”)
[SHIFT] + [4 (IN)] (*3)	Register the in point
[SHIFT] + [5 (OUT)] (*3)	Register the out point
[SHIFT] + [9 (FROM)] (*3)	Register the from point
[SHIFT] + [0 (TO)] (*3)	Register the to point
[SHIFT] + [CLEAR] + [4 (IN)]	Clear the track edit in point
[SHIFT] + [CLEAR] + [5 (OUT)]	Clear the track edit out point
[SHIFT] + [CLEAR] + [9 (FROM)]	Clear the track edit from point
[SHIFT] + [CLEAR] + [0 (TO)]	Clear the track edit to point
[A.PUNCH] + [4 (IN)]	Register the auto punch-in point
[A.PUNCH] + [5 (OUT)]	Register the auto punch-out point
[A.PUNCH] + [TAP]	Register the auto punch-in point and clear the auto punch-out point.
[LOOP] + [9 (FROM)]	Register the loop-from point
[LOOP] + [0 (TO)]	Register the loop-to point
[LOOP] + [TAP]	Register the loop-from point and clear the loop-to point.
[A.PUNCH] + [CLEAR] + [4 (IN)]	Clear the auto punch-in point
[A.PUNCH] + [CLEAR] + [5 (OUT)]	Clear the auto punch-out point
[LOOP] + [CLEAR] + [9 (FROM)]	Clear the loop-from point
[LOOP] + [CLEAR] + [0 (TO)]	Clear the loop-to point

(*3) If a time location has already been registered to a point, and the Global parameter EDIT POINT Sw TYPE is set to “Same as Locator,” you will jump to the time location that is registered for that point.

PHRASE/MARKER buttons

[PREVIOUS]	If there is a phrase at the current location, move to the beginning of that phrase. (*4) If not, move to the end of the previous phrase. (*4) Move to the previous marker. (*5)
[NEXT]	If there is a phrase at the current location, move to the end of that phrase. (*4) If not, move to the beginning of the next phrase. (*4) Move to the next marker. (*5)
[CD-RW MASTERING] + [TAP]	Register a marker for audio CD track number

(*4) when PREVIOUS/NEXT Sw is "PHRASE."

(*5) when PREVIOUS/NEXT Sw is "MARKER."

Other

[SHIFT] + [CD-RW (MASTERING)]	To Mastering Room setting screen
[SHIFT] + [HOME (DISPLAY)]	Switch the Graphic display (Home Condition)
[SHIFT] + [UNDO (REDO)]	Redo function (when the UNDO indicator is lit)
[SHIFT] + [TAP]	To the Tempo map setting screen
[SHIFT] + [NUMERICS (EXT SYNC)]	To the Sync parameter settings screen
[SHIFT] + [LOOP]	To the loop start/end point setting screen
[SHIFT] + [AUTO PUNCH]	To the punch in/out point setting screen
[SHIFT] + [MASTER EDIT (VGA↔LCD)]	Switch the operation display
[SHIFT] + [▼] [▲]	Zoom to change the number of tracks appearing in the playlist display.
[SHIFT] + [◀] [▶]	Change of the time axis display width of the playlist.
[SHIFT] + TIME/VALUE dial	Modify the value at 10 times the usual speed. When adjusting the channel level and AUX Send level, value is changed per 0.1 dB. In Play condition when the cursor is displayed at the sub frame of the time code display, move the current time in units of approximately 1/100 frame.
[SHIFT] + [SOLO]	All solo mode is turned off
[SHIFT] + [MUTE]	All mute mode is turned off
[SHIFT] + [EZ ROUTING]	To the PATCH BAY (and phantom power sw) screen
[SHIFT] + [AUTOMIX]	To the Automix screen
[SHIFT] + [CH EDIT]	Adjust each channel fader to set the channel level to "0 dB," and the PAN knobs to "Center."
[HOME] + The VS-2400CD turn on	Select the LCD as the main display.
[CLEAR] + Fader	Temporarily unlink the fader from its group so you can adjust its level independently.
[SHIFT] + (CH PARAMETER) [PAN]	To the RSS PAN setting screen

Shortcut Key Operations

Mouse Operation

[SHIFT] + Dropping	Copy the data.
--------------------	----------------

ASCII Keyboard

<SPACE>	PLAY/STOP the project performance.
<↓> <↑> <←> <→>	Same as the cursor on the panel
<Shift> + <↓> <↑> <←> <→> (*6)	Playlist zoom
<Ctrl> + <Alt> + <Delete>	Shutdown
<Enter ↵>	Same as [ENTER/YES]
<Esc>	Same as [EXIT/NO]
<Tab>	Same as [PAGE]
<F1>–<F6>	Same as [F1]–[F6]
<Shift> + <F1> (*6)	To the project condition screen
<Shift> + <F2> (*6)	To the track condition screen
<Shift> + <F3> (*6)	To the effect condition screen
<Shift> + <F4> (*6)	To the utility condition screen
<Shift> + <F5> (*6)	To the wave display on/off
<Shift> + <F6> (*6)	To the marker setting screen
<F7>	To the EZ routing condition screen
<Shift> + <F7> (*6)	To the PATCH BAY (and phantom power sw) screen
<F8>	To the CD-RW Mastering condition screen
<Shift> + <F8> (*6)	To the Mastering room screen
<F12>	Same as [NUMERICS]
<Ctrl> + <S>	Store current song data to the disk drive
<Home>	Same as [HOME]
<Shift> + <HOME> (*6)	Change the playlist mode (same as [SHIFT] + [HOME])

< > < > indicates a key on the ASCII keyboard.

(*6) Combinations using <Shift> on the ASCII keyboard and another key are valid only on the ASCII keyboard. This means that you cannot combine the ASCII keyboard's <Shift> key with a button on the VS-2400CD's panel, nor can you use the [SHIFT] on the VS-2400CD's panel in combination with a key on the ASCII keyboard.

Parameter List

Input Mixer [IN 1-12] (or [IN 13-16]) → [CH EDIT] (IN 1-12, 13-16)]

Parameter name	Display	Value, Initial value
Patchbay	-	ANALOG INPUT 1-8, R-BUS 1-8, COAXIAL, OPTICAL (*1)
Channel Link	Link	Off , On
Attenuator	ATT	-42.0- 0.0 +6.0 dB
Phase	Phase	NRM , INV
Fader Group	Group	Off , 1-12
Fader Link	F.LINK	Off , On
Level Meter	-	Pre , Pst
Solo	Solo	Off , On
Mute	Mute	Off , On
Offset Level	-	-∞- 0.0 +6.0 dB (*2)
Fader	Fader	-∞+6.0 dB
Mix Send Switch	MIX	Off, On
Offset Pan	PAN	L63- C -R63 (*3)
Mix Send Pan	PAN	L63- 0 -R63
Pan Mode	-	NRM , RSS
RSS Pan	PAN	0 -R??-180-L??- 0 (*17)
Dynamics Switch	DYN Sw	Off , On
Dynamics Type	DYN Type	COMPRESSOR , EXPANDER (*5)
Compressor Auto Gain Switch	AutoGain	Off, On (*4) (*5)
Compressor Key In	KeyIn	IN1-16 (Initial value is the current channel) (*4) (*5)
Compressor Threshold Level	Threshold	-24.0 -0.0 dB (*4) (*5)
Compressor Ratio	Ratio	1.00:1- 2.00 :1-∞:1 (*4) (*5)
Compressor Attack	Attack	0.0- 10.0 -800.0ms (*4) (*5)
Compressor Release	Release	0- 500 -8000 ms (*4) (*5)
Compressor Level	Level	-24.0- 0.0 +24.0 dB (*4) (*5) (*6)
Expander Key In	KeyIn	IN1-16 (Initial value is the current channel) (*5) (*7)
Expander Threshold Level	Threshold	-80.0- -40.0 -0.0 dB (*5) (*7)
Expander Ratio	Ratio	1.00:1- 2.00 :1-∞:1 (*5) (*7)
Expander Attack	Attack	0.0 -800.0ms (*5) (*7)
Expander Release	Release	0- 500 -8000 ms (*5) (*7)
Equalizer Switch	EQ Sw	Off, On (*5)
Equalizer Low Gain	EQ Low G	-15.0- 0.0 -15.0 dB (*5) (*8)
Equalizer Low Frequency	EQ Low F	20 Hz- 80 Hz -1.0 kHz (*5) (*8)
Equalizer Low Mid Gain	EQ Lo-Mid G	-15.0- 0.0 -15.0 dB (*5) (*8)
Equalizer Low Mid Frequency	EQ Lo-Mid F	20 Hz- 400 Hz -20.0 dB (*5) (*8)
Equalizer Low Mid Q	EQ Lo-Mid Q	0.36- 2.00 -16.0 (*5) (*8)
Equalizer High Mid Gain	EQ Hi-Mid G	-15.0- 0.0 -15.0 dB (*5) (*8)
Equalizer High Mid Frequency	EQ Hi-Mid F	20 Hz- 2.00 kHz -20.0 kHz (*5) (*8)

Parameter List

Parameter name	Display	Value, Initial value
Equalizer High Mid Q	EQ Hi-Mid Q	0.36– 2.00 –16.0 (*5) (*8)
Equalizer High Gain	EQ High G	-15.0– 0.0 –15.0 dB (*5) (*8)
Equalizer High Frequency	EQ High F	1.0 kHz– 10.0 kHz –20.0 kHz (*5) (*8)
AUX Send Switch	AUX (1–8)	Off, Pre/ Pst (*9)
AUX Send Level	-	-∞– 0.0 +6.0 (*10)
AUX Send Pan	-	L63– C –R63 (*11)
Direct Path Switch	DIR (1–8)	1, ..., 8 (INPUT MIXER CH 1), Off, On
Effect Insert Switch	FX1–4	Off , Ins, InsL, InsR, InsS (*12)
Effect Insert Send Level	Snd	-∞– 0.0 +6.0 dB (*13)
Effect Insert Return Level	Rtn	-∞– 0.0 +6.0 dB (*13)
Surround Pan	SURROUND PAN	L63– C –R63 (*14)
Surround Depth	SURROUND DEPTH	F63– C –R63 (*14)
Surround LR:C Rate	SURROUND LR:C	0– 50 –100 % (*14) (*15)
Surround Sub Woofer Level	SURROUND Sub.W	-∞– 0.0 +6.0 dB (*14) (*16)

- *1 Patchbay works in pairs. Odd-numbered channel can select an odd-numbered input or Lch, and even-numbered channel can select an even-numbered input or Rch.
Selectable area of the patchbay varies by the select settings of COAXIAL and OPTICAL in the Project parameters.
- *2 Valid when Channel Link is "On."
- *3 If Channel Link is On, the "Pan" parameter will change to the offset pan parameter.
- *4 Valid when Dynamics Type is "COMPRESSOR."
- *5 Only Input Mixer Channel 1–8 (when sampling frequency is 48/44.1/32 kHz).
Only Input Mixer Channel 1–4 (when sampling frequency is 96/88.2/64 kHz).
- *6 Max +6.0dB when compressor auto gain switch is "On."
- *7 Valid when Dynamics Type is "EXPANDER."
- *8 Changes in parameter settings accepted at any time. However, the settings are reflected in the outcome only when the Equalizer Switch is "On."
- *9 Pre/Pst is switched at the same time by each bus in MASTER EDIT.
- *10 Valid when AUX Switch is except "Off."
- *11 Valid when AUX Bus Link is "On."
- *12 "Off" or "Ins" are valid when Channel Link is "On."
- *13 Valid when Effect Insert Switch is except "Off."
- *14 Valid when Surround Mix Switch is "On."
- *15 Valid when Surround Mix Mode is except "2+2."
- *16 Valid when Surround Mix Mode is "3+2+1."
- *17 Valid when Pan Mode is "RSS." Value changes as follows.
Value increase from 0: 0 → R3 → R6 →... → R177 → 180 → L177 → L174 →... → L3 → 0
Value decrees from 0: 0 → L3 → L6 →... → L177 → 180 → R177 → R174 →... → R3 → 0

Track Mixer [TR 1-12] (or [TR 13-16]) → [CH EDIT] (TR 1-12, 13-16)

Parameter name	Display	Value, Initial value
V-track	V.Track	1-16
Channel Link	Link	Off, On
Attenuator	ATT	-42.0-0.0+6.0 dB
Phrase	Phase	NRM, INV
Fader Group	Group	Off, 1-12
Level Meter	Meter	Pre, Pst
Solo	Solo	Off, On
Mute	Mute	Off, On
Offset Level	-	-∞-0.0+6.0 (*1)
Fader	Fader	-∞-0.0+6.0 dB
Mix Send Switch	MIX	Off, On
Offset Pan	Pan	L63-C-R63 (*2)
Mix Send Pan	Pan	L63-C-R63
Pan Mode	-	NRM, RSS
RSS Pan	PAN	0-R??-180-L??-0 (*15)
Dynamics Switch	DYN Sw	Off, On
Dynamics Type	DYN Type	COMPRESSOR, EXPANDER
Compressor Auto Gain Switch	AutoGain	Off, On (*3)
Compressor Key In	KeyIn	TR1-24 (Initial value is the current channel)(*3)
Compressor Threshold Level	Threshold	-24.0-0.0 dB (*3)
Compressor Ratio	Ratio	1.00:1-2.00:1-∞:1 (*3)
Compressor Attack	Attack	0.0-10.0-800.0ms (*3)
Compressor Release	Release	0-500-8000 ms (*3)
Compressor Level	Level	-24.0-0.0+24.0 dB (*3) (*4)
Expander Key In	KeyIn	TR1-24 (Initial value is the current channel) (*5)
Expander Threshold Level	Threshold	-80.0-40.0-0.0 dB (*5)
Expander Ratio	Ratio	1.00:1-2.00:1-∞:1 (*5)
Expander Attack	Attack	0.0-800.0ms (*5)
Expander Release	Release	0-500-8000 ms (*5)
Equalizer Switch	EQ Sw	Off, On
Equalizer Low Gain	EQ Low G	-15.0-0.0-15.0 dB (*6)
Equalizer Low Frequency	EQ Low F	20 Hz-80 Hz-1.0 kHz (*6)
Equalizer Low Mid Gain	EQ Lo-Mid G	-15.0-0.0-15.0 dB (*6)
Equalizer Low Mid Frequency	EQ Lo-Mid F	20 Hz-400 Hz-20.0 dB (*6)
Equalizer Low Mid Q	EQ Lo-Mid Q	0.36-2.00-16.0 (*6)
Equalizer High Mid Gain	EQ Hi-Mid G	-15.0-0.0-15.0 dB (*6)
Equalizer High Mid Frequency	EQ Hi-Mid F	20 Hz-2.00 kHz-20.0 kHz (*6)
Equalizer High Mid Q	EQ Hi-Mid Q	0.36-2.00-16.0 (*6)

Parameter List

Parameter name	Display	Value, Initial value
Equalizer High Gain	EQ High G	-15.0- 0.0 -15.0 dB (*6)
Equalizer High Frequency	EQ High F	1.0 kHz- 10.0 kHz -20.0 kHz (*6)
AUX Send Switch	AUX (1-8)	Off, Pre/ Pst (*7)
AUX Send Level	-	-∞-+6.0 (*8)
AUX Send Pan	-	L63- 0 -R63 (*9)
Direct Path Switch	DIR (1-8)	Off , On
Effect Insert Switch	FX (1-4)	Off , Ins, InsL, InsR, InsS (*10)
Effect Insert Send Level	Snd	-∞- 0.0 -6.0 dB (*11)
Effect Insert Return Level	Rtn	-∞- 0.0 -6.0 dB (*11)
Surround Pan	SURROUND PAN	L63- C -R63 (*12)
Surround Depth	SURROUND DEPTH	F63- C -R63 (*12)
Surround LR:C Rate	SURROUND LR:C	0- 50 -100 % (*12) (*13)
Surround Sub Woofer Level	SURROUND Sub.W	-∞- 0.0 +6.0 dB (*12) (*14)

- *1 Valid when Channel Link is "On."
- *2 If Channel Link is On, the "Pan" parameter will change to the offset pan parameter.
- *3 Valid when Dynamics Type is "COMPRESSOR."
- *4 Max +6.0dB when compressor auto gain switch is "On."
- *5 Valid when Dynamics Type is "EXPANDER."
- *6 Changes in parameter settings accepted at any time. However, the settings are reflected in the outcome only when the Equalizer Switch is "On."
- *7 Pre/Pst is switched at the same time by each bus in MASTER EDIT.
- *8 Valid when AUX Switch is except "Off."
- *9 Valid when AUX Bus Link is "On."
- *10 "Off" or "Ins" are valid "Off" or "Ins" when Channel Link is "On."
- *11 Valid when Effect Insert Switch is except "Off."
- *12 Valid when Surround Mix Switch is "On."
- *13 Valid when Surround Mix Mode is except "2+2."
- *14 Valid when Surround Mix Mode is "3+2+1."
- *15 Valid when Pan Mode is "RSS." Value changes as follows.
 Value increase from 0: 0 → R3 → R6 →... → R177 → 180 → L177 → L174 →... → L3 → 0
 Value decreases from 0: 0 → L3 → L6 →... → L177 → 180 → R177 → R174 →... → R3 → 0

Effect Return [AUX1-8 FX1-4 RTN] → [CH EDIT] (FX 1-4 RTN)

Parameter name	Display	Value, Initial value
Assign	ASSIGN	AUX1-AUX8, DIR1-DIR8
Fader Group	GROUP	Off, On
Mono Switch	MONOSw	Off, On
Level Meter	-	Pre, Post
Solo	Solo	Off, On
Mute	Solo	Off, On
Effect Return Level	FADER	-∞-0.0+6.0 dB
Effect Return Balance	BAL	L63-C-R63
Mix Send Switch	MIX	Off, On
AUX Send Switch	AUX (1-8)	Off, On
AUX Send Level	-	-∞+6.0 dB
AUX Send Pan	-	L63-C-R63
Direct Path	DIR (1-8)	Off, On
Surround Pan	SURROUND PAN	L63-C-R63 (*1)
Surround Depth	SURROUND DEPTH	F63-C-R63 (*1)
Surround LR:C Rate	SURROUND LR:C	0-50-100 % (*1) (*2)
Surround Sub Woofer Level	SURROUND Sub.W	-∞-0.0+6.0 dB (*1) (*3)

*1 Valid when Surround Mix Switch is "Off."

*2 Valid when Surround Mix Mode is except "2+2."

*3 Valid when Surround Mix Mode is "3+2+1."

Master Block [MASTER EDIT]

Parameter name	Display	Value, Initial value
Master Level	MST	-∞-0.0-6.0 dB
Master Balance	-	L63-C-R63
Monitor Level	MON	-∞-6.0 dB
Monitor Balance	-	L63-C-R63
AUX Master Position	AUX (1-8)	Pre, Pst
AUX Master Level	AUX (1-8)	-∞-0.0-6.0 dB
AUX Bus Link	LINK	Off, On
AUX Master Balance	AUX	L63-C-R63 (*1)
DIR Master Position	DIR (1-8)	Pre, Pst
DIR Master Level	DIR (1-8)	-∞-0.0-6.0 dB
DIR Master Balance	DIR (1-8)	L63-C-R63 (*2)
Rec Bus Attenuator	REC ATT	-42-6.0-0.0 dB
Monitor Source	MONITOR	MASTER, REC BUS, AUX1, ..., AUX8, DIR1, ..., DIR8
AUX A	AUX A L/R	MASTER, MONITOR, AUX1/2, ..., AUX7/8, DIR1/2, ..., DIR7/8

Parameter List

Parameter name	Display	Value, Initial value
AUX B	AUX B L/R	MASTER, MONITOR, AUX1/2, AUX3/4 , ..., AUX7/8, DIR1/2, ..., DIR7/8
ANALOG MULTI OUTPUT	A.MULTI (1/2–7/8)	TR 1/2, ..., TR23/24, MONITOR (*3), MASTER, MONITOR, AUX1/2, AUX3/4, L/R, Ls/Rs, DIR1/2, ..., DIR7/8 (*4) MASTER, MONITOR, AUX1/2, AUX3/4, L/R, C/RC, DIR1/2, ..., DIR7/8 (*5) MASTER, MONITOR, AUX1/2, L/R, Sub.W/C, Ls/Rs, DIR1/2, ..., DIR7/8 (*6)
R-BUS 1/2	R-BUS 1/2	MASTER, MONITOR, AUX1/2 , ..., AUX7/8, DIR1/2, ..., DIR7/8
R-BUS 3/4	R-BUS 3/4	MASTER, MONITOR, AUX1/2, AUX3/4 , ..., AUX7/8, DIR1/2, ..., DIR7/8
R-BUS 5/6	R-BUS 5/6	MASTER, MONITOR, AUX1/2, ..., AUX5/6 , AUX7/8, DIR1/2, ..., DIR7/8
R-BUS 7/8	R-BUS 7/8	MASTER, MONITOR, AUX1/2, ..., AUX7/8 , DIR1/2, ..., DIR7/8
COAXIAL L/R	COAXIAL L/R	MASTER , MONITOR, AUX1/2, ..., AUX7/8, DIR1/2, ..., DIR7/8
OPTICAL L/R	OPTICAL L/R	MASTER , MONITOR, AUX1/2, ..., AUX7/8, DIR1/2, ..., DIR7/8
PHONES L/R	PHONES L/R	MASTER, MONITOR , AUX1/2, ..., AUX7/8, DIR1/2, ..., DIR7/8
Effect Insert Switch (1–4)	FX (1–4)	Off , Ins
Effect Insert Send Level	Snd	–∞– 0.0 –6.0 dB (*7)
Effect Insert Return Level	Rtn	–∞– 0.0 –6.0 dB (*7)
Track Direct Out	TRACK DIRECT OUT	Off , On
Track Direct Source	TRACK DIRECT SOURCE	PostFader, PreFader

*1 Valid when AUX Bus Link is “On.”

*2 Valid when DIR is selected by the linked channel or FX RTN channel

*3 Valid when Track Direct Out is “On.”

*4 Valid when Surround Mix Switch is “On,” and Surround Mix Mode is “2+2.”

*5 Valid when Surround Mix Switch is “On,” and Surround Mix Mode is “3+1.”

*6 Valid when Surround Mix Switch is “On,” and Surround Mix Mode is “3+2+1.”

*7 Valid when Effect Insert Switch is “3+2+1.”

System Parameter [SHIFT]+[F4 (UTILITY)] → [(Page1) F1 (SYSTEM)]

Parameter name	Display	Value, Initial value
Analog Input Phantom Switch	ANALOG INPUT	Off , On
External Level Meter Display Section	DISPLAY SECTION	Off , ANALOG INPUT 1-8, R-BUS/COAX/OPT IN, INPUT MIXER 1-16, TRACK MIXER 1-24, FX1-4 RETURN, AUX1-8/DIR1-8, ANALOG OUTPUT, R-BUS/COAX/OPT OUT
Meter Position	METER POSITION	Pre , Post
MB-24 Time Display	TIME DISPLAY	MEASURE/BEAT, TIME CODE , CLOCK/SCENE
MB-24 Meter Scale	METER SCALE	X1 , X1/2
VGA Out	VGA OUT	Off, On
Refresh Rate	REFRESH RATE	60 Hz , 66Hz, 70Hz, 75Hz
Horizontal Position	H.POSITION	-5-0-+5
Vertical Position	V.POSITION	When "REFRESH RATE" is 60 Hz: -21-0-+22 When "REFRESH RATE" is 66 Hz: -15-0-+16 When "REFRESH RATE" is 70 Hz: -37-0-+37 When "REFRESH RATE" is 75 Hz: -11-0-+11
Operation Target	OPERATION TARGET	LCD , VGA
PS/2 Mouse	PS/2 MOUSE	Off, On
Pointer Speed	POINTER SPEED	1, 2, 3 , 4, 5
PS/2 Keyboard	PS/2 KEYBOARD	Off , On
Mouse Button Swap Switch	MOUSE BUTTON SWAP Sw.	Off , On
Keyboard Type	KEYBOARD TYPE	101/104 , 106/109, PS/2(French), PS/2(Germany), PS/2(Italian), PS/2(Spanish)

Parameter List

Global Parameter [SHIFT]+[F4 (UTILITY)] → [(Page1) F2 (GLOBAL)]

Parameter name	Display	Value, Initial value
Input Peak Level	INPUT PEAK LEVEL	0 dB, -3 dB, -6 dB
Foot Switch Assign	FOOT SWITCH ASSIGN	Play/Stop , Record, TapMarker, Next, Previous, GPI
CD Digital Recording	CD DIGITAL REC	Off , On
Screen Saver	SCREEN SAVER	Off , 1–30 min
Shift Lock	SHIFT LOCK	Off , On, Once
Switching Time	SWITCHING TIME	0.3– 0.5 –2.0 sec
Locator/Scene Type	LOCATOR/SCENE TYPE	Safe, Quick
Previous/Next Switch	PREVIOUS/NEXT Sw	PHRASE , MARKER
Return to Locate Switch	RETURN TO LOCATE Sw	Off, On
Numerics Type	NUMERICS TYPE	Up , Down
Edit Point Switch Type	EDIT POINT Sw TYPE	OVERWRITE , Same as LOCATOR
Undo Message	UNDO MESSAGE	Off, On
Edit Message	EDIT MESSAGE	Off, On
Grid Mode	GRID MODE	Only TO , ALL EDIT POINT
Date/Remain Switch	DATE/REMAIN Sw	Date , Remain
Remaining Display Type	REMAIN DISP TYPE	Time , CapaMB, Capa %, Event

Project Parameter [SHIFT]+[F4 (UTILITY)] → [(Page1) F3 (Proj)]

Parameter name	Display	Value, Initial value
Master Clock	MASTER CLOCK	INT , R-BUS, DIGITAL IN (SELECT=COAXIAL, OPTICAL), EXT TIME CODE (Sync=MIDI IN, R-BUS)
Dither	DITHER	Off , 24bit, 23bit, ... , 8bit
Digital Copy Protect	DIGITAL COPY PROTECT	Off , On
Digital in Select	DIGITAL IN SELECT	COAXIAL , OPTICAL
Display Offset Time	DISPLAY OFFSET TIME	00:00:00.00 –23:59:59:29.99 (*)
Time Display Format	TIME DISPLAY FORMAT	ABS , REL
Peak Hold Switch	PEAK HOLD Sw	Off , On

* The settable value for Offset will change slightly depending on the MTC type.

Play/Recording Parameter [SHIFT]+[F4 (UTILITY)] → [(Page1) F4 (PlyRec)]

Parameter name	Display	Value, Initial value
Record Monitor	RECORD MONITOR	Auto , Source
Marker Stop	MARKER STOP	Off , On
Fade Curve	FADE CURVE	Linear , Exp
Fade Length	FADE LENGTH	2, 10 , 20, 30, 40, 50 ms
Vari Pitch Switch	VARI PITCH Sw	Off , On
Vari Pitch	Vari Pitch	16.00 kHz– 96.00 kHz –98.00 kHz (fs=96.0 kHz) 16.00 kHz– 88.20 kHz –98.00 kHz (fs=88.2 kHz) 16.00 kHz– 64.00 kHz –98.00 kHz (fs=64.0 kHz) 16.00 kHz– 48.00 kHz –50.00 kHz (fs=48.0 kHz) 16.00 kHz– 44.10 kHz –50.00 kHz (fs=44.1 kHz) 16.00 kHz– 32.00 kHz –50.00 kHz (fs=32.0 kHz)
Solo/Mute Switch Type	SOLO/MUTE Sw TYPE	All Bus Send , MIX BUS Send
Scrub Length	SCRUB LENGHT	25– 70 –100 ms
Preview To Length	PREVIEW TO LENGHT	1.0 –10.0 sec
Preview From Length	PREVIEW FROM LENGHT	1.0 –10.0 s

MIDI Parameter [SHIFT]+[F4 (UTILITY)] → [(Page1) F5 (MIDI)]

Parameter name	Display	Value, Initial value
MIDI through Switch	MIDI OUT/THRU	Out , Thru
Device ID	DEVICE ID	1– 17 –32
Control Local Switch	CONTROL LOCAL SW	Off, On
System Exclusive Receive Switch	SysEx. Rx Sw	Off, On
System Exclusive Transmit Switch	SysEx. Tx Sw	Off , On
Mixer Control Type	MIXER CONTROL TYPE	Off , C.C., Excl
Scene Program Change Receive Switch	SCENE P.C. Rx Sw	Off , On
Effect Program Change Receive Switch	EFFECT P.C. Rx Sw	Off , On
Effect Control Change Receive Switch	EFFECT C.C. Rx Sw	Off , On
MMC Mode	MMC MODE	Off, MASTER , SLAVE
MMC source	MMC SOURCE	MIDI , R-BUS

MIDI Bulk Dump [SHIFT]+[F4 (UTILITY)] → [(Page1) F5 (MIDI)] → [F5 (BlkDmp)]

Parameter name	Display	Value, Initial value
Scene Bulk Transmit Target	SCENE BULK Tx Target	ALL , 00–99
Scene Bulk Dump Transmit Switch	SCENE BULK TX SW	Off, On
EZ Routing User Template Bulk Transmit Target	EZR Usr Tmplt BULK Tx Target	ALL , 00–19
EZ Routing User Template Bulk Dump Transmit Switch	EZR Usr Tmplt BULK TX SW	Off, On
User Effect Bulk Transmit Target	Usr FX BULK Tx Target	ALL , U000–U199
User Effect Bulk Dump Transmit Switch	Usr FX BULK TX SW	Off, On

Parameter List

Sync Parameter [SHIFT]+[F4 (UTILITY)] → [(Page1) F6 (SYNC)]

Parameter name	Display	Value, Initial value
Sync Mode	SYNC MODE	INT, EXT
Sync with Gap	SYNC with Gap	Off, On
External Sync Source	EXT SYNC SOURCE	MIDI IN, R-BUS
Frame Rate auto select	SYNC AUTO	Off, On
Sync Offset Time	SYNC OFFSET TIME	00:00:00.00–23:59:59.99(*)
Frame Rate	FRAME RATE	30, 29N, 29D, 25, 24
Error Level	ERROR LEVEL	0–5–10
MIDI OUT Sync Generator	MIDI OUT SYNC Gen.	Off, MTC, MIDIClk, SyncTr
R-BUS OUT Sync Generator	R-BUS SYNC Gen.	Off, MTC

* The settable value for Offset will change slightly depending on the MTC type.

Tempo Map [SHIFT]+[F4 (UTILITY)] → [(Page2) F1 (TEMPO)]

Parameter name	Display	Value, Initial value
Tempo Map Number	MAP #	1–50
Beat	BEAT	1/1–16/1, 1/2–16/2, 1/4–4/4–16/4, 1/8–16/8, 1/16–16/16
Tempo	♩ =	25.0–120.0–250.0
Measure	MEASURE	1–999

Metronome Parameter [SHIFT]+[F4 (UTILITY)] → [(Page2) F2 (Metro)]

Parameter name	Display	Value, Initial value
Metronome Out	METRONOME OUT	Off, INT, MIDI
Internal Level	INT LEVEL	–∞–0.0–6.0 dB (*1)
Metronome Mode	METRONOME MODE	Rec Only, Rec & Play (*2)
Tone Type	TONE TYPE	CLICK1, CLICK2, CLICK2(NOTE), DRUM (*3)
Metronome MIDI Channel	METRONOME MIDI Ch	1–10–16 (*4)
Accent Note	ACCENT NOTE	C_0–C#2–G_9 (*4)
Accent Velocity	ACCENT VELOCITY	1–100–127 (*4)
Normal Note	NORMAL NOTE	C_0–C#2–G_9 (*4)
Normal Velocity	NORMAL VELOCITY	1–60–127 (*4)

*1 Valid when Metronome Out is "INT."

*2 Valid when Metronome Out is except "Off."

*3 When the tone type is "CLICK (NOTE)," notes in accordance with the accent note and normal note are output.

*4 Valid when Metronome Out is "MIDI."

Metronome Drum Pattern Edit**[SHIFT]+[F4 (UTILITY)] → [(Page2) F2 (Metro)] → [F1 (PtnEdt)]**

Parameter name	Display	Value, Initial value
Percussion	PERCUSSION	Hand Clap, Cowbel, Maracas
Percussion Switch	-	Off, On
Percussion Verocity	VELO	1-100-127
High Hat Switch	H.H.	○ (Off), ● (Close), ○ (Open)
High Hat Verocity	VELO	1-100-127
Snare Drum Switch	S.D.	Off, On (Initial value: odd-numbered beats are On. even-numbered beats are Off.)
Snare Drum Verocity	VELO	1-100-127
Bass Drum Switch	B.D.	Off, On (Initial value: odd-numbered beats are Off. even-numbered beats are On.)
Bass Drum Verocity	VELO	1-100-127

Auto Punch/Loop [SHIFT]+[F4 (UTILITY)] → [(Page2) F3 (A.P/LP)]

Parameter name	Display	Value, Initial value
Auto Punch In Point	IN	Unregistration, 00:00:00:00.00-23:59:59:29.99 (*)
Auto Punch Out Point	OUT	Unregistration, 00:00:00:00.00-23:59:59:29.99 (*)
Loop From Point	FROM	Unregistration, 00:00:00:00.00-23:59:59:29.99 (*)
Loop To Point	TO	Unregistration, 00:00:00:00.00-23:59:59:29.99 (*)

* The settable value for Offset will change slightly depending on the MTC type.

V.Fader [SHIFT]+[F4 (UTILITY)] → [(Page2) F6 (V.FDR)]

Parameter name	Display	Value, Initial value
V.Fader 1-12	FADER1-12	cc# 0-cc# 7-cc# 119
Tx channel	FADER1-12 Tx Ch	1-16
User Fader Assign to	USER FADER ASSIGN to	ATT, PHASE, GROUP, Ch LINK, Fader LINK, LEVEL, PAN , SOLO, MUTE, AUX1-8 Send Sw, AUX1-8 Send Lev, AUX1/2-7/8 SendPAN, InsFX1-4 Sw, InsFX1-4 SndLev, InsFX1-4 RrnLev, Surnd PAN, Surnd DEPTH, Surnd LR:C, Surnd SubWLev, Dyn Sw, Dyn Type, Cmp KeyIn, Cmp Thresh, Cmp RATIO, Cmp ATTACK, Cmp RELEASE, Cmp LEVEL, Cmp AUTOGAIN, Exp KeyIn, Exp Thresh, Exp RATIO, Exp ATTACK, Exp RELEASE, EQ Sw, EQ Low Gain, EQ Low Freq, EQ LoMid Gain, EQ LoMid Freq, EQ LoMid Q, EQ HiMid Gain, EQ HiMid Freq, EQ HiMid Q, EQ High Gain, EQ High Freq

Parameter List

Scene [SHIFT]+[F4 (UTILITY)] → [(Page3) F1 (SCENE)]

Parameter name	Display	Value, Initial value
Scene Active Channel	INPUT MIXER (1-16)	Valid, Ignore
	TRACK MIXER (1-24)	Valid, Ignore
	FX RETURN (1-4)	Valid, Ignore
	AUX MASTER (1-8)	Valid, Ignore
	DIR (1-8)	Valid, Ignore
	EFFECT (1-4)	Valid, Ignore
	MST (MST)	Valid, Ignore

Automix [SHIFT]+[F4 (UTILITY)] → [(Page3) F2 (A.MIX)]

Parameter name	Display	Value, Initial value
Writing Parameter	WRITING PARAMETER	LEVEL, PAN/Bal, EQ, MUTE, Aux Send, InsFX Lev, SURROUND (initial value is all On)
After Punch Out	AFTER PUNCH OUT	Return, Keep
Return Time	RETURN TIME	0, 100, 200, 300, 400, 500, 600, 700, 800, 900, 1000 ms
Master Block	MST	MST (Initial value is all MANUAL)
Input Mixer	INPUT MIXER(1-16)	MANUAL , WRITE, READ
Track Mixer	TRACK MIXER(1-24)	MANUAL , WRITE, READ
Effect Return Mixer	FX RETURN(1-4)	MANUAL , WRITE, READ
AUX Master	AUX MASTER(1-8)	MANUAL , WRITE, READ
Direct Path	DIR(1-8)	MANUAL , WRITE, READ
Effect Switch	FX(1-4)	MANUAL , WRITE, READ

Surround [SHIFT]+[F4 (UTILITY)] → [(Page3) F3 (Surrnd)]

Parameter name	Display	Value, Initial value
Surround Mix Switch	SURROUND MIX Sw	Off , On
Surround Mix Mode	SURROUND MIX MODE	2+2 , 3+1, 3+2+1

Oscillator/Analyzer [SHIFT]+[F4 (UTILITY)] → [(Page3) F4 (OscAna)]**Oscillator**

Parameter name	Display	Value, Initial value
Switch	Sw	Off, On
Source	SOURCE	PINK Noise, WhiteNoise, Sin Wave, METRONOME (*1)
Attenuator	ATT	-42.0--12--+0 dB (*2)
Fader	Fader	--0.0-6.0 dB
Mix Send Pan	PAN	L63-C-R63
Mix Send Switch	MIX	Off, On
AUX Send Switch	AUX (1-8)	Off, On
AUX Send Level	-	--6.0 dB
Direct Path	DIR (1-8)	Off, On

*1 Metronome is not output to monitor when "METRONOME" is selected.

*2 Valid when Source is except "METRONOME."

Analyzer

Parameter name	Display	Value, Initial value
Source	SOURCE	IN1-IN16, TR1-TR24, FX1-4 RTN L, FX1-4 RTN R, Gen/OSC, MST L, MST R, MON L, MON R, AUX1-8, DIR1-8
Average Times	AVERAGE TIMES	1-128
Average Type	AVERAGE TYPE	Off, NRM, EXP
Use Effect Board	Use EFFECT Board	Off, A, B (*1)

*1 When an effect board is being used by the analyzer, it's unavailable for other use.

Parameter Initialize [SHIFT]+[F4 (UTILITY)] → [(Page3) F6 (Prmlni)]

Parameter name	Display	Value, Initial value
Initialize Section	INITIALIZE SECTION	MIXER & UTILITY, MIXER, UTILITY

R-BUS Configuration [SHIFT]+[F4 (UTILITY)] → [(Page4) F1 (R-BUS)]

Parameter name	Display	Value, Initial value
R-BUS Remote Control	R-BUS Remote Control	Off, On

R-BUS Configuration**[SHIFT]+[F4 (UTILITY)] → [(Page4) F1 (R-BUS)] → [F1 (R-BUS)] *1**

*1 Valid when an R-BUS equipment is connected.

* The parameters appear on screen differs according to an R-BUS equipment connected to this unit.

Parameter List

RSS PAN Setup [SHIFT]+[F4 (UTILITY)] → [(Page4) F2 (RSSPan)]

Parameter name	Display	Value, Initial value
Use Effect Board	Use EFFECT Board	Off, A, B (*1)
Phones Mode	PHONES Sw	Off, On
Use Channel List	Use CHANNEL LIST	INPUT 1–INPUT16 (*2), TRACK 1–TRACK24 (*2)

*1 When an effect board is being used by the analyzer, it's unavailable for other use.

*2 If Channel Link is On, its channels will not appear in Use Channel List.

Project New [SHIFT]+[F1 (PROJECT)] → [(Page1) F2 (NEW)]

Parameter name	Display	Value, Initial value
Project Name	NAME	InitProj 000 (*)
Copy Utility Parameter	Copy Utility Prm	Off, On
Copy Mixer/Scene Parameter	Copy Mixer/Scene Prm	Off, On
Sample Rate	Sample Rate	96k, 88.2k, 64k, 48k, 44.1k , 32k
Recording Mode	Recording Mode	M24, MTP , CDR, M16, MT1, MT2, LIV, LV2

* A new number which is not designated to the projects which are already stored is allocated to 000.

Project Protect [SHIFT]+[F1 (PROJECT)] → [(Page1) F4 (PROTEC)]

Parameter name	Display	Value, Initial value
Project Protect	-	Off, On

Format Drive [SHIFT]+[F1 (PROJECT)] → [(Page4) F2 (FmtDrv)]

Parameter name	Display	Value, Initial value
Partition Size	Partition Size	500 MB, 1 GB (1000 MB), 2 GB (2000 MB), 10GB
Physical Format	Physical Format	Off(Quick), On
Surface Scan	SurfaceScan	Off, On

Clear Partition [SHIFT]+[F1 (PROJECT)] → [(Page4) F3 (ClrPrt)]

Parameter name	Display	Value, Initial value
Surface Scan	SurfaceScan	Off, On

Preset Patch List

On the VS-2400CD, you can access the range of effects listed below.

Loop: Direct Level is set to "0." Connect this Patch to the effects bus.

Insert: This Patch mixes the direct sound and effected sound. Insert it into a channel.

* The Patches using algorithm shown below cannot be selected on the EFFECT 2, 4, 6 and 8.
Reverb/Gate Reverb/Vocoder2 (19)/Voice Transformer/Mastering Tool Kit

* The Patches cannot be selected on the EFFECT 2, 4, 6 and 8, when the Algorithm shown below is used on the EFFECT 1, 3, 5 and 7.
Vocoder2 (19)/Voice Transformer/Mastering Tool Kit

* The Patches using algorithm shown below cannot be selected on the projects with 64kHz or higher sampling rate.
Reverb/Gate Reverb/Vocoder2 (19)/Voice Transformer/Mic Modeling/Speaker Modeling/Mastering Tool Kit

Same as Algorithm (36 presets)

No.	Patch Name	Algorithm	Type	Input	Comment
P000	Reverb	Reverb	Loop	Mono	(p. 46) [3 Band EQ] → [Reverb]
P001	Reverb2	Reverb2	Loop	Mono	(p. 48) [Reverb] → [Gate] → [3 Band EQ]
P002	Gate Reverb	Gate Reverb	Loop	Mono	(p. 50) [Gate Reverb] → [3 Band EQ]
P003	Delay	Delay	Loop	Mono	(p. 52) [Delay] → [3BAND EQ]
P004	StPS-Delay	Stereo Pitch Shifter Delay	Insert	Stereo	(p. 54) [Pitch Shifter] → [Delay] → [3 Band EQ]
P005	Delay RSS	Delay RSS	Insert	Mono	(p. 56) [3 Tap Delay] → [RSS]
P006	TapeEcho201	Tape Echo 201	Loop	Mono	(p. 57) [Tape Echo 201]
P007	MultiTapDly	Multi Tap Delay	Insert	Mono	(p. 58) [Multi Tap Delay] → [3 Band EQ]
P008	StDly-Chorus	Stereo Delay Chorus	Insert	Stereo	(p. 60) [Delay] → [Chorus] → [3 Band EQ]
P009	Chorus RSS	Chorus RSS	Insert	Mono	(p. 62) [Chorus] → [RSS]
P010	Space Chorus	Space Chorus	Insert	Stereo	(p. 63) [Space Chorus]
P011	St Phaser	Stereo Phaser	Insert	Stereo	(p. 64) [Phaser] → [3 Band EQ]
P012	AnalogPhaser	Analog Phaser	Insert	Stereo	(p. 66) [Analog Phaser]
P013	St Flanger	Stereo Flanger	Insert	Stereo	(p. 67) [Flanger] → [3 Band EQ]
P014	AnalogFlnger	Analog Flanger	Insert	Stereo	(p. 68) [Analog Flanger]
P015	Rotary	Rotary	Insert	Mono	(p. 69) [Noise Suppressor] → [Over Drive] → [Rotary Speaker]
P016	2ch RSS	2ch RSS	Insert	2ch	(p. 70) [RSS 3D Panner]
P017	MicModeling	Mic Modeling	Insert	2ch	(p. 72) [Mic Converter] → [Bass Cut] → [Distance] → [Limiter]
P018	GuitarMulti1	Guitar Multi 1	Insert	Mono	(p. 74) [Compressor] → [Heavy Metal] → [Noise Suppressor] → [Auto Wah] → [GAmp Mdl] → [Flanger] → [Delay]
P019	GuitarMulti2	Guitar Multi 2	Insert	Mono	(p. 74) [Compressor] → [Distortion] → [Noise Suppressor] → [Auto Wah] → [GAmp Mdl] → [Flanger] → [Delay]
P020	GuitarMulti3	Guitar Multi 3	Insert	Mono	(p. 74) [Compressor] → [OverDrive] → [Noise Suppressor] → [Auto Wah] → [GAmp Mdl] → [Flanger] → [Delay]
P021	GuitarAmpMdl	Guitar Amp Modeling	Insert	Mono	(p. 76) [Noise Suppressor] → [G-Amp] → [Speaker Modeling]
P022	Vocal Multi	Vocal Multi	Insert	Mono	(p. 78) [Noise Suppressor] → [Limiter/De-esser] → [Enhancer] → [3 Band EQ] → [Pitch Shifter] → [Delay] → [Chorus]
P023	Voice Trans	Voice Transformer	Insert	Mono	(p. 80) [Voice Transformer] → [Reverb]
P024	Vocal Cancel	Vocal Canceled	Insert	Stereo	(p. 81) [Vocal Canceled] → [3 Band EQ]
P025	Vocoder	Vocoder	Insert	Mono	(p. 83) [10 Band Vocoder] → [Chorus]
P026	Vocoder2 (19)	Vocoder2 (19)	Insert	Mono	(p. 84) [19 Band Vocoder] → [Chorus]
P027	Lo-Fi Proces	Lo-Fi Processor	Insert	Stereo	(p. 86) [Lo-Fi Processor] → [Real time Modify Filter] → [Noise Suppressor]
P028	3BndIsolator	3band Isolator	Insert	Stereo	(p. 87) [3 Band Isolator]
P029	DualComp/Lim	Dual Compressor/Limiter	Insert	2ch	(p. 88) [Compressor/Limiter] → [Noise Suppressor]
P030	ParametricEQ	Parametric Equalizer	Insert	2ch	(p. 90) [4 Band EQ]
P031	Graphic EQ	Graphic Equalizer	Insert	2ch	(p. 91) [10 Band EQ]
P032	Hum Canceler	Hum Canceler	Insert	Stereo	(p. 92) [Hum Canceler] → [Noise Suppressor]
P033	Stereo Multi	Stereo Multi	Insert	Stereo	(p. 93) [Noise Suppressor] → [Compressor/Limiter] → [Enhancer] → [3 Band EQ]
P034	Speaker Mdl	Speaker Modeling	Insert	Stereo	(p. 95) [SP Modeling] → [Bass Cut Freq] → [Lo Freq Trim] → [Hi Freq Trim] → [Limiter]
P035	MastringTool	Mastering Tool Kit	insert	Stereo	(p. 97) [4 Band EQ] → [Bass Cut] → [Enhancer] → [3 Band Expander] → [3 Band Compressor] → [Mixer] → [Limiter] → [Soft Clip]

Presets Patch List

■ Reverb (18 presets)

No.	Patch Name	Algorithm	Type	Input	Comment
P036	RV:LargeHall	Reverb	Loop	Mono	Large concert hall reverberation.
P037	RV:SmallHall	Reverb	Loop	Mono	Small hall reverberation.
P038	RV:Strings	Reverb	Loop	Mono	Reverberation optimized for delicate highs of strings.
P039	RV:PianoHall	Reverb	Loop	Mono	Rich and warm reverberation optimized for pianos.
P040	RV:Orch Room	Reverb	Loop	Mono	Reverberation of large-capacity rooms such as big banquet halls.
P041	RV:VocalRoom	Reverb	Loop	Mono	Room reverb suitable for vocals and chorus.
P042	RV:MediumRm	Reverb	Loop	Mono	Warm and naturally spacious room reverb.
P043	RV:LargeRoom	Reverb	Loop	Mono	Modeled acoustics of wide rooms with lots of reverberation.
P044	RV:CoolPlate	Reverb	Loop	Mono	Distinctive bright plate reverb.
P045	RV:Short Plt	Reverb	Loop	Mono	Shorter plate reverb.
P046	RV:Vocal Plt	Reverb	Loop	Mono	Crystal-clear reverb optimized for vocals.
P047	RV:Soft Amb.	Reverb	Loop	Mono	Modeled reverberation of a room with minimal wall reflections.
P048	RV:Room Amb.	Reverb	Loop	Mono	Natural reverberation of rooms with good acoustics, suitable for drums and guitars.
P049	RV:Cathedral	Reverb	Loop	Mono	Acoustics of a very large, high-ceilinged church.
P050	RV:Long Cave	Reverb	Loop	Mono	Modeled reverberation of deep caves.
P051	RV:GarageDr.	Reverb	Loop	Mono	Natural reverb that enhances unique drum sounds.
P052	RV:Rock Kick	Reverb	Loop	Mono	Reverb with many low-frequency components, suitable for rock kicks.
P053	RV:RockSnare	Reverb	Loop	Mono	Rich and thick sounding reverb suitable for rock snares.

■ Reverb2 (20 presets)

* "Reverb" and "Reverb2" use different algorithms with different sound characters.

No.	Patch Name	Algorithm	Type	Input	Comment
P054	R2:LargeHall	Reverb2	Loop	Mono	Large concert hall reverberation.
P055	R2:SmallHall	Reverb2	Loop	Mono	Small hall reverberation.
P056	R2:Strings	Reverb2	Loop	Mono	Reverberation optimized for delicate highs of strings.
P057	R2:PianoHall	Reverb2	Loop	Mono	Rich and warm reverberation optimized for pianos.
P058	R2:Orch Room	Reverb2	Loop	Mono	Reverberation of large-capacity rooms such as big banquet halls.
P059	R2:VocalRoom	Reverb2	Loop	Mono	Room reverb suitable for vocals and chorus.
P060	R2:MediumRm	Reverb2	Loop	Mono	Warm and naturally spacious room reverb.
P061	R2:LargeRoom	Reverb2	Loop	Mono	Modeled acoustics of wide rooms with lots of reverberation.
P062	R2:CoolPlate	Reverb2	Loop	Mono	Distinctive bright plate reverb.
P063	R2:Short Plt	Reverb2	Loop	Mono	Shorter plate reverb.
P064	R2:Vocal Plt	Reverb2	Loop	Mono	Crystal-clear reverb optimized for vocals.
P065	R2:Soft Amb.	Reverb2	Loop	Mono	Modeled reverberation of a room with minimal wall reflections.
P066	R2:Room Amb.	Reverb2	Loop	Mono	Natural reverberation of rooms with good acoustics, suitable for drums and guitars.
P067	R2:Cathedral	Reverb2	Loop	Mono	Acoustics of a very large, high-ceilinged church.
P068	R2:Long Cave	Reverb2	Loop	Mono	Modeled reverberation of deep caves.
P069	R2:GarageDr.	Reverb2	Loop	Mono	Natural reverb that enhances unique drum sounds.
P070	R2:Rock Kick	Reverb2	Loop	Mono	Reverb with many low-frequency components, suitable for rock kicks.
P071	R2:RockSnare	Reverb2	Loop	Mono	Rich and thick sounding reverb suitable for rock snares.
P072	R2:BriteGte2	Reverb2	Loop	Mono	A high-density and bright sounding gated reverb. Adjust Threshold.
P073	R2:Fat Gate2	Reverb2	Loop	Mono	A high-density and warm sounding gated reverb. Adjust Threshold.

■ Gate Reverb (4 presets)

No.	Patch Name	Algorithm	Type	Input	Comment
P074	RV:BriteGate	Gate Reverb	Loop	Mono	Slightly brighter gate reverb.
P075	RV:Fat Gate	Gate Reverb	Loop	Mono	Dynamic reverb sound with powerful mids and lows.
P076	RV:ReverseGt	Gate Reverb	Loop	Mono	A reverse gate commonly used as a special effect.
P077	RV:PanningGt	Gate Reverb	Loop	Mono	A special effect with gate reverb shifting from left to right.

■ Delay (9 presets)

No.	Patch Name	Algorithm	Type	Input	Comment
P078	DL:Short Dly	Delay	Loop	Mono	An ambience effect that adds depth to the sound by doubling.
P079	DL:MediumDly	Delay	Loop	Mono	Natural echo optimized for vocals.
P080	DL:LongDelay	Delay	Loop	Mono	Long delay suited for brass and analog synth solos.
P081	DL:AnalogDly	Delay	Loop	Mono	Analog sound with gradually diminishing feedbacking highs.
P082	DL:Tape Echo	Stereo Delay Chorus	Loop	Stereo	Modeled tape echo with distinctive wow flutter.
P083	DL:Karaoke	Stereo Delay Chorus	Loop	Stereo	Intense reverberation that effectively enhances karaoke vocals.
P084	DL:Multi-Tap	Stereo Delay Chorus	Loop	Stereo	Spacious reflections using positioning delay at any point along the stereo soundfield.
P085	DL:MitTapAmb	Multi Tap Delay	Loop	Mono	An ambience effect using 10 short delay units.
P086	DL:Ping Pong	Multi Tap Delay	Loop	Mono	A special effect using tap delay.

■ Tape Echo 201 (4 presets)

No.	Patch Name	Algorithm	Type	Input	Comment
P087	TE:ShortEcho	Tape Echo 201	Loop	Mono	Models short type tape echo.
P088	TE:LongEcho	Tape Echo 201	Loop	Mono	Models long type tape echo.
P089	TE:OldTape	Tape Echo 201	Loop	Mono	Models tape echo using an old tape.
P090	TE:PanEcho	Tape Echo 201	Loop	Mono	Models tape echo in stereo.

■ Chorus (6 presets)

No.	Patch Name	Algorithm	Type	Input	Comment
P091	CH:Lt Chorus	Stereo Delay Chorus	Insert	Stereo	Natural stereo chorus with shallow depth for spacious, crystal-clear sound.
P092	CH:Deep Cho	Stereo Delay Chorus	Insert	Stereo	Intense stereo chorus that adds depth and spaciousness to the sound.
P093	CH:DetuneCho	Stereo Pitch Shifter Delay	Insert	Stereo	Chorus with left and right channels separately pitch shift-detuned up and down.
P094	SPCHO:MODE 1	Space Chorus	Insert	Stereo	Models MODE1 of the classic SDD-320 ambience processor.
P095	SPCHO:MODE 2	Space Chorus	Insert	Stereo	Models MODE2 of the classic SDD-320 ambience processor.
P096	SPCHO:MODE 3	Space Chorus	Insert	Stereo	Models MODE3 of the classic SDD-320 ambience processor.

■ Phaser (3 presets)

No.	Patch Name	Algorithm	Type	Input	Comment
P097	PH:Lt Phaser	Stereo Phaser	Insert	Stereo	Lighter 4-stage stereo phaser suitable for synth strings.
P098	PH:DeepPhase	Stereo Phaser	Insert	Stereo	Deep phaser effective for electronic piano and clavinet sounds.
P099	AP:FB-Phaser	Analog Phaser	Insert	Stereo	Models analog phaser with oscillation on purpose.

■ Flanger (3 presets)

No.	Patch Name	Algorithm	Type	Input	Comment
P100	FL:LtFlanger	Stereo Flanger	Insert	Stereo	Stereo flanger with slight modulation.
P101	FL:Deep Fl	Stereo Flanger	Insert	Stereo	Deeper stereo flanger for metallic jet swooshing sound.
P102	AF:SBF-325	Analog Flanger	Insert	Stereo	Models Roland SBF-325 analog flanger.

■ Pitch Shifter (7 presets)

No.	Patch Name	Algorithm	Type	Input	Comment
P103	PS:4thVoice	Vocal Multi	Insert	Mono	Adds sound down a fourth to the direct sound.
P104	PS:ShimmerUD	Stereo Pitch Shifter Delay	Insert	Stereo	A special effect with left channel pitch rising and right channel pitch dropping over time.
P105	VT:M to Fm	Voice Transformer	Insert	Mono	Converts a male voice into a female voice.
P106	VT:Fm to M	Voice Transformer	Insert	Mono	Converts a female voice into a male voice.
P107	VT:Male Duo	Voice Transformer	Insert	Mono	Turns a single male voice into a duet (by adding a female voice).
P108	VT:FemaleDuo	Voice Transformer	Insert	Mono	Turns a single female voice into a duet (by adding a male voice).
P109	VT:Robot	Voice Transformer	Insert	Mono	Special effect like a robot speaking.

* PSD = Pitch Shifter Delay

■ Mic Modeling (29 presets)

No.	Patch Name	Algorithm	Type	Input	Comment
P110	MM:57→58	Mic Modeling	Insert	2ch	Converts a general-purpose D. mic to a vocal D. mic. Rich mid/low range.
P111	MM:57→421	Mic Modeling	Insert	2ch	Converts a general-purpose D. mic to a large D. mic. For drums and guitar amp.
P112	MM:57→451	Mic Modeling	Insert	2ch	Converts a general-purpose D. mic to a small C. mic. For acoustic guitar and cymbals.
P113	MM:57→87	Mic Modeling	Insert	2ch	Converts a general-purpose D. mic to a large C. mic. For vocals and acoustic inst.
P114	MM:57→47	Mic Modeling	Insert	2ch	Converts a general-purpose D. mic to a vintage C. mic. For vocals and acoustic inst.
P115	MM:57→Line	Mic Modeling	Insert	2ch	Cancels the characteristics of D.mic, giving the sound a flat frequency response.
P116	MM:DR20→421	Mic Modeling	Insert	2ch	Converts a Roland DR-20 to an instrumental D. mic. For drums and guitar amp.
P117	MM:DR20→451	Mic Modeling	Insert	2ch	Converts a Roland DR-20 to a small C. mic. For acoustic guitar and cymbals.
P118	MM:DR20→87	Mic Modeling	Insert	2ch	Converts a Roland DR-20 to a large C. mic. For vocals and acoustic inst.
P119	MM:10→58	Mic Modeling	Insert	2ch	Converts a headset mic to a vocal D. mic.
P120	MM:10→87	Mic Modeling	Insert	2ch	Converts a headset mic to a large C. mic.
P121	MM:Mini→57	Mic Modeling	Insert	2ch	Converts a miniature C. mic to a general-purpose D. mic.
P122	MM:Mini→87	Mic Modeling	Insert	2ch	Converts a miniature C. mic to a large C. mic.
P123	MM:C3KB→57	Mic Modeling	Insert	2ch	Converts a AKG C3000B to a general-purpose D. mic
P124	MM:C3KB→58	Mic Modeling	Insert	2ch	Converts a AKG C3000B to a vocal D. mic.
P125	MM:C3KB→421	Mic Modeling	Insert	2ch	Converts a AKG C3000B to an instrumental D. mic.
P126	MM:C3KB→451	Mic Modeling	Insert	2ch	Converts a AKG C3000B to a small C. mic.
P127	MM:C3KB→87	Mic Modeling	Insert	2ch	Converts a AKG C3000B to a large C. mic.
P128	MM:C3KB→47	Mic Modeling	Insert	2ch	Converts a AKG C3000B to a vintage C. mic.

Presets Patch List

P129	MM:C3KB→Line	Mic Modeling	Insert	2ch	Cancels the characteristics of AKG C3000B, giving the sound a flat frequency response.
P130	MM:Kick&Snr1	Mic Modeling	Insert	2ch	For the bass drum (L channel) and snare drum (R channel) of a drum set (1).
P131	MM:Kick&Snr2	Mic Modeling	Insert	2ch	For the bass drum (L channel) and snare drum (R channel) of a drum set (2).
P132	MM:H.Hat&Tom	Mic Modeling	Insert	2ch	For the hi-hat (L channel) and tom (R channel) of a drum set.
P133	MM:Dr.OvrTop	Mic Modeling	Insert	2ch	A patch for placing mics above the drums mainly to mic the cymbals.
P134	MM:Dr.OvrAll	Mic Modeling	Insert	2ch	A patch for placing mics above the front of the drums to mic the entire set.
P135	MM:Ac.Guitar	Mic Modeling	Insert	2ch	For acoustic guitar. InsertL: brighter, InsertR: warmer.
P136	MM:StudioVcl	Mic Modeling	Insert	2ch	For vocals. InsertL: natural, InsertR: Rock.
P137	MM:StereoMic	Mic Modeling	Insert	2ch	Gives time-lag to a sound miked in stereo, emphasizing spaciousness.
P138	MM:Ambience	Mic Modeling	Insert	2ch	Models ambience mics. Add reverb and mix with original source.

* D. mic = dynamic microphone, C. mic = condenser microphone

■ Vocal (10 presets)

No.	Patch Name	Algorithm	Type	Input	Comment
P139	VO:Vocal Fx	Vocal Multi	Insert	Mono	Basic setup for recording/mixdown of vocals.
P140	VO:JazzVocal	Vocal Multi	Insert	Mono	A natural sounding jazz club-like ambience for warm reverb well-suited for vocals.
P141	VO:RockVocal	Vocal Multi	Insert	Mono	Sound featuring limiter/enhancer processing as well as a unison effect.
P142	VO:Narration	Vocal Multi	Insert	Mono	An effect with heavy compression, used for narration.
P143	VO:BigChorus	Vocal Multi	Insert	Mono	A spacious-sounding stereo effect similar to increasing the number of vocalists.
P144	VO:Club DJ	Vocal Multi	Insert	Mono	A club DJ-tailored effect that uses a pitch shifter to make voices lower.
P145	VO:AM-Radio	Vocal Multi	Insert	Mono	Sound featuring hard compression and narrower frequency range.
P146	VO:PlusTwo	Stereo Pitch Shifter Delay	Insert	Stereo	A special effect that adds two more voices using a pitch shifter.
P147	VO:Robot Fx	Stereo Pitch Shifter Delay	Insert	Stereo	SF movie-like effect using a pitch shifter.
P148	VO:Bull Horn	Guitar Multi 3	Insert	Mono	Modeled effect of sound produced from a Bull Horn or old radio.

* PSD = Pitch Shifter Delay

■ Guitar (11 presets)

No.	Patch Name	Algorithm	Type	Input	Comment
P149	GT:Rock Lead	Guitar Multi 2	Insert	Mono	Straight distortion sound with delay.
P150	GT:LA Lead	Guitar Multi 2	Insert	Mono	Lead guitar sound with tasty compression and chorus applied.
P151	GT:MetalLead	Guitar Multi 1	Insert	Mono	Metal sound with dynamic, ultrahigh gain distortion.
P152	GT:Metal Jet	Guitar Multi 1	Insert	Mono	Distortion together with a metallic effect achieved by flanging.
P153	GT:CleanRthm	Guitar Multi 1	Insert	Mono	Clean sound with compression and chorus applied.
P154	GT:DledClean	Vocal Multi	Insert	Mono	Superclean sound like line recording directly into the console.
P155	GT:Delay Rif	Guitar Multi 2	Insert	Mono	Delay sounds at dotted eighth note intervals when a 120 BPM riff is played.
P156	GT:Acoustic	Vocal Multi	Insert	Mono	Optimized for electroacoustic guitars.
P157	GT:BluesDrv.	Guitar Multi 3	Insert	Mono	Crunchy overdrive sound suited to blues and R&R.
P158	GT:Liverpool	Guitar Multi 3	Insert	Mono	Crunchy sound often heard on '60s British rock.
P159	GT:Country	Guitar Multi 3	Insert	Mono	Clean sound featuring distinctive compression and delay.

■ Guitar Amp Modeling (9 presets)

No.	Patch Name	Algorithm	Type	Input	Comment
P160	GA:JazChorus	Guitar Amp Modeling	Insert	Mono	Roland JC-120 amp. Sounds more authentic when used with chorus for mixdown.
P161	GA:CleanTwin	Guitar Amp Modeling	Insert	Mono	U.S. tube combo amp circa "black panel."
P162	GA:Vin.Tweed	Guitar Amp Modeling	Insert	Mono	'50s U.S. tube amp overdrive.
P163	GA:BluesDrv.	Guitar Amp Modeling	Insert	Mono	Old British amp crunchy overdrive.
P164	GA:MatchLead	Guitar Amp Modeling	Insert	Mono	Hot-rodded British combo amp.
P165	GA:StudioCmb	Guitar Amp Modeling	Insert	Mono	Favorite late '70s amp of studio musicians.
P166	GA:JMP-Stack	Guitar Amp Modeling	Insert	Mono	Late '60s British stacks.
P167	GA:SLDN Lead	Guitar Amp Modeling	Insert	Mono	An '80s amp known for versatile distortion.
P168	GA:5150 Lead	Guitar Amp Modeling	Insert	Mono	Big tube amp standard for American heavy metal.

* Mdl. = Modeling

■ Bass (6 presets)

No.	Patch Name	Algorithm	Type	Input	Comment
P169	BS:DI'edBass	Vocal Multi	Insert	Mono	Slight limiting and equalization optimized, ideal for line recording applications.
P170	BS:MikedBass	Guitar Amp Modeling	Insert	Mono	A miked speaker box with four 12" s.
P171	BS:CompBass	Stereo Multi	Insert	Stereo	Hard-compressed sound optimized for slaps.
P172	BS:Fat Bass	Mastering Tool Kit	Insert	Stereo	Enhanced low end. Edit LoMid EQ to suit the source instruments.
P173	BS:Auto Wah	Guitar Multi 2	Insert	Mono	Synth bass like sound added with auto wah essential for '70s funk.
P174	BS:FX Bass	Stereo Delay Chorus	Insert	Stereo	Solo-optimized sound with depth and spaciousness added through delay and chorus.

* Mdl. = Modeling

Special Effects (11 presets)

No.	Patch Name	Algorithm	Type	Input	Comment
P175	LFP:BreakBts	Lo-Fi Processor	Insert	Stereo	Reproduces the tonal change produced by lowering the bit/rate of a sampled sound.
P176	LFP:1bitDist	Lo-Fi Processor	Insert	Stereo	Extreme distortion sound produced by lowering the number of bits.
P177	LFP:TeknoFlt	Lo-Fi Processor	Insert	Stereo	Emphasizes the out-of-band noise that occurs with low sampling rates.
P178	LFP:Reso Flt	Lo-Fi Processor	Insert	Stereo	Filter with resonance as found on synthesizers. Adjust CutOff.
P179	LFP:FatBotom	Lo-Fi Processor	Loop	Stereo	Add heavy low-range for the groove. Mix with original source.
P180	VOP22:M19Band	Vocoder2 (19)	Insert	Mono	Clear and crisp vocoder.
P181	VOP22:S19Band	Vocoder2 (19)	Insert	Mono	Special stereo vocoder with long decay.
P182	HC:Quiet60Hz	Hum Canceler	Insert	Stereo	Cancels 60 Hz hum noise.
P183	HC:Quiet50Hz	Hum Canceler	Insert	Stereo	Cancels 50 Hz hum noise.
P184	VC:Vocal Cnl	Vocal Canceler	Insert	Stereo	Cancels a vocal located in the center.
P185	VC:CenterCnl	Vocal Canceler	Insert	Stereo	Cancel all sound located in the center.

Parametric Equalizer (26 presets)

No.	Patch Name	Algorithm	Type	Input	Comment
P186	PEQ:BassDrum	Parametric Equalizer	Insert	Stereo	For bass drum. Adjust LowQ and HiG.
P187	PEQ:RockBD	Parametric Equalizer	Insert	Stereo	For bass drum. A sound suitable for rock with mid-lows emphasized.
P188	PEQ:RockSD	Parametric Equalizer	Insert	Stereo	For snare drum. Drops the mid-lows and emphasizes the attack and snares.
P189	PEQ:RimShot	Parametric Equalizer	Insert	Stereo	For rim shot. Emphasizes the feeling of attack unique to a rim shot.
P190	PEQ:Toms	Parametric Equalizer	Insert	Stereo	For toms. Adjust LowF and LowMidF.
P191	PEQ:Hi Hat	Parametric Equalizer	Insert	Stereo	For the crisper hi-hat. Adjust bell sound with HiMidG.
P192	PEQ:Cymbals	Parametric Equalizer	Insert	Stereo	For cymbals. Emphasizes the difference in tone between cymbals and their clarity.
P193	PEQ:Overhead	Parametric Equalizer	Insert	Stereo	For drum kit. Use when miking the sound of the entire kit.
P194	PEQ:Bass 1	Parametric Equalizer	Insert	Stereo	For electric bass. Wide-range and tight bass sound.
P195	PEQ:Bass 2	Parametric Equalizer	Insert	Stereo	For electric bass. Fatter and with more punch than P194. For rock.
P196	PEQ:SlapBass	Parametric Equalizer	Insert	Stereo	For electric bass. Settings that emphasize the accent of pulled notes with slap technique.
P197	PEQ:Sax	Parametric Equalizer	Insert	Stereo	For alto/soprano sax. Lower HiG for mellow sound.
P198	PEQ:Bari.Sax	Parametric Equalizer	Insert	Stereo	For baritone sax. Adjust LoMidF.
P199	PEQ:ElecGtr	Parametric Equalizer	Insert	Stereo	Settings that keep the lead guitar from being buried in the mix.
P200	PEQ:NylonGtr	Parametric Equalizer	Insert	Stereo	Emphasize the tone of nylon strings. Adjust fret sound with HiG.
P201	PEQ:BluesGtr	Parametric Equalizer	Insert	Stereo	Adds a delicate nuance suitable when playing blues on an acoustic guitar.
P202	PEQ:SlideGtr	Parametric Equalizer	Insert	Stereo	Adds a rich feel to acoustic slide guitar. Adjust HiF.
P203	PEQ:LineGtr	Parametric Equalizer	Insert	Stereo	For piezo pickups. Adjust brightness with HiG.
P204	PEQ:Male	Parametric Equalizer	Insert	Stereo	Improves the tone quality of a male vocal. Adjust HiG.
P205	PEQ:RockMale	Parametric Equalizer	Insert	Stereo	Equalizer that adds energy to a male vocal. Best for rock. Try with Comp.
P206	PEQ:Female	Parametric Equalizer	Insert	Stereo	Improves the tone quality of a female vocal. Adjust LoMidG.
P207	PEQ:RockFeml	Parametric Equalizer	Insert	Stereo	Equalizer that adds energy to a female vocal. Best for rock. Try with Comp.
P208	PEQ:Narrator	Parametric Equalizer	Insert	Stereo	Standard equalizer for male narration. Brings out the character of the voice.
P209	PEQ:Organ	Parametric Equalizer	Insert	Stereo	Settings to bring out the character of a church organ.
P210	PEQ:St.Piano	Parametric Equalizer	Insert	Stereo	For miking piano in stereo. Left: low range, right: high range.
P211	PEQ:SmallCho	Parametric Equalizer	Insert	Stereo	Settings that bring out the chorus without letting it conflict with the main vocal.

Graphic Equalizer (3 presets)

No.	Patch Name	Algorithm	Type	Input	Comment
P212	GEQ:TotalEQ1	Graphic Equalizer	Insert	Stereo	Boosts the low and high ranges.
P213	GEQ:TotalEQ2	Graphic Equalizer	Insert	Stereo	Attenuates the lows and highs to narrow the range, tightening up the sound.
P214	GEQ:Space EQ	Graphic Equalizer	Insert	Stereo	Special settings that turn a monaural source into stereo.

Stereo Multi (5 presets)

No.	Patch Name	Algorithm	Type	Input	Comment
P215	CL:Comp	Stereo Multi	Insert	Stereo	Stereo type compression optimized for broadcast mixing.
P216	CL:Limiter	Stereo Multi	Insert	Stereo	A convenient effect for analog mastering because it can limit peak signals.
P217	EQ:Loudness	Stereo Multi	Insert	Stereo	Applies EQ curve with slightly boosted lows and highs.
P218	EQ:Fat Dance	Stereo Multi	Insert	Stereo	Hard compression plus equalizing for dance music.
P219	EQ:ThinJingl	Stereo Multi	Insert	Stereo	Limiter and EQ processing for FM radio and TV broadcasting.

Preset Patch List

■ Speaker Modeling (11 presets)

No.	Patch Name	Algorithm	Type	Input	Comment
P220	SPM:SuperFlt	Speaker Modeling	Insert	Stereo	Modeling is used to compensate the DS-90, to produce an even flatter sound with a wider range.
P221	SPM:P.GenBlk	Speaker Modeling	Insert	Stereo	A widely used model of powered monitors (two-way type, with a woofer diameter of 170 mm (6-1/2 inches)).
P222	SPM:P.E-Bs	Speaker Modeling	Insert	Stereo	Powered monitors characterized by a bright tone.
P223	SPM:P.Mack	Speaker Modeling	Insert	Stereo	Powered monitors characterized by an extended low-frequency response.
P224	SPM:SmalCube	Speaker Modeling	Insert	Stereo	Small full-range speakers widely used in recording studios.
P225	SPM:WhiteCon	Speaker Modeling	Insert	Stereo	Sealed enclosure two-way speakers known for their white woofers and widely used in recording studios.
P226	SPM:W.C+tiss	Speaker Modeling	Insert	Stereo	A more mild sound, with tissue paper affixed over the tweeters of the above "White Cone" speakers.
P227	SPM:S.Radio	Speaker Modeling	Insert	Stereo	Small pocket-type radio.
P228	SPM:SmallTV	Speaker Modeling	Insert	Stereo	Speakers built into a 14 inch size television.
P229	SPM:BoomBox	Speaker Modeling	Insert	Stereo	Radio cassette recorder.
P230	SPM:BB.LowBs	Speaker Modeling	Insert	Stereo	Radio cassette recorder with the Low Boost switched on.

■ Mastering Tool Kit (19 presets)

No.	Patch Name	Algorithm	Type	Input	Comment
P231	MTK:Mixdown	Mastering Tool Kit	Insert	Stereo	Mix down for CD
P232	MTK:PreMastr	Mastering Tool Kit	Insert	Stereo	Pre-master for video editing
P233	MTK:LiveMix	Mastering Tool Kit	Insert	Stereo	Final mix of live recording
P234	MTK:PopMix	Mastering Tool Kit	Insert	Stereo	for Pop music
P235	MTK:DanceMix	Mastering Tool Kit	Insert	Stereo	for Dance music
P236	MTK:JinglMix	Mastering Tool Kit	Insert	Stereo	Jingle for FM radio
P237	MTK:HardComp	Mastering Tool Kit	Insert	Stereo	Heavy compression
P238	MTK:SoftComp	Mastering Tool Kit	Insert	Stereo	Light compression
P239	MTK:ClnComp	Mastering Tool Kit	Insert	Stereo	Eliminating the background noise and clean up the sound
P240	MTK:DnceComp	Mastering Tool Kit	Insert	Stereo	Compression for dance music
P241	MTK:OrchComp	Mastering Tool Kit	Insert	Stereo	Compression for orchestra
P242	MTK:VocalCmp	Mastering Tool Kit	Insert	Stereo	Compression for vocal
P243	MTK:Acoustic	Mastering Tool Kit	Insert	Stereo	Acoustic guitar
P244	MTK:RockBand	Mastering Tool Kit	Insert	Stereo	for Rock band
P245	MTK:Orchestr	Mastering Tool Kit	Insert	Stereo	for Orchestra
P246	MTK:LoBoost	Mastering Tool Kit	Insert	Stereo	Enhancing the low frequency range
P247	MTK:Brighten	Mastering Tool Kit	Insert	Stereo	Enhancing the high frequency range
P248	MTK:DJsVoice	Mastering Tool Kit	Insert	Stereo	DJ Microphone
P249	MTK:PhoneVox	Mastering Tool Kit	Insert	Stereo	Telephone voice modeling

Algorithm List

This section describes the effects associated with the respective algorithms and internal terminations. Read this section when you need to check the algorithms in the built-in library (pre-set library) or before creating a new library.

- **To add reverbs (Reverb-related)**

Reverb(p. 46)
Reverb2(p. 48)
Gate Reverb(p. 50)

- **To add delayed sounds (Delay-related)**

Delay(p. 52)
Stereo Pitch Shifter Delay(p. 54)
Tape Echo 201(p. 57)
Multi Tap Delay(p. 58)

- **To expand sounds (Chorus-related)**

Stereo Delay Chorus(p. 60)
Space Chorus(p. 63)

- **To swing sounds (Modulation-related)**

Stereo Phaser(p. 64)
Analog Phaser(p. 66)
Stereo Flanger(p. 67)
Analog Flanger(p. 68)

- **To alter the volume increment (Compressor-related)**

Dual Compressor/Limiter(p. 88)

- **To increase/decrease levels by frequency band (Filter-related)**

3band Isolator(p. 87)
Parametric Equalizer(p. 90)
Graphic Equalizer(p. 91)

- **To make sound quality rough (Lo-Fi-related)**

Lo-Fi Processor(p. 86)

- **To add effects suited for the guitar/bass**

Guitar Multi 1(p. 74)
Guitar Multi 2(p. 74)
Guitar Multi 3(p. 74)
Guitar Amp Modeling(p. 76)

- **To add effects suited for vocals**

Vocal Multi(p. 78)
Voice Transformer(p. 80)
Vocal Canceler(p. 81)

- **To add movement to sounds**

Rotary(p. 69)

- **To give three-dimensional location**

Delay RSS(p. 56)
Chorus RSS(p. 62)
2ch RSS(p. 70)

- **Others**

Mic Modeling(p. 72)
Vocoder(p. 83)
Vocoder2 (19)(p. 84)
Hum Canceler(p. 92)
Stereo Multi(p. 93)
Speaker Modeling(p. 95)
Mastering Tool Kit(p. 97)

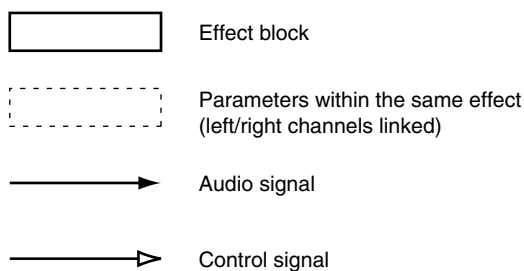

Algorithm List

((())) Reverb

This feature adds reverberation to the sound to model the size of space such as a hall and a room.

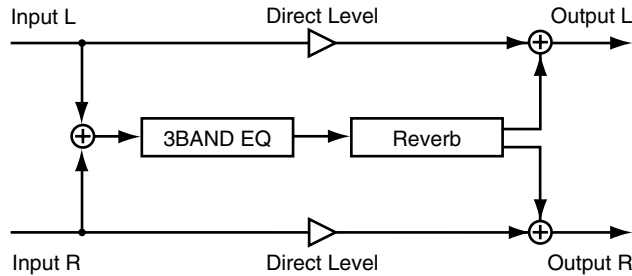

Sound types

Sounds around us can be analyzed and categorized into three types: direct sounds, early reflections and reverberation. A direct sound is the sound that reaches the listener directly from the source. An early reflection is the sound that has rebounded from the wall once, twice or several times. A reverberation is the sound we hear after sound reflections are repeated many times.

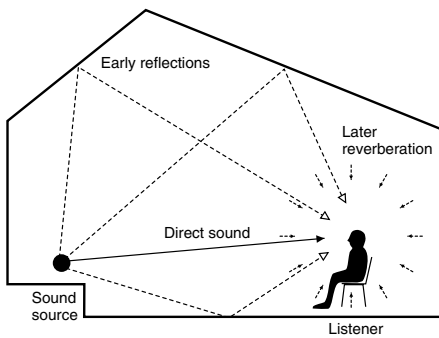

Relationship between sound and time

Reflected sound reach the listener in the following sequence. The pre-delay is the time from when the direct sound is heard until the reverb is heard. The reverb time is the time over which the reverb decays to silence.

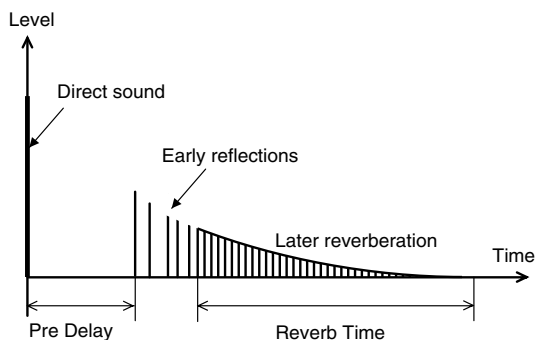

Reverb sound quality

The sound quality of a reverb is affected by materials of the walls and other members from which the sound is rebounded. This is because the degree of attenuation in the High and low frequency bands varies. HF-Damp Gain and LF-Damp Gain are provided so that you can adjust such attenuation degrees. The smaller the value becomes, the steeper the degree of attenuation of the reverberation becomes severer in the High and low frequency bands. In addition, in order to obtain softer reverberation, make the frequency lower by using HF-Damp Frequency (High Freqeq-Damp Freq). In order to obtain harder reverberation, make the frequency Higher by using LF-Damp Frequency (LoFreq-Damp Freq).

Parameter (full name)	Setting	Function
EQ (Equalizer)		
Sw (Switch)	On, Off	Turns the equalizer on or off.
Low Gain	-12– +12 dB	Sets the boost/cut amount in the low frequency band.
Low Freq (Low Frequency)	20 - 2000 Hz	Sets the center frequency in the low frequency band.
Low Q	0.3–10.0	Sets the width of the area around the low frequency that will be affected by the gain settings. *1
Low Type	Shlv, Peak	Sets the type of the low frequency band equalizer (Shelving type or peaking type).
Mid Gain (Middle Gain)	-12– +12 dB	Sets the boost/cut amount in the middle frequency band.
Mid Freq (Middle Frequency)	200–8000 Hz	Sets the center frequency in the middle frequency band.
Mid Q (Middle Q)	0.3–10.0	Sets the width of the area around the middle frequency that will be affected by the gain settings.
High Gain	-12– +12 dB	Sets the boost/cut amount in the High frequency band.
High Freq (High Frequency)	1.4–20.0 kHz	Sets the center frequency in the High frequency band.
High Q	0.3–10.0	Sets the width of the area around the High frequency that will be affected by the gain settings. *1
Hi Type (High Type)	Shlv, Peak	Sets the type of the High frequency band equalizer (Shelving type or peaking type).
Level (Output Level)	0–100	Sets the volume after passing through the equalizer.

Reverb: Adds reverberation.

Room Size (Room Size)	5–40 m	Sets the size of the room.
Time (Reverb Time)	0.1–32.0 sec.	Sets the time length of the reverb sound.
PreDLY (Pre-Delay)	0–200 ms	Sets the time until the reverb sound appears.
Difusi (Diffusion)	0–100	Sets the extent of diffusion of the early reflection sound.
Density (Density)	0–100	Sets the density of the reverb sound.
ERLvl (Early Reflection Level)	0 to100	Sets the volume of the early reflection.
LF Damp Gain (LF-Damp Gain)	-36–0 dB	Sets the degree of attenuation of the reverb in the low frequency band.
LF Damp Freq (LF-Damp Frequency)	50–4000 Hz	Sets the frequency on which the reverb starts attenuating in the low frequency band.
HF Damp Gain (HF-Damp Gain)	-36–0 dB	Sets the degree of attenuation of the reverb in the High frequency band.
HF Damp Freq (HF-Damp Frequency)	1.0–20.0 kHz	Sets the frequency on which the reverb starts attenuating in the High frequency band.
HiCF (High Cut Frequency)	0.2–20.0 kHz	Sets the frequency for which the High frequency band elements of the reverb are cut.
FX Lvl (Effect Level)	-100–100	Sets the volume of the reverb sound.
DirLvl (Direct Level)	-100–100	Sets the volume of the direct sound.



- *1: If Low Type (Lo Type) or High Type (Hi Type) is set to “Shlv (Shelving Type),” the setting for Lo Q or High Q is invalid.
- * “Reverb” cannot be used on EFFECT2 and 4 (even-numbered effects).
- * “Reverb” cannot be used on the projects with 64kHz or higher sampling rate.

Reverb2

This gate reverb works in either of two modes of gate operation (Gate/Ducking). In the Gate mode, the gate opens when a certain volume (Threshold Level) is exceeded while in the Ducking mode, the gate opens when the volume becomes as low as or lower than Threshold Level. You can use two reverbs (FX1 and FX2) with different settings, or use it in combination with a previous reverb.

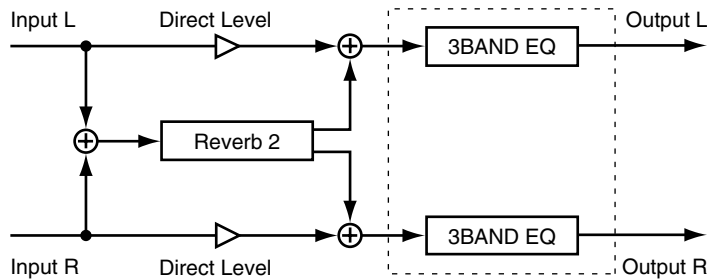

Reverb types

There are five reverb types: You can choose the type with Reverb Type.

Room1:	Ordinary room reverb
Room2:	Room reverb with a softer tone compared with Room1
Hall1:	Ordinary hall reverb
Hall2:	Hall reverb with a softer tone compared with Hall1
Plate:	Plate reverb

Selecting Gate type

Reverb sounds have different effects depending on the gate operation types. Use Gate Mode to select the type.

Gate:	The gate opens when the volume of the direct sound exceeds the value set with Threshold Level (Thres). The gate closes when the volume drops below the Threshold Level value.
Duckn:	Operates in the opposite manner as in the "Gate" mode. The gate closes when the volume of the direct sound exceeds the value set with Threshold Value. The gate opens when the volume becomes as low as or lower than the Threshold Level value.

Parameter (full name)	Setting	Function
Rev (Reverb 2): Gate reverb with two modes of gate operation		
Sw (Switch)	On, Off	Turns the reverb on or off.
Type (Reverb Type)	See the column on the previous page.	Sets the reverb type.
Gate (Gate)	On, Off	Opens or closes the gate.
Mode (Gate Mode)	Gate, Ducking	Sets the gate operation type.
Time (Reverb Time)	0.1–10.0 sec.	Sets the length (time) of the reverb sound.
PreDLY (Pre-Delay)	0–200 ms	Sets the time until the reverb sound is output.
Densty (Density)	0–100	Sets the density of the reverb sound.
HPF (High Pass Filter)	Thru, 20 - 2000 Hz	Sets the frequency at which HPF starts taking effect. Set this to “Thru” if HPF is to be disabled.
LPF (Low Pass Filter)	1.0–20.0 kHz, Thru	Sets the frequency at which LPF starts taking effect. Set this to “Thru” if LPF is to be disabled.
Thresh (Threshold)	0–100	Sets the reference volume for controlling gate operations.
Attack (Attack)	1–100	Sets the time from when the direct sound level exceeds the threshold level until when the gate is completely open.
Releas (Release)	1–100	Sets the time from when the hold time has elapsed until the sound is completely muted.
HoldT (Hold Time)	1–100	Sets the time from when the input falls below the threshold level until when the release begins.
FX Lvl (Effect Level).	0–100	Sets the volume of the reverb sound.
DirLvl (Direct Level)	0–100	Sets the volume of the direct sound.

EQ (Equalizer)

Sw (Switch)	On, Off	Turns the equalizer on or off.
Low Gain (Low Gain)	-12– +12 dB	Sets the boost/cut amount in the low frequency band.
Low Freq (Low Frequency)	20 - 2000 Hz	Sets the center frequency in the low frequency band.
Low Q	0.3–10.0	Sets the width of the area around the low frequency that will be affected by the gain settings. ¹
Low Type	Shlv, Peak	Sets the type of the low frequency band equalizer (Shlving type or peaking type).
Mid Gain (Middle Gain)	-12– +12 dB	Sets the boost/cut amount in the middle frequency band.
Mid Freq (Middle Frequency)	200–8000 Hz	Sets the center frequency in the middle frequency band.
Mid Q (Middle Q)	0.3–10.0	Sets the width of the area around the middle frequency that will be affected by the gain settings.
High Gain	-12– +12 dB	Sets the boost/cut amount in the High frequency band.
High Freq (High Frequency)	1.4–20.0 kHz	Sets the center frequency in the High frequency band.
High Q	0.3–10.0	Sets the width of the area around the High frequency that will be affected by the gain settings. ¹
Hi Type (High Type)	Shlv, Peak	Sets the type of the High frequency band equalizer (Shlving type or peaking type).
Level (Output Level)	0–100	Sets the volume after passing through the equalizer.



¹: If Low Type (Lo Type) or High Type (Hi Type) is set to “Shlv (Shlving Type),” the setting for Lo Q or High Q is invalid.



Gate Reverb

This is a reverb in which the reverberation is muted during its decay. Its reverse mode can be used in conjunction with Accent sounds to obtain sounds like from reverse play back of a tape.

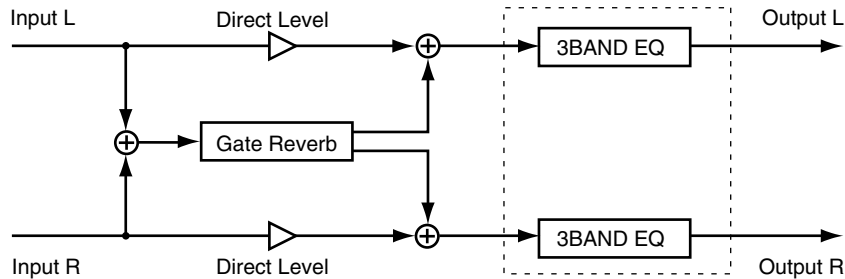

Gate Reverb

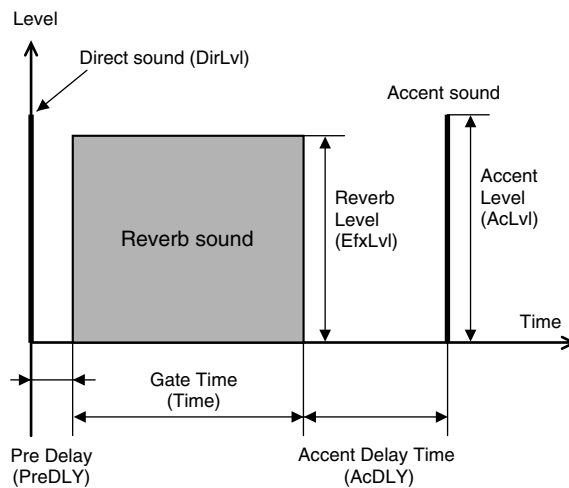

Reverb applications

You can select how reverb sounds can be applied by setting up Gate Mode (Mode).

- | | |
|-----------|--|
| Normal: | Ordinary Gate Reverb |
| L->R: | The Gate Reverb sound moves from the left to right side. |
| R->L: | The Gate Reverb sound moves from the right to left side. |
| Reverse1: | Reverse Gate (effect as if reverb are replayed backward.) |
| Reverse2: | Reverse Gate that causes the reverb sound to decay midway. |

Parameter (full name)	Setting	Function
GRev (Gate Reverb): Mutes the revert sound midway.		
Sw (Switch)	On, Off	Turns the gate reverb on or off.
Mode (Gate Mode)	See the column on the previous page.	Defines how the reverb sound is applied.
Time (Gate Time)	10–400 s	Sets the time from when the reverb sound begins until it is muted.
PreDLY (Pre-Delay)	0–300 ms	Sets the time until the reverb sound appears.
Thick (Thickness)	0–100	Sets the thickness of the reverb sound.
Density (Density)	0–100	Sets the density of the reverb sound.
AcDLY (Accent Delay Time)	0–200 ms	Sets the time from when the reverb sound is muted until the accent sound appears.
AcLvl (Accent Level)	0–100	Sets the volume of the accent sound.
AcPan (Accent Pan)	L63–R63	Sets the pan of the accent sound.
FX Lvl (Effect Level).	-100–100	Sets the volume of the gate reverb sound.
DirLvl (Direct Level)	-100–100	Sets the volume of the direct sound.

EQ (Equalizer)

Sw (Switch)	On, Off	Turns the equalizer on or off.
Low Gain (Low Gain)	-12– +12 dB	Sets the boost/cut amount in the low frequency band.
Low Freq (Low Frequency)	20 - 2000 Hz	Sets the center frequency in the low frequency band.
Low Q	0.3–10.0	Sets the width of the area around the low frequency that will be affected by the gain settings.1 *1
Low Type	Shlv, Peak	Sets the type of the low frequency band equalizer (Shlving type or peaking type).
Mid Gain (Middle Gain)	-12– +12 dB	Sets the boost/cut amount in the middle frequency band.
Mid Freq (Middle Frequency)	200–8000 Hz	Sets the center frequency in the middle frequency band.
Mid Q (Middle Q)	0.3–10.0	Sets the width of the area around the middle frequency that will be affected by the gain settings.
High Gain	-12– +12 dB	Sets the boost/cut amount in the High frequency band.
High Freq (High Frequency)	1.4–20.0 kHz	Sets the center frequency in the High frequency band.
High Q	0.3–10.0	Sets the width of the area around the High frequency that will be affected by the gain settings.1 *1
Hi Type (High Type)	Shlv, Peak	Sets the type of the High frequency band equalizer (Shlving type or peaking type).
Level (Output Level)	0–100	Sets the volume after passing through the equalizer.

NOTE

*1: If Low Type (Lo Type) or High Type (Hi Type) is set to “Shlv (Shlving Type),” the setting for Lo Q or High Q is invalid.

- * “Gate Reverb” cannot be used on EFFECT2 and 4 (even-numbered effects).
- * “Gate Reverb” cannot be used on the projects with 64kHz or higher sampling rate.

Delay

Delay is a feature to add a delayed sound to the direct sound in order to add thickness to the sound or to yield a special effect.

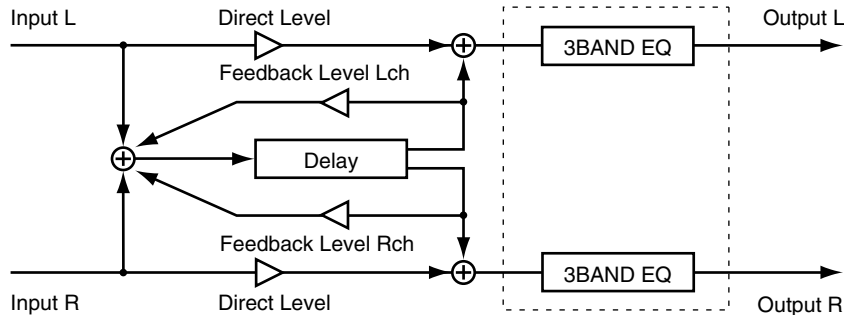

Delay sounds and the spread of sound

As a delay is output in the stereo mode, it sounds from the right and the left sides. These delay sounds can be adjusted by setting Delay shift (shift). Set it to the value on the L side to cause the left-side delay sound lag behind and to the value on the R side to cause the right-side delay sound lag behind. Set shift to "0" to make the delay sounds on the both sides simultaneously. Setting the right and left delay times to different values yields more spreading effect.

* The sum of the Delay Time value and the Delay shift value should not exceed the setting range of Delay Time. For example, if the setting range of Delay Time is 0 to 1200 ms and Delay Time is set to 1000 ms, the setting range of Delay Shift should be L200 to R200 ms.

Delay repetition

Delay feedback means to return the delay sound to the Delay input. The amount of feedback is set with FBLevel (Feedback Level). The greater this value becomes, the more times the delay sound is repeated. Setting this level to a negative value inverts the phase. Excessively large values may cause oscillation.

Parameter (full name)	Setting	Function
-----------------------	---------	----------

Delay: Adds a delayed sound to the direct sound, adding depth to the sound or creating special effects.

Sw (Switch)	On, Off	Turns the delay on or off.
Time (Delay Time)	0–1200 ms	Sets the time from direct sound until when the delay sound is heard. ^{*1}
Shift (Delay Shift)	L1200–0–R1200 ms	Sets the delay time difference between the right and left delay sounds.
Lch FeedbackLvl (Lch Feedback Level)	-100–100	Sets the amount of the left-side delay should be returned to the delay input.
Rch FeedbackLvl (Rch Feedback Level)	-100–100	Sets the amount of the right-side delay should be returned to the delay input.
LF Damp Gain (LF-Damp Gain)	-36–0 dB	Sets the degree of attenuation in the low frequency band for the delay sound fed back.
LF Damp Freq (LF-Damp Frequency)	50–4000 Hz	Sets the frequency at which attenuation in the low frequency band starts to the delay sound fed back.
HF Damp Gain (HF-Damp Gain)	-36–0 dB	Sets the degree of attenuation in the High frequency band for the delay sound fed back.
HF Damp Freq (HF-Damp Frequency)	1.0–20.0 kHz	Sets the frequency at which attenuation in the High frequency band starts to the delay sound fed back.
Lch FXLvl (Lch Effect Level)	-100–100	Sets the volume for the left-side delay sound.
Rch FXLvl (Rch Effect Level)	-100–100	Sets the volume for the right-side delay sound.
DirLvl (Direct Level)	-100–100	Sets the volume of the direct sound.

EQ (Equalizer)

Sw (Switch)	On, Off	Turns the equalizer on or off.
Low Gain (Low Gain)	-12– +12 dB	Sets the boost/cut amount in the low frequency band.
Low Freq (Low Frequency)	20 - 2000 Hz	Sets the center frequency in the low frequency band.
Low Q	0.3–10.0	Sets the width of the area around the low frequency that will be affected by the gain settings.1 *2
Low Type	Shlv, Peak	Sets the type of the low frequency band equalizer (Shlving type or peaking type).
Mid Gain (Middle Gain)	-12– +12 dB	Sets the boost/cut amount in the middle frequency band.
Mid Freq (Middle Frequency)	200–8000 Hz	Sets the center frequency in the middle frequency band.
Mid Q (Middle Q)	0.3–10.0	Sets the width of the area around the middle frequency that will be affected by the gain settings.
High Gain	-12– +12 dB	Sets the boost/cut amount in the High frequency band.
High Freq (High Frequency)	1.4–20.0 kHz	Sets the center frequency in the High frequency band.
High Q	0.3–10.0	Sets the width of the area around the High frequency that will be affected by the gain settings.1 *2
Hi Type (High Type)	Shlv, Peak	Sets the type of the High frequency band equalizer (Shlving type or peaking type).
Level (Output Level)	0–100	Sets the volume after passing through the equalizer.

NOTE

- *1: The sum of the Delay Time (Time) value and the Delay Shift (Shift) value should not exceed the setting range of Delay Time. For example, if Delay Time is set to 1000 ms, the setting range of Delay Shift is L200 to R200 ms.
- *2: If Low Type (Lo Type) or Hi Type (High Type) is set to "Shlv (Shlving Type)," the setting for Lo Q or High Q is invalid.



Stereo Pitch Shifter Delay

Changes the pitch of the direct sound. Corrects vocals out of tune or adds thickness to the sound by mixing the direct sound and a sound at a shifted pitch.

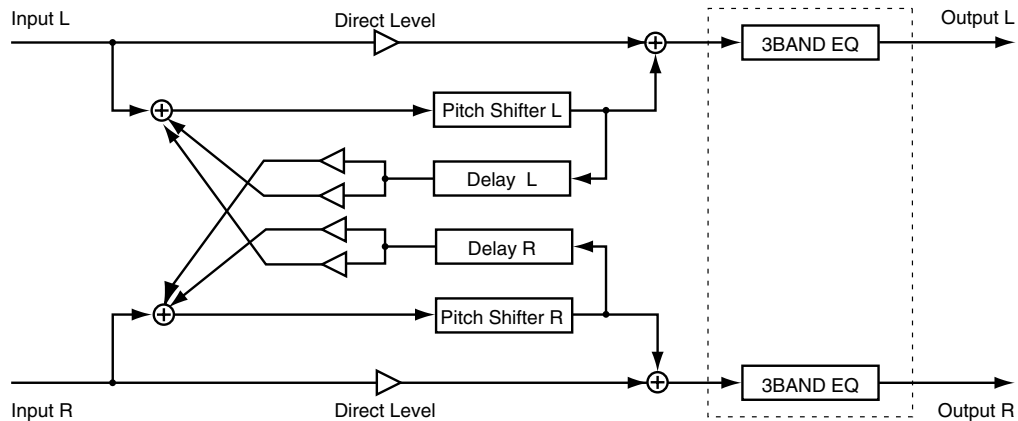

Setting up pitch

Chromatic Pitch (Chromatic) is used for major pitch variation while Fine Pitch (Fine) is used for fine adjustment. Setting up slightly different pitches for the right and left gives thickness to the sound.

Parameter (full name)	Setting	Function
PShift (Pitch Shifter Delay) : Shifts the pitch.		
Sw (Switch)	On, Off	Turns the pitch shifter on or off.
Lch Chroma Pitch (Lch Chromatic Pitch)	-12-12	Sets the left-side pitch variation (by semitone).
Rch Chroma Pitch (Rch Chromatic Pitch)	-12-12	Sets the right-side pitch variation (by semitone).
Lch Fine Pitch	-100-100	Sets the left-side pitch variation (by cent).
Rch Fine Pitch	-100-100	Sets the right-side pitch variation (by cent).
Lch PreDly (Lch Pre-Delay)	0-50 ms	Sets the time from when the direct sound is output until when the left-side sound at a shifted pitch is output.
Rch PreDly (Rch Pre-Delay)	0-50 ms	Sets the time from when the direct sound is output until when the right-side sound at a shifted pitch is output.
Lch FBDly (Lch Feedback Delay Time)	0-500 ms	Sets the feedback repetition cycle for the left-side delay sound.
Rch FBDly (Rch Feedback Delay Time)	0-500 ms	Sets the feedback repetition cycle for the right-side delay sound.
Lch FeedbackLvl (Lch Feedback Level)	-100-100	Sets the amount of the left-side sound at a shifted pitch should be returned to the left pitch shifter input.
Rch FeedbackLvl (Rch Feedback Level)	-100-100	Sets the amount of the right-side sound at a shifted pitch should be returned to the right-side pitch shifter input.
Lch CrossFeedbackLvl (Lch Cross-Feedback Level)	-100-100	Sets the amount of the left-side sound at a shifter pitch should be returned to the right-side pitch shifter input.
Rch CrossFeedbackLvl (Rch Cross-Feedback Level)	-100-100	Sets the amount of the right-side sound at a shifted pitch should be returned to the left-side pitch shifter input.
FX Lvl (Effect Level)	-100-100	Sets the volume of the sound at a shifter pitch.
DirLvl (Direct Level)	-100-100	Sets the volume of the direct sound.

EQ (Equalizer)

Sw (Switch)	On, Off	Turns the equalizer on or off.
Low Gain (Low Gain)	-12– +12 dB	Sets the boost/cut amount in the low frequency band.
Low Freq (Low Frequency)	20 - 2000 Hz	Sets the center frequency in the low frequency band.
Low Q	0.3–10.0	Sets the width of the area around the low frequency that will be affected by the gain settings.1 *1
Low Type	Shlv, Peak	Sets the type of the low frequency band equalizer (Shlving type or peaking type).
Mid Gain (Middle Gain)	-12– +12 dB	Sets the boost/cut amount in the middle frequency band.
Mid Freq (Middle Frequency)	200–8000 Hz	Sets the center frequency in the middle frequency band.
Mid Q (Middle Q)	0.3–10.0	Sets the width of the area around the middle frequency that will be affected by the gain settings.
High Gain	-12– +12 dB	Sets the boost/cut amount in the High frequency band.
High Freq (High Frequency)	1.4–20.0 kHz	Sets the center frequency in the High frequency band.
High Q	0.3–10.0	Sets the width of the area around the High frequency that will be affected by the gain settings.1 *1
Hi Type (High Type)	Shlv, Peak	Sets the type of the High frequency band equalizer (Shlving type or peaking type).
Level (Output Level)	0–100	Sets the volume after passing through the equalizer.

NOTE

*1: If Low Type (Lo Type) or High Type (Hi Type) is set to “Shlv (Shlving Type),” the setting for Lo Q or High Q is invalid.



Delay RSS

The right-side, left-side and center Delay sounds can be set separately. As RSS (p. 70) is connected to both the right and left outputs, the sound image of the sound from the left-side channel is localized at 90° to the left and that of the sound from the right-side channel at 90° to the right. The center Delay output can receive the Feedback effect.

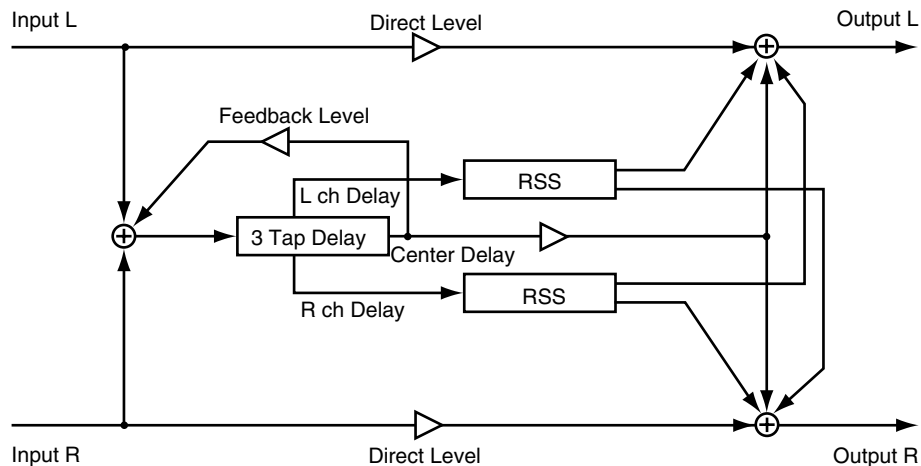

- The location is fixed; no azimuth or elevation can be specified.
- Refer to the column “Labeling on RSS product package” (p. 71).

Parameter (full name)	Setting	Function
DlyRSS (Delay RSS):	Gives three-dimensional location to Delay sounds.	
Time (Delay Time)	0–1200 ms	Sets the time from direct sound until when the left and right delay sound is heard.
shift (Delay shift)	L1200–0–R1200 ms	Sets the balance of the right and left delay times.
C.Time (Center Delay Time)	0–1200 ms	Sets the time from direct sound until when the center delay sound is heard.
RSS Lvl (RSS Level)	0–100	Sets the volume of the RSS sound.
C-Lvl (Center Level)	0–100	Sets the volume for the center delay sound.
LF Damp Gain (LF-Damp Gain)	-36–0 dB	Sets the degree of attenuation in the low frequency band for the center delay sound returned to the input.
LF Damp Freq (LF-Damp Frequency)	50–4000 Hz	Sets the frequency at which attenuation in the low frequency band starts for the center delay sound returned to the input.
HF Damp Gain (HF-Damp Gain)	-36–0 dB	Sets the degree of attenuation in the High frequency band for the center delay sound returned to the input.
HF Damp Freq (HF-Damp Frequency)	1.0–20.0 kHz	Sets the frequency at which attenuation in the High frequency band starts for the center delay sound returned to the input.
FBLvl (Feedback Level)	-100–100	Sets the amount of the center delay sound should be returned to the delay input.
FX Lvl (Effect Level)	-100–100	Sets the volume of the delay RSS sound.
DirLvl (Direct Level)	-100–100	Sets the volume of the direct sound.
Phones (Phones)	Off, On	Set to On when you use headphones Set to Off when you use speakers



*1 Refer to the column “Precautions for using RSS” (p. 71).



Tape Echo 201

Models the tape echo section of the Roland RE-201 Space Echo. Capable of reproducing very subtle behavior at the measuring instrument level as well as adding subtle changes in pitch due to deterioration of the tape or inconsistency in tape rotation



About replay head

RE-201 is equipped with three heads for creating sounds with different delay times (short, middle and long delay sounds). A desired combination of heads for use can be selected with Mode Selector (Mode).

In addition, separate panning features for the three replay heads not included in RE-201 are added.

Parameter (full name)	Setting	Function
Echo (Tape Echo 201): Models the tape echo section of the Roland RE-201 Space Echo.		
Sw (Switch)	On, Off	Turns the tape echo on or off.
Mode (Mode Selector)	1–7	Selects a combination of the three replay heads.
Repeat Rate (Repeat Rate)	0–100	Sets the tape speed.
Intnsty (Intensity)	0–100	Sets the number of repeated the delay sound.
Tone Bass (Tone Bass)	-100– +100	Sets the low frequency band tone of the tape echo sound.
Tone Treble (Tone Treble)	-100– +100	Sets the High frequency band tone of Tape Echo sound.
Pan HeadS (Pan Head S)	L63–R63	Sets the pan settings for the short delay play back head.
Pan HeadM (Pan Head M)	L63–R63	Sets the pan settings for the middle delay play back head.
Pan HeadL (Pan Head L)	L63–R63	Sets the pan settings for the long delay play back head.
Tape Dist (Tape Distortion)	0–100	Adds tape-specific distortion.
WahFlutter Rate (Wah-Flutter Rate)	0–100	Sets the fluttering rate of pitch due to deterioration of the tape or inconsistency in the rotation.
WahFlutter Depth (Wah-Flutter Depth)	0–100	Sets the fluttering depth of pitch due to deterioration of the tape or inconsistency in the rotation.
FX Lvl (Effect Level).	0–100	Sets the volume of the tape echo sound.
DirLvl(Direct Level)	0–100	Sets the volume of the direct sound.



Multi Tap Delay

This is a Delay feature that can set 10 delay sounds separately.

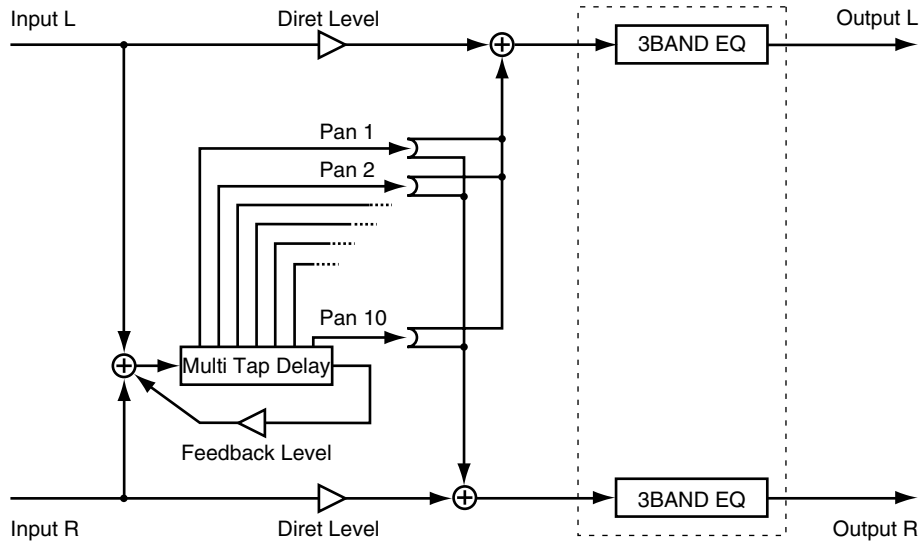

Parameter (full name)	Setting	Function
-----------------------	---------	----------

MTD (Multi-Tap Delay): Issues 10 delay sounds separately.

Time Ch1 – Ch10 (Delay Time 1 – 10)	0–1200 ms	Sets the time from the direct sound until when the delay sound for channels 1–10 is heard.
Level Ch1 – Ch10 (Delay Level 1 – 10)	0–100	Sets the volumes of delay sounds for channels 1–10.
Pan Ch1 – Ch10 (Pan 1 – 10)	L63–R63	Sets the pan of the delay sounds for channels 1–10.
FBTim (Feedback Delay Time)	0–1200 ms	Sets the repetition frequency for feedback.
FBLvl (Feedback Level)	-100–100	Sets the amount of the delay sound should be returned to the delay input.
FX Lvl (Effect Level).	-100–100	Sets the volume of the delay sound.
DirLvl (Direct Level)	-100–100	Sets the volume of the direct sound.

EQ (Equalizer)

Sw (Switch)	On, Off	Turns the equalizer on or off.
Low Gain (Low Gain)	-12– +12 dB	Sets the boost/cut amount in the low frequency band.
Low Freq (Low Frequency)	20 - 2000 Hz	Sets the center frequency in the low frequency band.
Low Q	0.3–10.0	Sets the width of the area around the low frequency that will be affected by the gain settings.1 *1
Low Type	Shlv, Peak	Sets the type of the low frequency band equalizer (Shlving type or peaking type).
Mid Gain (Middle Gain)	-12– +12 dB	Sets the boost/cut amount in the middle frequency band.
Mid Freq (Middle Frequency)	200–8000 Hz	Sets the center frequency in the middle frequency band.
Mid Q (Middle Q)	0.3–10.0	Sets the width of the area around the middle frequency that will be affected by the gain settings.
High Gain	-12– +12 dB	Sets the boost/cut amount in the High frequency band.
High Freq (High Frequency)	1.4–20.0 kHz	Sets the center frequency in the High frequency band.
High Q	0.3–10.0	Sets the width of the area around the High frequency that will be affected by the gain settings.1 *1
Hi Type (High Type)	Shlv, Peak	Sets the type of the High frequency band equalizer (Shlving type or peaking type).
Level (Output Level)	0–100	Sets the volume after passing through the equalizer.

NOTE

*1: If Low Type (Lo Type) or High Type (Hi Type) is set to “Shlv (Shlving Type),” the setting for Lo Q or High Q is invalid.



Stereo Delay Chorus

Delay and Chorus can be combined to create spaciousness.

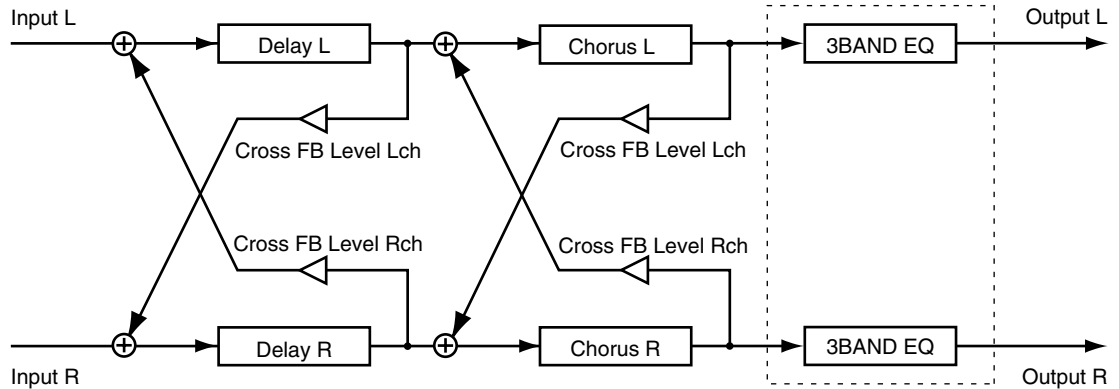

How feedback works for Delay and Chorus

Feedback is the feature to return the effect sound to its input. The amount of feedback is set with FBLevel (Feedback Level). Cross-Feedback is the feature to return the effect sound from the right input to the left input and the effect send from the left input to the right. The amount of cross-feedback is set with Cross-Feedback Level (CrossFB Level).

The greater this value becomes, the more times the delay sound is repeated. Setting this level to a negative value inverts the phase.

For feedback of chorus, the greater the value becomes, the more spaciousness and thickness is added to the sound. Setting this level to a negative value inverts the phase.

* *Excessively great values may cause oscillation, leading to abnormal noise.*

Parameter (full name)

Setting

Function

Delay: Adds a delayed sound to the direct sound, adding depth to the sound or creating special effects.

Sw (Switch)	On, Off	Turns the delay on or off.
Time (Delay Time)	0–500 ms	Sets the time from direct sound until when the delay sound is heard. ^{*1}
Shift (Delay Shift)	L500–0–R500 ms	Sets the delay time difference between the right and left delay sounds.
Lch FeedbackLvl (Lch Feedback Level)	-100–100	Sets the amount of the left-side delay should be returned to the left delay input.
Rch FeedbackLvl (Rch Feedback Level)	-100–100	Sets the amount of the right-side delay should be returned to the right delay input.
Lch CrossFeedbackLvl (Lch Cross-Feedback Level)	-100–100	Sets the amount of the left-side delay should be returned to the right delay input.
Rch CrossFeedbackLvl (Rch Cross-Feedback Level)	-100–100	Sets the amount of the right-side delay should be returned to the left delay input.
FX Lvl (Effect Level)	-100–100	Sets the volume of the delay sound.
DirLvl (Direct Level)	-100–100	Sets the volume of the direct sound.

Chorus: Adds spaciousness and depth to the sound.

Sw (Switch)	On, Off	Turns the chorus on or off.
Rate (Rate)	0.1–10.0 kHz	Sets the rate of modulation.
Depth (Depth)	0–100	Sets the depth of modulation.
PreDLY (Pre-Delay)	0–50 ms	Sets the time delay from when the direct sound begins until the processed sound is heard.
Lch FeedbackLvl (Lch Feedback Level)	-100–100	Sets the amount of the left-side chorus sound should be returned to the left chorus input.
Rch FeedbackLvl (Rch Feedback Level)	-100–100	Sets the amount of the right-side chorus sound should be returned to the right chorus input.
Lch CrossFeedbackLvl (Lch Cross-Feedback Level)	-100–100	Sets the amount of the left-side chorus sound should be returned to the right chorus input.
Rch CrossFeedbackLvl (Rch Cross-Feedback Level)	-100–100	Sets the amount of the right-side chorus sound should be returned to the left chorus input.
FX Lvl (Effect Level)	-100–100	Sets the volume of the chorus sound.
DirLvl (Direct Level)	-100–100	Sets the volume of the direct sound.

EQ (Equalizer)

Sw (Switch)	On, Off	Turns the equalizer on or off.
Low Gain (Low Gain)	-12– +12 dB	Sets the boost/cut amount in the low frequency band.
Low Freq (Low Frequency)	20 - 2000 Hz	Sets the center frequency in the low frequency band.
Low Q	0.3–10.0	Sets the width of the area around the low frequency that will be affected by the gain settings.1 *2
Low Type	Shlv, Peak	Sets the type of the low frequency band equalizer (Shlving type or peaking type).
Mid Gain (Middle Gain)	-12– +12 dB	Sets the boost/cut amount in the middle frequency band.
Mid Freq (Middle Frequency)	200–8000 Hz	Sets the center frequency in the middle frequency band.
Mid Q (Middle Q)	0.3–10.0	Sets the width of the area around the middle frequency that will be affected by the gain settings.
High Gain	-12– +12 dB	Sets the boost/cut amount in the High frequency band.
High Freq (High Frequency)	1.4–20.0 kHz	Sets the center frequency in the High frequency band.
High Q	0.3–10.0	Sets the width of the area around the High frequency that will be affected by the gain settings.1 *2
Hi Type (High Type)	Shlv, Peak	Sets the type of the High frequency band equalizer (Shlving type or peaking type).
Level (Output Level)	0–100	Sets the volume after passing through the equalizer.

NOTE

- *1: The sum of the Delay Time (Time) value and the Delay Shift (Shift) value should not exceed the setting range of Delay Time. For example, if the delay time is set to 300 ms, the setting range of Delay Shift is L200 to R200 ms.
- *2: If Lo Type (Low Type) or Hi Type (High Type) is set to “Shlv (Shlving Type),” the setting for Lo Q or High Q is invalid.



Chorus RSS

RSS (p. 70) is connected to the Chorus output. The sound image is defined with the sound from the left-side channel located at left 90° and the sound from the right-side channel at right 90°.

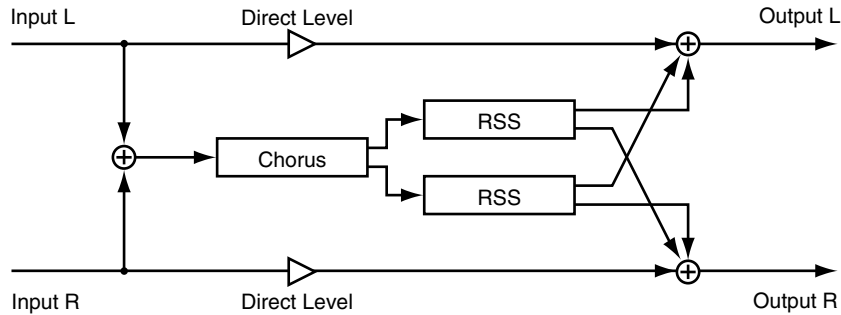

NOTE

- Location is fixed; no azimuth or elevation can be specified.
- Refer to the column “Labeling on RSS product package” (p. 71).

Parameter (full name)	Setting	Function
ChorRSS (Chorus RSS)	: Locates chorus sounds three-dimensionally.	
Rate (Chorus Rate)	0.1–10.0 Hz	Sets the rate of modulation.
Depth (Chorus Depth)	0–100	Sets the depth of modulation.
FX Lvl (Effect Level)	-100–100	Sets the volume of the chorus RSS sound.
DirLvl (Direct Level)	-100–100	Sets the volume of the direct sound.
Phones (Phones)	Off, On	Set to On when you use headphones Set to Off when you use speakers

NOTE

*1 Refer to the column “Precautions for using RSS” (p. 71).

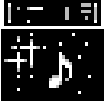

Space Chorus

This is a chorus effect simulating Roland SDD-320. The effect to be changed can be reproduced by turning the four buttons 1 to 4 on or off.

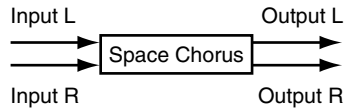

Parameter (full name)	Setting	Function
Spcho (Space Chorus):	Adds a chorus effect simulating SDD-320.	
Sw (Switch)	On, Off	Turns the space chorus on or off.
InMode (Input Mode)	Mono, Stereo	Specifies whether the input signal is stereo or mono.
Mode (Space Mode)	1, 2, 3, 4, 1+4, 2+4, 3+4	Sets the chorus variation style.
MixBal (Mix Balance)	0–100	Sets the volume balance between the chorus sound and the direct sound.



Stereo Phaser

A phaser adds a phase-shifted sound to the direct sound, producing a twisting modulation that creates spaciousness and depth.

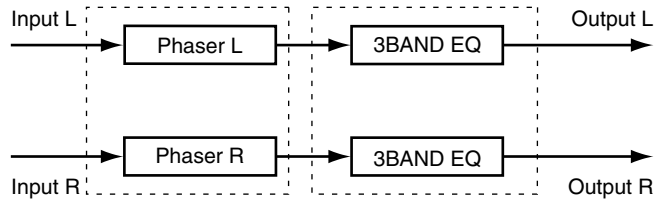

Phaser and Flanger

The effects obtained with Phaser and Flanger are very similar. Both add twisting modulation effects to the sound, creating spaciousness and depth. In other words, they create something like strongly accentuated chorus. Phaser provides a unique surge sounding like bubbles coming up. Flanger works mostly in the same mechanism as for Chorus. Besides that, it can create SE-type sounds like ascending/descending sounds of a jet.

Parameter (full name)	Setting	Function
Phs (Phaser): Adds a sound with a shifted phase to the direct sound to add spaciousness to the sound.		
Sw (Switch)	Off, On	Turns the phaser on or off.
Mode (Mode)	4, 8, 12, 16	Sets the number of stages in the phaser (p. 66).
Pol (Polarity)	Sync, Inv	Sets the right and left phases of modulation. *3
Rate (Rate)	0.1–10.0 Hz	Sets the rate at which the phaser will modulate.
Depth (Depth)	0–100	Sets the depth of modulation.
Manual (Manual)	0–100	Sets the reference frequency for adding the surging effect to the sound.
Reso (Resonance)	0–100	Enhances frequency components at around the center frequency set with Manual. *1
CrossFBLvl (Cross-Feedback Level)	0–100	Sets the amount of the phaser sound to be returned to the channel opposite to the one used for input. *2
FX Lvl (Effect Level)	-100–100	Sets the volume of the phaser sound.
DirLvl (Direct Level)	-100–100	Sets the volume of the direct sound.

EQ (Equalizer)

Sw (Switch)	On, Off	Turns the equalizer on or off.
Low Gain (Low Gain)	-12– +12 dB	Sets the boost/cut amount in the low frequency band.
Low Freq (Low Frequency)	20 - 2000 Hz	Sets the center frequency in the low frequency band.
Low Q	0.3–10.0	Sets the width of the area around the low frequency that will be affected by the gain settings.1 *4
Low Type	Shlv, Peak	Sets the type of the low frequency band equalizer (Shlving type or peaking type).
Mid Gain (Middle Gain)	-12– +12 dB	Sets the boost/cut amount in the middle frequency band.
Mid Freq (Middle Frequency)	200–8000 Hz	Sets the center frequency in the middle frequency band.
Mid Q (Middle Q)	0.3–10.0	Sets the width of the area around the middle frequency that will be affected by the gain settings.
High Gain	-12– +12 dB	Sets the boost/cut amount in the High frequency band.
High Freq (High Frequency)	1.4–20.0 kHz	Sets the center frequency in the High frequency band.
High Q	0.3–10.0	Sets the width of the area around the High frequency that will be affected by the gain settings.1 *4
Hi Type (High Type)	Shlv, Peak	Sets the type of the High frequency band equalizer (Shlving type or peaking type).
Level (Output Level)	0–100	Sets the volume after passing through the equalizer.

NOTE

- *1: An excessively great values for Resonance (Reso) may cause oscillation.
- *2: An excessively large value for Cross-Feedback level may cause oscillation.
- *3: When a mono source has been input, set “Inv” to provide spaciousness to the sound. Set “Sync” for inputting a stereo source.
- *4: If Low Type (Lo Type) or High Type (Hi Type) is set to “Shlv (Shlving Type),” the setting for Lo Q or High Q is invalid.

Algorithm List

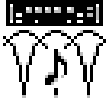

Analog Phaser

Two units of analog phasers are placed in parallel to accommodate stereo sounds. Surges unique to Phaser is created by adding sounds with the phase shifted periodically.

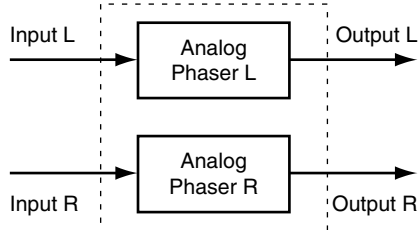

Number of stages of Phaser

As the number of stages of Phaser increases, the number of frequency points suppressed increases as well, generating sharper effect.

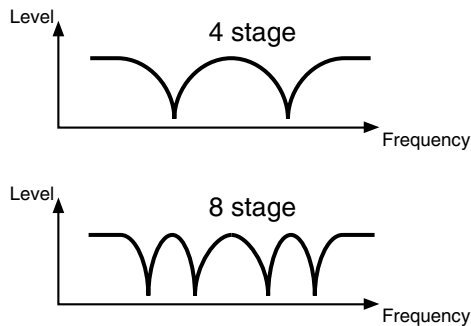

Parameter (full name)	Setting	Function
APH (Analog Phaser):	Two units of analog phaser are placed in parallel to accommodate stereo sounds.	
Sw (Switch)	On, Off	Turns the analog phaser on or off.
Mode (Mode)	8STAGE, 4STAGE	Sets the number of stages of phaser.
Freq (Frequency)	0-100	Sets the center frequency to which the phase effect is applied.
Reso (Resonance)	0-100	Enhances frequency components at around the center frequency set with Frequency.
LFO1/2 Rate (LFO1/2 Rate)	0-100	Sets the phase effect cycle length.
LFO1/2 Dep (LFO1/2 Depth)	0-100	Sets the depth of the phase effect cycle.
LFO1/2 ChB(LFO1/2 Channel B Inverse)	Nor Inv	"Inv" indicates that the surge phase should be inverted and "Nor" indicates that it should not be inverted.



Stereo Flanger

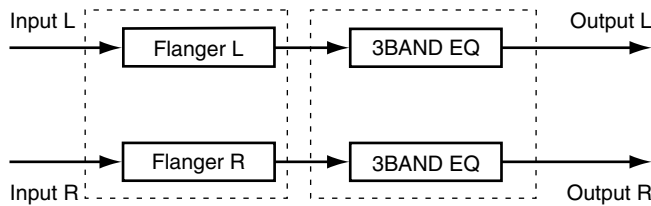

Fig (Flanger): Adds effect similar to ascending/descending sound of a jet.

Sw (Switch)	On, Off	Turns the flanger on or off.	
Pol (Polarity)	Sync, Inv	Sets the right and left phases of modulation.	*3
Rate (Rate)	0.1–10.0 Hz	Sets the rate at which the flanger is modulated.	
Depth (Depth)	0–100	Sets the depth of modulation.	
Manual (Manual)	0–100	Sets the center frequency subject to application of the Flanger effect.	
Reso (Resonance)	0–100	Enhances frequency components at around the center frequency set with Manual.	*1
CrossFBLvl (Cross-Feedback Level)	0–100	Sets the amount of the flanger sound to be returned to the channel opposite to the one used for input.	*2
FX Lvl (Effect Level).	-100–100	Sets the volume of the flanger sound.	
DirLvl (Direct Level)	-100–100	Sets the volume of the direct sound.	

EQ (Equalizer)

Sw (Switch)	On, Off	Turns the equalizer on or off.	
Low Gain (Low Gain)	-12– +12 dB	Sets the boost/cut amount in the low frequency band.	
Low Freq (Low Frequency)	20 - 2000 Hz	Sets the center frequency in the low frequency band.	
Low Q	0.3–10.0	Sets the width of the area around the low frequency that will be affected by the gain settings.1	*4
Low Type	Shlv, Peak	Sets the type of the low frequency band equalizer (Shlving type or peaking type).	
Mid Gain (Middle Gain)	-12– +12 dB	Sets the boost/cut amount in the middle frequency band.	
Mid Freq (Middle Frequency)	200–8000 Hz	Sets the center frequency in the middle frequency band.	
Mid Q (Middle Q)	0.3–10.0	Sets the width of the area around the middle frequency that will be affected by the gain settings.	
High Gain	-12– +12 dB	Sets the boost/cut amount in the High frequency band.	
High Freq (High Frequency)	1.4–20.0 kHz	Sets the center frequency in the High frequency band.	
High Q	0.3–10.0	Sets the width of the area around the High frequency that will be affected by the gain settings.1	*4
Hi Type (High Type)	Shlv, Peak	Sets the type of the High frequency band equalizer (Shlving type or peaking type).	
Level (Output Level)	0–100	Sets the volume after passing through the equalizer.	

NOTE

*1: An excessively great values for Resonance (Reso) may cause oscillation.

*2: An excessively large value for Cross-Feedback level may cause oscillation.

*3: When a mono source has been input, set “Inv” to provide spaciousness to the sound. Set “Sync” for inputting a stereo source.

*4: If Low Type (Lo Type) or High Type (Hi Type) is set to “Shlv (Shlving Type),” the setting for Lo Q or High Q is invalid.

Algorithm List



Analog Flanger

Models Roland SBF-325 Analog Flanger. Provides three types of flanger effects as well as chorus-like effect.

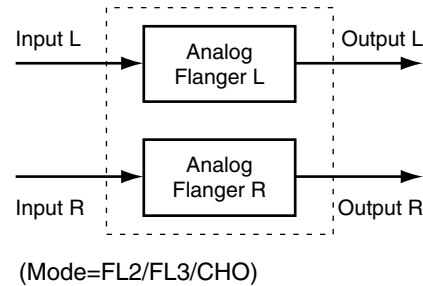
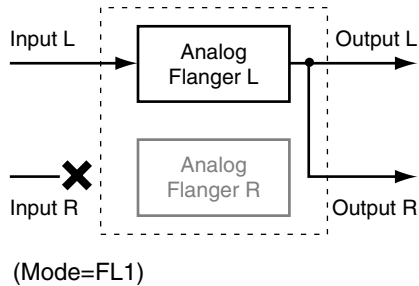

Types of Flanger Effect

Analog Flanger provides a variety of flanger effects or chorus effects. Selecting the desired flanger effect type in Mode.

FL1:	General monaural flanger
FL2:	Stereo flanger that allows stereo location of the direct sound to take effect.
FL3:	Cross mix flanger that provides more powerful effect
CHO:	Chorus effect

Parameter (full name)	Setting	Function
AFL (Analog Flanger): Models SBF-325 Analog Flanger.		
Sw (Switch)	On, Off	Turns the analog flanger on or off.
Feedback (Feedback Level)	0–100	Sets the amount of the delayed sound should be returned to the flanger input. *1, *2
Modulation Freq (Modulation Frequency)	0–100	Sets the center frequency subject to application of the flanger effect.
Modulation Rate (Modulation Rate)	0–100	Sets the flanger's modulation rate.
Modulation Depth (Modulation Depth)	0–100	Sets the depth of the flanger modulation.
Mode (Mode)	FL1, FL2, FL3, CHO	Sets the type of flanger effects. *3
ChB (Channel B Inverse)	Nor, Inv	"Inv" indicates that the Flanger effect on Channel B should be inverted. "Nor" indicates that it should not be inverted.
Phase ChA (Mix A Inverse)	Nor, Inv	"Inv" indicates that the phase should be inverted for mixing Channel A Flanger sound into the direct sound. "Nor" indicates that the phase should not be inverted.
Phase ChB (Mix B Inverse)	Nor, Inv	"Inv" indicates that the phase should be inverted for mixing Channel B Flanger sound into the direct sound. "Nor" indicates that the phase should not be inverted.

NOTE

*1: This feature is disabled when Mode is set to "CHO."

*2: Excessively large values may cause oscillation.

*3: MODE is set to "FL1," audio of Input R will not be send to Effect.



Rotary

Models a rotary speaker. Behaviors of High and low frequency band Roters can be set up separately, allowing realistic modeling of unique surging sensation. This effect is suited for organ sounds.

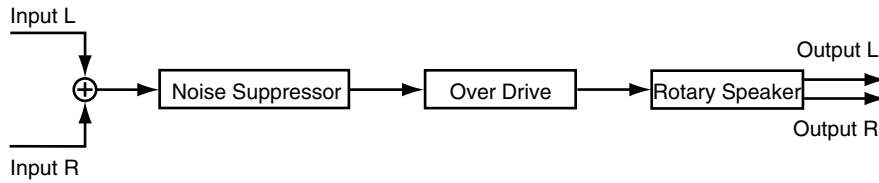

Parameter (full name)	Setting	Function
NS (Noise Suppressor):	Mutes noise in the silent mode.	
Sw (Switch)	On, Off	Turns the noise suppressor on or off.
Thresh (Threshold)	0–100	Sets the level to start muting noise.
Release (Release)	0–100	Sets the time over which the volume will drop to 0 after the noise starts being muted.
Ovd (Overdrive):	Adds distortion to the sound.	
Sw (Switch)	On, Off	Turns overdrive on or off.
Gain (Gain)	0–100	Sets the degree of sound distortion.
Level (Level)	0–100	Sets the volume of the overdrive sound.
Rot (Rotary Speaker):	Models a rotary speaker.	
LRate (Low Rate)	0.1–10.0 Hz	Sets the rotary frequency of the low frequency band roter.
HRate (High Rate)	0.1–10.0 Hz	Sets the rotary frequency of the High frequency band roter.

Algorithm List

2ch RSS

Gives each of the sounds input into the respective channels three-dimensional locations.

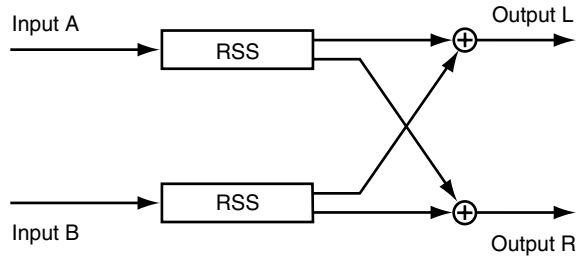

NOTE

- Input A is input into the L-channel side of the effect. Therefore, it is required to insert and connect “Lch” of the effect to the channel handling Input A. Similarly, Input B is input into the R-channel side of the effect. Insert and connect “Rch” of the effect to the channel handling Input B.
- Do not output the direct sound.

What is RSS?

It stands for Roland Sound Space. This is one of the Roland’s proprietary effect technologies that enables three-dimensional location of the sound source on the ordinary stereo system. Not only control on effect for the front and the sides of the audience, this technology provides controls on directions (azimuth) such as up, down and rear as well as control on distance to localize the sound source.

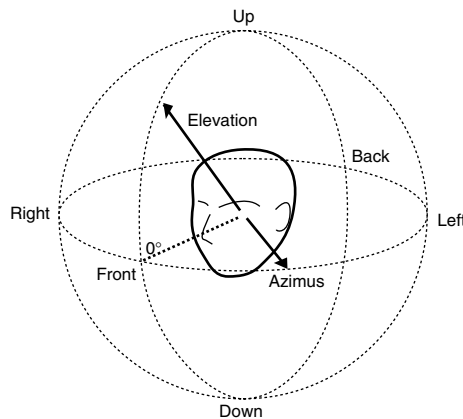

Parameter (full name)

Setting

Function

RSS:

Gives sounds three-dimensional locations.

Azimuth	-180–180°	Sets output directions, front, back, right and left, for the Input A channel.
Elevation	-90–90°	Sets output directions, up and down, for the Input A channel.
Type	A B	Same effects can be achieved as the old VS series (VS-880/880EX/890/1680/1880/1824/1824CD/VSF-880). More distinctive effects can be achieved than Type A.
Phones	Off, On	Set to On when you use headphones Set to Off when you use speakers.

Precautions for using RSS

When you use RSS with Phones Off, please notice the following points.

- Acoustically “dead” rooms are most suitable.
- A single-way speaker is suited. However, a multi-way type will do if it incorporates the coaxial or virtual coaxial system.
- Place the speakers as far as possible from the walls on the sides.
- Do not separate the right and left speakers too much.
- Recommended sweet spots for listening are as follows:

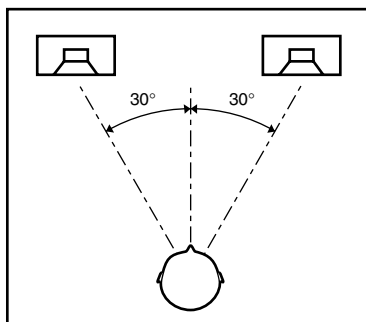

Labeling on RSS product package

In order to allow RSS to demonstrate its maximum performance, it is important to specify listening environment. For sale, we recommend that you should attach the following labeling on the packages of your products produced by using RSS patches.

■ When using with Phones Off



For Stereo Speakers

This sound is made to be played specifically through speakers.
The proper effect cannot be obtained if listened to through headphones.

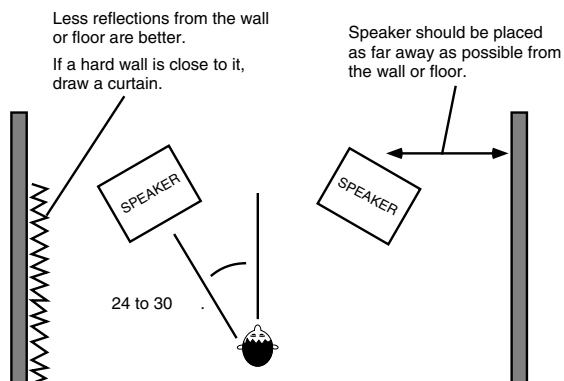

■ When using with Phones On



For Headphones

This sound has been made specifically for playing through headphones.
You cannot obtain the proper effect if listening through speakers.





Mic Modeling (Microphone Modeling)

This modifies sound that was recorded by a conventional dynamic mic, lapel mic or direct line, causing it to sound as though it had been recorded by an expensive condenser mic or a special studio mic. The mic simulator can add effects of proximity or distance.

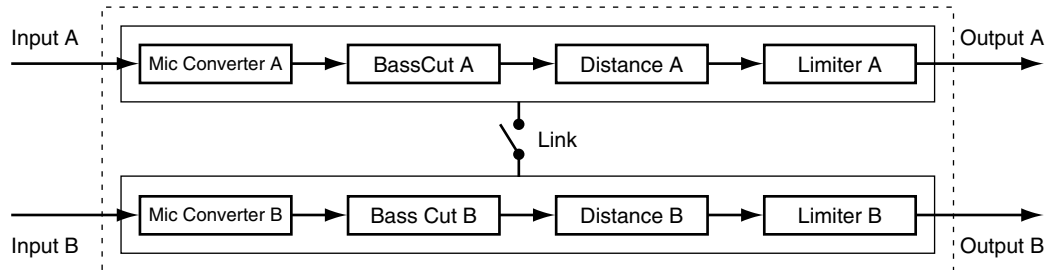

Selecting the microphone used for recording.

Input of Mic Converter selects the type of microphone to be used recording.

DR-20:	Roland DR-20 (dynamic microphone manufactured by Roland)
Sml.Dy:	Small Dynamic Microphone (dynamic microphone used for instruments and vocal)
Hed.Dy:	Head-worn Dynamic Microphone (headset-type dynamic microphone)
Min.Cn:	Miniature Condenser Microphone (very small condenser microphone)
Flat:	Line input
C3000B:	AKG C3000B (Condenser microphone manufactured by AKG)

Microphone types that can be modeled

The characteristics of the low-end general-purpose microphone are converted into the characteristics of the High-end microphone for studio application. You can add sound quality changes to already recorded sounds just as if a different type of microphone were used or if they were recorded at a different distance. In addition, it is possible to add microphone characteristics to line-recorded instrumental sounds. These characteristics can be set up by selecting the relevant value for Out of Mic Converter.

- Sml.Dy: Dynamic microphone for general musical instruments and vocal sounds. Ideal for a guitar amplifier and snare drums.
- Voc.Dy: Dynamic microphone for standard vocal sounds. Characterized in middle frequency band sounds with tension. Suited for vocal.
- Lrg.Dy: Dynamic microphone with an extended low frequency band. For bass and tom drums.
- Sml.Cn: Small condenser microphone for musical instruments. Characterized in bright High frequency band sounds. For metal percussion and acoustic guitars.
- Lrg.Cn: Condenser microphone with flat characteristics. For vocal, narration and live musical instruments.
- Vnt.Cn: Vintage condenser microphone. For vocal and live musical instruments.
- Flat: Microphone with flat frequency response. For removing peculiarity of the microphone used for recording sounds.

* When a condenser-type mic is selected in OUT, low-range noise transmitted through the mic stand may be accentuated due to the mic's low range characteristics. In such instances, either cut out any unnecessary low end with bass cut filter, or equip the mic stand with an isolation mount (a mic holder with rubber or other shock absorbing material).

* The "Lrg.Dy" and the "Lrg.Cn" of the Out parameter are valid only if the In parameter is set to "Min.Cn."

Proximity effect of microphone

In nature, a microphone tends to extend the low frequency band characteristics when placed close to the sound source. This is called proximity effect. This effect can be modeled in Proximity Effect (Prox-Efect). Set the parameter to a positive (+) value for a shorter distance to the sound source and a negative (-) value for a longer distance to the sound source. Time of Distance models the time difference due to distance from the sound source.

Controlling Channels A and B separately

Setting Link On enables simultaneous control on the 4-Band Parametric Equalizer via Channel B according to the settings on the Channel A side. To control Channels A and B separately, turn Link Off.

Parameter (full name)	Setting	Function
Lnk (Link): Channel B follows the settings for Channel A.		
Link (Link Switch)	On, Off	Specifies if Channel B follows or does not follow the settings for Channel A.
CnvA, CnvB (Mic Converter): Converts the characteristics of the low-end general-purpose microphone into the characteristics of the High-end microphone for studio application.		
Sw (Switch)	On, Off	Turns the microphone converter on or off.
Input (Input)	See the column on the previous page.	Sets the microphone type used for recording.
Output (Output)	See the column on the previous page.	Sets the microphone types to be Modeled.
Phase (Phase)	Nor, Inv	Sets the microphone phase.
BCutA, BCutB (Bass Cut Filter): Cuts off undesired low frequency band sounds such as pop noise.		
Sw (Switch)	On, Off	Turns the bass cut filter on or off.
Freq (Frequency)	Thru, 20 - 2000 Hz	Sets the frequency for cutting off undesired low frequency band sounds such as pop noise.
DstnA, DstnB (Distance): Models the frequency characteristics and time difference due to distance difference.		
Sw (Switch)	On, Off	Turns the distance on or off.
Prox.Fx (Proximity Effect)	-12- +12	Corrects the low frequency band characteristics due to the distance from the sound source.
Time (Time)	0-3000 cm	Models the time difference due to the distance from the sound source.
LmtA, LmtB (Limiter): Prevents distortion by suppressing signals at High levels.		
Sw (Switch)	On, Off	Turns the limiter on or off.
Thrsh (Threshold)	-60-0 dB	Sets the volume level to start suppressing excessive input.
Attack (Attack Time)	0-100	Sets the time from when the input level exceeds the threshold level to when the effect begins to apply.
Release (Release Time)	0-100	Sets the time from when the input level drops below the threshold level to when the effect ceases to apply.
Detect HPF Freq (Detect HPF Frequency)	Thru, 20 - 2000 Hz	Normally, sets "Thru". Sets the cutoff frequency of the level detection section.
Level (Output Level)	-60- +24 dB	Sets the volume of the compressor sound.

Algorithm List



Guitar Multi 1-3

These provide multi-effects for guitar sounds suited for rock. Guitar Multi 1 through 3 differ in the degree of sound distortion. Guitar Multi 1 provides the Highest degree of distortion and Guitar-Multi 3 the lowest.

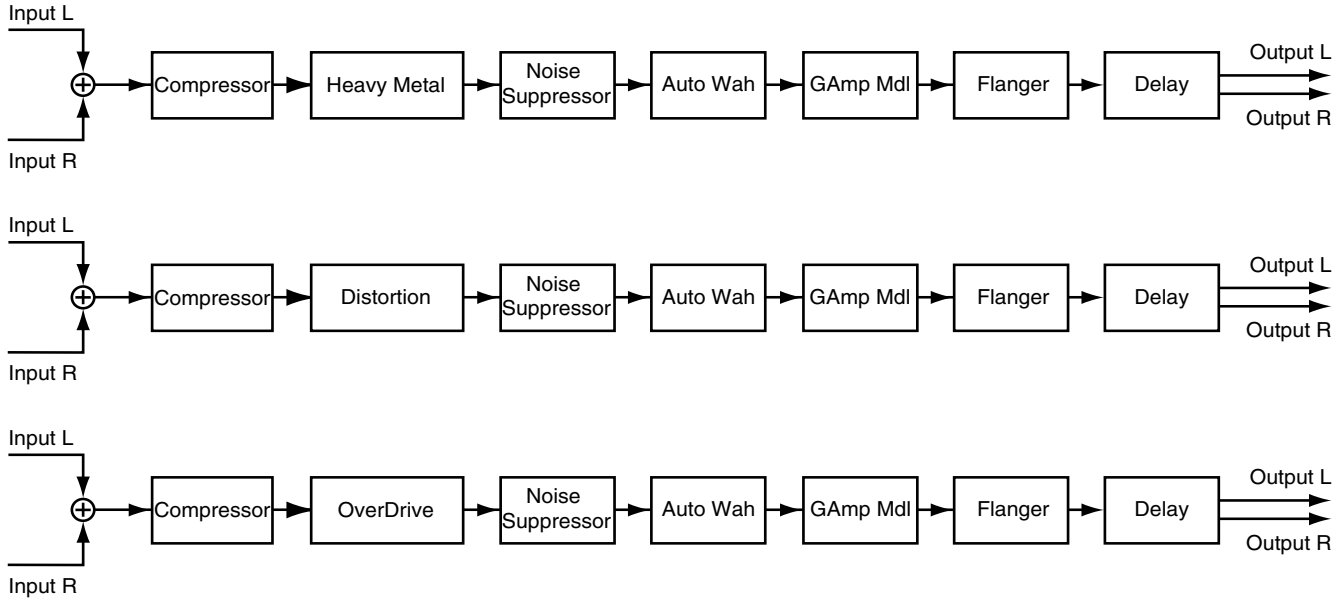

Usage of Guitar Multi 1 through 3

The basic configuration is almost identical for all of Guitar-Multi 1 through 3. The only difference is the type of the second effect (heavy metal, distortion, and overdrive). Select Guitar Multi 1 to add severe distortion to the sound, and select Guitar Multi 3 for soft distortion as that achieved with the vacuum tube amplifier.

Adding Wah effect by changing input volume

Typically, Auto-Wah provides an automatic wah effect at the cycle set with Rate (Rate).

Alternatively, you can give wah effect according to changes of input volume. For example, you can apply the wah effect so that it reflects changes in picking on the guitar. First, adjust sensitivity for changes in input volume by using Sense (Sens). Set it to a larger value for finer subtlety. After that, you simply decide the direction into which the filter should be moved by entering a setting for Polarity (Pol).

Selecting Guitar Amplifier

You can select which type of Guitar Amplifier to use with Mode (Mode) under Guitar Amplifier Simulator.

Small:	Small-sized amplifier
Built In:	Built-in type amplifier
2 Stack:	Large-sized two-deck stacked amplifiers
3 Stack:	Large-sized three-deck stacked amplifiers

Compressors used in Guitar Multi 1 through 3

Compressors used in Guitar Multi 1 through 3 are designed to accommodate playing of the guitar, providing a slightly different effect from ordinary compressors. Compressors for the guitar unifies volumes by suppressing signals at High levels and enhancing signals at low levels.

Unlike these, ordinary compressors simply suppress signals at High levels.

Parameter (full name)	Setting	Function
Comp (Compressor): Compresses the entire output signals when the input volume exceeds a specified value.		
Sw (Switch)	On, Off	Turns the compressor on or off.
Sustain (Sustain)	0–100	Sets the time over which low level signals are boosted to a constant volume.
Attack (Attack)	0–100	Sets the strength of attack when a sound is input.
Tone (Tone)	-50–50	Sets the tone color.
Level (Level)	0–100	Sets the volume of the compressor sound.

Metal (Heavy Metal) / Dstr (Distortion) / Ovd (Overdrive): Gives distortion to the sound.		
Sw (Switch)	On, Off	Turns the metal, distortion or overdrive on or off.
Gain (Gain)	0–100	Sets the degree of the distortion.
Low Gainain (Low Gain)	-100–100	Sets the boost/cut amount in the low frequency band. (only for Metal)
MidGain (Middle Gain)	-100–100	Sets the boost/cut amount in the middle frequency band. (only for Metal)
High Gainain (High Gain)	-100–100	Sets the boost/cut amount in the High frequency band. (only for Metal)
Tone (Tone)	0–100	Sets the tone color. (for Distortion/Overdrive only)
Level (Level)	0–100	Sets the volume of the metal, distortion or overdrive sound.

NS (Noise Suppressor): Mutes noise in the silent mode.		
Sw (Switch)	On, Off	Turns the noise suppressor on or off.
Thresh (Threshold)	0–100	Sets the level to start muting noise.
Release (Release)	0–100	Sets the time over which the volume will drop to 0 after the noise starts being muted.

Wah (Auto Wah): Adds the wah effect.		
Sw (Switch)	On, Off	Turns the auto wah on or off.
Mode (Mode)	LPF, BPF	Set to “BPF” for the wah effect in a narrow range of frequencies and to “LPF” for wah effect in a broad range of frequencies.
Pol (Polarity)	Up, Down	Activated only for adding the wah effect according to input volume changes. Set to “Up” for moving the filter to a Higher frequency and “Down” for moving it to a lower frequency.
Sens (Sense)	0–100	Normally “0.” Sets sensitivity for input volume changes for adding the wah effect according to input volume changes.
Freq (Frequency)	0–100	Sets the frequency at which the wah effect starts working.
Peak (Peak)	0–100	Sets the degree of the wah effect applied at around the frequency.
Rate (Rate)	0.1–10.0 Hz	Sets the rate at which the wah effect will be cyclically modulated.
Depth (Depth)	0–100	Sets the depth at which the wah effect will be cyclically modulated.
Level (Level)	0–100	Sets the volume of the wah sound.

Mdl (Guitar Amplifier Simulator): Models Guitar Amplifier.		
Sw (Switch)	On, Off	Turns the guitar amplifier simulator on or off.
Mode (Mode)	See the column on the previous page.	Type of the guitar amplifier.

Flg (Flanger): Adds effects similar to ascending/descending sound of a jet.		
Sw (Switch)	On, Off	Turns the flanger on or off.
Rate (Rate)	0.1–10.0 Hz	Sets the rate of modulation for the flanger.
Depth (Depth)	0–100	Sets the depth of modulation for the flanger.
Manual (Manual)	0–100	Sets the center frequency subject to application of the flanger effect.
Reso (Resonance)	0–100	Enhances frequency components at around the center frequency set with Manual.

➔ Continued...

Algorithm List

Dly (Delay): Adds a delayed sound to the direct sound, adding depth to the sound or creating special effects.

Sw (Switch)	On, Off	Turns the delay on or off.
Time (Delay Time)	0–1000 ms	Sets the time from direct sound until when the delay sound is heard. *1
shift (shift)	L1000–0–R1000 ms	Sets the delay time difference between the right and left delay sounds.
FBTim (Feedback Delay Time)	0–1000 ms	Sets the feedback repetition cycle.
FBLvl (Feedback Level)	-100–100	Sets the amount of the delay sound should be returned to the delay input.
FX Lvl (Effect Level)	-100–100	Sets the volume of the delay sound.
DirLvl (Direct Level)	-100–100	Sets the volume of the direct sound.



*1: The sum of the Delay Time value and the Delay shift value should not exceed the setting range of Delay Time. For example, if Delay Time is set to 800 ms, the setting range of Delay shift is L200 to R200 ms.



Guitar Amp Modeling (Guitar Amplifier Modeling)

Models a guitar amplifier.

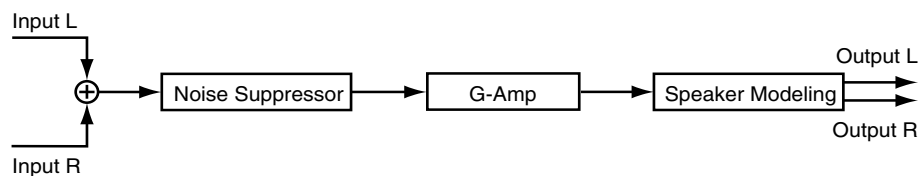

Parameter (full name)	Setting	Function
-----------------------	---------	----------

NS (Noise Suppressor): Mutes noise in the silent mode.

Sw (Switch)	On, Off	Turns the noise suppressor on or off.
Thresh (Threshold)	0–100	Sets the level to start muting noise.
Release (Release)	0–100	Sets the time over which the volume will drop to 0 after the noise starts being muted.

AMP (Pre-Amplifier): Models the pre-amplifier section of a guitar amplifier.

Sw (Switch)	On, Off	Turns the compressor on or off.
Amp Type (Pre-amplifier type)	See the column on the next page.	Sets the type of the guitar amplifier.
Gain (Gain)	Low, Middle, High	Sets the degree of sound distortion on the pre-amplifier.
Bright (Bright)	On, Off	You can set this on to generate clear-cut bright sounds. *1
Volume (Volume)	0–100	Sets the volume and degree of distortion of the amplifier.
Bass (Bass)	0–100	Sets the tone of the low range.
Middle (Middle)	0–100	Sets the tone of the middle range. *2
Treble (Treble)	0–100	Sets the tone of the High range.
Presence (Presence)	0–100 (-100–0)	Sets the tone of the ultra-High range. *3
Master (Master)	0–100	Sets the volume of the entire pre-amplifier

Sp (Speaker Simulator): Models a speaker.

Sw (Switch)	On, Off	Turns the speaker simulator on or off.
Sp Type (Speaker Type)	See the column on the previous page.	Sets the speaker type.
Mic Setting (Microphone Setting)	1, 2, 3	Sets the location of the microphone that is recording the sound of the speaker. This can be adjusted in three steps, with the microphone becoming more distant in the order of 1, 2, and 3.
MicLvl (Microphone Level)	0–100	Sets the microphone volume.

DirLvl (Direct Level) 0–100 Sets the volume of the direct sound.



- *1: Can be set only when JC-120, Clean Twin or BG Lead is selected for Pre-amplifier Type.
- *2: Cannot be set when Match Drive is selected for the Pre-amplifier Type.
- *3: The setting range is -100 to 0 when Match Drive is selected for the Pre-amplifier Type.

Pre-amplifier

Models the pre-amplifier section of a guitar amplifier. 14 types of pre-amplifiers that can be modeled are listed below: The type can be set with pre-amplifier Type.

JC-120:	The sound of a Roland.
Clean Twin:	The sound of standard built-in type vacuum tube amplifier.
Match Drive:	The sound of a recent vacuum tube amplifier widely used in blues, rock and fusion.
BG Lead:	The sound of a vacuum tube amplifier representative of the late 70's through 80's.
MS1959<I>:	The sound of the large vacuum tube amplifier stack that was indispensable to the British hard rock of the 70's, with input I connected.
MS1959<II>:	The same amplifier as MS1959 <I>, but with input II connected.
MS1959<I+II>:	The same amplifier as MS1959 <I>, but with input I and II connected in parallel.
SLDN Lead:	The sound of a vacuum tube amplifier usable in a wide variety of styles.
Metal 5150:	The sound of a large vacuum tube amplifier suitable for heavy metal.
Metal Lead:	A metal lead sound with a distinctive mid-range.
OD-1:	The sound of the BOSS OD-1 compact effector.
OD-2Turbo:	The sound of the BOSS OD-2 compact effector with the Turbo switch on.
Distortion:	Distortion sound
Fuzz:	Fuzz sound

* With JC-120, Clean Twin or BG Lead is selected, turning Bright (Bright) on generates clear-cut bright sound.

Speaker simulator

Models a speaker. The 12 types of speakers as listed below can be modeled: The type is set with Speaker Type. The type can be set with Speaker Type.

Type	Cabinet (size (in inch), number of units)	Speaker	Microphone
Small	Small open-back enclosure	10	Dynamic microphone
Middle	Open back enclosure	12 x 1	Dynamic microphone
JC-120	Open back enclosure	12 x 2	Dynamic microphone
Built In 1	Open back enclosure	12 x 2	Dynamic microphone
Built In 2	Open back enclosure	12 x 2	Condenser microphone
Built In 3	Open back enclosure	12 x 2	Condenser microphone
Built In 4	Open back enclosure	12 x 2	Condenser microphone
BG Stack 1	Sealed enclosure	12 x 2	Condenser microphone
BG Stack 2	Large sealed enclosure	12 x 2	Condenser microphone
MS Stack 1	Large sealed enclosure	12 x 4	Condenser microphone
MS Stack 2	Large sealed enclosure	12 x 4	Condenser microphone
Metal Stack	Large double stack	12 x 4	Condenser microphone

Recommended combinations of Pre-amplifier and Speaker

Pre-amplifier Type	Speaker Type
BG Lead	BG Stack 1, BG Stack 2, Middle
MS1959II	BG Stack 1, BG Stack 2, Metal Stack
MS1959I+II	BG Stack 1, BG Stack 2, Metal Stack
SLDN Lead	BG Stack 1, BG Stack 2, Metal Stack
Metal 5150	BG Stack 1, BG Stack 2, Metal Stack
Metal Lead	BG Stack 1, BG Stack 2, Metal Stack
OD-2 Turbo	Built In1 - 4
Distortion	Built In1 - 4
Fuzz	Built In 1 - 4

Algorithm List



Vocal Multi

This feature provides a multi-effect suited for vocals.

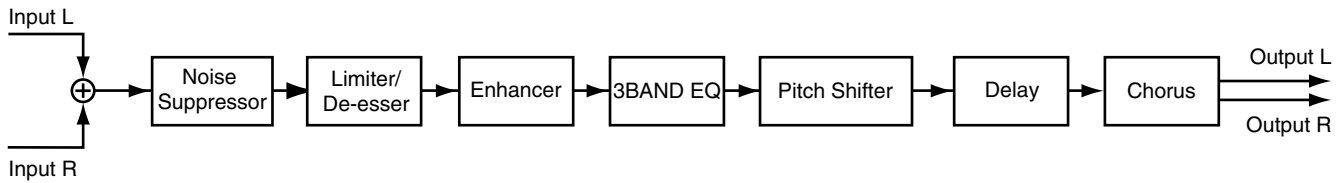

Cutting distortion in vocals

Limiter can be used to suppress signals at a High level to prevent sound distortion. To do this, follow the steps below:

Mode (Mode):	Limiter
Limiter Threshold (Thresh):	Sets the volume at which sound distortion starts being suppressed.
Limiter Release (Release):	Determines the time that elapses before the input level becomes off after it drops below the Limiter Threshold.
Limiter Level (Level):	Decides the volume after passing through Limiter.

Cutting the sibilant sounds of a voice.

De-esser can be used to cut off sibilant sounds contained in vocal sounds to achieve softer sound quality. To do this, follow the steps below:

Mode (Mode):	De-esser
De-esser Sense (Sens):	Sets the degree of the De-esser effect.
De-esser Frequency (Freq):	Sets the frequency at which De-esser effect starts working.

Parameter (full name)	Setting	Function
NS (Noise Suppressor):	Mutes noise in the silent mode.	
Sw (Switch)	On, Off	Turns the noise suppressor on or off.
Thresh (Threshold)	0–100	Sets the level to start muting noise.
Release (Release)	0–100	Sets the time over which the volume will drop to 0 after the noise starts being muted.
Lmt (Limiter / De-esser):	Suppresses signals at High levels to control distortion / Suppresses the annoying s-consonant.	
Sw (Switch)	On, Off	Turns the limiter/de-esser on or off.
Mode (Mode)	Limiter, De-esser	Selects limiter or de-esser.
Thresh (Limiter Threshold)	0–100	Sets the volume at which sound distortion starts being suppressed.
Release (Limiter Release)	0–100	Sets the time until when the limiter will turn off after the input level falls the limiter Threshold (Thresh).
Level (Limiter Level)	0–100	Sets the volume of the limiter sound.
ENH (Enhancer):	Accentuates the sound and push the sound forward.	
Sw (Switch)	On, Off	Turns the enhancer on or off.
Sens (Sense)	0–100	Sets the degree of the enhancer effect desired.
Freq (Frequency)	1.0–10.0 kHz	Sets the frequency at which the enhancer effect starts working.
MixLvl (Mix Level)	0–100	Sets the amount of the enhancer sound should be mixed into the direct sound.
Level (Level)	0–100	Sets the volume of the enhancer sound.

EQ (Equalizer)

Sw (Switch)	On, Off	Turns the equalizer on or off.
Low Gain (Low Gain)	-12– +12 dB	Sets the boost/cut amount in the low frequency band.
Low Freq (Low Frequency)	20 - 2000 Hz	Sets the center frequency in the low frequency band.
Low Q	0.3–10.0	Sets the width of the area around the low frequency that will be affected by the gain settings.1 *1
Low Type	Shlv, Peak	Sets the type of the low frequency band equalizer (Shlving type or peaking type).
Mid Gain (Middle Gain)	-12– +12 dB	Sets the boost/cut amount in the middle frequency band.
Mid Freq (Middle Frequency)	200–8000 Hz	Sets the center frequency in the middle frequency band.
Mid Q (Middle Q)	0.3–10.0	Sets the width of the area around the middle frequency that will be affected by the gain settings.
High Gain	-12– +12 dB	Sets the boost/cut amount in the High frequency band.
High Freq (High Frequency)	1.4–20.0 kHz	Sets the center frequency in the High frequency band.
High Q	0.3–10.0	Sets the width of the area around the High frequency that will be affected by the gain settings.1 *1
Hi Type (High Type)	Shlv, Peak	Sets the type of the High frequency band equalizer (Shlving type or peaking type).
Level (Output Level)	0–100	Sets the volume after passing through the equalizer.

Pshift (Pitch shifter): shifts the pitch.

Sw (Switch)	On, Off	Turns the pitch shifter on or off.
Chromatic Pitch	-12–12	Pitch variation (by semitone)
Fine Pitch	-100–100	Pitch variation (by cent)
FX Lvl (Effect Level)	-100–100	Sets the volume of the pitch shift sound.
DirLvl (Direct Level)	-100–100	Sets the volume of the direct sound.

Dly(Delay): Adds a delayed sound to the direct sound, adding depth to the sound or creating special effects.

Sw (Switch)	On, Off	Turns the delay on or off.
Time (Delay Time)	0–1000 ms	Sets the time from direct sound until when the delay sound is heard.
FBLvl (Feedback Level)	-100–100	Sets the amount of the delay sound should be returned to the delay input.
FX Lvl (Effect Level)	-100–100	Sets the volume of the delay sound.
DirLvl (Direct Level)	-100–100	Sets the volume of the direct sound.

Cho (Chorus): Adds spaciousness and thickness to the sound.

Sw (Switch)	On, Off	Turns the chorus on or off.
Rate (Rate)	0.1–10.0 Hz	Sets the rate of modulation.
Depth (Depth)	0–100	Sets the depth of modulation.
PreDLY (Pre-Delay)	0–50 ms	Sets the time delay from when the direct sound begins until the processed sound is heard.
FX Lvl (Effect Level)	-100–100	Sets the volume of the chorus sound.
DirLvl (Direct Level)	-100–100	Sets the volume of the direct sound.



*1: If Low Type (Lo Type) or High Type (Hi Type) is set to “Shlv (Shlving Type),” the setting for Lo Q or High Q is invalid.



Voice Transformer

You can convert male voice into female voice, female voice into male voice, and human voice into mechanical voice to create sounds of various qualities by controlling the base pitch and the formant separately.

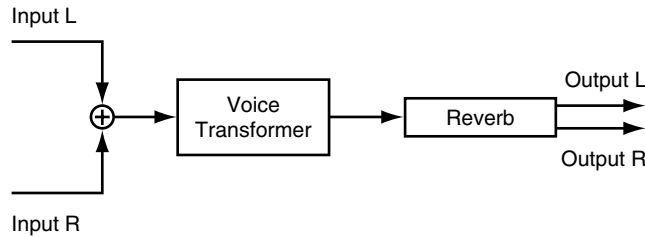

NOTE

- When inputting voice, use voice of one person only. Inputting voices of more than one person disables normal operation.
- Be sure that sound from a speaker does not enter the microphone you are using. This will have the same effect as if several voices were input to the unit.
- A unidirectional microphone is recommended for use. It is also recommended that the person should speak standing as close to the microphone as possible.
- “Voice Transformer” cannot be used on EFFECT2 and 4 (even-numbered effects).
- When “Voice Transformer” is used on EFFECT1 and 3 (odd-numbered effects), EFFECT2 and 4 (even-numbered effects) cannot be used.
- “Voice Transformer” cannot be used on the projects with 64kHz or higher sampling rate.

Parameter (full name)	Setting	Function
VT (Voice Transformer): Creates various voice characters.		
Sw (Switch)	On, Off	Turns Vocal the transformer on or off.
Robot (Robot)	On, Off	When this is on, the audio will be output at a fixed pitch regardless of the pitch that is input.
Chromatic Pitch	-12– +36	Sets the pitch variation of the voice to be output (by semitone).
Fine Pitch	-100–100	Sets the pitch variation of the voice to be output (by cent).
Chromatic Formant	-12– +12	Sets the formant variation of the voice to be output (by semitone).
Fine Formant	-100– +100	Sets the formant variation of the voice to be output (by cent).
MixBal (Mix Balance)	0–100	Sets the volume balance between the output voice and the input voice.

REV (Reverb): Adds reverberation.		
Sw (Switch)	On, Off	Turns the reverb on or off.
Time (Reverb Time)	0.1–32.0 sec	Sets the length (time) of the reverb sound.
PreDLY (Pre-Delay)	0–200 ms	Sets the time until the reverberation appears.
Density (Density)	0–100	Sets the density of the reverb sound.
FX Lvl (Effect Level).	0–100	Sets the volume of the reverb sound.



Formants (p.18)

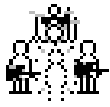

Vocal Canceler

When a stereo source is being input from CD or DAT and so on, this cancels the sound which is located in the stereo center, such as the vocal or bass.

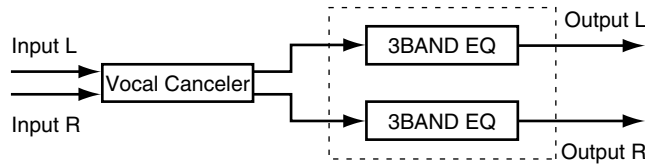

NOTE

Depending on the music source, sounds that you do not wish to be canceled may be canceled as well. In particular if the musical source has heavy reverb or if the sound that you wish to delete is not located in the center, the vocal canceler may not produce the desired result.

Canceling the vocals alone

Vocal Canceler cancels the sound located in the center. That means it cancels sounds such as the bass and sounds of the lead instrument along with vocal sounds. To cancel vocals only to create music for karaoke, for example, set Range Lo to around 100 Hz and Range Hi to around 1 kHz.

Parameter (full name)	Setting	Function
VC (Vocal Canceler):	Cancels sounds located in the center such as vocals and the bass.	
Sw (Switch)	On, Off	Turns the vocal canceler on or off.
Balance (Balance)	0-100	If the sound that you wish to cancel is not located in the center, find the point at which it is most effectively canceled.
RangeLo (Range Low)	Unlimit, 20 - 2000 Hz	Sets the lower limit of the frequency band to be canceled. ^{*1}
RangeHi (Range High)	1.0 - 20.0 kHz, Unlimit	Sets the upper limit of the frequency band to be canceled. ^{*2}
EQ (Equalizer)		
Sw (Switch)	On, Off	Turns the equalizer on or off.
Low Gain (Low Gain)	-12- +12 dB	Sets the boost/cut amount in the low frequency band.
Low Freq (Low Frequency)	20 - 2000 Hz	Sets the center frequency in the low frequency band.
Low Q	0.3-10.0	Sets the width of the area around the low frequency that will be affected by the gain settings. ^{*3}
Low Type	Shlv, Peak	Sets the type of the low frequency band equalizer (Shlving type or peaking type).
Mid Gain (Middle Gain)	-12- +12 dB	Sets the boost/cut amount in the middle frequency band.
Mid Freq (Middle Frequency)	200-8000 Hz	Sets the center frequency in the middle frequency band.
Mid Q (Middle Q)	0.3-10.0	Sets the width of the area around the middle frequency that will be affected by the gain settings.
High Gain	-12- +12 dB	Sets the boost/cut amount in the High frequency band.
High Freq (High Frequency)	1.4-20.0 kHz	Sets the center frequency in the High frequency band.
High Q	0.3-10.0	Sets the width of the area around the High frequency that will be affected by the gain settings. ^{*3}
Hi Type (High Type)	Shlv, Peak	Sets the type of the High frequency band equalizer (Shlving type or peaking type).
Level (Output Level)	0-100	Sets the volume after passing through the equalizer.

→ Continued...

Algorithm List

NOTE

- *1: Setting to "Unlimit" means that the frequency that can be played back on this unit is the lower limit.
- *2: Setting to "Unlimit" means that the frequency that can be played back on this unit is the upper limit.
- *3: If Low Type (Lo Type) or High Type (Hi Type) is set to "Shlv (Shlving Type)," the setting for Lo Q or High Q is invalid.



Vocoder

The vocoder creates “talking instrument” effects. To use Vocoder, input an instrumental sound into the left channel and a vocal sound into the right channel. The instrumental sound is split into ten frequency bands to be processed according to its frequency components.

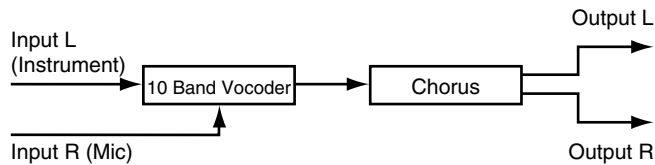

NOTE

Instrumental sounds are input into the L-channel side of the effect. Therefore, it is required to insert and connect “Lch” of the effect to the channel handling instrumental sounds. Similarly, vocal sounds are input into the R-channel side of the effect. Insert and connect “Rch” of the effect to the channel handling vocal sounds.

Tips for using Vocoder

It is a good idea to choose instrumental sounds containing a lot of overtones. Recommended sounds include those with saw-tooth waveforms such as strings and distorted guitar sounds.

Parameter (full name)

Setting

Function

Voc (Vocoder): The pitch is specified with the instrumental sound while the tone is output in vocals.

Parameter (full name)	Setting	Function
Char 1–10 (Voice Characters)	0–100	Sets the volume by frequency band. These are used to change the vocoder tone.

CHO (Chorus):

Adds spaciousness and depth to the sound.

Parameter (full name)	Setting	Function
Sw (Switch)	On, Off	Turns the chorus on or off.
Rate (Rate)	0.1–10.0 Hz	Sets the rate of modulation.
Depth (Depth)	0–100	Sets the depth of modulation.
PreDLY (Pre-Delay)	0–50 ms	Sets the time delay from when the direct sound begins until the processed sound is heard.
FBLvl (Feedback Level)	-100–100	Sets the amount of the chorus sound should be returned to the chorus input.
FX Lvl (Effect Level)	-100–100	Sets the volume of the chorus sound.
DirLvl (Direct Level)	-100–100	Sets the volume of the direct sound.

Algorithm List



Vocoder2 (19)

This is a 19-band vocoder. Provides clear sounds that used to be impossible with the previous vocoders.

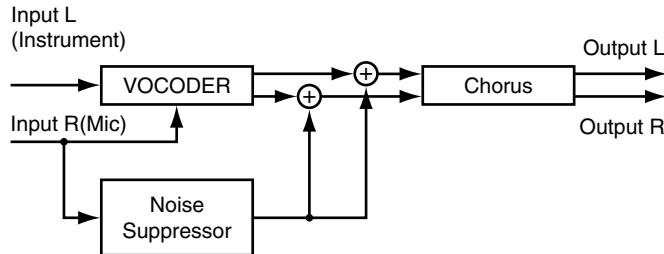

NOTE

- Instrumental sounds are input into the L channel side of Effect. Therefore, it is required to insert-connect "Lch" of Effect to the channel handling instrumental sounds. Similarly, vocal sounds are input into the R channel side of Effect. Insert-connect "Rch" of Effect to the channel handling vocal sounds.
- "Vocoder2 (19)" cannot be used on EFFECT2 and 4 (even-numbered effects).
- When "Vocoder2 (19)" is used on EFFECT1 and 3 (odd-numbered effects), EFFECT2 and 4 (even-numbered effects) cannot be used.
- "Vocoder2 (19)" cannot be used on the projects with 64kHz or higher sampling rate.

Difference between Vocoder and Vocoder 2

Compared to Vocoder, Vocoder 2 has a significant number of frequency bands as points. It also makes it possible to make fine adjustment including adjustment of the input sensitivity of the microphone and location of sounds as well as setting the input level for instrumental sounds and removing noise. All this yields clear human voices.

"Envelope" for defining sound characteristics

Each sound has its own envelope. An envelope gives characteristics to the sound and functions as a significant factor for the human ear to distinguish different sound types. On Vocoder 2, you can use Envelope to give the following characteristics.

Sharp:	Enhances human voice.
Soft:	Enhances instrumental sound.
Long:	Vintage sound with long reverberation.

Sound location

Pan Mode (PanMode) can be used to specify how Vocoder sounds should be located.

Mono:	Locating in the middle.
Stereo:	Stereo (Odd-number frequencies are located to the left and even-number frequencies to the right.)
L→R:	Lower frequencies are located to the left and upper frequencies to the right.
R→L:	Lower frequencies are located to the right and upper frequencies to the left.

Sounding instrumental sounds with the formant fixed

While inputting voice through the microphone, instrumental sounds can be sounded at the same vocal formant. For example, when saying "a-i-u-e-o" into the microphone, set "Hold" On at the moment the speaker is on the "i" sound to issue an instrumental sound with the formant of the "i" sound.

Parameter (full name)	Setting	Function
Voc (Vocoder 2):		
The pitch is specified as in the instrumental sound while the tone is output in the human voice.		
Envelope (Envelope)	Sharp, Soft, Long	Defines characteristics of the sound.
PanMode (Pan Mode)	Mono, Stereo, L→R, R→L	Defines how the sound is located.
Hold (Hold)	On, MIDI	Specifies that an instrumental sound is or is not issued with the formant fixed.
MicSens (Microphone Sensitivity)	0–100	Sets the input sensitivity of the microphone.
SynInLvl (Synthesizer In Level)	0–100	Sets the input level of the instrumental sound.
Character Ch1 – 19 (Voice Character Channels 1 - 19)	0–100	Sets the tone of the vocoder.
Mic (Microphone Mix)	0–100	Sets the amount of the sound after passing through the microphone HPF should be mixed into the Vocoder output.
MicHPF (Microphone HPF)	Thru, 1.0–20.0 kHz	Sets the frequency at which HPF on the vocal sounds through the microphone starts taking effect. Sets this to “Thru” if HPF is not desired.
MicPan (Microphone Pan)	L63–R63	Sets the panning of vocal sounds through the microphone.
NSThresh (Noise Suppressor Threshold)	0–100	Sets the volume to start muting noise on the instrumental sound input.
Cho (Chorus):		
Adds spaciousness and depth to the sound.		
Sw (Switch)	On, Off	Turns the chorus on or off.
Rate (Rate)	0.1–10.0 Hz	Sets the rate of modulation.
Depth (Depth)	0–100	Sets the depth of modulation.
PreDly (Pre-Delay)	0–50 ms	Sets the time delay from when the direct sound begins until the chorus sound is heard.
MixBal (Mix Balance)	0–100	Sets the volume balance between the chorus sound and the direct sound.

Algorithm List



Lo-Fi Processor

This allows you to create a “lo-fi” sound by lowering the sample rate and/or decreasing the number of bits.

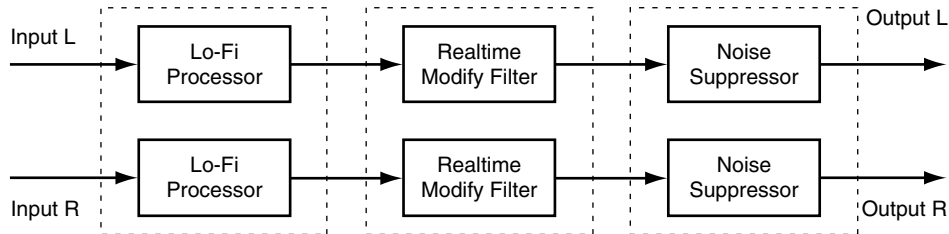

Creating lo-fi sounds

Follow the steps below to create lo-fi sounds essential to dance music including hip-hop and DJ music.

Lo-Fi Processor

- Turn Pre Filter and Post Filter off. This provides powerful lo-fi sounds containing digital distortion.
- Set Rate and Bit to relatively low values. Note, however, an excessively low value for Bit may cause big noise even in the silent mode. In that case, increase Threshold (Thresh) of Noise Suppressor.

Real time Modify Filter

- Increase resonance to add a twist to the sound. Note that excessive resonance may cause oscillation.

Lo-Fi (Lo-Fi Processor): Creates lo-fi sounds.

Sw (Switch)	On, Off	Turns the lo-fi processor on or off.
Pre Filter (Pre Filter Switch)	On, Off	Turns the filter to reduce digital distortion on or off.
Rate (Rate)	Off, 1/2 - 1/32	Sets the sample rate. Set Rate to “Off” if no change is desired.
Bit (Bit)	Off, 15 bits - 1 bit	Sets the number of bits in data. Set Bit to “Off” if no change is desired.
Post Filter (Post Filter Switch)	On, Off	Turns the filter to reduce digital distortion due to modification to lo-fi sounds on or off.
FX Lvl (Effect Level).	0–100	Sets the volume of the lo-fi sound.
DirLvl (Direct Level)	0–100	Sets the volume of the direct sound.

RMF (Real time Modify Filter): Creates sounds with a twist.

Sw (Switch)	On, Off	Turns the real time modify filter on or off.
Type (Type)	LPF, BPF, HPF	Sets the filter type.
CutOff (Cutoff Frequency)	0–100	Sets the cutoff frequency.
Reso (Resonance)	0–100	Enhances the frequency components around cutoff frequency.
Gain (Gain)	0–24 dB	Sets the volume of the real time modify filter.

NS (Noise Suppressor): Mutes noise in the silent mode.

Thresh (Threshold)	0–100	Sets the level to start muting noise.
Release (Release)	0–100	Sets the time over which the volume will drop to 0 after the noise starts being muted.

XX 3band Isolator

Sharply cuts off components by frequency band to eliminate undesired sounds. Useful to eliminate undesired sounds and take out only specific sounds from a CD. Isolator can make sounds completely perish, unlike ordinary equalizers that leave some sounds even with the gains of the respective frequency bands set to the minimum.

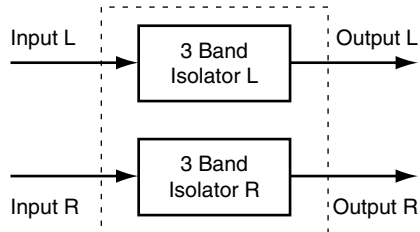

Muting the bass

Set up as follows to eliminate low frequency band sounds such as bass sounds.

Anti-phase Low Mix Switch (AntiPhase LoMixSw): On
 Anti-phase Low Level (AntiPhase LoLev): Relatively High

Muting vocals

Set up as follows to eliminate middle frequency band sounds such as vocal sounds.

Anti-phase Middle Mix Switch (AntiPhase MidMixSw): On
 Anti-phase Middle Level (AntiPhase MidLev): Relatively High

Muting noise

Identify the frequency band of the noise and set the relevant Level (LowLvl, MidLvl or HiLvl) to -60 dB.

Parameter (full name)	Setting	Function
Iso (3-band Isolator):	Divides the input sound into three frequency bands to abstract or eliminate the sound.	
Sw (Switch)	On, Off	Turns the 3-band isolator on or off.
AntiPhase LoLev (Anti-phase Low Level)	0-100	Sets the amount of the low frequency band sound should be muted.
AntiPhase MidLev (Anti-phase Middle Level)	0-100	Sets how much of the middle frequency band sound should be muted.
LoMixSw (Anti-phase Low Mix Switch)	On, Off	Mutes or leaves the low frequency band sound.
MidMixSw (Anti-phase Middle Mix Switch)	On, Off	Mutes or leaves the middle frequency band sound.
LowLvl (Low Level)	-60- +4 dB	Increases or decreases frequency bands in the low frequency band.
MidLvl (Middle Level)	-60- +4 dB	Increases or decreases frequency bands in the middle frequency band.
HiLvl (High Level)	-60- +4 dB	Increases or decreases frequency bands in the High frequency band.



Dual Compressor/Limiter

Compressors suppress signals at High levels. Limiter is used to control excessive input. Each of the above is used to prevent sound distortion or to control dynamics.

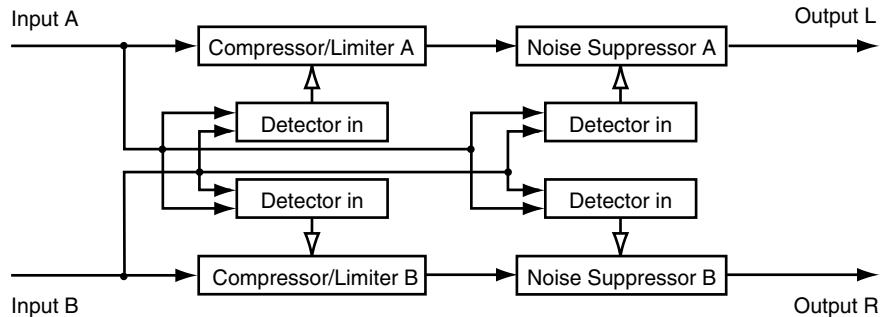

NOTE

Input A is input into the L-channel side of the effect. Therefore, it is required to insert and connect "Lch" of the effect to the channel handling Input A. Similarly, Input B is input into the R-channel side of the effect. Insert and connect "Rch" of the effect to the channel handling Input B.

Difference between Compressor and Limiter

Behaviors of Compressor and Limiter are very similar. Both of them compress the entire output signals if input signals exceed a certain level (threshold level), according to the input level.

Compressor automatically drops the amplitude to suppress all levels in the exceeding section. Limiter suppresses only the maximum level of input signals.

Using as Limiter

Threshold Level (Thresh):	Relatively High
Ratio (Ratio):	100:1
Attack Time (Attack):	Relatively short
Release Time (Release):	Relatively short

Using as Compressor

Threshold Level (Thresh):	A level that does not cause distortion of output sounds.
Ratio (Ratio):	1.5:1, 2:1, 4:1
Attack Time (Attack):	Adjusted according to the input sound type.
Release Time (Release):	Adjusted according to the input sound type.

Parameter (full name)	Setting	Function
CmpA, CmpB		
(Compressor):	Compresses the entire output signals when the input volume has exceeded a preset value.	
(Limiter):	Suppresses the volume of the section where the input volume has exceeded the preset value.	
Sw (Switch)	On, Off	Turns the compressor/limiter on or off.
Thresh (Threshold Level)	-60 - 0 dB	Sets the level at which the compressor/limiter starts taking effect.
Ratio (Ratio)	1.5:1, 2:1, 4:1, 100:1	Sets the compression ratio applied when threshold level (Thresh) is exceeded.
Attack (Attack Time)	0–100	Sets the time from when the input level exceeds the threshold level to when the effect begins to apply.
Release (Release Time)	0–100	Sets the time from when the input level drops below the threshold level to when the effect ceases to apply.
Level (Output Level)	-60–12 dB	Sets the volume of the compressor/limiter sound.
Detect (Detect In)	A, B, Link	Selects Input A or B for controlling compressor/limiter. Set this to “Link” for controlling by the input at a greater level.
NS (Noise Suppressor): Mutes noise in the silent mode.		
Sw (Switch)	On, Off	Turns the noise suppressor on or off.
Thresh (Threshold)	0–100	Sets the level to start muting noise.
Release (Release)	0–100	Sets the time over which the volume will drop to 0 after the noise starts being muted.
Detect (Detect In)	A, B, Link	Selects the input (Input A/Input B) for controlling Noise Suppressor. Set this to “Link” for controlling by the input at a greater level.

Algorithm List

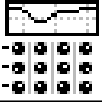

Parametric Equalizer (4-Band Parametric Equalizer)

This is an equalizer that can freely change the cutoff frequency or the band width (Q). With this equalizer, you can create sounds with subtlety.

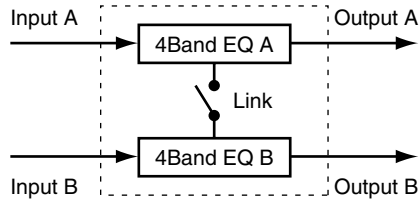

Cutting noise.

4-Band Parametric Equalizer can freely change the cutoff frequency or the band width (Q) at four points, that is, in the High, High middle, low middle and low frequency bands.

Capitalizing on this feature, you can precisely capture the point where any noise or howling is occurring. To find such point, the first step is to increase the gain for easier identification of sound variation and move the cutoff frequency little by little. Then, perform filtering by sharpening “Q.”

Controlling Channels A and B separately

Setting Link On enables simultaneous control on the 4-Band Parametric Equalizer via Channel B according to the settings on the Channel A side. To control Channels A and B separately, turn Link off.

Parameter (full name)	Setting	Function
Lnk (Link): Makes Channel B follow the settings for Channel A.		
Link (Link Switch)	On, Off	Specifies if Channel B follows or does not follow the settings for Channel A.
PEQA, PEQB (4 Band Parametric Equalizer): Parametric equalizer with four bands.		
Sw (Switch)	On, Off	Turns the parametric equalizer on or off.
Low Gain (Low Gain)	-12– +12 dB	Sets the boost/cut amount in the low frequency band.
Low Freq (Low Frequency)	20 - 2000 Hz	Sets the center frequency in the low frequency band.
Low Q (Low Q)	0.3–10	Sets the width of the area around the low frequency that will be affected by the gain settings. *1
Low Type	Shlv, Peak	Sets the type of the low frequency band equalizer (Shlving type or peaking type).
LowMid Gain (Low Middle Gain)	-12– +12 dB	Sets the boost/cut amount in the low middle frequency band.
LoMid Freq (Low Middle Frequency)	200–8000 Hz	Sets the center frequency in the low middle frequency band.
LoMid Q (Low Middle Q)	0.3–10	Sets the width of the area around the Low middle frequency that will be affected by the gain settings.
HiMid Gain (High Middle Gain)	-12– +12 dB	Sets the boost/cut amount in the High middle frequency band.
HiMid Freq (High Middle Frequency)	200–8000 Hz	Sets the center frequency in the High middle frequency band.
HiMid Q (High Middle Q)	0.3–10	Sets the width of the area around the High middle frequency that will be affected by the gain settings.
Hi Type (High Type)	Shlv, Peak	Sets the type of the High frequency band equalizer (Shlving type or peaking type).
High Gain (High Gain)	-12– +12 dB	Sets the boost/cut amount in the High frequency band.
High Freq (High Frequency)	1.4–20.0 kHz	Sets the center frequency in the High frequency band.
High Q (High Q)	0.3–10	Sets the width of the area around the High frequency that will be affected by the gain settings. *1
InputG (Input Gain)	-60– +12 dB	Sets the overall volume before passing through the equalizer.
Level (Output Level)	-60– +12 dB	Sets the overall volume after passing through the equalizer.

NOTE

*1: If Low Type (Low Type) or High Type (High Type) is set to “Shlv (Shlving Type),” the setting for Lo Q or High Q is invalid.

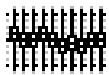

Graphic Equalizer (10-Band Graphic Equalizer)

This Equalizer sets the boost/cut amount by each segment of the frequency divided into ten bands. In performing PA at a live, this feature is useful to prevent howling by cutting the site-specific resonance frequency.

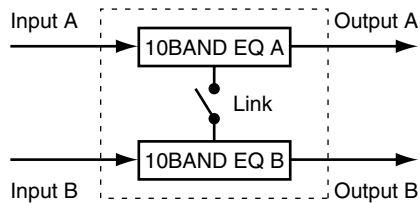

Preventing howling

While performing PA at a live, follow the steps below to prevent howling. First, identify the site-specific resonance frequency to cut its gain.

Controlling Channels A and B separately

Setting Link On enables simultaneous control on the 10-Band Parametric Equalizer via Channel B according to the settings on the Channel A side.

To control Channels A and B separately, turn Link Off.

Parameter (full name)	Setting	Function
Lnk (Link): Makes Channel B follow the settings for Channel A.		
Link (Link Switch)	On, Off	Specifies if Channel B follows or does not follow the settings for Channel A.
GEQA, GEQB (10-Band Graphic Equalizer): Models a 10-band graphic equalizer.		
Sw (Switch)	On, Off	Turns the parametric equalizer on or off.
31.2 – 16 k (Gain)	-12– +12 dB	Sets the boost/cut amount at the respective frequencies.
InputG (Input Gain)	-60– +12 dB	Sets the overall volume before passing through the equalizer.
Level (Output Level)	-60– +12 dB	Sets the overall volume after passing through the equalizer.



Hum Canceler

Eliminates annoying hum (or “surge” sounding “boon”).

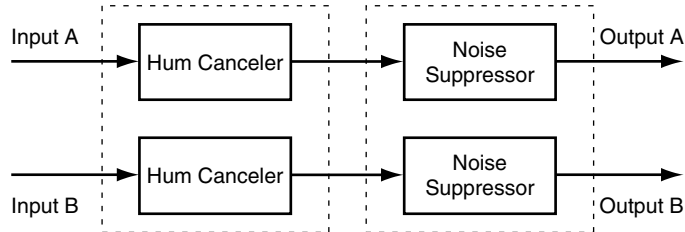

Removing hum

Hum is a noise with a certain low frequency. Hum is generated mostly due to ingress of part of alternating current into signals as alternating current is converted into direct current in the power circuit. Sets Frequency (Freq) to that according with the frequency of the power source (50 Hz/60 Hz), and hum with that frequency and frequencies of its multiples can be removed.

Range Lo and Range Hi can be used to specify the frequency band of hum to be removed.

Parameter (full name)	Setting	Function
HC (Hum Canceler):	Removes hum.	
Sw (Switch)	On, Off	Turns the hum canceler on or off.
Freq (Frequency)	20.0–800.0 Hz	Sets the frequency of hum to be removed.
Width (Width)	10–40%	Sets the width of the filter which will remove the hum.
Depth (Depth)	0–100	Sets the depth of the filter which will remove the hum.
Thresh (Threshold)	0–100	Sets the level at which the hum is to be removed.
RangeLo (Range Low)	Unlimit, 20 - 2000 Hz	Sets the lower limit of the frequency of hum to be removed. *1
RangeHi (Range High)	1.0 - 20.0 kHz, Unlimit	Sets the upper limit of the frequency of hum to be removed. *2
NS (Noise Suppressor):	Mutes noise in the silent mode.	
Sw (Switch)	On, Off	Turns the noise suppressor on or off.
Thresh (Threshold)	0–100	Sets the level to start muting noise.
Release (Release)	0–100	Sets the time over which the volume will drop to 0 after the noise starts being muted.



*1: Setting to “Unlimit” means that the frequency that can be played back on this unit is the lower limit.

*2: Setting to “Unlimit” means that the frequency that can be played back on this unit is the upper limit.

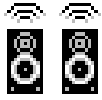

Stereo Multi

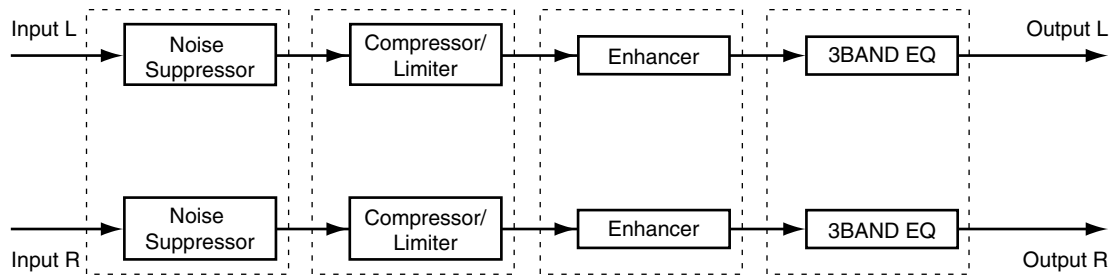

Parameter (full name)	Setting	Function
-----------------------	---------	----------

NS (Noise Suppressor): Mutes noise in the silent mode.

Sw (Switch)	On, Off	Turns the noise suppressor on or off.
Thresh (Threshold)	0–100	Sets the level to start muting noise.
Release (Release)	0–100	Sets the time over which the volume will drop to 0 after the noise starts being muted.

Cmp (Compressor/Limiter): Compresses the entire output signals when the input volume exceeds a specified value.

Sw (Switch)	On, Off	Turns the compressor on or off.
Thresh (Threshold Level)	-60–0 dB	Sets the level at which the compressor starts taking effect.
Ratio (Ratio)	1.5:1, 2:1, 4:1, 100:1	Sets the compression ratio applied when the threshold level is exceeded.
Attack (Attack Time)	0–100	Sets the time from when the input level exceeds the threshold level to when the effect begins to apply.
Release (Release Time)	0–100	Sets the time from when the input level drops below the threshold level to when the effect ceases to apply.
Level (Output Level)	-60–12 dB	Sets the volume of the compressor sound.

Enh (Enhancer): Accentuates the sound and push the sound forward.

Sw (Switch)	On, Off	Turns the enhancer on or off.
Sens (Sense)	0–100	Sets the degree of the enhancer effect desired.
Freq (Frequency)	1.0–10.0 kHz	Sets the frequency at which the enhancer effect starts working.
MixLvl (Mix Level)	0–100	Sets the amount of the enhancer sound should be mixed into the direct sound.
Level (Level)	0–100	Sets the volume of the enhancer sound.

→ Continued...

Algorithm List

EQ (Equalizer)

Sw (Switch)	On, Off	Turns the equalizer on or off.
Low Gain (Low Gain)	-12– +12 dB	Sets the boost/cut amount in the low frequency band.
Low Freq (Low Frequency)	20 - 2000 Hz	Sets the center frequency in the low frequency band.
Low Q	0.3–10.0	Sets the width of the area around the low frequency that will be affected by the gain settings.1 *1
Low Type	Shlv, Peak	Sets the type of the low frequency band equalizer (Shlving type or peaking type).
Mid Gain (Middle Gain)	-12– +12 dB	Sets the boost/cut amount in the middle frequency band.
Mid Freq (Middle Frequency)	200–8000 Hz	Sets the center frequency in the middle frequency band.
Mid Q (Middle Q)	0.3–10.0	Sets the width of the area around the middle frequency that will be affected by the gain settings.
High Gain	-12– +12 dB	Sets the boost/cut amount in the High frequency band.
High Freq (High Frequency)	1.4–20.0 kHz	Sets the center frequency in the High frequency band.
High Q	0.3–10.0	Sets the width of the area around the High frequency that will be affected by the gain settings.1 *1
Hi Type (High Type)	Shlv, Peak	Sets the type of the High frequency band equalizer (Shlving type or peaking type).
Level (Output Level)	0–100	Sets the volume after passing through the equalizer.

NOTE

*1: If Low Type (Lo Type) or High Type (Hi Type) is set to “Shlv (Shlving Type),” the setting for Lo Q or High Q is invalid.

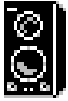

Speaker Modeling

Models a variety of speaker characteristics ranging from those of High-end professional monitor speakers used as the standard at studios around the world to those of speakers of small-sized TV sets and portable radios.

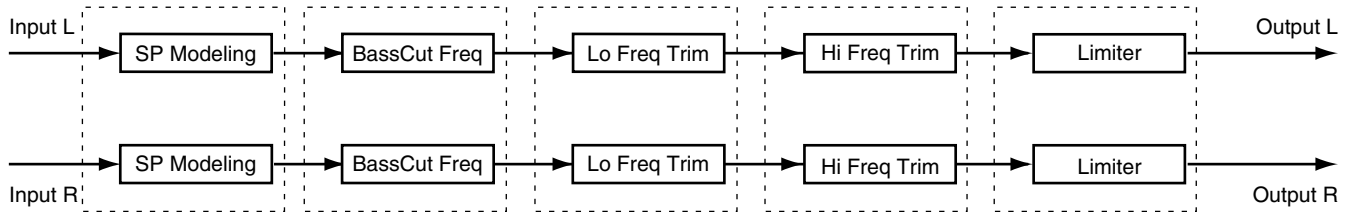

NOTE

- Speaker Modeling is adjusted so that its optimal effect is achieved when a Roland Powered Monitor DS-90 is used in digital connection. Its effect may not be fully achieved with other types of speakers.
- “Mic Modeling” cannot be used on the projects with 64kHz or higher sampling rate.

Speaker types applicable for modeling

The characteristics of the following types of speakers can be modeled. Set the desired type for Model.

THRU:	No modeling is to be performed.
Super FLAT:	DS-90 is corrected by modeling to produce wider-range and untwisted sounds.
Powered GenBlk:	Typical model of powered monitor (two-way type, the woofer diameter = 170 mm (6-1/2 inches))
Powered E-Bas:	Powered monitor characterized in delightful sound quality
Powered Mack:	Powered monitor characterized in well-extended low frequency band sounds
Small Cube:	Small-sized full-range speaker widely used in recording studios
White Cone:	Enclosed-type two-way speaker widely used in recording studios, characterized in white woofers.
White C +tissue:	Mild sounds from “White Cone” Tweeter covered with tissue paper
Small Radio:	Pocket-type small-sized radio
Small TV:	Speaker attached to the 14-inch TV set
Boom Box:	Radio cassette recorder
BoomBox LoBoost:	Radio cassette recorder with the low frequency band enhanced

* Use “THRU” for clear comparison between sounds with and without modeling.

→ Continued...

Algorithm List

Parameter (full name)	Setting	Function
SpMod (Speaker Modeling): Selects the speaker subject to characteristics modeling.		
Sw (Switch)	Off, On	Turns the Speaker Modeling on or off.
Model (Model)	See the column on the previous page.	Specifies the speaker actually generating sounds.
Output Speakers (Output Speakers)	DS-90/DS-90A, DS-50A	
Phase (Phase)	NRM, INV	Sets the phase of the speaker. "NRM" for the same phase, and "INV" for the inverted phase.
BCut (Bass Cut Filter): Cuts off undesired low sounds such as pop noise.		
Sw (Switch)	On, Off	Turns the bass cut filter on or off.
Freq (Frequency)	Thru, 20 - 2000 Hz	Sets the frequency for cutting off undesired low frequency band sounds such as pop noise.
LFT (Low Frequency Trimmer): Adjusts the low frequency band sounds.		
Sw (Switch)	On, Off	Turns the low frequency trimmer on or off.
Gain (Gain)	-12- +12dB	Sets the boost/cut amount.
Freq (Frequency)	20-2000 Hz	Sets the center frequency of the trimmer.
HFT (High Frequency Trimmer): Adjusts the High frequency band sounds.		
Sw (Switch)	On, Off	Turns the High frequency trimmer on or off.
Gain (Gain)	-12- +12dB	Sets the boost/cut amount.
Freq (Frequency)	1.0-20.0 kHz	Sets the center frequency.
Lmt (Limiter): Prevents distortion by suppressing signals at High levels.		
Sw (Switch)	On, Off	Turns the limiter on or off.
Thresh (Threshold)	-60-0 dB	Sets the volume at which the limiter starts working.
Release (Release)	0-100	Sets the time from when the input level drops below the threshold level to when the effect ceases to apply.
Level (Level)	-60- +24 dB	Sets the volume after passing through the limiter.



Mastering Tool Kit

This Kit is a compressor that splits sounds into different frequency band to unify their volumes. With this feature, you can perform mastering at the optimized level when mixing down into an MD or a CD or when producing your original audio CD using the CD-R disk.

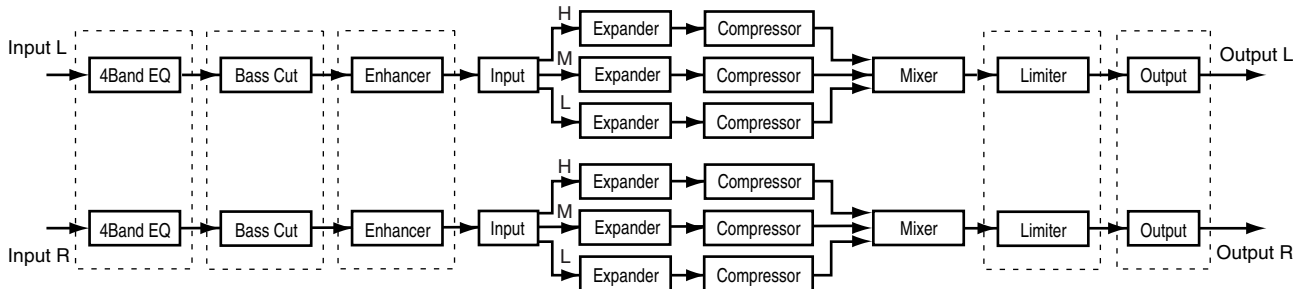

Effect of “Detect Time” under Input

With ordinary compressors, a moment of delay occurs to suppress a level over instance after it has been detected. With this algorithm, this problem is bypassed by using the input sound only for level detection and adding a specified length of delay to the sound for processing and output. “Detect Time” under Input is the setting of the delay time for this purpose. Note that supplying Detect Time causes time difference between input and output of audio signals, requiring due considerations if used for operations other than mastering (ex. channel insertion).

Splitting into frequency bands

To split into High, middle and low frequency bands, Low Split Point (LoSplit Point) and High Split Point (HiSplit Point) under Input are used to specify frequencies.

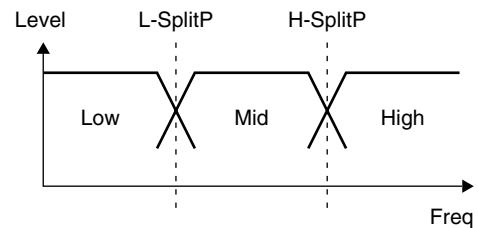

Parameter (full name)	Setting	Function
-----------------------	---------	----------

EQ (Equalizer)

Sw (Switch)	On, Off	Turns the equalizer on or off.
InputG (Input Gain)	-24- +12 dB	Sets the overall volume before passing through the equalizer.
Low Gain (Low Gain)	-12- +12 dB	Sets the boost/cut amount in the low frequency band.
Low Freq (Low Frequency)	20-2000 Hz	Sets the center frequency in the low frequency band.
Low Q (Low Q)	0.3-16.0	Sets the width of the area around the low frequency that will be affected by the gain settings. *1
Low Type	Shlv, Peak	Sets the type of the low frequency band equalizer (Shlving type or peaking type).
LoMid Gain (Low Middle Gain)	-12- +12 dB	Sets the boost/cut amount in the low middle frequency band.
LoMid Freq (Low Middle Frequency)	20-8000 Hz	Sets the center frequency in the low middle frequency band.
LoMid Q (Low Middle Q)	0.3-16.0	Sets the width of the area around the low middle frequency that will be affected by the gain settings.
HiMid Gain (High Middle Gain)	-12- +12 dB	Sets the boost/cut amount in the High frequency band.
HiMid Freq (High Middle Frequency)	20-8000 Hz	Sets the center frequency in the High middle frequency band.

→ Continued...

Algorithm List

HiMid Q (High Middle Q)	0.3–16.0	Sets the width of the area around the High middle frequency that will be affected by the gain settings.
High Gain (High Gain)	-12– +12 dB	Sets the boost/cut amount in the High frequency band.
High Freq (High Frequency)	1.40–20.0 kHz	Sets the center frequency in the High frequency band.
High Q (High Q)	0.3–16.0	Sets the width of the area around the High frequency that will be affected by the gain settings. *1
Hi Type (High Type)	Shlv, Peak	Sets the type of the High frequency band equalizer (Shlving type or peaking type).
Level (Level)	-24– +12 dB	Sets the overall volume after passing through the equalizer.

BCut (Bass Cut Filter): Cuts off undesired low frequency band sounds such as pop noise.

Sw (Switch)	On, Off	Turns the bass cut filter on or off.
Freq (Frequency)	Thru, 20 - 2000 Hz	Sets the frequency for cutting off undesired low frequency band sounds such as pop noise.

Enh (Enhancer): Accentuates the sound and push the sound forward.

Sw (Switch)	On, Off	Turns the enhancer on or off.
Sens (Sensitivity)	0–100	Sets the degree of the enhancer effect desired.
Freq (Frequency)	1.00–10.0 kHz	Sets the frequency at which the enhancer effect starts working.
MixLvl (Mix Level)	-24– +12dB	Set the amount of the enhancer sound to be added to the direct sound.

In (Input): Splits the direct sound into three frequency bands, that is, low, middle and High frequency bands.

InGain (Input Gain)	-24– +12dB	Sets the overall volume before entering expander/compressor.
D-Time (Detect Time)	0–10 ms	Sets the length of delay to add to the direct sound input.
Split Point Low (Low Split Point)	20–800 Hz	Sets the frequency at which the direct sound is split into three bands (on the low frequency band side).
Split Point High (High Split Point)	1.60–16.0 kHz	Sets the frequency at which the direct sound is split into three bands (on the High frequency band side).

Exp (Expander): Expands the dynamic range at a certain ratio.

Sw (Switch)	On, Off	Turns the expander on or off.
Low Thre (Low Threshold)	-80–0 dB	Sets the volume at which the expander for the low frequency band starts working.
Low Ratio (Low Raito)	1:1.0–1:16, 1:INF	Sets the ratio at which the output in the low frequency band is increased when the input level has exceeded below the low threshold level.
Low Atck (Low Attack)	0–100 ms	Sets the time until when the low frequency band expander starts working after the input level dropps below the low threshold level.
Low Rel (Low Release)	50 ms–5.000 s	Sets the time until when the High frequency band expander stops working after the input level exceeds the low threshold level.
Mid Thre (Middle Threshold)	-80–0 dB	Sets the volume at which the expander for the middle frequency band starts working.
Mid Ratio (Middle Ratio)	1:1.0–1:16, 1:INF	Sets the ratio at which the output in the middle frequency band is increased when the input level has exceeded below the middle threshold level.
Mid Atck (Middle Attack)	0–100 ms	Sets the time until when the middle frequency band expander starts working after the input level dropps below the middle threshold level.
Mid Rel (Middle Release)	50 ms–5.000 s	Sets the time until when the middle frequency band expander stops working after the input level exceeds the middle threshold level.
High Thre (High Threshold)	-80–0 dB	Sets the volume at which the expander for the High frequency band starts working.
High Ratio (High Ratio)	1:1.0–1:16, 1:INF	Sets the ratio at which the output in the High frequency band is increased when the input level has exceeded below the High threshold level.
High Atck (High Attack)	0–100 ms	Sets the time until when the High frequency band expander starts working after the input level dropps below the High threshold level.
High Rel (High Release)	50 ms–5.000 s	Sets the time until when the High frequency band expander stops working after the input level exceeds the High threshold level.

Cmp (Compressor): Compresses the entire output signals when the input volume exceeds a specified value.

SW (Switch)	On, Off	Turns the compressor on or off.
Low Thre (Low Threshold)	-24–0 dB	Sets the volume at which the compressor for the low frequency band starts working.
Low Ratio (Low Raito)	1:1.0–1:16, 1:INF	Sets the ratio at which the output in the low frequency band is suppressed when the input level has exceeded the low threshold level.
Low Atck (Low Attack)	0–100 ms	Sets the time until when the low frequency band compressor starts working after the input level has exceeded the low threshold level.
Low Rel (Low Release)	50 ms–5.000 s	Sets the time until when the low frequency band compressor stops working after the input level has dropped below the low threshold level.
Mid Thre (Middle Threshold)	-24–0 dB	Sets the volume at which the compressor in the middle frequency band starts working.
Mid Ratio (Middle Ratio)	1:1.0–1:16, 1:INF	Sets the ratio at which the output in the middle frequency band is suppressed when the input level has exceeded the middle threshold level.
Mid Atck (Middle Attack)	0–100 ms	Sets the time until when the middle frequency band compressor starts working after the input level has exceeded the middle threshold level.
Mid Rel (Middle Release)	50 ms–5.000 s	Sets the time until when the middle frequency band compressor stops working after the input level has dropped below the middle threshold level.
High Thre (High Threshold)	-24–0 dB	Sets the volume at which the compressor for the High frequency band starts working.
High Raito (High Ratio)	1:1.0–1:16, 1:INF	Sets the ratio at which the output in the High frequency band is suppressed when the input level has exceeded the High threshold level.
High Atck (High Attack)	0–100 ms	Sets the time until when the High frequency band compressor starts working after the input level has exceeded the High threshold level.
High Rel (High Release)	50 ms–5.000 s	Sets the time until when the High frequency band compressor stops working after the input level has dropped below the High threshold level.

Mix (Mixer): Adjusts the volume by frequency band.

Low Level (Low Level)	-80– +6 dB	Sets the volume in the low frequency band after passing through the expander and compressor.
Mid Level (Middle Level)	-80– +6 dB	Sets the middle frequency band volume after passing through the expander and compressor.
High Level (High Level)	-80– +6 dB	Sets the volume in the High frequency band after passing through the expander and compressor.

Lmt (Limiter): Prevents distortion by suppressing signals at High levels.

Sw (Switch)	On, Off	Turns the limiter on or off.
Thresh (Threshold)	-24–0 dB	Sets the volume at which the limiter starts working.
Attack (Attack)	0–100 ms	Sets the time until when the limiter starts working after the input level has exceeded threshold level.
Release (Release)	50 ms–5.000 s	Sets the time until when the limiter stops working after the input level drops below the threshold level.

Out (Output): Provides settings concerning overall output.

SoftClip (Soft Clip)	On, Off	Suppresses conspicuous distortion that may occur when the effect of compressor/limiter has been applied excessively.
Level (Level)	-80– +6 dB	Sets the overall volume after passing through the limiter.



*1: If Low Type (Lo Type) or High Type (Hi Type) is set to “Shlv (Shlving Type),” the setting for Lo Q or High Q is invalid.

- With Compressor, the level is automatically adjusted to the optimal with the settings for Threshold (Thres) and Raito (Ratio). Setting Attack (Atck) to a relatively long time may cause distortion. For this reason, a margin of -6 dB is provided. Adjust the Mixer (Mix) level as required.
- “Mastering Tool Kit” cannot be used on EFFECT2 and 4 (even-numbered effects).
- When “Mastering Tool Kit” is used on EFFECT1 and 3 (odd-numbered effects), EFFECT2 and 4 (even-numbered effects) cannot be used.
- “Mastering Tool Kit” cannot be used on the projects with 64kHz or higher sampling rate.

MIDI Implementation

Model VS-2400CD Version 1.00 Oct. 2, 2002

1. TRANSMITTED DATA AND RECOGNIZED RECEIVE DATA

■Channel Voice message

●Note On/Off

When "METRONOME OUT" in the UTILITY condition METRONOME screen is OUT, MIDI note number/velocity of MIDI channel number which is assigned to the Metronome is transmitted. Received when the effect patch Voice Transformer effect (algorithm 27) is selected (FX1 or 3) and MIDI CONTROL Sw is "On".

```

Status   Second   Third
-----
 9nH      mmH      llH

n = MIDI Channel No.: 0H - FH (ch.1-ch.16) (*1)
                    : 0H - 3H (ch.1-ch.4) (*2)
mm = Note No.       : 0CH - 7FH (12 - 127) (*1)
                    : 24H - 54H (38 - 64) (*2)
ll = Velocity       : 01H - 7FH (1 - 127) / 00H = NOTE OFF
  
```

(*1) Only when transmitting Metronome.

(*2) Only when receiving with MIDI CONTROL Sw of Voice Transformer is On.

```

n = 0,2 (FX1,3) : Voice Transformer: Chromatic Pitch
mm = 24H - 54H (C2 - C6)
ll = ignored
n = 1,3 (FX1,3): Voice Transformer: Chromatic Formant
mm = 24H - 3CH (C2 - C4)
ll = Ignored
  
```

●Polyphonic Key Pressure

Transmits the level meter value of VS-2400CD according to the value of DISPLAY SECTION (MIDI ch. is fixed to 16.) Ignored when received.

```

Status   Second   Third
-----
 AFH      mmH      llH

mm = Note No.       : 00H - 5BH (0 - 91)
ll = Level Meter Value : 00H - 7FH (0 - 127)
  
```

Level meter and NOTE No.								
Level Meter Target	Analog Input	Digital Input	Input Mixer	Track Mixer	FX Return	AUX/DIR	Analog Output	Digital Output
Note Number	Level Meter Channel	Level Meter Channel	Level Meter Channel	Level Meter Channel	Level Meter Channel	Level Meter Channel	Level Meter Channel	Level Meter Channel
0	Input 1	R-BUS 1	Input 1	Track 1	FxRtn 1L	AUX 1	Output 1	R-BUS 1
1	Input 2	R-BUS 2	Input 2	Track 2	FxRtn 1R	AUX 2	Output 2	R-BUS 2
2	Input 3	R-BUS 3	Input 3	Track 3	FxRtn 2L	AUX 3	Output 3	R-BUS 3
3	Input 4	R-BUS 4	Input 4	Track 4	FxRtn 2R	AUX 4	Output 4	R-BUS 4
4	Input 5	R-BUS 5	Input 5	Track 5	FxRtn 3L	AUX 5	Output 5	R-BUS 5
5	Input 6	R-BUS 6	Input 6	Track 6	FxRtn 3R	AUX 6	Output 6	R-BUS 6
6	Input 7	R-BUS 7	Input 7	Track 7	FxRtn 4L	AUX 7	Output 7	R-BUS 7
7	Input 8	R-BUS 8	Input 8	Track 8	FxRtn 4R	AUX 8	Output 8	R-BUS 8
8	-	-	Input 9	Track 9	-	DIR 1	-	-
9	-	-	Input 10	Track 10	-	DIR 2	-	-
10	-	-	Input 11	Track 11	-	DIR 3	-	-
11	-	-	Input 12	Track 12	-	DIR 4	-	-
12	-	-	Input 13	Track 13	-	DIR 5	-	-
13	-	-	Input 14	Track 14	-	DIR 6	-	-
14	-	-	Input 15	Track 15	-	DIR 7	-	-
15	-	-	Input 16	Track 16	-	DIR 8	-	-
16	-	D.In L	-	Track 17	-	-	-	D.Out L
17	-	D.In R	-	Track 18	-	-	-	D.Out R
18	-	-	-	Track 19	-	-	-	-
19	-	-	-	Track 20	-	-	-	-
20	-	-	-	Track 21	-	-	-	-
21	-	-	-	Track 22	-	-	-	-
22	-	-	-	Track 23	-	-	-	-
23	-	-	-	Track 24	-	-	-	-
24	-	-	-	-	-	-	-	-
25	-	-	-	-	-	-	-	-
26	-	-	-	-	-	-	-	-
27	-	-	-	-	-	-	-	-
28	-	-	-	-	-	-	-	-
29	-	-	-	-	-	-	-	-
30	-	-	-	-	-	-	-	-
31	-	-	-	-	-	-	-	-
32	MONITOR L	MONITOR L	MONITOR L	MONITOR L	MONITOR L	MONITOR L	MONITOR L	MONITOR L
33	MONITOR R	MONITOR R	MONITOR R	MONITOR R	MONITOR R	MONITOR R	MONITOR R	MONITOR R
34	MASTER L	MASTER L	MASTER L	MASTER L	MASTER L	MASTER L	MASTER L	MASTER L
35	MASTER R	MASTER R	MASTER R	MASTER R	MASTER R	MASTER R	MASTER R	MASTER R
36	-	-	-	-	-	-	-	-
37	-	-	-	-	-	-	-	-
38	-	-	-	-	-	-	-	-
39	-	-	-	-	-	-	-	-
40	Channel Status 1ch	0:Off, 1:Play, 2:Bounce/Source, 3:Rec						
41	Channel Status 2ch	0:Off, 1:Play, 2:Bounce/Source, 3:Rec						
42	Channel Status 3ch	0:Off, 1:Play, 2:Bounce/Source, 3:Rec						
43	Channel Status 4ch	0:Off, 1:Play, 2:Bounce/Source, 3:Rec						
44	Channel Status 5ch	0:Off, 1:Play, 2:Bounce/Source, 3:Rec						
45	Channel Status 6ch	0:Off, 1:Play, 2:Bounce/Source, 3:Rec						
46	Channel Status 7ch	0:Off, 1:Play, 2:Bounce/Source, 3:Rec						
47	Channel Status 8ch	0:Off, 1:Play, 2:Bounce/Source, 3:Rec						
48	Channel Status 9ch	0:Off, 1:Play, 2:Bounce/Source, 3:Rec						
49	Channel Status 10ch	0:Off, 1:Play, 2:Bounce/Source, 3:Rec						
50	Channel Status 11ch	0:Off, 1:Play, 2:Bounce/Source, 3:Rec						
51	Channel Status 12ch	0:Off, 1:Play, 2:Bounce/Source, 3:Rec						
52	Channel Status 13ch	0:Off, 1:Play, 2:Bounce/Source, 3:Rec						
53	Channel Status 14ch	0:Off, 1:Play, 2:Bounce/Source, 3:Rec						
54	Channel Status 15ch	0:Off, 1:Play, 2:Bounce/Source, 3:Rec						
55	Channel Status 16ch	0:Off, 1:Play, 2:Bounce/Source, 3:Rec						
56	Channel Status 17ch	0:Off, 1:Play, 2:Bounce/Source, 3:Rec						
57	Channel Status 18ch	0:Off, 1:Play, 2:Bounce/Source, 3:Rec						
58	Channel Status 19ch	0:Off, 1:Play, 2:Bounce/Source, 3:Rec						

```

59 Channel Status 20ch 0:Off, 1:Play, 2:Bounce/Source, 3:Rec
60 Channel Status 21ch 0:Off, 1:Play, 2:Bounce/Source, 3:Rec
61 Channel Status 22ch 0:Off, 1:Play, 2:Bounce/Source, 3:Rec
62 Channel Status 23ch 0:Off, 1:Play, 2:Bounce/Source, 3:Rec
63 Channel Status 24ch 0:Off, 1:Play, 2:Bounce/Source, 3:Rec
64
65
66
67
68
69
70
71
72 SCALE 0:X1, 1:X1/2
73 LOCATION 1:PRE FADER, 2:POST FADER
74
75
76
77
78 8SEG.MODE 0:Measure/Beat, 1:Time Code, 2:Clock+Scene
79 OVER RANGE 0:0db
80 MASTER MUTE 0:OFF, 1:ON
81 PEAK HOLD TIME 0:OFF
82
83
84
85
86
87
88 CLOCK HOUR(*1) / MEAS. MSB (*2)
89 CLOCK MIN.(*1) / MEAS. LSB (*2)
90 CLOCK SEC.(*1) / BEAT (*2)
91 SCENE (*1) / TICK (*2)
92

```

(*1) When 8SEG.MODE is 2.
 (*2) When 8SEG.MODE is 0.

```

-----
Level Meter Value and Level
-----
Value Level
0 0dB
1 -1dB
2 -2dB
:
127 -Infinite

```

●Control Change

The controller numbers that have been set by means of the FADER parameters in the Utility menus V.FADER/USER screen are transmitted when the faders are operated while the faders are in V.Fader mode.

If V-LINK function is enable, see "5.V-LINK".

Status	Second	Third
-----	-----	-----
BnH	mmH	llH
n = MIDI Channel No. : 0H - FH (ch.1-ch.16)		
mm = Controller No. : 00H - 77H (0 - 119)		
ll = Controller Value : 00H - 7FH (0 - 127)		

Parameters on the Mixer section can be received and transmitted by the control change messages when MIXER CONTROL TYPE in the UTILITY-MIDI screen is set to C.C.

Status	Second	Third
-----	-----	-----
BnH	mmH	llH
n = MIDI Channel No. : 0H - FH (ch.1-ch.16: see below)		
mm = Mixer Parameter No. : (see below)		
ll = Mixer Parameter Value. : 00H - 7FH (0 - 127) (*1)		

```

-----
Mixer Parameter and MIDI Channel/Control Change No.
-----
INPUT MIX CH. 1 2 3 4 5 6 7 8 9 10 11 12 13 14 15 16
MIDI ch. -> 1 2 3 4 5 6 7 8 9 10 11 12 13 14 15 16
-----
FADER LEVEL 7 -> -> -> -> -> -> -> -> -> -> -> -> -> -> -> ->
PAN 10 -> -> -> -> -> -> -> -> -> -> -> -> -> -> -> ->
AUX1 SEND LEVEL 12 -> -> -> -> -> -> -> -> -> -> -> -> -> -> ->
AUX2 SEND LEVEL 13 -> -> -> -> -> -> -> -> -> -> -> -> -> -> ->
AUX3 SEND LEVEL 14 -> -> -> -> -> -> -> -> -> -> -> -> -> -> ->
AUX4 SEND LEVEL 15 -> -> -> -> -> -> -> -> -> -> -> -> -> -> ->
AUX5 SEND LEVEL 16 -> -> -> -> -> -> -> -> -> -> -> -> -> -> ->
AUX6 SEND LEVEL 17 -> -> -> -> -> -> -> -> -> -> -> -> -> -> ->
AUX7 SEND LEVEL 18 -> -> -> -> -> -> -> -> -> -> -> -> -> -> ->
AUX8 SEND LEVEL 19 -> -> -> -> -> -> -> -> -> -> -> -> -> -> ->
AUX1/2 SEND PAN 20 -> -> -> -> -> -> -> -> -> -> -> -> -> -> ->
AUX3/4 SEND PAN 21 -> -> -> -> -> -> -> -> -> -> -> -> -> -> ->
AUX5/6 SEND PAN 22 -> -> -> -> -> -> -> -> -> -> -> -> -> -> ->
AUX7/8 SEND PAN 23 -> -> -> -> -> -> -> -> -> -> -> -> -> -> ->
OFFSET FADER LEVEL 24 -> -> -> -> -> -> -> -> -> -> -> -> -> -> ->
OFFSET PAN 25 -> -> -> -> -> -> -> -> -> -> -> -> -> -> -> ->
-----

```

```

TRACK MIX CH. 1 2 3 4 5 6 7 8 9 10 11 12 13 14 15 16
MIDI ch. -> 1 2 3 4 5 6 7 8 9 10 11 12 13 14 15 16
-----
TRACK STATUS(*2) 35 -> -> -> -> -> -> -> -> -> -> -> -> -> -> ->
FADER LEVEL 39 -> -> -> -> -> -> -> -> -> -> -> -> -> -> ->
PAN 42 -> -> -> -> -> -> -> -> -> -> -> -> -> -> ->
AUX1 SEND LEVEL 44 -> -> -> -> -> -> -> -> -> -> -> -> -> -> ->
AUX2 SEND LEVEL 45 -> -> -> -> -> -> -> -> -> -> -> -> -> -> ->
AUX3 SEND LEVEL 46 -> -> -> -> -> -> -> -> -> -> -> -> -> -> ->
AUX4 SEND LEVEL 47 -> -> -> -> -> -> -> -> -> -> -> -> -> -> ->
AUX5 SEND LEVEL 48 -> -> -> -> -> -> -> -> -> -> -> -> -> -> ->
AUX6 SEND LEVEL 49 -> -> -> -> -> -> -> -> -> -> -> -> -> -> ->
AUX7 SEND LEVEL 50 -> -> -> -> -> -> -> -> -> -> -> -> -> -> ->
AUX8 SEND LEVEL 51 -> -> -> -> -> -> -> -> -> -> -> -> -> -> ->
AUX1/2 SEND PAN 52 -> -> -> -> -> -> -> -> -> -> -> -> -> -> ->
AUX3/4 SEND PAN 53 -> -> -> -> -> -> -> -> -> -> -> -> -> -> ->
AUX5/6 SEND PAN 54 -> -> -> -> -> -> -> -> -> -> -> -> -> -> ->
AUX7/8 SEND PAN 55 -> -> -> -> -> -> -> -> -> -> -> -> -> -> ->
OFFSET FADER LEVEL 56 -> -> -> -> -> -> -> -> -> -> -> -> -> -> ->
OFFSET PAN 57 -> -> -> -> -> -> -> -> -> -> -> -> -> -> -> ->
-----

```

```

TRACK MIX CH. 17 18 19 20 21 22 23 24
MIDI ch. -> 9 10 11 12 13 14 15 16
-----
TRACK STATUS(*2) 67 -> -> -> -> -> -> -> ->
FADER LEVEL 71 -> -> -> -> -> -> -> ->
PAN 74 -> -> -> -> -> -> -> ->
AUX1 SEND LEVEL 76 -> -> -> -> -> -> -> ->
AUX2 SEND LEVEL 77 -> -> -> -> -> -> -> ->
AUX3 SEND LEVEL 78 -> -> -> -> -> -> -> ->
AUX4 SEND LEVEL 79 -> -> -> -> -> -> -> ->
AUX5 SEND LEVEL 80 -> -> -> -> -> -> -> ->
AUX6 SEND LEVEL 81 -> -> -> -> -> -> -> ->
AUX7 SEND LEVEL 82 -> -> -> -> -> -> -> ->
AUX8 SEND LEVEL 83 -> -> -> -> -> -> -> ->
AUX1/2 SEND PAN 84 -> -> -> -> -> -> -> ->
AUX3/4 SEND PAN 85 -> -> -> -> -> -> -> ->
AUX5/6 SEND PAN 86 -> -> -> -> -> -> -> ->
AUX7/8 SEND PAN 87 -> -> -> -> -> -> -> ->
OFFSET FADER LEVEL 88 -> -> -> -> -> -> -> ->
OFFSET PAN 89 -> -> -> -> -> -> -> ->
-----

```

```

RETURN MIX CH. 1 2 3 4
MIDI ch. -> 1 2 3 4
-----
FADER LEVEL 102 -> -> ->
BALANCE 103 -> -> ->
AUX1 SEND LEVEL 104 -> -> ->
AUX2 SEND LEVEL 105 -> -> ->
AUX3 SEND LEVEL 106 -> -> ->
AUX4 SEND LEVEL 107 -> -> ->
AUX5 SEND LEVEL 108 -> -> ->
AUX6 SEND LEVEL 109 -> -> ->
AUX7 SEND LEVEL 110 -> -> ->
AUX8 SEND LEVEL 111 -> -> ->
AUX1/2 SEND Bal 112 -> -> ->
AUX3/4 SEND Bal 113 -> -> ->
AUX5/6 SEND Bal 114 -> -> ->
AUX7/8 SEND Bal 115 -> -> ->
-----

```

```

MASTER BLOCK
MIDI ch.=14
DIR1 LEVEL 104
DIR2 LEVEL 105
DIR3 LEVEL 106
DIR4 LEVEL 107
DIR5 LEVEL 108
DIR6 LEVEL 109
DIR7 LEVEL 110
DIR8 LEVEL 111
DIR1/2 Bal 112
DIR3/4 Bal 113
DIR5/6 Bal 114
DIR7/8 Bal 115
-----

```

```

MIDI ch.=15
AUX1 LEVEL 104
AUX2 LEVEL 105
AUX3 LEVEL 106
AUX4 LEVEL 107
AUX5 LEVEL 108
AUX6 LEVEL 109
AUX7 LEVEL 110
AUX8 LEVEL 111
AUX1/2 Bal 112
AUX3/4 Bal 113
AUX5/6 Bal 114
AUX7/8 Bal 115
-----

```

```

MIDI ch.=16
MASTER LEVEL 102
MASTER BAL 103
MONITOR BAL 104
-----

```

MIDI Implementation

(*1) Mixer Level Table

Data	Lev (dB)	Data	Lev (dB)	Data	Lev (dB)	Data	Lev (dB)
0	- Inf	32	-21.2	64	- 9.3	96	- 0.8
1	-80.0	33	-20.8	65	- 9.0	97	- 0.6
2	-68.0	34	-20.4	66	- 8.8	98	- 0.4
3	-60.0	35	-20.0	67	- 8.6	99	- 0.2
4	-55.0	36	-19.6	68	- 8.4	100	0.0
5	-53.0	37	-19.2	69	- 8.2	101	0.2
6	-50.0	38	-18.8	70	- 8.0	102	0.4
7	-48.0	39	-18.4	71	- 7.6	103	0.6
8	-46.0	40	-18.0	72	- 7.3	104	0.8
9	-44.0	41	-17.6	73	- 7.0	105	1.0
10	-42.0	42	-17.2	74	- 6.6	106	1.3
11	-40.0	43	-16.8	75	- 6.3	107	1.5
12	-38.0	44	-16.4	76	- 6.0	108	1.8
13	-36.0	45	-16.0	77	- 5.8	109	2.0
14	-34.5	46	-15.6	78	- 5.5	110	2.3
15	-33.0	47	-15.2	79	- 5.3	111	2.5
16	-32.0	48	-14.8	80	- 5.0	112	2.8
17	-31.0	49	-14.4	81	- 4.8	113	3.0
18	-30.0	50	-14.0	82	- 4.6	114	3.3
19	-29.0	51	-13.6	83	- 4.4	115	3.5
20	-28.0	52	-13.2	84	- 4.2	116	3.8
21	-27.2	53	-12.8	85	- 4.0	117	4.0
22	-26.4	54	-12.4	86	- 3.6	118	4.2
23	-25.6	55	-12.0	87	- 3.3	119	4.4
24	-24.8	56	-11.6	88	- 3.0	120	4.6
25	-24.0	57	-11.3	89	- 2.6	121	4.8
26	-23.6	58	-11.0	90	- 2.3	122	5.0
27	-23.2	59	-10.6	91	- 2.0	123	5.2
28	-22.8	60	-10.3	92	- 1.8	124	5.4
29	-22.4	61	-10.0	93	- 1.5	125	5.6
30	-22.0	62	- 9.8	94	- 1.3	126	5.8
31	-21.6	63	- 9.5	95	- 1.0	127	6.0

(*2) Value and switching Track status corresponds as follows.

(1) While VS-2400CD stops

Value	0-41	42-83	84-127
Status	OFF -> OFF PLAY -> OFF REC -> OFF	OFF -> REC PLAY -> REC REC -> REC	OFF -> PLAY PLAY -> PLAY REC -> PLAY

(2) While play back/recording

Value	0-41	42-83	84-127
Status	OFF -> X PLAY -> OFF REC -> X	OFF -> X PLAY -> X REC -> REC	OFF -> PLAY PLAY -> PLAY REC -> X

(*) X = Ignored

Bank Select (MSB/LSB)

Switches the effect bank.

Status	Second	Third
BnH	00H	mmH
BnH	20H	11H

n = MIDI Channel No. :
0H - 3H (ch.1 = FX1 ch.2 = FX2 ch.3 = FX3 ch.4 = FX4)
mm = upper byte of bank number: 00H
11 = lower byte of bank number: 00H - 04H (0 - 4)

Bank Select	Program Change	Patch Number
MSB LSB		
00H 00H	00H - 63H (0 - 99)	Preset #000 - #099
00H 01H	00H - 63H (0 - 99)	Preset #100 - #199
00H 02H	00H - 31H (0 - 49)	Preset #200 - #249
00H 03H	00H - 63H (0 - 99)	User #000 - #099
00H 04H	00H - 63H (0 - 99)	User #100 - #199

Hold1

VS-2400CD can receive when EFFECT C.C. Rx Sw in the UTILITY condition MIDI screen is "On", effect patch Vocoder2 effect (algorithm 28) is selected, and Vocoder2's Hold parameter is "MIDI."

Status	Second	Third
BnH	40H	11H

n = MIDI Channel No. : 0,2H (ch.1 = FX1 ch.3 = FX3)
11 = Control Value: 00H - 7FH (0 - 127)

ONRPN(MSB/LSB)

Parameters on the Mixer/Effect section can be changed when UTILITY-MIDI screens EFFECT C.C. Rx Sw is "On."

Status	Second	Third
BnH	62H	11H
BnH	63H	mmH

n = MIDI Channel No. :
0H - 3H (ch.1 = FX1 ch.2 = FX2 ch.3 = FX3 ch.4 = FX4)
8H - 9H (ch.9 = Input Mixer, ch.10=Track Mixer)
mm = upper byte of the parameter number
to be assigned with NRPN.: 00H
n = 0H - 3H
00H - 17H (1 - 24)
n = 8H - 9H
11 = lower byte of the parameter number
to be assigned with NRPN.: 00H - 3EH (0 - 62)

Data Entry (MSB/LSB)

When UTILITY-MIDI screens EFFECT C.C. Rx Sw is "On," controls effect parameter assigned with NRPN.

Status	Second	Third
BnH	06H	mmH
BnH	26H	11H

n = MIDI Channel No. :
0H - 3H (ch.1 = FX1 ch.2 = FX2 ch.3 = FX3 ch.4 = FX4)
8H - 9H (ch.9 = Input Mixer, ch.10 = Track Mixer)
mm = upper byte corresponding to the parameter
assigned with NRPN.
11 = lower byte corresponding to the parameter
assigned with NRPN.
<Ex> mmH 11H = 40H 00H = -8192
= 7FH 7FH = -1
= 00H 00H = 0
= 3FH 7FH = +8191

Data Increment

When UTILITY-MIDI screens EFFECT C.C. Rx Sw is "On," increments the effect parameter assigned with NRPN.

Status	Second	Third
BnH	60H	00H

n = MIDI Channel No. :
0H - 7H (ch.1 = FX1 ch.2 = FX2 ch.3 = FX3 ch.4 = FX4)
8H - 9H (ch.9 = Input Mixer, ch.10 = Track Mixer)

Increment the effect parameter selected with NRPN.

Data Decrement

When UTILITY-MIDI screens EFFECT C.C. Rx Sw is "On," decrements the effect parameter assigned with NRPN.

Status	Second	Third
BnH	61H	00H

n = MIDI Channel No. :
0H - 7H (ch.1 = FX1 ch.2 = FX2 ch.3 = FX3 ch.4 = FX4)
8H - 9H (ch.9 = Input Mixer, ch.10 = Track Mixer)

Decrement the effect parameter selected with NRPN.

NRPN Parameters Number Map

Ch	NRPN MSB LSB	
0	00H 00H	EFFECT 1 Parameter
	01H 00H	(Reserved)
	7FH 7FH	(Reserved)
1	00H 00H	EFFECT 2 Parameter
	01H 00H	(Reserved)
	7FH 7FH	(Reserved)
2	00H 00H	EFFECT 3 Parameter
	01H 00H	(Reserved)
	7FH 7FH	(Reserved)
3	00H 00H	EFFECT 4 Parameter
	01H 00H	(Reserved)
	7FH 7FH	(Reserved)
4	00H 00H	Reserve
	01H 00H	(Reserved)
	7FH 7FH	(Reserved)
5	00H 00H	Reserve
	01H 00H	(Reserved)
	7FH 7FH	(Reserved)
6	00H 00H	Reserve
	01H 00H	(Reserved)
	7FH 7FH	(Reserved)
7	00H 00H	Reserve
	01H 00H	(Reserved)
	7FH 7FH	(Reserved)
8	00H 00H	Input Mixer Channel 1 EQ Parameter
	01H 00H	Input Mixer Channel 2 EQ Parameter
	07H 00H	Input Mixer Channel 8 EQ Parameter
	08H 00H	(Reserved)
	7FH 7FH	(Reserved)
9	00H 00H	Track Mixer Channel 1 EQ Parameter
	01H 00H	Track Mixer Channel 2 EQ Parameter
	17H 00H	Track Mixer Channel 24 EQ Parameter
	18H 00H	(Reserved)
	7FH 7FH	(Reserved)

(*1) Mixer Frequency Table

Data	Freq (Hz)	Data	Freq (Hz)	Data	Freq (Hz)
20	20	62	224	104	2.50k
21	21	63	237	105	2.66k
22	22	64	250	106	2.80k
23	24	65	266	107	3.00k
24	25	66	280	108	3.15k
25	27	67	300	109	3.35k
26	28	68	315	110	3.55k
27	30	69	335	111	3.76k
28	32	70	355	112	4.00k
29	33	71	376	113	4.22k
30	36	72	400	114	4.50k
31	38	73	422	115	4.73k
32	40	74	450	116	5.00k
33	42	75	473	117	5.30k
34	45	76	500	118	5.60k
35	47	77	530	119	6.00k
36	50	78	560	120	6.30k
37	53	79	600	121	6.70k
38	56	80	630	122	7.10k
39	60	81	670	123	7.50k
40	63	82	710	124	8.00k
41	67	83	750	125	8.40k
42	71	84	800	126	9.00k
43	75	85	840	127	9.44k
44	80	86	900	128	10.0k
45	84	87	944	129	10.6k
46	90	88	1.00k	130	11.2k
47	94	89	1.06k	131	12.0k
48	100	90	1.12k	132	12.5k
49	106	91	1.20k	133	13.3k
50	112	92	1.25k	134	14.0k
51	120	93	1.33k	135	15.0k
52	125	94	1.40k	136	16.0k
53	133	95	1.50k	137	17.0k
54	140	96	1.60k	138	18.0k
55	150	97	1.70k	139	19.0k
56	160	98	1.80k	140	20.0k
57	170	99	1.90k		
58	180	100	2.00k		
59	190	101	2.10k		
60	200	102	2.24k		
61	210	103	2.37k		

(*2) Mixer Q Table

Data	Q	Data	Q	Data	Q	Data	Q
30	0.36	50	1.12	70	3.55	90	11.2
31	0.38	51	1.20	71	3.76	91	12.0
32	0.40	52	1.25	72	4.00	92	12.5
33	0.42	53	1.33	73	4.22	93	13.3
34	0.45	54	1.40	74	4.50	94	14.0
35	0.47	55	1.50	75	4.73	95	15.0
36	0.50	56	1.60	76	5.00	96	16.0
37	0.53	57	1.70	77	5.30		
38	0.56	58	1.80	78	5.60		
39	0.60	59	1.90	79	6.00		
40	0.63	60	2.00	80	6.30		
41	0.67	61	2.10	81	6.70		
42	0.71	62	2.24	82	7.10		
43	0.75	63	2.37	83	7.50		
44	0.80	64	2.50	84	8.00		
45	0.84	65	2.66	85	8.40		
46	0.90	66	2.80	86	9.00		
47	0.94	67	3.00	87	9.44		
48	1.00	68	3.15	88	10.0		
49	1.06	69	3.35	89	10.6		

NRPN and Mixer Parameters

NRPN	Data Entry	
ccH 00H	mmH 11H	EQ SWITCH 0,1 = Off,On
ccH 01H	mmH 11H	EQ LOW GAIN -150,,,150 = -15.0,,,15.0dB
ccH 02H	mmH 11H	EQ LOW FREQUENCY 20,,,88 = 20Hz,,,1.00kHz (*1)
ccH 03H	mmH 11H	EQ LOWMID GAIN -150,,,150 = -15.0,,,15.0dB
ccH 04H	mmH 11H	EQ LOWMID FREQUENCY 20,,,140 = 20Hz,,,20.0kHz (*1)
ccH 05H	mmH 11H	EQ LOWMID Q 30,,,96 = 0.36,,,16.0 (*2)
ccH 06H	mmH 11H	EQ HIGHMID GAIN -150,,,150 = -15.0,,,15.0dB
ccH 07H	mmH 11H	EQ HIGHMID FREQUENCY 20,,,140 = 20Hz,,,20.0kHz (*1)
ccH 08H	mmH 11H	EQ HIGHMID Q 30,,,96 = 0.36,,,16.0 (*2)
ccH 09H	mmH 11H	EQ HIGH GAIN -150,,,150 = -15.0,,,15.0dB
ccH 0AH	mmH 11H	EQ HIGH FREQUENCY 88,,,140 = 1.00kHz,,,20.0kHz (*1)

* The Mixer Channel number is specified in NRPN's MSB (above ccH).

MIDI Implementation

NRPN and Effect Parameters

○ Algorithm 0 Reverb (FX1 or FX3)

NRPN	Data Entry	
00H 00H	mmH 11H	EQ SW 0,1 = Off,On
00H 01H	mmH 11H	EQ: Low EQ Type 0,1 = Shelving, Peaking
00H 02H	mmH 11H	EQ: Low EQ Gain -12,,,12dB
00H 03H	mmH 11H	EQ: Low EQ Frequency 2,,,200 = 20,,,2000Hz
00H 04H	mmH 11H	EQ: Low EQ Q 3,,,100 = 0.3,,,10.0
00H 05H	mmH 11H	EQ: Mid EQ Gain -12,,,12dB
00H 06H	mmH 11H	EQ: Mid EQ Frequency 20,,,800 = 200,,,8000Hz
00H 07H	mmH 11H	EQ: Mid EQ Q 3,,,100 = 0.3,,,10.0
00H 08H	mmH 11H	EQ: High EQ Type 0,1 = Shelving, Peaking
00H 09H	mmH 11H	EQ: High EQ Gain -12,,,12dB
00H 0AH	mmH 11H	EQ: High EQ Frequency 14,,,200 = 1.4,,,20.0kHz
00H 0BH	mmH 11H	EQ: High EQ Q 3,,,100 = 0.3,,,10.0
00H 0CH	mmH 11H	EQ: Out Level 0,,,100
00H 0DH	mmH 11H	Reverb: Room Size 5,,,40m
00H 0EH	mmH 11H	Reverb: Reverb Time 1,,,320 = 0.1,,,32.0s
00H 0FH	mmH 11H	Reverb: Pre Delay 0,,,200 = 0,,,200ms
00H 10H	mmH 11H	Reverb: Diffusion 0,,,100
00H 11H	mmH 11H	Reverb: Density 0,,,100
00H 12H	mmH 11H	Reverb: Early Reflection Level 0,,,100
00H 13H	mmH 11H	Reverb: LF Damp Frequency 5,,,400 = 50,,,4000Hz
00H 14H	mmH 11H	Reverb: LF Damp Gain -36,,,0dB
00H 15H	mmH 11H	Reverb: HF Damp Frequency 10,,,200 = 1.0,,,20.0kHz
00H 16H	mmH 11H	Reverb: HF Damp Gain -36,,,0dB
00H 17H	mmH 11H	Reverb: HI Cut Frequency 2,,,200 = 0.2,,,20.0kHz
00H 18H	mmH 11H	Reverb: Effect Level -100,,,100
00H 19H	mmH 11H	Reverb: Direct Level -100,,,100
00H 1AH	00H 00H	(Reserved)
00H 7FH	00H 00H	(Reserved)

○ Algorithm 1 Delay

NRPN	Data Entry	
00H 00H	mmH 11H	Delay SW 0,1 = Off,On
00H 01H	mmH 11H	EQ SW 0,1 = Off,On
00H 02H	mmH 11H	Delay: Delay Time 0,,,1200ms
00H 03H	mmH 11H	Delay: Shift -1200,,,1200 = L1200,,,R1200ms
00H 04H	mmH 11H	Delay: Lch Feedback Level -100,,,100
00H 05H	mmH 11H	Delay: Rch Feedback Level -100,,,100
00H 06H	mmH 11H	Delay: Lch Level -100,,,100

00H 07H	mmH 11H	Delay: Rch Level -100,,,100
00H 08H	mmH 11H	Delay: LF Damp Frequency 5,,,400 = 50,,,4000Hz
00H 09H	mmH 11H	Delay: LF Damp Gain -36,,,0dB
00H 0AH	mmH 11H	Delay: HF Damp Frequency 10,,,200 = 1.0,,,20.0kHz
00H 0BH	mmH 11H	Delay: HF Damp Gain -36,,,0dB
00H 0CH	mmH 11H	Delay: Direct Level -100,,,100
00H 0DH	mmH 11H	EQ: Low EQ Type 0,1 = Shelving, Peaking
00H 0EH	mmH 11H	EQ: Low EQ Gain -12,,,12dB
00H 0FH	mmH 11H	EQ: Low EQ Frequency 2,,,200 = 20,,,2000Hz
00H 10H	mmH 11H	EQ: Low EQ Q 3,,,100 = 0.3,,,10.0
00H 11H	mmH 11H	EQ: Mid EQ Gain -12,,,12dB
00H 12H	mmH 11H	EQ: Mid EQ Frequency 20,,,800 = 200,,,8000Hz
00H 13H	mmH 11H	EQ: Mid EQ Q 3,,,100 = 0.3,,,10.0
00H 14H	mmH 11H	EQ: High EQ Type 0,1 = Shelving, Peaking
00H 15H	mmH 11H	EQ: High EQ Gain -12,,,12dB
00H 16H	mmH 11H	EQ: High EQ Frequency 14,,,200 = 1.4,,,20.0kHz
00H 17H	mmH 11H	EQ: High EQ Q 3,,,100 = 0.3,,,10.0
00H 18H	mmH 11H	EQ: Out Level 0,,,100
00H 19H	00H 00H	(Reserved)
:	:	:
00H 7FH	00H 00H	(Reserved)

* (Delay Time) + (Absolute value of Shift) should be 1200 or less.

○ Algorithm 2 Stereo Delay Chorus

NRPN	Data Entry	
00H 00H	mmH 11H	Delay SW 0,1 = Off,On
00H 01H	mmH 11H	Chorus SW 0,1 = Off,On
00H 02H	mmH 11H	EQ SW 0,1 = Off,On
00H 03H	mmH 11H	Delay: Delay Time 0,,,500ms
00H 04H	mmH 11H	Delay: Shift -500,,,500 = L500,,,R500ms
00H 05H	mmH 11H	Delay: Lch Feedback Level -100,,,100
00H 06H	mmH 11H	Delay: Rch Feedback Level -100,,,100
00H 07H	mmH 11H	Delay: Lch Cross Feedback Level -100,,,100
00H 08H	mmH 11H	Delay: Rch Cross Feedback Level -100,,,100
00H 09H	mmH 11H	Delay: Effect Level -100,,,100
00H 0AH	mmH 11H	Delay: Direct Level -100,,,100
00H 0BH	mmH 11H	Chorus: Rate 1,,,100 = 0.1,,,10.0Hz
00H 0CH	mmH 11H	Chorus: Depth 0,,,100
00H 0DH	mmH 11H	Chorus: Pre Delay 0,,,50ms
00H 0EH	mmH 11H	Chorus: Effect Level -100,,,100
00H 0FH	mmH 11H	Chorus: Direct Level -100,,,100
00H 10H	mmH 11H	Chorus: Lch Feedback Level -100,,,100

00H 11H	mmH 11H	Chorus: Rch Feedback Level	-100,,,100
00H 12H	mmH 11H	Chorus: Lch Cross Feedback Level	-100,,,100
00H 13H	mmH 11H	Chorus: Rch Cross Feedback Level	-100,,,100
00H 14H	mmH 11H	EQ: Low EQ Type	0,1 = Shelving, Peaking
00H 15H	mmH 11H	EQ: Low EQ Gain	-12,,,12dB
00H 16H	mmH 11H	EQ: Low EQ Frequency	2,,,200 = 20,,,2000Hz
00H 17H	mmH 11H	EQ: Low EQ Q	3,,,100 = 0.3,,,10.0
00H 18H	mmH 11H	EQ: Mid EQ Gain	-12,,,12dB
00H 19H	mmH 11H	EQ: Mid EQ Frequency	20,,,800 = 200,,,8000Hz
00H 1AH	mmH 11H	EQ: Mid EQ Q	3,,,100 = 0.3,,,10.0
00H 1BH	mmH 11H	EQ: High EQ Type	0,1 = Shelving, Peaking
00H 1CH	mmH 11H	EQ: High EQ Gain	-12,,,12dB
00H 1DH	mmH 11H	EQ: High EQ Frequency	14,,,200 = 1.4,,,20.0kHz
00H 1EH	mmH 11H	EQ: High EQ Q	3,,,100 = 0.3,,,10.0
00H 1FH	mmH 11H	EQ: Out Level	0,,,100
00H 20H	00H 00H	(Reserved)	
:	:	:	
00H 7FH	00H 00H	(Reserved)	

* (Delay Time) + (Absolute value of Shift) should be 500 or less.

○ Algorithm 3 Stereo Pitch Shifter Delay

NRPN	Data Entry		
00H 00H	mmH 11H	P.ShifterDelay SW	0,1 = Off,On
00H 01H	mmH 11H	EQ SW	0,1 = Off,On
00H 02H	mmH 11H	P.ShifterDelay: Lch Chromatic Pitch	-12,,,12
00H 03H	mmH 11H	P.ShifterDelay: Lch Fine Pitch	-100,,,100
00H 04H	mmH 11H	P.ShifterDelay: Lch Pre Delay	0,,,50ms
00H 05H	mmH 11H	P.ShifterDelay: Lch Feedback Delay Time	0,,,500ms
00H 06H	mmH 11H	P.ShifterDelay: Lch Feedback Level	-100,,,100
00H 07H	mmH 11H	P.ShifterDelay: Lch Cross Feedback Level	-100,,,100
00H 08H	mmH 11H	P.ShifterDelay: Rch Chromatic Pitch	-12,,,12
00H 09H	mmH 11H	P.ShifterDelay: Rch Fine Pitch	-100,,,100
00H 0AH	mmH 11H	P.ShifterDelay: Rch Pre Delay	0,,,50ms
00H 0BH	mmH 11H	P.ShifterDelay: Rch Feedback Delay Time	0,,,500ms
00H 0CH	mmH 11H	P.ShifterDelay: Rch Feedback Level	-100,,,100
00H 0DH	mmH 11H	P.ShifterDelay: Rch Cross Feedback Level	-100,,,100
00H 0EH	mmH 11H	P.ShifterDelay: Effect Level	-100,,,100
00H 0FH	mmH 11H	P.ShifterDelay: Direct Level	-100,,,100
00H 10H	mmH 11H	EQ: Low EQ Type	0,1 = Shelving, Peaking
00H 11H	mmH 11H	EQ: Low EQ Gain	-12,,,12dB
00H 12H	mmH 11H	EQ: Low EQ Frequency	2,,,200 = 20,,,2000Hz
00H 13H	mmH 11H	EQ: Low EQ Q	3,,,100 = 0.3,,,10.0

00H 14H	mmH 11H	EQ: Mid EQ Gain	-12,,,12dB
00H 15H	mmH 11H	EQ: Mid EQ Frequency	20,,,800 = 200,,,8000Hz
00H 16H	mmH 11H	EQ: Mid EQ Q	3,,,100 = 0.3,,,10.0
00H 17H	mmH 11H	EQ: High EQ Type	0,1 = Shelving, Peaking
00H 18H	mmH 11H	EQ: High EQ Gain	-12,,,12dB
00H 19H	mmH 11H	EQ: High EQ Frequency	14,,,200 = 1.4,,,20.0kHz
00H 1AH	mmH 11H	EQ: High EQ Q	3,,,100 = 0.3,,,10.0
00H 1BH	mmH 11H	EQ: Out Level	0,,,100
00H 1CH	00H 00H	(Reserved)	
:	:	:	
00H 7FH	00H 00H	(Reserved)	

○ Algorithm 4 Vocoder

NRPN	Data Entry		
00H 00H	mmH 11H	Chorus SW	0,1 = Off,On
00H 01H	mmH 11H	Vocoder: Voice Character 1	0,,,100
00H 02H	mmH 11H	Vocoder: Voice Character 2	0,,,100
00H 03H	mmH 11H	Vocoder: Voice Character 3	0,,,100
00H 04H	mmH 11H	Vocoder: Voice Character 4	0,,,100
00H 05H	mmH 11H	Vocoder: Voice Character 5	0,,,100
00H 06H	mmH 11H	Vocoder: Voice Character 6	0,,,100
00H 07H	mmH 11H	Vocoder: Voice Character 7	0,,,100
00H 08H	mmH 11H	Vocoder: Voice Character 8	0,,,100
00H 09H	mmH 11H	Vocoder: Voice Character 9	0,,,100
00H 0AH	mmH 11H	Vocoder: Voice Character 10	0,,,100
00H 0BH	mmH 11H	Chorus: Rate	1,,,100 = 0.1,,,10.0Hz
00H 0CH	mmH 11H	Chorus: Depth	0,,,100
00H 0DH	mmH 11H	Chorus: Pre Delay	0,,,50ms
00H 0EH	mmH 11H	Chorus: Feedback Level	-100,,,100
00H 0FH	mmH 11H	Chorus: Effect Level	-100,,,100
00H 10H	mmH 11H	Chorus: Direct Level	-100,,,100
00H 11H	00H 00H	(Reserved)	
:	:	:	
00H 7FH	00H 00H	(Reserved)	

○ Algorithm 5 2CH RSS

NRPN	Data Entry		
00H 00H	mmH 11H	2CH RSS: Ach Azimuth	-30,,,30 = -180,,,180
00H 01H	mmH 11H	2CH RSS: Ach Elevation	-15,,,15 = -90,,,90
00H 02H	mmH 11H	2CH RSS: Bch Azimuth	-30,,,30 = -180,,,180
00H 03H	mmH 11H	2CH RSS: Bch Elevation	-15,,,15 = -90,,,90
00H 04H	mmH 11H	2CH RSS: Phones SW	0,1 = Off,On
00H 05H	mmH 11H	2CH RSS: RSS Type	0,1 = Type A, Type B

MIDI Implementation

00H 06H	00H 00H	(Reserved)
:	:	:
00H 7FH	00H 00H	(Reserved)

Algorithm 6 Delay RSS

NRPN	Data Entry	
00H 00H	mmH 11H	Delay RSS: Delay Time 0,,,1200ms
00H 01H	mmH 11H	Delay RSS: Shift -1200,,,1200 = L1200,,,R1200ms
00H 02H	mmH 11H	Delay RSS: Center Delay Time 0,,,1200ms
00H 03H	mmH 11H	Delay RSS: RSS Level 0,,,100
00H 04H	mmH 11H	Delay RSS: Center Level 0,,,100
00H 05H	mmH 11H	Delay RSS: Feedback Level -100,,,100
00H 06H	mmH 11H	Delay RSS: LF Damp Frequency 5,,,400 = 50,,,4000Hz
00H 07H	mmH 11H	Delay RSS: LF Damp Gain -36,,,0dB
00H 08H	mmH 11H	Delay RSS: HF Damp Frequency 10,,,200 = 1.0,,,20.0kHz
00H 09H	mmH 11H	Delay RSS: HF Damp Gain -36,,,0dB
00H 0AH	mmH 11H	Delay RSS: Effect Level -100,,,100
00H 0BH	mmH 11H	Delay RSS: Direct Level -100,,,100
00H 0CH	mmH 11H	Delay RSS: Phones SW 0,1 = Off,On
00H 0DH	00H 00H	(Reserved)
:	:	:
00H 7FH	00H 00H	(Reserved)

* (Delay Time) + (Absolute value of Shift) should be 1200 or less.

Algorithm 7 Chorus RSS

NRPN	Data Entry	
00H 00H	mmH 11H	Chorus RSS: Chorus Rate 1,,,100 = 0.1,,,10.0Hz
00H 01H	mmH 11H	Chorus RSS: Chorus Depth 0,,,100
00H 02H	mmH 11H	Chorus RSS: Effect Level -100,,,100
00H 03H	mmH 11H	Chorus RSS: Direct Level -100,,,100
00H 04H	mmH 11H	Chorus RSS: Phones SW 0,1 = Off,On
00H 05H	00H 00H	(Reserved)
:	:	:
00H 7FH	00H 00H	(Reserved)

Common for Algorithm 8,9,10 Guitar Multi 1, 2, 3

NRPN	Data Entry	
00H 00H	mmH 11H	Compressor SW 0,1 = Off,On
00H 01H	mmH 11H	Metal/Distortion/Over Drive SW 0,1 = Off,On
00H 02H	mmH 11H	Noise Suppressor SW 0,1 = Off,On
00H 03H	mmH 11H	Auto Wah SW 0,1 = Off,On
00H 04H	mmH 11H	Guitar Amp Modeling SW 0,1 = Off,On
00H 05H	mmH 11H	Flanger SW 0,1 = Off,On
00H 06H	mmH 11H	Delay SW 0,1 = Off,On
00H 07H	mmH 11H	Compressor: Attack 0,,,100
00H 08H	mmH 11H	Compressor: Level 0,,,100

00H 09H	mmH 11H	Compressor: Sustain 0,,,100
00H 0AH	mmH 11H	Compressor: Tone -50,,, -50
00H 0BH	mmH 11H	Noise Suppressor: Threshold 0,,,100
00H 0CH	mmH 11H	Noise Suppressor: Release 0,,,100
00H 0DH	mmH 11H	Auto Wah: Mode 0,1 = LPF,BPF
00H 0EH	mmH 11H	Auto Wah: Polarity 0,1 = Down,Up
00H 0FH	mmH 11H	Auto Wah: Frequency 0,,,100
00H 10H	mmH 11H	Auto Wah: Level 0,,,100
00H 11H	mmH 11H	Auto Wah: Peak 0,,,100
00H 12H	mmH 11H	Auto Wah: Sens 0,,,100
00H 13H	mmH 11H	Auto Wah: Rate 1,,,100 = 0.1,,,10.0Hz
00H 14H	mmH 11H	Auto Wah: Depth 0,,,100
00H 15H	mmH 11H	Guitar Amp Modeling: Mode 0,,,3 = Small,BultIn,2Stack,3Stack
00H 16H	mmH 11H	Flanger: Rate 1,,,100 = 0.1,,,10.0Hz
00H 17H	mmH 11H	Flanger: Depth 0,,,100
00H 18H	mmH 11H	Flanger: Manual 0,,,100
00H 19H	mmH 11H	Flanger: Resonance 0,,,100
00H 1AH	mmH 11H	Delay: Delay Time 0,,,1000ms
00H 1BH	mmH 11H	Delay: Shift -1000,,,1000 = L1000,,,R1000ms
00H 1CH	mmH 11H	Delay: Feedback Time 0,,,1000ms
00H 1DH	mmH 11H	Delay: Feedback Level -100,,,100
00H 1EH	mmH 11H	Delay: Effect Level -100,,,100
00H 1FH	mmH 11H	Delay: Direct Level -100,,,100

* (Delay Time) + (Absolute value of Shift) should be 1000 or less.

Individual for Algorithm 8 Guitar Multi 1

00H 20H	mmH 11H	Metal: Gain 0,,,100
00H 21H	mmH 11H	Metal: Level 0,,,100
00H 22H	mmH 11H	Metal: Hi Gain -100,,,100
00H 23H	mmH 11H	Metal: Mid Gain -100,,,100
00H 24H	mmH 11H	Metal: Low Gain -100,,,100
00H 25H	00H 00H	(Reserved)
:	:	:
00H 7FH	00H 00H	(Reserved)

Individual for Algorithm 9 Guitar Multi 2

00H 20H	mmH 11H	Distortion: Gain 0,,,100
00H 21H	mmH 11H	Distortion: Level 0,,,100
00H 22H	mmH 11H	Distortion: Tone 0,,,100
00H 23H	00H 00H	(Reserved)
:	:	:
00H 7FH	00H 00H	(Reserved)

Individual for Algorithm 10 Guitar Multi 3

00H 20H	mmH 11H	Over Drive: Gain	0,,,100
00H 21H	mmH 11H	Over Drive: Level	0,,,100
00H 22H	mmH 11H	Over Drive: Tone	0,,,100
00H 23H	00H 00H	(Reserved)	
:	:	:	
00H 7FH	00H 00H	(Reserved)	

○ Algorithm 11 Vocal Multi

NRPN	Data Entry		
00H 00H	mmH 11H	Noise Suppressor SW	0,1 = Off,On
00H 01H	mmH 11H	Limiter/De-esser SW	0,1 = Off,On
00H 02H	mmH 11H	Enhancer SW	0,1 = Off,On
00H 03H	mmH 11H	EQ SW	0,1 = Off,On
00H 04H	mmH 11H	P.Shifter SW	0,1 = Off,On
00H 05H	mmH 11H	Delay SW	0,1 = Off,On
00H 06H	mmH 11H	Chorus SW	0,1 = Off,On
00H 07H	mmH 11H	Limiter/De-esser Mode	0,1 = Limiter,De-esser
00H 08H	mmH 11H	Noise Suppressor: Threshold	0,,,100
00H 09H	mmH 11H	Noise Suppressor: Release	0,,,100
00H 0AH	mmH 11H	Limiter: Threshold	0,,,100
00H 0BH	mmH 11H	Limiter: Release	0,,,100
00H 0CH	mmH 11H	Limiter: Level	0,,,100
00H 0DH	mmH 11H	De-esser: Sens	0,,,100
00H 0EH	mmH 11H	De-esser: Frequency	10,,,100 = 1.0,,,10.0kHz
00H 0FH	mmH 11H	Enhancer: Sens	0,,,100
00H 10H	mmH 11H	Enhancer: Frequency	10,,,100 = 1.0,,,10.0kHz
00H 11H	mmH 11H	Enhancer: MIX Level	0,,,100
00H 12H	mmH 11H	Enhancer: Level	0,,,100
00H 13H	mmH 11H	EQ: Low EQ Type	0,1 = Shelving, Peaking
00H 14H	mmH 11H	EQ: Low EQ Gain	-12,,,12dB
00H 15H	mmH 11H	EQ: Low EQ Frequency	2,,,200 = 20,,,2000Hz
00H 16H	mmH 11H	EQ: Low EQ Q	3,,,100 = 0.3,,,10.0
00H 17H	mmH 11H	EQ: Mid EQ Gain	-12,,,12dB
00H 18H	mmH 11H	EQ: Mid EQ Frequency	20,,,800 = 200,,,8000Hz
00H 19H	mmH 11H	EQ: Mid EQ Q	3,,,100 = 0.3,,,10.0
00H 1AH	mmH 11H	EQ: High EQ Type	0,1 = Shelving, Peaking
00H 1BH	mmH 11H	EQ: High EQ Gain	-12,,,12dB
00H 1CH	mmH 11H	EQ: High EQ Frequency	14,,,200 = 1.4,,,20.0kHz
00H 1DH	mmH 11H	EQ: High EQ Q	3,,,100 = 0.3,,,10.0
00H 1EH	mmH 11H	EQ: Out Level	0,,,100

00H 1FH	mmH 11H	P.Shifter: Chromatic Pitch	-12,,,12
00H 20H	mmH 11H	P.Shifter: Fine Pitch	-100,,,100
00H 21H	mmH 11H	P.Shifter: Effect Level	-100,,,100
00H 22H	mmH 11H	P.Shifter: Direct Level	-100,,,100
00H 23H	mmH 11H	Delay: Delay Time	0,,,1000
00H 24H	mmH 11H	Delay: Feedback Level	-100,,,100
00H 25H	mmH 11H	Delay: Effect Level	-100,,,100
00H 26H	mmH 11H	Delay: Direct Level	-100,,,100
00H 27H	mmH 11H	Chorus: Rate	1,,,100 = 0.1,,,10.0Hz
00H 28H	mmH 11H	Chorus: Depth	0,,,100
00H 29H	mmH 11H	Chorus: Pre Delay	0,,,50ms
00H 2AH	mmH 11H	Chorus: Effect Level	-100,,,100
00H 2BH	mmH 11H	Chorus: Direct Level	-100,,,100
00H 2CH	00H 00H	(Reserved)	
:	:	:	
00H 7FH	00H 00H	(Reserved)	

○ Algorithm 12 Rotary

NRPN	Data Entry		
00H 00H	mmH 11H	Noise Suppressor SW	0,1 = Off,On
00H 01H	mmH 11H	Over Drive SW	0,1 = Off,On
00H 02H	mmH 11H	Noise Suppressor: Threshold	0,,,100
00H 03H	mmH 11H	Noise Suppressor: Release	0,,,100
00H 04H	mmH 11H	Over Drive: Gain	0,,,100
00H 05H	mmH 11H	Over Drive: Level	0,,,100
00H 06H	mmH 11H	Rotary: Low Rate	1,,,100 = 0.1,,,10.0Hz
00H 07H	mmH 11H	Rotary: Hi Rate	1,,,100 = 0.1,,,10.0Hz
00H 08H	00H 00H	(Reserved)	
:	:	:	
00H 7FH	00H 00H	(Reserved)	

○ Algorithm 13 Guitar AMP Modeling

NRPN	Data Entry		
00H 00H	mmH 11H	Noise Suppressor SW	0,1 = Off,On
00H 01H	mmH 11H	Pre Amp SW	0,1 = Off,On
00H 02H	mmH 11H	Speaker SW	0,1 = Off,On
00H 03H	mmH 11H	Noise Suppressor: Threshold	0,,,100
00H 04H	mmH 11H	Noise Suppressor: Release	0,,,100
00H 05H	mmH 11H	Pre Amp: Mode	0,,,13 = JC-120, Clean Twin, Match Drive, BG Lead, MS1959(I), MS1959(II), MS1959(I+II), SLDN Lead, Metal 5150, Metal Lead, OD-1, OD-2Turbo, Distortion, Fuzz
00H 06H	mmH 11H	Pre Amp: Volume	0,,,100
00H 07H	mmH 11H	Pre Amp: Bass	0,,,100
00H 08H	mmH 11H	Pre Amp: Middle	0,,,100

MIDI Implementation

00H 09H	mmH 11H	Pre Amp: Treble	0,,,100
00H 0AH	mmH 11H	Pre Amp: Presence	0,,,100
00H 0BH	mmH 11H	Pre Amp: Master	0,,,100
00H 0CH	mmH 11H	Pre Amp: Bright	0,1 = Off,On
00H 0DH	mmH 11H	Pre Amp: Gain	0,1,2 = Low,Middle,High
00H 0EH	mmH 11H	Speaker: Type 0,,,11 = Small, Middle, JC-120, Built In 1, Built In 2,Built In 3, Built In 4, BG Stack 1, BG Stack 2, MS Stack 1, MS Stack 2, Metal Stack	
00H 0FH	mmH 11H	Speaker: MIC Setting	0,1,2 = 1,2,3
00H 10H	mmH 11H	Speaker: MIC Level	0,,,100
00H 11H	mmH 11H	Speaker: Direct Level	0,,,100
00H 12H	00H 00H	(Reserved)	
:	:	:	
00H 7FH	00H 00H	(Reserved)	

- * Pre Amp Middle is invalid when the Mode = Match Drive.
- * When the Mode = Match Drive, Pre Amp Presence works counter to the value (-100,,0).
- * Pre Amp Bright is available only when the Mode = JC-120, Clean Twin, BG Lead.

Algorithm 14 Stereo Phaser

NRPN	Data Entry		
00H 00H	mmH 11H	Phaser SW	0,1 = Off,On
00H 01H	mmH 11H	EQ SW	0,1 = Off,On
00H 02H	mmH 11H	Phaser: Mode	0,,,3 = 4,8,12,16stage
00H 03H	mmH 11H	Phaser: Rate	1,,,100 = 0.1,,,10.0Hz
00H 04H	mmH 11H	Phaser: Depth	0,,,100
00H 05H	mmH 11H	Phaser: Polarity	0,1 = Inverse,Synchro
00H 06H	mmH 11H	Phaser: Manual	0,,,100
00H 07H	mmH 11H	Phaser: Resonance	0,,,100
00H 08H	mmH 11H	Phaser: Cross Feedback	0,,,100
00H 09H	mmH 11H	Phaser: Effect Level	-100,,,100
00H 0AH	mmH 11H	Phaser: Direct Level	-100,,,100
00H 0BH	mmH 11H	EQ: Low EQ Type	0,1 = Shelving, Peaking
00H 0CH	mmH 11H	EQ: Low EQ Gain	-12,,,12dB
00H 0DH	mmH 11H	EQ: Low EQ Frequency	2,,,200 = 20,,,2000Hz
00H 0EH	mmH 11H	EQ: Low EQ Q	3,,,100 = 0.3,,,10.0
00H 0FH	mmH 11H	EQ: Mid EQ Gain	-12,,,12dB
00H 10H	mmH 11H	EQ: Mid EQ Frequency	20,,,800 = 200,,,8000Hz
00H 11H	mmH 11H	EQ: Mid EQ Q	3,,,100 = 0.3,,,10.0
00H 12H	mmH 11H	EQ: High EQ Type	0,1 = Shelving, Peaking
00H 13H	mmH 11H	EQ: High EQ Gain	-12,,,12dB
00H 14H	mmH 11H	EQ: High EQ Frequency	14,,,200 = 1.4,,,20.0kHz
00H 15H	mmH 11H	EQ: High EQ Q	3,,,100 = 0.3,,,10.0
00H 16H	mmH 11H	EQ: Out Level	0,,,100
00H 17H	00H 00H	(Reserved)	
:	:	:	
00H 7FH	00H 00H	(Reserved)	

Algorithm 15 Stereo Flanger

NRPN	Data Entry		
00H 00H	mmH 11H	Flanger SW	0,1 = Off,On
00H 01H	mmH 11H	EQ SW	0,1 = Off,On
00H 02H	mmH 11H	Flanger: Rate	1,,,100 = 0.1,,,10.0Hz
00H 03H	mmH 11H	Flanger: Depth	0,,,100
00H 04H	mmH 11H	Flanger: Polarity	0,1 = Inverse,Synchro
00H 05H	mmH 11H	Flanger: Manual	0,,,100
00H 06H	mmH 11H	Flanger: Resonance	0,,,100
00H 07H	mmH 11H	Flanger: Cross Feedback Level	0,,,100
00H 08H	mmH 11H	Flanger: Effect Level	-100,,,100
00H 09H	mmH 11H	Flanger: Direct Level	-100,,,100
00H 0AH	mmH 11H	EQ: Low EQ Type	0,1 = Shelving, Peaking
00H 0BH	mmH 11H	EQ: Low EQ Gain	-12,,,12dB
00H 0CH	mmH 11H	EQ: Low EQ Frequency	2,,,200 = 20,,,2000Hz
00H 0DH	mmH 11H	EQ: Low EQ Q	3,,,100 = 0.3,,,10.0
00H 0EH	mmH 11H	EQ: Mid EQ Gain	-12,,,12dB
00H 0FH	mmH 11H	EQ: Mid EQ Frequency	20,,,800 = 200,,,8000Hz
00H 10H	mmH 11H	EQ: Mid EQ Q	3,,,100 = 0.3,,,10.0
00H 11H	mmH 11H	EQ: High EQ Type	0,1 = Shelving, Peaking
00H 12H	mmH 11H	EQ: High EQ Gain	-12,,,12dB
00H 13H	mmH 11H	EQ: High EQ Frequency	14,,,200 = 1.4,,,20.0kHz
00H 14H	mmH 11H	EQ: High EQ Q	3,,,100 = 0.3,,,10.0
00H 15H	mmH 11H	EQ: Out Level	0,,,100
00H 16H	00H 00H	(Reserved)	
:	:	:	
00H 7FH	00H 00H	(Reserved)	

Algorithm 16 Dual Compressor/Limiter

NRPN	Data Entry		
00H 00H	mmH 11H	Comp/Limit A SW	0,1 = Off,On
00H 01H	mmH 11H	Noise Suppressor A SW	0,1 = Off,On
00H 02H	mmH 11H	Comp/Limit B SW	0,1 = Off,On
00H 03H	mmH 11H	Noise Suppressor B SW	0,1 = Off,On
00H 04H	mmH 11H	Comp/Limit A: Detect	0,1,2 = A,B,Link
00H 05H	mmH 11H	Comp/Limit A: Level	-60,,,12dB
00H 06H	mmH 11H	Comp/Limit A: Thresh	-60,,,0dB
00H 07H	mmH 11H	Comp/Limit A: Attack	0,,,100
00H 08H	mmH 11H	Comp/Limit A: Release	0,,,100
00H 09H	mmH 11H	Comp/Limit A: Ratio	0,,,3 = 1.5:1,2:1,4:1,100:1
00H 0AH	mmH 11H	Noise Suppressor A: Detect	0,1,2 = A,B,Link

00H 0BH	mmH 11H	Noise Suppressor A: Threshold	0,,,100
00H 0CH	mmH 11H	Noise Suppressor A: Release	0,,,100
00H 0DH	mmH 11H	Comp/Limit B: Detect	0,1,2 = A,B,Link
00H 0EH	mmH 11H	Comp/Limit B: Level	-60,,,12dB
00H 0FH	mmH 11H	Comp/Limit B: Thresh	-60,,,0dB
00H 10H	mmH 11H	Comp/Limit B: Attack	0,,,100
00H 11H	mmH 11H	Comp/Limit B: Release	0,,,100
00H 12H	mmH 11H	Comp/Limit B: Ratio	0,,,3 = 1.5:1,2:1,4:1,100:1
00H 13H	mmH 11H	Noise Suppressor B: Detect	0,1,2 = A,B,Link
00H 14H	mmH 11H	Noise Suppressor B: Threshold	0,,,100
00H 15H	mmH 11H	Noise Suppressor B: Release	0,,,100
00H 16H : 00H 7FH	00H 00H : 00H 00H	(Reserved) : (Reserved)	

○ Algorithm 17 Gate Reverb (FX1 or FX3)

NRPN	Data Entry		
00H 00H	mmH 11H	G.Reverb SW	0,1 = Off,On
00H 01H	mmH 11H	EQ SW	0,1 = Off,On
00H 02H	mmH 11H	G.Reverb: Gate Time	10,,,400ms
00H 03H	mmH 11H	G.Reverb: Pre Delay	0,,,300ms
00H 04H	mmH 11H	G.Reverb: Effect Level	-100,,,100
00H 05H	mmH 11H	G.Reverb: Mode	0,,,4 = Normal,L->R,R->L,Reverse1,Reverse2
00H 06H	mmH 11H	G.Reverb: Thickness	0,,,100
00H 07H	mmH 11H	G.Reverb: Density	0,,,100
00H 08H	mmH 11H	G.Reverb: Accent Delay	0,,,200ms
00H 09H	mmH 11H	G.Reverb: Accent Level	0,,,100
00H 0AH	mmH 11H	G.Reverb: Accent Pan	1,,,127 = L63,,,R63
00H 0BH	mmH 11H	G.Reverb: Direct Level	-100,,,100
00H 0CH	mmH 11H	EQ: Low EQ Type	0,1 = Shelving, Peaking
00H 0DH	mmH 11H	EQ: Low EQ Gain	-12,,,12dB
00H 0EH	mmH 11H	EQ: Low EQ Frequency	2,,,200 = 20,,,2000Hz
00H 0FH	mmH 11H	EQ: Low EQ Q	3,,,100 = 0.3,,,10.0
00H 10H	mmH 11H	EQ: Mid EQ Gain	-12,,,12dB
00H 11H	mmH 11H	EQ: Mid EQ Frequency	20,,,800 = 200,,,8000Hz
00H 12H	mmH 11H	EQ: Mid EQ Q	3,,,100 = 0.3,,,10.0
00H 13H	mmH 11H	EQ: High EQ Type	0,1 = Shelving, Peaking
00H 14H	mmH 11H	EQ: High EQ Gain	-12,,,12dB
00H 15H	mmH 11H	EQ: High EQ Frequency	14,,,200 = 1.4,,,20.0kHz
00H 16H	mmH 11H	EQ: High EQ Q	3,,,100 = 0.3,,,10.0
00H 17H	mmH 11H	EQ: Out Level	0,,,100

00H 18H	00H 00H	(Reserved)
:	:	:
00H 7FH	00H 00H	(Reserved)

○ Algorithm 18 Multi Tap Delay

NRPN	Data Entry		
00H 00H	mmH 11H	EQ SW	0,1 = Off,On
00H 01H	mmH 11H	M.Tap Delay: Time 1	0,,,1200ms
00H 02H	mmH 11H	M.Tap Delay: Level 1	0,,,100
00H 03H	mmH 11H	M.Tap Delay: Pan 1	1,,,127 = L63,,,R63
00H 04H	mmH 11H	M.Tap Delay: Time 2	0,,,1200ms
00H 05H	mmH 11H	M.Tap Delay: Level 2	0,,,100
00H 06H	mmH 11H	M.Tap Delay: Pan 2	1,,,127 = L63,,,R63
00H 07H	mmH 11H	M.Tap Delay: Time 3	0,,,1200ms
00H 08H	mmH 11H	M.Tap Delay: Level 3	0,,,100
00H 09H	mmH 11H	M.Tap Delay: Pan 3	1,,,127 = L63,,,R63
00H 0AH	mmH 11H	M.Tap Delay: Time 4	0,,,1200ms
00H 0BH	mmH 11H	M.Tap Delay: Level 4	0,,,100
00H 0CH	mmH 11H	M.Tap Delay: Pan 4	1,,,127 = L63,,,R63
00H 0DH	mmH 11H	M.Tap Delay: Time 5	0,,,1200ms
00H 0EH	mmH 11H	M.Tap Delay: Level 5	0,,,100
00H 0FH	mmH 11H	M.Tap Delay: Pan 5	1,,,127 = L63,,,R63
00H 10H	mmH 11H	M.Tap Delay: Time 6	0,,,1200ms
00H 11H	mmH 11H	M.Tap Delay: Level 6	0,,,100
00H 12H	mmH 11H	M.Tap Delay: Pan 6	1,,,127 = L63,,,R63
00H 13H	mmH 11H	M.Tap Delay: Time 7	0,,,1200ms
00H 14H	mmH 11H	M.Tap Delay: Level 7	0,,,100
00H 15H	mmH 11H	M.Tap Delay: Pan 7	1,,,127 = L63,,,R63
00H 16H	mmH 11H	M.Tap Delay: Time 8	0,,,1200ms
00H 17H	mmH 11H	M.Tap Delay: Level 8	0,,,100
00H 18H	mmH 11H	M.Tap Delay: Pan 8	1,,,127 = L63,,,R63
00H 19H	mmH 11H	M.Tap Delay: Time 9	0,,,1200ms
00H 1AH	mmH 11H	M.Tap Delay: Level 9	0,,,100
00H 1BH	mmH 11H	M.Tap Delay: Pan 9	1,,,127 = L63,,,R63
00H 1CH	mmH 11H	M.Tap Delay: Time 10	0,,,1200ms
00H 1DH	mmH 11H	M.Tap Delay: Level 10	0,,,100
00H 1EH	mmH 11H	M.Tap Delay: Pan 10	1,,,127 = L63,,,R63
00H 1FH	mmH 11H	M.Tap Delay: Feedback Delay Time	0,,,1200ms
00H 20H	mmH 11H	M.Tap Delay: Feedback Level	-100,,,100
00H 21H	mmH 11H	M.Tap Delay: Effect Level	-100,,,100
00H 22H	mmH 11H	M.Tap Delay: Direct Level	-100,,,100

MIDI Implementation

00H 23H	mmH 11H	EQ: Low EQ Type 0,1 = Shelving, Peaking
00H 24H	mmH 11H	EQ: Low EQ Gain -12,,,12dB
00H 25H	mmH 11H	EQ: Low EQ Frequency 2,,,200 = 20,,,2000Hz
00H 26H	mmH 11H	EQ: Low EQ Q 3,,,100 = 0.3,,,10.0
00H 27H	mmH 11H	EQ: Mid EQ Gain -12,,,12dB
00H 28H	mmH 11H	EQ: Mid EQ Frequency 20,,,800 = 200,,,8000Hz
00H 29H	mmH 11H	EQ: Mid EQ Q 3,,,100 = 0.3,,,10.0
00H 2AH	mmH 11H	EQ: High EQ Type 0,1 = Shelving, Peaking
00H 2BH	mmH 11H	EQ: High EQ Gain -12,,,12dB
00H 2CH	mmH 11H	EQ: High EQ Frequency 14,,,200 = 1.4,,,20.0kHz
00H 2DH	mmH 11H	EQ: High EQ Q 3,,,100 = 0.3,,,10.0
00H 2EH	mmH 11H	EQ: Out Level 0,,,100
00H 2FH	00H 00H	(Reserved)
:	:	:
00H 7FH	00H 00H	(Reserved)

Algorithm 19 Stereo Multi

NRPN	Data Entry	
00H 00H	mmH 11H	Noise Suppressor SW 0,1 = Off,On
00H 01H	mmH 11H	Comp/Limit SW 0,1 = Off,On
00H 02H	mmH 11H	Enhancer SW 0,1 = Off,On
00H 03H	mmH 11H	EQ SW 0,1 = Off,On
00H 04H	mmH 11H	Noise Suppressor: Threshold 0,,,100
00H 05H	mmH 11H	Noise Suppressor: Release 0,,,100
00H 06H	mmH 11H	Comp/Limit: Level -60,,,12dB
00H 07H	mmH 11H	Comp/Limit: Thresh -60,,,0dB
00H 08H	mmH 11H	Comp/Limit: Attack 0,,,100
00H 09H	mmH 11H	Comp/Limit: Release 0,,,100
00H 0AH	mmH 11H	Comp/Limit: Ratio 0,,,3 = 1.5:1,2:1,4:1,100:1
00H 0BH	mmH 11H	Enhancer: Sens 0,,,100
00H 0CH	mmH 11H	Enhancer: Frequency 10,,,100 = 1.0,,,10.0kHz
00H 0DH	mmH 11H	Enhancer: MIX Level 0,,,100
00H 0EH	mmH 11H	Enhancer: Level 0,,,100
00H 0FH	mmH 11H	EQ: Low EQ Type 0,1 = Shelving, Peaking
00H 10H	mmH 11H	EQ: Low EQ Gain -12,,,12dB
00H 11H	mmH 11H	EQ: Low EQ Frequency 2,,,200 = 20,,,2000Hz
00H 12H	mmH 11H	EQ: Low EQ Q 3,,,100 = 0.3,,,10.0
00H 13H	mmH 11H	EQ: Mid EQ Gain -12,,,12dB
00H 14H	mmH 11H	EQ: Mid EQ Frequency 20,,,800 = 200,,,8000Hz
00H 15H	mmH 11H	EQ: Mid EQ Q 3,,,100 = 0.3,,,10.0
00H 16H	mmH 11H	EQ: High EQ Type 0,1 = Shelving, Peaking

00H 17H	mmH 11H	EQ: High EQ Gain -12,,,12dB
00H 18H	mmH 11H	EQ: High EQ Frequency 14,,,200 = 1.4,,,20.0kHz
00H 19H	mmH 11H	EQ: High EQ Q 3,,,100 = 0.3,,,10.0
00H 1AH	mmH 11H	EQ: Out Level 0,,,100
00H 1BH	00H 00H	(Reserved)
:	:	:
00H 7FH	00H 00H	(Reserved)

Algorithm 20 Reverb 2

NRPN	Data Entry	
00H 00H	mmH 11H	Reverb SW 0,1 = Off,On
00H 01H	mmH 11H	EQ SW 0,1 = Off,On
00H 02H	mmH 11H	Reverb 2: Reverb Type 0,,,4 = Room1,Room2,Hall1,Hall2,Plate
00H 03H	mmH 11H	Reverb 2: Reverb Time 1,,,100 = 0.1,,,10.0sec
00H 04H	mmH 11H	Reverb 2: Pre Delay 0,,,200msec
00H 05H	mmH 11H	Reverb 2: Density 0,,,100
00H 06H	mmH 11H	Reverb 2: High Pass Filter 1,,,200 = Thru,20,,,2000Hz
00H 07H	mmH 11H	Reverb 2: Low Pass Filter 10,,,201 = 1.0,,,20,0kHz,Thru
00H 08H	mmH 11H	Reverb 2: Effect Level 0,,,100
00H 09H	mmH 11H	Reverb 2: Direct Level 0,,,100
00H 0AH	mmH 11H	Reverb 2: Gate SW 0,1 = Off,On
00H 0BH	mmH 11H	Reverb 2: Gate Mode 0,1 = Gate,Ducking
00H 0CH	mmH 11H	Reverb 2: Gate Threshold 0,,,100
00H 0DH	mmH 11H	Reverb 2: Gate Attack Time 1,,,100
00H 0EH	mmH 11H	Reverb 2: Gate Release Time 1,,,100
00H 0FH	mmH 11H	Reverb 2: Gate Hold Time 1,,,100
00H 10H	mmH 11H	EQ: Low EQ Type 0,1 = Shelving, Peaking
00H 11H	mmH 11H	EQ: Low EQ Gain -12,,,12dB
00H 12H	mmH 11H	EQ: Low EQ Frequency 2,,,200 = 20,,,2000Hz
00H 13H	mmH 11H	EQ: Low EQ Q 3,,,100 = 0.3,,,10.0
00H 14H	mmH 11H	EQ: Mid EQ Gain -12,,,12dB
00H 15H	mmH 11H	EQ: Mid EQ Frequency 20,,,800 = 200,,,8000Hz
00H 16H	mmH 11H	EQ: Mid EQ Q 3,,,100 = 0.3,,,10.0
00H 17H	mmH 11H	EQ: High EQ Type 0,1 = Shelving, Peaking
00H 18H	mmH 11H	EQ: High EQ Gain -12,,,12dB
00H 19H	mmH 11H	EQ: High EQ Frequency 14,,,200 = 1.4,,,20.0kHz
00H 1AH	mmH 11H	EQ: High EQ Q 3,,,100 = 0.3,,,10.0
00H 1BH	mmH 11H	EQ: Out Level 0,,,100
00H 1CH	00H 00H	(Reserved)
:	:	:
00H 7FH	00H 00H	(Reserved)

○ Algorithm 21 Space Chorus

NRPN	Data Entry	
00H 00H	mmH 11H	Chorus SW 0,1 = Off,On
00H 01H	mmH 11H	Chorus: Input Mode 0,1 = Mono,Stereo
00H 02H	mmH 11H	Chorus: Mode 0,,,6 = 1,2,3,4,1+4,2+4,3+4
00H 03H	mmH 11H	Chorus: Mix Balance 0,,,100
00H 04H	00H 00H	(Reserved)
:	:	:
00H 7FH	00H 00H	(Reserved)

○ Algorithm 22 Lo-Fi Processor

NRPN	Data Entry	
00H 00H	mmH 11H	Lo-Fi Processor SW 0,1 = Off,On
00H 01H	mmH 11H	Real time Modify Filter SW 0,1 = Off,On
00H 02H	mmH 11H	Lo-Fi Processor: Pre Filter SW 0,1 = Off,On
00H 03H	mmH 11H	Lo-Fi Processor: Rate 0,,,31 = Off,1/2,,,1/32
00H 04H	mmH 11H	Lo-Fi Processor: Number of Bit 0,,,15 = Off,15,,,1bit
00H 05H	mmH 11H	Lo-Fi Processor: Post Filter SW 0,1 = Off,On
00H 06H	mmH 11H	Lo-Fi Processor: Effect Level 0,,,100
00H 07H	mmH 11H	Lo-Fi Processor: Direct Level 0,,,100
00H 08H	mmH 11H	Real time Modify Filter: Filter Type 0,,,2 = LPF,BPF,HPF
00H 09H	mmH 11H	Real time Modify Filter: Cut Off 0,,,100
00H 0AH	mmH 11H	Real time Modify Filter: Resonance 0,,,100
00H 0BH	mmH 11H	Real time Modify Filter: Gain 0,,,24dB
00H 0CH	mmH 11H	Noise Suppressor: Threshold 0,,,100
00H 0DH	mmH 11H	Noise Suppressor: Release 0,,,100
00H 0EH	00H 00H	(Reserved)
:	:	:
00H 7FH	00H 00H	(Reserved)

○ Algorithm 23 4 Band Parametric EQ

NRPN	Data Entry	
00H 00H	mmH 11H	Parametric EQ Link SW 0,1 = Off,On
00H 01H	mmH 11H	Parametric EQ Ach SW 0,1 = Off,On
00H 02H	mmH 11H	Parametric EQ Bch SW 0,1 = Off,On
00H 03H	mmH 11H	EQ Ach: Input Gain -60,,,12dB
00H 04H	mmH 11H	EQ Ach: Low EQ Type 0,1 = Shelving, Peaking
00H 05H	mmH 11H	EQ Ach: Low EQ Gain -12,,,12dB
00H 06H	mmH 11H	EQ Ach: Low EQ Frequency 2,,,200 = 20,,,2000Hz
00H 07H	mmH 11H	EQ Ach: Low EQ Q 3,,,100 = 0.3,,,10.0
00H 08H	mmH 11H	EQ Ach: Low Mid EQ Gain -12,,,12dB
00H 09H	mmH 11H	EQ Ach: Low Mid EQ Frequency 20,,,800 = 200,,,8000Hz
00H 0AH	mmH 11H	EQ Ach: Low Mid EQ Q 3,,,100 = 0.3,,,10.0
00H 0BH	mmH 11H	EQ Ach: High Mid EQ Gain -12,,,12dB

00H 0CH	mmH 11H	EQ Ach: High Mid EQ Frequency 20,,,800 = 200,,,8000Hz
00H 0DH	mmH 11H	EQ Ach: High Mid EQ Q 3,,,100 = 0.3,,,10.0
00H 0EH	mmH 11H	EQ Ach: High EQ Type 0,1 = Shelving, Peaking
00H 0FH	mmH 11H	EQ Ach: High EQ Gain -12,,,12dB
00H 10H	mmH 11H	EQ Ach: High EQ Frequency 14,,,200 = 1.4,,,20.0kHz
00H 11H	mmH 11H	EQ Ach: High EQ Q 3,,,100 = 0.3,,,10.0
00H 12H	mmH 11H	EQ Ach: Output Level -60,,,12dB
00H 13H	mmH 11H	EQ Bch: Input Gain -60,,,12dB
00H 14H	mmH 11H	EQ Bch: Low EQ Type 0,1 = Shelving, Peaking
00H 15H	mmH 11H	EQ Bch: Low EQ Gain -12,,,12dB
00H 16H	mmH 11H	EQ Bch: Low EQ Frequency 2,,,200 = 20,,,2000Hz
00H 17H	mmH 11H	EQ Bch: Low EQ Q 3,,,100 = 0.3,,,10.0
00H 18H	mmH 11H	EQ Bch: Low Mid EQ Gain -12,,,12dB
00H 19H	mmH 11H	EQ Bch: Low Mid EQ Frequency 20,,,800 = 200,,,8000Hz
00H 1AH	mmH 11H	EQ Bch: Low Mid EQ Q 3,,,100 = 0.3,,,10.0
00H 1BH	mmH 11H	EQ Bch: High Mid EQ Gain -12,,,12dB
00H 1CH	mmH 11H	EQ Bch: High Mid EQ Frequency 20,,,800 = 200,,,8000Hz
00H 1DH	mmH 11H	EQ Bch: High Mid EQ Q 3,,,100 = 0.3,,,10.0
00H 1EH	mmH 11H	EQ Bch: High EQ Type 0,1 = Shelving, Peaking
00H 1FH	mmH 11H	EQ Bch: High EQ Gain -12,,,12dB
00H 20H	mmH 11H	EQ Bch: High EQ Frequency 14,,,200 = 1.4,,,20.0kHz
00H 21H	mmH 11H	EQ Bch: High EQ Q 3,,,100 = 0.3,,,10.0
00H 22H	mmH 11H	EQ Bch: Output Level -60,,,12dB
00H 23H	00H 00H	(Reserved)
:	:	:
00H 7FH	00H 00H	(Reserved)

* When Link SW = On, Bch corresponds to Ach.

○ Algorithm 24 10 Band Graphic EQ

NRPN	Data Entry	
00H 00H	mmH 11H	Graphic EQ Link SW 0,1 = Off,On
00H 01H	mmH 11H	Graphic EQ Ach SW 0,1 = Off,On
00H 02H	mmH 11H	Graphic EQ Bch SW 0,1 = Off,On
00H 03H	mmH 11H	EQ Ach: Input Gain -60,,,12dB
00H 04H	mmH 11H	EQ Ach: 31.25Hz Gain -12,,,12dB
00H 05H	mmH 11H	EQ Ach: 62.5Hz Gain -12,,,12dB
00H 06H	mmH 11H	EQ Ach: 125Hz Gain -12,,,12dB
00H 07H	mmH 11H	EQ Ach: 250Hz Gain -12,,,12dB
00H 08H	mmH 11H	EQ Ach: 500Hz Gain -12,,,12dB
00H 09H	mmH 11H	EQ Ach: 1.0kHz Gain -12,,,12dB
00H 0AH	mmH 11H	EQ Ach: 2.0kHz Gain -12,,,12dB
00H 0BH	mmH 11H	EQ Ach: 4.0kHz Gain -12,,,12dB

MIDI Implementation

00H 0CH	mmH 11H	EQ Ach: 8.0kHz Gain	-12,,,12dB
00H 0DH	mmH 11H	EQ Ach: 16.0kHz Gain	-12,,,12dB
00H 0EH	mmH 11H	EQ Ach: Output Level	-60,,,12dB
00H 0FH	mmH 11H	EQ Bch: Input Gain	-60,,,12dB
00H 10H	mmH 11H	EQ Bch: 31.25Hz Gain	-12,,,12dB
00H 11H	mmH 11H	EQ Bch: 62.5Hz Gain	-12,,,12dB
00H 12H	mmH 11H	EQ Bch: 125Hz Gain	-12,,,12dB
00H 13H	mmH 11H	EQ Bch: 250Hz Gain	-12,,,12dB
00H 14H	mmH 11H	EQ Bch: 500Hz Gain	-12,,,12dB
00H 15H	mmH 11H	EQ Bch: 1.0kHz Gain	-12,,,12dB
00H 16H	mmH 11H	EQ Bch: 2.0kHz Gain	-12,,,12dB
00H 17H	mmH 11H	EQ Bch: 4.0kHz Gain	-12,,,12dB
00H 18H	mmH 11H	EQ Bch: 8.0kHz Gain	-12,,,12dB
00H 19H	mmH 11H	EQ Bch: 16.0kHz Gain	-12,,,12dB
00H 1AH	mmH 11H	EQ Bch: Output Level	-60,,,12dB
00H 1BH	00H 00H	(Reserved)	
:	:	:	
00H 7FH	00H 00H	(Reserved)	

* When Link SW = On, Bch corresponds to Ach.

○ Algorithm 25 Hum Canceled

NRPN	Data Entry		
00H 00H	mmH 11H	Hum Canceled SW	0,1 = Off,On
00H 01H	mmH 11H	Noise Suppressor SW	0,1 = Off,On
00H 02H	mmH 11H	Hum Canceled: Freq	200,,,8000 = 20.0,,,800.0Hz
00H 03H	mmH 11H	Hum Canceled: Width	10,,,40%
00H 04H	mmH 11H	Hum Canceled: Depth	0,,,100
00H 05H	mmH 11H	Hum Canceled: Threshold	0,,,100
00H 06H	mmH 11H	Hum Canceled: Range Low	1,,,200 = Unlimit,20,,,2000Hz
00H 07H	mmH 11H	Hum Canceled: Range High	10,,,201 = 1.0,,,20,0kHz,Unlimit
00H 08H	mmH 11H	Noise Suppressor: Threshold	0,,,100
00H 09H	mmH 11H	Noise Suppressor: Release	0,,,100
00H 0AH	00H 00H	(Reserved)	
:	:	:	
00H 7FH	00H 00H	(Reserved)	

○ Algorithm 26 Vocal Canceled

NRPN	Data Entry		
00H 00H	mmH 11H	Vocal Canceled SW	0,1 = Off,On
00H 01H	mmH 11H	EQ SW	0,1 = Off,On
00H 02H	mmH 11H	Vocal Canceled: Balance	0,,,100
00H 03H	mmH 11H	Vocal Canceled: Range Low	1,,,200 = Unlimit,20,,,2000Hz
00H 04H	mmH 11H	Vocal Canceled: Range High	10,,,201 = 1.0,,,20,0kHz,Unlimit
00H 05H	mmH 11H	EQ: Low EQ Type	0,1 = Shelving, Peaking

00H 06H	mmH 11H	EQ: Low EQ Gain	-12,,,12dB
00H 07H	mmH 11H	EQ: Low EQ Frequency	2,,,200 = 20,,,2000Hz
00H 08H	mmH 11H	EQ: Low EQ Q	3,,,100 = 0.3,,,10.0
00H 09H	mmH 11H	EQ: Mid EQ Gain	-12,,,12dB
00H 0AH	mmH 11H	EQ: Mid EQ Frequency	20,,,800 = 200,,,8000Hz
00H 0BH	mmH 11H	EQ: Mid EQ Q	3,,,100 = 0.3,,,10.0
00H 0CH	mmH 11H	EQ: High EQ Type	0,1 = Shelving, Peaking
00H 0DH	mmH 11H	EQ: High EQ Gain	-12,,,12dB
00H 0EH	mmH 11H	EQ: High EQ Frequency	14,,,200 = 1.4,,,20.0kHz
00H 0FH	mmH 11H	EQ: High EQ Q	3,,,100 = 0.3,,,10.0
00H 10H	mmH 11H	EQ: Out Level	0,,,100
00H 11H	00H 00H	(Reserved)	
:	:	:	
00H 7FH	00H 00H	(Reserved)	

○ Algorithm 27 Voice Transformer (FX1 or FX3)

NRPN	Data Entry		
00H 00H	mmH 11H	Voice Transformer SW	0,1 = Off,On
00H 01H	mmH 11H	Reverb SW	0,1 = Off,On
00H 02H	mmH 11H	(Reserved)	
00H 03H	mmH 11H	MIDI Control SW	0,1 = Off,On
00H 04H	mmH 11H	Voice Transformer: Robot SW	0,1 = Off,On
00H 05H	mmH 11H	Voice Transformer: Chromatic Pitch	-12,,,36
00H 06H	mmH 11H	Voice Transformer: Fine Pitch	-100,,,100
00H 07H	mmH 11H	Voice Transformer: Chromatic Formant	-12,,,12
00H 08H	mmH 11H	Voice Transformer: Fine Formant	-100,,,100
00H 09H	mmH 11H	Voice Transformer: Mix Balance	0,,,100
00H 0AH	mmH 11H	Reverb: Reverb Time	1,,,100 = 0.1,,,10.0sec
00H 0BH	mmH 11H	Reverb: Pre Delay	0,,,200msec
00H 0CH	mmH 11H	Reverb: Density	0,,,100
00H 0DH	mmH 11H	Reverb: Effect Level	0,,,100
00H 0EH	mmH 11H	MIDI Control: Bend Range	0,,,12 = Off,1,,,12
00H 0FH	mmH 11H	MIDI Control: Portamento	0...100 = Off,1,,,100
00H 10H	00H 00H	(Reserved)	
:	:	:	
00H 7FH	00H 00H	(Reserved)	

○ Algorithm 28 Vocoder 2 (FX1 or FX3)

NRPN	Data Entry		
00H 00H	mmH 11H	Chorus SW	0,1 = Off,On
00H 01H	mmH 11H	Vocoder: Envelope Mode	0,,,2 = Sharp,Soft,Long
00H 02H	mmH 11H	Vocoder: Pan Mode	0,,,3 = Mono,Stereo,L->R,R->L
00H 03H	mmH 11H	Vocoder: Hold	0,1 = Off,MIDI
00H 04H	mmH 11H	Vocoder: Mic Sens	0,,,100

00H 05H	mmH 11H	Vocoder: Synth Input Level	0,,,100
00H 06H	mmH 11H	Vocoder: Voice Char Level 1	0,,,100
00H 07H	mmH 11H	Vocoder: Voice Char Level 2	0,,,100
00H 08H	mmH 11H	Vocoder: Voice Char Level 3	0,,,100
00H 09H	mmH 11H	Vocoder: Voice Char Level 4	0,,,100
00H 0AH	mmH 11H	Vocoder: Voice Char Level 5	0,,,100
00H 0BH	mmH 11H	Vocoder: Voice Char Level 6	0,,,100
00H 0CH	mmH 11H	Vocoder: Voice Char Level 7	0,,,100
00H 0DH	mmH 11H	Vocoder: Voice Char Level 8	0,,,100
00H 0EH	mmH 11H	Vocoder: Voice Char Level 9	0,,,100
00H 0FH	mmH 11H	Vocoder: Voice Char Level 10	0,,,100
00H 10H	mmH 11H	Vocoder: Voice Char Level 11	0,,,100
00H 11H	mmH 11H	Vocoder: Voice Char Level 12	0,,,100
00H 12H	mmH 11H	Vocoder: Voice Char Level 13	0,,,100
00H 13H	mmH 11H	Vocoder: Voice Char Level 14	0,,,100
00H 14H	mmH 11H	Vocoder: Voice Char Level 15	0,,,100
00H 15H	mmH 11H	Vocoder: Voice Char Level 16	0,,,100
00H 16H	mmH 11H	Vocoder: Voice Char Level 17	0,,,100
00H 17H	mmH 11H	Vocoder: Voice Char Level 18	0,,,100
00H 18H	mmH 11H	Vocoder: Voice Char Level 19	0,,,100
00H 19H	mmH 11H	Vocoder: Mic High Pass Filter 9,,,200 = Thru,1.0,,,20.0kHz	
00H 1AH	mmH 11H	Vocoder: Mic High Pass Filter Pan 1,,,127 = L63,,,R63	
00H 1BH	mmH 11H	Vocoder: Mic Mix	0,,,100
00H 1CH	mmH 11H	Vocoder: Noise Suppressor Threshold	0,,,100
00H 1DH	mmH 11H	Chorus: Rate 1,,,100 = 0.1,,,10.0Hz	
00H 1EH	mmH 11H	Chorus: Depth	0,,,100
00H 1FH	mmH 11H	Chorus: Pre Delay	0,,,50ms
00H 20H	mmH 11H	Chorus: Mix Balance	0,,,100
00H 21H	00H 00H	(Reserved)	
:	:	:	
00H 7FH	00H 00H	(Reserved)	

○ Algorithm 29 Mic Modeling

NRPN	Data Entry		
00H 00H	mmH 11H	Link SW	0,1 = Off,On
00H 01H	mmH 11H	Mic Converter Ach SW	0,1 = Off,On
00H 02H	mmH 11H	Bass Cut Ach SW	0,1 = Off,On
00H 03H	mmH 11H	Distance Ach SW	0,1 = Off,On
00H 04H	mmH 11H	Limiter Ach SW	0,1 = Off,On
00H 05H	mmH 11H	Mic Converter Bch SW	0,1 = Off,On
00H 06H	mmH 11H	Bass Cut Bch SW	0,1 = Off,On

00H 07H	mmH 11H	Distance Bch SW	0,1 = Off,On
00H 08H	mmH 11H	Limiter Bch SW	0,1 = Off,On
00H 09H	mmH 11H	Mic Converter Ach: Input 0,,,4 = DR-20,SmlDy,HedDy,MinCn,Flat	
00H 0AH	mmH 11H	Mic Converter Ach: Output 0,,,6 = SmlDy,VocDy,LrgDy,SmlCn,LrgCn, VntCn,Flat	
00H 0BH	mmH 11H	Mic Converter Ach: Phase 0,1 = Normal,Inverse	
00H 0CH	mmH 11H	Bass Cut Ach: Bass Cut Frequency 1,,,200 = Thru,20,,,2000Hz	
00H 0DH	mmH 11H	Distance Ach: Proximity Effect	-12,,,+12
00H 0EH	mmH 11H	Distance Ach: Timelag 0,,,1000 = 0,,,3000cm	
00H 0FH	mmH 11H	Limiter Ach: Detect HPF Frequency 1,,,200 = Thru,20,,,2000Hz	
00H 10H	mmH 11H	Limiter Ach: Level	-60,,,24dB
00H 11H	mmH 11H	Limiter Ach: Threshold	-60,,,0dB
00H 12H	mmH 11H	Limiter Ach: Attack	0,,,100
00H 13H	mmH 11H	Limiter Ach: Release	0,,,100
00H 14H	mmH 11H	Mic Converter Bch: Input 0,,,4 = DR-20,SmlDy,HedDy,MinCn,Flat	
00H 15H	mmH 11H	Mic Converter Bch: Output 0,,,6 = SmlDy,VocDy,LrgDy,SmlCn,LrgCn, VntCn,Flat	
00H 16H	mmH 11H	Mic Converter Bch: Phase 0,1 = Normal,Inverse	
00H 17H	mmH 11H	Bass Cut Bch: Bass Cut Frequency 1,,,200 = Thru,20,,,2000Hz	
00H 18H	mmH 11H	Distance Bch: Proximity Effect	-12,,,+12
00H 19H	mmH 11H	Distance Bch: Timelag 0,,,1000 = 0,,,3000cm	
00H 1AH	mmH 11H	Limiter Bch: Detect HPF Frequency 1,,,200 = Thru,20,,,2000Hz	
00H 1BH	mmH 11H	Limiter Bch: Level	-60,,,24dB
00H 1CH	mmH 11H	Limiter Bch: Threshold	-60,,,0dB
00H 1DH	mmH 11H	Limiter Bch: Attack	0,,,100
00H 1EH	mmH 11H	Limiter Bch: Release	0,,,100
00H 1FH	00H 00H	(Reserved)	
:	:	:	
00H 7FH	00H 00H	(Reserved)	

- * When Mic converter Input = MinCn, Output is fixed to SmlDy,LrgCn.
- * When Link SW = On, Bch corresponds to Ach.

○ Algorithm 30 3 Band Isolator

NRPN	Data Entry		
00H 00H	mmH 11H	Isolator SW	0,1 = Off,On
00H 01H	mmH 11H	Isolator High Volume	-60,,,+4dB
00H 02H	mmH 11H	Isolator Middle Volume	-60,,,+4dB
00H 03H	mmH 11H	Isolator Low Volume	-60,,,+4dB
00H 04H	mmH 11H	Isolator Anti Phase Middle Switch	0,1 = Off,On
00H 05H	mmH 11H	Isolator Anti Phase Middle Level	0,,,100
00H 06H	mmH 11H	Isolator Anti Phase Low Switch	0,1 = Off,On
00H 07H	mmH 11H	Isolator Anti Phase Low Level	0,,,100
00H 08H	00H 00H	(Reserved)	
:	:	:	
00H 7FH	00H 00H	(Reserved)	

MIDI Implementation

○ Algorithm 31 Tape Echo 201

NRPN	Data Entry	
00H 00H	mmH 11H	Tape Echo SW 0,1 = Off,On
00H 01H	mmH 11H	Tape Echo Mode Select 0,,,6 = 1,,,7
00H 02H	mmH 11H	Tape Echo Repeat Rate 0,,,100
00H 03H	mmH 11H	Tape Echo Intensity 0,,,100
00H 04H	mmH 11H	Tape Echo Effect Level 0,,,100
00H 05H	mmH 11H	Tape Echo Direct Level 0,,,100
00H 06H	mmH 11H	Tape Echo Tone Bass -100,,,100
00H 07H	mmH 11H	Tape Echo Tone Treble -100,,,100
00H 08H	mmH 11H	Tape Echo Tape Head S Pan 1,,,127 = L63,,,R63
00H 09H	mmH 11H	Tape Echo Tape Head M Pan 1,,,127 = L63,,,R63
00H 0AH	mmH 11H	Tape Echo Tape Head L Pan 1,,,127 = L63,,,R63
00H 0BH	mmH 11H	Tape Echo Tape Distortion 0,,,100
00H 0CH	mmH 11H	Tape Echo Wah Flutter Rate 0,,,100
00H 0DH	mmH 11H	Tape Echo Wah Flutter Depth 0,,,100
00H 0EH	00H 00H	(Reserved)
00H 7FH	00H 00H	(Reserved)

○ Algorithm 32 Analog Flanger

NRPN	Data Entry	
00H 00H	mmH 11H	Analog Flanger SW 0,1 = Off,On
00H 01H	mmH 11H	Analog Flanger Mode 0,,,3 = FL1,FL2,FL3,CHO
00H 02H	mmH 11H	Analog Flanger Feedback 0,,,100
00H 03H	mmH 11H	Analog Flanger Modulation Rate 0,,,100
00H 04H	mmH 11H	Analog Flanger Modulation Depth 0,,,100
00H 05H	mmH 11H	Analog Flanger Modulation Frequency 0,,,100
00H 06H	mmH 11H	Analog Flanger Channel B Modulation 0,1 = Nor,Inv
00H 07H	mmH 11H	Analog Flanger Channel A Phase 0,1 = Nor,Inv
00H 08H	mmH 11H	Analog Flanger Channel B Phase 0,1 = Nor,Inv
00H 09H	00H 00H	(Reserved)
00H 7FH	00H 00H	(Reserved)

○ Algorithm 33 Analog Phaser

NRPN	Data Entry	
00H 00H	mmH 11H	Analog Phaser SW 0,1 = Off,On
00H 01H	mmH 11H	Analog Phaser Mode 0,1 = 4STAGE,8STAGE
00H 02H	mmH 11H	Analog Phaser Frequency 0,,,100
00H 03H	mmH 11H	Analog Phaser Resonance 0,,,100
00H 04H	mmH 11H	Analog Phaser LFO 1 Rate 0,,,100
00H 05H	mmH 11H	Analog Phaser LFO 1 Depth 0,,,100
00H 06H	mmH 11H	Analog Phaser LFO 1 Channel B Mod 0,1 = Nor,Inv

00H 07H	mmH 11H	Analog Phaser LFO 2 Rate 0,,,100
00H 08H	mmH 11H	Analog Phaser LFO 2 Depth 0,,,100
00H 09H	mmH 11H	Analog Phaser LFO 2 Channel B Mod 0,1 = Nor,Inv
00H 0AH	00H 00H	(Reserved)
00H 7FH	00H 00H	(Reserved)

○ Algorithm 34 Speaker Modeling

NRPN	Data Entry	
00H 00H	mmH 11H	Speaker Modeling SW 0,1 = Off,On
00H 01H	mmH 11H	Bass Cut SW 0,1 = Off,On
00H 02H	mmH 11H	Low Frequency Trimmer SW 0,1 = Off,On
00H 03H	mmH 11H	High Frequency Trimmer SW 0,1 = Off,On
00H 04H	mmH 11H	Limiter SW 0,1 = Off,On
00H 05H	mmH 11H	Output Speakers 0,1 = DS-90/DS-90A,DS-50A
00H 06H	mmH 11H	Speaker Modeling Model 0,,,11 = THRU,Super Flat,Powered GenBlk,Powered E-Bas,Powered Mack,Small Cube,White Cone,White C +tissue,Small Radio,Small TV,Boom Box,BoomBox LoBoost
00H 07H	mmH 11H	Speaker Modeling Phase 0,1 = NRM,INV
00H 08H	mmH 11H	Bass Cut Frequency 1,,,200 = Thru,20,,,2000Hz
00H 09H	mmH 11H	Low Frequency Trimmer Gain -12,,,12dB
00H 0AH	mmH 11H	Low Frequency Trimmer Frequency 2,,,200 = 20,,,2000Hz
00H 0BH	mmH 11H	High Frequency Trimmer Gain -12,,,12dB
00H 0CH	mmH 11H	High Frequency Trimmer Frequency 10,,,200 = 1.0,,,20.0kHz
00H 0DH	mmH 11H	Limiter Threshold -60,,,0dB
00H 0EH	mmH 11H	Limiter Release 0,,,100
00H 0FH	mmH 11H	Limiter Level -60,,,24dB
00H 10H	00H 00H	(Reserved)
00H 7FH	00H 00H	(Reserved)

○ Algorithm 35 Mastering Tool Kit (FX1 or FX3)

NRPN	Data Entry	
00H 00H	mmH 11H	EQ SW 0,1 = Off,On
00H 01H	mmH 11H	Bass Cut SW 0,1 = Off,On
00H 02H	mmH 11H	Enhancer SW 0,1 = Off,On
00H 03H	mmH 11H	Expander SW 0,1 = Off,On
00H 04H	mmH 11H	Compressor SW 0,1 = Off,On
00H 05H	mmH 11H	Limiter SW 0,1 = Off,On
00H 06H	mmH 11H	EQ: Input Gain -24,,,12dB
00H 07H	mmH 11H	EQ: Low EQ Type 0,1 = Shelving, Peaking
00H 08H	mmH 11H	EQ: Low EQ Gain -12,,,12dB
00H 09H	mmH 11H	EQ: Low EQ Frequency 2,,,42 = 20,,,2000Hz(*1 Frequency Table)
00H 0AH	mmH 11H	EQ: Low EQ Q 0,,,31 = 0.3,,,16.0(*2 Q Table)

00H 0BH	mmH 11H	EQ: Low Mid EQ Gain -12,,,12dB
00H 0CH	mmH 11H	EQ: Low Mid EQ Frequency 2,,,54 = 20,,,8000Hz(*1 Frequency Table)
00H 0DH	mmH 11H	EQ: Low Mid EQ Q 0,,,31 = 0.3,,,16.0(*2 Q Table)
00H 0EH	mmH 11H	EQ: High Mid EQ Gain -12,,,12dB
00H 0FH	mmH 11H	EQ: High Mid EQ Frequency 2,,,54 = 20,,,8000Hz(*1 Frequency Table)
00H 10H	mmH 11H	EQ: High Mid EQ Q 0,,,31 = 0.3,,,16.0(*2 Q Table)
00H 11H	mmH 11H	EQ: High EQ Type 0,1 = Shelving, Peaking
00H 12H	mmH 11H	EQ: High EQ Gain -12,,,12dB
00H 13H	mmH 11H	EQ: High EQ Frequency 39,,,62 = 1.4,,,20.0kHz(*1 Frequency Table)
00H 14H	mmH 11H	EQ: High EQ Q 0,,,31 = 0.3,,,16.0(*2 Q Table)
00H 15H	mmH 11H	EQ: Level -24,,,12dB
00H 16H	mmH 11H	Bass Cut Frequency 1,,,42 = Off,20,,,2000Hz(*1 Frequency Table)
00H 17H	mmH 11H	Enhancer Sens 0,,,100
00H 18H	mmH 11H	Enhancer Frequency 36,,,56 = 1.0,,,10.0kHz(*1 Frequency Table)
00H 19H	mmH 11H	Enhancer Mix Level -24,,,12dB
00H 1AH	mmH 11H	Input Gain -24,,,12dB
00H 1BH	mmH 11H	Input Detect Time 0,,,10ms
00H 1CH	mmH 11H	Input Low Split Point 2,,,34 = 20,,,800Hz(*1 Frequency Table)
00H 1DH	mmH 11H	Input High Split Point 40,,,60 = 1.6,,,16.0kHz(*1 Frequency Table)
00H 1EH	mmH 11H	Expander Low Threshold 0,,,80 = -80,,,0dB
00H 1FH	mmH 11H	Expander Mid Threshold 0,,,80 = -80,,,0dB
00H 20H	mmH 11H	Expander High Threshold 0,,,80 = -80,,,0dB
00H 21H	mmH 11H	Expander Low Ratio 0,,,13 = 1:1.0,,,1:INF(*3 Ratio Table)
00H 22H	mmH 11H	Expander Mid Ratio 0,,,13 = 1:1.0,,,1:INF(*3 Ratio Table)
00H 23H	mmH 11H	Expander High Ratio 0,,,13 = 1:1.0,,,1:INF(*3 Ratio Table)
00H 24H	mmH 11H	Expander Low Attack 0,,,100ms
00H 25H	mmH 11H	Expander Mid Attack 0,,,100ms
00H 26H	mmH 11H	Expander High Attack 0,,,100ms
00H 27H	mmH 11H	Expander Low Release 0,,,100 = 50,,,5000ms
00H 28H	mmH 11H	Expander Mid Release 0,,,100 = 50,,,5000ms
00H 29H	mmH 11H	Expander High Release 0,,,100 = 50,,,5000ms
00H 2AH	mmH 11H	Compressor Low Threshold -24,,,0dB
00H 2BH	mmH 11H	Compressor Mid Threshold -24,,,0dB
00H 2CH	mmH 11H	Compressor High Threshold -24,,,0dB
00H 2DH	mmH 11H	Compressor Low Ratio 0,,,13 = 1:1.0,,,1:INF(*3 Ratio Table)
00H 2EH	mmH 11H	Compressor Mid Ratio 0,,,13 = 1:1.0,,,1:INF(*3 Ratio Table)
00H 2FH	mmH 11H	Compressor High Ratio 0,,,13 = 1:1.0,,,1:INF(*3 Ratio Table)
00H 30H	mmH 11H	Compressor Low Attack 0,,,100ms
00H 31H	mmH 11H	Compressor Mid Attack 0,,,100ms

00H 32H	mmH 11H	Compressor High Attack 0,,,100ms
00H 33H	mmH 11H	Compressor Low Release 0,,,100 = 50,,,5000ms
00H 34H	mmH 11H	Compressor Mid Release 0,,,100 = 50,,,5000ms
00H 35H	mmH 11H	Compressor High Release 0,,,100 = 50,,,5000ms
00H 36H	mmH 11H	Mixer Low Level 0,,,86 = -80,,,6dB
00H 37H	mmH 11H	Mixer Mid Level 0,,,86 = -80,,,6dB
00H 38H	mmH 11H	Mixer High Level 0,,,86 = -80,,,6dB
00H 39H	mmH 11H	Limiter Threshold -24,,,0dB
00H 3AH	mmH 11H	Limiter Attack 0,,,100ms
00H 3BH	mmH 11H	Limiter Release 0,,,100 = 50,,,5000ms
00H 3CH	mmH 11H	Output Level 0,,,86 = -80,,,6dB
00H 3DH	mmH 11H	Output Soft Clip 0,1 = Off,On
00H 3EH	00H 00H	(Reserved)
:	:	:
00H 7FH	00H 00H	(Reserved)

* 1 Effect Frequency Table

Data	Freq(Hz)	Data	Freq(Hz)	Data	Freq(Hz)	Data	Freq(Hz)
0	THRU	16	100	32	630	48	4.00k
1	THRU	17	112	33	710	49	4.50k
2	20.0	18	125	34	800	50	5.00k
3	22.4	19	140	35	900	51	5.60k
4	25.0	20	160	36	1.00k	52	6.30k
5	28.0	21	180	37	1.12k	53	7.10k
6	31.5	22	200	38	1.25k	54	8.00k
7	35.5	23	224	39	1.40k	55	9.00k
8	40.0	24	250	40	1.60k	56	10.0k
9	45.0	25	280	41	1.80k	57	11.2k
10	50.0	26	315	42	2.00k	58	12.5k
11	56.0	27	355	43	2.24k	59	14.0k
12	63.0	28	400	44	2.50k	60	16.0k
13	71.0	29	450	45	2.80k	61	18.0k
14	80.0	30	500	46	3.15k	62	20.0k
15	90.0	31	560	47	3.55k	63	22.4k

* 2 Effect Q Table

Data	Q	Data	Q
0	0.3	16	2.8
1	0.4	17	3.1
2	0.5	18	3.5
3	0.6	19	4.0
4	0.7	20	4.5
5	0.8	21	5.0
6	0.9	22	5.6
7	1.0	23	6.3
8	1.1	24	7.1
9	1.2	25	8.0
10	1.4	26	9.0
11	1.6	27	10.0
12	1.8	28	11.2
13	2.0	29	12.5
14	2.2	30	14.0
15	2.5	31	16.0

* 3 Ratio Table

Data	RATIO
0	1:1.0 (OFF)
1	1:1.1
2	1:1.2
3	1:1.4
4	1:1.6
5	1:1.8
6	1:2.0
7	1:2.5
8	1:3.1
9	1:4.0
10	1:5.6
11	1:8.0
12	1:16
13	1:INF

MIDI Implementation

●Program Change

Parameters on the Mixer/Effect section can be changed when UTILITY-MIDI screens EFFECT P.C.Rx Sw is "On."

When UTILITY-MIDI screens EFFECT P.C. Rx Sw is "On," 00H-03H is received if it operates as the Effect Program Change.

When UTILITY-MIDI screens SCENE P.C. Rx Sw is "On," MIDI Channel No. FH is received if it operates as the Scene Change.

If V-LINK function is enable, see "5.V-LINK".

```
Status  Second
-----  -----
CnH     ppH

n = MIDI Channel No.:
0H - 3H (ch.1 = FX1 ch.2 = FX2 ch.3 = FX3 ch.4 = FX4)
FH (ch.16 = Scene Memory (*1))
pp = Program No. : 00H - 63H (0 - 99) n = 0H - 3H
pp = Program No. : 00H - 63H (0 - 99) n = FH
```

(*1) If received while VS-2400CD is playing, play back stops, and then restarts after the scene switched. Never receives while recording.

●Pitch Bend Change

Receives when effect Algorithm 27 (Voice Transformer) is selected and MIDI control Sw is On.

```
Status  Second  Third
-----  -----  -----
EnH     llH     mmH

n = MIDI Channel No.: 0H - 3H (ch.1-ch.4)
n = 0,2 (ch.1 = FX1, ch.3 = FX3)
: Voice Transformer: Fine Pitch
n = 1,3 (ch.2 = FX1, ch.4 = FX3)
: Voice Transformer: Fine Formant
mm, ll = Value : 00H,00H - 40H,00H - 7FH,7FH
(-8192 - 0 - +8191)
```

■System Common Messages

●MIDI Time Code Quarter Frame Messages

MIDI Time Code Quarter Frame Messages can be transmitted while the VS-2400CD is running (Playing or Recording) if the UTILITY-SYNC screens SYNC MODE is "INT" and SYNC Gen. is "MTC."

The transmitted time counts are summed to "SYNC OFF SET TIME" as the project top is "00:00:00:00."

The VS-2400CD synchronizes with the time counts which are summed to "SYNC OFFSET TIME" as the project top is "00:00:00:00" if the SYNC screens SYNC MODE is "EXT."

```
Status  Second
-----  -----
F1H     mmH (= 0nnndddd)

nnn = Message type: 0 = Frame count LS nibble
1 = Frame count MS nibble
2 = Seconds count LS nibble
3 = Seconds count MS nibble
4 = Minutes count LS nibble
5 = Minutes count MS nibble
6 = Hours count LS nibble
7 = Hours count MS nibble
dddd = 4bit nibble data : 0H - FH (0 - 15)
```

If the upper and lower 4 bits of the count are combined, these bit fields are assigned as follows.

```
Frame Count  xxxxyyyy  Reserved (000)
              xxxx   Frame No. (0-29)
Seconds Count  yyyyyy   Reserved (00)
              yy     Second Count (0-59)
Minutes Count  xxxxyyyy  Reserved (00)
              xx     Minutes Count (0-59)
Hour Count    yyyyyy   Reserved (0)
              xyzzzz  Time Code Type
              x       0 = 24 Frame/Sec
              yy     1 = 25 Frame/Sec
                   2 = 30 Frame/Sec (Drop Frame)
                   3 = 30 Frame/Sec (Non Drop Frame)
                   zzzzz  Hours Count
```

●Song Position Pointer

The current position is transmitted with the Song Position Pointer Message before the VS-2400CD starts top run or after the locate operation when UTILITY-SYNC screens SYNC MODE is "INT" and SYNC Gen. is "MIDIclk" or "SyncTr."

```
Status  Second  Third
-----  -----  -----
F2H     mmH     nnH

mm,nn = Song Position Point: 00H 00H - 7FH 7FH
```

■System Real time Message

Transmitted when UTILITY-SYNC screens SYNC MODE is "INT" and SYNC Gen. is "MIDIclk" or "SyncTr."

●Timing Clock

```
Status
-----
F8H
```

●Start

```
Status
-----
FAH
```

●Continue

```
Status
-----
FBH
```

●Stop

```
Status
-----
FCH
```

■System Exclusive Message

```
Status  Data Byte  Status
-----  -----  -----
F0H     iiH,ddH, ..., eeH  F7H
```

```
Byte  Description
----  -----
F0H   Status of System Exclusive Message
iiH   Manufacturer ID
      41H Roland's Manufacturer ID
      7EH Universal Non Real-time Message
      7FH Universal Real-time Message
ddH   Data: 00H - 7FH (0 - 127)
:     :
eeH   Data
F7H   EOX (End of System Exclusive message)
```

The VS-2400CD can transfer and receive the internal parameters information using system exclusive messages, and also can be controlled by the external devices using system exclusive message.

The VS-2400CD can transmit and receive Universal System Exclusive messages, Data Request (RQ1) and Data set (DT1) as the System Exclusive Message.

○About Model ID

The Model ID of the VS-2400CD is 00H,61H as for Data Request (RQ1) and Data set (DT1). The VS-2400CD also can receive 00H,61H (VS-2400CD) and 00,36H (VE-7000).

○About Device ID

System Exclusive messages are not assigned to any particular MIDI channel. Instead, they have their own special control parameter called device ID.

The roland system exclusive messages use device IDs to specify multiple VS-2400CD units. The VS-2400CD sends system exclusive messages using 00H-1FH, and receives the system exclusive messages whose device ID is same as its device ID and 7FH. the value of the device ID is the value set on the UTILITY-MIDI screens DEVICE ID minus one.

●Universal System Exclusive message

○Identify Request

```
Status  Data Byte  Status
-----  -----  -----
F0H     7EH,Dev,06H,01H  F7H
```

```
Byte  Description
----  -----
F0H   Status of System Exclusive Message
7EH   Universal System Exclusive message Non Real-time header
Dev   Device ID (or 7FH)
06H   General Information (sub-ID #1)
01H   Identify Request (sub-ID #2)
F7H   EOX (End of System Exclusive Message)
```

The message is used to request the particular information of the VS-2400CD.

The VS-2400CD does not transmit the message.

If the VS-2400CD received the message and the device ID of the message is same as its device.

ID or 7FH, the VS-2400CD transmits the following Identify Reply message.

○Identify Reply

```
Status  Data Byte  Status
-----  -----  -----
F0H     7EH,Dev,06H,02H,41H,mmH,nnH,00H,00H,00H,00H,  F7H
        ssH,ssH
```

```
Byte  Description
----  -----
F0H   Status of System Exclusive Message
7EH   Universal System Exclusive Non Real-time Header
Dev   Device ID
06H   General Information (sub-ID #1)
```

02H	Identify Request (sub-ID #2)
41H	Manufacturer ID (Roland)
mmH mmH	Device Family Code (VS-2400CD)
00H 00H	Device Family No.
00H	
00H	
ssH ssH	Software Revision Level
F7H	EOX (End of Exclusive Message)

When VS-2400CD, the value of the device family code is 61H 01H.

○MIDI Time Code

Status	Data Byte	Status
-----	-----	-----
F0H	7FH, Dev, 01H, 01H, hr, mn, sc, fr	F7H
Byte	Description	
-----	-----	
F0H	Status of System Exclusive Message	
7FH	Universal System Exclusive Real-time Header	
Dev	Device ID	
01H	MIDI Time Code	
01H	MIDI Time Code Full Message	
	hr Type/Hour (0yyzzzzz)	
	yy: Time Code Type	
	0=24 Frame/Sec	
	1=25 Frame/Sec	
	2=30 Frame/Sec (Drop)	
	3=30 Frame/Sec (Non-Drop)	
	mn Minutes (0-59)	
	sc Second (0-59)	
	fr Frame (0-29)	
F7H	EOX (End of Exclusive Message)	

○MIDI Machine Control Commands

Status	Data Byte	Status
-----	-----	-----
F0H	7FH, Dev, 06H, aaH, . . . , bbH	F7H
Byte	Description	
-----	-----	
F0H	Status of System Exclusive Message	
7FH	Universal System Exclusive Real-time Header	
Dev	Device ID (or 7FH)	
06H	MMC Command Message	
aaH	Command	
:	:	
bbH	Command	
F7H	EOX (End of Exclusive Message)	

(*) see "3. MIDI Machine Control."

●Data Transfer (RQ1,DT1)

○Data Request (RQ1)

Status	Data Byte	Status
-----	-----	-----
F0H	41H, Dev, 00H, 61H, 11H, aaH, bbH, ccH, ddH, ssH, ssH, ssH, ssH, Sum	F7H
Byte	Description	
-----	-----	
F0H	Status of System Exclusive Message	
41H	Manufacturer ID (Roland)	
Dev	Device ID	
00H 61H	Model ID (VS-2400CD)	
11H	Command ID (RQ1)	
aaH	Address MSB	
bbH	Address	
ccH	Address	
ddH	Address LSB	
ssH	Data MSB	
ssH	Data	
ssH	Data	
ssH	Data LSB	
Sum	Check Sum	
F7H	EOX (End of Exclusive Message)	

○Data Set (DT1)

<Model ID = 00H 61H (VS-2400CD)>

Status	Data Byte	Status
-----	-----	-----
F0H	41H, Dev, 00H, 61H, 12H, aaH, bbH, ccH, ddH, . . . , eeH, Sum	F7H
Byte	Description	
-----	-----	
F0H	Status of System Exclusive Message	
41H	Manufacturer ID (Roland)	
Dev	Device ID	
00H 61H	Model ID (VS-2400CD)	
12H	Command ID (DT1)	
aaH	Address MSB	
bbH	Address	
ccH	Address	
ddH	Address LSB	
eeH	Data	
Sum	Check Sum	
F7H	EOX (End of Exclusive Message)	

<Model ID = 00H 36H (VE-7000)>

Status	Data Byte	Status
-----	-----	-----
F0H	41H, Dev, 00H, 36H, 12H, aaH, bbH, ccH, ddH, . . . , eeH, Sum	F7H

Byte	Description
-----	-----
F0H	Status of System Exclusive Message
41H	Manufacturer ID (Roland)
Dev	Device ID
00H 36H	Model ID (VE-7000)
12H	Command ID (DT1)
aaH	Address MSB
bbH	Address
ccH	Address LSB
ddH	Data
Sum	Check Sum
F7H	EOX (End of Exclusive Message)

○The message is transmitted under the following condition.

If the device ID on the message is same as that of the receive device, and the address on the message correspond to the specified parameter base address, the received data are stored form the specified parameter base address.

If the interval of received messages is shorter than 25 msec, the VS-2400CD can not work the receive message procedure correctly.

2. Data Transfer Address Map

●Address Block

<Model ID = 00H 61H (VS-2400CD)>

Address are expressed in 7bit hexadecimal values.

Address	MSB			LSB
Binary	0aaa aaaa	0bbb bbbb	0ccc cccc	0ddd dddd
7 Bit Hex	AA	BB	CC	DD

Start address	Contents and remarks
00 00 00 00	(Reserved)
02 00 00 00	Utility Parameter
03 00 00 00	Project Parameter
04 00 00 00	Mixer Parameter
05 00 00 00	Effect Parameter
06 00 00 00	Sync Track Data

●Utility Parameter

Start address	Data	Contents and remarks
02 00 00 00	00 - 01	PHANTOM SWITCH ANALOG INPUT1 Off, On
02 00 00 01	00 - 01	PHANTOM SWITCH ANALOG INPUT2 Off, On
02 00 00 02	00 - 01	PHANTOM SWITCH ANALOG INPUT3 Off, On
02 00 00 03	00 - 01	PHANTOM SWITCH ANALOG INPUT4 Off, On
02 00 00 04	00 - 01	PHANTOM SWITCH ANALOG INPUT5 Off, On
02 00 00 05	00 - 01	PHANTOM SWITCH ANALOG INPUT6 Off, On
02 00 00 06	00 - 01	PHANTOM SWITCH ANALOG INPUT7 Off, On
02 00 00 07	00 - 01	PHANTOM SWITCH ANALOG INPUT8 Off, On
02 00 00 08	00 - 08	MB-24 DISPLAY SECTION OFF, ANALOG INPUT 1-8, R-BUS/COAX/OPT IN, INPUT MIXER 1-16, TRACK MIXER 1-24, FX1-4 RETURN, AUX1-8/DIR1-8, ANALOG OUTPUT, R-BUS/COAX/OPT OUT
02 00 00 09	00 - 01	MB-24 METER POSITION Pre, Pst
02 00 00 0A	00 - 02	MB-24 TIME DISPLAY MEASURE/BEAT, TIME CODE, CLOCK/SCENE
02 00 00 0B	00 - 01	MB-24 METER SCALE x1, x1/2
02 00 00 0C	00 - 01	VGA OUT Off, On
02 00 00 0D	00 - 03	VGA REFRESH RATE 60, 66, 70, 75Hz
02 00 00 0E	01 - 0B	VGA H. POSITION +5, . . . , -5
02 00 00 0F	01 - 2C 01 - 20 01 - 4B 01 - 17	VGA V. POSITION -21, . . . , 0, . . . , +22 (VGA REFRESH RATE = 60 Hz) -15, . . . , 0, . . . , +16 (VGA REFRESH RATE = 65 Hz) -37, . . . , 0, . . . , +37 (VGA REFRESH RATE = 70 Hz) -11, . . . , 0, . . . , +11 (VGA REFRESH RATE = 75 Hz)
02 00 00 10	00 - 01	PS/2 MOUSE Off, On
02 00 00 11	00 - 04	PS/2 MOUSE POINTER SPEED 0, . . . , 4
02 00 00 12	00 - 01	PS/2 KEYBOARD Off, On
02 00 00 13	00 - 05	PS/2 KEYBOARD TYPE 101/104, 106/109, French, Germany, Italian, Spanish
02 01 00 00	00 - 02	INPUT PEAK LEVEL 0, -3, -6dB
02 01 00 01	00 - 05	FOOT SWITCH ASSIGN Play/Stop, Record, TapMarker, Next, Previous, GPI

MIDI Implementation

02 01 00 02	00 - 01	CD DIGITAL REC	Off,On
02 01 00 03	00 - 02	SHIFT LOCK	Off,On,Once
02 01 00 04	03 - 14	SWITCHING TIME	0.3,,,2.0sec
02 01 00 05		(Reserved)	
02 01 00 06	00 - 01	PREVIOUS/NEXT SWITCH	Phrase,Marker
02 01 00 07	00 - 01	LOCATOR/SCENE TYPE	Safe,Quick
02 01 00 08	00 - 01	NUMERICS TYPE	Up,Down
02 01 00 09	00 - 01	UNDO MESSAGE	Off,On
02 01 00 0A	00 - 01	EDIT MESSAGE	Off,On
02 01 00 0B		(Reserved)	
02 01 00 0C		(Reserved)	
02 01 00 0D		(Reserved)	
02 01 00 0E	00 - 01	DATE/REMAIN SWITCH	Date,Remain
02 01 00 0F	00 - 03	REMAIN DISPLAY TYPE	Time,CapaMB,Capa %,Event
02 01 00 10	00 - 01	RETURN TO LOCATE SWITCH	Off,On
02 01 00 11	00 - 01	EDIT POINT SWITCH TYPE	Same LOCATOR,OVERWRITE
02 01 00 12	00 - 1E	SCREEN SAVER	Off,1,,,30min
02 02 00 00	00 - 03	MASTER CLOCK	INT,R-BUS,DIGITAL IN, EXT TIME CODE
02 02 00 01	00 - 7F	DITHER	127,24,,,8 = Off,24,,,8bit
02 02 00 02	00 - 01	DIGITAL COPY PROTECT	Off,On
02 02 00 03		(Reserved)	
02 02 00 04	0000aaaa	DISPLAY OFFSET TIME	(*1,2,3)
02 02 00 05#	0000bbbb	aaaabbbbccccddddeeeeffffgggghhhh =	
02 02 00 06#	0000cccc	0,,,4294967295block (1block=16sample)	
02 02 00 07#	0000dddd		
02 02 00 08#	0000eeee		
02 02 00 09#	0000ffff		
02 02 00 0A#	0000gggg		
02 02 00 0B#	0000hhhh		
02 02 00 0C	00 - 01	TIME DISPLAY FORMAT	ABS,REL
02 02 00 0D	00 - 01	PEAK HOLD SWITCH	Off,On
02 02 00 0E		(Reserved)	
02 02 00 0F		(Reserved)	
02 02 00 10	00 - 01	DIGITAL IN SELECT	COAXIAL,OPTICAL
02 03 00 00	00 - 01	RECORD MONITOR	Auto,Source
02 03 00 01	00 - 01	MARKER STOP	Off,On
02 03 00 02	00 - 01	FADE CURVE	Linear/Exp
02 03 00 03	00 - 05	FADE LENGTH	2,10,20,30,40,50ms
02 03 00 04	00 - 01	VARI PITCH SWITCH	Off,On
02 03 00 05		(Reserved)	
02 03 00 06	0aaaaaaa	VARI PITCH	
02 03 00 07#	0bbbbbbb	499,,,1561 = 50.00,,,16.00kHz	
02 03 00 08#	0ccccccc	(SAMPLE RATE = 32,44.1,48kHz)	
02 03 00 09#	0ddddddd	254,,,1561 = 98.00,,,16.00kHz	
		(SAMPLE RATE = 64,88.2,96kHz)	
02 03 00 0A	00 - 01	SOLO/MUTE TYPE	All BUS Send,MIX BUS Send
02 03 00 0B	00 - 4B	SCRUB LENGTH	25,,,100ms
02 03 00 0C	0A - 64	PREVIEW TO LENGTH	1.0,,,10,0sec
02 03 00 0D	0A - 64	PREVIEW FROM LENGTH	1.0,,,10,0sec
02 04 00 00	00 - 01	MIDI OUT/THRU SWITCH	Out,Thru
02 04 00 01		(Reserved)	
02 04 00 02	00 - 02	MMC MODE	Off,Master,Slave
02 04 00 03	00 - 01	MMC SOURCE	MIDI,R-BUS
02 04 00 04		(Reserved)	
02 04 00 05	00 - 01	MIDI SYSTEM EXCLUSIVE TX SWITCH	Off,On
02 04 00 06	00 - 02	MIXER CONTROL TYPE	Off,CC,SysEx
02 04 00 07	00 - 01	SCENE CHANGE BY PROGRAM CHANGE SWITCH	Off,On
02 04 00 08	00 - 01	FX CHANGE BY PROGRAM CHANGE SWITCH	Off,On
02 04 00 09	00 - 01	FX CONTROL BY CONTROL CHANGE SWITCH	Off,On
02 05 00 00	00 - 01	SYNC Mode	INT,EXT
02 05 00 01	00 - 01	SYNC with Gap	Off,On

02 05 00 02	00 - 01	EXT SYNC SOURCE	MIDI IN,R-BUS
02 05 00 03		(Reserved)	
02 05 00 04	0000aaaa	SYNC OFFSET TIME	(*1,2,3)
02 05 00 05#	0000bbbb	aaaabbbbccccddddeeeeffffgggghhhh =	
02 05 00 06#	0000cccc	0,,,4294967295block (1block=16sample)	
02 05 00 07#	0000dddd		
02 05 00 08#	0000eeee		
02 05 00 09#	0000ffff		
02 05 00 0A#	0000gggg		
02 05 00 0B#	0000hhhh		
02 05 00 0C	00 - 04	FRAME RATE	24,25,29D,29N,30
02 05 00 0D	00 - 0A	SYNC ERROR LEVEL	0,,,10
02 05 00 0E	00 - 03	MIDI OUT SYNC GENERATE	Off,MTC,MIDIclk,SyncTr
02 05 00 0F	00 - 01	R-BUS SYNC GENERATE	Off,MTC
02 05 00 10		(Reserved)	
02 05 00 11	00 - 01	SYNC TRACK ENABLE	Off,On
02 05 00 12	00 - 01	SYNC AUTO	Off,On
02 06 00 00		TEMPO MAP-1	(Reserved)
02 06 00 0F		TEMPO MAP-1	(Reserved)
02 06 00 10	0aaaaaaa	TEMPO MAP-1	TEMPO
02 06 00 11#	0bbbbbbb		250 - 2500 = 25.0 - 250.0
02 06 00 12	0aaaaaaa	TEMPO MAP-1	MEASURE
02 06 00 13#	0bbbbbbb		1,,,999
02 06 00 14	00 - 4F	TEMPO MAP-1	Beat 0 - 79 =
02 06 00 15#			1/1,2/1,3/1,,,15/16,16/16
02 06 00 16	00	TEMPO MAP-1	(Reserved)
02 06 00 1F#	00		
02 06 00 20		TEMPO MAP-2	(See TEMPO MAP-1, 32bytes each)
:		:	
02 06 0C 3F#		TEMPO MAP-50	
02 06 0C 40	01 - 32	Total TEMPO MAP NUMBER	1,,,50
02 07 00 00	00 - 02	METRONOME OUT	Off,INT,MIDI
02 07 00 01		(Reserved)	
02 07 00 02	0aaaaaaa	METRONOME INT LEVEL	
02 07 00 03#	0bbbbbbb	less than -905,-905,,,60 =	-Inf,-90.5,,,+6.0dB
02 07 00 04	00 - 01	METRONOME MODE	Rec Only,Rec&Play
02 07 00 05	00 - 03	METRONOME TONE TYPE	CLICK1,CLICK2,CLICK2 (Note),DRUM
02 07 00 06	00 - 0F	METRONOME MIDI CHANNEL	1,,,16
02 07 00 07	0C - 7F	METRONOME MIDI ACCENT NOTE	C_0,,,G_9
02 07 00 08	01 - 7F	METRONOME MIDI ACCENT VELOCITY	1,,,127
02 07 00 09	0C - 7F	METRONOME MIDI NORMAL NOTE	C_0,,,G_9
02 07 00 0A	01 - 7F	METRONOME MIDI NORMAL VELOCITY	1,,,127
02 07 00 0B	00 - 02	METRONOME PERCUSSION	Hand Clap,Cowbel,Maracas
02 07 10 00	00 - 02	DRUM BEAT PATTERN 1	
02 07 10 01	01 - 7F	H.H. Switch	Off,On,Open
02 07 10 02	00 - 01	S.D. Switch	Off,On
02 07 10 03	01 - 7F	Velocity	1,,,127
02 07 10 04	00 - 01	B.D. Switch	Off,On
02 07 10 05	01 - 7F	Velocity	1,,,127
02 07 10 06	00 - 01	PERCUSSION Switch	Off,On
02 07 10 07	01 - 7F	Velocity	1,,,127
02 07 10 08		DRUM BEAT PATTERN 2	(See DRUM BEAT PATTERN 1, 8bytes each)
:		:	
02 07 10 78		DRUM BEAT PATTERN 16	
02 08 00 00	0000aaaa	AUTO PUNCH IN	(*1,2,3)
02 08 00 01#	0000bbbb	aaaabbbbccccddddeeeeffffgggghhhh =	
02 08 00 02#	0000cccc	0,,,4294967295block (1block=16sample)	
02 08 00 03#	0000dddd		
02 08 00 04#	0000eeee		
02 08 00 05#	0000ffff		
02 08 00 06#	0000gggg		
02 08 00 07#	0000hhhh		
02 08 00 08	0000aaaa	AUTO PUNCH OUT	(*1,2,3)
02 08 00 09#	0000bbbb	aaaabbbbccccddddeeeeffffgggghhhh =	
02 08 00 0A#	0000cccc	0,,,4294967295block (1block=16sample)	
02 08 00 0B#	0000dddd		
02 08 00 0C#	0000eeee		
02 08 00 0D#	0000ffff		
02 08 00 0E#	0000gggg		
02 08 00 0F#	0000hhhh		
02 08 00 10	0000aaaa	LOOP FROM	(*1,2,3)
02 08 00 11#	0000bbbb	aaaabbbbccccddddeeeeffffgggghhhh =	
02 08 00 12#	0000cccc	0,,,4294967295block (1block=16sample)	
02 08 00 13#	0000dddd		
02 08 00 14#	0000eeee		
02 08 00 15#	0000ffff		
02 08 00 16#	0000gggg		
02 08 00 17#	0000hhhh		

02 08 00 18	0000aaaa	LOOP TO (*1,2,3)
02 08 00 19#	0000bbbb	aaaabbbbccccddddeeeeffffggghhhh =
02 08 00 1A#	0000cccc	0,,,4294967295block (1block=16sample)
02 08 00 1B#	0000dddd	
02 08 00 1C#	0000eeee	
02 08 00 1D#	0000ffff	
02 08 00 1E#	0000gggg	
02 08 00 1F#	0000hhhh	
02 08 00 20	00 - 01	AUTO PUNCH SWITCH Off,On
02 08 00 21	00 - 01	LOOP SWITCH Off,On
02 09 00 00	0000aaaa	MARKER TIME or MARKER NUMBER (*1,2,4)
02 09 00 01#	0000bbbb	aaaabbbbccccddddeeeeffffggghhhh =
02 09 00 02#	0000cccc	0,,,4294967295block (1block=16sample)
02 09 00 03#	0000dddd	or
02 09 00 04#	0000eeee	0,,,999 Marker Number, >=1000 All
02 09 00 05#	0000ffff	
02 09 00 06#	0000gggg	
02 09 00 07#	0000hhhh	
02 09 00 08	20 - 7F	MARKER NAME -1 (ASCII)
:	:	:
02 09 00 13	20 - 7F	MARKER NAME -12
02 09 01 00	00 - 04	MARKER COMMAND (*4)
		00=MARKER READ
		01=MARKER WRITE
		02=MARKER CLEAR
		03=MARKER NAME READ
		04=MARKER NAME WRITE
02 0A 00 00	0000aaaa	LOCATOR- 00 TIME (*1,2)
02 0A 00 01#	0000bbbb	aaaabbbbccccddddeeeeffffggghhhh =
02 0A 00 02#	0000cccc	0,,,4294967295block (1block=16sample)
02 0A 00 03#	0000dddd	
02 0A 00 04#	0000eeee	
02 0A 00 05#	0000ffff	
02 0A 00 06#	0000gggg	
02 0A 00 07#	0000hhhh	
02 0A 00 08	20 - 7F	LOCATOR- 00 NAME -1 (ASCII)
:	:	:
02 0A 00 13	20 - 7F	LOCATOR- 00 NAME -12
02 0A 00 14	00 -	LOCATOR- 01
		(similar to 02 0A 00 00 - 02 0A 00 13)
:	:	:
02 0A 00 27	00 -	
:	:	:
02 0A 0F 3C	00 -	LOCATOR- 99
		(similar to 02 0A 00 00 - 02 0A 00 13)
:	:	:
02 0A 0F 4F	00 -	
02 0B 00 00	0aaaaaaaa	FADER ASSIGN to
02 0B 00 01#	0bbbbbbbb	ATT
02 0B 00 02#	0ccccccc	PHASE
02 0B 00 03#	0ddddddd	GROUP
		Ch LINK
		Fader LINK
		LEVEL
		PAN
		SOLO
		MUTE
		AUX1 Send Sw,
		AUX2 Send Sw,
		AUX3 Send Sw,
		AUX4 Send Sw,
		AUX5 Send Sw,
		AUX6 Send Sw,
		AUX7 Send Sw,
		AUX8 Send Sw,
		AUX1 Send Lev,
		AUX2 Send Lev,
		AUX3 Send Lev,
		AUX4 Send Lev,
		AUX5 Send Lev,
		AUX6 Send Lev,
		AUX7 Send Lev,
		AUX8 Send Lev,
		AUX1/2SendPAN,
		AUX3/4SendPAN,
		AUX5/6SendPAN,
		AUX7/8SendPAN,
		InsFX1 Sw,
		InsFX2 Sw,
		InsFX3 Sw,
		InsFX4 Sw,
		InsFX1 SndLev,
		InsFX2 SndLev,
		InsFX3 SndLev,
		InsFX4 SndLev,
		InsFX1 RtnLev,
		InsFX2 RtnLev,
		InsFX3 RtnLev,
		InsFX4 RtnLev,
		Surnd PAN
		Surnd DEPTH
		Surnd LR:C
		Surnd SubWLev,
		Dyn Sw
		Dyn Type
		Cmp KeyIn,
		Cmp Thresh,
		Cmp RATIO
		Cmp ATTACK
		Cmp RELEASE
		Cmp LEVEL
		Cmp AUTOGAIN
		Exp KeyIn,
		Exp Thresh,
		Exp RATIO
		Exp ATTACK
		Exp RELEASE

			EQ Sw
			EQ Low Gain,
			EQ Low Freq,
			EQ LoMid Gain,
			EQ LoMid Freq,
			EQ LoMid Q,
			EQ HiMid Gain,
			EQ HiMid Freq,
			EQ HiMid Q,
			EQ High Gain,
			EQ High Freq
02 0B 00 04	00 - 77	V.Fader Fader 1	0,,,119
:	:	:	:
02 0B 00 0F	00 - 77	V.Fader Fader 12	0,,,119
02 0B 00 10		(Reserved)	
:	:	:	:
02 0B 00 23		(Reserved)	
02 0B 00 24	00 - 0F	V.Fader Fader 1 Tx Ch	1,,,16
:	:	:	:
02 0B 00 0F	00 - 0F	V.Fader Fader 12 Tx Ch	1,,,16
02 0C 00 00	00 - 01	SCENE INPUT MIXER 1	Valid,Ignore
:	:	:	:
02 0C 00 0F	00 - 01	SCENE INPUT MIXER 16	Valid,Ignore
02 0C 00 10		(Reserved)	
:	:	:	:
02 0C 00 17		(Reserved)	
02 0C 00 18	00 - 01	SCENE TRACK MIXER 1	Valid,Ignore
:	:	:	:
02 0C 00 2F	00 - 01	SCENE TRACK MIXER 24	Valid,Ignore
02 0C 00 30	00 - 01	SCENE FX RETURN 1	Valid,Ignore
:	:	:	:
02 0C 00 33	00 - 01	SCENE FX RETURN 4	Valid,Ignore
02 0C 00 34		(Reserved)	
:	:	:	:
02 0C 00 37		(Reserved)	
02 0C 00 38	00 - 01	SCENE AUX MASTER 1	Valid,Ignore
:	:	:	:
02 0C 00 3F	00 - 01	SCENE AUX MASTER 8	Valid,Ignore
02 0C 00 40	00 - 01	SCENE DIR MIXER 1	Valid,Ignore
:	:	:	:
02 0C 00 47	00 - 01	SCENE DIR MIXER 8	Valid,Ignore
02 0C 00 48	00 - 01	SCENE EFFECT 1	Valid,Ignore
:	:	:	:
02 0C 00 4B	00 - 01	SCENE EFFECT 4	Valid,Ignore
02 0C 00 4C		(Reserved)	
:	:	:	:
02 0C 00 4F		(Reserved)	
02 0C 00 50	00 - 01	SCENE MASTER	Valid,Ignore
02 0D 00 00	00 - 02	AUTOMIX STATUS INPUT MIXER 1	Manual,Write,Read
:	:	:	:
02 0D 00 0F	00 - 02	AUTOMIX STATUS INPUT MIXER 16	Manual,Write,Read
02 0D 00 10		(Reserved)	
:	:	:	:
02 0D 00 17		(Reserved)	
02 0D 00 18	00 - 02	AUTOMIX STATUS TRACK MIXER 1	Manual,Write,Read
:	:	:	:
02 0D 00 2F	00 - 02	AUTOMIX STATUS TRACK MIXER 24	Manual,Write,Read
02 0D 00 30	00 - 02	AUTOMIX STATUS FX RETURN 1	Manual,Write,Read
:	:	:	:
02 0D 00 33	00 - 02	AUTOMIX STATUS FX RETURN 4	Manual,Write,Read
02 0D 00 34		(Reserved)	
:	:	:	:
02 0D 00 37		(Reserved)	
02 0D 00 38	00 - 02	AUTOMIX STATUS AUX MASTER 1	Manual,Write,Read
:	:	:	:
02 0D 00 3F	00 - 02	AUTOMIX STATUS AUX MASTER 8	Manual,Write,Read
02 0D 00 40	00 - 02	AUTOMIX STATUS DIR 1	Manual,Write,Read
:	:	:	:
02 0D 00 47	00 - 02	AUTOMIX STATUS DIR 8	Manual,Write,Read
02 0D 00 48	00 - 02	AUTOMIX STATUS EFFECT 1	Manual,Write,Read
:	:	:	:
02 0D 00 4B	00 - 02	AUTOMIX STATUS EFFECT 4	Manual,Write,Read
02 0D 00 4C		(Reserved)	
:	:	:	:
02 0D 00 4F		(Reserved)	
02 0D 00 50	00 - 02	AUTOMIX STATUS MASTER	Manual,Write,Read
02 0D 00 51	00 - 01	AUTOMIX WRITING PARAMETER LEVEL	Off,On
02 0D 00 52	00 - 01	AUTOMIX WRITING PARAMETER PAN/Bal	Off,On
02 0D 00 53	00 - 01	AUTOMIX WRITING PARAMETER EQ	Off,On
02 0D 00 54	00 - 01	AUTOMIX WRITING PARAMETER MUTE	Off,On

MIDI Implementation

02 0D 00 55	00 - 01	AUTOMIX WRITING PARAMETER AUX Send Off,On
02 0D 00 56	00 - 01	AUTOMIX WRITING PARAMETER InsFXLev Off,On
02 0D 00 57	00 - 01	AUTOMIX WRITING PARAMETER SURROUND Off,On
02 0D 00 58	00 - 01	AUTOMIX AFTER PUNCH OUT Return,Keep
02 0D 00 59	00 - 0A	AUTOMIX RETURN TIME 0,,,10 = 0,,,1000ms
02 0E 00 00	00 - 01	SURROUND MIX SWITCH Off,On
02 0E 00 01	00 - 02	SURROUND MIX MODE 2+2,3+1,3+2+1
02 0F 00 00	00 - 01	GENERATOR SWITCH Off,On
02 0F 00 01	00 - 01	GENERATOR SOURCE Pink Noise,White Noise,Sin Wave, METRONOME
02 0F 00 02	0aaaaaaa	GENERATOR ATT
02 0F 00 03#	0bbbbbbb	-420,,,60 = -42.0,,,+6.0dB (*5)
02 0F 00 04	0aaaaaaa	GENERATOR FREQUENCY
02 0F 00 05#	0bbbbbbb	20,,,140 = 20Hz,,,20.0kHz (*6,7)
02 0F 00 06	0aaaaaaa	GENERATOR FADER LEVEL
02 0F 00 07#	0bbbbbbb	less than -905,-905,,,60 = -Inf,-90.5,,,+6.0dB
02 0F 00 08	01 - 7F	GENERATOR PAN L63,,,R63
02 0F 00 09	00 - 01	GENERATOR MIX SEND SWITCH Off,On
02 0F 00 0A	00	(Reserved)
02 0F 00 0B	00	(Reserved)
02 0F 00 0C	00 - 01	GENERATOR AUX1 SEND SWITCH Off,On
02 0F 00 0D	00 - 01	GENERATOR AUX2 SEND SWITCH Off,On
02 0F 00 0E	00 - 01	GENERATOR AUX3 SEND SWITCH Off,On
02 0F 00 0F	00 - 01	GENERATOR AUX4 SEND SWITCH Off,On
02 0F 00 10	00 - 01	GENERATOR AUX5 SEND SWITCH Off,On
02 0F 00 11	00 - 01	GENERATOR AUX6 SEND SWITCH Off,On
02 0F 00 12	00 - 01	GENERATOR AUX7 SEND SWITCH Off,On
02 0F 00 13	00 - 01	GENERATOR AUX8 SEND SWITCH Off,On
02 0F 00 14	0aaaaaaa	GENERATOR AUX1 SEND LEVEL
02 0F 00 15#	0bbbbbbb	less than -905,-905,,,60 = -Inf,-90.5,,,+6.0dB
02 0F 00 16	0aaaaaaa	GENERATOR AUX2 SEND LEVEL
02 0F 00 17#	0bbbbbbb	less than -905,-905,,,60 = -Inf,-90.5,,,+6.0dB
02 0F 00 18	0aaaaaaa	GENERATOR AUX3 SEND LEVEL
02 0F 00 19#	0bbbbbbb	less than -905,-905,,,60 = -Inf,-90.5,,,+6.0dB
02 0F 00 1A	0aaaaaaa	GENERATOR AUX4 SEND LEVEL
02 0F 00 1B#	0bbbbbbb	less than -905,-905,,,60 = -Inf,-90.5,,,+6.0dB
02 0F 00 1C	0aaaaaaa	GENERATOR AUX5 SEND LEVEL
02 0F 00 1D#	0bbbbbbb	less than -905,-905,,,60 = -Inf,-90.5,,,+6.0dB
02 0F 00 1E	0aaaaaaa	GENERATOR AUX6 SEND LEVEL
02 0F 00 1F#	0bbbbbbb	less than -905,-905,,,60 = -Inf,-90.5,,,+6.0dB
02 0F 00 20	0aaaaaaa	GENERATOR AUX7 SEND LEVEL
02 0F 00 21#	0bbbbbbb	less than -905,-905,,,60 = -Inf,-90.5,,,+6.0dB
02 0F 00 22	0aaaaaaa	GENERATOR AUX8 SEND LEVEL
02 0F 00 23#	0bbbbbbb	less than -905,-905,,,60 = -Inf,-90.5,,,+6.0dB
02 0F 00 24	01 - 7F	GENERATOR AUX1X2 SEND PAN L63,,,R63
02 0F 00 25	01 - 7F	GENERATOR AUX3X4 SEND PAN L63,,,R63
02 0F 00 26	01 - 7F	GENERATOR AUX5X6 SEND PAN L63,,,R63
02 0F 00 27	01 - 7F	GENERATOR AUX7X8 SEND PAN L63,,,R63
02 0F 00 28	00	(Reserved)
:	:	:
02 0F 00 2D	00	(Reserved)
02 0F 00 2E	00 - 01	GENERATOR DIR1 SELECT SWITCH Off,On
02 0F 00 2F	00 - 01	GENERATOR DIR2 SELECT SWITCH Off,On
02 0F 00 30	00 - 01	GENERATOR DIR3 SELECT SWITCH Off,On
02 0F 00 31	00 - 01	GENERATOR DIR4 SELECT SWITCH Off,On
02 0F 00 32	00 - 01	GENERATOR DIR5 SELECT SWITCH Off,On
02 0F 00 33	00 - 01	GENERATOR DIR6 SELECT SWITCH Off,On
02 0F 00 34	00 - 01	GENERATOR DIR7 SELECT SWITCH Off,On
02 0F 00 35	00 - 01	GENERATOR DIR8 SELECT SWITCH Off,On

02 0F 00 36	00 - 7F	ANALYZER SOURCE 127 = Off 0,,,15 = IN1,,,IN16 24,,,47 = TR1,,,TR16 48,,,55 = FX1 RTN L,,,FX4 RTN 64,,,84 = Gen/Osc,MST L,MST R, MON L,MON R,AUX1,,,AUX8,DIR1,,,DIR8
02 0F 00 37	00 - 01	ANALYZER POSITION Pre,Pst
02 0F 00 38	00 - 7F	ANALYZER AVERAGE TIMES 1,,,128
02 0F 00 39	00 - 02	ANALYZER AVERAGE TYPE Off,NRM,EXP
02 10 00 00	00 - 04	DATE FORMAT mm/dd/yyyy,dd/mm/yyyy,yyyy/mm/dd, MMM.dd,'YY,dd MMM 'YY
02 12 00 00	00 - 01	R-BUS REMOTE CONTROL Off,On
02 12 00 01	00 - 01	R-BUS DIF-AT INPUT SELECT ADAT,TDIF
02 12 00 02	01 - 02	R-BUS DIF-AT INPUT CH 1 STATUS PLY,REC
:	:	:
02 12 00 09	01 - 02	R-BUS DIF-AT INPUT CH 8 STATUS PLY,REC
02 12 00 0A	00 - 02	R-BUS ADA-7000 CLOCK SOURCE INTERNAL,R-BUS,WORD CLOCK
02 12 00 0B	00 - 03	R-BUS ADA-7000 SAMPLING FREQ 32,44.1,48,96k
02 12 00 0C	00 - 01	R-BUS ADA-7000 FRONT PANEL CONTROL Off,On
02 12 00 0D	00 - 01	R-BUS ADA-7000 INPUT CH 1 PHANTOM +48V Off,On
:	:	:
02 12 00 14	00 - 01	R-BUS ADA-7000 INPUT CH 8 PHANTOM +48V Off,On
02 12 00 15	00 - 44	R-BUS ADA-7000 INPUT CH 1 INPUT SENS +4dBu,,, -64dBu
:	:	:
02 12 00 1C	00 - 44	R-BUS ADA-7000 INPUT CH 8 INPUT SENS +4dBu,,, -64dBu
02 12 00 1D	00 - 02	R-BUS AE-7000 CLOCK SOURCE R-BUS,WORD CLOCK,INPUT-A
02 12 00 1E	00 - 01	R-BUS AE-7000 DIGITAL OUT TYPE TYPE2,TYPE1
02 12 00 1F	00 - 01	R-BUS AE-7000 COPY PROTECT On,Off
02 12 00 20	00 - 03	R-BUS VSR-880 CH 1 STATUS SRC,PLY,REC,OFF
:	:	:
02 12 00 27	00 - 03	R-BUS VSR-880 CH 8 STATUS SRC,PLY,REC,OFF
02 30 00 00	00 - 01	MASTERING ROOM Off,On
02 30 00 01	00 - 01	MASTERING STATUS Play,Rec
02 30 00 02	00 - 01	MASTERING CDR Rec MODE Off,On
02 30 00 03	00 - 01	MASTERING Auto Marker Off,On
02 30 00 04	00 - 0F	MASTERING V.Track 1,,,16
02 30 00 05	00 - 04	MASTERING After Rec to ZERO, to Last Phrs:0s, to Last Phrs:2s, to Last Phrs:4s, Stay HERE

(* Addresses with a "#" are ignored, even when sent as the Start Address.

Transmit the Data Set (DT1) or Data Request (RQ1) message with the specified size to the address without "#" mark.

(*1) Time parameters are set to the relocated time (REL) that the time of project top is "00h00m00s00f00."

(*2) The VS-2400CD treats the 16 sample as 1 block for managing internal time. Pay attention to the expression of the internal time changes respond to the sampling frequency of each project. And time parameter cannot be set to over 24 hours.

Ex.1) Set the time 00h01m00s00f00(FRAME RATE = 30Non-Drop)

Sampling Frequency is 96kHz:

5760000 sample = 360000 block = 00 00 00 05 07 0E 04 00 (4bit nibble)

Sampling Frequency is 88.2kHz:

5292000 sample = 330750 block = 00 00 00 05 00 0B 0F 0E (4bit nibble)

Sampling Frequency is 64kHz:

3840000 sample = 240000 block = 00 00 00 03 0A 09 08 00 (4bit nibble)

Sampling Frequency is 48kHz:

2880000 sample = 180000 block = 00 00 00 02 0B 0F 02 00 (4bit nibble)

Sampling Frequency is 44.1kHz:

2646000 sample = 165375 block = 00 00 00 02 08 05 0F 0F (4bit nibble)

Sampling Frequency is 32kHz:

1920000 sample = 120000 block = 00 00 00 01 0D 04 0C 00 (4bit nibble)

Ex.2) 23h59m59s29f00(FRAME RATE = 30 Non-Drop)

Sampling Frequency is 96kHz:

8294396800 sample = 518399800 block = 01 0E 0E 06 02 07 03 08 (4bit nibble)
 Sampling Frequency is 88.2kHz:
 7620477060 sample = 476279816 block = 01 0C 06 03 07 04 00 08 (4bit nibble)
 Sampling Frequency is 64kHz:
 5529597867 sample = 345599867 block = 01 04 09 09 06 07 07 0B (4bit nibble)
 Sampling Frequency is 48kHz:
 4147198400 sample = 259199900 block = 00 0F 07 03 01 03 09 0C (4bit nibble)
 Sampling Frequency is 44.1kHz:
 3810238530 sample = 238139908 block = 00 0E 03 01 0B 0A 00 04 (4bit nibble)
 Sampling Frequency is 32kHz:
 2764798933 sample = 172799933 block = 00 0A 04 0C 0B 07 0B 0D (4bit nibble)

(*3) The Loop Start point must be before the Loop Stop point.
 The Auto Puunch In point must be before the Auto Punch Out point.
 If the interval of each point is shorter than 1 sec, the VS-2400CD does not work correctly.

(*4) Read/Write/Erase of the Mark points are done by writing operation mode to the marker command.

Set the value of the Marker time and marker Number, before setting the value of the Marker command.

Ex.1) Delete all mark points (Device ID = 10)
 (HOST) => F0 41 10 00 61 12 02 09 00 00 0F 0F 0F 0F 0F 0F 7D F7 => (VS-2400CD)
 (HOST) => F0 41 10 00 61 12 02 09 01 00 02 72 F7 => (VS-2400CD)
 (HOST) <= F0 41 10 00 61 12 02 09 00 00 00 00 00 00 00 00 00 75 F7 <= (VS-2400CD)

The MARKER CLEAR command is issued with specifying time "FFFFFFF."

The return value "0" is a sum of mark points.

Ex.2) Write the mark point (Device ID = 10)
 (HOST) => F0 41 10 00 61 12 02 09 00 00 0a 0a 0a 0a 0a 0a 0a ss F7 => (VS-2400CD)
 aaaaaaa = time of Marker, ss = check sum
 (HOST) => F0 41 10 00 61 12 02 09 01 00 01 73 F7 => (VS-2400CD)
 (HOST) <= F0 41 10 00 61 12 02 09 00 00 0n 0n 0n 0n 0n 0n 0n ss F7 <= (VS-2400CD)
 nnnnnnnn = total Marker number, ss = check sum

If the total of mark point is over 1000, the VS-2400CD ignores the writing and returns the total numbers of the mark points.

If the mark point already exists 0.1 msec near the new mark point, the VS-2400CD ignores the writing and returns the total numbers of the mark points.

Ex.3) Read the mark point #3 (Device ID = 10)
 (HOST) => F0 41 10 00 61 12 02 09 00 00 00 00 00 00 00 00 00 72 F7 => (VS-2400CD)
 (HOST) => F0 41 10 00 61 12 02 09 01 00 00 74 F7 => (VS-2400CD)
 (HOST) <= F0 41 10 00 61 12 02 09 00 00 0n 0n 0n 0n 0n 0n 0n ss F7 <= (VS-2400CD)
 nnnnnnnn = total Marker number, ss = check sum
 (HOST) <= F0 41 10 00 61 12 02 09 00 00 0a 0a 0a 0a 0a 0a 0a ss F7 <= (VS-2400CD)
 aaaaaaa = time of Marker #3, ss = check sum

If the mark point is less than 3, the VS-2400CD does not return the block of "aaaaaaa."

Ex.4) Read all mark points (Device ID = 10)
 (HOST) => F0 41 10 00 61 12 02 09 00 00 0F 0F 0F 0F 0F 0F 7D F7 => (VS-2400CD)
 FFFFFFFF(>= 1000) means All Marker
 (HOST) => F0 41 10 00 61 12 02 09 01 00 00 74 F7 => (VS-2400CD)
 (HOST) <= F0 41 10 00 61 12 02 09 00 00 0n 0n 0n 0n 0n 0n 0n ss F7 <= (VS-2400CD)
 nnnnnnnn = total Marker number, ss = check sum
 (HOST) <= F0 41 10 00 61 12 02 09 00 00 0a 0a 0a 0a 0a 0a 0a ss F7 <= (VS-2400CD)
 aaaaaaa = time of Marker #1, ss = check sum
 (HOST) <= F0 41 10 00 61 12 02 09 00 00 0b 0b 0b 0b 0b 0b 0b ss F7 <= (VS-2400CD)
 bbbbbbbb = time of Marker #2, ss = check sum
 :
 (HOST) <= F0 41 10 00 61 12 02 09 00 00 0x 0x 0x 0x 0x 0x 0x ss F7 <= (VS-2400CD)
 xxxxxxxx = time of the last Marker#, ss = check sum

If the mark point does not exist, the VS-2400CD does not return blocks under "aaaaaaa."

Ex.5) Delete the mark point (Device ID = 10)
 (HOST) => F0 41 10 00 61 12 02 09 00 00 0a 0a 0a 0a 0a 0a 0a ss F7 => (VS-2400CD)
 aaaaaaa = time of Marker, ss = check sum
 (HOST) => F0 41 10 00 61 12 02 09 01 00 02 72 F7 => (VS-2400CD)
 (HOST) <= F0 41 10 00 61 12 02 09 00 00 0n 0n 0n 0n 0n 0n 0n ss F7 <= (VS-2400CD)
 nnnnnnnn = total marker number, ss = check sum

The VS-2400CD deletes the mark point which includes specified time, and returns the total numbers of the mark point.

Ex.6) Read the name of mark point #3 (Device ID = 10)
 (HOST) => F0 41 10 00 61 12 02 09 00 00 00 00 00 00 00 00 00 72 F7 => (VS-2400CD)
 (HOST) => F0 41 10 00 61 12 02 09 01 00 03 71 F7 => (VS-2400CD)
 (HOST) <= F0 41 10 00 61 12 02 09 00 00 0n 0n 0n 0n 0n 0n 0n ss F7 <= (VS-2400CD)
 nnnnnnnn = total Marker number, ss = check sum
 (HOST) <= F0 41 10 00 61 12 02 09 00 08 aa bb cc dd ee ff gg hh ii jj kk ll ss F7 <= (VS-2400CD)

abcdefghijkl = name of Marker #3, ss = check sum

If the mark point is less than 3, the VS-2400CD does not return the block of "abcdefghijkl."

Ex.7) Write the name to the mark point #3(Device ID = 10)
 (HOST) => F0 41 10 00 61 12 02 09 00 00 00 00 00 00 00 00 00 72 F7 => (VS-2400CD)
 (HOST) => F0 41 10 00 61 12 02 09 00 08 aa bb cc dd ee ff gg hh ii jj kk ll ss F7 => (VS-2400CD)
 abcdefghijkl = name of Marker #3, ss = check sum
 (HOST) => F0 41 10 00 61 12 02 09 01 00 04 70 F7 => (VS-2400CD)
 (HOST) <= F0 41 10 00 61 12 02 09 00 00 0n 0n 0n 0n 0n 0n 0n ss F7 <= (VS-2400CD)
 nnnnnnnn = total Marker number, ss = check sum

If the mark point is less than 3, the VS-2400CD ignores the writing and returns the total numbers of the mark points.

(*5)GENERATOR SOURCE is "METRONOME" when invalid.

(*6)GENERATOR SOURCE is "Sin Wave" when valid.

(*7)see Mixer Frequency Table of NRPN and Mixer Parameter.

●Project Parameter

Start address	Data	Contents and remarks
03 00 00 00	20 - 7F	CURRENT PROJECT NAME -1 (ASCII)
03 00 00 0B	20 - 7F	CURRENT PROJECT NAME -12
03 00 00 0C	00 - 05	CURRENT PROJECT SAMPLE RATE 96k(3), 88.2k(4), 64k(5), 48k(0), 44.1k(1), 32k(2)
03 00 00 0D	00 - 08	CURRENT PROJECT RECORDING MODE M24(8), MTP(5), CDR(4), M16(3), MT1(0), MT2(1), LIV(2), LV2(6)
03 00 00 0E	00 - 3B	CURRENT PROJECT CREATED (second)
03 00 00 0F	00 - 3B	(minute)
03 00 00 10	00 - 17	(hour)
03 00 00 11	01 - 07	(a day of week)
03 00 00 12	01 - 1F	(day)
03 00 00 13	01 - 0C	(month)
03 00 00 14	0aaaaaaa	(year)
03 00 00 15#	0bbbbbbb	
03 00 00 16	00 - 3B	CURRENT PROJECT SAVED (second)
03 00 00 17	00 - 3B	(minute)
03 00 00 18	00 - 17	(hour)
03 00 00 19	01 - 07	(a day of week)
03 00 00 1A	01 - 1F	(day)
03 00 00 1B	01 - 0C	(month)
03 00 00 1C	0aaaaaaa	(year)
03 00 00 1D#	0bbbbbbb	
03 00 00 1E	00	(Reserved)
03 00 00 1F	00	(Reserved)
03 00 00 20	00 - 01	CURRENT PROJECT PROTECT Off, On
03 00 00 21	00	(Reserved)
03 00 00 22	0000000a	PROJECT LIST LENGTH abbbbbbb = 1,,200
03 00 00 23#	0bbbbbbb	
03 00 00 24	00	(Reserved)
:	:	:
03 00 00 7F	00	(Reserved)
03 00 01 00	20 - 7F	CURRENT PROJECT COMMENT - 1 (ASCII)
:	:	:
03 00 01 63	20 - 7F	CURRENT PROJECT COMMENT -100 (ASCII)
03 00 01 64	00	(Reserved)
:	:	:
03 00 01 7F	00	(Reserved)
03 00 02 00	00 -	PROJECT- 1 (similar to 03 00 00 00 - 03 00 00 1F)
:	:	:
03 00 02 1F	00 -	
:	:	:
03 00 33 60	00 -	PROJECT-200 (similar to 03 00 00 00 - 03 00 00 1F)
:	:	:
03 00 33 7F	00 -	

(*) Addresses with a "#" are ignored, even when sent as the Start Address.

Transmit the Data Set (DT1) message with the specified size to the address without "##" mark.

(*) Only the Data Set (DT1) message to the project name and project comment is acceptable.

●Mixer Parameter

Start address	Data	Contents and remarks
04 00 00 00	0aaaaaaa	INPUT CHANNEL 1 ATF
04 00 00 01#	0bbbbbbb	-420,,,60 = -42.0,,,+6.0dB
04 00 00 02	00 - 01	INPUT CHANNEL 1 PHASE NRM, INV

MIDI Implementation

04 00 00 03	00 - 7F	INPUT CHANNEL 1 GROUP 127,0,,,11 = Off,1,,,12
04 00 00 04	00 - 01	INPUT CHANNEL 1 LINK Off,On
04 00 00 05	00 - 01	INPUT CHANNEL 1 FADER LINK Off,On
04 00 00 06 04 00 00 07#	0aaaaaaa 0bbbbbbb	INPUT CHANNEL 1 FADER LEVEL less than -905,-905,,,60 = -Inf,-90.5,,,+6.0dB
04 00 00 08 04 00 00 09#	0aaaaaaa 0bbbbbbb	INPUT CHANNEL 1 OFFSET FADER LEVEL less than -905,-905,,,60 = -Inf,-90.5,,,+6.0dB
04 00 00 0A	00	(Reserved)
04 00 00 0B	00	(Reserved)
04 00 00 0C	00	(Reserved)
04 00 00 0D	01 - 7F	INPUT CHANNEL 1 PAN L63,,,R63
04 00 00 0E	01 - 7F	INPUT CHANNEL 1 OFFSET PAN L63,,,R63
04 00 00 0F	00 - 01	INPUT CHANNEL 1 SOLO Off,On
04 00 00 10	00 - 01	INPUT CHANNEL 1 MUTE Off,On
04 00 00 11	00 - 7F	INPUT CHANNEL 1 ASSIGN TRACK SELECT 127,0,,,23 = Off,Tr1,,,Tr24
04 00 00 12	00 - 01	INPUT CHANNEL 1 AUX1 SEND SWITCH Off,On
04 00 00 13	00 - 01	INPUT CHANNEL 1 AUX2 SEND SWITCH Off,On
04 00 00 14	00 - 01	INPUT CHANNEL 1 AUX3 SEND SWITCH Off,On
04 00 00 15	00 - 01	INPUT CHANNEL 1 AUX4 SEND SWITCH Off,On
04 00 00 16	00 - 01	INPUT CHANNEL 1 AUX5 SEND SWITCH Off,On
04 00 00 17	00 - 01	INPUT CHANNEL 1 AUX6 SEND SWITCH Off,On
04 00 00 18	00 - 01	INPUT CHANNEL 1 AUX7 SEND SWITCH Off,On
04 00 00 19	00 - 01	INPUT CHANNEL 1 AUX8 SEND SWITCH Off,On
04 00 00 1A 04 00 00 1B#	0aaaaaaa 0bbbbbbb	INPUT CHANNEL 1 AUX1 SEND LEVEL less than -905,-905,,,60 = -Inf,-90.5,,,+6.0dB
04 00 00 1C 04 00 00 1D#	0aaaaaaa 0bbbbbbb	INPUT CHANNEL 1 AUX2 SEND LEVEL less than -905,-905,,,60 = -Inf,-90.5,,,+6.0dB
04 00 00 1E 04 00 00 1F#	0aaaaaaa 0bbbbbbb	INPUT CHANNEL 1 AUX3 SEND LEVEL less than -905,-905,,,60 = -Inf,-90.5,,,+6.0dB
04 00 00 20 04 00 00 21#	0aaaaaaa 0bbbbbbb	INPUT CHANNEL 1 AUX4 SEND LEVEL less than -905,-905,,,60 = -Inf,-90.5,,,+6.0dB
04 00 00 22 04 00 00 23#	0aaaaaaa 0bbbbbbb	INPUT CHANNEL 1 AUX5 SEND LEVEL less than -905,-905,,,60 = -Inf,-90.5,,,+6.0dB
04 00 00 24 04 00 00 25#	0aaaaaaa 0bbbbbbb	INPUT CHANNEL 1 AUX6 SEND LEVEL less than -905,-905,,,60 = -Inf,-90.5,,,+6.0dB
04 00 00 26 04 00 00 27#	0aaaaaaa 0bbbbbbb	INPUT CHANNEL 1 AUX7 SEND LEVEL less than -905,-905,,,60 = -Inf,-90.5,,,+6.0dB
04 00 00 28 04 00 00 29#	0aaaaaaa 0bbbbbbb	INPUT CHANNEL 1 AUX8 SEND LEVEL less than -905,-905,,,60 = -Inf,-90.5,,,+6.0dB
04 00 00 2A	01 - 7F	INPUT CHANNEL 1 AUX1/2 SEND PAN L63,,,R63
04 00 00 2B	01 - 7F	INPUT CHANNEL 1 AUX3/4 SEND PAN L63,,,R63
04 00 00 2C	01 - 7F	INPUT CHANNEL 1 AUX5/6 SEND PAN L63,,,R63
04 00 00 2D	01 - 7F	INPUT CHANNEL 1 AUX7/8 SEND PAN L63,,,R63
04 00 00 2E	00 - 04	INPUT CHANNEL 1 FX1 INSERT SWITCH Off,Ins,InsL,InsR,InsS
04 00 00 2F	00 - 04	INPUT CHANNEL 1 FX2 INSERT SWITCH Off,Ins,InsL,InsR,InsS
04 00 00 30	00 - 04	INPUT CHANNEL 1 FX3 INSERT SWITCH Off,Ins,InsL,InsR,InsS
04 00 00 31	00 - 04	INPUT CHANNEL 1 FX4 INSERT SWITCH Off,Ins,InsL,InsR,InsS
04 00 00 32	00	(Reserved)
04 00 00 33	00	(Reserved)
04 00 00 34	00	(Reserved)
04 00 00 35	00	(Reserved)
04 00 00 36 04 00 00 37#	0aaaaaaa 0bbbbbbb	INPUT CHANNEL 1 FX1 INSERT SEND LEVEL less than -905,-905,,,60 = -Inf,-90.5,,,+6.0dB
04 00 00 38 04 00 00 39#	0aaaaaaa 0bbbbbbb	INPUT CHANNEL 1 FX2 INSERT SEND LEVEL less than -905,-905,,,60 = -Inf,-90.5,,,+6.0dB

04 00 00 3A 04 00 00 3B#	0aaaaaaa 0bbbbbbb	INPUT CHANNEL 1 FX3 INSERT SEND LEVEL less than -905,-905,,,60 = -Inf,-90.5,,,+6.0dB
04 00 00 3C 04 00 00 3D#	0aaaaaaa 0bbbbbbb	INPUT CHANNEL 1 FX4 INSERT SEND LEVEL less than -905,-905,,,60 = -Inf,-90.5,,,+6.0dB
04 00 00 3E	00	(Reserved)
04 00 00 3F	00	(Reserved)
04 00 00 40	00	(Reserved)
04 00 00 41	00	(Reserved)
04 00 00 42 04 00 00 43#	0aaaaaaa 0bbbbbbb	INPUT CHANNEL 1 FX1 INSERT RETURN LEVEL less than -905,-905,,,60 = -Inf,-90.5,,,+6.0dB
04 00 00 44 04 00 00 45#	0aaaaaaa 0bbbbbbb	INPUT CHANNEL 1 FX2 INSERT RETURN LEVEL less than -905,-905,,,60 = -Inf,-90.5,,,+6.0dB
04 00 00 46 04 00 00 47#	0aaaaaaa 0bbbbbbb	INPUT CHANNEL 1 FX3 INSERT RETURN LEVEL less than -905,-905,,,60 = -Inf,-90.5,,,+6.0dB
04 00 00 48 04 00 00 49#	0aaaaaaa 0bbbbbbb	INPUT CHANNEL 1 FX4 INSERT RETURN LEVEL less than -905,-905,,,60 = -Inf,-90.5,,,+6.0dB
04 00 00 4A 04 00 00 4B#	0aaaaaaa 0bbbbbbb	INPUT CHANNEL 1 FX1 INSERT RETURN LEVEL less than -905,-905,,,60 = -Inf,-90.5,,,+6.0dB
04 00 00 4C 04 00 00 4D#	0aaaaaaa 0bbbbbbb	INPUT CHANNEL 1 FX2 INSERT RETURN LEVEL less than -905,-905,,,60 = -Inf,-90.5,,,+6.0dB
04 00 00 4E	00	(Reserved)
04 00 00 4F	00	(Reserved)
04 00 00 50	00	(Reserved)
04 00 00 51 04 00 00 52#	01 - 7F 01 - 7F	INPUT CHANNEL 1 SURROUND PAN L63,,,R63 INPUT CHANNEL 1 SURROUND DEPTH R63,,,F63
04 00 00 53	01 - 64	INPUT CHANNEL 1 SURROUND LRC 0,,,100%
04 00 00 54	00	(Reserved)
04 00 00 55 04 00 00 56#	0aaaaaaa 0bbbbbbb	INPUT CHANNEL 1 SURROUND SUBWOOFER LEVEL less than -905,-905,,,60 = -Inf,-90.5,,,+6.0dB
04 00 00 57	00 - 01	INPUT CHANNEL 1 DYNAMICS SWITCH Off,On
04 00 00 58	00 - 01	INPUT CHANNEL 1 DYNAMICS TYPE CMP,EXP
04 00 00 59	00 - 0F	INPUT CHANNEL 1 DYNAMICS CMP KEYIN CH1,,,CH16
04 00 00 5A	00	(Reserved)
04 00 00 5B 04 00 00 5C#	0aaaaaaa 0bbbbbbb	INPUT CHANNEL 1 DYNAMICS CMP THRESHOLD -240,,,0 = -24.0,,,0.0dB
04 00 00 5D	00 - 0D	INPUT CHANNEL 1 DYNAMICS CMP RATIO 1.00:1,,,Inf:1 (*1)
04 00 00 5E	00	(Reserved)
04 00 00 5F	00 - 7C	INPUT CHANNEL 1 DYNAMICS CMP ATTACK 0.0,,,800.0ms (*2)
04 00 00 60	00 - 7C	INPUT CHANNEL 1 DYNAMICS CMP RELEASE 0,,,8000ms (*2)
04 00 00 61 04 00 00 62#	0aaaaaaa 0bbbbbbb	INPUT CHANNEL 1 DYNAMICS CMP LEVEL -240,,,240 = -24.0,,,+24.0dB -240,,,60 = -24.0,,,+6.0dB when AUTO GAIN is On
04 00 00 63	00 - 01	INPUT CHANNEL 1 DYNAMICS CMP AUTO GAIN Off,On
04 00 00 64 04 00 00 65#	0aaaaaaa 0bbbbbbb	INPUT CHANNEL 1 DYNAMICS EXP THRESHOLD -800,,,0 = -80.0,,,0.0dB
04 00 00 66	00 - 0D	INPUT CHANNEL 1 DYNAMICS EXP RATIO 1.00:1,,,Inf:1 (*1)
04 00 00 67	00	(Reserved)
04 00 00 68 04 00 00 69#	0aaaaaaa 0bbbbbbb	INPUT CHANNEL 1 DYNAMICS EXP ATTACK 0.0,,,800.0ms (*2)
04 00 00 6A 04 00 00 6B#	0aaaaaaa 0bbbbbbb	INPUT CHANNEL 1 DYNAMICS EXP RELEASE 0,,,8000ms (*2)
04 00 00 6C	00 - 01	INPUT CHANNEL 1 EQ SWITCH Off,On
04 00 00 6D	00	(Reserved)
04 00 00 6E	00 - 01	INPUT CHANNEL 1 EQ LOW GAIN -150,,,150 = -15.0,,,+15.0dB
04 00 00 6F	00 - 01	INPUT CHANNEL 1 EQ LOW FREQUENCY 20,,,88 = 20Hz,,,1.00kHz (*3)
04 00 00 70 04 00 00 71#	0aaaaaaa 0bbbbbbb	INPUT CHANNEL 1 EQ LOWMID GAIN -150,,,150 = -15.0,,,+15.0dB
04 00 00 72 04 00 00 73#	0aaaaaaa 0bbbbbbb	INPUT CHANNEL 1 EQ LOWMID FREQUENCY 20,,,140 = 20Hz,,,20.0kHz (*3)
04 00 00 74 04 00 00 75#	0aaaaaaa 0bbbbbbb	INPUT CHANNEL 1 EQ LOWMID Q 30,,,96 = 0.36,,,16.0 (*4)
04 00 00 76 04 00 00 77#	0aaaaaaa 0bbbbbbb	INPUT CHANNEL 1 EQ HIGHMID GAIN -150,,,150 = -15.0,,,+15.0dB

04 00 00 7E	0aaaaaaa	INPUT CHANNEL 1 EQ HIGHMID FREQUENCY
04 00 00 7F#	0bbbbbbb	20,,,140 = 20Hz,,,20.0kHz (*3)
04 00 01 00	0aaaaaaa	INPUT CHANNEL 1 EQ HIGHMID Q
04 00 01 01#	0bbbbbbb	30,,,96 = 0.36,,,16.0 (*4)
04 00 01 02	0aaaaaaa	INPUT CHANNEL 1 EQ HIGH GAIN
04 00 01 03#	0bbbbbbb	-150,,,150 = -15.0,,,+15.0dB
04 00 01 04	0aaaaaaa	INPUT CHANNEL 1 EQ HIGH FREQUENCY
04 00 01 05#	0bbbbbbb	88,,,140 = 1.00kHz,,,20.0kHz (*3)
04 00 01 06	00	(Reserved)
:	:	:
04 00 01 0B	00	(Reserved)
04 00 01 0C	00 - 7F	INPUT CHANNEL 1 INPUT SELECT 127 = Off
		0,,,3 = A.IN1x2,,,A.IN7x8
		8,,,11 = R-BUS_1x2,,,R-BUS_7x8
		12 = DIGITAL IN
04 00 01 0D	00	(Reserved)
04 00 01 0E	00	(Reserved)
04 00 01 0F	00	(Reserved)
04 00 01 10	00 - 01	INPUT CHANNEL 1 MIX SEND SWITCH Off,On
04 00 01 11	00 - 01	INPUT CHANNEL 1 DIR1 SELECT SWITCH Off,On
04 00 01 12	00 - 01	INPUT CHANNEL 1 DIR2 SELECT SWITCH Off,On
04 00 01 13	00 - 01	INPUT CHANNEL 1 DIR3 SELECT SWITCH Off,On
04 00 01 14	00 - 01	INPUT CHANNEL 1 DIR4 SELECT SWITCH Off,On
04 00 01 15	00 - 01	INPUT CHANNEL 1 DIR5 SELECT SWITCH Off,On
04 00 01 16	00 - 01	INPUT CHANNEL 1 DIR6 SELECT SWITCH Off,On
04 00 01 17	00 - 01	INPUT CHANNEL 1 DIR7 SELECT SWITCH Off,On
04 00 01 18	00 - 01	INPUT CHANNEL 1 DIR8 SELECT SWITCH Off,On
04 00 01 19	00	(Reserved)
04 00 01 1A	00	(Reserved)
04 00 01 1B	00 - 01	INPUT CHANNEL 1 PAN MODE NRM,RSS
04 00 01 1C	00 - 77	INPUT CHANNEL 1 RSS PAN
		0,1,,,59,60,61,,,119 =
		0,R3,,,R177,180,L177,,,L3
04 00 01 1D	00	(Reserved)
:	:	:
04 00 7F 7F	00	(Reserved)
04 01 00 00	00 -	INPUT CHANNEL 2
:	:	(similar to 04 00 00 00 - 04 00 7F 7F)
:	:	:
04 01 7F 7F	00 -	
:	:	:
04 0F 00 00	00 -	INPUT CHANNEL 16
:	:	(similar to 04 00 00 00 - 04 00 7F 7F)
:	:	:
04 0F 7F 7F	00 -	
:	:	:
04 10 00 00	00	(Reserved)
:	:	:
04 1F 7F 7F	00	(Reserved)
04 20 00 00	0aaaaaaa	TRACK CHANNEL 1 ATT
04 20 00 01#	0bbbbbbb	-420,,,60 = -42.0,,,+6.0dB
04 20 00 02	00 - 01	TRACK CHANNEL 1 PHASE NRM,INV
04 20 00 03	00 - 7F	TRACK CHANNEL 1 GROUP
		127,0,,,11 = Off,1,,,12
04 20 00 04	00 - 01	TRACK CHANNEL 1 LINK Off,On
04 20 00 05	00 - 01	TRACK CHANNEL 1 FADER LINK Off,On
04 20 00 06	0aaaaaaa	TRACK CHANNEL 1 FADER LEVEL
04 20 00 07#	0bbbbbbb	less than -905,-905,,,60 =
		-Inf,-90.5,,,+6.0dB
04 20 00 08	0aaaaaaa	TRACK CHANNEL 1 OFFSET FADER LEVEL
04 20 00 09#	0bbbbbbb	less than -905,-905,,,60 =
		-Inf,-90.5,,,+6.0dB
04 20 00 0A	00	(Reserved)
04 20 00 0B	00	(Reserved)
04 20 00 0C	00	(Reserved)
04 20 00 0D	01 - 7F	TRACK CHANNEL 1 PAN L63,,,R63
04 20 00 0E	01 - 7F	TRACK CHANNEL 1 OFFSET PAN L63,,,R63
04 20 00 0F	00 - 01	TRACK CHANNEL 1 SOLO Off,On
04 20 00 10	00 - 01	TRACK CHANNEL 1 MUTE Off,On
04 20 00 11	00 - 7F	TRACK CHANNEL 1 ASSIGN TRACK SELECT
		127,0,,,23 = Off,Tr1,,,Tr24

04 20 00 12	00 - 01	TRACK CHANNEL 1 AUX1 SEND SWITCH Off,On
04 20 00 13	00 - 01	TRACK CHANNEL 1 AUX2 SEND SWITCH Off,On
04 20 00 14	00 - 01	TRACK CHANNEL 1 AUX3 SEND SWITCH Off,On
04 20 00 15	00 - 01	TRACK CHANNEL 1 AUX4 SEND SWITCH Off,On
04 20 00 16	00 - 01	TRACK CHANNEL 1 AUX5 SEND SWITCH Off,On
04 20 00 17	00 - 01	TRACK CHANNEL 1 AUX6 SEND SWITCH Off,On
04 20 00 18	00 - 01	TRACK CHANNEL 1 AUX7 SEND SWITCH Off,On
04 20 00 19	00 - 01	TRACK CHANNEL 1 AUX8 SEND SWITCH Off,On
04 20 00 1A	0aaaaaaa	TRACK CHANNEL 1 AUX1 SEND LEVEL
04 20 00 1B#	0bbbbbbb	less than -905,-905,,,60 =
		-Inf,-90.5,,,+6.0dB
04 20 00 1C	0aaaaaaa	TRACK CHANNEL 1 AUX2 SEND LEVEL
04 20 00 1D#	0bbbbbbb	less than -905,-905,,,60 =
		-Inf,-90.5,,,+6.0dB
04 20 00 1E	0aaaaaaa	TRACK CHANNEL 1 AUX3 SEND LEVEL
04 20 00 1F#	0bbbbbbb	less than -905,-905,,,60 =
		-Inf,-90.5,,,+6.0dB
04 20 00 20	0aaaaaaa	TRACK CHANNEL 1 AUX4 SEND LEVEL
04 20 00 21#	0bbbbbbb	less than -905,-905,,,60 =
		-Inf,-90.5,,,+6.0dB
04 20 00 22	0aaaaaaa	TRACK CHANNEL 1 AUX5 SEND LEVEL
04 20 00 23#	0bbbbbbb	less than -905,-905,,,60 =
		-Inf,-90.5,,,+6.0dB
04 20 00 24	0aaaaaaa	TRACK CHANNEL 1 AUX6 SEND LEVEL
04 20 00 25#	0bbbbbbb	less than -905,-905,,,60 =
		-Inf,-90.5,,,+6.0dB
04 20 00 26	0aaaaaaa	TRACK CHANNEL 1 AUX7 SEND LEVEL
04 20 00 27#	0bbbbbbb	less than -905,-905,,,60 =
		-Inf,-90.5,,,+6.0dB
04 20 00 28	0aaaaaaa	TRACK CHANNEL 1 AUX8 SEND LEVEL
04 20 00 29#	0bbbbbbb	less than -905,-905,,,60 =
		-Inf,-90.5,,,+6.0dB
04 20 00 2A	01 - 7F	TRACK CHANNEL 1 AUX1/2 SEND PAN L63,,,R63
04 20 00 2B	01 - 7F	TRACK CHANNEL 1 AUX3/4 SEND PAN L63,,,R63
04 20 00 2C	01 - 7F	TRACK CHANNEL 1 AUX5/6 SEND PAN L63,,,R63
04 20 00 2D	01 - 7F	TRACK CHANNEL 1 AUX7/8 SEND PAN L63,,,R63
04 20 00 2E	00 - 04	TRACK CHANNEL 1 FX1 INSERT SWITCH
		Off,Ins,InsL,InsR,InsS
04 20 00 2F	00 - 04	TRACK CHANNEL 1 FX2 INSERT SWITCH
		Off,Ins,InsL,InsR,InsS
04 20 00 30	00 - 04	TRACK CHANNEL 1 FX3 INSERT SWITCH
		Off,Ins,InsL,InsR,InsS
04 20 00 31	00 - 04	TRACK CHANNEL 1 FX4 INSERT SWITCH
		Off,Ins,InsL,InsR,InsS
04 20 00 32	00	(Reserved)
:	:	:
04 20 00 35	00	(Reserved)
04 20 00 36	0aaaaaaa	TRACK CHANNEL 1 FX1 INSERT SEND LEVEL
04 20 00 37#	0bbbbbbb	less than -905,-905,,,60 =
		-Inf,-90.5,,,+6.0dB
04 20 00 38	0aaaaaaa	TRACK CHANNEL 1 FX2 INSERT SEND LEVEL
04 20 00 39#	0bbbbbbb	less than -905,-905,,,60 =
		-Inf,-90.5,,,+6.0dB
04 20 00 3A	0aaaaaaa	TRACK CHANNEL 1 FX3 INSERT SEND LEVEL
04 20 00 3B#	0bbbbbbb	less than -905,-905,,,60 =
		-Inf,-90.5,,,+6.0dB
04 20 00 3C	0aaaaaaa	TRACK CHANNEL 1 FX4 INSERT SEND LEVEL
04 20 00 3D#	0bbbbbbb	less than -905,-905,,,60 =
		-Inf,-90.5,,,+6.0dB
04 20 00 3E	00	(Reserved)
:	:	:
04 20 00 45	00	(Reserved)
04 20 00 46	0aaaaaaa	TRACK CHANNEL 1 FX1 INSERT RETURN LEVEL
04 20 00 47#	0bbbbbbb	less than -905,-905,,,60 =
		-Inf,-90.5,,,+6.0dB
04 20 00 48	0aaaaaaa	TRACK CHANNEL 1 FX2 INSERT RETURN LEVEL
04 20 00 49#	0bbbbbbb	less than -905,-905,,,60 =
		-Inf,-90.5,,,+6.0dB
04 20 00 4A	0aaaaaaa	TRACK CHANNEL 1 FX3 INSERT RETURN LEVEL
04 20 00 4B#	0bbbbbbb	less than -905,-905,,,60 =
		-Inf,-90.5,,,+6.0dB
04 20 00 4C	0aaaaaaa	TRACK CHANNEL 1 FX4 INSERT RETURN LEVEL
04 20 00 4D#	0bbbbbbb	less than -905,-905,,,60 =
		-Inf,-90.5,,,+6.0dB
04 20 00 4E	00	(Reserved)
:	:	:
04 20 00 55	00	(Reserved)
04 20 00 56	01 - 7F	TRACK CHANNEL 1 SURROUND PAN L63,,,R63

MIDI Implementation

04 20 00 57	01 - 7F	TRACK CHANNEL 1 SURROUND DEPTH R63,,,F63
04 20 00 58	01 - 64	TRACK CHANNEL 1 SURROUND LRC 0,,,100%
04 20 00 59	00	(Reserved)
04 20 00 5A 04 20 00 5B#	0aaaaaaa 0bbbbbbb	TRACK CHANNEL 1 SURROUND SUBWOOFER LEVEL less than -905,-905,,,60 = -Inf,-90.5,,,+6.0dB
04 20 00 5C	00 - 01	TRACK CHANNEL 1 DYNAMICS SWITCH Off,On
04 20 00 5D	00 - 01	TRACK CHANNEL 1 DYNAMICS TYPE CMP,EXP
04 20 00 5E	00 - 17	TRACK CHANNEL 1 DYNAMICS CMP KEYIN CH1,,,CH24
04 20 00 5F	00	(Reserved)
04 20 00 60 04 20 00 61#	0aaaaaaa 0bbbbbbb	TRACK CHANNEL 1 DYNAMICS CMP THRESHOLD -240,,,0 = -24.0,,,0.0dB
04 20 00 62	00 - 0D	TRACK CHANNEL 1 DYNAMICS CMP RATIO 1.00:1,,,Inf:1 (*1)
04 20 00 63	00	(Reserved)
04 20 00 64	00 - 7C	TRACK CHANNEL 1 DYNAMICS CMP ATTACK 0.0,,,800.0ms (*2)
04 20 00 65	00 - 7C	TRACK CHANNEL 1 DYNAMICS CMP RELEASE 0,,,800ms (*2)
04 20 00 66 04 20 00 67#	0aaaaaaa 0bbbbbbb	TRACK CHANNEL 1 DYNAMICS CMP LEVEL -240,,,240 = -24.0,,,+24.0dB -240,,,60 = -24.0,,,+6.0dB when AUTO GAIN is On
04 20 00 68	00 - 01	TRACK CHANNEL 1 DYNAMICS CMP AUTO GAIN Off,On
04 20 00 69	00 - 17	TRACK CHANNEL 1 DYNAMICS EXP KEYIN CH1,,,CH24
04 20 00 6A 04 20 00 6B#	0aaaaaaa 0bbbbbbb	TRACK CHANNEL 1 DYNAMICS EXP THRESHOLD -800,,,0 = -80.0,,,0.0dB
04 20 00 6C	00 - 0D	TRACK CHANNEL 1 DYNAMICS EXP RATIO 1.00:1,,,Inf:1 (*1)
04 20 00 6D	00	(Reserved)
04 20 00 6E	00 - 7C	TRACK CHANNEL 1 DYNAMICS EXP ATTACK 0.0,,,800.0ms (*2)
04 20 00 6F	00 - 7C	TRACK CHANNEL 1 DYNAMICS EXP RELEASE 0,,,800ms (*2)
04 20 00 70	00 - 01	TRACK CHANNEL 1 EQ SWITCH Off,On
04 20 00 71	00	(Reserved)
04 20 00 72 04 20 00 73#	0aaaaaaa 0bbbbbbb	TRACK CHANNEL 1 EQ LOW GAIN -150,,,150 = -15.0,,,+15.0dB
04 20 00 74 04 20 00 75#	0aaaaaaa 0bbbbbbb	TRACK CHANNEL 1 EQ LOW FREQUENCY 20,,,88 = 20Hz,,,1.00kHz (*3)
04 20 00 76 04 20 00 77#	0aaaaaaa 0bbbbbbb	TRACK CHANNEL 1 EQ LOWMID GAIN -150,,,150 = -15.0,,,+15.0dB
04 20 00 78 04 20 00 79#	0aaaaaaa 0bbbbbbb	TRACK CHANNEL 1 EQ LOWMID FREQUENCY 20,,,140 = 20Hz,,,20.0kHz (*3)
04 20 00 7A 04 20 00 7B#	0aaaaaaa 0bbbbbbb	TRACK CHANNEL 1 EQ LOWMID Q 30,,,96 = 0.36,,,16.0 (*4)
04 20 00 7C 04 20 00 7D#	0aaaaaaa 0bbbbbbb	TRACK CHANNEL 1 EQ HIGHMID GAIN -150,,,150 = -15.0,,,+15.0dB
04 20 00 7E 04 20 00 7F#	0aaaaaaa 0bbbbbbb	TRACK CHANNEL 1 EQ HIGHMID FREQUENCY 20,,,140 = 20Hz,,,20.0kHz (*3)
04 20 01 00 04 20 01 01#	0aaaaaaa 0bbbbbbb	TRACK CHANNEL 1 EQ HIGHMID Q 30,,,96 = 0.36,,,16.0 (*4)
04 20 01 02 04 20 01 03#	0aaaaaaa 0bbbbbbb	TRACK CHANNEL 1 EQ HIGH GAIN -150,,,150 = -15.0,,,+15.0dB
04 20 01 04 04 20 01 05#	0aaaaaaa 0bbbbbbb	TRACK CHANNEL 1 EQ HIGH FREQUENCY 88,,,140 = 1.00kHz,,,20.0kHz (*3)
04 20 01 06	00	(Reserved)
: 04 20 01 0B	: 00	: (Reserved)
04 20 01 0C	00	(Reserved)
04 20 01 0D	01 - 03	TRACK STATUS PLAY,REC,OFF
04 20 01 0E	00 - 0F	V.TRACK SELECT 1,,,16
04 20 01 0F	00	(Reserved)
04 20 01 10	00 - 01	TRACK CHANNEL 1 MIX SEND SWITCH Off,On
04 20 01 11	00 - 01	TRACK CHANNEL 1 DIR1 SELECT SWITCH Off,On
04 20 01 12	00 - 01	TRACK CHANNEL 1 DIR2 SELECT SWITCH Off,On
04 20 01 13	00 - 01	TRACK CHANNEL 1 DIR3 SELECT SWITCH Off,On

04 20 01 14	00 - 01	TRACK CHANNEL 1 DIR4 SELECT SWITCH Off,On
04 20 01 15	00 - 01	TRACK CHANNEL 1 DIR5 SELECT SWITCH Off,On
04 20 01 16	00 - 01	TRACK CHANNEL 1 DIR6 SELECT SWITCH Off,On
04 20 01 17	00 - 01	TRACK CHANNEL 1 DIR7 SELECT SWITCH Off,On
04 20 01 18	00 - 01	TRACK CHANNEL 1 DIR8 SELECT SWITCH Off,On
04 20 01 19	00	(Reserved)
04 20 01 1A	00	(Reserved)
04 20 01 1B	00 - 01	TRACK CHANNEL 1 PAN MODE NRM,RSS
04 20 01 1C	00 - 77	TRACK CHANNEL 1 RSS PAN 0,1,,,59,60,61,,,119 = 0,R3,,,R177,180,L177,,,L3
04 20 01 1D	00	(Reserved)
: 04 20 7F 7F	: 00	: (Reserved)
04 21 00 00	00 -	TRACK CHANNEL 2 (similar to 04 20 00 00 - 04 20 7F 7F)
: 04 21 7F 7F	: 00 -	: (Reserved)
: 04 37 00 00	: 00 -	: TRACK CHANNEL 24 (similar to 04 20 00 00 - 04 20 7F 7F)
: 04 37 7F 7F	: 00 -	: (Reserved)
04 38 00 00	00	(Reserved)
: 04 3F 7F 7F	: 00	: (Reserved)
04 40 00 00	00 - 7F	RETURN CHANNEL 1 INPUT SELECT 127,0,,,15 = Off,AUX1,,,DIR8
04 40 00 01	00	(Reserved)
: 04 40 00 03	: 00	: (Reserved)
04 40 00 04	00 - 7F	RETURN CHANNEL 1 GROUP 127,0,,,11 = Off,1,,,12
04 40 00 05	00 - 01	RETURN CHANNEL 1 MONO SWITCH Off,On
04 40 00 06	00	(Reserved)
04 40 00 07	00	(Reserved)
04 40 00 08 04 40 00 09#	0aaaaaaa 0bbbbbbb	RETURN CHANNEL 1 FADER LEVEL less than -905,-905,,,60 = -Inf,-90.5,,,+6.0dB
04 40 00 0A	00	(Reserved)
: 04 40 00 0C	: 00	: (Reserved)
04 40 00 0D	01 - 7F	RETURN CHANNEL 1 BALANCE L63,,,R63
04 40 00 0E	00	(Reserved)
04 40 00 0F	00 - 01	RETURN CHANNEL 1 SOLO Off,On
04 40 00 10	00 - 01	RETURN CHANNEL 1 MUTE Off,On
04 40 00 11	00 - 7F	RETURN CHANNEL 1 ASSIGN TRACK SELECT 127,0,,,23 = Off,Tr1,,,Tr24
04 40 00 12	00 - 01	RETURN CHANNEL 1 AUX1 SEND SWITCH Off,On
04 40 00 13	00 - 01	RETURN CHANNEL 1 AUX2 SEND SWITCH Off,On
04 40 00 14	00 - 01	RETURN CHANNEL 1 AUX3 SEND SWITCH Off,On
04 40 00 15	00 - 01	RETURN CHANNEL 1 AUX4 SEND SWITCH Off,On
04 40 00 16	00 - 01	RETURN CHANNEL 1 AUX5 SEND SWITCH Off,On
04 40 00 17	00 - 01	RETURN CHANNEL 1 AUX6 SEND SWITCH Off,On
04 40 00 18	00 - 01	RETURN CHANNEL 1 AUX7 SEND SWITCH Off,On
04 40 00 19	00 - 01	RETURN CHANNEL 1 AUX8 SEND SWITCH Off,On
04 40 00 1A 04 40 00 1B#	0aaaaaaa 0bbbbbbb	RETURN CHANNEL 1 AUX1 SEND LEVEL less than -905,-905,,,60 = -Inf,-90.5,,,+6.0dB
04 40 00 1C 04 40 00 1D#	0aaaaaaa 0bbbbbbb	RETURN CHANNEL 1 AUX2 SEND LEVEL less than -905,-905,,,60 = -Inf,-90.5,,,+6.0dB
04 40 00 1E 04 40 00 1F#	0aaaaaaa 0bbbbbbb	RETURN CHANNEL 1 AUX3 SEND LEVEL less than -905,-905,,,60 = -Inf,-90.5,,,+6.0dB
04 40 00 20 04 40 00 21#	0aaaaaaa 0bbbbbbb	RETURN CHANNEL 1 AUX4 SEND LEVEL less than -905,-905,,,60 = -Inf,-90.5,,,+6.0dB

04 40 00 22	0aaaaaaaa	RETURN CHANNEL 1 AUX5 SEND LEVEL	
04 40 00 23#	0bbbbbbb	less than -905,-905,,,60 =	-Inf,-90.5,,,+6.0dB
04 40 00 24	0aaaaaaaa	RETURN CHANNEL 1 AUX6 SEND LEVEL	
04 40 00 25#	0bbbbbbb	less than -905,-905,,,60 =	-Inf,-90.5,,,+6.0dB
04 40 00 26	0aaaaaaaa	RETURN CHANNEL 1 AUX7 SEND LEVEL	
04 40 00 27#	0bbbbbbb	less than -905,-905,,,60 =	-Inf,-90.5,,,+6.0dB
04 40 00 28	0aaaaaaaa	RETURN CHANNEL 1 AUX8 SEND LEVEL	
04 40 00 29#	0bbbbbbb	less than -905,-905,,,60 =	-Inf,-90.5,,,+6.0dB
04 40 00 2A	01 - 7F	RETURN CHANNEL 1 AUX1/2 SEND PAN	L63,,,R63
04 40 00 2B	01 - 7F	RETURN CHANNEL 1 AUX3/4 SEND PAN	L63,,,R63
04 40 00 2C	01 - 7F	RETURN CHANNEL 1 AUX5/6 SEND PAN	L63,,,R63
04 40 00 2D	01 - 7F	RETURN CHANNEL 1 AUX7/8 SEND PAN	L63,,,R63
04 40 00 2E	00	(Reserved)	
:	:	:	:
04 40 00 55	00	(Reserved)	
04 40 00 56	01 - 7F	RETURN CHANNEL 1 SURROUND PANL63,,,R63	
04 40 00 57	01 - 7F	RETURN CHANNEL 1 SURROUND DEPTH	R63,,,F63
04 40 00 58	01 - 64	RETURN CHANNEL 1 SURROUND LRC	0,,,100%
04 40 00 59	00	(Reserved)	
04 40 00 5A	0aaaaaaaa	RETURN CHANNEL 1 SURROUND SUBWOOFER LEVEL	
04 40 00 5B#	0bbbbbbb	less than -905,-905,,,60 =	-Inf,-90.5,,,+6.0dB
04 40 00 5C	00	(Reserved)	
:	:	:	:
04 40 01 0F	00	(Reserved)	
04 40 01 10	00 - 01	RETURN CHANNEL 1 MIX SEND SWITCH	Off,On
04 40 01 11	00 - 01	RETURN CHANNEL 1 DIR1 SELECT SWITCH	Off,On
04 40 01 12	00 - 01	RETURN CHANNEL 1 DIR2 SELECT SWITCH	Off,On
04 40 01 13	00 - 01	RETURN CHANNEL 1 DIR3 SELECT SWITCH	Off,On
04 40 01 14	00 - 01	RETURN CHANNEL 1 DIR4 SELECT SWITCH	Off,On
04 40 01 15	00 - 01	RETURN CHANNEL 1 DIR5 SELECT SWITCH	Off,On
04 40 01 16	00 - 01	RETURN CHANNEL 1 DIR6 SELECT SWITCH	Off,On
04 40 01 17	00 - 01	RETURN CHANNEL 1 DIR7 SELECT SWITCH	Off,On
04 40 01 18	00 - 01	RETURN CHANNEL 1 DIR8 SELECT SWITCH	Off,On
04 40 01 19	00	(Reserved)	
:	:	:	:
04 40 7F 7F	00	(Reserved)	
04 41 00 00	00 -	RETURN CHANNEL 2	(similar to 04 40 00 00 - 04 40 7F 7F)
:	:	:	:
04 41 7F 7F	00 -	:	:
:	:	:	:
04 43 00 00	00 -	RETURN CHANNEL 4	(similar to 04 40 00 00 - 04 40 7F 7F)
:	:	:	:
04 43 7F 7F	00 -	:	:
04 44 00 00	00	(Reserved)	
:	:	:	:
04 4F 7F 7F	00	(Reserved)	
04 50 00 00	0aaaaaaaa	MASTER LEVEL	
04 50 00 01#	0bbbbbbb	less than -905,-905,,,60 =	-Inf,-90.5,,,+6.0dB
04 50 00 02	01 - 7F	MASTER BALANCE	L63,,,R63
04 50 00 03	00	(Reserved)	
04 50 00 04	0aaaaaaaa	MONITOR LEVEL (*5)	
04 50 00 05#	0bbbbbbb	less than -905,-905,,,60 =	-Inf,-90.5,,,+6.0dB
04 50 00 06	01 - 7F	MONITOR BALANCE	L63,,,R63
04 50 00 07	00	(Reserved)	
04 50 00 08	00 - 01	AUX1 MASTER POSITION	Pre,Pst
04 50 00 09	00 - 01	AUX2 MASTER POSITION	Pre,Pst
04 50 00 0A	00 - 01	AUX3 MASTER POSITION	Pre,Pst

04 50 00 0B	00 - 01	AUX4 MASTER POSITION	Pre,Pst
04 50 00 0C	00 - 01	AUX5 MASTER POSITION	Pre,Pst
04 50 00 0D	00 - 01	AUX6 MASTER POSITION	Pre,Pst
04 50 00 0E	00 - 01	AUX7 MASTER POSITION	Pre,Pst
04 50 00 0F	00 - 01	AUX8 MASTER POSITION	Pre,Pst
04 50 00 10	0aaaaaaaa	AUX1 MASTER LEVEL	
04 50 00 11#	0bbbbbbb	less than -905,-905,,,60 =	-Inf,-90.5,,,+6.0dB
04 50 00 12	0aaaaaaaa	AUX2 MASTER LEVEL	
04 50 00 13#	0bbbbbbb	less than -905,-905,,,60 =	-Inf,-90.5,,,+6.0dB
04 50 00 14	0aaaaaaaa	AUX3 MASTER LEVEL	
04 50 00 15#	0bbbbbbb	less than -905,-905,,,60 =	-Inf,-90.5,,,+6.0dB
04 50 00 16	0aaaaaaaa	AUX4 MASTER LEVEL	
04 50 00 17#	0bbbbbbb	less than -905,-905,,,60 =	-Inf,-90.5,,,+6.0dB
04 50 00 18	0aaaaaaaa	AUX5 MASTER LEVEL	
04 50 00 19#	0bbbbbbb	less than -905,-905,,,60 =	-Inf,-90.5,,,+6.0dB
04 50 00 1A	0aaaaaaaa	AUX6 MASTER LEVEL	
04 50 00 1B#	0bbbbbbb	less than -905,-905,,,60 =	-Inf,-90.5,,,+6.0dB
04 50 00 1C	0aaaaaaaa	AUX7 MASTER LEVEL	
04 50 00 1D#	0bbbbbbb	less than -905,-905,,,60 =	-Inf,-90.5,,,+6.0dB
04 50 00 1E	0aaaaaaaa	AUX8 MASTER LEVEL	
04 50 00 1F#	0bbbbbbb	less than -905,-905,,,60 =	-Inf,-90.5,,,+6.0dB
04 50 00 20	00 - 01	AUX1/2 BUS LINK	Off,On
04 50 00 21	00 - 01	AUX3/4 BUS LINK	Off,On
04 50 00 22	00 - 01	AUX5/6 BUS LINK	Off,On
04 50 00 23	00 - 01	AUX7/8 BUS LINK	Off,On
04 50 00 24	01 - 7F	AUX1/2 MASTER BALANCE	L63,,,R63
04 50 00 25	01 - 7F	AUX3/4 MASTER BALANCE	L63,,,R63
04 50 00 26	01 - 7F	AUX5/6 MASTER BALANCE	L63,,,R63
04 50 00 27	01 - 7F	AUX7/8 MASTER BALANCE	L63,,,R63
04 50 00 28	00 - 7F	AUX1 ASSIGN TRACK SELECT	127,0,,,23 = Off,Tr1,,,Tr24
04 50 00 29	00 - 7F	AUX2 ASSIGN TRACK SELECT	127,0,,,23 = Off,Tr1,,,Tr24
04 50 00 2A	00 - 7F	AUX3 ASSIGN TRACK SELECT	127,0,,,23 = Off,Tr1,,,Tr24
04 50 00 2B	00 - 7F	AUX4 ASSIGN TRACK SELECT	127,0,,,23 = Off,Tr1,,,Tr24
04 50 00 2C	00 - 7F	AUX5 ASSIGN TRACK SELECT	127,0,,,23 = Off,Tr1,,,Tr24
04 50 00 2D	00 - 7F	AUX6 ASSIGN TRACK SELECT	127,0,,,23 = Off,Tr1,,,Tr24
04 50 00 2E	00 - 7F	AUX7 ASSIGN TRACK SELECT	127,0,,,23 = Off,Tr1,,,Tr24
04 50 00 2F	00 - 7F	AUX8 ASSIGN TRACK SELECT	127,0,,,23 = Off,Tr1,,,Tr24
04 50 00 30	00 - 01	DIR1 MASTER POSITION	Pre,Pst
04 50 00 31	00 - 01	DIR2 MASTER POSITION	Pre,Pst
04 50 00 32	00 - 01	DIR3 MASTER POSITION	Pre,Pst
04 50 00 33	00 - 01	DIR4 MASTER POSITION	Pre,Pst
04 50 00 34	00 - 01	DIR5 MASTER POSITION	Pre,Pst
04 50 00 35	00 - 01	DIR6 MASTER POSITION	Pre,Pst
04 50 00 36	00 - 01	DIR7 MASTER POSITION	Pre,Pst
04 50 00 37	00 - 01	DIR8 MASTER POSITION	Pre,Pst
04 50 00 38	0aaaaaaaa	DIR1 MASTER LEVEL	
04 50 00 39#	0bbbbbbb	less than -905,-905,,,60 =	-Inf,-90.5,,,+6.0dB
04 50 00 3A	0aaaaaaaa	DIR2 MASTER LEVEL	
04 50 00 3B#	0bbbbbbb	less than -905,-905,,,60 =	-Inf,-90.5,,,+6.0dB
04 50 00 3C	0aaaaaaaa	DIR3 MASTER LEVEL	
04 50 00 3D#	0bbbbbbb	less than -905,-905,,,60 =	-Inf,-90.5,,,+6.0dB
04 50 00 3E	0aaaaaaaa	DIR4 MASTER LEVEL	
04 50 00 3F#	0bbbbbbb	less than -905,-905,,,60 =	-Inf,-90.5,,,+6.0dB
04 50 00 40	0aaaaaaaa	DIR5 MASTER LEVEL	
04 50 00 41#	0bbbbbbb	less than -905,-905,,,60 =	-Inf,-90.5,,,+6.0dB

MIDI Implementation

04 50 00 42	0aaaaaaa	DIR6 MASTER LEVEL	
04 50 00 43#	0bbbbbbb	less than -905,-905,,,60 =	-Inf,-90.5,,,+6.0dB
04 50 00 44	0aaaaaaa	DIR7 MASTER LEVEL	
04 50 00 45#	0bbbbbbb	less than -905,-905,,,60 =	-Inf,-90.5,,,+6.0dB
04 50 00 46	0aaaaaaa	DIR8 MASTER LEVEL	
04 50 00 47#	0bbbbbbb	less than -905,-905,,,60 =	-Inf,-90.5,,,+6.0dB
04 50 00 48	01 - 7F	DIR1/2 MASTER BALANCE	L63,,,R63
04 50 00 49	01 - 7F	DIR3/4 MASTER BALANCE	L63,,,R63
04 50 00 4A	01 - 7F	DIR5/6 MASTER BALANCE	L63,,,R63
04 50 00 4B	01 - 7F	DIR7/8 MASTER BALANCE	L63,,,R63
04 50 00 4C	00 - 7F	DIR1 ASSIGN TRACK SELECT	127,0,,,23 = Off,Tr1,,,Tr24
04 50 00 4D	00 - 7F	DIR2 ASSIGN TRACK SELECT	127,0,,,23 = Off,Tr1,,,Tr24
04 50 00 4E	00 - 7F	DIR3 ASSIGN TRACK SELECT	127,0,,,23 = Off,Tr1,,,Tr24
04 50 00 4F	00 - 7F	DIR4 ASSIGN TRACK SELECT	127,0,,,23 = Off,Tr1,,,Tr24
04 50 00 50	00 - 7F	DIR5 ASSIGN TRACK SELECT	127,0,,,23 = Off,Tr1,,,Tr24
04 50 00 51	00 - 7F	DIR6 ASSIGN TRACK SELECT	127,0,,,23 = Off,Tr1,,,Tr24
04 50 00 52	00 - 7F	DIR7 ASSIGN TRACK SELECT	127,0,,,23 = Off,Tr1,,,Tr24
04 50 00 53	00 - 7F	DIR8 ASSIGN TRACK SELECT	127,0,,,23 = Off,Tr1,,,Tr24
04 50 00 54	00	(Reserved)	
04 50 00 57	00	(Reserved)	
04 50 00 58	00 - 01	MASTER FX1 INSERT SWITCH	Off,Ins
04 50 00 59	00 - 01	MASTER FX2 INSERT SWITCH	Off,Ins
04 50 00 5A	00 - 01	MASTER FX3 INSERT SWITCH	Off,Ins
04 50 00 5B	00 - 01	MASTER FX4 INSERT SWITCH	Off,Ins
04 50 00 5C	00	(Reserved)	
04 50 00 5F	00	(Reserved)	
04 50 00 60	0aaaaaaa	MASTER FX1 INSERT SEND LEVEL	
04 50 00 61#	0bbbbbbb	less than -905,-905,,,60 =	-Inf,-90.5,,,+6.0dB
04 50 00 62	0aaaaaaa	MASTER FX2 INSERT SEND LEVEL	
04 50 00 63#	0bbbbbbb	less than -905,-905,,,60 =	-Inf,-90.5,,,+6.0dB
04 50 00 64	0aaaaaaa	MASTER FX3 INSERT SEND LEVEL	
04 50 00 65#	0bbbbbbb	less than -905,-905,,,60 =	-Inf,-90.5,,,+6.0dB
04 50 00 66	0aaaaaaa	MASTER FX4 INSERT SEND LEVEL	
04 50 00 67#	0bbbbbbb	less than -905,-905,,,60 =	-Inf,-90.5,,,+6.0dB
04 50 00 68	00	(Reserved)	
04 50 00 6F	00	(Reserved)	
04 50 00 70	0aaaaaaa	MASTER FX1 INSERT RETURN LEVEL	
04 50 00 71#	0bbbbbbb	less than -905,-905,,,60 =	-Inf,-90.5,,,+6.0dB
04 50 00 72	0aaaaaaa	MASTER FX2 INSERT RETURN LEVEL	
04 50 00 73#	0bbbbbbb	less than -905,-905,,,60 =	-Inf,-90.5,,,+6.0dB
04 50 00 74	0aaaaaaa	MASTER FX3 INSERT RETURN LEVEL	
04 50 00 75#	0bbbbbbb	less than -905,-905,,,60 =	-Inf,-90.5,,,+6.0dB
04 50 00 76	0aaaaaaa	MASTER FX4 INSERT RETURN LEVEL	
04 50 00 77#	0bbbbbbb	less than -905,-905,,,60 =	-Inf,-90.5,,,+6.0dB
04 50 00 78	00	(Reserved)	
04 50 00 7F	00	(Reserved)	
04 50 01 00	00 - 11	MONITOR SOURCE	MASTER, REC BUS, AUX1,,,AUX8, DIR1,,,DIR8
04 50 01 01	00	(Reserved)	
04 50 01 02	00	(Reserved)	
04 50 01 03	00	(Reserved)	
04 50 01 04	00 - 09	A.MULTI 1/2 SOURCE	(*6) MASTER, MONITOR, AUX1/2, AUX3/4, L/R, Ls/Rs, DIR1/2,,,DIR7/8 (*7) MASTER, MONITOR, AUX1/2, AUX3/4, L/R, C/RC, DIR1/2,,,DIR7/8 (*8) MASTER, MONITOR, AUX1/2, L/R, Sub.W/C, Ls/Rs, DIR1/2,,,DIR7/8 (*9)

04 50 01 05	00 - 09	AUX A SOURCE (*10)	MASTER, MONITOR, AUX1/2,,,AUX7/8, DIR1/2,,,DIR7/8
		A.MULTI 3/4 SOURCE	MASTER, MONITOR, AUX1/2, AUX3/4, L/R, Ls/Rs, DIR1/2,,,DIR7/8 (*7) MASTER, MONITOR, AUX1/2, AUX3/4, L/R, C/RC, DIR1/2,,,DIR7/8 (*8) MASTER, MONITOR, AUX1/2, L/R, Sub.W/C, Ls/Rs, DIR1/2,,,DIR7/8 (*9)
04 50 01 06	00 - 09	AUX B SOURCE (*10)	MASTER, MONITOR, AUX1/2,,,AUX7/8, DIR1/2,,,DIR7/8
		A.MULTI 5/6 SOURCE	MASTER, MONITOR, AUX1/2, AUX3/4, L/R, Ls/Rs, DIR1/2,,,DIR7/8 (*7) MASTER, MONITOR, AUX1/2, AUX3/4, L/R, C/RC, DIR1/2,,,DIR7/8 (*8) MASTER, MONITOR, AUX1/2, L/R, Sub.W/C, Ls/Rs, DIR1/2,,,DIR7/8 (*9)
04 50 01 07	00 - 09	A.MULTI 7/8 SOURCE	(*6) MASTER, MONITOR, AUX1/2, AUX3/4, L/R, Ls/Rs, DIR1/2,,,DIR7/8 (*7) MASTER, MONITOR, AUX1/2, AUX3/4, L/R, C/RC, DIR1/2,,,DIR7/8 (*8) MASTER, MONITOR, AUX1/2, L/R, Sub.W/C, Ls/Rs, DIR1/2,,,DIR7/8 (*9)
04 50 01 08	00 - 09	R-BUS 1/2 SOURCE	MASTER, MONITOR, AUX1/2,,,AUX7/8, DIR1/2,,,DIR7/8
04 50 01 09	00 - 09	R-BUS 3/4 SOURCE	MASTER, MONITOR, AUX1/2,,,AUX7/8, DIR1/2,,,DIR7/8
04 50 01 0A	00 - 09	R-BUS 5/6 SOURCE	MASTER, MONITOR, AUX1/2,,,AUX7/8, DIR1/2,,,DIR7/8
04 50 01 0B	00 - 09	R-BUS 7/8 SOURCE	MASTER, MONITOR, AUX1/2,,,AUX7/8, DIR1/2,,,DIR7/8
04 50 01 0C	00	(Reserved)	
04 50 01 0F	00	(Reserved)	
04 50 01 10	00 - 09	DIGITAL L/R SOURCE	MASTER, MONITOR, AUX1/2,,,AUX7/8, DIR1/2,,,DIR7/8
04 50 01 11	00	(Reserved)	
04 50 01 12	00 - 01	TRACK DIRECT OUT	Off,On
04 50 01 13	00 - 01	TRACK DIRECT SOURCE	PreFader, PostFader
04 50 01 14	00	(Reserved)	
04 50 01 15	00	(Reserved)	
04 50 01 16	00 - 0C	TRACK DIRECT OUT	(*12)
		A.MULTI 1/2 SOURCE	TR1/2,,,TR23/24, MONITOR
04 50 01 17	00 - 0C	TRACK DIRECT OUT	(*12)
		A.MULTI 3/4 SOURCE	TR1/2,,,TR23/24, MONITOR
04 50 01 18	00 - 0C	TRACK DIRECT OUT	(*12)
		A.MULTI 5/6 SOURCE	TR1/2,,,TR23/24, MONITOR
04 50 01 19	00 - 0C	TRACK DIRECT OUT	(*12)
		A.MULTI 7/8 SOURCE	TR1/2,,,TR23/24, MONITOR
04 50 01 1A	00 - 0C	TRACK DIRECT OUT	(*12)
		R-BUS 1/2 SOURCE	TR1/2,,,TR23/24, MONITOR
04 50 01 1B	00 - 0C	TRACK DIRECT OUT	(*12)
		R-BUS 3/4 SOURCE	TR1/2,,,TR23/24, MONITOR
04 50 01 1C	00 - 0C	TRACK DIRECT OUT	(*12)
		R-BUS 5/6 SOURCE	TR1/2,,,TR23/24, MONITOR
04 50 01 1D	00 - 0C	TRACK DIRECT OUT	(*12)
		R-BUS 7/8 SOURCE	TR1/2,,,TR23/24, MONITOR
04 50 01 1E	00	(Reserved)	
04 50 01 21	00	(Reserved)	
04 50 01 22	00 - 0C	TRACK DIRECT OUT	(*12)
		DIGITAL L/R SOURCE	TR1/2,,,TR23/24, MONITOR
04 50 01 23	00	(Reserved)	
04 50 01 24	0aaaaaaa	REC BUS MIX ATT	-42.0,,,+0.0dB(-420,,,0)
04 50 01 25#	0bbbbbbb		

(* Addresses with a "#" are ignored, even when sent as the Start Address.

Transmit the Data Set (DT1) or Data Request (RQ1) message with the specified size to the address without "#" mark.

(*1) Dynamics Ratio Table

Data	RATIO
0	1.00:1
1	1.12:1
2	1.25:1
3	1.40:1
4	1.60:1
5	1.80:1
6	2.00:1
7	2.50:1
8	3.20:1
9	4.00:1
10	5.60:1
11	8.00:1
12	16.0:1
13	Inf:1

(*2) Dynamics Attack/Release time Table

Data	Atk (ms)	Rel (ms)	Data	Atk (ms)	Rel (ms)	Data	Atk (ms)	Rel (ms)
0	0.0	0	42	7.1	71	84	80.0	800
1	0.1	1	43	7.5	75	85	84.0	840
2	0.2	2	44	8.0	80	86	90.0	900
3	0.3	3	45	8.4	84	87	94.4	944
4	0.4	4	46	9.0	90	88	100.0	1000
5	0.5	5	47	9.4	94	89	106.0	1060
6	0.6	6	48	10.0	100	90	112.0	1120
7	0.7	7	49	10.6	106	91	120.0	1200
8	0.8	8	50	11.2	112	92	125.0	1250
9	0.9	9	51	12.0	120	93	133.0	1330
10	1.0	10	52	12.5	125	94	140.0	1400
11	1.1	11	53	13.3	133	95	150.0	1500
12	1.2	12	54	14.0	140	96	160.0	1600
13	1.3	13	55	15.0	150	97	170.0	1700
14	1.4	14	56	16.0	160	98	180.0	1800
15	1.5	15	57	17.0	170	99	190.0	1900
16	1.6	16	58	18.0	180	100	200.0	2000
17	1.7	17	59	19.0	190	101	210.0	2100
18	1.8	18	60	20.0	200	102	224.0	2240
19	1.9	19	61	21.0	210	103	237.0	2370
20	2.0	20	62	22.4	224	104	250.0	2500
21	2.1	21	63	23.7	237	105	266.0	2660
22	2.2	22	64	25.0	250	106	280.0	2800
23	2.4	24	65	26.6	266	107	300.0	3000
24	2.5	25	66	28.0	280	108	315.0	3150
25	2.7	27	67	30.0	300	109	335.0	3350
26	2.8	28	68	31.5	315	110	355.0	3550
27	3.0	30	69	33.5	335	111	376.0	3760
28	3.2	32	70	35.5	355	112	400.0	4000
29	3.3	33	71	37.6	376	113	422.0	4220
30	3.6	36	72	40.0	400	114	450.0	4500
31	3.8	38	73	42.2	422	115	473.0	4730
32	4.0	40	74	45.0	450	116	500.0	5000
33	4.2	42	75	47.3	473	117	530.0	5300
34	4.5	45	76	50.0	500	118	560.0	5600
35	4.7	47	77	53.0	530	119	600.0	6000
36	5.0	50	78	56.0	560	120	630.0	6300
37	5.3	53	79	60.0	600	121	670.0	6700
38	5.6	56	80	63.0	630	122	710.0	7100
39	6.0	60	81	67.0	670	123	750.0	7500
40	6.3	63	82	71.0	710	124	800.0	8000
41	6.7	67	83	75.0	750			

(*3)See Mixer Frequency Table of NRPN and Mixer Parameter.

(*4)See Mixer Q Table of NRPN and Mixer Parameter.

(*5)This is read-only. Settings can only be made from the panel.

(*6)This is disabled when SURROUND MIX SWITCH is set to "Off."

(*7)This is enabled when SURROUND MIX SWITCH is set to "On" and SURROUND MIX MODE is set to "2+2."

(*8)This is enabled when SURROUND MIX SWITCH is set to "On" and SURROUND MIX MODE is set to "3+1."

(*9)This is enabled when SURROUND MIX SWITCH is set to "On" and SURROUND MIX MODE is set to "3+2+1."

(*10)This is enabled when SURROUND MIX SWITCH is set to "Off."

(*12)This is enabled when TRACK DIRECT OUT is set to "On."

●Effect Parameter

○Basic Address

Start address	Contents and remarks
05 00 00 00	0aaaaaaa EFFECTOR - 1 Algorithm
05 00 00 01#	0bbbbbbb aaaaaabbbbb = (0:Reverb *1) 1:Delay 2:Stereo Delay Chorus 3:Stereo Pitch Shifter Delay 4:Vocoder 5:2ch RSS 6:Delay RSS 7:Chorus RSS 8:Guitar Multi 1 9:Guitar Multi 2 10:Guitar Multi 3 11:Vocal Multi 12:Rotary 13:Guitar Amp Modeling 14:Stereo Phaser 15:Stereo Flanger 16: Dual Comp/Limiter (17:Gate Reverb *1) 18:Multi Tap Delay 19:Stereo Multi 20:Reverb 2 21:Space Chorus 22:Lo-Fi Processor 23:4Band Parametric Equalizer 24:10Band Graphic Equalizer 25:Hum Canceler 26:Vocal Canceler (27:Voice Transformer *1,*2) (28:Vocoder 2 *1,*2) 29: Mic Modeling 30:3Band Isolator 31:Tape Echo 201 32:Analog Flanger 33:Analog Phaser 34:Speaker Modeling (35:Mastering Tool Kit *1,*2)
05 00 00 02	20 - 7F EFFECTOR - 1 Name -1 (ASCII)
:	:
05 00 00 0D	20 - 7F EFFECTOR - 1 Name -12
:	:
05 00 00 0E	00 - 7F EFFECTOR - 1 Parameter Area (See Below)
:	:
05 00 7F 7F	00 - 7F :
:	:
05 01 00 00	00 - EFFECTOR - 2 (similar to 05 00 00 00 - 05 00 7F 7F)
:	:
05 01 7F 7F	00 - :
:	:
05 02 00 00	00 - EFFECTOR - 3 (similar to 05 00 00 00 - 05 00 7F 7F)
:	:
05 02 7F 7F	00 - :
:	:
05 03 00 00	00 - EFFECTOR - 4 (similar to 05 00 00 00 - 05 00 7F 7F)
:	:
05 03 7F 7F	00 - :

(*1) Cannot select "0:Reverb," "17:Gate Reverb," "27:Voice Transformer," "28:Vocoder2," or "35:Mastering Tool Kit" on Effect 2, and 4.

(*2) If "27:Voice Transformer," "28:Vocoder2," or "35:Mastering Tool Kit" is selected at Effect 1 or 3, Effect 2, or 4 is invalid.

* A meaning of the parameter area changes correspond with the top of parameter of Effect Algorithm. See the following tables. The address shows at Effect 1.

* If select the different Algorithm type from current one, all parameters will be copied from the preset patch data which selected Algorithm.

○Algorithm 0 Reverb (FX1 or FX3)

05 00 00 0E	0aaaaaaa EQ SW	0,1 = Off,On
05 00 00 0F#	0bbbbbbb	
05 00 00 10	0aaaaaaa EQ: Low EQ Type	0,1 = Shelving, Peaking
05 00 00 11#	0bbbbbbb	
05 00 00 12	0aaaaaaa EQ: Low EQ Gain	-12,,,12dB
05 00 00 13#	0bbbbbbb	
05 00 00 14	0aaaaaaa EQ: Low EQ Frequency	2,,,200 = 20,,,2000Hz
05 00 00 15#	0bbbbbbb	
05 00 00 16	0aaaaaaa EQ: Low EQ Q	3,,,100 = 0.3,,,10.0
05 00 00 17#	0bbbbbbb	
05 00 00 18	0aaaaaaa EQ: Mid EQ Gain	-12,,,12dB
05 00 00 19#	0bbbbbbb	
05 00 00 1A	0aaaaaaa EQ: Mid EQ Frequency	20,,,800 = 200,,,8000Hz
05 00 00 1B#	0bbbbbbb	
05 00 00 1C	0aaaaaaa EQ: Mid EQ Q	3,,,100 = 0.3,,,10.0
05 00 00 1D#	0bbbbbbb	
05 00 00 1E	0aaaaaaa EQ: High EQ Type	0,1 = Shelving, Peaking
05 00 00 1F#	0bbbbbbb	

MIDI Implementation

05 00 00 20	0aaaaaaa	EQ: High EQ Gain	
05 00 00 21#	0bbbbbbb		-12,,12dB
05 00 00 22	0aaaaaaa	EQ: High EQ Frequency	
05 00 00 23#	0bbbbbbb		14,,200 = 1.4,,20.0kHz
05 00 00 24	0aaaaaaa	EQ: High EQ Q	
05 00 00 25#	0bbbbbbb		3,,100 = 0.3,,10.0
05 00 00 26	0aaaaaaa	EQ: Out Level	
05 00 00 27#	0bbbbbbb		0,,100
05 00 00 28	0aaaaaaa	Reverb: Room Size	
05 00 00 29#	0bbbbbbb		5,,40m
05 00 00 2A	0aaaaaaa	Reverb: Reverb Time	
05 00 00 2B#	0bbbbbbb		1,,320 = 0.1,,32.0s
05 00 00 2C	0aaaaaaa	Reverb: Pre Delay	
05 00 00 2D#	0bbbbbbb		0,,200 = 0,,200ms
05 00 00 2E	0aaaaaaa	Reverb: Diffusion	
05 00 00 2F#	0bbbbbbb		0,,100
05 00 00 30	0aaaaaaa	Reverb: Density	
05 00 00 31#	0bbbbbbb		0,,100
05 00 00 32	0aaaaaaa	Reverb: Early Reflection Level	
05 00 00 33#	0bbbbbbb		0,,100
05 00 00 34	0aaaaaaa	Reverb: LF Damp Frequency	
05 00 00 35#	0bbbbbbb		5,,400 = 50,,4000Hz
05 00 00 36	0aaaaaaa	Reverb: LF Damp Gain	
05 00 00 37#	0bbbbbbb		-36,,0dB
05 00 00 38	0aaaaaaa	Reverb: HF Damp Frequency	
05 00 00 39#	0bbbbbbb		10,,200 = 1.0,,20.0kHz
05 00 00 3A	0aaaaaaa	Reverb: HF Damp Gain	
05 00 00 3B#	0bbbbbbb		-36,,0dB
05 00 00 3C	0aaaaaaa	Reverb: HI Cut Frequency	
05 00 00 3D#	0bbbbbbb		2,,200 = 0.2,,20.0kHz
05 00 00 3E	0aaaaaaa	Reverb: Effect Level	
05 00 00 3F#	0bbbbbbb		-100,,100
05 00 00 40	0aaaaaaa	Reverb: Direct Level	
05 00 00 41#	0bbbbbbb		-100,,100
05 00 00 42	00	(Reserved)	
:	:	:	
05 00 7F 7F	00	(Reserved)	

Algorithm 1 Delay

05 00 00 0E	0aaaaaaa	Delay SW	
05 00 00 0F#	0bbbbbbb		0,1 = Off,On
05 00 00 10	0aaaaaaa	EQ SW	
05 00 00 11#	0bbbbbbb		0,1 = Off,On
05 00 00 12	0aaaaaaa	Delay: Delay Time	
05 00 00 13#	0bbbbbbb		0,,1200ms
05 00 00 14	0aaaaaaa	Delay: Shift	
05 00 00 15#	0bbbbbbb		-1200,,1200 = L1200,,R1200ms
05 00 00 16	0aaaaaaa	Delay: Lch Feedback Level	
05 00 00 17#	0bbbbbbb		-100,,100
05 00 00 18	0aaaaaaa	Delay: Rch Feedback Level	
05 00 00 19#	0bbbbbbb		-100,,100
05 00 00 1A	0aaaaaaa	Delay: Lch Level	
05 00 00 1B#	0bbbbbbb		-100,,100
05 00 00 1C	0aaaaaaa	Delay: Rch Level	
05 00 00 1D#	0bbbbbbb		-100,,100
05 00 00 1E	0aaaaaaa	Delay: LF Damp Frequency	
05 00 00 1F#	0bbbbbbb		5,,400 = 50,,4000Hz
05 00 00 20	0aaaaaaa	Delay: LF Damp Gain	
05 00 00 21#	0bbbbbbb		-36,,0dB
05 00 00 22	0aaaaaaa	Delay: HF Damp Frequency	
05 00 00 23#	0bbbbbbb		10,,200 = 1.0,,20.0kHz
05 00 00 24	0aaaaaaa	Delay: HF Damp Gain	
05 00 00 25#	0bbbbbbb		-36,,0dB
05 00 00 26	0aaaaaaa	Delay: Direct Level	
05 00 00 27#	0bbbbbbb		-100,,100
05 00 00 28	0aaaaaaa	EQ: Low EQ Type	
05 00 00 29#	0bbbbbbb		0,1 = Shelving, Peaking
05 00 00 2A	0aaaaaaa	EQ: Low EQ Gain	
05 00 00 2B#	0bbbbbbb		-12,,12dB
05 00 00 2C	0aaaaaaa	EQ: Low EQ Frequency	
05 00 00 2D#	0bbbbbbb		2,,200 = 20,,2000Hz
05 00 00 2E	0aaaaaaa	EQ: Low EQ Q	
05 00 00 2F#	0bbbbbbb		3,,100 = 0.3,,10.0
05 00 00 30	0aaaaaaa	EQ: Mid EQ Gain	
05 00 00 31#	0bbbbbbb		-12,,12dB
05 00 00 32	0aaaaaaa	EQ: Mid EQ Frequency	
05 00 00 33#	0bbbbbbb		20,,800 = 200,,8000Hz

05 00 00 34	0aaaaaaa	EQ: Mid EQ Q	
05 00 00 35#	0bbbbbbb		3,,100 = 0.3,,10.0
05 00 00 36	0aaaaaaa	EQ: High EQ Type	
05 00 00 37#	0bbbbbbb		0,1 = Shelving, Peaking
05 00 00 38	0aaaaaaa	EQ: High EQ Gain	
05 00 00 39#	0bbbbbbb		-12,,12dB
05 00 00 3A	0aaaaaaa	EQ: High EQ Frequency	
05 00 00 3B#	0bbbbbbb		14,,200 = 1.4,,20.0kHz
05 00 00 3C	0aaaaaaa	EQ: High EQ Q	
05 00 00 3D#	0bbbbbbb		3,,100 = 0.3,,10.0
05 00 00 3E	0aaaaaaa	EQ: Out Level	
05 00 00 3F#	0bbbbbbb		0,,100
05 00 00 40	00	(Reserved)	
:	:	:	
05 00 7F 7F	00	(Reserved)	

* (Delay Time) + (Absolute Shift) should be 1200 or less.

Algorithm 2 Stereo Delay Chorus

05 00 00 0E	0aaaaaaa	Delay SW	
05 00 00 0F#	0bbbbbbb		0,1 = Off,On
05 00 00 10	0aaaaaaa	Chorus SW	
05 00 00 11#	0bbbbbbb		0,1 = Off,On
05 00 00 12	0aaaaaaa	EQ SW	
05 00 00 13#	0bbbbbbb		0,1 = Off,On
05 00 00 14	0aaaaaaa	Delay: Delay Time	
05 00 00 15#	0bbbbbbb		0,,500ms
05 00 00 16	0aaaaaaa	Delay: Shift	
05 00 00 17#	0bbbbbbb		-500,,500 = L500,,R500ms
05 00 00 18	0aaaaaaa	Delay: Lch Feedback Level	
05 00 00 19#	0bbbbbbb		-100,,100
05 00 00 1A	0aaaaaaa	Delay: Rch Feedback Level	
05 00 00 1B#	0bbbbbbb		-100,,100
05 00 00 1C	0aaaaaaa	Delay: Lch Cross Feedback Level	
05 00 00 1D#	0bbbbbbb		-100,,100
05 00 00 1E	0aaaaaaa	Delay: Rch Cross Feedback Level	
05 00 00 1F#	0bbbbbbb		-100,,100
05 00 00 20	0aaaaaaa	Delay: Effect Level	
05 00 00 21#	0bbbbbbb		-100,,100
05 00 00 22	0aaaaaaa	Delay: Direct Level	
05 00 00 23#	0bbbbbbb		-100,,100
05 00 00 24	0aaaaaaa	Chorus: Rate	
05 00 00 25#	0bbbbbbb		1,,100 = 0.1,,10.0Hz
05 00 00 26	0aaaaaaa	Chorus: Depth	
05 00 00 27#	0bbbbbbb		0,,100
05 00 00 28	0aaaaaaa	Chorus: Pre Delay	
05 00 00 29#	0bbbbbbb		0,,50ms
05 00 00 2A	0aaaaaaa	Chorus: Effect Level	
05 00 00 2B#	0bbbbbbb		-100,,100
05 00 00 2C	0aaaaaaa	Chorus: Direct Level	
05 00 00 2D#	0bbbbbbb		-100,,100
05 00 00 2E	0aaaaaaa	Chorus: Lch Feedback Level	
05 00 00 2F#	0bbbbbbb		-100,,100
05 00 00 30	0aaaaaaa	Chorus: Rch Feedback Level	
05 00 00 31#	0bbbbbbb		-100,,100
05 00 00 32	0aaaaaaa	Chorus: Lch Cross Feedback LEVEL	
05 00 00 33#	0bbbbbbb		-100,,100
05 00 00 34	0aaaaaaa	Chorus: Rch Cross Feedback LEVEL	
05 00 00 35#	0bbbbbbb		-100,,100
05 00 00 36	0aaaaaaa	EQ: Low EQ Type	
05 00 00 37#	0bbbbbbb		0,1 = Shelving, Peaking
05 00 00 38	0aaaaaaa	EQ: Low EQ Gain	
05 00 00 39#	0bbbbbbb		-12,,12dB
05 00 00 3A	0aaaaaaa	EQ: Low EQ Frequency	
05 00 00 3B#	0bbbbbbb		2,,200 = 20,,2000Hz
05 00 00 3C	0aaaaaaa	EQ: Low EQ Q	
05 00 00 3D#	0bbbbbbb		3,,100 = 0.3,,10.0
05 00 00 3E	0aaaaaaa	EQ: Mid EQ Gain	
05 00 00 3F#	0bbbbbbb		-12,,12dB
05 00 00 40	0aaaaaaa	EQ: Mid EQ Frequency	
05 00 00 41#	0bbbbbbb		20,,800 = 200,,8000Hz
05 00 00 42	0aaaaaaa	EQ: Mid EQ Q	
05 00 00 43#	0bbbbbbb		3,,100 = 0.3,,10.0
05 00 00 44	0aaaaaaa	EQ: High EQ Type	
05 00 00 45#	0bbbbbbb		0,1 = Shelving, Peaking
05 00 00 46	0aaaaaaa	EQ: High EQ Gain	
05 00 00 47#	0bbbbbbb		-12,,12dB
05 00 00 48	0aaaaaaa	EQ: High EQ Frequency	
05 00 00 49#	0bbbbbbb		14,,200 = 1.4,,20.0kHz

05 00 00 4A	0aaaaaaaa	EQ: High EQ Q	
05 00 00 4B#	0bbbbbbb		3,,,100 = 0.3,,,10.0
05 00 00 4C	0aaaaaaaa	EQ: Out Level	
05 00 00 4D#	0bbbbbbb		0,,,100
05 00 00 4E	00	(Reserved)	
:	:	:	
05 00 7F 7F	00	(Reserved)	

* (Delay Time) + (Absolute Shift) should be 500 or less.

Algorithm 3 Stereo Pitch Shifter Delay

05 00 00 0E	0aaaaaaaa	P.ShifterDelay SW	
05 00 00 0F#	0bbbbbbb		0,1 = Off,On
05 00 00 10	0aaaaaaaa	EQ SW	
05 00 00 11#	0bbbbbbb		0,1 = Off,On
05 00 00 12	0aaaaaaaa	P.ShifterDelay: Lch Chromatic Pitch	
05 00 00 13#	0bbbbbbb		-12,,,12
05 00 00 14	0aaaaaaaa	P.ShifterDelay: Lch Fine Pitch	
05 00 00 15#	0bbbbbbb		-100,,,100
05 00 00 16	0aaaaaaaa	P.ShifterDelay: Lch Pre Delay	
05 00 00 17#	0bbbbbbb		0,,,50ms
05 00 00 18	0aaaaaaaa	P.ShifterDelay: Lch Feedback Delay Time	
05 00 00 19#	0bbbbbbb		0,,,500ms
05 00 00 1A	0aaaaaaaa	P.ShifterDelay: Lch Feedback Level	
05 00 00 1B#	0bbbbbbb		-100,,,100
05 00 00 1C	0aaaaaaaa	P.ShifterDelay: Lch Cross Feedback Level	
05 00 00 1D#	0bbbbbbb		-100,,,100
05 00 00 1E	0aaaaaaaa	P.ShifterDelay: Rch Chromatic Pitch	
05 00 00 1F#	0bbbbbbb		-12,,,12
05 00 00 20	0aaaaaaaa	P.ShifterDelay: Rch Fine Pitch	
05 00 00 21#	0bbbbbbb		-100,,,100
05 00 00 22	0aaaaaaaa	P.ShifterDelay: Rch Pre Delay	
05 00 00 23#	0bbbbbbb		0,,,50ms
05 00 00 24	0aaaaaaaa	P.ShifterDelay: Rch Feedback Delay Time	
05 00 00 25#	0bbbbbbb		0,,,500ms
05 00 00 26	0aaaaaaaa	P.ShifterDelay: Rch Feedback Level	
05 00 00 27#	0bbbbbbb		-100,,,100
05 00 00 28	0aaaaaaaa	P.ShifterDelay: Rch Cross Feedback Level	
05 00 00 29#	0bbbbbbb		-100,,,100
05 00 00 2A	0aaaaaaaa	P.ShifterDelay: Effect Level	
05 00 00 2B#	0bbbbbbb		-100,,,100
05 00 00 2C	0aaaaaaaa	P.ShifterDelay: Direct Level	
05 00 00 2D#	0bbbbbbb		-100,,,100
05 00 00 2E	0aaaaaaaa	EQ: Low EQ Type	
05 00 00 2F#	0bbbbbbb		0,1 = Shelving, Peaking
05 00 00 30	0aaaaaaaa	EQ: Low EQ Gain	
05 00 00 31#	0bbbbbbb		-12,,,12dB
05 00 00 32	0aaaaaaaa	EQ: Low EQ Frequency	
05 00 00 33#	0bbbbbbb		2,,,200 = 20,,,2000Hz
05 00 00 34	0aaaaaaaa	EQ: Low EQ Q	
05 00 00 35#	0bbbbbbb		3,,,100 = 0.3,,,10.0
05 00 00 36	0aaaaaaaa	EQ: Mid EQ Gain	
05 00 00 37#	0bbbbbbb		-12,,,12dB
05 00 00 38	0aaaaaaaa	EQ: Mid EQ Frequency	
05 00 00 39#	0bbbbbbb		20,,,800 = 200,,,8000Hz
05 00 00 3A	0aaaaaaaa	EQ: Mid EQ Q	
05 00 00 3B#	0bbbbbbb		3,,,100 = 0.3,,,10.0
05 00 00 3C	0aaaaaaaa	EQ: High EQ Type	
05 00 00 3D#	0bbbbbbb		0,1 = Shelving, Peaking
05 00 00 3E	0aaaaaaaa	EQ: High EQ Gain	
05 00 00 3F#	0bbbbbbb		-12,,,12dB
05 00 00 40	0aaaaaaaa	EQ: High EQ Frequency	
05 00 00 41#	0bbbbbbb		14,,,200 = 1.4,,,20.0kHz
05 00 00 42	0aaaaaaaa	EQ: High EQ Q	
05 00 00 43#	0bbbbbbb		3,,,100 = 0.3,,,10.0
05 00 00 44	0aaaaaaaa	EQ: Out Level	
05 00 00 45#	0bbbbbbb		0,,,100
05 00 00 46	00	(Reserved)	
:	:	:	
05 00 7F 7F	00	(Reserved)	

Algorithm 4 Vocoder

05 00 00 0E	0aaaaaaaa	Chorus SW	
05 00 00 0F#	0bbbbbbb		0,1 = Off,On
05 00 00 10	0aaaaaaaa	Vocoder: Voice Character 1	
05 00 00 11#	0bbbbbbb		0,,,100
05 00 00 12	0aaaaaaaa	Vocoder: Voice Character 2	
05 00 00 13#	0bbbbbbb		0,,,100

05 00 00 14	0aaaaaaaa	Vocoder: Voice Character 3	
05 00 00 15#	0bbbbbbb		0,,,100
05 00 00 16	0aaaaaaaa	Vocoder: Voice Character 4	
05 00 00 17#	0bbbbbbb		0,,,100
05 00 00 18	0aaaaaaaa	Vocoder: Voice Character 5	
05 00 00 19#	0bbbbbbb		0,,,100
05 00 00 1A	0aaaaaaaa	Vocoder: Voice Character 6	
05 00 00 1B#	0bbbbbbb		0,,,100
05 00 00 1C	0aaaaaaaa	Vocoder: Voice Character 7	
05 00 00 1D#	0bbbbbbb		0,,,100
05 00 00 1E	0aaaaaaaa	Vocoder: Voice Character 8	
05 00 00 1F#	0bbbbbbb		0,,,100
05 00 00 20	0aaaaaaaa	Vocoder: Voice Character 9	
05 00 00 21#	0bbbbbbb		0,,,100
05 00 00 22	0aaaaaaaa	Vocoder: Voice Character 10	
05 00 00 23#	0bbbbbbb		0,,,100
05 00 00 24	0aaaaaaaa	Chorus: Rate	
05 00 00 25#	0bbbbbbb		1,,,100 = 0.1,,,10.0Hz
05 00 00 26	0aaaaaaaa	Chorus: Depth	
05 00 00 27#	0bbbbbbb		0,,,100
05 00 00 28	0aaaaaaaa	Chorus: Pre Delay	
05 00 00 29#	0bbbbbbb		0,,,50ms
05 00 00 2A	0aaaaaaaa	Chorus: Feedback Level	
05 00 00 2B#	0bbbbbbb		-100,,,100
05 00 00 2C	0aaaaaaaa	Chorus: Effect Level	
05 00 00 2D#	0bbbbbbb		-100,,,100
05 00 00 2E	0aaaaaaaa	Chorus: Direct Level	
05 00 00 2F#	0bbbbbbb		-100,,,100
05 00 00 30	00	(Reserved)	
:	:	:	
05 00 7F 7F	00	(Reserved)	

Algorithm 5 2CH RSS

05 00 00 0E	0aaaaaaaa	2CH RSS: Ach Azimuth	
05 00 00 0F#	0bbbbbbb		-30,,,30 = -180,,,180
05 00 00 10	0aaaaaaaa	2CH RSS: Ach Elevation	
05 00 00 11#	0bbbbbbb		-15,,,15 = -90,,,90
05 00 00 12	0aaaaaaaa	2CH RSS: Bch Azimuth	
05 00 00 13#	0bbbbbbb		-30,,,30 = -180,,,180
05 00 00 14	0aaaaaaaa	2CH RSS: Bch Elevation	
05 00 00 15#	0bbbbbbb		-15,,,15 = -90,,,90
05 00 00 16	0aaaaaaaa	2CH RSS: Phones SW	
05 00 00 17#	0bbbbbbb		0,1 = Off,On
05 00 00 18	0aaaaaaaa	2CH RSS: RSS Type	
05 00 00 19#	0bbbbbbb		0,1 = Type A,Type B
05 00 00 1A	00	(Reserved)	
:	:	:	
05 00 7F 7F	00	(Reserved)	

Algorithm 6 Delay RSS

05 00 00 0E	0aaaaaaaa	Delay RSS: Delay Time	
05 00 00 0F#	0bbbbbbb		0,,,1200ms
05 00 00 10	0aaaaaaaa	Delay RSS: Shift	
05 00 00 11#	0bbbbbbb		-1200,,,1200 = L1200,,,R1200ms
05 00 00 12	0aaaaaaaa	Delay RSS: Center Delay Time	
05 00 00 13#	0bbbbbbb		0,,,1200ms
05 00 00 14	0aaaaaaaa	Delay RSS: RSS Level	
05 00 00 15#	0bbbbbbb		0,,,100
05 00 00 16	0aaaaaaaa	Delay RSS: Center Level	
05 00 00 17#	0bbbbbbb		0,,,100
05 00 00 18	0aaaaaaaa	Delay RSS: Feedback Level	
05 00 00 19#	0bbbbbbb		-100,,,100
05 00 00 1A	0aaaaaaaa	Delay RSS: LF Damp Frequency	
05 00 00 1B#	0bbbbbbb		5,,,400 = 50,,,4000Hz
05 00 00 1C	0aaaaaaaa	Delay RSS: LF Damp Gain	
05 00 00 1D#	0bbbbbbb		-36,,,0dB
05 00 00 1E	0aaaaaaaa	Delay RSS: HF Damp Frequency	
05 00 00 1F#	0bbbbbbb		10,,,200 = 1.0,,,20.0kHz
05 00 00 20	0aaaaaaaa	Delay RSS: HF Damp Gain	
05 00 00 21#	0bbbbbbb		-36,,,0dB
05 00 00 22	0aaaaaaaa	Delay RSS: Effect Level	
05 00 00 23#	0bbbbbbb		-100,,,100
05 00 00 24	0aaaaaaaa	Delay RSS: Direct Level	
05 00 00 25#	0bbbbbbb		-100,,,100
05 00 00 26	0aaaaaaaa	Delay RSS: Phones SW	
05 00 00 27#	0bbbbbbb		0,1 = Off,On

MIDI Implementation

05 00 00 26	00	(Reserved)
:	:	:
05 00 7F 7F	00	(Reserved)

* (Delay Time) + (Absolute Shift) should be 1200 or less.

Algorithm 7 Chorus RSS

05 00 00 0E	0aaaaaaa	Chorus RSS: Chorus Rate
05 00 00 0F#	0bbbbbbb	1,,100 = 0.1,,10.0Hz
05 00 00 10	0aaaaaaa	Chorus RSS: Chorus Depth
05 00 00 11#	0bbbbbbb	0,,100
05 00 00 12	0aaaaaaa	Chorus RSS: Effect Level
05 00 00 13#	0bbbbbbb	-100,,100
05 00 00 14	0aaaaaaa	Chorus RSS: Direct Level
05 00 00 15#	0bbbbbbb	-100,,100
05 00 00 16	0aaaaaaa	Chorus RSS: Phones SW
05 00 00 17#	0bbbbbbb	0,1 = Off,On
05 00 00 18	00	(Reserved)
:	:	:
05 00 7F 7F	00	(Reserved)

Common for Algorithm 8,9,10 Guitar Multi 1, 2, 3

05 00 00 0E	0aaaaaaa	Compressor SW
05 00 00 0F#	0bbbbbbb	0,1 = Off,On
05 00 00 10	0aaaaaaa	Metal/Distortion/Over Drive SW
05 00 00 11#	0bbbbbbb	0,1 = Off,On
05 00 00 12	0aaaaaaa	Noise Suppressor SW
05 00 00 13#	0bbbbbbb	0,1 = Off,On
05 00 00 14	0aaaaaaa	Auto Wah SW
05 00 00 15#	0bbbbbbb	0,1 = Off,On
05 00 00 16	0aaaaaaa	Guitar Amp Modeling SW
05 00 00 17#	0bbbbbbb	0,1 = Off,On
05 00 00 18	0aaaaaaa	Flanger SW
05 00 00 19#	0bbbbbbb	0,1 = Off,On
05 00 00 1A	0aaaaaaa	Delay SW
05 00 00 1B#	0bbbbbbb	0,1 = Off,On
05 00 00 1C	0aaaaaaa	Compressor: Attack
05 00 00 1D#	0bbbbbbb	0,,100
05 00 00 1E	0aaaaaaa	Compressor: Level
05 00 00 1F#	0bbbbbbb	0,,100
05 00 00 20	0aaaaaaa	Compressor: Sustain
05 00 00 21#	0bbbbbbb	0,,100
05 00 00 22	0aaaaaaa	Compressor: Tone
05 00 00 23#	0bbbbbbb	-50,,-50
05 00 00 24	0aaaaaaa	Noise Suppressor: Threshold
05 00 00 25#	0bbbbbbb	0,,100
05 00 00 26	0aaaaaaa	Noise Suppressor: Release
05 00 00 27#	0bbbbbbb	0,,100
05 00 00 28	0aaaaaaa	Auto Wah: Mode
05 00 00 29#	0bbbbbbb	0,1 = LPF,BPF
05 00 00 2A	0aaaaaaa	Auto Wah: Polarity
05 00 00 2B#	0bbbbbbb	0,1 = Down,Up
05 00 00 2C	0aaaaaaa	Auto Wah: Frequency
05 00 00 2D#	0bbbbbbb	0,,100
05 00 00 2E	0aaaaaaa	Auto Wah: Level
05 00 00 2F#	0bbbbbbb	0,,100
05 00 00 30	0aaaaaaa	Auto Wah: Peak
05 00 00 31#	0bbbbbbb	0,,100
05 00 00 32	0aaaaaaa	Auto Wah: Sens
05 00 00 33#	0bbbbbbb	0,,100
05 00 00 34	0aaaaaaa	Auto Wah: Rate
05 00 00 35#	0bbbbbbb	1,,100 = 0.1,,10.0Hz
05 00 00 36	0aaaaaaa	Auto Wah: Depth
05 00 00 37#	0bbbbbbb	0,,100
05 00 00 38	0aaaaaaa	Guitar Amp Modeling: Mode
05 00 00 39#	0bbbbbbb	0,,3 = Small,BultIn,2Stack,3Stack
05 00 00 3A	0aaaaaaa	Flanger: Rate
05 00 00 3B#	0bbbbbbb	1,,100 = 0.1,,10.0Hz
05 00 00 3C	0aaaaaaa	Flanger: Depth
05 00 00 3D#	0bbbbbbb	0,,100
05 00 00 3E	0aaaaaaa	Flanger: Manual
05 00 00 3F#	0bbbbbbb	0,,100
05 00 00 40	0aaaaaaa	Flanger: Resonance
05 00 00 41#	0bbbbbbb	0,,100
05 00 00 42	0aaaaaaa	Delay: Delay Time
05 00 00 43#	0bbbbbbb	0,,1000ms
05 00 00 44	0aaaaaaa	Delay: Shift
05 00 00 45#	0bbbbbbb	-1000,,1000 = L1000,,R1000ms

05 00 00 46	0aaaaaaa	Delay: Feedback Time
05 00 00 47#	0bbbbbbb	0,,1000ms
05 00 00 48	0aaaaaaa	Delay: Feedback Level
05 00 00 49#	0bbbbbbb	-100,,100
05 00 00 4A	0aaaaaaa	Delay: Effect Level
05 00 00 4B#	0bbbbbbb	-100,,100
05 00 00 4C	0aaaaaaa	Delay: Direct Level
05 00 00 4D#	0bbbbbbb	-100,,100

* (Delay Time) + (Absolute Shift) should be 1000 or less.

Individual Algorithm 8 Guitar Multi 1

05 00 00 4E	0aaaaaaa	Metal: Gain
05 00 00 4F#	0bbbbbbb	0,,100
05 00 00 50	0aaaaaaa	Metal: Level
05 00 00 51#	0bbbbbbb	0,,100
05 00 00 52	0aaaaaaa	Metal: Hi Gain
05 00 00 53#	0bbbbbbb	-100,,100
05 00 00 54	0aaaaaaa	Metal: Mid Gain
05 00 00 55#	0bbbbbbb	-100,,100
05 00 00 56	0aaaaaaa	Metal: Low Gain
05 00 00 57#	0bbbbbbb	-100,,100
05 00 00 58	00	(Reserved)
:	:	:
05 00 7F 7F	00	(Reserved)

Individual Algorithm 9 Guitar Multi 2

05 00 00 4E	0aaaaaaa	Distortion: Gain
05 00 00 4F#	0bbbbbbb	0,,100
05 00 00 50	0aaaaaaa	Distortion: Level
05 00 00 51#	0bbbbbbb	0,,100
05 00 00 52	0aaaaaaa	Distortion: Tone
05 00 00 53#	0bbbbbbb	0,,100
05 00 00 54	00	(Reserved)
:	:	:
05 00 7F 7F	00	(Reserved)

Individual Algorithm 10 Guitar Multi 3

05 00 00 4E	0aaaaaaa	Over Drive: Gain
05 00 00 4F#	0bbbbbbb	0,,100
05 00 00 50	0aaaaaaa	Over Drive: Level
05 00 00 51#	0bbbbbbb	0,,100
05 00 00 52	0aaaaaaa	Over Drive: Tone
05 00 00 53#	0bbbbbbb	0,,100
05 00 00 54	00	(Reserved)
:	:	:
05 00 7F 7F	00	(Reserved)

Algorithm 11 Vocal Multi

05 00 00 0E	0aaaaaaa	Noise Suppressor SW
05 00 00 0F#	0bbbbbbb	0,1 = Off,On
05 00 00 10	0aaaaaaa	Limitier/De-esser SW
05 00 00 11#	0bbbbbbb	0,1 = Off,On
05 00 00 12	0aaaaaaa	Enhancer SW
05 00 00 13#	0bbbbbbb	0,1 = Off,On
05 00 00 14	0aaaaaaa	EQ SW
05 00 00 15#	0bbbbbbb	0,1 = Off,On
05 00 00 16	0aaaaaaa	P.Shifter SW
05 00 00 17#	0bbbbbbb	0,1 = Off,On
05 00 00 18	0aaaaaaa	Delay SW
05 00 00 19#	0bbbbbbb	0,1 = Off,On
05 00 00 1A	0aaaaaaa	Chorus SW
05 00 00 1B#	0bbbbbbb	0,1 = Off,On
05 00 00 1C	0aaaaaaa	Limitier/De-esser Mode
05 00 00 1D#	0bbbbbbb	0,1 = Limitier,De-esser
05 00 00 1E	0aaaaaaa	Noise Suppressor: Threshold
05 00 00 1F#	0bbbbbbb	0,,100
05 00 00 20	0aaaaaaa	Noise Suppressor: Release
05 00 00 21#	0bbbbbbb	0,,100
05 00 00 22	0aaaaaaa	Limitier: Threshold
05 00 00 23#	0bbbbbbb	0,,100
05 00 00 24	0aaaaaaa	Limitier: Release
05 00 00 25#	0bbbbbbb	0,,100
05 00 00 26	0aaaaaaa	Limitier: Level
05 00 00 27#	0bbbbbbb	0,,100
05 00 00 28	0aaaaaaa	De-esser: Sens
05 00 00 29#	0bbbbbbb	0,,100

05 00 00 2A	0aaaaaaaa	De-esser: Frequency	
05 00 00 2B#	0bbbbbbb	10,,,100 = 1.0,,,10.0kHz	
05 00 00 2C	0aaaaaaaa	Enhancer: Sens	
05 00 00 2D#	0bbbbbbb	0,,,100	
05 00 00 2E	0aaaaaaaa	Enhancer: Frequency	
05 00 00 2F#	0bbbbbbb	10,,,100 = 1.0,,,10.0kHz	
05 00 00 30	0aaaaaaaa	Enhancer: MIX Level	
05 00 00 31#	0bbbbbbb	0,,,100	
05 00 00 32	0aaaaaaaa	Enhancer: Level	
05 00 00 33#	0bbbbbbb	0,,,100	
05 00 00 34	0aaaaaaaa	EQ: Low EQ Type	
05 00 00 35#	0bbbbbbb	0,1 = Shelving, Peaking	
05 00 00 36	0aaaaaaaa	EQ: Low EQ Gain	
05 00 00 37#	0bbbbbbb	-12,,,12dB	
05 00 00 38	0aaaaaaaa	EQ: Low EQ Frequency	
05 00 00 39#	0bbbbbbb	2,,,200 = 20,,,2000Hz	
05 00 00 3A	0aaaaaaaa	EQ: Low EQ Q	
05 00 00 3B#	0bbbbbbb	3,,,100 = 0.3,,,10.0	
05 00 00 3C	0aaaaaaaa	EQ: Mid EQ Gain	
05 00 00 3D#	0bbbbbbb	-12,,,12dB	
05 00 00 3E	0aaaaaaaa	EQ: Mid EQ Frequency	
05 00 00 3F#	0bbbbbbb	20,,,800 = 200,,,8000Hz	
05 00 00 40	0aaaaaaaa	EQ: Mid EQ Q	
05 00 00 41#	0bbbbbbb	3,,,100 = 0.3,,,10.0	
05 00 00 42	0aaaaaaaa	EQ: High EQ Type	
05 00 00 43#	0bbbbbbb	0,1 = Shelving, Peaking	
05 00 00 44	0aaaaaaaa	EQ: High EQ Gain	
05 00 00 45#	0bbbbbbb	-12,,,12dB	
05 00 00 46	0aaaaaaaa	EQ: High EQ Frequency	
05 00 00 47#	0bbbbbbb	14,,,200 = 1.4,,,20.0kHz	
05 00 00 48	0aaaaaaaa	EQ: High EQ Q	
05 00 00 49#	0bbbbbbb	3,,,100 = 0.3,,,10.0	
05 00 00 4A	0aaaaaaaa	EQ: Out Level	
05 00 00 4B#	0bbbbbbb	0,,,100	
05 00 00 4C	0aaaaaaaa	P.Shifter: Chromatic Pitch	
05 00 00 4D#	0bbbbbbb	-12,,,12	
05 00 00 4E	0aaaaaaaa	P.Shifter: Fine Pitch	
05 00 00 4F#	0bbbbbbb	-100,,,100	
05 00 00 50	0aaaaaaaa	P.Shifter: Effect Level	
05 00 00 51#	0bbbbbbb	-100,,,100	
05 00 00 52	0aaaaaaaa	P.Shifter: Direct Level	
05 00 00 53#	0bbbbbbb	-100,,,100	
05 00 00 54	0aaaaaaaa	Delay: Delay Time	
05 00 00 55#	0bbbbbbb	0,,,1000	
05 00 00 56	0aaaaaaaa	Delay: Feedback Level	
05 00 00 57#	0bbbbbbb	-100,,,100	
05 00 00 58	0aaaaaaaa	Delay: Effect Level	
05 00 00 59#	0bbbbbbb	-100,,,100	
05 00 00 5A	0aaaaaaaa	Delay: Direct Level	
05 00 00 5B#	0bbbbbbb	-100,,,100	
05 00 00 5C	0aaaaaaaa	Chorus: Rate	
05 00 00 5D#	0bbbbbbb	1,,,100 = 0.1,,,10.0Hz	
05 00 00 5E	0aaaaaaaa	Chorus: Depth	
05 00 00 5F#	0bbbbbbb	0,,,100	
05 00 00 60	0aaaaaaaa	Chorus: Pre Delay	
05 00 00 61#	0bbbbbbb	0,,,50ms	
05 00 00 62	0aaaaaaaa	Chorus: Effect Level	
05 00 00 63#	0bbbbbbb	-100,,,100	
05 00 00 64	0aaaaaaaa	Chorus: Direct Level	
05 00 00 65#	0bbbbbbb	-100,,,100	
05 00 00 66	00	(Reserved)	
:	:	:	
05 00 7F 7F	00	(Reserved)	

Algorithm 12 Rotary

05 00 00 0E	0aaaaaaaa	Noise Suppressor SW	
05 00 00 0F#	0bbbbbbb	0,1 = Off,On	
05 00 00 10	0aaaaaaaa	Over Drive SW	
05 00 00 11#	0bbbbbbb	0,1 = Off,On	
05 00 00 12	0aaaaaaaa	Noise Suppressor: Threshold	
05 00 00 13#	0bbbbbbb	0,,,100	
05 00 00 14	0aaaaaaaa	Noise Suppressor: Release	
05 00 00 15#	0bbbbbbb	0,,,100	
05 00 00 16	0aaaaaaaa	Over Drive: Gain	
05 00 00 17#	0bbbbbbb	0,,,100	
05 00 00 18	0aaaaaaaa	Over Drive: Level	
05 00 00 19#	0bbbbbbb	0,,,100	

05 00 00 1A	0aaaaaaaa	Rotary: Low Rate	
05 00 00 1B#	0bbbbbbb	1,,,100 = 0.1,,,10.0Hz	
05 00 00 1C	0aaaaaaaa	Rotary: Hi Rate	
05 00 00 1D#	0bbbbbbb	1,,,100 = 0.1,,,10.0Hz	
05 00 00 1E	00	(Reserved)	
:	:	:	
05 00 7F 7F	00	(Reserved)	

Algorithm 13 Guitar AMP Modeling

05 00 00 0E	0aaaaaaaa	Noise Suppressor SW	
05 00 00 0F#	0bbbbbbb	0,1 = Off,On	
05 00 00 10	0aaaaaaaa	Pre Amp SW	
05 00 00 11#	0bbbbbbb	0,1 = Off,On	
05 00 00 12	0aaaaaaaa	Speaker SW	
05 00 00 13#	0bbbbbbb	0,1 = Off,On	
05 00 00 14	0aaaaaaaa	Noise Suppressor: Threshold	
05 00 00 15#	0bbbbbbb	0,,,100	
05 00 00 16	0aaaaaaaa	Noise Suppressor: Release	
05 00 00 17#	0bbbbbbb	0,,,100	
05 00 00 18	0aaaaaaaa	Pre Amp: Mode	
05 00 00 19#	0bbbbbbb	0,,,13 = JC-120, Clean Twin, Match Drive, BG Lead, MS1959(I), MS1959(II), MS1959(I+II), SLDN Lead, Metal 5150, Metal Lead, OD-1, OD-2Turbo, Distortion, Fuzz	
05 00 00 1A	0aaaaaaaa	Pre Amp: Volume	
05 00 00 1B#	0bbbbbbb	0,,,100	
05 00 00 1C	0aaaaaaaa	Pre Amp: Bass	
05 00 00 1D#	0bbbbbbb	0,,,100	
05 00 00 1E	0aaaaaaaa	Pre Amp: Middle	
05 00 00 1F#	0bbbbbbb	0,,,100	
05 00 00 20	0aaaaaaaa	Pre Amp: Treble	
05 00 00 21#	0bbbbbbb	0,,,100	
05 00 00 22	0aaaaaaaa	Pre Amp: Presence	
05 00 00 23#	0bbbbbbb	0,,,100	
05 00 00 24	0aaaaaaaa	Pre Amp: Master	
05 00 00 25#	0bbbbbbb	0,,,100	
05 00 00 26	0aaaaaaaa	Pre Amp: Bright	
05 00 00 27#	0bbbbbbb	0,1 = Off,On	
05 00 00 28	0aaaaaaaa	Pre Amp: Gain	
05 00 00 29#	0bbbbbbb	0,1,2 = Low,Middle,High	
05 00 00 2A	0aaaaaaaa	Speaker: Type	
05 00 00 2B#	0bbbbbbb	0,,,11 = Small,Middle JC-120, Built In 1,Built In 2,Built In 3, Built In 4,BG Stack 1,BG Stack 2, MS Stack 1,MS Stack 2,Metal Stack	
05 00 00 2C	0aaaaaaaa	Speaker: MIC Setting	
05 00 00 2D#	0bbbbbbb	0,1,2 = 1,2,3	
05 00 00 2E	0aaaaaaaa	Speaker: MIC Level	
05 00 00 2F#	0bbbbbbb	0,,,100	
05 00 00 30	0aaaaaaaa	Speaker: Direct Level	
05 00 00 31#	0bbbbbbb	0,,,100	
05 00 00 32	00	(Reserved)	
:	:	:	
05 00 7F 7F	00	(Reserved)	

- * The Pre Amp Middle is invalid when Mode = Match Drive.
- * The Pre Amp Presence works counter to the Value (-100,,0) when Mode = Match Drive.
- * The Pre Amp Bright is valid when Mode = JC-120, Clean Twin, or BG Lead.

Algorithm 14 Stereo Phaser

05 00 00 0E	0aaaaaaaa	Phaser SW	
05 00 00 0F#	0bbbbbbb	0,1 = Off,On	
05 00 00 10	0aaaaaaaa	EQ SW	
05 00 00 11#	0bbbbbbb	0,1 = Off,On	
05 00 00 12	0aaaaaaaa	Phaser: Mode	
05 00 00 13#	0bbbbbbb	0,,,3 = 4,8,12,16stage	
05 00 00 14	0aaaaaaaa	Phaser: Rate	
05 00 00 15#	0bbbbbbb	1,,,100 = 0.1,,,10.0Hz	
05 00 00 16	0aaaaaaaa	Phaser: Depth	
05 00 00 17#	0bbbbbbb	0,,,100	
05 00 00 18	0aaaaaaaa	Phaser: Polarity	
05 00 00 19#	0bbbbbbb	0,1 = Inverse,Synchro	
05 00 00 1A	0aaaaaaaa	Phaser: Manual	
05 00 00 1B#	0bbbbbbb	0,,,100	
05 00 00 1C	0aaaaaaaa	Phaser: Resonance	
05 00 00 1D#	0bbbbbbb	0,,,100	
05 00 00 1E	0aaaaaaaa	Phaser: Cross Feedback	
05 00 00 1F#	0bbbbbbb	0,,,100	
05 00 00 20	0aaaaaaaa	Phaser: Effect Level	
05 00 00 21#	0bbbbbbb	-100,,,100	

MIDI Implementation

05 00 00 22	0aaaaaaa	Phaser: Direct Level	
05 00 00 23#	0bbbbbbb		-100,,100
05 00 00 24	0aaaaaaa	EQ: Low EQ Type	
05 00 00 25#	0bbbbbbb		0,1 = Shelving, Peaking
05 00 00 26	0aaaaaaa	EQ: Low EQ Gain	
05 00 00 27#	0bbbbbbb		-12,,12dB
05 00 00 28	0aaaaaaa	EQ: Low EQ Frequency	
05 00 00 29#	0bbbbbbb		2,,200 = 20,,2000Hz
05 00 00 2A	0aaaaaaa	EQ: Low EQ Q	
05 00 00 2B#	0bbbbbbb		3,,100 = 0.3,,10.0
05 00 00 2C	0aaaaaaa	EQ: Mid EQ Gain	
05 00 00 2D#	0bbbbbbb		-12,,12dB
05 00 00 2E	0aaaaaaa	EQ: Mid EQ Frequency	
05 00 00 2F#	0bbbbbbb		20,,800 = 200,,8000Hz
05 00 00 30	0aaaaaaa	EQ: Mid EQ Q	
05 00 00 31#	0bbbbbbb		3,,100 = 0.3,,10.0
05 00 00 32	0aaaaaaa	EQ: High EQ Type	
05 00 00 33#	0bbbbbbb		0,1 = Shelving, Peaking
05 00 00 34	0aaaaaaa	EQ: High EQ Gain	
05 00 00 35#	0bbbbbbb		-12,,12dB
05 00 00 36	0aaaaaaa	EQ: High EQ Frequency	
05 00 00 37#	0bbbbbbb		14,,200 = 1.4,,20.0kHz
05 00 00 38	0aaaaaaa	EQ: High EQ Q	
05 00 00 39#	0bbbbbbb		3,,100 = 0.3,,10.0
05 00 00 3A	0aaaaaaa	EQ: Out Level	
05 00 00 3B#	0bbbbbbb		0,,100
05 00 00 3C	00	(Reserved)	
:	:	:	
05 00 7F 7F	00	(Reserved)	

Algorithm 15 Stereo Flanger

05 00 00 0E	0aaaaaaa	Flanger SW	
05 00 00 0F#	0bbbbbbb		0,1 = Off,On
05 00 00 10	0aaaaaaa	EQ SW	
05 00 00 11#	0bbbbbbb		0,1 = Off,On
05 00 00 12	0aaaaaaa	Flanger: Rate	
05 00 00 13#	0bbbbbbb		1,,100 = 0.1,,10.0Hz
05 00 00 14	0aaaaaaa	Flanger: Depth	
05 00 00 15#	0bbbbbbb		0,,100
05 00 00 16	0aaaaaaa	Flanger: Polarity	
05 00 00 17#	0bbbbbbb		0,1 = Inverse,Synchro
05 00 00 18	0aaaaaaa	Flanger: Manual	
05 00 00 19#	0bbbbbbb		0,,100
05 00 00 1A	0aaaaaaa	Flanger: Resonance	
05 00 00 1B#	0bbbbbbb		0,,100
05 00 00 1C	0aaaaaaa	Flanger: Cross Feedback Level	
05 00 00 1D#	0bbbbbbb		0,,100
05 00 00 1E	0aaaaaaa	Flanger: Effect Level	
05 00 00 1F#	0bbbbbbb		-100,,100
05 00 00 20	0aaaaaaa	Flanger: Direct Level	
05 00 00 21#	0bbbbbbb		-100,,100
05 00 00 22	0aaaaaaa	EQ: Low EQ Type	
05 00 00 23#	0bbbbbbb		0,1 = Shelving, Peaking
05 00 00 24	0aaaaaaa	EQ: Low EQ Gain	
05 00 00 25#	0bbbbbbb		-12,,12dB
05 00 00 26	0aaaaaaa	EQ: Low EQ Frequency	
05 00 00 27#	0bbbbbbb		2,,200 = 20,,2000Hz
05 00 00 28	0aaaaaaa	EQ: Low EQ Q	
05 00 00 29#	0bbbbbbb		3,,100 = 0.3,,10.0
05 00 00 2A	0aaaaaaa	EQ: Mid EQ Gain	
05 00 00 2B#	0bbbbbbb		-12,,12dB
05 00 00 2C	0aaaaaaa	EQ: Mid EQ Frequency	
05 00 00 2D#	0bbbbbbb		20,,800 = 200,,8000Hz
05 00 00 2E	0aaaaaaa	EQ: Mid EQ Q	
05 00 00 2F#	0bbbbbbb		3,,100 = 0.3,,10.0
05 00 00 30	0aaaaaaa	EQ: High EQ Type	
05 00 00 31#	0bbbbbbb		0,1 = Shelving, Peaking
05 00 00 32	0aaaaaaa	EQ: High EQ Gain	
05 00 00 33#	0bbbbbbb		-12,,12dB
05 00 00 34	0aaaaaaa	EQ: High EQ Frequency	
05 00 00 35#	0bbbbbbb		14,,200 = 1.4,,20.0kHz
05 00 00 36	0aaaaaaa	EQ: High EQ Q	
05 00 00 37#	0bbbbbbb		3,,100 = 0.3,,10.0
05 00 00 38	0aaaaaaa	EQ: Out Level	
05 00 00 39#	0bbbbbbb		0,,100
05 00 00 3A	00	(Reserved)	
:	:	:	
05 00 7F 7F	00	(Reserved)	

Algorithm 16 Dual Compressor/Limiter

05 00 00 0E	0aaaaaaa	Comp/Limit A SW	
05 00 00 0F#	0bbbbbbb		0,1 = Off,On
05 00 00 10	0aaaaaaa	Noise Suppressor A SW	
05 00 00 11#	0bbbbbbb		0,1 = Off,On
05 00 00 12	0aaaaaaa	Comp/Limit B SW	
05 00 00 13#	0bbbbbbb		0,1 = Off,On
05 00 00 14	0aaaaaaa	Noise Suppressor B SW	
05 00 00 15#	0bbbbbbb		0,1 = Off,On
05 00 00 16	0aaaaaaa	Comp/Limit A: Detect	
05 00 00 17#	0bbbbbbb		0,1,2 = A,B,Link
05 00 00 18	0aaaaaaa	Comp/Limit A: Level	
05 00 00 19#	0bbbbbbb		-60,,12dB
05 00 00 1A	0aaaaaaa	Comp/Limit A: Thresh	
05 00 00 1B#	0bbbbbbb		-60,,0dB
05 00 00 1C	0aaaaaaa	Comp/Limit A: Attack	
05 00 00 1D#	0bbbbbbb		0,,100
05 00 00 1E	0aaaaaaa	Comp/Limit A: Release	
05 00 00 1F#	0bbbbbbb		0,,100
05 00 00 20	0aaaaaaa	Comp/Limit A: Ratio	
05 00 00 21#	0bbbbbbb		0,,3 = 1.5:1,2:1,4:1,100:1
05 00 00 22	0aaaaaaa	Noise Suppressor A: Detect	
05 00 00 23#	0bbbbbbb		0,1,2 = A,B,Link
05 00 00 24	0aaaaaaa	Noise Suppressor A: Threshold	
05 00 00 25#	0bbbbbbb		0,,100
05 00 00 26	0aaaaaaa	Noise Suppressor A: Release	
05 00 00 27#	0bbbbbbb		0,,100
05 00 00 28	0aaaaaaa	Comp/Limit B: Detect	
05 00 00 29#	0bbbbbbb		0,1,2 = A,B,Link
05 00 00 2A	0aaaaaaa	Comp/Limit B: Level	
05 00 00 2B#	0bbbbbbb		-60,,12dB
05 00 00 2C	0aaaaaaa	Comp/Limit B: Thresh	
05 00 00 2D#	0bbbbbbb		-60,,0dB
05 00 00 2E	0aaaaaaa	Comp/Limit B: Attack	
05 00 00 2F#	0bbbbbbb		0,,100
05 00 00 30	0aaaaaaa	Comp/Limit B: Release	
05 00 00 31#	0bbbbbbb		0,,100
05 00 00 32	0aaaaaaa	Comp/Limit B: Ratio	
05 00 00 33#	0bbbbbbb		0,,3 = 1.5:1,2:1,4:1,100:1
05 00 00 34	0aaaaaaa	Noise Suppressor B: Detect	
05 00 00 35#	0bbbbbbb		0,1,2 = A,B,Link
05 00 00 36	0aaaaaaa	Noise Suppressor B: Threshold	
05 00 00 37#	0bbbbbbb		0,,100
05 00 00 38	0aaaaaaa	Noise Suppressor B: Release	
05 00 00 39#	0bbbbbbb		0,,100
05 00 00 3A	00	(Reserved)	
:	:	:	
05 00 7F 7F	00	(Reserved)	

Algorithm 17 Gate Reverb (FX1 or FX3)

05 00 00 0E	0aaaaaaa	G.Reverb SW	
05 00 00 0F#	0bbbbbbb		0,1 = Off,On
05 00 00 10	0aaaaaaa	EQ SW	
05 00 00 11#	0bbbbbbb		0,1 = Off,On
05 00 00 12	0aaaaaaa	G.Reverb: Gate Time	
05 00 00 13#	0bbbbbbb		10,,400ms
05 00 00 14	0aaaaaaa	G.Reverb: Pre Delay	
05 00 00 15#	0bbbbbbb		0,,300ms
05 00 00 16	0aaaaaaa	G.Reverb: Effect Level	
05 00 00 17#	0bbbbbbb		-100,,100
05 00 00 18	0aaaaaaa	G.Reverb: Mode	
05 00 00 19#	0bbbbbbb		0,,4 = Normal,L->R,R->L,Reverse1,Reverse2
05 00 00 1A	0aaaaaaa	G.Reverb: Thickness	
05 00 00 1B#	0bbbbbbb		0,,100
05 00 00 1C	0aaaaaaa	G.Reverb: Density	
05 00 00 1D#	0bbbbbbb		0,,100
05 00 00 1E	0aaaaaaa	G.Reverb: Accent Delay	
05 00 00 1F#	0bbbbbbb		0,,200ms
05 00 00 20	0aaaaaaa	G.Reverb: Accent Level	
05 00 00 21#	0bbbbbbb		0,,100
05 00 00 22	0aaaaaaa	G.Reverb: Accent Pan	
05 00 00 23#	0bbbbbbb		1,,127 = L63,,R63
05 00 00 24	0aaaaaaa	G.Reverb: Direct Level	
05 00 00 25#	0bbbbbbb		-100,,100
05 00 00 26	0aaaaaaa	EQ: Low EQ Type	
05 00 00 27#	0bbbbbbb		0,1 = Shelving, Peaking

05 00 00 28	0aaaaaaaa	EQ: Low EQ Gain	-12,,,12dB
05 00 00 29#	0bbbbbbb		
05 00 00 2A	0aaaaaaaa	EQ: Low EQ Frequency	2,,,200 = 20,,,2000Hz
05 00 00 2B#	0bbbbbbb		
05 00 00 2C	0aaaaaaaa	EQ: Low EQ Q	3,,,100 = 0.3,,,10.0
05 00 00 2D#	0bbbbbbb		
05 00 00 2E	0aaaaaaaa	EQ: Mid EQ Gain	-12,,,12dB
05 00 00 2F#	0bbbbbbb		
05 00 00 30	0aaaaaaaa	EQ: Mid EQ Frequency	20,,,800 = 200,,,8000Hz
05 00 00 31#	0bbbbbbb		
05 00 00 32	0aaaaaaaa	EQ: Mid EQ Q	3,,,100 = 0.3,,,10.0
05 00 00 33#	0bbbbbbb		
05 00 00 34	0aaaaaaaa	EQ: High EQ Type	0,1 = Shelving, Peaking
05 00 00 35#	0bbbbbbb		
05 00 00 36	0aaaaaaaa	EQ: High EQ Gain	-12,,,12dB
05 00 00 37#	0bbbbbbb		
05 00 00 38	0aaaaaaaa	EQ: High EQ Frequency	14,,,200 = 1.4,,,20.0kHz
05 00 00 39#	0bbbbbbb		
05 00 00 3A	0aaaaaaaa	EQ: High EQ Q	3,,,100 = 0.3,,,10.0
05 00 00 3B#	0bbbbbbb		
05 00 00 3C	0aaaaaaaa	EQ: Out Level	0,,,100
05 00 00 3D#	0bbbbbbb		
05 00 00 3E	00	(Reserved)	
:	:	:	
05 00 7F 7F	00	(Reserved)	

Algorithm 18 Multi Tap Delay

05 00 00 0E	0aaaaaaaa	EQ SW	0,1 = Off,On
05 00 00 0F#	0bbbbbbb		
05 00 00 10	0aaaaaaaa	M.Tap Delay: Time 1	0,,,1200ms
05 00 00 11#	0bbbbbbb		
05 00 00 12	0aaaaaaaa	M.Tap Delay: Level 1	0,,,100
05 00 00 13#	0bbbbbbb		
05 00 00 14	0aaaaaaaa	M.Tap Delay: Pan 1	1,,,127 = L63,,,R63
05 00 00 15#	0bbbbbbb		
05 00 00 16	0aaaaaaaa	M.Tap Delay: Time 2	0,,,1200ms
05 00 00 17#	0bbbbbbb		
05 00 00 18	0aaaaaaaa	M.Tap Delay: Level 2	0,,,100
05 00 00 19#	0bbbbbbb		
05 00 00 1A	0aaaaaaaa	M.Tap Delay: Pan 2	1,,,127 = L63,,,R63
05 00 00 1B#	0bbbbbbb		
05 00 00 1C	0aaaaaaaa	M.Tap Delay: Time 3	0,,,1200ms
05 00 00 1D#	0bbbbbbb		
05 00 00 1E	0aaaaaaaa	M.Tap Delay: Level 3	0,,,100
05 00 00 1F#	0bbbbbbb		
05 00 00 20	0aaaaaaaa	M.Tap Delay: Pan 3	1,,,127 = L63,,,R63
05 00 00 21#	0bbbbbbb		
05 00 00 22	0aaaaaaaa	M.Tap Delay: Time 4	0,,,1200ms
05 00 00 23#	0bbbbbbb		
05 00 00 24	0aaaaaaaa	M.Tap Delay: Level 4	0,,,100
05 00 00 25#	0bbbbbbb		
05 00 00 26	0aaaaaaaa	M.Tap Delay: Pan 4	1,,,127 = L63,,,R63
05 00 00 27#	0bbbbbbb		
05 00 00 28	0aaaaaaaa	M.Tap Delay: Time 5	0,,,1200ms
05 00 00 29#	0bbbbbbb		
05 00 00 2A	0aaaaaaaa	M.Tap Delay: Level 5	0,,,100
05 00 00 2B#	0bbbbbbb		
05 00 00 2C	0aaaaaaaa	M.Tap Delay: Pan 5	1,,,127 = L63,,,R63
05 00 00 2D#	0bbbbbbb		
05 00 00 2E	0aaaaaaaa	M.Tap Delay: Time 6	0,,,1200ms
05 00 00 2F#	0bbbbbbb		
05 00 00 30	0aaaaaaaa	M.Tap Delay: Level 6	0,,,100
05 00 00 31#	0bbbbbbb		
05 00 00 32	0aaaaaaaa	M.Tap Delay: Pan 6	1,,,127 = L63,,,R63
05 00 00 33#	0bbbbbbb		
05 00 00 34	0aaaaaaaa	M.Tap Delay: Time 7	0,,,1200ms
05 00 00 35#	0bbbbbbb		
05 00 00 36	0aaaaaaaa	M.Tap Delay: Level 7	0,,,100
05 00 00 37#	0bbbbbbb		
05 00 00 38	0aaaaaaaa	M.Tap Delay: Pan 7	1,,,127 = L63,,,R63
05 00 00 39#	0bbbbbbb		
05 00 00 3A	0aaaaaaaa	M.Tap Delay: Time 8	0,,,1200ms
05 00 00 3B#	0bbbbbbb		
05 00 00 3C	0aaaaaaaa	M.Tap Delay: Level 8	0,,,100
05 00 00 3D#	0bbbbbbb		
05 00 00 3E	0aaaaaaaa	M.Tap Delay: Pan 8	1,,,127 = L63,,,R63
05 00 00 3F#	0bbbbbbb		

05 00 00 40	0aaaaaaaa	M.Tap Delay: Time 9	0,,,1200ms
05 00 00 41#	0bbbbbbb		
05 00 00 42	0aaaaaaaa	M.Tap Delay: Level 9	0,,,100
05 00 00 43#	0bbbbbbb		
05 00 00 44	0aaaaaaaa	M.Tap Delay: Pan 9	1,,,127 = L63,,,R63
05 00 00 45#	0bbbbbbb		
05 00 00 46	0aaaaaaaa	M.Tap Delay: Time 10	0,,,1200ms
05 00 00 47#	0bbbbbbb		
05 00 00 48	0aaaaaaaa	M.Tap Delay: Level 10	0,,,100
05 00 00 49#	0bbbbbbb		
05 00 00 4A	0aaaaaaaa	M.Tap Delay: Pan 10	1,,,127 = L63,,,R63
05 00 00 4B#	0bbbbbbb		
05 00 00 4C	0aaaaaaaa	M.Tap Delay: Feedback Delay Time	0,,,1200ms
05 00 00 4D#	0bbbbbbb		
05 00 00 4E	0aaaaaaaa	M.Tap Delay: Feedback Level	-100,,,100
05 00 00 4F#	0bbbbbbb		
05 00 00 50	0aaaaaaaa	M.Tap Delay: Effect Level	-100,,,100
05 00 00 51#	0bbbbbbb		
05 00 00 52	0aaaaaaaa	M.Tap Delay: Direct Level	-100,,,100
05 00 00 53#	0bbbbbbb		
05 00 00 54	0aaaaaaaa	EQ: Low EQ Type	0,1 = Shelving, Peaking
05 00 00 55#	0bbbbbbb		
05 00 00 56	0aaaaaaaa	EQ: Low EQ Gain	-12,,,12dB
05 00 00 57#	0bbbbbbb		
05 00 00 58	0aaaaaaaa	EQ: Low EQ Frequency	2,,,200 = 20,,,2000Hz
05 00 00 59#	0bbbbbbb		
05 00 00 5A	0aaaaaaaa	EQ: Low EQ Q	3,,,100 = 0.3,,,10.0
05 00 00 5B#	0bbbbbbb		
05 00 00 5C	0aaaaaaaa	EQ: Mid EQ Gain	-12,,,12dB
05 00 00 5D#	0bbbbbbb		
05 00 00 5E	0aaaaaaaa	EQ: Mid EQ Frequency	20,,,800 = 200,,,8000Hz
05 00 00 5F#	0bbbbbbb		
05 00 00 60	0aaaaaaaa	EQ: Mid EQ Q	3,,,100 = 0.3,,,10.0
05 00 00 61#	0bbbbbbb		
05 00 00 62	0aaaaaaaa	EQ: High EQ Type	0,1 = Shelving, Peaking
05 00 00 63#	0bbbbbbb		
05 00 00 64	0aaaaaaaa	EQ: High EQ Gain	-12,,,12dB
05 00 00 65#	0bbbbbbb		
05 00 00 66	0aaaaaaaa	EQ: High EQ Frequency	14,,,200 = 1.4,,,20.0kHz
05 00 00 67#	0bbbbbbb		
05 00 00 68	0aaaaaaaa	EQ: High EQ Q	3,,,100 = 0.3,,,10.0
05 00 00 69#	0bbbbbbb		
05 00 00 6A	0aaaaaaaa	EQ: Out Level	0,,,100
05 00 00 6B#	0bbbbbbb		
05 00 00 6C	00	(Reserved)	
:	:	:	
05 00 7F 7F	00	(Reserved)	

Algorithm 19 Stereo Multi

05 00 00 0E	0aaaaaaaa	Noise Suppressor SW	0,1 = Off,On
05 00 00 0F#	0bbbbbbb		
05 00 00 10	0aaaaaaaa	Comp/Limit SW	0,1 = Off,On
05 00 00 11#	0bbbbbbb		
05 00 00 12	0aaaaaaaa	Enhancer SW	0,1 = Off,On
05 00 00 13#	0bbbbbbb		
05 00 00 14	0aaaaaaaa	EQ SW	0,1 = Off,On
05 00 00 15#	0bbbbbbb		
05 00 00 16	0aaaaaaaa	Noise Suppressor: Threshold	0,,,100
05 00 00 17#	0bbbbbbb		
05 00 00 18	0aaaaaaaa	Noise Suppressor: Release	0,,,100
05 00 00 19#	0bbbbbbb		
05 00 00 1A	0aaaaaaaa	Comp/Limit: Level	-60,,,12dB
05 00 00 1B#	0bbbbbbb		
05 00 00 1C	0aaaaaaaa	Comp/Limit: Thresh	-60,,,0dB
05 00 00 1D#	0bbbbbbb		
05 00 00 1E	0aaaaaaaa	Comp/Limit: Attack	0,,,100
05 00 00 1F#	0bbbbbbb		
05 00 00 20	0aaaaaaaa	Comp/Limit: Release	0,,,100
05 00 00 21#	0bbbbbbb		
05 00 00 22	0aaaaaaaa	Comp/Limit: Ratio	0,,,3 = 1.5:1,2:1,4:1,100:1
05 00 00 23#	0bbbbbbb		
05 00 00 24	0aaaaaaaa	Enhancer: Sens	0,,,100
05 00 00 25#	0bbbbbbb		
05 00 00 26	0aaaaaaaa	Enhancer: Frequency	10,,,100 = 1.0,,,10.0kHz
05 00 00 27#	0bbbbbbb		
05 00 00 28	0aaaaaaaa	Enhancer: MIX Level	0,,,100
05 00 00 29#	0bbbbbbb		

MIDI Implementation

05 00 00 2A	0aaaaaaaa	Enhancer: Level	
05 00 00 2B#	0bbbbbbb		0,,,100
05 00 00 2C	0aaaaaaaa	EQ: Low EQ Type	0,1 = Shelving, Peaking
05 00 00 2B#	0bbbbbbb		
05 00 00 2E	0aaaaaaaa	EQ: Low EQ Gain	-12,,,12dB
05 00 00 2F#	0bbbbbbb		
05 00 00 30	0aaaaaaaa	EQ: Low EQ Frequency	2,,,200 = 20,,,2000Hz
05 00 00 31#	0bbbbbbb		
05 00 00 32	0aaaaaaaa	EQ: Low EQ Q	3,,,100 = 0.3,,,10.0
05 00 00 33#	0bbbbbbb		
05 00 00 34	0aaaaaaaa	EQ: Mid EQ Gain	-12,,,12dB
05 00 00 35#	0bbbbbbb		
05 00 00 36	0aaaaaaaa	EQ: Mid EQ Frequency	20,,,800 = 200,,,8000Hz
05 00 00 37#	0bbbbbbb		
05 00 00 38	0aaaaaaaa	EQ: Mid EQ Q	3,,,100 = 0.3,,,10.0
05 00 00 39#	0bbbbbbb		
05 00 00 3A	0aaaaaaaa	EQ: High EQ Type	0,1 = Shelving, Peaking
05 00 00 3B#	0bbbbbbb		
05 00 00 3C	0aaaaaaaa	EQ: High EQ Gain	-12,,,12dB
05 00 00 3D#	0bbbbbbb		
05 00 00 3E	0aaaaaaaa	EQ: High EQ Frequency	14,,,200 = 1.4,,,20.0kHz
05 00 00 3F#	0bbbbbbb		
05 00 00 40	0aaaaaaaa	EQ: High EQ Q	3,,,100 = 0.3,,,10.0
05 00 00 41#	0bbbbbbb		
05 00 00 42	0aaaaaaaa	EQ: Out Level	0,,,100
05 00 00 43#	0bbbbbbb		
05 00 00 44	00	(Reserved)	
:	:	:	
05 00 7F 7F	00	(Reserved)	

Algorithm 20 Reverb 2

05 00 00 0E	0aaaaaaaa	Reverb SW	0,1 = Off,On
05 00 00 0F#	0bbbbbbb		
05 00 00 10	0aaaaaaaa	EQ SW	0,1 = Off,On
05 00 00 11#	0bbbbbbb		
05 00 00 12	0aaaaaaaa	Reverb 2: Reverb Type	0,,,4 = Room1,Room2,Hall1,Hall2,Plate
05 00 00 13#	0bbbbbbb		
05 00 00 14	0aaaaaaaa	Reverb 2: Reverb Time	1,,,100 = 0.1,,,10.0sec
05 00 00 15#	0bbbbbbb		
05 00 00 16	0aaaaaaaa	Reverb 2: Pre Delay	0,,,200msec
05 00 00 17#	0bbbbbbb		
05 00 00 18	0aaaaaaaa	Reverb 2: Density	0,,,100
05 00 00 19#	0bbbbbbb		
05 00 00 1A	0aaaaaaaa	Reverb 2: High Pass Filter	1,,,200 = Thru,20,,,2000Hz
05 00 00 1B#	0bbbbbbb		
05 00 00 1C	0aaaaaaaa	Reverb 2: Low Pass Filter	10,,,201 = 1.0,,,20,0kHz,Thru
05 00 00 1D#	0bbbbbbb		
05 00 00 1E	0aaaaaaaa	Reverb 2: Effect Level	0,,,100
05 00 00 1F#	0bbbbbbb		
05 00 00 20	0aaaaaaaa	Reverb 2: Direct Level	0,,,100
05 00 00 21#	0bbbbbbb		
05 00 00 22	0aaaaaaaa	Reverb 2: Gate SW	0,1 = Off,On
05 00 00 23#	0bbbbbbb		
05 00 00 24	0aaaaaaaa	Reverb 2: Gate Mode	0,1 = Gate,Ducking
05 00 00 25#	0bbbbbbb		
05 00 00 26	0aaaaaaaa	Reverb 2: Gate Threshold	0,,,100
05 00 00 27#	0bbbbbbb		
05 00 00 28	0aaaaaaaa	Reverb 2: Gate Attack Time	1,,,100
05 00 00 29#	0bbbbbbb		
05 00 00 2A	0aaaaaaaa	Reverb 2: Gate Release Time	1,,,100
05 00 00 2B#	0bbbbbbb		
05 00 00 2C	0aaaaaaaa	Reverb 2: Gate Hold Time	1,,,100
05 00 00 2D#	0bbbbbbb		
05 00 00 2E	0aaaaaaaa	EQ: Low EQ Type	0,1 = Shelving, Peaking
05 00 00 2F#	0bbbbbbb		
05 00 00 30	0aaaaaaaa	EQ: Low EQ Gain	-12,,,12dB
05 00 00 31#	0bbbbbbb		
05 00 00 32	0aaaaaaaa	EQ: Low EQ Frequency	2,,,200 = 20,,,2000Hz
05 00 00 33#	0bbbbbbb		
05 00 00 34	0aaaaaaaa	EQ: Low EQ Q	3,,,100 = 0.3,,,10.0
05 00 00 35#	0bbbbbbb		
05 00 00 36	0aaaaaaaa	EQ: Mid EQ Gain	-12,,,12dB
05 00 00 37#	0bbbbbbb		
05 00 00 38	0aaaaaaaa	EQ: Mid EQ Frequency	20,,,800 = 200,,,8000Hz
05 00 00 39#	0bbbbbbb		
05 00 00 3A	0aaaaaaaa	EQ: Mid EQ Q	3,,,100 = 0.3,,,10.0
05 00 00 3B#	0bbbbbbb		

05 00 00 3C	0aaaaaaaa	EQ: High EQ Type	0,1 = Shelving, Peaking
05 00 00 3D#	0bbbbbbb		
05 00 00 3E	0aaaaaaaa	EQ: High EQ Gain	-12,,,12dB
05 00 00 3F#	0bbbbbbb		
05 00 00 40	0aaaaaaaa	EQ: High EQ Frequency	14,,,200 = 1.4,,,20.0kHz
05 00 00 41#	0bbbbbbb		
05 00 00 42	0aaaaaaaa	EQ: High EQ Q	3,,,100 = 0.3,,,10.0
05 00 00 43#	0bbbbbbb		
05 00 00 44	0aaaaaaaa	EQ: Out Level	0,,,100
05 00 00 45#	0bbbbbbb		
05 00 00 46	00	(Reserved)	
:	:	:	
05 00 7F 7F	00	(Reserved)	

Algorithm 21 Space Chorus

05 00 00 0E	0aaaaaaaa	Chorus SW	0,1 = Off,On
05 00 00 0F#	0bbbbbbb		
05 00 00 10	0aaaaaaaa	Chorus: Input Mode	0,1 = Mono,Stereo
05 00 00 11#	0bbbbbbb		
05 00 00 12	0aaaaaaaa	Chorus: Mode	0,,,6 = 1,2,3,4,1+4,2+4,3+4
05 00 00 13#	0bbbbbbb		
05 00 00 14	0aaaaaaaa	Chorus: Mix Balance	0,,,100
05 00 00 15#	0bbbbbbb		
05 00 00 16	00	(Reserved)	
:	:	:	
05 00 7F 7F	00	(Reserved)	

Algorithm 22 Lo-Fi Processor

05 00 00 0E	0aaaaaaaa	Lo-Fi Processor SW	0,1 = Off,On
05 00 00 0F#	0bbbbbbb		
05 00 00 10	0aaaaaaaa	Real time Modify Filter SW	0,1 = Off,On
05 00 00 11#	0bbbbbbb		
05 00 00 12	0aaaaaaaa	Lo-Fi Processor: Pre Filter SW	0,1 = Off,On
05 00 00 13#	0bbbbbbb		
05 00 00 14	0aaaaaaaa	Lo-Fi Processor: Rate	0,,,31 = Off,1/2,,,1/32
05 00 00 15#	0bbbbbbb		
05 00 00 16	0aaaaaaaa	Lo-Fi Processor: Number of Bit	0,,,15 = Off,15,,,1bit
05 00 00 17#	0bbbbbbb		
05 00 00 18	0aaaaaaaa	Lo-Fi Processor: Post Filter SW	0,1 = Off,On
05 00 00 19#	0bbbbbbb		
05 00 00 1A	0aaaaaaaa	Lo-Fi Processor: Effect Level	0,,,100
05 00 00 1B#	0bbbbbbb		
05 00 00 1C	0aaaaaaaa	Lo-Fi Processor: Direct Level	0,,,100
05 00 00 1D#	0bbbbbbb		
05 00 00 1E	0aaaaaaaa	Real time Modify Filter: Filter Type	0,,,2 = LPF,BPF,HPF
05 00 00 1F#	0bbbbbbb		
05 00 00 20	0aaaaaaaa	Real time Modify Filter: Cut Off	0,,,100
05 00 00 21#	0bbbbbbb		
05 00 00 22	0aaaaaaaa	Real time Modify Filter: Resonance	0,,,100
05 00 00 23#	0bbbbbbb		
05 00 00 24	0aaaaaaaa	Real time Modify Filter: Gain	0,,,24dB
05 00 00 25#	0bbbbbbb		
05 00 00 26	0aaaaaaaa	Noise Suppressor: Threshold	0,,,100
05 00 00 27#	0bbbbbbb		
05 00 00 28	0aaaaaaaa	Noise Suppressor: Release	0,,,100
05 00 00 29#	0bbbbbbb		
05 00 00 2A	00	(Reserved)	
:	:	:	
05 00 7F 7F	00	(Reserved)	

Algorithm 23 4 Band Parametric EQ

05 00 00 0E	0aaaaaaaa	Parametric EQ Link SW	0,1 = Off,On
05 00 00 0F#	0bbbbbbb		
05 00 00 10	0aaaaaaaa	Parametric EQ Ach SW	0,1 = Off,On
05 00 00 11#	0bbbbbbb		
05 00 00 12	0aaaaaaaa	Parametric EQ Bch SW	0,1 = Off,On
05 00 00 13#	0bbbbbbb		
05 00 00 14	0aaaaaaaa	EQ Ach: Input Gain	-60,,,12dB
05 00 00 15#	0bbbbbbb		
05 00 00 16	0aaaaaaaa	EQ Ach: Low EQ Type	0,1 = Shelving, Peaking
05 00 00 17#	0bbbbbbb		
05 00 00 18	0aaaaaaaa	EQ Ach: Low EQ Gain	-12,,,12dB
05 00 00 19#	0bbbbbbb		
05 00 00 1A	0aaaaaaaa	EQ Ach: Low EQ Frequency	2,,,200 = 20,,,2000Hz
05 00 00 1B#	0bbbbbbb		
05 00 00 1C	0aaaaaaaa	EQ Ach: Low EQ Q	3,,,100 = 0.3,,,10.0
05 00 00 1D#	0bbbbbbb		

05 00 00 1E	0aaaaaaaa	EQ Ach: Low Mid EQ Gain	-12,,,12dB
05 00 00 1F#	0bbbbbbbb		
05 00 00 20	0aaaaaaaa	EQ Ach: Low Mid EQ Frequency	20,,,800 = 200,,,8000Hz
05 00 00 21#	0bbbbbbbb		
05 00 00 22	0aaaaaaaa	EQ Ach: Low Mid EQ Q	3,,,100 = 0.3,,,10.0
05 00 00 23#	0bbbbbbbb		
05 00 00 24	0aaaaaaaa	EQ Ach: High Mid EQ Gain	-12,,,12dB
05 00 00 25#	0bbbbbbbb		
05 00 00 26	0aaaaaaaa	EQ Ach: High Mid EQ Frequency	20,,,800 = 200,,,8000Hz
05 00 00 27#	0bbbbbbbb		
05 00 00 28	0aaaaaaaa	EQ Ach: High Mid EQ Q	3,,,100 = 0.3,,,10.0
05 00 00 29#	0bbbbbbbb		
05 00 00 2A	0aaaaaaaa	EQ Ach: High EQ Type	0,1 = Shelving, Peaking
05 00 00 2B#	0bbbbbbbb		
05 00 00 2C	0aaaaaaaa	EQ Ach: High EQ Gain	-12,,,12dB
05 00 00 25#	0bbbbbbbb		
05 00 00 2E	0aaaaaaaa	EQ Ach: High EQ Frequency	14,,,200 = 1.4,,,20.0kHz
05 00 00 2F#	0bbbbbbbb		
05 00 00 30	0aaaaaaaa	EQ Ach: High EQ Q	3,,,100 = 0.3,,,10.0
05 00 00 31#	0bbbbbbbb		
05 00 00 32	0aaaaaaaa	EQ Ach: Output Level	-60,,,12dB
05 00 00 33#	0bbbbbbbb		
05 00 00 34	0aaaaaaaa	EQ Bch: Input Gain	-60,,,12dB
05 00 00 35#	0bbbbbbbb		
05 00 00 36	0aaaaaaaa	EQ Bch: Low EQ Type	0,1 = Shelving, Peaking
05 00 00 37#	0bbbbbbbb		
05 00 00 38	0aaaaaaaa	EQ Bch: Low EQ Gain	-12,,,12dB
05 00 00 39#	0bbbbbbbb		
05 00 00 3A	0aaaaaaaa	EQ Bch: Low EQ Frequency	2,,,200 = 20,,,2000Hz
05 00 00 3B#	0bbbbbbbb		
05 00 00 3C	0aaaaaaaa	EQ Bch: Low EQ Q	3,,,100 = 0.3,,,10.0
05 00 00 3D#	0bbbbbbbb		
05 00 00 3E	0aaaaaaaa	EQ Bch: Low Mid EQ Gain	-12,,,12dB
05 00 00 3F#	0bbbbbbbb		
05 00 00 40	0aaaaaaaa	EQ Bch: Low Mid EQ Frequency	20,,,800 = 200,,,8000Hz
05 00 00 41#	0bbbbbbbb		
05 00 00 42	0aaaaaaaa	EQ Bch: Low Mid EQ Q	3,,,100 = 0.3,,,10.0
05 00 00 43#	0bbbbbbbb		
05 00 00 44	0aaaaaaaa	EQ Bch: High Mid EQ Gain	-12,,,12dB
05 00 00 45#	0bbbbbbbb		
05 00 00 46	0aaaaaaaa	EQ Bch: High Mid EQ Frequency	20,,,800 = 200,,,8000Hz
05 00 00 47#	0bbbbbbbb		
05 00 00 48	0aaaaaaaa	EQ Bch: High Mid EQ Q	3,,,100 = 0.3,,,10.0
05 00 00 49#	0bbbbbbbb		
05 00 00 4A	0aaaaaaaa	EQ Bch: High EQ Type	0,1 = Shelving, Peaking
05 00 00 4B#	0bbbbbbbb		
05 00 00 4C	0aaaaaaaa	EQ Bch: High EQ Gain	-12,,,12dB
05 00 00 4D#	0bbbbbbbb		
05 00 00 4E	0aaaaaaaa	EQ Bch: High EQ Frequency	14,,,200 = 1.4,,,20.0kHz
05 00 00 4F#	0bbbbbbbb		
05 00 00 50	0aaaaaaaa	EQ Bch: High EQ Q	3,,,100 = 0.3,,,10.0
05 00 00 51#	0bbbbbbbb		
05 00 00 52	0aaaaaaaa	EQ Bch: Output Level	-60,,,12dB
05 00 00 53#	0bbbbbbbb		
05 00 00 54	00	(Reserved)	
:	:	:	
05 00 7F 7F	00	(Reserved)	

* When Link Sw = On, Bch corresponds to Ach.

○Algorithm 24 10 Band Graphic EQ

05 00 00 0E	0aaaaaaaa	Graphic EQ Link SW	0,1 = Off,On
05 00 00 0F#	0bbbbbbbb		
05 00 00 10	0aaaaaaaa	Graphic EQ Ach SW	0,1 = Off,On
05 00 00 11#	0bbbbbbbb		
05 00 00 12	0aaaaaaaa	Graphic EQ Bch SW	0,1 = Off,On
05 00 00 13#	0bbbbbbbb		
05 00 00 14	0aaaaaaaa	EQ Ach: Input Gain	-60,,,12dB
05 00 00 15#	0bbbbbbbb		
05 00 00 16	0aaaaaaaa	EQ Ach: 31.25Hz Gain	-12,,,12dB
05 00 00 17#	0bbbbbbbb		
05 00 00 18	0aaaaaaaa	EQ Ach: 62.5Hz Gain	-12,,,12dB
05 00 00 19#	0bbbbbbbb		
05 00 00 1A	0aaaaaaaa	EQ Ach: 125Hz Gain	-12,,,12dB
05 00 00 1B#	0bbbbbbbb		
05 00 00 1C	0aaaaaaaa	EQ Ach: 250Hz Gain	-12,,,12dB
05 00 00 1D#	0bbbbbbbb		
05 00 00 1E	0aaaaaaaa	EQ Ach: 500Hz Gain	-12,,,12dB
05 00 00 1F#	0bbbbbbbb		

05 00 00 20	0aaaaaaaa	EQ Ach: 1.0kHz Gain	-12,,,12dB
05 00 00 21#	0bbbbbbbb		
05 00 00 22	0aaaaaaaa	EQ Ach: 2.0kHz Gain	-12,,,12dB
05 00 00 23#	0bbbbbbbb		
05 00 00 24	0aaaaaaaa	EQ Ach: 4.0kHz Gain	-12,,,12dB
05 00 00 25#	0bbbbbbbb		
05 00 00 26	0aaaaaaaa	EQ Ach: 8.0kHz Gain	-12,,,12dB
05 00 00 27#	0bbbbbbbb		
05 00 00 28	0aaaaaaaa	EQ Ach: 16.0kHz Gain	-12,,,12dB
05 00 00 29#	0bbbbbbbb		
05 00 00 2A	0aaaaaaaa	EQ Ach: Output Level	-60,,,12dB
05 00 00 2B#	0bbbbbbbb		
05 00 00 2C	0aaaaaaaa	EQ Bch: Input Gain	-60,,,12dB
05 00 00 2D#	0bbbbbbbb		
05 00 00 2E	0aaaaaaaa	EQ Bch: 31.25Hz Gain	-12,,,12dB
05 00 00 2F#	0bbbbbbbb		
05 00 00 30	0aaaaaaaa	EQ Bch: 62.5Hz Gain	-12,,,12dB
05 00 00 31#	0bbbbbbbb		
05 00 00 32	0aaaaaaaa	EQ Bch: 125Hz Gain	-12,,,12dB
05 00 00 33#	0bbbbbbbb		
05 00 00 34	0aaaaaaaa	EQ Bch: 250Hz Gain	-12,,,12dB
05 00 00 35#	0bbbbbbbb		
05 00 00 36	0aaaaaaaa	EQ Bch: 500Hz Gain	-12,,,12dB
05 00 00 37#	0bbbbbbbb		
05 00 00 38	0aaaaaaaa	EQ Bch: 1.0kHz Gain	-12,,,12dB
05 00 00 39#	0bbbbbbbb		
05 00 00 3A	0aaaaaaaa	EQ Bch: 2.0kHz Gain	-12,,,12dB
05 00 00 3B#	0bbbbbbbb		
05 00 00 3C	0aaaaaaaa	EQ Bch: 4.0kHz Gain	-12,,,12dB
05 00 00 3D#	0bbbbbbbb		
05 00 00 3E	0aaaaaaaa	EQ Bch: 8.0kHz Gain	-12,,,12dB
05 00 00 3F#	0bbbbbbbb		
05 00 00 40	0aaaaaaaa	EQ Bch: 16.0kHz Gain	-12,,,12dB
05 00 00 41#	0bbbbbbbb		
05 00 00 42	0aaaaaaaa	EQ Bch: Output Level	-60,,,12dB
05 00 00 43#	0bbbbbbbb		
05 00 00 44	00	(Reserved)	
:	:	:	
05 00 7F 7F	00	(Reserved)	

* When Link Sw = On, Bch corresponds to Ach.

○Algorithm 25 Hum Canceled

05 00 00 0E	0aaaaaaaa	Hum Canceled SW	0,1 = Off,On
05 00 00 0F#	0bbbbbbbb		
05 00 00 10	0aaaaaaaa	Noise Suppressor SW	0,1 = Off,On
05 00 00 11#	0bbbbbbbb		
05 00 00 12	0aaaaaaaa	Hum Canceled: Freq	200,,,8000 = 20.0,,,800.0Hz
05 00 00 13#	0bbbbbbbb		
05 00 00 14	0aaaaaaaa	Hum Canceled: Width	10,,,40%
05 00 00 15#	0bbbbbbbb		
05 00 00 16	0aaaaaaaa	Hum Canceled: Depth	0,,,100
05 00 00 17#	0bbbbbbbb		
05 00 00 18	0aaaaaaaa	Hum Canceled: Threshold	0,,,100
05 00 00 19#	0bbbbbbbb		
05 00 00 1A	0aaaaaaaa	Hum Canceled: Range Low	1,,,200 = Unlimit,20,,,2000Hz
05 00 00 1B#	0bbbbbbbb		
05 00 00 1C	0aaaaaaaa	Hum Canceled: Range High	10,,,201 = 1.0,,,20.0kHz,Unlimit
05 00 00 1D#	0bbbbbbbb		
05 00 00 1E	0aaaaaaaa	Noise Suppressor: Threshold	0,,,100
05 00 00 1F#	0bbbbbbbb		
05 00 00 20	0aaaaaaaa	Noise Suppressor: Release	0,,,100
05 00 00 21#	0bbbbbbbb		
05 00 00 22	00	(Reserved)	
:	:	:	
05 00 7F 7F	00	(Reserved)	

○Algorithm 26 Vocal Canceled

05 00 00 0E	0aaaaaaaa	Vocal Canceled SW	0,1 = Off,On
05 00 00 0F#	0bbbbbbbb		
05 00 00 10	0aaaaaaaa	EQ SW	0,1 = Off,On
05 00 00 11#	0bbbbbbbb		
05 00 00 12	0aaaaaaaa	Vocal Canceled: Balance	0,,,100
05 00 00 13#	0bbbbbbbb		
05 00 00 14	0aaaaaaaa	Vocal Canceled: Range Low	1,,,200 = Unlimit,20,,,2000Hz
05 00 00 15#	0bbbbbbbb		
05 00 00 16	0aaaaaaaa	Vocal Canceled: Range High	10,,,201 = 1.0,,,20.0kHz,Unlimit
05 00 00 17#	0bbbbbbbb		

MIDI Implementation

05 00 00 18	0aaaaaaa	EQ: Low EQ Type	
05 00 00 19#	0bbbbbbb	0,1 = Shelving, Peaking	
05 00 00 1A	0aaaaaaa	EQ: Low EQ Gain	
05 00 00 1B#	0bbbbbbb	-12,,,12dB	
05 00 00 1C	0aaaaaaa	EQ: Low EQ Frequency	
05 00 00 1D#	0bbbbbbb	2,,,200 = 20,,,2000Hz	
05 00 00 1E	0aaaaaaa	EQ: Low EQ Q	
05 00 00 1F#	0bbbbbbb	3,,,100 = 0.3,,,10.0	
05 00 00 20	0aaaaaaa	EQ: Mid EQ Gain	
05 00 00 21#	0bbbbbbb	-12,,,12dB	
05 00 00 22	0aaaaaaa	EQ: Mid EQ Frequency	
05 00 00 23#	0bbbbbbb	20,,,800 = 200,,,8000Hz	
05 00 00 24	0aaaaaaa	EQ: Mid EQ Q	
05 00 00 25#	0bbbbbbb	3,,,100 = 0.3,,,10.0	
05 00 00 26	0aaaaaaa	EQ: High EQ Type	
05 00 00 27#	0bbbbbbb	0,1 = Shelving, Peaking	
05 00 00 28	0aaaaaaa	EQ: High EQ Gain	
05 00 00 29#	0bbbbbbb	-12,,,12dB	
05 00 00 2A	0aaaaaaa	EQ: High EQ Frequency	
05 00 00 2B#	0bbbbbbb	14,,,200 = 1.4,,,20.0kHz	
05 00 00 2C	0aaaaaaa	EQ: High EQ Q	
05 00 00 2D#	0bbbbbbb	3,,,100 = 0.3,,,10.0	
05 00 00 2E	0aaaaaaa	EQ: Out Level	
05 00 00 2F#	0bbbbbbb	0,,,100	
05 00 00 30	00	(Reserved)	
:	:	:	
05 00 7F 7F	00	(Reserved)	

Algorithm 27 Voice Transformer (FX1 or FX3)

05 00 00 0E	0aaaaaaa	Voice Transformer SW	
05 00 00 0F#	0bbbbbbb	0,1 = Off,On	
05 00 00 10	0aaaaaaa	Reverb SW	
05 00 00 11#	0bbbbbbb	0,1 = Off,On	
05 00 00 12	00	(Reserved)	
05 00 00 13	00	(Reserved)	
05 00 00 14	0aaaaaaa	MIDI Control SW	
05 00 00 15#	0bbbbbbb	0,1 = Off,On	
05 00 00 16	0aaaaaaa	Voice Transformer: Robot SW	
05 00 00 17#	0bbbbbbb	0,1 = Off,On	
05 00 00 18	0aaaaaaa	Voice Transformer: Chromatic Pitch	
05 00 00 19#	0bbbbbbb	-12,,,36	
05 00 00 1A	0aaaaaaa	Voice Transformer: Fine Pitch	
05 00 00 1B#	0bbbbbbb	-100,,,100	
05 00 00 1C	0aaaaaaa	Voice Transformer: Chromatic Formant	
05 00 00 1D#	0bbbbbbb	-12,,,12	
05 00 00 1E	0aaaaaaa	Voice Transformer: Fine Formant	
05 00 00 1F#	0bbbbbbb	-100,,,100	
05 00 00 20	0aaaaaaa	Voice Transformer: Mix Balance	
05 00 00 21#	0bbbbbbb	0,,,100	
05 00 00 22	0aaaaaaa	Reverb: Reverb Time	
05 00 00 23#	0bbbbbbb	1,,,100 = 0.1,,,10.0sec	
05 00 00 24	0aaaaaaa	Reverb: Pre Delay	
05 00 00 25#	0bbbbbbb	0,,,200msec	
05 00 00 26	0aaaaaaa	Reverb: Density	
05 00 00 27#	0bbbbbbb	0,,,100	
05 00 00 28	0aaaaaaa	Reverb: Effect Level	
05 00 00 29#	0bbbbbbb	0,,,100	
05 00 00 2A	0aaaaaaa	MIDI Control: Bend Range	
05 00 00 2B#	0bbbbbbb	0,,,12 = Off,1,,,12	
05 00 00 2C	0aaaaaaa	MIDI Control: Portamento	
05 00 00 2D#	0bbbbbbb	0...100 = Off,1,,,100	
05 00 00 2E	00	(Reserved)	
:	:	:	
05 00 7F 7F	00	(Reserved)	

Algorithm 28 Vocoder 2 (FX1 or FX3)

05 00 00 0E	0aaaaaaa	Chorus SW	
05 00 00 0F#	0bbbbbbb	0,1 = Off,On	
05 00 00 10	0aaaaaaa	Vocoder: Envelope Mode	
05 00 00 11#	0bbbbbbb	0,,,2 = Sharp,Soft,Long	
05 00 00 12	0aaaaaaa	Vocoder: Pan Mode	
05 00 00 13#	0bbbbbbb	0,,,3 = Mono,Stereo,L->R,R->L	
05 00 00 14	0aaaaaaa	Vocoder: Hold	
05 00 00 15#	0bbbbbbb	0,1 = Off,MIDI	
05 00 00 16	0aaaaaaa	Vocoder: Mic Sens	
05 00 00 17#	0bbbbbbb	0,,,100	

05 00 00 18	0aaaaaaa	Vocoder: Synth Input Level	
05 00 00 19#	0bbbbbbb	0,,,100	
05 00 00 1A	0aaaaaaa	Vocoder: Voice Char Level 1	
05 00 00 1B#	0bbbbbbb	0,,,100	
05 00 00 1C	0aaaaaaa	Vocoder: Voice Char Level 2	
05 00 00 1D#	0bbbbbbb	0,,,100	
05 00 00 1E	0aaaaaaa	Vocoder: Voice Char Level 3	
05 00 00 1F#	0bbbbbbb	0,,,100	
05 00 00 20	0aaaaaaa	Vocoder: Voice Char Level 4	
05 00 00 21#	0bbbbbbb	0,,,100	
05 00 00 22	0aaaaaaa	Vocoder: Voice Char Level 5	
05 00 00 23#	0bbbbbbb	0,,,100	
05 00 00 24	0aaaaaaa	Vocoder: Voice Char Level 6	
05 00 00 25#	0bbbbbbb	0,,,100	
05 00 00 26	0aaaaaaa	Vocoder: Voice Char Level 7	
05 00 00 27#	0bbbbbbb	0,,,100	
05 00 00 28	0aaaaaaa	Vocoder: Voice Char Level 8	
05 00 00 29#	0bbbbbbb	0,,,100	
05 00 00 2A	0aaaaaaa	Vocoder: Voice Char Level 9	
05 00 00 2B#	0bbbbbbb	0,,,100	
05 00 00 2C	0aaaaaaa	Vocoder: Voice Char Level 10	
05 00 00 2D#	0bbbbbbb	0,,,100	
05 00 00 2E	0aaaaaaa	Vocoder: Voice Char Level 11	
05 00 00 2F#	0bbbbbbb	0,,,100	
05 00 00 30	0aaaaaaa	Vocoder: Voice Char Level 12	
05 00 00 31#	0bbbbbbb	0,,,100	
05 00 00 32	0aaaaaaa	Vocoder: Voice Char Level 13	
05 00 00 33#	0bbbbbbb	0,,,100	
05 00 00 34	0aaaaaaa	Vocoder: Voice Char Level 14	
05 00 00 35#	0bbbbbbb	0,,,100	
05 00 00 36	0aaaaaaa	Vocoder: Voice Char Level 15	
05 00 00 37#	0bbbbbbb	0,,,100	
05 00 00 38	0aaaaaaa	Vocoder: Voice Char Level 16	
05 00 00 39#	0bbbbbbb	0,,,100	
05 00 00 3A	0aaaaaaa	Vocoder: Voice Char Level 17	
05 00 00 3B#	0bbbbbbb	0,,,100	
05 00 00 3C	0aaaaaaa	Vocoder: Voice Char Level 18	
05 00 00 3D#	0bbbbbbb	0,,,100	
05 00 00 3E	0aaaaaaa	Vocoder: Voice Char Level 19	
05 00 00 3F#	0bbbbbbb	0,,,100	
05 00 00 40	0aaaaaaa	Vocoder: Mic High Pass Filter	
05 00 00 41#	0bbbbbbb	9,,,200 = Thru,1.0,,,20.0kHz	
05 00 00 42	0aaaaaaa	Vocoder: Mic High Pass Filter Pan	
05 00 00 43#	0bbbbbbb	1,,,127 = L63,,,R63	
05 00 00 44	0aaaaaaa	Vocoder: Mic Mix	
05 00 00 45#	0bbbbbbb	0,,,100	
05 00 00 46	0aaaaaaa	Vocoder: Noise Suppressor Threshold	
05 00 00 47#	0bbbbbbb	0,,,100	
05 00 00 48	0aaaaaaa	Chorus: Rate	
05 00 00 49#	0bbbbbbb	1,,,100 = 0.1,,,10.0Hz	
05 00 00 4A	0aaaaaaa	Chorus: Depth	
05 00 00 4B#	0bbbbbbb	0,,,100	
05 00 00 4C	0aaaaaaa	Chorus: Pre Delay	
05 00 00 4D#	0bbbbbbb	0,,,50ms	
05 00 00 4E	0aaaaaaa	Chorus: Mix Balance	
05 00 00 4F#	0bbbbbbb	0,,,100	
05 00 00 50	00	(Reserved)	
:	:	:	
05 00 7F 7F	00	(Reserved)	

Algorithm 29 Mic Modeling

05 00 00 0E	0aaaaaaa	Link SW	
05 00 00 0F#	0bbbbbbb	0,1 = Off,On	
05 00 00 10	0aaaaaaa	Mic Converter Ach SW	
05 00 00 11#	0bbbbbbb	0,1 = Off,On	
05 00 00 12	0aaaaaaa	Bass Cut Ach SW	
05 00 00 13#	0bbbbbbb	0,1 = Off,On	
05 00 00 14	0aaaaaaa	Distance Ach SW	
05 00 00 15#	0bbbbbbb	0,1 = Off,On	
05 00 00 16	0aaaaaaa	Limitter Ach SW	
05 00 00 17#	0bbbbbbb	0,1 = Off,On	
05 00 00 18	0aaaaaaa	Mic Converter Bch SW	
05 00 00 19#	0bbbbbbb	0,1 = Off,On	
05 00 00 1A	0aaaaaaa	Bass Cut Bch SW	
05 00 00 1B#	0bbbbbbb	0,1 = Off,On	
05 00 00 1C	0aaaaaaa	Distance Bch SW	
05 00 00 1D#	0bbbbbbb	0,1 = Off,On	

05 00 00 1E 05 00 00 1F#	0aaaaaaaa 0bbbbbbbb	Limiter Bch SW 0,1 = Off,On
05 00 00 20 05 00 00 21#	0aaaaaaaa 0bbbbbbbb	Mic Converter Ach: Input 0,,5 = DR-20, SmlDy, HedDy, MinCn, Flat, C3000B
05 00 00 22 05 00 00 23#	0aaaaaaaa 0bbbbbbbb	Mic Converter Ach: Output 0,,6 = SmlDy, VocDy, LrgDy, SmlCn, LrgCn, VntCn, Flat
05 00 00 24 05 00 00 25#	0aaaaaaaa 0bbbbbbbb	Mic Converter Ach: Phase 0,1 = Normal, Inverse
05 00 00 26 05 00 00 27#	0aaaaaaaa 0bbbbbbbb	Bass Cut Ach: Bass Cut Frequency 1,,200 = Thru,20,,2000Hz
05 00 00 28 05 00 00 29#	0aaaaaaaa 0bbbbbbbb	Distance Ach: Proximity Effect -12,,,+12
05 00 00 2A 05 00 00 2B#	0aaaaaaaa 0bbbbbbbb	Distance Ach: Timelag 0,,1000 = 0,,3000cm
05 00 00 2C 05 00 00 2D#	0aaaaaaaa 0bbbbbbbb	Limiter Ach: Detect HPF Frequency 1,,200 = Thru,20,,2000Hz
05 00 00 2E 05 00 00 2F#	0aaaaaaaa 0bbbbbbbb	Limiter Ach: Level -60,,24dB
05 00 00 30 05 00 00 31#	0aaaaaaaa 0bbbbbbbb	Limiter Ach: Threshold -60,,0dB
05 00 00 32 05 00 00 33#	0aaaaaaaa 0bbbbbbbb	Limiter Ach: Attack 0,,100
05 00 00 34 05 00 00 35#	0aaaaaaaa 0bbbbbbbb	Limiter Ach: Release 0,,100
05 00 00 36 05 00 00 37#	0aaaaaaaa 0bbbbbbbb	Mic Converter Bch: Input 0,,5 = DR-20, SmlDy, HedDy, MinCn, Flat, C3000B
05 00 00 38 05 00 00 39#	0aaaaaaaa 0bbbbbbbb	Mic Converter Bch: Output 0,,6 = SmlDy, VocDy, LrgDy, SmlCn, LrgCn, VntCn, Flat
05 00 00 3A 05 00 00 3B#	0aaaaaaaa 0bbbbbbbb	Mic Converter Bch: Phase 0,1 = Normal, Inverse
05 00 00 3C 05 00 00 3D#	0aaaaaaaa 0bbbbbbbb	Bass Cut Bch: Bass Cut Frequency 1,,200 = Thru,20,,2000Hz
05 00 00 3E 05 00 00 3F#	0aaaaaaaa 0bbbbbbbb	Distance Bch: Proximity Effect -12,,,+12
05 00 00 40 05 00 00 41#	0aaaaaaaa 0bbbbbbbb	Distance Bch: Timelag 0,,1000 = 0,,3000cm
05 00 00 42 05 00 00 43#	0aaaaaaaa 0bbbbbbbb	Limiter Bch: Detect HPF Frequency 1,,200 = Thru,20,,2000Hz
05 00 00 44 05 00 00 45#	0aaaaaaaa 0bbbbbbbb	Limiter Bch: Level -60,,24dB
05 00 00 46 05 00 00 47#	0aaaaaaaa 0bbbbbbbb	Limiter Bch: Threshold -60,,0dB
05 00 00 48 05 00 00 49#	0aaaaaaaa 0bbbbbbbb	Limiter Bch: Attack 0,,100
05 00 00 4A 05 00 00 4B#	0aaaaaaaa 0bbbbbbbb	Limiter Bch: Release 0,,100
05 00 00 4C :	00 :	(Reserved)
05 00 7F 7F :	00 :	(Reserved)

* When Mic Converter Input = MinCn, output is fixed to SmlDy or LrgCn.
* When Link Sw = On, Bch corresponds to Ach.

○Algorithm 30 3 Band Isolator

05 00 00 0E 05 00 00 0F#	0aaaaaaaa 0bbbbbbbb	Isolator SW 0,1 = Off,On
05 00 00 10 05 00 00 11#	0aaaaaaaa 0bbbbbbbb	Isolator High Volume -60,,+4dB
05 00 00 12 05 00 00 13#	0aaaaaaaa 0bbbbbbbb	Isolator Middle Volume -60,,+4dB
05 00 00 14 05 00 00 15#	0aaaaaaaa 0bbbbbbbb	Isolator Low Volume -60,,+4dB
05 00 00 16 05 00 00 17#	0aaaaaaaa 0bbbbbbbb	Isolator Anti Phase Middle Switch 0,1 = Off,On
05 00 00 18 05 00 00 19#	0aaaaaaaa 0bbbbbbbb	Isolator Anti Phase Middle Level 0,,100
05 00 00 1A 05 00 00 1B#	0aaaaaaaa 0bbbbbbbb	Isolator Anti Phase Low Switch 0,1 = Off,On
05 00 00 1C 05 00 00 1D#	0aaaaaaaa 0bbbbbbbb	Isolator Anti Phase Low Level 0,,100
05 00 00 1E :	00 :	(Reserved)
05 00 7F 7F :	00 :	(Reserved)

○Algorithm 31 Tape Echo 201

05 00 00 0E 05 00 00 0F#	0aaaaaaaa 0bbbbbbbb	Tape Echo SW 0,1 = Off,On
05 00 00 10 05 00 00 11#	0aaaaaaaa 0bbbbbbbb	Tape Echo Mode Select 0,,6 = 1,,7
05 00 00 12 05 00 00 13#	0aaaaaaaa 0bbbbbbbb	Tape Echo Repeat Rate 0,,100
05 00 00 14 05 00 00 15#	0aaaaaaaa 0bbbbbbbb	Tape Echo Intensity 0,,100
05 00 00 16 05 00 00 17#	0aaaaaaaa 0bbbbbbbb	Tape Echo Effect Level 0,,100
05 00 00 18 05 00 00 19#	0aaaaaaaa 0bbbbbbbb	Tape Echo Direct Level 0,,100
05 00 00 1A 05 00 00 1B#	0aaaaaaaa 0bbbbbbbb	Tape Echo Tone Bass -100,,100
05 00 00 1C 05 00 00 1D#	0aaaaaaaa 0bbbbbbbb	Tape Echo Tone Treble -100,,100
05 00 00 1E 05 00 00 1F#	0aaaaaaaa 0bbbbbbbb	Tape Echo Tape Head S Pan 1,,127 = L63,,R63
05 00 00 20 05 00 00 21#	0aaaaaaaa 0bbbbbbbb	Tape Echo Tape Head M Pan 1,,127 = L63,,R63
05 00 00 22 05 00 00 23#	0aaaaaaaa 0bbbbbbbb	Tape Echo Tape Head L Pan 1,,127 = L63,,R63
05 00 00 24 05 00 00 25#	0aaaaaaaa 0bbbbbbbb	Tape Echo Tape Distortion 0,,100
05 00 00 26 05 00 00 27#	0aaaaaaaa 0bbbbbbbb	Tape Echo Wah Flutter Rate 0,,100
05 00 00 28 05 00 00 29#	0aaaaaaaa 0bbbbbbbb	Tape Echo Wah Flutter Depth 0,,100
05 00 00 2A :	00 :	(Reserved)
05 00 7F 7F :	00 :	(Reserved)

○Algorithm 32 Analog Flanger

05 00 00 0E 05 00 00 0F#	0aaaaaaaa 0bbbbbbbb	Analog Flanger SW 0,1 = Off,On
05 00 00 10 05 00 00 11#	0aaaaaaaa 0bbbbbbbb	Analog Flanger Mode 0,,3 = FL1,FL2,FL3,CHO
05 00 00 12 05 00 00 13#	0aaaaaaaa 0bbbbbbbb	Analog Flanger Feedback 0,,100
05 00 00 14 05 00 00 15#	0aaaaaaaa 0bbbbbbbb	Analog Flanger Modulation Rate 0,,100
05 00 00 16 05 00 00 17#	0aaaaaaaa 0bbbbbbbb	Analog Flanger Modulation Depth 0,,100
05 00 00 18 05 00 00 19#	0aaaaaaaa 0bbbbbbbb	Analog Flanger Modulation Frequency 0,,100
05 00 00 1A 05 00 00 1B#	0aaaaaaaa 0bbbbbbbb	Analog Flanger Channel B Modulation 0,1 = Nor,Inv
05 00 00 1C 05 00 00 1D#	0aaaaaaaa 0bbbbbbbb	Analog Flanger Channel A Phase 0,1 = Nor,Inv
05 00 00 1E 05 00 00 1F#	0aaaaaaaa 0bbbbbbbb	Analog Flanger Channel B Phase 0,1 = Nor,Inv
05 00 00 20 :	00 :	(Reserved)
05 00 7F 7F :	00 :	(Reserved)

○Algorithm 33 Analog Phaser

05 00 00 0E 05 00 00 0F#	0aaaaaaaa 0bbbbbbbb	Analog Phaser SW 0,1 = Off,On
05 00 00 10 05 00 00 11#	0aaaaaaaa 0bbbbbbbb	Analog Phaser Mode 0,1 = 4STAGE,8STAGE
05 00 00 12 05 00 00 13#	0aaaaaaaa 0bbbbbbbb	Analog Phaser Frequency 0,,100
05 00 00 14 05 00 00 15#	0aaaaaaaa 0bbbbbbbb	Analog Phaser Resonance 0,,100
05 00 00 16 05 00 00 17#	0aaaaaaaa 0bbbbbbbb	Analog Phaser LFO 1 Rate 0,,100
05 00 00 18 05 00 00 19#	0aaaaaaaa 0bbbbbbbb	Analog Phaser LFO 1 Depth 0,,100
05 00 00 1A 05 00 00 1B#	0aaaaaaaa 0bbbbbbbb	Analog Phaser LFO 1 Channel B Mod 0,1 = Nor,Inv
05 00 00 1C 05 00 00 1D#	0aaaaaaaa 0bbbbbbbb	Analog Phaser LFO 2 Rate 0,,100
05 00 00 1E 05 00 00 1F#	0aaaaaaaa 0bbbbbbbb	Analog Phaser LFO 2 Depth 0,,100
05 00 00 20 05 00 00 21#	0aaaaaaaa 0bbbbbbbb	Analog Phaser LFO 2 Channel B Mod 0,1 = Nor,Inv

MIDI Implementation

05 00 00 22	00	(Reserved)
:	:	:
05 00 7F 7F	00	(Reserved)

Algorithm 34 Speaker Modeling

05 00 00 0E	0aaaaaaa	Speaker Modeling SW	0,1 = Off,On
05 00 00 0F#	0bbbbbbb		
05 00 00 10	0aaaaaaa	Bass Cut SW	0,1 = Off,On
05 00 00 11#	0bbbbbbb		
05 00 00 12	0aaaaaaa	Low Frequency Trimmer SW	0,1 = Off,On
05 00 00 13#	0bbbbbbb		
05 00 00 14	0aaaaaaa	High Frequency Trimmer SW	0,1 = Off,On
05 00 00 15#	0bbbbbbb		
05 00 00 16	0aaaaaaa	Limiter SW	0,1 = Off,On
05 00 00 17#	0bbbbbbb		
05 00 00 18	0aaaaaaa	Output Speakers	0,1 = DS-90/DS-90A,DS-50A
05 00 00 19#	0bbbbbbb		
05 00 00 1A	0aaaaaaa	Speaker Modeling Model	0,,11 = THRU,Super Flat, Powered GenBlk,Powered E-Bas, Powered Mack,Small Cube,White Cone, White C +tissue,Small Radio,Small TV, Boom Box,BoomBox LoBoost
05 00 00 1B#	0bbbbbbb		
05 00 00 1C	0aaaaaaa	Speaker Modeling Phase	0,1 = NRM,INV
05 00 00 1D#	0bbbbbbb		
05 00 00 1E	0aaaaaaa	Bass Cut Frequency	1,,200 = Thru,20,,2000Hz
05 00 00 1F#	0bbbbbbb		
05 00 00 20	0aaaaaaa	Low Frequency Trimmer Gain	-12,,12dB
05 00 00 21#	0bbbbbbb		
05 00 00 22	0aaaaaaa	Low Frequency Trimmer Frequency	2,,200 = 20,,2000Hz
05 00 00 23#	0bbbbbbb		
05 00 00 24	0aaaaaaa	High Frequency Trimmer Gain	-12,,12dB
05 00 00 25#	0bbbbbbb		
05 00 00 26	0aaaaaaa	High Frequency Trimmer Frequency	10,,200 = 1.0,,20.0kHz
05 00 00 27#	0bbbbbbb		
05 00 00 28	0aaaaaaa	Limiter Threshold	-60,,0dB
05 00 00 29#	0bbbbbbb		
05 00 00 2A	0aaaaaaa	Limiter Release	0,,100
05 00 00 2B#	0bbbbbbb		
05 00 00 2C	0aaaaaaa	Limiter Level	-60,,24dB
05 00 00 2D#	0bbbbbbb		
05 00 00 2E	00	(Reserved)	
:	:	:	
05 00 7F 7F	00	(Reserved)	

Algorithm 35 Mastering Tool Kit (FX1 or FX3)

05 00 00 0E	0aaaaaaa	EQ SW	0,1 = Off,On
05 00 00 0F#	0bbbbbbb		
05 00 00 10	0aaaaaaa	Bass Cut SW	0,1 = Off,On
05 00 00 11#	0bbbbbbb		
05 00 00 12	0aaaaaaa	Enhancer SW	0,1 = Off,On
05 00 00 13#	0bbbbbbb		
05 00 00 14	0aaaaaaa	Expander SW	0,1 = Off,On
05 00 00 15#	0bbbbbbb		
05 00 00 16	0aaaaaaa	Compressor SW	0,1 = Off,On
05 00 00 17#	0bbbbbbb		
05 00 00 18	0aaaaaaa	Limiter SW	0,1 = Off,On
05 00 00 19#	0bbbbbbb		
05 00 00 1A	0aaaaaaa	EQ: Input Gain	-24,,12dB
05 00 00 1B#	0bbbbbbb		
05 00 00 1C	0aaaaaaa	EQ: Low EQ Type	0,1 = Shelving, Peaking
05 00 00 1D#	0bbbbbbb		
05 00 00 1E	0aaaaaaa	EQ: Low EQ Gain	-12,,12dB
05 00 00 1F#	0bbbbbbb		
05 00 00 20	0aaaaaaa	EQ: Low EQ Frequency	2,,42 = 20,,2000Hz (*1)
05 00 00 21#	0bbbbbbb		
05 00 00 22	0aaaaaaa	EQ: Low EQ Q	0,,31 = 0.3,,16.0 (*2)
05 00 00 23#	0bbbbbbb		
05 00 00 24	0aaaaaaa	EQ: Low Mid EQ Gain	-12,,12dB
05 00 00 25#	0bbbbbbb		
05 00 00 26	0aaaaaaa	EQ: Low Mid EQ Frequency	2,,54 = 20,,8000Hz (*1)
05 00 00 27#	0bbbbbbb		
05 00 00 28	0aaaaaaa	EQ: Low Mid EQ Q	0,,31 = 0.3,,16.0 (*2)
05 00 00 29#	0bbbbbbb		
05 00 00 2A	0aaaaaaa	EQ: High Mid EQ Gain	-12,,12dB
05 00 00 2B#	0bbbbbbb		
05 00 00 2C	0aaaaaaa	EQ: High Mid EQ Frequency	2,,54 = 20,,8000Hz (*1)
05 00 00 2D#	0bbbbbbb		

05 00 00 2E	0aaaaaaa	EQ: High Mid EQ Q	0,,31 = 0.3,,16.0 (*2)
05 00 00 2F#	0bbbbbbb		
05 00 00 30	0aaaaaaa	EQ: High EQ Type	0,1 = Shelving, Peaking
05 00 00 31#	0bbbbbbb		
05 00 00 32	0aaaaaaa	EQ: High EQ Gain	-12,,12dB
05 00 00 33#	0bbbbbbb		
05 00 00 34	0aaaaaaa	EQ: High EQ Frequency	39,,62 = 1.4,,20.0kHz (*1)
05 00 00 35#	0bbbbbbb		
05 00 00 36	0aaaaaaa	EQ: High EQ Q	0,,31 = 0.3,,16.0 (*2)
05 00 00 37#	0bbbbbbb		
05 00 00 38	0aaaaaaa	EQ: Level	-24,,12dB
05 00 00 39#	0bbbbbbb		
05 00 00 3A	0aaaaaaa	Bass Cut Frequency	1,,42 = Off,20,,2000Hz (*1)
05 00 00 3B#	0bbbbbbb		
05 00 00 3C	0aaaaaaa	Enhancer Sens	0,,100
05 00 00 3D#	0bbbbbbb		
05 00 00 3E	0aaaaaaa	Enhancer Frequency	36,,56 = 1.0,,10.0kHz (*1)
05 00 00 3F#	0bbbbbbb		
05 00 00 40	0aaaaaaa	Enhancer Mix Level	-24,,12dB
05 00 00 41#	0bbbbbbb		
05 00 00 42	0aaaaaaa	Input Gain	-24,,12dB
05 00 00 43#	0bbbbbbb		
05 00 00 44	0aaaaaaa	Input Detect Time	0,,10ms
05 00 00 45#	0bbbbbbb		
05 00 00 46	0aaaaaaa	Input Low Split Point	2,,34 = 20,,800Hz (*1)
05 00 00 47#	0bbbbbbb		
05 00 00 48	0aaaaaaa	Input High Split Point	40,,60 = 1.6,,16.0kHz (*1)
05 00 00 49#	0bbbbbbb		
05 00 00 4A	0aaaaaaa	Expander Low Threshold	0,,80 = -80,,0dB
05 00 00 4B#	0bbbbbbb		
05 00 00 4C	0aaaaaaa	Expander Mid Threshold	0,,80 = -80,,0dB
05 00 00 4D#	0bbbbbbb		
05 00 00 4E	0aaaaaaa	Expander High Threshold	0,,80 = -80,,0dB
05 00 00 4F#	0bbbbbbb		
05 00 00 50	0aaaaaaa	Expander Low Ratio	0,,13 = 1:1.0,,1:INF (*3)
05 00 00 51#	0bbbbbbb		
05 00 00 52	0aaaaaaa	Expander Mid Ratio	0,,13 = 1:1.0,,1:INF (*3)
05 00 00 53#	0bbbbbbb		
05 00 00 54	0aaaaaaa	Expander High Ratio	0,,13 = 1:1.0,,1:INF (*3)
05 00 00 55#	0bbbbbbb		
05 00 00 56	0aaaaaaa	Expander Low Attack	0,,100ms
05 00 00 57#	0bbbbbbb		
05 00 00 58	0aaaaaaa	Expander Mid Attack	0,,100ms
05 00 00 59#	0bbbbbbb		
05 00 00 5A	0aaaaaaa	Expander High Attack	0,,100ms
05 00 00 5B#	0bbbbbbb		
05 00 00 5C	0aaaaaaa	Expander Low Release	0,,100 = 50,,5000ms
05 00 00 5D#	0bbbbbbb		
05 00 00 5E	0aaaaaaa	Expander Mid Release	0,,100 = 50,,5000ms
05 00 00 5F#	0bbbbbbb		
05 00 00 60	0aaaaaaa	Expander High Release	0,,100 = 50,,5000ms
05 00 00 61#	0bbbbbbb		
05 00 00 62	0aaaaaaa	Compressor Low Threshold	-24,,0dB
05 00 00 63#	0bbbbbbb		
05 00 00 64	0aaaaaaa	Compressor Mid Threshold	-24,,0dB
05 00 00 65#	0bbbbbbb		
05 00 00 66	0aaaaaaa	Compressor High Threshold	-24,,0dB
05 00 00 67#	0bbbbbbb		
05 00 00 68	0aaaaaaa	Compressor Low Ratio	0,,13 = 1:1.0,,1:INF (*3)
05 00 00 69#	0bbbbbbb		
05 00 00 6A	0aaaaaaa	Compressor Mid Ratio	0,,13 = 1:1.0,,1:INF (*3)
05 00 00 6B#	0bbbbbbb		
05 00 00 6C	0aaaaaaa	Compressor High Ratio	0,,13 = 1:1.0,,1:INF (*3)
05 00 00 6D#	0bbbbbbb		
05 00 00 6E	0aaaaaaa	Compressor Low Attack	0,,100ms
05 00 00 6F#	0bbbbbbb		
05 00 00 70	0aaaaaaa	Compressor Mid Attack	0,,100ms
05 00 00 71#	0bbbbbbb		
05 00 00 72	0aaaaaaa	Compressor High Attack	0,,100ms
05 00 00 73#	0bbbbbbb		
05 00 00 74	0aaaaaaa	Compressor Low Release	0,,100 = 50,,5000ms
05 00 00 75#	0bbbbbbb		
05 00 00 76	0aaaaaaa	Compressor Mid Release	0,,100 = 50,,5000ms
05 00 00 77#	0bbbbbbb		
05 00 00 78	0aaaaaaa	Compressor High Release	0,,100 = 50,,5000ms
05 00 00 79#	0bbbbbbb		
05 00 00 7A	0aaaaaaa	Mixer Low Level	0,,86 = -80,,6dB
05 00 00 7B#	0bbbbbbb		

05 00 00 7C#	0aaaaaaa	Mixer Mid Level	0,,,86 = -80,,,6dB
05 00 00 7D#	0bbbbbbb		
05 00 00 7E	0aaaaaaa	Mixer High Level	0,,,86 = -80,,,6dB
05 00 00 7F#	0bbbbbbb		
05 00 01 00#	0aaaaaaa	Limiter Threshold	-24,,,0dB
05 00 01 01#	0bbbbbbb		
05 00 01 02	0aaaaaaa	Limiter Attack	0,,,100ms
05 00 01 03#	0bbbbbbb		
05 00 01 04	0aaaaaaa	Limiter Release	0,,,100 = 50,,,5000ms
05 00 01 05#	0bbbbbbb		
05 00 01 06	0aaaaaaa	Output Level	0,,,86 = -80,,,6dB
05 00 01 07#	0bbbbbbb		
05 00 01 08	0aaaaaaa	Output Soft Clip	0,1 = Off,On
05 00 01 09#	0bbbbbbb		
05 00 01 0A	00	(Reserved)	
:	:	:	:
05 00 7F 7F	00	(Reserved)	

(*1) See the Frequency Table of NRPN and Effect Parameters "Algorithm 35 Mastering Tool Kit."

(*2) See the Q Table of NRPN and Effect Parameters "Algorithm 35 Mastering Tool Kit."

(*3) See the Ratio Table of NRPN and Effect Parameters "Algorithm 35 Mastering Tool Kit."

●Sync Track Data

Start address	Data	Contents and remarks	
06 00 00 00	0000aaaa	Sync Track Data 1	aaaabbbbccccdddd
06 00 00 01#	0000bbbb		
06 00 00 02#	0000cccc		
06 00 00 03#	0000dddd		
06 00 00 04	0000aaaa	Sync Track Data 2	aaaabbbbccccdddd
06 00 00 05#	0000bbbb		
06 00 00 06#	0000cccc		
06 00 00 07#	0000dddd		
06 00 00 08	0000aaaa	Sync Track Data 3	
:	:	:	:
06 07 7F 7B#	0000dddd	Sync Track Data 32767	
06 07 7F 7C	0000aaaa	Sync Track Data 32768	aaaabbbbccccdddd
06 07 7F 7D#	0000bbbb		
06 07 7F 7E#	0000cccc		
06 07 7F 7F#	0000dddd		

<Model ID = 00H 36H (VE-7000)>

Address are expressed in 7bit hexadecimal values.

Address	MSB		LSB
Binary 7 Bit Hex	0aaa aaaa AA	0bbb bbbb BB	0ccc cccc CC

Start address	Data	Contents and remarks	
00 00 00	01	CH_COM_PHASE	
00 00 01	01	VIEW SCREEN (ATT)	
00 00 02	01	DYNAMICS SWITCH	
00 00 03	01	DYNAMICS SCREEN	
00 00 04	01	AUX1 SEND SWITCH	
00 00 05	01	AUX2 SEND SWITCH	
00 00 06	01	AUX3 SEND SWITCH	
00 00 07	01	AUX4 SEND SWITCH	
00 00 08	01	AUX5 SEND SWITCH	
00 00 09	01	AUX6 SEND SWITCH	
00 00 0A	01	AUX7 SEND SWITCH	
00 00 0B	01	AUX8 SEND SWITCH	
00 00 10	01	VIEW SCREEN (AUX SEND)	
00 00 11		(Reserved)	
00 00 12	01	EQ SWITCH	
00 00 13	01	EQ SCREEN	
00 00 14	01	SURROUND SCREEN	
00 00 15	01	VIEW SCREEN	
00 00 16	01 - 02	SHIFT	
00 00 17	01	MIX SWITCH	
00 00 18	01	VIEW SCREEN (PAN)	
00 01 00	00-7F(*1)	ATT	

00 01 01	00-7F(*1)	THRESHOLD
00 01 02	00-7F(*1)	RATIO
00 01 03	00-7F(*1)	ATTACK
00 01 04	00-7F(*1)	RELEASE
00 01 05	00-7F(*1)	AUX1 SEND LEVEL
00 01 06	00-7F(*1)	AUX2 SEND LEVEL
00 01 07	00-7F(*1)	AUX3 SEND LEVEL
00 01 08	00-7F(*1)	AUX4 SEND LEVEL
00 01 09	00-7F(*1)	AUX5 SEND LEVEL
00 01 0A	00-7F(*1)	AUX6 SEND LEVEL
00 01 0B	00-7F(*1)	AUX7 SEND LEVEL
00 01 0C	00-7F(*1)	AUX8 SEND LEVEL
00 01 11	00-7F(*1)	EQ HIGH GAIN
00 01 12	00-7F(*1)	EQ HIGH FREQ
00 01 13	00-7F(*1)	EQ HIGH-MID GAIN
00 01 14	00-7F(*1)	EQ HIGH-MID FREQ
00 01 15	00-7F(*1)	EQ HIGH-MID Q
00 01 16	00-7F(*1)	EQ LO-MID GAIN
00 01 17	00-7F(*1)	EQ LO-MID FREQ
00 01 18	00-7F(*1)	EQ LO-MID Q
00 01 19	00-7F(*1)	EQ LOW GAIN
00 01 1A	00-7F(*1)	EQ LOW FREQ
00 01 1B		(Reserved)
00 01 1C	00-7F(*1)	PAN
00 02 00	00 - 7F	SURROUND VERTICAL
00 02 01	00 - 7F	SURROUND HORIZONTAL

(*1) 7-bit binary complement

3. MIDI Machine Control

■MIDI Machine Control Details

●STOP(MCS)

Status	Data Byte	Status
F0H	7FH, Dev, 06H, 01H	F7H
Byte	Description	
F0H	Status of System Exclusive Message	
7FH	Universal System Exclusive Real time Header	
Dev	Device ID (or 7FH)	
06H	MMC Command Message	
01H	STOP (MCS)	
F7H	EOX (End of Exclusive Message)	

If the device ID on the message was as same as that of the receiving device or 7FH, the VS-2400CD stops immediately.

If the transport switch [STOP] was pressed, the VS-2400CD transmits as the device ID 7FH.

●PLAY(MCS)

Status	Data Byte	Status
F0H	7FH, Dev, 06H, 02H	F7H
Byte	Description	
F0H	Status of System Exclusive Message	
7FH	Universal System Exclusive Real time Header	
Dev	Device ID (or 7FH)	
06H	MMC Command Message	
02H	PLAY (MCS)	
F7H	EOX (End of Exclusive Message)	

If the device ID on the message was as same as that of the receiving device or 7FH, the VS-2400CD goes into the play back condition.

The VS-2400CD does not transmit this message.

MIDI Implementation

●DEFERRED PLAY(MCS)

Status	Data Byte	Status
F0H	7FH, Dev, 06H, 03H	F7H

Byte	Description
F0H	Status of System Exclusive Message
7FH	Universal System Exclusive Real time Header
Dev	Device ID (or 7FH)
06H	MMC Command Message
03H	DEFERRED PLAY(MCS)
F7H	EOX (End of Exclusive Message)

If the device ID on the message was as same as that of the receiving device or 7FH, the VS-2400CD goes into the play back condition after the locate operation.
If the transport switch [PLAY] was pressed, the VS-2400CD transmits as the device ID 7FH.

●FAST FORWARD(MCS)

Status	Data Byte	Status
F0H	7FH, Dev, 06H, 04H	F7H

Byte	Description
F0H	Status of System Exclusive Message
7FH	Universal System Exclusive Real time Header
Dev	Device ID (or 7FH)
06H	MMC Command Message
04H	FAST FORWARD(MCS)
F7H	EOX (End of Exclusive Message)

If the device ID on the message was as same as that of the receiving device or 7FH, the VS-2400CD goes into the fast forward condition.
The VS-2400CD does not transmit this message.

●REWIND(MCS)

Status	Data Byte	Status
F0H	7FH, Dev, 06H, 05H	F7H

Byte	Description
F0H	Status of System Exclusive Message
7FH	Universal System Exclusive Real time Header
Dev	Device ID (or 7FH)
06H	MMC Command Message
05H	REWIND(MCS)
F7H	EOX (End of Exclusive Message)

If the device ID on the message was as same as that of the receiving device or 7FH, the VS-2400CD goes into the rewind condition.
The VS-2400CD does not transmit this message.

●RECORD STROBE

Status	Data Byte	Status
F0H	7FH, Dev, 06H, 06H	F7H

Byte	Description
F0H	Status of System Exclusive Message
7FH	Universal System Exclusive Real time Header
Dev	Device ID (or 7FH)
06H	MMC Command Message
06H	RECORD STROBE
F7H	EOX (End of Exclusive Message)

If the device ID on the message was as same as that of the receiving device or 7FH, the VS-2400CD goes into the following condition.

1. The VS-2400CD is in the play back condition. Start Recording the tracks that status are the record standby mode.
2. The VS-2400CD is in the stop condition. Start Playing back and Start Recording the track that status are the record standby mode.

If the transport switch [REC] was pressed out of the recording condition, the VS-2400CD transmits as the device ID 7FH.ccH,ddH,eeH,,ffH,,

●RECORD EXIT

Status	Data Byte	Status
F0H	7FH, Dev, 06H, 07H	F7H

Byte	Description
F0H	Status of System Exclusive Message
7FH	Universal System Exclusive Real time Header
Dev	Device ID (or 7FH)
06H	MMC Command Message
07H	RECORD EXIT
F7H	EOX (End of Exclusive Message)

If the device ID on the message was as same as that of the receiving device or 7FH, the VS-2400CD exit from the record condition.
If the transport switch [REC] was pressed while recording, the VS-2400CD transmits as the device ID 7FH.

●MMC RESET

Status	Data Byte	Status
F0H	7FH, Dev, 06H, 0DH	F7H

Byte	Description
F0H	Status of System ExclusiveMessage.
7FH	Universal System Exclusive Real time Header
Dev	Device ID (or 7FH)
06H	MMC Command Message
0DH	MMC RESET
F7H	EOX (End of Exclusive Message)

If the device ID on the message was as same as that of the receiving device or 7FH, the VS-2400CD resets all communication channels related with MMC.
When powered on the VS-2400CD transmits as the device ID 7FH.

●WRITE

Status	Data Byte	Status
F0H	7FH, Dev, 06H, 40H,	F7H

Byte	Description
F0H	Status of System Exclusive Message
7FH	Universal System Exclusive Real time Header
Dev	Device ID (or 7FH)
06H	MMC Command Message
40H	WRITE
ccH	Information Bytes follows the command
ddH	The name of the writable Information Field.
eeH	Information Field Format
:	:
ffH	Field names and data
:	:
F7H	EOX (End of Exclusive Message)

If the device ID on the message was as same as that of the receiving device or 7FH, the VS-2400CD write the data to the specified information field.
The VS-2400CD does not transmit this message.

●MASKED WRITE

Status	Data Byte	Status
F0H	7FH, Dev, 06H, 41H, 04H, ddH, eeH, ffH, ggH	F7H

Byte	Description
F0H	Status of System Exclusive Message
7FH	Universal System Exclusive Real time Header
Dev	Device ID (or 7FH)
06H	MMC Command Message
41H	MASKED WRITE
04H	Number of Bytes follows the command
ddH	The name of the masked type writable Information Field
eeH	Byte number to write in the Bit Map
ffH	bit location of the bit map byte to change
ggH	New data to write to the specified bit map byte
F7H	EOX (End of Exclusive Message)

If the device ID on the message was as same as that of the receiving device or 7FH, the VS-2400CD writes the data to the specified bit map byte.
The VS-2400CD does not transmit this message.

●LOCATE(MCP)

○Format 1 - LOCATE[I/F]

Status	Data Byte	Status
F0H	7FH, Dev, 06H, 44H, 02H, 00H, nnH	F7H

Byte	Description
F0H	Status of System Exclusive Message
7FH	Universal System Exclusive Real time Header
Dev	Device ID (or 7FH)
06H	MMC Command Message
44H	LOCATE(MCP)
02H	Number of Bytes
00H	*I/F* sub command
nnH	Information Field (08H, 09H, 0AH, 0BH, 0CH, 0DH, 0EH, 0FH)
F7H	EOX (End of Exclusive Message)

If the device ID on the message was as same as that of the receiving device or 7FH, the VS-2400CD locates the selected time location stored to the specified information filed.
The VS-2400CD does not transmit this message.

○Format 2 - LOCATE[TARGET]

Status	Data Byte	Status
F0H	7FH, Dev, 06H, 44H, 06H, 01H, hrH, mnH, scH, frH, ffH	F7H

Byte	Description
F0H	Status of System Exclusive Message
7FH	Universal System Exclusive Real time Header
Dev	Device ID (or 7FH)
06H	MMC Command Message
44H	LOCATE(MCP)
06H	Number of Bytes
01H	"TARGET" sub command
hrH, mnH, scH, frH, ffH	Standard time with Sub Frame
F7H	EOX (End of Exclusive Message)

If the device ID on the message was as same as that of the receiving device or 7FH, the VS-2400CD locates the specified time location received from the command.

If the efficient locate number or marker number is selected, the VS-2400CD transmits as the device ID 7FH.

●MOVE

Status	Data Byte	Status
F0H	7FH, Dev, 06H, 4CH, 02H, ddH, ssH	F7H

Byte	Description
F0H	Status of System Exclusive Message
7FH	Universal System Exclusive Real time Header
Dev	Device ID (or 7FH)
06H	MMC Command Message
4CH	MOVE
02H	Number of Bytes
ddH	Name of the Efficient Destination Information Field (08H, 09H, 0AH, 0BH, 0CH, 0DH, 0EH, 0FH)
ssH	Name of the Efficient Source Information Field
F7H	EOX (End of Exclusive Message)

If the device ID on the message was as same as that of the receiving device or 7FH, the VS-2400CD transfers the data on the selected source information filed to the destination Information Field, if the name of both information fields in efficient.

The VS-2400CD does not transmit this message.

●The efficient Information Field

The followings are the efficient Information Field on the VS-2400CD.

The name of the efficient destination Information Field:

- 01H SELECTED TIME CODE
- 08H GP0 / LOCATE POINT
- 09H GP1
- 0AH GP2
- 0BH GP3
- 0CH GP4
- 0DH GP5
- 0EH GP6
- 0FH GP7
- 4FH TRACK RECORD READY

4. Bulk Dump

VS-2400CD can transfer and receive the scenes, the EZ ROUTING User Templates and the User Effect Patches by bulk dump.

In order to make bulk dump transmit, a transmitting function is performed on UTILITY-MIDI BULK DUMP screen.

In order to make bulk dump receive, after changing into a reception standby state on UTILITY-MIDI BULK DUMP screen, the bulk dump which the VS-2400CD outputted beforehand is sent to the VS-2400CD.

■Address Block

Start address	Contents and remarks
10 00 00 00	SCENE #00
:	:
10 00 7F 7F	:
10 01 00 00	SCENE #01
:	:
10 01 7F 7F	:
:	:
10 63 00 00	SCENE #99
:	:
10 63 7F 7F	:
11 00 00 00	EZ ROUTING USER TEMPLATE #00
:	:
11 00 7F 7F	:
11 01 00 00	EZ ROUTING USER TEMPLATE #01
:	:
11 01 7F 7F	:
:	:
11 13 00 00	EZ ROUTING USER TEMPLATE #19
:	:
11 13 7F 7F	:
12 00 00 00	EFFECT USER PATCH #000
:	:
12 00 01 7F	:
12 00 02 00	EFFECT USER PATCH #001
:	:
12 00 03 7F	:
:	:
12 03 0E 00	EFFECT USER PATCH #199
:	:
12 03 0F 7F	:

5. V-LINK TRANSMITTED DATA

The following control command will be transmitted while V-LIN function is activated.

■ CHANNEL VOICE MESSAGES

● CONTROL CHANGE

○ BANK SELECT(MSB)

This is used to switch image banks. (MIDI ch.=1 fixed)

In the V-LINK activated mode, while AUTOMIX is playing, this is transmitted when the current time coincides with the pre-registered time for switching image bank.

Status	Second	Third
BOH	00H	mmH

mm = Bank number : 00H - 7FH (1 - 128)

○ PROGRAM CHANGE

This is used to switch image clip to be played or to select video input channel. (MIDI ch. = 1 fixed)

In the V-LINK activated mode and while AUTOMIX is playing, this is transmitted when the current time coincides with the pre-registered time for switching image clip.

Status	Second
COH	ppH

pp = Program number : 00H - 7FH (1 - 128)

■ CHANNEL MODE MESSAGES

● RESET ALL CONTROLLERS (Controller number 121)

This is transmitted when [CLEAR]+[V-LINK] are pressed. (MIDI ch.=1 fixed)

Status	Second	Third
BOH	79H	00H

● ALL NOTEOFF(Controller number 123)

This is transmitted when VS-2400CD stops. (MIDI ch.=1 fixed)

Status	Second	Third
BOH	7BH	00H

■ SYSTEM EXCLUSIVE MESSAGES

● V-LINK ON

Status	Data Byte	Status
F0H	41H, 7FH, 00H, 51H, 12H, 10H, 00H, 00H, 01H, aaH, ..., ffH, Sum	F7H

Byte	Description
F0H	Status of System Exclusive Message
41H	Manufacturers ID (Roland)
7FH	Device ID
00H 51H	Model ID (DV-7PR)
12H	Command ID (DT1)
10H	Address MSB
00H	Address
00H	Address LSB
01H	V-LINK ON/OFF (ON)
aaH	Clip Ctrl Rx MIDI ch (*1)
bbH	Color Ctrl Rx MIDI ch (*1)
ccH	Note Message Enabled (*2)
ddH	Fast Control Enabled (*3)
eeH	MMC Control Mode (*4)
ffH	MTC Control Mode (*5)
Sum	Check Sum
F7H	EOX (End Of Exclusive)

These messages are transmitted when V-LINK function turns to enable.
VS-2400CD doesn't receive these messages.

(*1) 00H(ch.1) fixed

(*2) 00H(OFF) fixed

(*3) 01H(ON) fixed

(*4) It depends on MMC mode(OFF, MASTER or SLAVE) of VS-2400CD as followings.

OFF 00H(OFF)

MASTER 01H(SLAVE)

SLAVE 02H(MASTER)

(*5) It depends on SYNC mode(INT or EXT) of VS-2400CD as followings.

INT 01H(SLAVE)

EXT 02H(MASTER)

● V-LINK OFF

Status	Data Byte	Status
F0H	41H, 7FH, 00H, 51H, 12H, 10H, 00H, 00H, 00H, Sum	F7H

Byte	Description
F0H	Status of System Exclusive Message
41H	Manufacturer's ID (Roland)
7FH	Device ID
00H 51H	Model ID (DV-7PR)
12H	Command ID (DT1)
10H	Address MSB
00H	Address
00H	Address LSB
00H	V-LINK ON/OFF (OFF)
Sum	Check Sum
F7H	EOX (End Of Exclusive)

These messages are transmitted when V-LINK function turns to disable.
VS-2400CD doesn't receive these messages.

● SET CLIP CONTROL ASSIGNMENT

Status	Data Byte	Status
F0H	41H, 7FH, 00H, 51H, 12H, 10H, 10H, 00H, 05H, 00H, 00H, 05H, Sum	F7H

Byte	Description
F0H	Status of System Exclusive Message
41H	Manufacturer's ID (Roland)
7FH	Device ID
00H 51H	Model ID (DV-7PR)
12H	Command ID (DT1)
10H	Address MSB
10H	Address
00H	Address LSB
04H	play back Spped Control Assign(MSB)
08H	play back Spped Control Assign(LSB)
00H	Dissolve Time Control Assign(MSB)
05H	Dissolve Time Control Assign(LSB)
Sum	Check Sum
F7H	EOX (End Of Exclusive)

These messages are transmitted when V-LINK function turns to enable.
VS-2400CD doesn't receive these messages.

● SET COLOR CONTROL ASSIGNMENT

Status	Data Byte	Status
F0H	41H, 7FH, 00H, 51H, 12H, 10H, 20H, 00H, 00H, 07H, 00H, 0AH, 00H, 01H, Sum	F7H

Byte	Description
F0H	Status of System Exclusive Message
41H	Manufacturer's ID (Roland)
7FH	Device ID
00H 51H	Model ID (DV-7PR)
12H	Command ID (DT1)
10H	Address MSB
20H	Address
00H	Address LSB
00H	Color Cb Control Assign(MSB)
07H	Color Cb Control Assign(LSB)
00H	Color Cr Control Assign(MSB)
0AH	Color Cr Control Assign(LSB)
00H	Brightness Control Assign(MSB)
01H	Brightness Control Assign(LSB)
Sum	Check Sum
F7H	EOX (End Of Exclusive)

These messages are transmitted when V-LINK function turns to enable.
VS-2400CD doesn't receive these messages.

6. Appendices

●Decimal and Hexadecimal table (Hexadecimal number is shown with H.)

In MIDI documentation, data values and addresses/sizes of system exclusive messages etc. are expressed as hexadecimal values for each 7 bits.

the following table shows how these correspond to decimal numbers.

dec	hex	dec	hex	dec	hex	dec	hex
0	00H	32	20H	64	40H	96	60H
1	01H	33	21H	65	41H	97	61H
2	02H	34	22H	66	42H	98	62H
3	03H	35	23H	67	43H	99	63H
4	04H	36	24H	68	44H	100	64H
5	05H	37	25H	69	45H	101	65H
6	06H	38	26H	70	46H	102	66H
7	07H	39	27H	71	47H	103	67H
8	08H	40	28H	72	48H	104	68H
9	09H	41	29H	73	49H	105	69H
10	0AH	42	2AH	74	4AH	106	6AH
11	0BH	43	2BH	75	4BH	107	6BH
12	0CH	44	2CH	76	4CH	108	6CH
13	0DH	45	2DH	77	4DH	109	6DH
14	0EH	46	2EH	78	4EH	110	6EH
15	0FH	47	2FH	79	4FH	111	6FH
16	10H	48	30H	80	50H	112	70H
17	11H	49	31H	81	51H	113	71H
18	12H	50	32H	82	52H	114	72H
19	13H	51	33H	83	53H	115	73H
20	14H	52	34H	84	54H	116	74H
21	15H	53	35H	85	55H	117	75H
22	16H	54	36H	86	56H	118	76H
23	17H	55	37H	87	57H	119	77H
24	18H	56	38H	88	58H	120	78H
25	19H	57	39H	89	59H	121	79H
26	1AH	58	3AH	90	5AH	122	7AH
27	1BH	59	3BH	91	5BH	123	7BH
28	1CH	60	3CH	92	5CH	124	7CH
29	1DH	61	3DH	93	5DH	125	7DH
30	1EH	62	3EH	94	5EH	126	7EH
31	1FH	63	3FH	95	5FH	127	7FH

(*) Decimal values such as MIDI channel, bank select, and program change are listed as one(1) greater than the values given in the above table.

(*) A 7-bit byte can express data in the range of 128 steps. For data where greater precision is required, we must use two or more bytes. For example, two hexadecimal numbers aa bbH expression two 7-bit bytes would indicate a value of aa x 128 + bb.

(*) In the case of values which have a +/- sign, 40H=-64, 00H=0, 3FH=+63, so that the decimal expression would be 64 less than the value given in the above chart.

In the case of two types, 40 00H = -8192, 00 00H = 0, 3F 7FH = +8191.

(*) Data marked "nibbled" is expressed in hexadecimal in 4-bit units.

A value expressed as a 20byte nibble 0a 0bH has the value of a x 16 + b.

<Ex.1> What 5AH in decimal system?

5AH = 90 according to the above table.

<Ex.2> What in decimal system is 12034H in hexadecimal of every 7 bit?

12H = 18, 34H = 52 according to the above table. So 18 x 128 + 52 = 2356.

<Ex.3> What in decimal system is 0A 03 09 0D in nibble system?

0AH = 10, 03H = 3, 09H = 9, 0DH = 13 according to the above table.

So ((10 x 16 + 3) x 16 + 9) x 16 + 13 = 41885.

<Ex.4> What in nibble system is 1258 in decimal system?

```

16) 1258
   78 ... 10
   4 ... 14
   0 ... 4

```

0 = 00H, 4 = 04H, 14 = 0EH, 10 = 0AH according to the above table. So it is 00 04 0E 0AH.

●Example of system exclusive message and Checksum calculation

On Roland system exclusive message (DT1), checksum is added at the end of transmitted data (in front of F7) to check the message is received correctly.

Value of checksum is defined by address and data (or size) of the system exclusive message to be transmitted.

○How to calculate checksum (Hexadecimal number is shown with H.)

checksum is a value which lower 7 bit of the sum of address, size and checksum itself turns to be 0.

If the address of the system exclusive message to be transmitted is aa bb cH and data or size is dd ee fH,

$$aa + bb + cc + dd + ee + ff = \text{sum}$$

$$\text{sum} / 128 = \text{quotient and odd}$$

When odd is 0, 0 = checksum
 When odd is other than 0, 128 - odd = checksum.

■MIDI Machine Control (MMC) Command, Information Field/Response Reference

●Command Recognized

Command	Action
01H STOP	STOP
02H PLAY	PLAY
03H DEFERRED PLAY	PLAY
04H FAST FORWARD	FF
05H REWIND	REW
06H RECORD STROBE	REC / PUNCH IN
07H RECORD EXIT	PUNCH OUT
0DH MMC RESET	RESET
40H WRITE	write to Information fields
41H MASKED WRITE	Set Track Status Information Fields
44H 00H LOCATE I/F	LOCATE (Read Locator)
44H 01H LOCATE TARGET	LOCATE (Designated Time)
4CH MOVE	Move between Information

●Commands Transmitted

Command	Action
01H STOP	STOP
03H DEFERRED PLAY	PLAY
06H RECORD STROBE	REC / PUNCH IN
07H RECORD EXIT	PUNCH OUT
0DH MMC RESET	RESET
44H 01H LOCATE TARGET	LOCATE

●Valid Information Fields/response

Command	Action	Valid Commands
01H SELECTED TIME CODE	Current Time	MOVE (FROM)
08H GP0 / LOCATE POINT	Locator 1	MOVE (FROM), MOVE (TO), WRITE
09H GP1	Locator 2	MOVE (FROM), MOVE (TO), WRITE
0AH GP2	Locator 3	MOVE (FROM), MOVE (TO), WRITE
0BH GP3	Locator 4	MOVE (FROM), MOVE (TO), WRITE
0CH GP4	Locator 5	MOVE (FROM), MOVE (TO), WRITE
0DH GP5	Locator 6	MOVE (FROM), MOVE (TO), WRITE
0EH GP6	Locator 7	MOVE (FROM), MOVE (TO), WRITE
0FH GP7	Locator 8	MOVE (FROM), MOVE (TO), WRITE
4FH TRACK RECORD READY	Track Status	MASKED WRITE, WRITE

Digital Studio Workstation
Model VS-2400CD

MIDI Implementation Chart

Date: Oct. 2, 2002
Version : 1.00

Function...	Transmitted	Recognized	Remarks
Basic Channel: Default changed	1-16 1-16 *1	1-16	
Mode: Default Messages Altered	Mode 3 x *****	Mode 3 x x	
Note Number: True Voice	o *1 12-127	o *6 36-84, 36-60	
Velocity: Note On Note Off	1-127 *1 x 9n, v=0	x x	
After Touch: Key's Channel's	o *5 x	x x	
Pitch Bender:	x	o *6	
Control Change:	0-119 o *11	o	
	0, 32 o *12	o	
	6, 38 x	o	
	7, 39, 71 o	o	
	10, 42, 74 o	o	
	12, 44, 76 o	o	
	13, 45, 77 o	o	
	14, 46, 78 o	o	
	15, 47, 79 o	o	
	16, 48, 80 o	o	
	17, 49, 81 o	o	
	18, 50, 82 o	o	
	19, 51, 83 o	o	
	20, 52, 84 o	o	
	21, 53, 85 o	o	
	22, 54, 86 o	o	
	23, 55, 87 o	o	
	24, 56, 88 o	o	
	25, 57, 89 o	o	
	35, 67 o	o	
64 x	o		
96, 97 x	o		
98, 99 x	o		
102-115 o	o		
Program Change: True Number	o *13 ***** *****	o *1 0-99 *7 0-99 *8	Effect 0-99 Scene 0-99
System Exclusive	o *9	o *10	
Common: Quarter Frame Song Position Project Select Tune	o *2 o *3 x x	o *2 x x x	
Realtime: Clock Command	o *3 o	o *4 o	
Aux: All sound Off Reset All Controllers Local on/off All Notes Off Active Sensing System Reset	x o *13 x o *13 x x	x x x x x	
Notes	*1 MIDI Metronome Only *2 MIDI OUT SYNC Gen.=MTC Only *3 MIDI OUT SYNC Gen.=MIDIclk or SyncTr Only *4 When recording Sync Track Only *5 Transmits Level Meter Value according to the value of UTILITY-SYSTEM screen's DISPLAY SECTION. MIDI CH=16 (fixed). *6 When the effect patch Voice Transformer effect (algorithm 27) is selected and MIDI CONTROL Sw is "On" only. *7 When EFFECT P.C. Rx Sw=On and MIDI CH=1-8. *8 When SCENE P.C. Rx Sw=On and MIDI CH=16. *9 SysEx. Tx Sw=On Only *10 SysEx. Rx Sw=On Only *11 When the Fader is V.FADER Mode. *12 When V-LINK switch is "On," transmit MSB. *13 V-LINK switch is "On" only.		

Mode1 : OMNI ON, POLY
Mode3 : OMNI OFF, POLY

Mode 2 : OMNI ON, MONO
Mode 4 : OMNI OFF, MONO

o: Yes
x: No

Track Sheet

Roland® VS-2400CD Project _____ Artist _____ Client _____
 Track Sheet (1) Project Name _____ Date _____
 Partition # _____ Backing up to _____

		Tracks							
		1	2	3	4	5	6	7	8
1									
2									
3									
4									
5									
6									
7									
8									
9									
10									
11									
12									
13									
14									
15									
16									

V-Tracks

		SCENE									
		0	1	2	3	4	5	6	7	8	9
0											
1											
2											
3											
4											
5											
6											
7											
8											
9											

LOCATOR

		0	1	2	3	4	5	6	7	8	9
0											
1											
2											
3											
4											
5											
6											
7											
8											
9											

Roland® VS-2400
Track Sheet (2)

		Tracks																				
		9	10	11	12	13	14	15	16													
1	2	3	4	5	6	7	8	9	10	11	12	13	14	15	16							
		V-Tracks																				
1	2	3	4	5	6	7	8	9	10	11	12	13	14	15	16							
2	3	4	5	6	7	8	9	10	11	12	13	14	15	16								
3	4	5	6	7	8	9	10	11	12	13	14	15	16									
4	5	6	7	8	9	10	11	12	13	14	15	16										
5	6	7	8	9	10	11	12	13	14	15	16											
6	7	8	9	10	11	12	13	14	15	16												
7	8	9	10	11	12	13	14	15	16													
8	9	10	11	12	13	14	15	16														
9	10	11	12	13	14	15	16															
10	11	12	13	14	15	16																
11	12	13	14	15	16																	
12	13	14	15	16																		
13	14	15	16																			
14	15	16																				
15	16																					
16																						

NOTES

Roland® VS-2400CD
Track Sheet (3)

		Tracks							
		17	18	19	20	21	22	23	24
1	V-Tracks								
2									
3									
4									
5									
6									
7									
8									
9									
10									
11									
12									
13									
14									
15									
16									

NOTES

About the Demo Performances

"Promises"

Written by Scott Tibbs

© 2002 Buoy Music BMI All rights reserved

		V-Tracks															
		1	2	3	4	5	6	7	8	9	10	11	12	13	14	15	16
Tracks	1	Kick							Kick								
	2	Snare							Snare								
	3	Claps							Claps								
	4	Real Snare							Real Snare								
	5	Bass							Bass								
	6	El.Piano							El.Piano								
	7	Scratch&FX-L *							Scratch&FX-L *								
	8	Scratch&FX-R *							Scratch&FX-R *								
	9	Male Lead							Male Lead								
	10	Female Lead	Femme Lead						Female Lead								
	11	Rap N Stuff *							Rap N Stuff *								
	12	Femme Lead							Femme Lead								
	13	Male Bgnd L *							Male Bgnd L *								
	14	Male Bgnd R *							Male Bgnd R *								
	15	Female BgndL							Female BgndL								
	16	Female BgndR							Female BgndR								
	17																
	18	Electric Gtr	ElGtr+outroSolo						Electric Gtr								
	19	AC Gtr L							AC Gtr L								
	20	AC Gtr R							AC Gtr R								
	21	Super Pad L							Super Pad L								
	22	Super Pad R							Super Pad R								
	23	Synth Lead							Synth Lead								
	24	Pop Synth							Pop Synth								

LOCATOR (BANK 1)		SCENE (BANK 0)	
Locate 0		Scene 0	Default Mix
Locate 1	Intro	Scene 1	Mix w/ MTK
Locate 2	Verse	Scene 2	Short Intro
Locate 3	Drop	Scene 3	
Locate 4	Bridge	Scene 4	
Locate 5	Drop 2	Scene 5	
Locate 6	Chorus	Scene 6	
Locate 7	Middle	Scene 7	
Locate 8	Rap	Scene 8	
Locate 9	Chorus/Outro	Scene 9	

* RSS PAN is applied to audio on these tracks.

"Chemistry"

Written by Dan Wilson

(c)2001 Semidelicious Music/wb Music Corp (ASCAP) all rights reserved

SemiSonic appears courtesy of MCA Records

		V-Tracks															
		1	2	3	4	5	6	7	8	9	10	11	12	13	14	15	16
Tracks	1	Kick															
	2	Share															
	3	Overhead L															
	4	Overhead R															
	5	Hat															
	6	Bass								Bass Take 2							
	7	Perc Bounce L								Vocal FX L							
	8	Perc Bounce R								Vocal FX R							
	9	Piano												Tambourine			
	10	Lead Vocal												Shaker			
	11	Organ												Drumslps L			
	12													Drumslps R			
	13	Bgnd Vox L															
	14	Bgnd Vox R															
	15	Guitar L															
	16	Guitar R															
	17	End Riffs															
	18	Clav. Riffs															
	19	BV Vox Bounce L							Chorus Vox L	Hook Vox L							
	20	BV Vox Bounce R							Chorus Vox R	Hook Vox R							
	21									FX Return L							
	22									FX Return R							
	23	Gtr Bounce L									Gtr Tele	Gtr Hook/BI LP	Gtr Hook Dbld L	Dist Hook	Gtr Stabs L		
	24	Gtr Bounce R											Gtr Hook Dbld R	Picked Gtr	Gtr Stabs R		

LOCATOR (BANK 0)		SCENE (BANK 0)	
Locate 0	Downbeat	Scene 0	Auto Mix
Locate 1	Guit. Intro	Scene 1	Drums/Bass
Locate 2	Verse 1	Scene 2	4 FX Mix
Locate 3	Chorus 1	Scene 3	VoxFX/No Drms
Locate 4	Guit Lick	Scene 4	Perc Bounce
Locate 5	Verse 2	Scene 5	Drums/Vox
Locate 6	Chorus 2	Scene 6	
Locate 7	Bridge	Scene 7	
Locate 8	Solo	Scene 8	
Locate 9	Vs/Cho Out	Scene 9	

SPECIFICATIONS

VS-2400CD

24-Tr, 24-bit, 96kHz Sampling Digital Studio Workstation

Tracks

Tracks: 24
V.Tracks: 384 (16-V.Tracks per each Track)

Sample Rate

96.0/88.2/64.0/48.0/44.1/32.0 kHz

- * Adjustable range with vari-pitch function
22.00 kHz – 98.00 kHz (at 96 kHz)
22.00 kHz – 50.00 kHz (at 48 kHz)

Recording Mode

Mastering 24-bit (M24)
Multitrack Pro (MTP)
CD Writing (CDR)
Mastering 16-bit (M16)
Multitrack 1 (MT1)
Multitrack 2 (MT2)
Live 1 (LIV)
Live 2 (LV2)

Maximum Simultaneous Recording / play back Tracks

- Sample Rate 48/44.1/32 kHz
16-tr. Rec / 16-tr. Play (M24, M16, CDR)
16-tr. Rec / 24-tr. Play (MTP, MT1/2, LIV, LV2)
- Sample Rate 96/88.2/64 kHz
8-tr. Rec / 8-tr. Play (M24, M16, CDR)
8-tr. Rec / 12-tr. Play (MTP, MT1/2, LIV, LV2)

* Depending on the organization of the song data etc., the number of tracks which can be simultaneously recorded or played back may be limited.

* 16-track simultaneous recording requires optional 8-channel R-BUS device.

Maximum Useful Capacity

40 G bytes: 10 G bytes (Capacity) x 4 (Partition)

Recording Time (at 10GB Partition, conversion in 1 track, unit: minutes)

Recording Mode	Sample Rate (kHz)					
	96	88.2	64	48	44.1	32
M24	658	716	987	1,316	1,433	1,975
MTP	1,977	2,152	2,966	3,954	4,305	5,932
M16	988	1,076	1,483	1,977	2,152	2,966
CDR	988	1,076	1,483	1,977	2,152	2,966
MT1	1,977	2,152	2,966	3,954	4,305	5,932
MT2	2,635	2,866	3,953	5,271	5,732	7,907
LIV	3,163	3,442	4,744	6,326	6,885	9,489
LV2	3,954	4,304	5,932	7,909	8,609	11,864

* The above-listed recording times are approximate. Times may be slightly depending on the specifications of the disk drive and on the number of songs that were created.

* In "CDR" recording mode, two tracks are always used in a pair (channel link is on), so recording time is half the above-listed.

* Maximum recording time of VS-2400CD is approximately four times of above recording time. (10 GB x 4 Partitions)

Frequency Response

96.0 kHz: 20 Hz – 40 kHz (+0 dB/-2 dB)
88.2 kHz: 20 Hz – 40 kHz (+0 dB/-2 dB)
48.0 kHz: 20 Hz – 22 kHz (+0 dB/-2 dB)
44.1 kHz: 20 Hz – 20 kHz (+0 dB/-2 dB)
32.0 kHz: 20 Hz – 14 kHz (+0 dB/-2 dB)

Projects

200 projects in each partition

Marker

1000 per project

Locator

100 (10 x 10 banks) per project

Scene

100 (10 x 10 banks) per project

Undo/Redo

999 Undo / 1 Redo

Nominal Input Level (variable)

Input 1–8: -50 – +14 dBu
(maximum +26dBu: balanced,
maximum +20dBu: unbalanced)
Guitar (Hi-Z): -50 – +14 dBu (maximum +20 dBu)

Input Impedance

Input 1–8: 10 k ohm (balanced)
Guitar (Hi-Z): 1 M ohm

Nominal Output Level

Master Out: +4 dBu (balanced)
AUX A (L, R): +4 dBu (balanced)
AUX B (L, R): +4 dBu (balanced)
Monitor Out: +4 dBu (balanced)

Output Impedance

Master Out: 600 ohm
AUX A (L, R): 600 ohm
AUX B (L, R): 600 ohm
Monitor Out: 600 ohm
Phones: 22 ohm

Recommended Load Impedance

Master Out: 10 k ohm or greater
AUX A (L, R): 10 k ohm or greater
AUX B (L, R): 10 k ohm or greater
Monitor Out: 10 k ohm or greater
Phones: 8 – 600 ohm

SPECIFICATIONS

Residual Noise Level (input terminated with 1k ohm, INPUT SENS: LINE, IHF-A, typ.)

Master Out: -86 dBu or less
AUX A: -86 dBu or less
AUX B: -86 dBu or less
Monitor Out: -86 dBu or less

EQ

4-band (2 shelving + 2 peaking)

- * Useful simultaneously at up to 32ch in both Input Mixer and Track Mixer. (at 48kHz or less.)
- * Useful simultaneously at up to 16ch in both Input Mixer and Track Mixer. (at 64kHz or above.)

Dynamics Processor

Compressor, Expander

- * Useful simultaneously at up to 32ch in both Input Mixer and Track Mixer. (at 48kHz or less.)
- * Useful simultaneously at up to 16ch in both Input Mixer and Track Mixer. (at 64kHz or above.)

Effects

Maximum 4 stereo (One pre-installed + One more optional VS8F-2)

Display

320 x 240 dots Graphic LCD (with backlit)

Interface

Digital I/O: Coaxial, Optical (conforms to IEC60958)
VGA Out: 15-pin miniD-sub
PS/2: 6-pin miniDIN
MIDI: 5-pin DIN
R-BUS: 25-pin D-sub

Hard Disk Drive

IDE type 3.5 inches 40 G bytes

CD-RW Drive

Reading Speed: 24x (max.)
Recording Speed: Record (CD-R) 4x correspond
Re-Write (CD-RW) 4x correspond

Connectors

MIDI Connectors (5-pin DIN)
Input Jack 1-8 (XLR type [balanced, phantom power])
Input Jack 1-8 (1/4inch phone type [TRS balanced])
Guitar (Hi-Z) Jack (1/4inch phone type)
Digital In Connectors (Coaxial type, Optical type)
Digital Out Connectors (Coaxial type, Optical type)
Foot Switch Jack (1/4inch phone type)
PS/2 Mouse Connector (6-pin miniDIN)
PS/2 Keyboard Connector (6-pin miniDIN)
VGA Out Connector (15-pin miniD-sub)
R-BUS Connector (25-pin D-sub)
Master Out Jack L/R (1/4inch phone type, TRS balanced)

Monitor Out Jack L/R (1/4inch phone type, TRS balanced)
AUX A Send Jack L/R (1/4inch phone type, TRS balanced)
AUX B Send Jack L/R (1/4inch phone type, TRS balanced)
Headphones Jack (Stereo 1/4inch phone type)

Power Supply

AC117 V, AC230 V or AC240 V

Power Consumption

60 W

Dimensions

480 (W) x 481 (D) x 136 (H) mm
18-15/16 (W) x 18-15/16 (D) x 5-3/8 (H) inches

Weight

10.5 kg
23 lbs 3 oz

Accessories

Owner's Manual English
Appendices
R-BUS Equipment Connection and Setting Guide 2
Block diagram
Demo CD
CD-R disc
PS/2 Mouse
Shortcut Seal
AC Cord

Options

24-bit Effect Expansion Board: VS8F-2
Level Meter Bridge: MB-24
Bi-amp Monitor: DS-90A, DS-50A
10CH Digital Line Mixer: M-1000
Mic Modeling Preamp: MMP-2
Dynamic Microphone: DR-20
R-BUS Cable: RBC-1 (1 m) / RBC-3 (3 m)
Footswitch: FS-5U (BOSS)
Pedal Switch: DP-2

(0dBu=0.775Vrms)

* In the interest of product development, the specifications for this product are subject to change without prior notice.

Index

Numerics

10-Band Graphic Equalizer	91
2ch RSS	70
3band Isolator	87
4-Band Parametric Equalizer	90

A

Aborted Command!	16
algorithm	6
Analog Flanger	68
Analog Phaser	66
Analyzer	18, 37
Arbitration Failed!	16
ATA	18
ATAPI	18
Attenuator	6
audio cable	5
Auto Punch/Loop Parameter	35
AUTOMIX	
Event Memory Full!	17
Automix	36
AUX1-8 FX1-4	29

B

Bass	42
Blank Disc	16

C

Can't Communicate!	16
Can't record CD!	16
Can't Set Marker!	16
Cannot write in "Track at Once" format on CD-RW Disc! 16	
CD-R	18
CD-R disc	7
CD-R/RW drive	6
CD-RW	18
CD-RW Memory Full!	17
CH EDIT	27, 29
CH EDIT/SELECT/AUTOMIX STATUS buttons ...	21
Channel fader	5
Check Condition!	16
Chorus	41
Chorus RSS	62
Clear Partition	38
Compact Disc Recordable	18
Compact Disc ReWritable	18
Composite Object Sound Modeling	18
Compressor	18
Control Change messages	4
COSM	18
Current Project	18

D

DAT	18
Delay	40, 52
Delay RSS	56

Device ID	4
DIGITAL In Lock	16
DIGITAL In Unlock Change to Internal Clock?	16
Digital Signal Processing	18
Disk Memory Full!	17
Drive Busy!	16
Drive Not Ready!	16
Drive Status Error!	16
Drive Time-out!	16
Drive Unformatted!	17
DSP	18
Dual Compressor/Limiter	88
Dynamics	18

E

Effect Return	29
Event Memory Full!	17
events	5
Exceeding limit of RSS PAN Channels!	16
Exclusive messages	4
Expander	18

F

F1 (PtnEdt)	35
F1 (R-BUS)	37
F1 (SCENE)	36
F1 (SYSTEM)	31
F1 (TEMPO)	34
F2 (A.MIX)	36
F2 (GLOBAL)	32
F2 (Metro)	34-35
F2 (NEW)	38
F2 (RSSPan)	38
F3 (A.P/LP)	35
F3 (ClrPrt)	38
F3 (MkPart)	38
F3 (Proj)	32
F3 (Surrnd)	36
F4 (OscAna)	37
F4 (PlyRec)	33
F4 (PROTEC)	38
F5 (BlkDmp)	33
F5 (MIDI)	33
F6 (PrmIni)	37
F6 (SYNC)	34
F6 (V.FDR)	35
Finalize	18
Finalized CD!	16
Flanger	41
Formants	18
Format Drive	38
Found Illegal Phrase Pair!	16
Found Illegal Track Pair!	16
Frame	19
FX Board for RSS PAN is not installed!	17
FX RTN	29

G	
Gate Reverb	40, 50
Gated Reverb	6
General Purpose Interface	19
Global Parameter	32
GPI	19
Graphic Equalizer	43, 91
Guitar	42
GUITAR (Hi-Z)	19
Guitar Amp Modeling	42, 76
Guitar Multi 1	74
Guitar Multi 2	74
Guitar Multi 3	74
H	
Hardware Error!	17
Hum Canceler	92
I	
IDE	19
IEC	19
Illegal Phrase Pair!	16
Illegal Request!	16
Illegal Track Pair!	16
Illegal Track!	17
IN	25
IN 1-12	25
IN 13-16	25
Input Mixer	25
Integrated Device and Electronics	19
Invalid Disc!	17
L	
Lack Of Event!	17
Lack of IDE Memory!	17
Limiter	19
LOCATOR/SCENE buttons	22
Lo-Fi Processor	86
M	
MARKER Memory Full!	17
Master Block	29
MASTER CLOCK	6
MASTER EDIT	29
Master fader	5
Mastering Tool Kit	6, 44, 97
Medium Error!	17
Message Error!	16
Metronome Drum Pattern Edit	35
Metronome Parameter	34
Mic Modeling	41
Microphone Modeling	72
MIDI	
Bulk Dump	33
channels	4
connectors	4
Implementation Chart	4
IN	4
messages	4
OUT	4
Parameter	33
sequencer	7
THRU	4
MIDI Machine Control	19
MIDI messages	
Control Change messages	4
Exclusive messages	4
Note messages	4
MIDI Time Code	19
MMC	19
MONITOR knob	5
MTC	19
Multi Tap Delay	58
Musical Instrument Digital Interface	4
Mute	5
N	
No Data to Write	17
Not 44.1kHz Project!	17
Note messages	4
note number	4
NTSC Format	19
O	
Operation Canceled!	17
Operation Failed!	17
Oscillator	19, 37
P	
PAL Formats	20
Parameter Initialize	37
Parametric Equalizer	43, 90
Phantom Power	19
Phase Mismatch!	16
Phaser	41
PHONES knob	5
Phrase	
Delete	6
Pink noise	19
Pitch Shifter	41
Play/Recording Parameter	33
Preset Patch List	
Bass	42
Chorus	41
Delay	40
Flanger	41
Gate Reverb	40
Graphic Equalizer	43
Guitar	42
Guitar Amp Modeling	42
Mastering Tool Kit	44
Mic Modeling	41
Parametric Equalizer	43
Phaser	41
Pitch Shifter	41

- Reverb 40
 Reverb2 40
 Same as Algorithm 39
 Special Effects 43
 Stereo Multi 43
 Tape Echo 201 41
 Vocal 42
 Project
 Optimize 6
 Project New 38
 Project Parameter 32
 Project Protect 38
 Project Protected! 17
 PS/2 Keyboard 19
 PS/2 Mouse 19
- R**
- R-BUS 20
 R-BUS Configuration 37
 R-BUS Lock 16
 R-BUS Unlock Change to Internal Clock? 16
 Region
 Cut 6
 Erase 6
 Reverb 6, 40, 46
 Reverb2 40, 48
 Rotary 69
 RSS 20
 RSS PAN Setup 38
- S**
- Same as Algorithm 39
 Scene 36
 SCMS 20
 SECAM Formats 20
 Shutdown 20
 Sine wave 20
 SMPTE time code 20
 Solo 5
 Space Chorus 63
 Speaker Modeling 95
 Special Effects 43
 St Phaser 67
 STATUS indicator 5
 StDly-Chorus 60
 Stereo Flanger 67
 Stereo Multi 43, 93
 Stereo Phaser 64
 Stereo Pitch Shifter Delay 54
 Surround 36
 Sync Parameter 34
 System Parameter 31
- T**
- Tape Echo 201 41, 57
 Tempo Map 34
 time compression 6
 time expansion 6
- TOC 20
 TOC Read Error! 17
 Too Many Markers! 17
 TR 27
 TR 1-12 27
 TR 13-16 27
 Track 0 Not Found! 17
 Track Minutes 20
 Track Mixer 27
 Track Sheet 145
 TRACK STATUS buttons 21
 Transport Control buttons 21
- U**
- Undefined Sense! 16
 Unknown Drive Error! 16
- V**
- V.Fader 35
 VARI PITCH 6
 velocity 4
 VGA 20
 Vocal 42
 Vocal Canceler 81
 Vocal Multi 78
 Vocoder 83
 Vocoder2 (19) 6, 84
 Voice Transformer 6, 80
 VS8F-2 6
- W**
- Write Protected! 17

Information

When you need repair service, call your nearest Roland Service Center or authorized Roland distributor in your country as shown below.

AFRICA

EGYPT

Al Fanny Trading Office
9, EBN Hagar A1 Askalany Street,
ARD El Golf, Heliopolis,
Cairo 11341, EGYPT
TEL: 20-2-417-1828

REUNION

Maison FO - YAM Marcel
25 Rue Jules Hermann,
Chaudron - BP79 97 491
Ste Clotilde Cedex,
REUNION ISLAND
TEL: (0262) 218-429

SOUTH AFRICA

That Other Music Shop(PTY)Ltd.
11 Melle St., Braamfontein,
Johannesbourg,
SOUTH AFRICA
TEL: (011) 403 4105
FAX: (011) 403 1234

Paul Bothner(PTY)Ltd.

Royal Cape Park, Unit 24
Londonderry Road, Ottery 7800
Cape Town, SOUTH AFRICA
TEL: (021) 799 4900

ASIA

CHINA

Roland Shanghai Electronics Co.,Ltd.
5F, No.1500 Pingliang Road
Shanghai 200090, CHINA
TEL: (021) 5580-0800

Roland Shanghai Electronics Co.,Ltd.

(BEIJING OFFICE)
10F, No.18 3 Section Anhuaxili
Chaoyang District Beijing
100011 CHINA
TEL: (010) 6426-5050

Roland Shanghai Electronics Co.,Ltd.

(GUANGZHOU OFFICE)
2/F., No.30 Si You Nan Er Jie
Yi Xiang, Wu Yang Xin Cheng,
Guangzhou 510600, CHINA
TEL: (020) 8736-0428

HONG KONG

Tom Lee Music Co., Ltd.
Service Division
22-32 Pun Shan Street, Tsuen
Wan, New Territories,
HONG KONG
TEL: 2415 0911

Parsons Music Ltd.

8th Floor, Railway Plaza, 39
Chatham Road South, T.S.T.,
Kowloon, HONG KONG
TEL: 2333 1863

INDIA

Rivera Digitec (India) Pvt. Ltd.
409, Nirman Kendra
Mahalaxmi Flats Compound
Off. Dr. Edwin Moses Road,
Mumbai-400011, INDIA
TEL: (022) 2493 9051

INDONESIA

PT Citra IntiRama
Jl. Cideng Timur No. 15J-150
Jakarta Pusat
INDONESIA
TEL: (021) 6324170

KOREA

Cosmos Corporation
1461-9, Seocho-Dong,
Seocho Ku, Seoul, KOREA
TEL: (02) 3486-8855

MALAYSIA

Roland Asia Pacific Sdn. Bhd.
45-1, Block C2, Jalan PJU 1/39,
Dataran Prima, 47301 Petaling
Jaya, Selangor, MALAYSIA
TEL: (03) 7805-3263

PHILIPPINES

G.A. Yupango & Co. Inc.
339 Gil J. Puyat Avenue
Makati, Metro Manila 1200,
PHILIPPINES
TEL: (02) 899 9801

SINGAPORE

SWEE LEE MUSIC COMPANY PTE. LTD.
150 Sims Drive,
SINGAPORE 387381
TEL: 6846-3676

TAIWAN

ROLAND TAIWAN ENTERPRISE CO., LTD.
Room 5, 9fl. No. 112 Chung
Shan N.Road Sec.2, Taipei,
TAIWAN, R.O.C.
TEL: (02) 2561 3339

THAILAND

Theera Music Co., Ltd.
330 Soi Verng NakornKasem,
New Road, Sumpantawongse,
Bangkok 10100, THAILAND
TEL: (02) 224-8821

VIETNAM

SAIGON MUSIC DISTRIBUTOR (TAN DINH MUSIC)
138 Tran Quang Khai Street
Dist. 1, Ho Chi Minh City
VIETNAM
TEL: (08) 848-4068

AUSTRALIA/ NEW ZEALAND

**AUSTRALIA/
NEW ZEALAND
Roland Corporation
Australia Pty.,Ltd.**
38 Campbell Avenue
Dee Why West. NSW 2099
AUSTRALIA

For Australia

TEL: (02) 9982 8266
For New Zealand

TEL: (09) 3098 715

CENTRAL/LATIN AMERICA

ARGENTINA

Instrumentos Musicales S.A.
Av. Santa Fe 2055
(1123) Buenos Aires
ARGENTINA
TEL: (011) 4508-2700

BARBADOS

A&B Music Supplies LTD
12 Webster Industrial Park
Wilkey, St.Michael, Barbados
TEL: (246)430-1100

BRAZIL

Roland Brasil Ltda.
Rua San Jose, 780 Sala B
Parque Industrial San Jose
Cotia - Sao Paulo - SP, BRAZIL
TEL: (011) 4615 5666

CHILE

Comercial Fancy II S.A.
Rut: 96.919.420-1
Nataaniel Cox #739, 4th Floor
Santiago - Centro, CHILE
TEL: (02) 688-9540

COLOMBIA

Centro Musical Ltda.
Cra 43 B No 25 A 41 Bododega 9
Medellin, Colombia
TEL: (574)3812529

COSTA RICA

JUAN Bansbach Instrumentos Musicales
Ave.1. Calle 11, Apartado 10237,
San Jose, COSTA RICA
TEL: 258-0211

CURACAO

Zeelandia Music Center Inc.
Orionweg 30
Curacao, Netherland Antilles
TEL:(305)5926866

DOMINICAN REPUBLIC

Instrumentos Fernando Giraldez
Calle Proyecto Central No.3
Ens.La Esperilla
Santo Domingo,
Dominican Republic
TEL:(809) 683 0305

ECUADOR

Mas Musica
Rumichaca 822 y Zaruma
Guayaquil - Ecuador
TEL:(593-4)2302364

EL SALVADOR

OMNI MUSIC
75 Avenida Norte y Final
Alameda Juan Pablo II,
Edificio No.4010 San Salvador,
EL SALVADOR
TEL: 262-0788

GUATEMALA

Casa Instrumental
Calzada Roosevelt 34-01,zona 11
Ciudad de Guatemala
Guatemala
TEL:(502) 599-2888

HONDURAS

Almacen Pajaro Azul S.A. de C.V.
BO.Paz Barahona
3 Ave.11 Calle S.O
San Pedro Sula, Honduras
TEL: (504) 553-2029

MARTINIQUE

Musique & Son
Z.I.Les Mangle
97232 Le Lamantin
Martinique F.W.I.
TEL: 596 596 426860

Gigamusic SARI

10 Rte De La Folie
97200 Fort De France
Martinique F.W.I.
TEL: 596 596 715222

MEXICO

Casa Veerkamp, s.a. de c.v.
Av. Teluca No. 323, Col. Olivara
de los Padres 01780 Mexico
D.F. MEXICO
TEL: (55) 5668-6699

NICARAGUA

Bansbach Instrumentos Musicales
Municipalidad
Altamira D'Este Calle Principal
de la Farmacia 5ta.Avenida
1 Cuadra al Lago.#503
Managua, Nicaragua
TEL: (505)277-2557

PANAMA

SUPRO MUNDIAL, S.A.
Boulevard Andrews, Albrook,
Panama City, REP. DE
PANAMA
TEL: 315-0101

PARAGUAY

Distribuidora De Instrumentos Musicales
J.E. Olear y ESQ. Manduvara
Asuncion PARAGUAY
TEL: (595) 21 492147

PERU

Audionet
Distribuciones Musicales SAC
Juan Fanning 530
Miraflores
Lima - Peru
TEL: (511) 4461388

TRINIDAD

AMR Ltd
Ground Floor
Maritime Plaza
Barataria Trinidad W.I.
TEL: (868) 638 6385

URUGUAY

Todo Musica S.A.
Francisco Acuna de Figueroa
1771
C.P.: 11.800
Montevideo, URUGUAY
TEL: (02) 924-2335

VENEZUELA

Instrumentos Musicales Allegro,C.A.
Av.las industrias edf.Guitar import
#7 zona Industrial de Turumo
Caracas, Venezuela
TEL: (212) 244-1122

EUROPE

AUSTRIA

Roland Elektronische Musikinstrumente HmbH.
Austrian Office
Eduard-Bodem-Gasse 8,
A-6020 Innsbruck, AUSTRIA
TEL: (0512) 26 44 260

BELGIUM/FRANCE/ HOLLAND/ LUXEMBOURG

Roland Central Europe N.V.
Houtstraat 3, B-2260, Oevel
(Westerlo) BELGIUM
TEL: (014) 575811

CZECH REP.

K-AUDIO
Kardasovska 626,
CZ-198 00 Praha 9,
CZECH REP.
TEL: (2) 666 10529

DENMARK

Roland Scandinavia A/S
Nordhavnsvej 7, Postbox 880,
DK-2100 Copenhagen
DENMARK
TEL: 3916 6200

FINLAND

Roland Scandinavia As, Filial Finland
Elanontie 5
FIN-01510 Vantaa, FINLAND
TEL: (09) 68 24 020

GERMANY

Roland Elektronische Musikinstrumente HmbH.
Oststrasse 96, 22844
Norderstedt, GERMANY
TEL: (040) 52 60090

GREECE

STOLLAS S.A.
Music Sound Light
155, New National Road
Patras 26442, GREECE
TEL: 2610 435400

HUNGARY

Roland East Europe Ltd.
Warehouse Area 'DEPO' Pf.83
H-2046 Torokbalint,
HUNGARY
TEL: (23) 511011

IRELAND

Roland Ireland
G2 Calmount Park, Calmount
Avenue, Dublin 12
Republic of IRELAND
TEL: (01) 4294444

ITALY

Roland Italy S. p. A.
Viale delle Industrie 8,
20020 Aresse, Milano, ITALY
TEL: (02) 937-78300

NORWAY

Roland Scandinavia Avd.
Kontor Norge
Lilleakerveien 2 Postboks 95
Lilleaker N-0216 Oslo
NORWAY
TEL: 2273 0074

POLAND

MX MUSIC SP.Z.O.O.
UL. Gibraltar 4,
PL-03664 Warszawa POLAND
TEL: (022) 679 44 19

PORTUGAL

Roland Iberia, S.L.
Portugal Office
Cais das Pedras, 8/9-1 Dto
4050-465, Porto, PORTUGAL
TEL: 22 608 00 60

ROMANIA

FBS LINES
Piata Libertatii 1,
535500 Gheorgheni,
ROMANIA
TEL: (266) 364 609

RUSSIA

MuTek
Dorozhnaya ul.3,korp.6
117 545 Moscow, RUSSIA
TEL: (095) 981-4967

SPAIN

Roland Iberia, S.L.
Paseo Garcia Faria, 33-35
08005 Barcelona SPAIN
TEL: 93 493 91 00

SWEDEN

Roland Scandinavia A/S
SWEDISH SALES OFFICE
Danvik Center 28, 2 tr.
S-131 30 Nacka SWEDEN
TEL: (08) 702 00 20

SWITZERLAND

Roland (Switzerland) AG
Landstrasse 5, Postfach,
CH-4452 Itingen,
SWITZERLAND
TEL: (061) 927-8383

UKRAINE

TIC-TAC
Mira Str. 19/108
P.O. Box 180
295400 Munkachevo,
UKRAINE
TEL: (03131) 414-40

UNITED KINGDOM

Roland (U.K.) Ltd.
Atlantic Close, Swansea
Enterprise Park, SWANSEA
SA7 9FJ,
UNITED KINGDOM
TEL: (01792) 702701

MIDDLE EAST

BAHRAIN

Moon Stores
No.16, Bab Al Bahrain Avenue,
P.O.Box 247, Manama 304,
State of BAHRAIN
TEL: 17 211 005

CYPRUS

Radex Sound Equipment Ltd.
17, Diagorou Street, Nicosia,
CYPRUS
TEL: (022) 66-9426

IRAN

MOCO INC.
No.41 Nike St., Dr.Shariyati Ave.,
Roberoye Cerah Mirdamad
Tehran, IRAN
TEL: (021) 285-4169

ISRAEL

Halilit P. Greenspoon & Sons Ltd.
8 Retzif Ha'aliya Hashnya St.
Tel-Aviv-Yafo ISRAEL
TEL: (03) 6823666

JORDAN

MUSIC HOUSE CO. LTD.
FREDDY FOR MUSIC
P. O. Box 922846
Amman 11192 JORDAN
TEL: (06) 5692696

KUWAIT

EASA HUSAIN AL-YOUSIFI & SONS CO.
Abdullah Salem Street,
Safat, KUWAIT
TEL: 243-6399

LEBANON

Chahine S.A.L.
Gerge Zeidan St., Chahine
Bldg., Achrafieh, P.O.Box: 16-
5857
Beirut, LEBANON
TEL: (01) 20-1441

OMAN

TALENTZ CENTRE L.L.C.
Malatan House No.1
Al Noor Street, Ruwi
SULTANATE OF OMAN
TEL: 2478 3443

QATAR

Al Emadi Co. (Badie Studio & Stores)
P.O. Box 62, Doha, QATAR
TEL: 4423-554

SAUDI ARABIA

aDawlah Universal Electronics APL
Corniche Road, Aldossary
Bldg., 1st Floor, Alkhobar,
SAUDI ARABIA

P.O.Box 2154, Alkhobar 31952

SAUDI ARABIA
TEL: (03) 898 2081

SYRIA

Technical Light & Sound Center
Rawda, Abdul Qader Jazairi St.
Bldg. No. 21, P.O.BOX 13520,
Damascus, SYRIA
TEL: (011) 223-5384

TURKEY

ZUHAL DIS TICARET A.S.
Galip Dede Cad. No.37
Beyoglu - Istanbul / TURKEY
TEL: (0212) 249 85 10

U.A.E.

Zak Electronics & Musical Instruments Co. L.L.C.
Zabeel Road, Al Sherook Bldg.,
No. 14, Grand Floor, Dubai,
U.A.E.
TEL: (04) 3360715

NORTH AMERICA

CANADA

Roland Canada Music Ltd.
(Head Office)
5480 Parkwood Way
Richmond B. C., V6V 2M4
CANADA
TEL: (604) 270 6626

Roland Canada Music Ltd.

(Toronto Office)
170 Admiral Boulevard
Mississauga On L5T 2N6
CANADA
TEL: (905) 362 9707

U. S. A.

Roland Corporation U.S.
5100 S. Eastern Avenue
Los Angeles, CA 90040-2938,
U. S. A.
TEL: (323) 890 3700

Copyright

- Unauthorized recording, distribution, sale, lending, public performance, broadcasting, or the like, in whole or in part, of a work (musical composition, video, broadcast, public performance, or the like) whose copyright is held by a third party is prohibited by law.
- When exchanging audio signals through a digital connection with an external instrument, this unit can perform recording without being subject to the restrictions of the Serial Copy Management System (SCMS). This is because the unit is intended solely for musical production, and is designed not to be subject to restrictions as long as it is used to record works (such as your own compositions) that do not infringe on the copyrights of others. (SCMS is a feature that prohibits second-generation and later copying through a digital connection. It is built into MD recorders and other consumer digital-audio equipment as a copyright-protection feature.)
- Do not use this unit for purposes that could infringe on a copyright held by a third party. Roland assumes no responsibility whatsoever with regard to any infringements of third-party copyrights arising through your use of this unit.

About the License Agreement

- The VS-2400CD and its CD-R capability are designed to allow you to reproduce material to which you have copyright, or material which the copyright owner has granted you permission to copy. Accordingly, reproduction of Music CD or other copyrighted material without permission of the copyright owner avoiding technical prohibiting features of second-generation and later copying like SCMS or others constitutes copyright infringement and may incur penalties even in case such reproduction is for your own personal use and enjoyment (private use). Consult a copyright specialist or special publications for more detailed information on obtaining such permission from copyright holders.

- Microsoft and Windows are registered trademarks of Microsoft Corporation.
- Apple and Macintosh are registered trademarks of Apple Computer, Inc.
- Dolby is a registered trademark of Dolby Laboratories.
- DTS is a registered trademark of Digital Theater Systems, Inc.
- All product names mentioned in this document are trademarks or registered trademarks of their respective owners.



This product must be disposed of separately at your local waste recycling centre. Do not dispose of in household waste bin.



* 0 3 1 2 1 5 6 7 - 0 7 *

03121567 '06-03-7KS