

Errata

We apologize for the following errors in the V-Synth XT Owner's Manual. Please make the corrections listed below.

P.41 Step 6

(Incorrect)

 To save your patch, use the procedure described in "Saving Patches (PATCH Write)" (p. 53).

(Correct)

 To save your patch, use the procedure described in "Saving Patches (PATCH Write)" (p. 53) and "**Saving Project on Disk (Save Project)**" (p. 132).

P.78 right column Step 6

(Incorrect)

 Save your patch as described in "Saving Patches (PATCH Write)" (p. 75).

(Correct)

 Save your patch as described in "Saving Patches (PATCH Write)" (p. 75) and "**Saving Project on Disk (Save Project)**" (p. 132).

P.125 left column "Clock Source"

(Incorrect)

Value

INTERNAL: The Patch Tempo will be used.

EXTERNAL: Synchronize to the clock of an external sequencer.

(Correct)

Value

INT: The Patch Tempo will be used.

MIDI: Synchronize to the clock of an external MIDI.

USB MIDI: Synchronize to the clock of an external USB MIDI.

P.129 right column "KBD Output"

(Incorrect)

KBD Output (V-LINK Keyboard Output Fade Switch)

Specifies whether the video output from the video device will be stopped (ON) or will not be stopped (OFF) when you are not holding down a key.

Value: OFF, ON

(Correct)

Delete

P.156 "Common Group" table MIDI/USB - Clock Source

(Incorrect)

| Parameter | Value |
|--------------|--------------------|
| Clock Source | INTERNAL, EXTERNAL |

(Correct)

| Parameter | Value |
|--------------|---------------------|
| Clock Source | INT, MIDI, USB MIDI |

For the latest information about MIDI Implementation, please visit

<http://www.roland.com/>

お詫びと訂正

「V-Synth XT 取扱説明書」の内容に誤りがありましたので、ここに謹んでお詫び申し上げますとともに、次のように訂正させていただきます。

P.42 手順 6

(誤)

 「パッチを保存する (PATCH Write)」 (P.53) の手順で保存してください。

(正)

 「パッチを保存する (PATCH Write)」 (P.53) と「**プロジェクトをディスクに保存する (Save Project)**」 (P.133) の手順で保存してください。

P.78 右段 手順 6

(誤)

 「パッチを保存する (PATCH Write)」 (P.75) の手順で保存してください。

(正)

 「パッチを保存する (PATCH Write)」 (P.75) と「**プロジェクトをディスクに保存する (Save Project)**」 (P.133) の手順で保存してください。

P.125 左段 「Clock Source (クロック・ソース)」

(誤)

設定値

INTERNAL: パッチ・テンポに合わせます。

EXTERNAL: 外部シーケンサーのクロックに合わせます。

(正)

設定値

INT: パッチ・テンポに合わせます。

MIDI: 外部 MIDI のクロックに合わせます。

USB MIDI: 外部 USB MIDI のクロックに合わせます。

P.156 表 「Common グループ」 MIDI / USB - Clock Source

(誤)

| パラメーター | 設定値 |
|--------------|-----------------------------|
| Clock Source | クロック・ソース INTERNAL, EXTERNAL |

(正)

| パラメーター | 設定値 |
|--------------|------------------------------|
| Clock Source | クロック・ソース INT, MIDI, USB MIDI |

MIDI インプリメンテーションに関する最新情報は、ローランドの Web サイトをご覧ください

<http://www.roland.co.jp/>

V-Synth XT

OWNER'S MANUAL

Thank you, and congratulations on your choice of the Roland V-Synth XT.

Before using this unit, carefully read the sections entitled: "IMPORTANT SAFETY INSTRUCTIONS" (p. 2), "USING THE UNIT SAFELY" (p. 3), and "IMPORTANT NOTES" (p. 4). These sections provide important information concerning the proper operation of the unit. Additionally, in order to feel assured that you have gained a good grasp of every feature provided by your new unit, Owner's manual and Sound List should be read in its entirety. These manuals should be saved and kept on hand as a convenient reference.



- * Microsoft and Windows are registered trademarks of Microsoft Corporation.
- * Windows® is known officially as: "Microsoft® Windows® operating system."
- * Apple and Macintosh are registered trademarks of Apple Computer, Inc.
- * Mac OS is a trademark of Apple Computer, Inc.
- * SmartMedia is a trademark of Toshiba Corp.
- * OMS is a registered trademark of Opcode Systems, Inc.
- * FreeMIDI is a trademark of Mark of the Unicorn, Inc.
- * All product names mentioned in this document are trademarks or registered trademarks of their respective owners.



Copyright © 2005 ROLAND CORPORATION

All rights reserved. No part of this publication may be reproduced in any form without the written permission of ROLAND CORPORATION.

WARNING: To reduce the risk of fire or electric shock, do not expose this apparatus to rain or moisture.

| |
|--|
|    ATTENTION: RISQUE DE CHOC ELECTRIQUE NE PAS OUVRIR |
| CAUTION: TO REDUCE THE RISK OF ELECTRIC SHOCK, DO NOT REMOVE COVER (OR BACK). NO USER-SERVICEABLE PARTS INSIDE. REFER SERVICING TO QUALIFIED SERVICE PERSONNEL. |



The lightning flash with arrowhead symbol, within an equilateral triangle, is intended to alert the user to the presence of uninsulated "dangerous voltage" within the product's enclosure that may be of sufficient magnitude to constitute a risk of electric shock to persons.



The exclamation point within an equilateral triangle is intended to alert the user to the presence of important operating and maintenance (servicing) instructions in the literature accompanying the product.

INSTRUCTIONS PERTAINING TO A RISK OF FIRE, ELECTRIC SHOCK, OR INJURY TO PERSONS.

IMPORTANT SAFETY INSTRUCTIONS SAVE THESE INSTRUCTIONS

WARNING - When using electric products, basic precautions should always be followed, including the following:

1. Read these instructions.
2. Keep these instructions.
3. Heed all warnings.
4. Follow all instructions.
5. Do not use this apparatus near water.
6. Clean only with a dry cloth.
7. Do not block any of the ventilation openings. Install in accordance with the manufacturers instructions.
8. Do not install near any heat sources such as radiators, heat registers, stoves, or other apparatus (including amplifiers) that produce heat.
9. Do not defeat the safety purpose of the polarized or grounding-type plug. A polarized plug has two blades with one wider than the other. A grounding type plug has two blades and a third grounding prong. The wide blade or the third prong are provided for your safety. If the provided plug does not fit into your outlet, consult an electrician for replacement of the obsolete outlet.
10. Protect the power cord from being walked on or pinched particularly at plugs, convenience receptacles, and the point where they exit from the apparatus.
11. Only use attachments/accessories specified by the manufacturer.
12. Unplug this apparatus during lightning storms or when unused for long periods of time.
13. Refer all servicing to qualified service personnel. Servicing is required when the apparatus has been damaged in any way, such as power-supply cord or plug is damaged, liquid has been spilled or objects have fallen into the apparatus, the apparatus has been exposed to rain or moisture, does not operate normally, or has been dropped.

For the U.K.

WARNING: THIS APPARATUS MUST BE EARTHED

IMPORTANT: THE WIRES IN THIS MAINS LEAD ARE COLOURED IN ACCORDANCE WITH THE FOLLOWING CODE.
GREEN-AND-YELLOW: EARTH, BLUE: NEUTRAL, BROWN: LIVE

As the colours of the wires in the mains lead of this apparatus may not correspond with the coloured markings identifying the terminals in your plug, proceed as follows:

The wire which is coloured GREEN-AND-YELLOW must be connected to the terminal in the plug which is marked by the letter E or by the safety earth symbol  or coloured GREEN or GREEN-AND-YELLOW.

The wire which is coloured BLUE must be connected to the terminal which is marked with the letter N or coloured BLACK.

The wire which is coloured BROWN must be connected to the terminal which is marked with the letter L or coloured RED.

USING THE UNIT SAFELY

INSTRUCTIONS FOR THE PREVENTION OF FIRE, ELECTRIC SHOCK, OR INJURY TO PERSONS

About ⚠ WARNING and ⚠ CAUTION Notices

| | |
|------------------|--|
| ⚠ WARNING | Used for instructions intended to alert the user to the risk of death or severe injury should the unit be used improperly. |
| ⚠ CAUTION | Used for instructions intended to alert the user to the risk of injury or material damage should the unit be used improperly. * Material damage refers to damage or other adverse effects caused with respect to the home and all its furnishings, as well to domestic animals or pets. |

About the Symbols

| | |
|--|--|
| | The ⚠ symbol alerts the user to important instructions or warnings. The specific meaning of the symbol is determined by the design contained within the triangle. In the case of the symbol at left, it is used for general cautions, warnings, or alerts to danger. |
| | The ⓧ symbol alerts the user to items that must never be carried out (are forbidden). The specific thing that must not be done is indicated by the design contained within the circle. In the case of the symbol at left, it means that the unit must never be disassembled. |
| | The ● symbol alerts the user to things that must be carried out. The specific thing that must be done is indicated by the design contained within the circle. In the case of the symbol at left, it means that the power-cord plug must be unplugged from the outlet. |

ALWAYS OBSERVE THE FOLLOWING

⚠ WARNING







- Before using this unit, make sure to read the instructions below, and the Owner's Manual.
- Connect mains plug of this model to a mains socket outlet with a protective earthing connection.
- Do not open or perform any internal modifications on the unit.
- Do not attempt to repair the unit, or replace parts within it (except when this manual provides specific instructions directing you to do so). Refer all servicing to your retailer, the nearest Roland Service Center, or an authorized Roland distributor, as listed on the "Information" page.
- Never use or store the unit in places that are:
 - Subject to temperature extremes (e.g., direct sunlight in an enclosed vehicle, near a heating duct, on top of heat-generating equipment); or are
 - Damp (e.g., baths, washrooms, on wet floors); or are
 - Humid; or are
 - Exposed to rain; or are
 - Dusty; or are
 - Subject to high levels of vibration.
- This unit should be used only with a rack or stand that is recommended by Roland.
- When using the unit with a rack or stand recommended by Roland, the rack or stand must be carefully placed so it is level and sure to remain stable. If not using a rack or stand, you still need to make sure that any location you choose for placing the unit provides a level surface that will properly support the unit, and keep it from wobbling.
- The unit should be connected to a power supply only of the type described in the operating instructions, or as marked on the rear side of unit.
- Use only the attached power-supply cord. Also, the supplied power cord must not be used with any other device.
- Do not excessively twist or bend the power cord, nor place heavy objects on it. Doing so can damage the cord, producing severed elements and short circuits. Damaged cords are fire and shock hazards!
- This unit, either alone or in combination with an amplifier and headphones or speakers, may be capable of producing sound levels that could cause permanent hearing loss. Do not operate for a long period of time at a high volume level, or at a level that is uncomfortable. If you experience any hearing loss or ringing in the ears, you should immediately stop using the unit, and consult an audiologist.

⚠ WARNING





- Do not allow any objects (e.g., flammable material, coins, pins); or liquids of any kind (water, soft drinks, etc.) to penetrate the unit.
- Immediately turn the power off, remove the power cord from the outlet, and request servicing by your retailer, the nearest Roland Service Center, or an authorized Roland distributor, as listed on the "Information" page when:
 - The power-supply cord, or the plug has been damaged; or
 - If smoke or unusual odor occurs
 - Objects have fallen into, or liquid has been spilled onto the unit; or
 - The unit has been exposed to rain (or otherwise has become wet); or
 - The unit does not appear to operate normally or exhibits a marked change in performance.
- In households with small children, an adult should provide supervision until the child is capable of following all the rules essential for the safe operation of the unit.
- Protect the unit from strong impact. (Do not drop it!)
- Do not force the unit's power-supply cord to share an outlet with an unreasonable number of other devices. Be especially careful when using extension cords—the total power used by all devices you have connected to the extension cord's outlet must never exceed the power rating (watts/ampères) for the extension cord. Excessive loads can cause the insulation on the cord to heat up and eventually melt through.
- Before using the unit in a foreign country, consult with your retailer, the nearest Roland Service Center, or an authorized Roland distributor, as listed on the "Information" page.
- DO NOT play a CD-ROM disc on a conventional audio CD player. The resulting sound may be of a level that could cause permanent hearing loss. Damage to speakers or other system components may result.
- Do not put anything that contains water (e.g., flower vases) on this unit. Also, avoid the use of insecticides, perfumes, alcohol, nail polish, spray cans, etc., near the unit. Swiftly wipe away any liquid that spills on the unit using a dry, soft cloth.

USING THE UNIT SAFELY

⚠ CAUTION

- The unit should be located so that its location or position does not interfere with its proper ventilation. 
- Always grasp only the plug on the power-supply cord when plugging into, or unplugging from, an outlet or this unit. 
- At regular intervals, you should unplug the power plug and clean it by using a dry cloth to wipe all dust and other accumulations away from its prongs. Also, disconnect the power plug from the power outlet whenever the unit is to remain unused for an extended period of time. Any accumulation of dust between the power plug and the power outlet can result in poor insulation and lead to fire. 
- Try to prevent cords and cables from becoming entangled. Also, all cords and cables should be placed so they are out of the reach of children. 
- Never climb on top of, nor place heavy objects on the unit. 
- Never handle the power cord or its plugs with wet hands when plugging into, or unplugging from, an outlet or this unit. 

⚠ CAUTION

- Before moving the unit, disconnect the power plug from the outlet, and pull out all cords from external devices. 
- Before cleaning the unit, turn off the power and unplug the power cord from the outlet (p. 54). 
- Whenever you suspect the possibility of lightning in your area, pull the plug on the power cord out of the outlet. 
- Keep any screws you may remove and the included screws in a safe place out of children's reach, so there is no chance of them being swallowed accidentally. 
- Always turn the phantom power off when connecting any device other than condenser microphones that require phantom power. You risk causing damage if you mistakenly supply phantom power to dynamic microphones, audio playback devices, or other devices that don't require such power. Be sure to check the specifications of any microphone you intend to use by referring to the manual that came with it. 

(This instrument's phantom power: 48 V DC, 10 mA Max)

IMPORTANT NOTES

In addition to the items listed under "IMPORTANT SAFETY INSTRUCTIONS" and "USING THE UNIT SAFELY" on pages 2–4, please read and observe the following:

Power Supply

- Do not connect this unit to same electrical outlet that is being used by an electrical appliance that is controlled by an inverter (such as a refrigerator, washing machine, microwave oven, or air conditioner), or that contains a motor. Depending on the way in which the electrical appliance is used, power supply noise may cause this unit to malfunction or may produce audible noise. If it is not practical to use a separate electrical outlet, connect a power supply noise filter between this unit and the electrical outlet.
- Before connecting this unit to other devices, turn off the power to all units. This will help prevent malfunctions and/or damage to speakers or other devices.
- Although the LCD and LEDs are switched off when the POWER switch is switched off, this does not mean that the unit has been completely disconnected from the source of power. If you need to turn off the power completely, first turn off the POWER switch, then unplug the power cord from the power outlet. For this reason, the outlet into which you choose to connect the power cord's plug should be one that is within easy reach and readily accessible.

Placement

- Using the unit near power amplifiers (or other equipment containing large power transformers) may induce hum. To alleviate the problem, change the orientation of this unit; or move it farther away from the source of interference.
- This device may interfere with radio and television reception. Do not use this device in the vicinity of such receivers.
- Noise may be produced if wireless communications devices, such as cell phones, are operated in the vicinity of this unit. Such noise could occur when receiving or initiating a call, or while conversing. Should you experience such problems, you should relocate such wireless devices so they are at a greater distance from this unit, or switch them off.

- When moved from one location to another where the temperature and/or humidity is very different, water droplets (condensation) may form inside the unit. Damage or malfunction may result if you attempt to use the unit in this condition. Therefore, before using the unit, you must allow it to stand for several hours, until the condensation has completely evaporated.

Maintenance

- For everyday cleaning wipe the unit with a soft, dry cloth or one that has been slightly dampened with water. To remove stubborn dirt, use a cloth impregnated with a mild, non-abrasive detergent. Afterwards, be sure to wipe the unit thoroughly with a soft, dry cloth.
- Never use benzine, thinners, alcohol or solvents of any kind, to avoid the possibility of discoloration and/or deformation.

Repairs and Data

- Please be aware that all data contained in the unit's memory may be lost when the unit is sent for repairs. Important data should always be backed up on a memory card, or written down on paper (when possible). During repairs, due care is taken to avoid the loss of data. However, in certain cases (such as when circuitry related to memory itself is out of order), we regret that it may not be possible to restore the data, and Roland assumes no liability concerning such loss of data.

Additional Precautions

- You cannot detach the V-Synth XT's rack-mounting hardware from the main unit. Also, you must never loosen any screws other than the "rotation lock hardware" (P.19). Doing so will cause malfunctions.
- Before you transport the V-Synth XT, you must install the included "rotation lock hardware." The unit may be damaged if you transport it without the "rotation lock hardware" installed (p. 19).
- Please be aware that the contents of memory can be irretrievably lost as a result of a malfunction, or the improper operation of the unit. To protect yourself against the risk of losing important data, we recommend that you periodically save a backup copy of important data you have stored in the unit's memory on a memory card.
- Unfortunately, it may be impossible to restore the contents of data that was stored in the unit's memory, on a memory card, or in another MIDI device (e.g., a sequencer) once it has been lost. Roland Corporation assumes no liability concerning such loss of data.
- Use a reasonable amount of care when using the unit's buttons, sliders, or other controls; and when using its jacks and connectors. Rough handling can lead to malfunctions.
- Never strike or apply strong pressure to the display.
- When connecting / disconnecting all cables, grasp the connector itself—never pull on the cable. This way you will avoid causing shorts, or damage to the cable's internal elements.
- A small amount of heat will radiate from the unit during normal operation.
- To avoid disturbing your neighbors, try to keep the unit's volume at reasonable levels. You may prefer to use headphones, so you do not need to be concerned about those around you (especially when it is late at night).
- When you need to transport the unit, package it in the box (including padding) that it came in, if possible. Otherwise, you will need to use equivalent packaging materials.
- Use a cable from Roland to make the connection. If using some other make of connection cable, please note the following precautions.
 - Some connection cables contain resistors. Do not use cables that incorporate resistors for connecting to this unit. The use of such cables can cause the sound level to be extremely low, or impossible to hear. For information on cable specifications, contact the manufacturer of the cable.

Compatibility of patches created on an older version of V-Synth

- Be aware that if patches created on a V-Synth with a system version older than 2.0 (i.e., versions 1.00 through 1.51 of the system) use preset PCM waves, those patches will not play correctly on version 2.0.

- Patches that use a PCM oscillator
 - Patches that use preset waves
 - ✗ Not compatible
 - ✗ Will NOT play correctly in version 2.0
 - Patches that use user waves
 - Upwardly compatible
 - Can be imported and played in version 2.0
 - Patches that use an analog oscillator
 - Patches that use an external input oscillator
 - Upwardly compatible
 - Can be imported and played in version 2.0

Before Using Cards

Using Memory Cards

- Carefully insert the DATA card all the way in—until it is firmly in place.
- Never touch the terminals of the memory card. Also, avoid getting the terminals dirty.
- Memory cards are constructed using precision components; handle the cards carefully, paying particular note to the following.
 - To prevent damage to the cards from static electricity, be sure to discharge any static electricity from your own body before handling the cards.
 - Do not touch or allow metal to come into contact with the contact portion of the cards.
 - Do not bend, drop, or subject cards to strong shock or vibration.
 - Do not keep cards in direct sunlight, in closed vehicles, or other such locations (storage temperature: -25 to 85° C).
 - Do not allow cards to become wet.
 - Do not disassemble or modify the cards.

Handling CD-ROMs

- Avoid touching or scratching the shiny underside (encoded surface) of the disc. Damaged or dirty CD-ROM discs may not be read properly. Keep your discs clean using a commercially available CD cleaner.

Copyright

- Unauthorized recording, distribution, sale, lending, public performance, broadcasting, or the like, in whole or in part, of a work (musical composition, video, broadcast, public performance, or the like) whose copyright is held by a third party is prohibited by law.
- When exchanging audio signals through a digital connection with an external instrument, this unit can perform recording without being subjected to some of the restrictions of the Serial Copy Management System (SCMS). This is because the unit is intended solely for musical production, and is designed not to be subject to restrictions as long as it is used to record works (such as your own compositions) that do not infringe on the copyrights of others. (SCMS is a feature that prohibits second-generation and later copying through a digital connection. It is built into MD recorders and other consumer digital-audio equipment as a copyright-protection feature.)
- Do not use this unit for purposes that could infringe on a copyright held by a third party. We assume no responsibility whatsoever with regard to any infringements of third-party copyrights arising through your use of this unit.

How To Use This Manual

This owner's manual is organized as follows.

For details on all the patches and waves that the V-Synth XT contains, refer to the separate "Sound List."

Quick Start (p. 17)

This chapter offers a basic introduction to the V-Synth XT, and provides simple, easy-to-understand explanations, allowing the beginner to quickly experience many of the V-Synth XT's exciting features. As you read the Quick Start, we recommend actually performing the described operations on your V-Synth XT. This'll help you understand most of what you need to know for basic operations.

Reference (p. 55)

Overview of the V-Synth XT

This explains the structure of the V-Synth XT, and basic operation. Reading it is essential for understanding V-Synth XT operational procedures.

Playing in Patch Mode

This explains how to play the V-Synth XT in Patch mode. Reading it is essential for understanding V-Synth XT operational procedures.

Creating a Patch

This chapter explains how to create patches, and describes what the patch parameters do and how they are composed. Read this chapter when you wish to create patches.

Creating a Rhythm Kit (Rhythm Mode)

This chapter explains how to create a Rhythm Kit.

Creating and Editing Samples (Sample Mode)

This explains how to sample, and how to edit and encode samples. Read this when you want to sample sounds.

Settings Common to All Modes (System Mode)

This chapter describes how the System parameters that determine the V-Synth XT's operation environment work and how these parameters are organized. Read it as necessary.

Disk-Related Functions (Disk Mode)

This chapter covers disk-related operations such as saving data to disk and loading data from disk. Read it as necessary.

Transferring Data (USB Mode)

This explains how to connect the V-Synth XT to your computer, and transfer data such as patches and waves. Read this as necessary.

Other Functions

This explains how to transmit data to an external MIDI device (Data Transfer), and how to restore all data of the V-Synth XT to the factory settings (Factory Reset). Read it as necessary.

Appendices (p. 149)

This chapter contains a troubleshooting section for use when the V-Synth XT is not functioning as expected. There is also a list of messages that you can refer to if an message appears on the display. A list of parameters and a MIDI implementation chart are also provided.

Notation Used in This Owner's Manual

To make operation procedures easy to understand, the following notation system is adopted:

Characters and graphics in square brackets [] indicate buttons and knobs on the front panel. For example, [MODE] indicates the MODE button, and [▲], [▼], [◀], and [▶] indicates the cursor buttons.

Text or graphics enclosed in <> indicate objects in the screen (touch screen) that can be touched using your finger. The manual will instruct you to "touch" the object shown in the touch screen.

(p. **) refers to pages within the manual.

Below are the meanings of the symbols preceding certain sentences in the text.



These are notes. Be sure to read them.



These are reference memos. Read it as necessary.



These are hints for operating the V-Synth XT. Read it as necessary.



These provide information from related reference pages. Read it as necessary.



The display screens printed in this owner's manual are based on the factory settings. However, please be aware that in some cases they may differ from the actual factory settings.



Please be aware that in the screen shots printed in this manual, the patch names may differ from the factory settings.

Separate booklet: V-Card owner's manual

The Roland "V-Card" series software VC-1 and VC-2 are preinstalled in the V-Synth XT. For details on how to use the VC-1 "D-50" and VC-2 "Vocal Designer," refer to the separate "V-Card owner's manual."

Contents

| | |
|---|-----------|
| How To Use This Manual | 6 |
| Notation Used in This Owner's Manual..... | 6 |
| Main Features | 12 |
| Panel Descriptions | 14 |
| Front Panel..... | 14 |
| Rear Panel..... | 16 |

Quick Start 17

| | |
|---|-----------|
| Getting Ready | 18 |
| Placing the V-Synth XT..... | 18 |
| Connecting an Amp and Speaker System..... | 20 |
| Turning On the Power..... | 21 |
| Starting up V-Card..... | 22 |
| Adjusting the Display Contrast (LCD Contrast)..... | 22 |
| Installing the PC Card Protector..... | 23 |
| Basic Touch Screen Operation | 24 |
| Enabling/Disabling the Beep Tone..... | 24 |
| Moving the Cursor..... | 25 |
| Editing a Value..... | 26 |
| Using the numeric keys for input..... | 27 |
| Try Out the Sounds | 28 |
| Selecting Patches and Playing Sounds..... | 28 |
| Playing a Patch on the V-Synth XT from an External MIDI Device (MIDI Keyboard)..... | 29 |
| Selecting Patches from the List..... | 29 |
| Selecting Favorite Patches (Patch Palette)..... | 30 |
| Playing a drum set (Rhythm mode)..... | 31 |
| Try Out the Various Performance Features | 32 |
| Manipulating Sounds with the Time Trip Pad..... | 32 |
| Using Knobs to Modify the Sound in Realtime (E1–E8 knobs)..... | 34 |
| Playing Arpeggios (Arpeggiator)..... | 36 |
| Using steps to vary the sound (Multi Step Modulator)..... | 38 |
| Holding the notes you play (Key Hold)..... | 39 |
| Creating a Patch | 40 |
| Creating a patch intuitively (Sound Shaper)..... | 40 |
| Initializing Patch Settings..... | 42 |
| Selecting a Structure Type..... | 43 |
| Switching Each Section On/Off..... | 45 |
| Setting Up the Oscillators (OSC1/2)..... | 46 |
| Mixing/Modulating Two Sounds (Mod)..... | 47 |
| Applying COSM Modeling to Oscillators (COSM1/2)..... | 48 |
| Shaping a Sound's Volume Over Time (TVA)..... | 49 |
| Adding the V-Synth XT Effects..... | 50 |
| Saving Patches You've Created..... | 51 |
| Turning Off the Power..... | 54 |

Reference55

| | |
|--|-----------|
| Overview of the V-Synth XT | 56 |
| How the V-Synth XT Is Organized | 56 |
| Basic Structure | 56 |
| Polyphony | 56 |
| About Multitimbral Performance | 56 |
| Memory | 57 |
| Memory Structure | 57 |
| Basic Operation of the V-Synth XT | 58 |
| Changing Operating Modes ([MODE]) | 58 |
| Playing in Patch Mode..... | 60 |
| About the PATCH PLAY Screen..... | 60 |
| Displaying PATCH PLAY Screen..... | 60 |
| Selecting a Patch | 60 |
| Selecting Favorite Patches (Patch Palette) | 61 |
| Selecting Patches by Category..... | 61 |
| Selecting Patches from the List..... | 62 |
| Playing Single Notes (Mono)..... | 63 |
| Creating Smooth Pitch Changes (Portamento) | 63 |
| Making Controller-related Settings (Control) | 63 |
| Playing Arpeggios (Arpeggiator)..... | 64 |
| Holding an Arpeggio..... | 64 |
| Making Arpeggiator Settings | 65 |
| Creating an Original Arpeggio Pattern (Pattern Edit)..... | 65 |
| Using steps to vary the sound (Multi Step Modulator) | 68 |
| Applying Various Effects to the Sound | 69 |
| Applying an Effect by Touching Your Finger to the Pad (Time Trip Pad)..... | 69 |
| Applying an Effect by Turning a Knob (E1–E8 knobs) | 70 |
| Synchronizing Music and Video While You Play the V-Synth XT (V-LINK) | 71 |
| Enter V-LINK Mode | 71 |
| V-LINK Functions that the V-Synth XT Can Control and MIDI Messages..... | 71 |
| Creating a Patch..... | 72 |
| How to Make the Patch Settings | 72 |
| Initializing Patch Settings (PATCH Init) | 73 |
| Copying Patch Settings (PATCH Copy) | 73 |
| Naming a Patch (PATCH Name)..... | 74 |
| Assigning the Category of a Patch..... | 74 |
| Saving Patches (PATCH Write)..... | 75 |
| Auditioning the Save-Destination Patch (Compare) | 76 |
| Registering a Favorite Patch (Patch Palette) | 76 |
| Deleting Patches (PATCH Delete) | 77 |
| Creating a patch intuitively (Sound Shaper)..... | 77 |
| Functions of Patch Parameters | 79 |
| Settings Common to the Entire Patch (Common) | 79 |
| Modifying Waveforms (OSC1/OSC2) | 86 |
| Mixing/Modulating Two Sounds (MOD)..... | 93 |
| Applying Various Effects to Each Note You Play (COSM1/COSM2) | 93 |
| Adjusting the Volume and Pan (TVA)..... | 94 |
| Making Envelope Settings | 95 |
| Making LFO Settings | 96 |
| Setting Effects for a Patch (Effect)..... | 97 |
| Zone Settings (Zone)..... | 99 |
| Splitting the Keyboard to Play Different Sounds (Split) | 99 |
| Creating a Drum Patch (Drum)..... | 101 |

| | |
|--|------------|
| Creating a Rhythm Kit (Rhythm Mode) | 102 |
| The concept of a Rhythm Kit | 102 |
| Playing in Rhythm mode | 102 |
| Creating a Rhythm Kit..... | 103 |
| Creating and Editing Samples (Sample Mode)..... | 104 |
| Sampling..... | 104 |
| Settings Before You Sample (What Is a Template?) | 104 |
| Sampling Procedure | 105 |
| Resampling..... | 109 |
| Setup Settings | 109 |
| Pre-Effect Settings | 110 |
| Metronome Settings..... | 111 |
| Checking Sample Information..... | 112 |
| Importing a Sample..... | 113 |
| Editing a Sample..... | 113 |
| Common Procedure for Editing..... | 113 |
| Editing the Specified Region of the Sample | 115 |
| Loop Region Settings..... | 117 |
| Original Tempo Setting..... | 118 |
| Converting the Sample to V-Synth XT Data (Encode)..... | 118 |
| Selecting the Encoding Type | 119 |
| Automatically Detecting Events | 120 |
| Deleting and Adding Events | 120 |
| Saving a Sample..... | 121 |
| Settings Common to All Modes (System Mode) | 122 |
| How to Make the System Function Settings..... | 122 |
| Saving the System Settings (Write)..... | 122 |
| Initializing the System Settings (Init) | 122 |
| Functions of System Parameters | 123 |
| Settings Common to the Entire System (Common) | 123 |
| Controller Settings (Controller) | 127 |
| V-LINK Settings (V-LINK) | 129 |
| Disk-Related Functions (Disk Mode)..... | 131 |
| About Disk Utility | 131 |
| Basic Disk Utility Operations..... | 131 |
| Sorting the Files Displayed in the File List..... | 132 |
| Loading a Project from Disk into the V-Synth XT (Load Project) | 132 |
| Saving Project on Disk (Save Project) | 132 |
| Delete Unneeded Files (Clean Project) | 133 |
| Importing Individual Patch or Wave Files (Import Files) | 133 |
| Initializing a Disk (Format)..... | 134 |
| Functions Related to Files and Folders (Tools) | 135 |
| Copying Files/Folders (Copy) | 135 |
| Moving Files/Folders (Move) | 135 |
| Deleting Files/Folders (Delete)..... | 136 |
| Renaming a Files/Folders (Rename) | 137 |
| Connecting to Your Computer via USB (USB Mode)..... | 138 |
| About USB Functions..... | 138 |
| Driver Installation and Settings..... | 138 |
| Exchanging MIDI Messages with Your Computer (MIDI function) | 138 |
| USB audio signal flow (USB audio device function)..... | 138 |
| Transferring Files to or from Your Computer (Storage Function) | 139 |
| Windows Users | 139 |
| Macintosh Users | 141 |
| Examples of Using Storage Function..... | 143 |

| | |
|--|------------|
| Using V-Synth Librarian | 145 |
| Features of V-Synth Librarian | 145 |
| Installation..... | 145 |
| Other Functions | 146 |
| Transmitting Data to an External MIDI Device (Data Transfer) | 146 |
| Reset to Default Factory Settings (Factory Reset)..... | 147 |
| Viewing Various Information (Info)..... | 147 |
| Adjusting the Sensitivity of the Touch Screen (Calibration Mode) | 148 |
| Adjusting the Sensitivity of the Touch Screen | 148 |

Appendices 149

| | |
|---|------------|
| Parameter List | 150 |
| Patch Parameters | 150 |
| System Parameters | 156 |
| COSM List..... | 159 |
| COSM Parameters | 159 |
| Overdrive / Distortion..... | 159 |
| Wave Shape..... | 159 |
| Amp Simulator | 160 |
| Speaker Simulator | 160 |
| Resonator..... | 160 |
| 1st order SideBandFilter..... | 160 |
| 2nd order SideBandFilter | 161 |
| Comb Filter | 161 |
| Dual Filter..... | 161 |
| TVF | 162 |
| Dynamic TVF..... | 162 |
| Polyphonic Compressor..... | 162 |
| Polyphonic Limiter | 162 |
| Frequency Shifter | 163 |
| Lo-Fi Processor | 163 |
| TB Filter | 163 |
| Effects List..... | 164 |
| MFX Parameters | 164 |
| 01: Parametric EQ (Parametric Equalizer)..... | 165 |
| 02: Graphic EQ (Graphic Equalizer)..... | 165 |
| 03: Resonant Filter | 165 |
| 04: Isolator and Filter | 166 |
| 05: Distortion / OD (Distortion / Overdrive)..... | 166 |
| 06: Amp Simulator (Guitar Amp Simulator) | 167 |
| 07: Auto Wah | 168 |
| 08: Humanizer | 168 |
| 09: Dynamic Processor (Stereo Dynamic Processor)..... | 169 |
| 10: Tape Echo Simulator..... | 169 |
| 11: Stereo Delay | 170 |
| 12: Multi Tap Delay..... | 171 |
| 13: Reverse Delay | 171 |
| 14: Vocal Echo..... | 172 |
| 15: Band Pass Delay | 172 |
| 16: Analog Delay -> Chorus | 173 |
| 17: Digital Chorus | 173 |
| 18: Space Chorus | 174 |
| 19: Hexa Chorus | 174 |

| | |
|--|------------|
| 20: Analog Flanger | 174 |
| 21: BOSS Flanger | 175 |
| 22: Step Flanger | 175 |
| 23: Analog Phaser..... | 176 |
| 24: Digital Phaser..... | 176 |
| 25: Rotary..... | 177 |
| 26: Tremolo/ Auto Pan | 177 |
| 27: Stereo Pitch Shifter..... | 178 |
| 28: OD/DS -> Cho/Flg (Overdrive/Distortion -> Chorus/Flanger)..... | 178 |
| 29: OD/DS -> Delay (Overdrive/Distortion -> Delay) | 179 |
| 30: Cho/Flg -> Delay (Chorus/Flanger -> Delay) | 179 |
| 31: Enh -> Cho/Flg (Enhancer -> Chorus/Flanger) | 180 |
| 32: Enh -> Delay (Enhancer -> Delay)..... | 180 |
| 33: Vocal Multi..... | 181 |
| 34: Guitar Multi | 181 |
| 35: Bass Multi | 182 |
| 36: EP Multi..... | 183 |
| 37: Keyboard Multi | 183 |
| 38: Phonograph..... | 184 |
| 39: Radio Tuning | 185 |
| 40: Bit Rate Converter | 185 |
| 41: Pseudo Stereo..... | 185 |
| Chorus Parameters | 186 |
| Chorus Type..... | 186 |
| Chorus Parameters..... | 186 |
| Reverb Parameters | 186 |
| 01: Room 1 | 187 |
| 02: Room 2 | 187 |
| 03: Room 3 | 188 |
| 04: Hall 1 | 188 |
| 05: Hall 2 | 189 |
| 06: Hall 3 | 189 |
| 07: Garage..... | 190 |
| 08: PLATE..... | 190 |
| 09: Non-Linear | 191 |
| 10: Delay | 191 |
| Troubleshooting..... | 193 |
| Problems Related to the V-Synth XT | 193 |
| Problems Related to the USB Driver (Windows)..... | 194 |
| Problems Related to the USB Driver (Macintosh) | 196 |
| Message List | 197 |
| ERROR Screens | 197 |
| WARNING Screens..... | 198 |
| Message Boxes | 199 |
| About MIDI | 200 |
| About MIDI Connectors..... | 200 |
| MIDI Channels and Multi-timbral Sound Generators..... | 200 |
| MIDI Implementation Chart..... | 201 |
| Specifications..... | 202 |
| Index..... | 203 |

Main Features

The V-Synth XT is a professional synthesizer with a sound generator section that represents a pooling of numerous proprietary Roland technologies, allowing an extremely high level of musical expressive potential.

From acoustic-like sounds to lush pads, rhythmical grooves, and aggressive sounds that could not be produced by synthesizers of the past, the V-Synth XT is able to create organic changes in the sound. Furthermore, the VC-1 and VC-2 “V-Card” series software expansions are preinstalled.

You can switch systems simply by pressing a single switch—there's no need for the bothersome routine of switching off the power, then switching it back on again. Thanks to the inclusion of this software, the V-Synth XT can be used as two other, completely different products; as a “D-50” and as a “Vocal Designer.”

Whether you're playing live on stage or producing music in the studio, and regardless of the musical styles in which you're working, the V-Synth XT gives you usable and playable sounds that are available nowhere else.

■ The V-Synth sound engine, producing utterly unique sounds

- The sound generator section consists of a PCM oscillator with VariPhrase capability, high-quality analog modeling oscillators, powerful modulators, and COSM processors equipped with sideband filters. You can specify how these sections are connected simply by selecting a structure. By combining these sections, each of which delivers powerful functionality, you can create completely new sounds, which could not be produced on any previous synthesizer.
- Each of the two oscillators can function as one of three types: PCM (VariPhrase), analog modeling, and external input. Dedicated envelopes are provided for the principal parameters of each oscillator. Even when using the oscillators alone, you can apply a wide range of time-based changes.
- The PCM oscillators utilize Roland's proprietary VariPhrase technology. In a revolutionary breakthrough in comparison to conventional waveform playback, VariPhrase allows the pitch, time, and formant of the audio material to be varied with complete independence in real time, while maintaining high audio quality. This transforms a PCM waveform into “elastic audio,” which you can freely stretch like a rubber band in the desired direction and create organic-sounding changes.
- The analog modeling oscillators are packed with high-quality waveforms, such as the “Super Saw,” which is just what you need for thick detuned textures; and a feedback oscillator, which produces a dramatically varying lead sound—all together giving you a total of fourteen waveforms to stimulate your musical creativity.
- The oscillator output can be processed by Roland's proprietary COSM processors. Going far beyond the filter functionality seen on typical synthesizers, these implement a wide range of processes. There are a total of 16 types, including TVF, guitar amp modeling, Lo-Fi processor, a sideband filter, which imparts a sense of playable pitch to noise or a phrase, and a resonator, which adds the body resonances of an instrument. You can also apply a COSM processor to an external audio input and use the V-Synth XT as a filter bank.

■ Sound Shaper function allows intuitive sound creation

- V-Synth XT features a Sound Shaper function, which liberates the musician from dealing with an overwhelming number of edit parameters. Simply choose the desired sound template from the list, and the parameters that are effective for that template will be selected and available for your control. You'll be able to obtain the desired variations easily by operating a few knobs or buttons to edit exactly what you need, just like a professional sound designer.

■ Unique and useful patches

- All sounds can be rewritten by the user down to the level of the source waves. You can sample directly into the V-Synth XT, or import WAV/AIFF files from external devices, making this an ideal instrument for the professional who insists on absolute originality.
- V-Synth XT provides a Rhythm mode screen, which lets you assign different V-Synth sounds to each note of the keyboard. This means that you can use the synth sound generator as a rhythm kit to play many types of sound from the keyboard. Since the sound assigned to each key is a fully editable V-Synth sound, you can have anything from an analog kick to VariPhrase rhythm loops available for immediate playing.

■ The power to make bold time-based changes in sound

- V-Synth XT provides a multi-step modulator, which lets you choose four parameters from a broad range of choices, and simultaneously modulate these parameters by completely different ascending or descending patterns. You can use the panel knobs to freely program the ascending or descending patterns, and you can even turn Smoothing on and use this as an LFO.
- VariPhrase waves can be freely controlled using the Time Trip function. By stroking the Time Trip pad in a circular motion, you can halt the progress of the waveform while the sound is still being heard, and then play that sound from the keyboard as the desired pitches. It's also easy to create distinctive effects such as manually controlling the progression of break-beats.
- All of the various functions that control time-based change can be synchronized to the tempo. VariPhrase, the LFO and envelope of each section, the programmable arpeggiator, the multi-step modulator, and the effects can all be controlled by the master tempo.

■ Hardware that meets the demands of the professional

- A unique design allows the V-Synth XT to be placed in a variety of locations; both table-top and rack-mounted use are possible. The design not only looks good, but is also highly practical.
- The V-Synth XT features a large color touch-screen, which provides a sophisticated user interface and guarantees easy editing of the displayed parameters. There are also eight editing knobs, which give you an “analog-feel” editing experience, and which can also be used as a general-purpose MIDI control surface.
- Both optical and coaxial digital audio jacks are provided. The output supports sample rates of 44.1 kHz, 48 kHz, and 96 kHz. The main out allows balanced output via TRS phone plugs.
- The front panel provides a mic input jack, which supports both XLR connectors and phone plugs. Phantom power can be supplied, and you can switch to high-impedance input, accommodating a variety of input sources from studio mics to electric guitars.
- The USB connector supports file transfer, MIDI communication, and audio streaming. A wide variety of data can be easily backed up to your computer via a USB connection, and you can even use the V-Synth XT as a USB audio converter for a broad range of applications.
- You can also store large amount of data using the PC card slot. Commercially available PC card adaptors allow you to use CompactFlash or SmartMedia cards.

■ “V-Card” series expansions are preinstalled

- The V-Synth XT comes with the VC-1 and VC-2 titles from Roland’s “V-Card” software series preinstalled. Without having to cycle power to the unit, you can simply press a single switch to transform the V-Synth XT into a completely different product (p. 22).
 - VC-1 “D-50” transforms the V-Synth XT into a sound module that’s equivalent to the Roland D-50 (a classic digital synthesizer that was released in 1987). Not just the preset patches, but every bit of functionality has been faithfully reproduced, giving you that distinctive D-50 sound with the stability of modern hardware.



For details on using VC-1 “D-50,” refer to the separate “V-Card owner’s manual.”

- VC-2 “Vocal Designer” transforms the V-Synth XT into a cutting-edge vocal modeling processor. By playing a keyboard while you speak into the mic, you can create beautiful and clearly intelligible human choruses as well as many other vocal-type sounds with unprecedented quality.



For details on using VC-2 “Vocal Designer,” refer to the separate “V-Card owner’s manual.”

What is VariPhrase?

VariPhrase has the following advantages:

- 1 Capable of changing the pitch, rate of time expansion/compression and voice characteristics (formant) on a real-time basis.
- 2 Allows easy synchronization to tempo and pitch.
- 3 A single sample covers an extended range of keys compared to conventional digital samplers.
- 4 Retains sound quality, while implementing the above three advantages.

VariPhrase overcomes many problems that conventional samplers and digital recorders have with audio phrases.

Typical issues with Digital Samplers and Digital recorders

- Changing tempo affects Pitch.
- Changing the pitch of phrases affects tempo and formant of the sound.
- Limited control of audio phrases. You cannot adjust a partial section of a sound in real-time.
- Most samplers require multiple samples over limited key ranges for realistic playback of a sound.
- Samples of the same tempo must be available for performing chords, otherwise the notes of the chord will be out of sync.
- Pitch or tempo changes on Digital samplers tends to degrade audio quality.

VariPhrase solves all of these problems.

Panel Descriptions

Front Panel

1 INPUT

Adjusts the volume of the signal input through the MIC jacks on the front panel. → (p. 106)

* This does not affect the rear panel INPUT jacks.

2 VOLUME

Adjusts the overall volume that is output from the MAIN OUT jacks and PHONES jack. → (p. 21)

3 MIC Jack

This is a mic jack for analog audio signal input.

It accommodates either XLR type or phone type plugs.

XLR type connections can provide 48V phantom power, allowing you to connect condenser mics that require phantom power. In this case, turn the mic switch to “PHANTOM ON.”

* The audio signal received via the MIC jack is switched on/off by the **MIC Jack Switch** (p. 126).

* This instrument is equipped with balanced (XLR/TRS) type jacks. Wiring diagrams for these jacks are shown below. Make connections after first checking the wiring diagrams of other equipment you intend to connect.

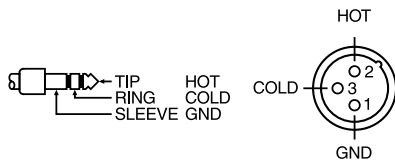

4 MIC Switch

This setting specifies the impedance and phantom power supply for the mic jack.

| | |
|-------------------|---|
| HI-Z | Choose the high impedance (Hi-Z) setting if you've connected a high-impedance device such as a guitar or bass to the phone-type input jack. |
| NORMAL | Choose the NORMAL setting if you've connected a low impedance device such as a mic to the phone-type input jack. |
| PHANTOM ON | Choose this setting if you need to supply phantom power to a mic connected to the XLR-type input jack. |

* The MIC switch does not affect the rear panel INPUT jacks.

* Always turn the phantom power off when connecting any device other than condenser microphones that require phantom power. You risk causing damage if you mistakenly supply phantom power to dynamic microphones, audio playback devices, or other devices that don't require such power. Be sure to check the specifications of any microphone you intend to use by referring to the manual that came with it. (This instrument's phantom power: 48 V DC, 10 mA Max)



5 USB Connector

This is a USB connector. You can connect it to your personal computer to send or receive files and MIDI messages (p. 138). Audio streaming is also supported.

6

[PEAK] (Peak Indicator)

This will light when the input volume is too high.

* This responds to either the front panel MIC jack or the rear panel INPUT jacks.

[MIDI] (MIDI indicator)

This will light when a MIDI message is received.

[USB] (USB indicator)

This will light when the V-Synth XT is connected via USB.

7 PHONES Jack

This is the jack for connecting headphones (sold separately). → (p. 20)

8 V-CARD Button

The Roland “V-Card” series software VC-1 and VC-2 are preinstalled in the V-Synth XT. You can switch between V-Synth/VC-1/VC-2 functionality simply by pressing the V-Card button (p. 22).



9 PREVIEW Button

Use this button to audition the patch.

10 KEY PAD Button

This button switches the function of the numeric keypad.

When lit:

- The numeric keypad will function as input keys.
→ **Using the numeric keys for input** (p. 27)

When unlit:

- The numeric keypad will function as a Patch Palette which lets you select your favorite patches.
→ **Selecting Favorite Patches (Patch Palette)** (p. 61)

11 Numeric Key

When the cursor is at an input location, you can use the numeric keypad to input parameter values (p. 27).

The keypad can also function as a Patch Palette that lets you select your favorite patches (p. 61).

12 LCD CONT (LCD CONTRAST) Knob

Adjusts the display contrast. → (p. 22)

13 Display

This displays information regarding the operation you are performing.

14 E1-E8 knobs

These knobs control the on-screen parameters in real time (p. 34).

MEMO

The parameters that are controlled by these knobs can be switched in the PATCH PLAY screen (p. 60) by holding down the [SHIFT] key and using the up/down [▲][▼] cursor buttons.

15 PC CARD Slot

A memory card can be inserted here.



For details on installing the included PC card protector, refer to p. 23.

16

VALUE Dial

This is used to modify values. If you hold down [SHIFT] as you turn the VALUE dial, the value will change in greater increments.

→ (p. 26)

Press the VALUE dial to perform the function of the ENTER button.

When the cursor is at an input location, you can press [ENTER] (VALUE dial) and use the numeric keys to enter a numeric value (p. 27).

[SHIFT]

This button is used in conjunction with other buttons to execute various functions.

[MODE]

Opens the Mode Menu window.

[CTRL]

This accesses the Control screen (p. 63). In the Control screen you use the "Time Trip" function (p. 69) which lets you apply various effects to the sound by touching the display. Additionally, this is also used for the External Control function (p. 63), which lets you use the E1-E8 knobs to control an external MIDI device; for the V-LINK function (p. 71), which lets you control a video device; and for switching the Arpeggio function on/off (p. 64).

[EXIT]

Return to the PLAY screen, or close the currently open window. In some screens, this causes the currently executing function to be aborted.

[DEC], [INC]

This is used to modify values. If you keep on holding down one button while pressing the other, the value change accelerates. If you press one of these buttons while holding down [SHIFT], the value will change in bigger increments. → (p. 26)

Panel Descriptions

[▲], [▼], [◀], [▶] (Cursor Buttons)

Moves the cursor location up/down/left/right. → (p. 25)

MEMO

In the PATCH PLAY screen (p. 60), you can hold down the [SHIFT] key and use the cursor up/down [▲] [▼] keys to alter the function of the E1–E8 knobs.

MEMO

By holding down the [SHIFT] key and using the cursor left/right ([◀] [▶]) keys you can switch the zone displayed in the upper right of the PATCH PLAY screen or EDIT screen (p. 99).



17 POWER Switch

Press to turn the power on/off. → (p. 21, p. 54)

Rear Panel

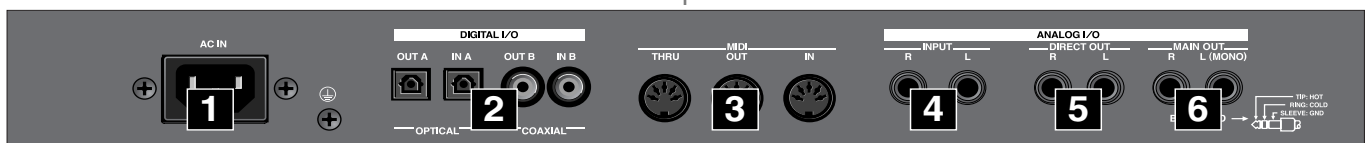

1 AC Inlet

Connect the included power cord to this inlet.

2 DIGITAL AUDIO INTERFACE Connector (OPTICAL IN/OUT, COAXIAL IN/OUT)

(conforming to IEC60958).

These connectors input/output a digital audio signal (stereo). The output signal is identical to the signal that is output from the MAIN OUT jacks.

3 MIDI Connectors (IN, OUT, THRU)

These connectors can be connected to other MIDI devices to receive and transmit MIDI messages.

4 INPUT Jacks (L, R)

An external audio source such as a CD player can be connected to these jacks for sampling or external input.

* The audio signal received via the INPUT jacks can be switched on/off by the **INPUT Jack Switch** (p. 126).

* The gain of the audio signal received via the INPUT jacks is adjusted by the **INPUT Jack Gain** (p. 126).

5 DIRECT OUT Jacks (L, R) (1/4 inch phone type)

This jack is a stereo output of the sound unprocessed by onboard effects. An external effects processor or other devices can be connected to these jacks.

6 MAIN OUT Jacks (L (MONO), R) (1/4 inch TRS phone type)

These jacks output the audio signal to the connected mixer/amplifier system in stereo. For mono output, use the L jack.

→ (p. 20)

Quick Start

Getting Ready

Placing the V-Synth XT

The V-Synth XT's unique design lets you use it either on a table or in a rack.

Table-top use

Place the V-Synth XT as shown.

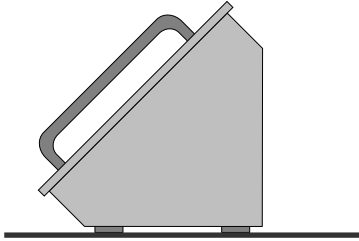

Rack-mount use

- 1 Install the V-Synth XT securely in a rack.

Use screws (sold separately) to mount the V-Synth XT securely in your rack (four locations).



You cannot detach the V-Synth XT's rack-mounting hardware from the main unit. Also, you must never loosen any screws other than the "rotation lock hardware." Doing so will cause malfunctions.

2

You can change the angle of the V-Synth XT while it is mounted in a rack.

Make sure that the V-Synth XT is securely installed in your rack. Then firmly grasp both of the front panel handles, and pivot it toward yourself until you hear a click.

To return the unit to its normal angle, push the handles inward until you hear the click.

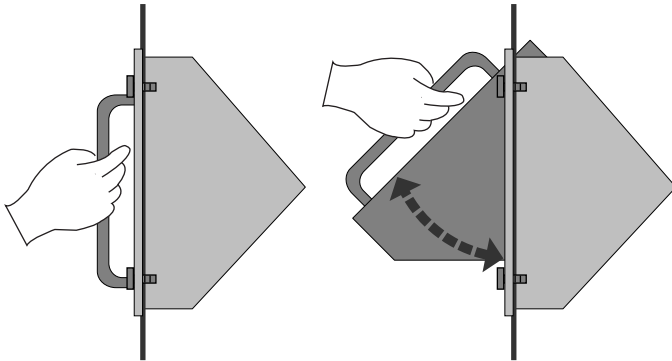

* You must perform this operation with the V-Synth XT installed in a rack.

* Some space above the V-Synth XT is required in order to use this rotating capability.

If equipment is installed in your rack directly above the V-Synth XT, you won't be able to perform this operation.

Installing the rotation-lock hardware

Before you transport the V-Synth XT, you must install the included "rotation lock hardware." The unit may be damaged if you transport it without the "rotation lock hardware" installed.

Use screws to fasten the "rotation lock hardware" as shown in the following illustration.



Connecting an Amp and Speaker System

Since the V-Synth XT contains no amplifier or speakers, you'll need to connect it to audio equipment such as a keyboard amplifier, monitor speaker system or home stereo, or use headphones to hear its sound.

Here we will explain example connections that use mainly the MAIN OUT jacks.

- 1 **Before hooking anything up, make sure that the power on all of your gear is turned OFF.**
- 2 **Connect one end of the supplied power cable to the V-Synth XT, and the other end to a power outlet.**
- 3 **Connect the V-Synth XT to your amp/speaker system.**

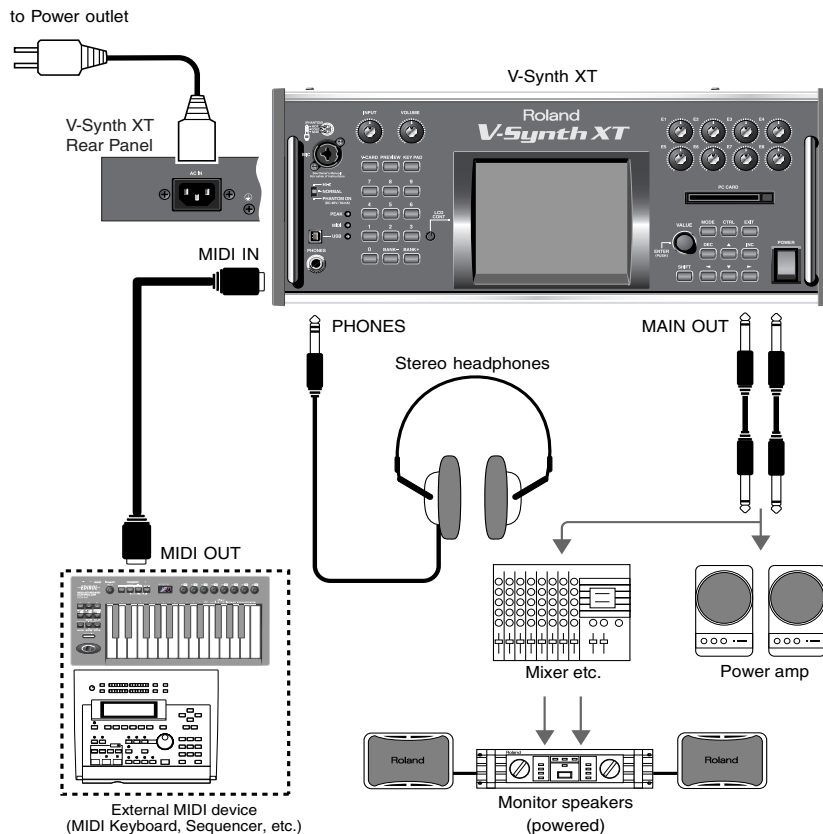

Use audio cables to connect audio equipment such as an amp or speakers. If you're using headphones, plug them into the PHONES jack.



**The unit should be connected to a power source only of the type marked on the rear panel of the unit.*

For details on the power consumption, refer to p. 202.

For details on the settings you need when connecting the V-Synth XT to your computer, refer to **“Connecting to Your Computer via USB (USB Mode)”** (p. 138)



To prevent malfunction and/or damage to speakers or other devices, always turn down the volume, and turn off the power on all devices before making any connections.



In order to fully experience the V-Synth XT's sound, we recommend using a stereo amp/speaker system. If you're using a mono system, however, make your connections to the V-Synth XT's MAIN OUT jack L (MONO).



Audio cables are not included with the V-Synth XT. You'll need to provide them.

Turning On the Power

- 1** Before turning on the V-Synth XT's power, consider these two questions:

 - Are all peripheral devices connected correctly?
 - Have the volume controls of the V-Synth XT and all connected audio devices been turned to their lowest settings?
- 2** Turn on the POWER switch located on the front panel of the V-Synth XT.

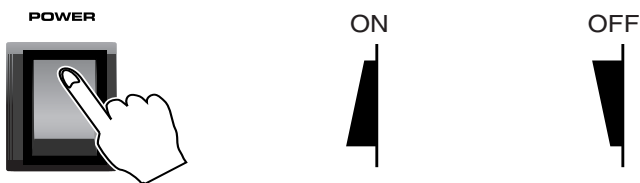

- 3** Turn on the power for any connected amplifiers or speakers.
- 4** Wait for the V-Synth XT to start up. When it has started up normally, a screen like the following will appear.

* When you turn on the power, the V-Card that was most recently started will start up (p. 22).

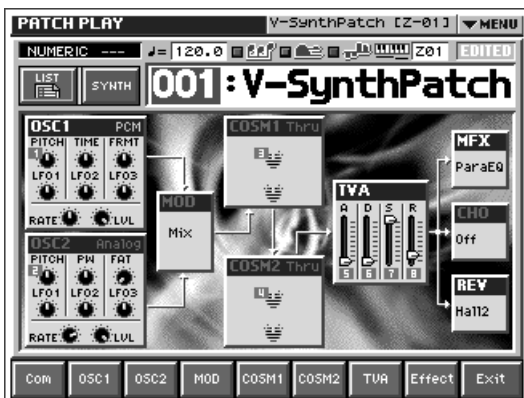

- 5** Set the volume for your connected amplifier and speakers. While playing the external MIDI keyboard, gradually raise the V-Synth XT's volume slider to the desired listening level.



NOTE

Once the connections have been completed (p. 18), turn on power to your various devices in the order specified. By turning on devices in the wrong order, you risk causing malfunctions and/or damage to speakers and other devices.

NOTE

This unit is equipped with a protection circuit. A brief interval (a few seconds) after power up is required before the unit will operate normally.

MEMO

While the V-Synth XT is starting up, the display will indicate "Processing..."

NOTE

Be careful not to set your listening volume too high to avoid damage to your amp/speaker system or your hearing.

HINT

In order to obtain the best audio quality from the V-Synth XT, we recommend that you set the V-Synth XT's volume to the maximum position, and adjust the volume appropriately on your amp or speaker system.

Starting up V-Card

You can press the [V-CARD] button to switch between V-Synth/VC-1/VC-2.

The Roland “V-Card” series VC-1 and VC-2 software is preinstalled in the V-Synth XT. By pressing a single switch, you can change between these functions without having to restart the unit, and use the V-Synth XT as a completely different product.

VC-1 “D-50” transforms the V-Synth XT into a sound module that’s equivalent to the Roland D-50 (a classic digital synthesizer that was released in 1987). Not just the preset patches, but every bit of functionality has been faithfully reproduced, giving you that distinctive D-50 sound with the stability of modern hardware.

VC-2 “Vocal Designer” transforms the V-Synth XT into a cutting-edge vocal modeling processor. By playing a keyboard while you speak into the mic, you can create beautiful and clearly intelligible human choruses as well as many other vocal-type sounds with unprecedented quality.

- 1 When the V-Synth XT has started up, press the [V-CARD] button, and in the screen that appears, touch the V-Card that you want to use.

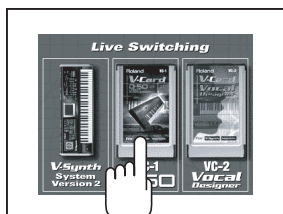

The V-Card startup screen will appear.

* By holding down the [V-CARD] button while you turn on the power, you can take a shortcut to the above screen when the V-Synth XT starts up.

- ☞ For details on how to use the VC-1 “D-50” and VC-2 “Vocal Designer,” refer to the separate “V-Card owner's manual.”

Adjusting the Display Contrast (LCD Contrast)

The characters in the display may be difficult to view immediately after turning on the V-Synth XT’s power or after extended use. Your viewing angle or the current lighting conditions can also affect the appearance of the display. In such situations, you can turn the LCD CONT knob to adjust the contrast of the display.

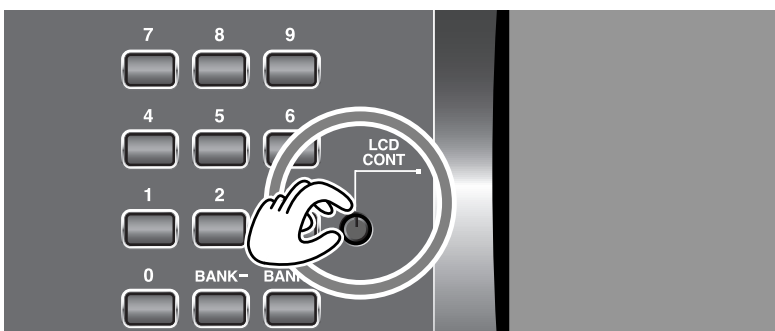

MEMO

When you turn on the power, the V-Card that was most recently started will start up.

NOTE

When you start up V-Card operation, any data that you were editing will be lost. If you've edited patches or system settings, be sure to save them first.

→“Saving Patches (PATCH Write)” (p. 75)

→“Saving the System Settings (Write)” (p. 122)

Installing the PC Card Protector

The V-Synth XT provides a PC card protector to prevent theft of the memory card. To install the PC card protector, use the following procedure.

- 1** Use a screwdriver to remove both of the screws from the bottom side of the PC CARD slot.
- 2** Insert the PC card into the PC CARD card slot.
- 3** Use the screws to fasten the PC card protector as shown below.

* Never insert or remove a memory card while this unit's power is on. Doing so may corrupt the unit's data or the data on the memory card.

* Carefully insert the memory card all the way in—until it is firmly in place.

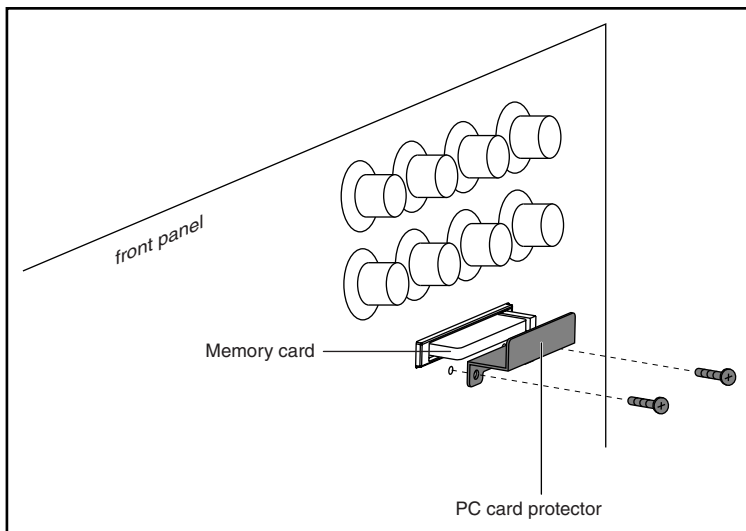

Basic Touch Screen Operation

The V-Synth XT features a touch screen. The touch screen lets you perform a variety of operations by lightly touching the screen.

** The touch screen responds to a light touch. Pressing the touch screen with too much force, or with a hard object, may damage it. Be careful not to apply excessive force, and touch it only with your finger.*

Enabling/Disabling the Beep Tone

You can specify whether or not a beep tone will be heard when you touch a valid point on the touch screen.

** At the factory setting, the beep tone will be sounded.*

- 1 In the upper right of the screen, touch <▼ MENU>.

A pulldown menu appears.

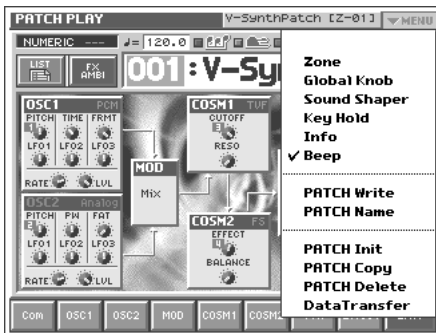

- 2 In the pulldown menu, touch <Beep> to add a check mark (✓).

With this setting, the beep tone will be heard. If you perform the same procedure once again, the check mark will be cleared and the beep tone will no longer be heard.

** If you have turned off the beep tone, a "∇" appears in the title area at the top of the screen when you touch a valid point on the touch screen.*

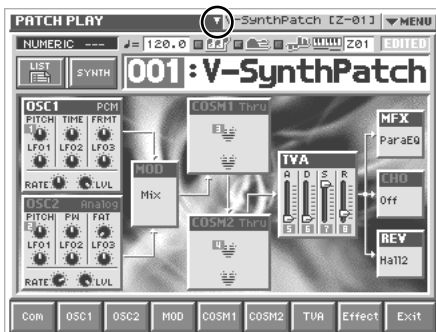

Moving the Cursor

A single screen or window displays multiple parameters or items for selection. To edit a parameter's value, move the cursor to the value. The cursor is a blue rectangle, and the parameter value or item you select with the cursor is highlighted (displayed in inverted colors).

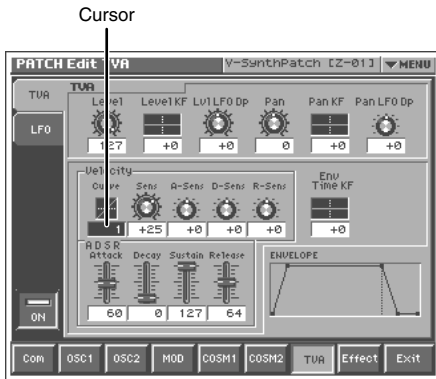

Cursor Buttons

Press [▲], [▼], [◀], or [▶] (the cursor buttons) to move the cursor.

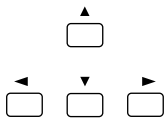

[▲]: moves the cursor up.

[▼]: moves the cursor down.

[◀]: moves the cursor to the left.

[▶]: moves the cursor to the right.

Touch Screen

Directly touch a parameter value to move the cursor.

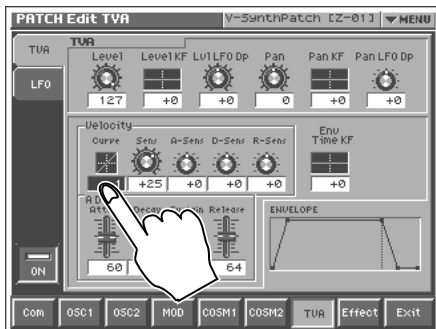

Editing a Value

To edit a value, you can use the VALUE dial, [INC] [DEC], or drag on the touch screen.

- In each V-Synth XT screen, you can select a value using the cursor as described earlier, and modify its value.
- Each parameter has its own range of possible values. You cannot set any value smaller than the minimum value or greater than the maximum value.

VALUE Dial

Turning the VALUE dial clockwise increases the value, and turning it counterclockwise decreases its value. Hold down [SHIFT] as you move the VALUE dial to increase value increments to make large value changes more quickly.

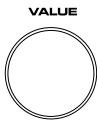

[INC] and [DEC]

Press [INC] to increase the selected value, and [DEC] to decrease it. Keep the button pressed for continuous adjustment. For faster value increases, keep [INC] pressed down and press [DEC]. To decrease values quickly, keep [DEC] pressed down and press [INC].



Touch Screen

Touch a parameter value, and drag your finger up/down or left/right. Dragging upward or to the right increases the value, and dragging downward or to the left decreases the value.

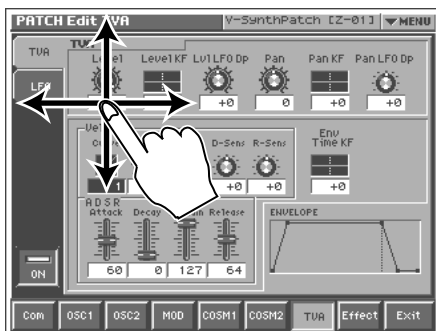

Using the numeric keys for input

Using the numeric keys to switch patch numbers

When the cursor is located at a patch number, you can use the numeric keys to switch patches.

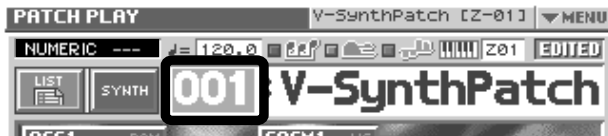

Input a numeric value in the input value area.

- [0]-[9] buttons: Input the patch number.
- [BANK-], [BANK+] buttons: These function as ENTER.

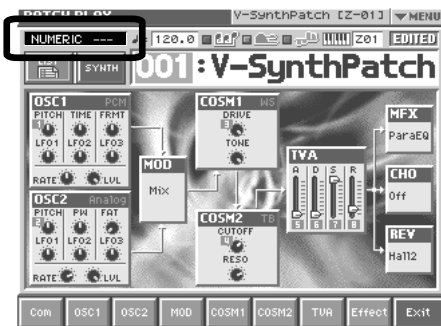

Using the numeric keys to input parameters

When the cursor is located at an input location, pressing a numeric key will sometimes make a list of parameter values appear.

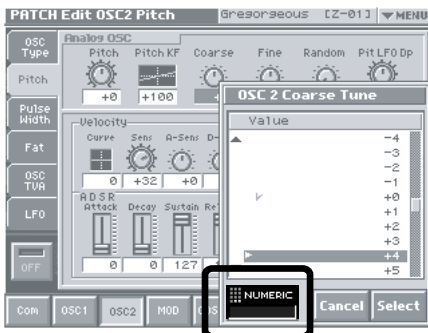

When you can input a numeric value

Use the numeric keys to input a value in the input field.

- [0]-[9] buttons: Input numeric values.
- [BANK-] button: Reverse the sign of the input value.
- [BANK+] button: Clear the input value.
- [KEY PAD] button: Return the list to the middle.

When you can input directly

The input area will blink "SELECT."

- Press a button to input a value directly. From the top of the list, the items correspond to the [0]-[9] buttons.
- The corresponding buttons will light. The current value will blink.

MEMO

The numeric keys also function as the Patch Palette (p. 30).

MEMO

You can also display the list by pressing the VALUE dial (ENTER) instead of the numeric keys.

Try Out the Sounds

Selecting Patches and Playing Sounds

The V-Synth XT comes with a wide range of onboard sounds, including single tones called patches. Let's select a few patches to get an idea of the variety of sounds available with the V-Synth XT.

1 Make sure the PATCH PLAY screen is displayed.

If the PATCH PLAY screen—shown below—is not displayed, press [EXIT] once or twice until the PATCH PLAY screen appears.

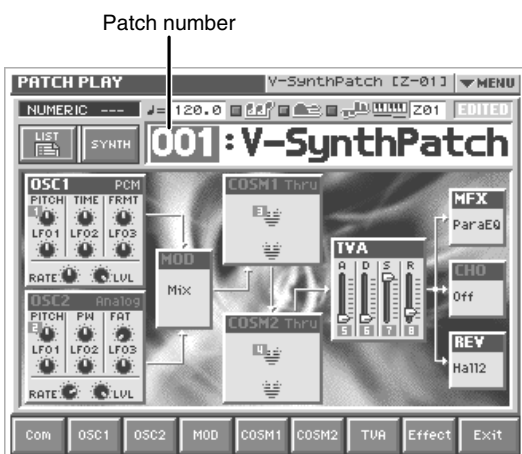

2 Press the [PREVIEW] button to audition the patch.

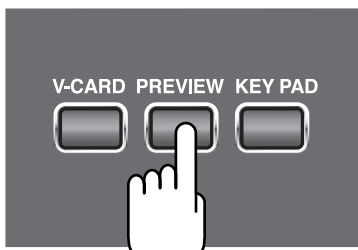

3 To change to a different patch, touch the patch number to highlight it, and then turn the VALUE dial or press [INC] [DEC]. At this time you can switch more rapidly by holding down [SHIFT] while you perform these operations.

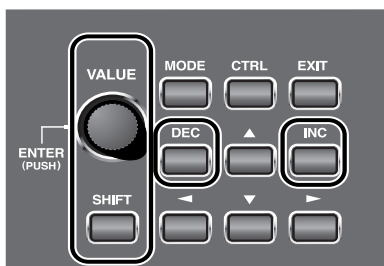

HINT

You can also touch the patch number display area and use the numeric keys to switch patches (p. 27).

HINT

Alternately, you can touch the patch number and drag your finger up and down—or right and left—to change patches.

Playing a Patch on the V-Synth XT from an External MIDI Device (MIDI Keyboard)

The V-Synth XT produces sound in response to MIDI messages it receives from an external MIDI device such as a MIDI keyboard or sequencer.

Try connecting your MIDI keyboard and playing sounds on the V-Synth XT.

Connecting the MIDI Keyboard

Connect the MIDI keyboard as shown in the following.

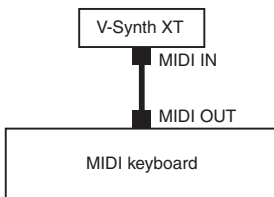

Matching MIDI Channels

In order for the V-Synth XT to respond to MIDI data sent by an external MIDI device, both devices must be set to use the same MIDI channel or channels.



Executing a Factory Reset sets the V-Synth XT's reception channel in Patch mode to "1." If you want to set this to a channel other than 1, use "Part MIDI" (p. 126) to specify the desired MIDI receive channel for Part 1.

Selecting Patches from the List

You can easily find the desired patch by selecting it from the patch list.

- 1 **Make sure the PATCH PLAY screen is displayed.**

If the PATCH PLAY screen is not displayed, press [EXIT] once or twice until the PATCH PLAY screen appears.

- 2 **Touch <List> in the upper left area of the display.**

The PATCH List window appears.

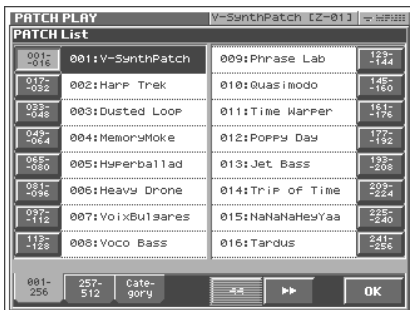

- 3 **Select a patch from the list.**

Either turn the VALUE dial or use [INC] [DEC] to select a patch. You can also select a patch by touching it on the display.



For details on the factory-set patches in the V-Synth XT's memory, refer to "Sound List" (separate booklet).



If you select a patch in the list and play your external MIDI keyboard, the selected patch will sound. This is a useful way to audition the sound of a patch.

Playing a drum set (Rhythm mode)

Rhythm mode lets you assign a different V-Synth sound to each note of the keyboard. This lets you use the V-Synth XT as a rhythm sound module.

- 1 Press [MODE].
- 2 In the V-SYNTH XT MODE MENU window that appears, touch <RHYTHM>.

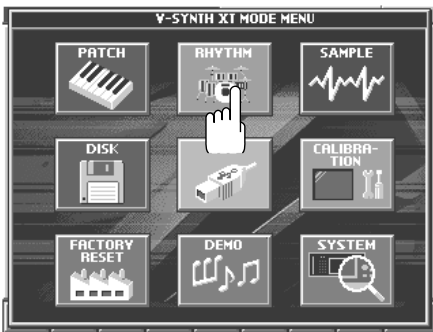

- 3 Use an external MIDI device to play the rhythm kit.
- 4 To switch rhythm kits, touch the area where the patch number is displayed so it's highlighted, then turn the VALUE dial or use [INC][DEC].



- 5 To exit RHYTHM mode, press [MODE], and then touch <PATCH> in the V-SYNTH XT MODE MENU window that appears.

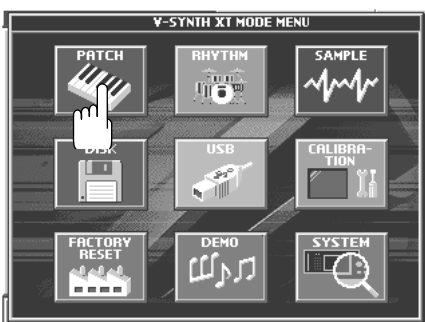

For details on how to edit Rhythm mode settings, refer to “Creating a Rhythm Kit (Rhythm Mode)” (p. 102).

Try Out the Various Performance Features

The V-Synth XT is equipped with a variety of powerful performance features that can raise your musical expressiveness to new levels. These include the Time Trip Pad and the Arpeggiator. Take a moment to try out some of the V-Synth XT's performance features.

Manipulating Sounds with the Time Trip Pad

You can apply a variety of effects to the sound simply by touching your fingertip to the Time Trip Pad.

1 Make sure the PATCH PLAY screen is displayed.

If the PATCH PLAY screen is not displayed, press [EXIT] once or twice until the PATCH PLAY screen appears.

2 Press [CTRL] to access the Control screen.

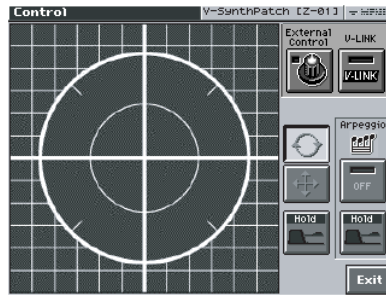
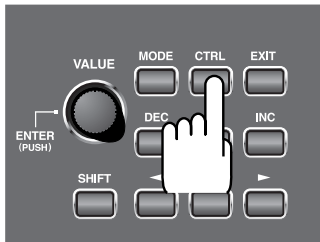

3 Choose the function that you want to control from the Time Trip pad, and press the TIME TRIP PAD button for that function.

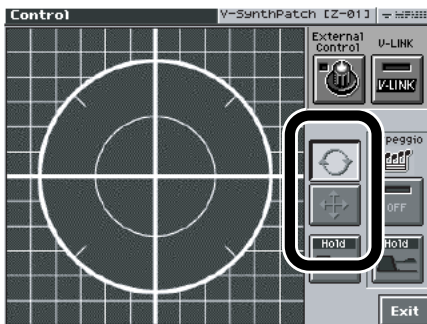

 : Apply the Time Trip effect.

 : Apply the effect that is specified by each patch.

MEMO

What is the Time Trip function?

One of the advantages of vari-phrase is that the playback location and speed of the wave can be changed in real time. The Time Trip function takes advantage of this ability to manually control the playback location and speed of the wave. In patches that use vari-phrase, switch the Time Trip Pad function to "TIME TRIP" to use this function. While playing your external MIDI keyboard, touch the Time Trip pad and the currently sounding wave will stop at the current playback location. Then as you move your finger from that point in a circle, the wave playback will advance in the direction of conventional playback (clockwise), or the reverse (counterclockwise). Unlike "scratching" on a turntable, this lets you control the playback without affecting the pitch, so you can play the sound at the pitch you specify from the keyboard.

NOTE

The Time Trip pad will have an effect if PCM is selected for the oscillator (OSC1/OSC2) and the "Time Trip Sw (Time Trip Switch)" (p. 87) is ON.

- 4 While you play your external MIDI keyboard to produce sound, place your fingertip on the Time Trip pad and move your finger in the following way.

If  is on

The effect will be applied when you move your finger in a circle on the Time Trip pad.

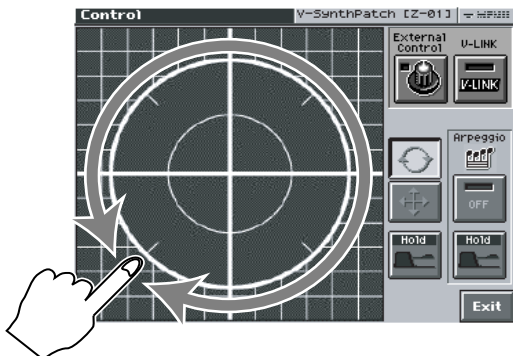

If  is on

The effect will be applied when you move your finger up/down/left/right on the Time Trip pad.

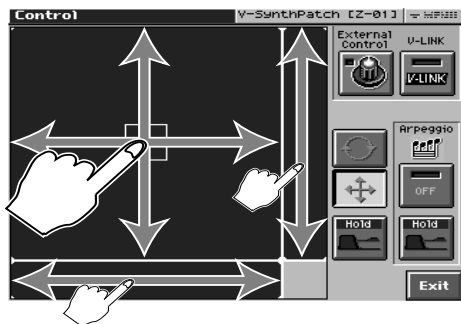

HINT

Time Trip Pad settings are saved with each patch. This means that you can create the best Time Trip Pad settings for each patch.



For details on using the Time Trip Pad, refer to “Applying an Effect by Touching Your Finger to the Pad (Time Trip Pad)” (p. 69).

Try Out the Various Performance Features

Using Knobs to Modify the Sound in Realtime (E1-E8 knobs)

By turning the E1-E8 knobs while you play, you can control the various functions that've been assigned to them.

- 1 **Make sure the PATCH PLAY screen (p. 60) is displayed.**

If the PATCH PLAY screen is not displayed, press [EXIT] once or twice until the PATCH PLAY screen appears.

- 2 **While playing your external MIDI keyboard to produce sound, turn the E1-E8 knobs**

The sound will change according to the function assigned to each knob.

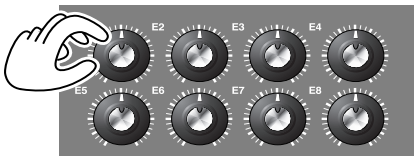

As shown in the following illustration, numbers (1-8) will appear in the PATCH PLAY screen; these correspond to E1-E8.

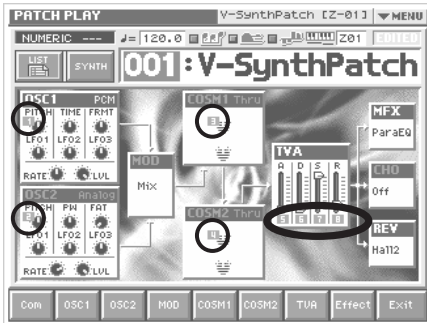

In the PATCH PLAY screen, you can hold down the [SHIFT] key and use the cursor up/down [▲] [▼] buttons to switch the parameters that will be controlled.

In the menu that appears when you touch <▼ MENU> in the upper right of the PATCH PLAY screen, you can touch "Global Knob" and use the buttons to switch E1-E8 knob sets. These are saved as patch parameters.

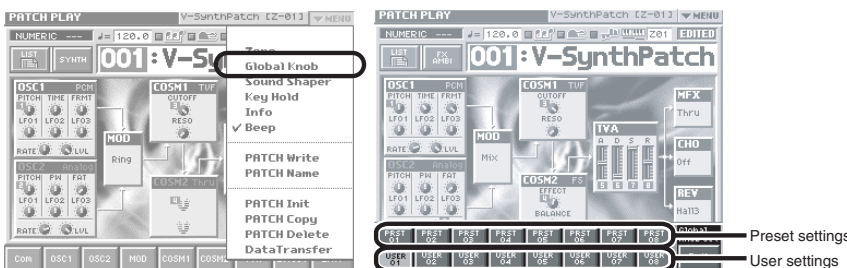

If you want to edit the user knob settings, use the System settings "E1 - E8 Knob" (p. 128).

E1-E8 knobs in the editing screens

In the editing screens that appear when you touch the buttons at the bottom of the PATCH PLAY screen (Com, OSC1, OSC2, etc.), the E1-E8 knobs function as follows.

In the menu that appears when you touch <▼MENU>, verify the “Indiv Knob” setting.



If “Indiv Knob” is checked:

The knobs correspond to the knob numbers shown in each editing screen.

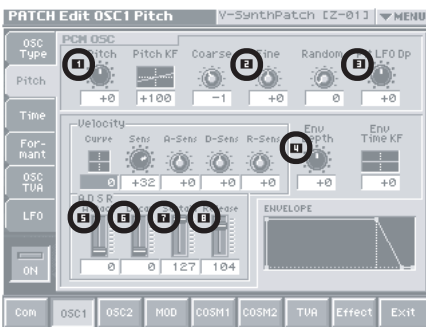

* You cannot change the knob number assignments of each editing screen.

If “Indiv Knob” is not checked:

The knob numbers are not shown in the editing screens. The knobs will correspond to the knob numbers shown in the top screen (PATCH PLAY screen).



Try Out the Various Performance Features

Playing Arpeggios (Arpeggiator)

The V-Synth XT provides an automatic arpeggio function (Arpeggiator). When you turn on the arpeggiator and play your external MIDI keyboard, arpeggios are produced automatically.

For example, if you press the keys of a C major chord, the V-Synth XT arpeggiates the chord as C → E → G → C → E → G...

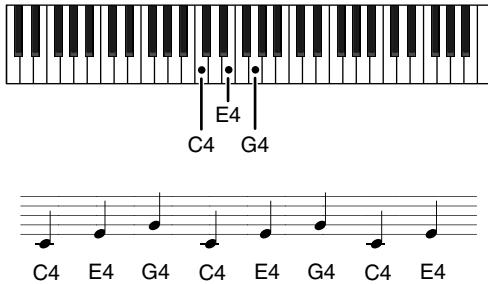

1 Make sure the PATCH PLAY screen is displayed.

If the PATCH PLAY screen is not displayed, press [EXIT] once or twice until the PATCH PLAY screen appears.

2 Press Arpeggio <ON/OFF> to make the indicator light.

The arpeggiator is turned on.

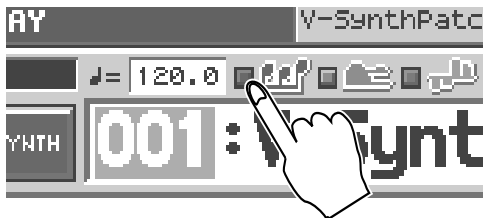

3 Play your external MIDI keyboard.

The V-Synth XT arpeggiates what you've played.

- 4 To adjust the tempo of the arpeggio, touch <TEMPO> in the location shown below, and turn the [VALUE] dial.

Turning the dial toward the right makes the tempo faster, and turning it toward the left makes the tempo slower. Hold down [SHIFT] as you move the VALUE dial to increase value increments to make large value changes more quickly.

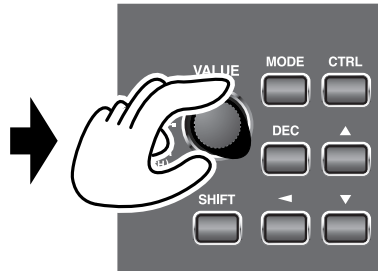
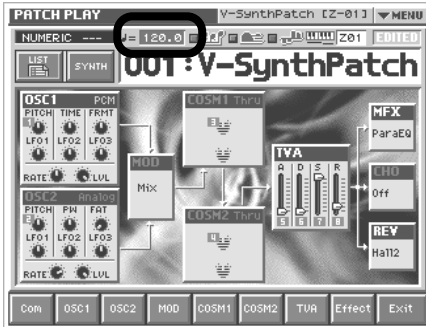

- 5 To finish listening to the arpeggio, press Arpeggio <ON/OFF> again so its indicator turns off.

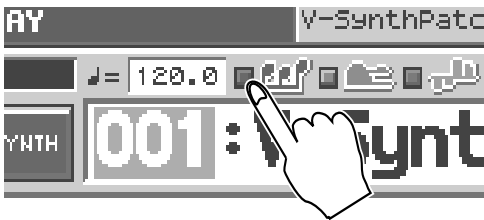

HINT

Arpeggiator settings can be saved with each patch. This means that you can create the best arpeggio settings for each patch.



For details on using the Arpeggiator, refer to "Playing Arpeggios (Arpeggiator)" (p. 64).

Using steps to vary the sound (Multi Step Modulator)

The Multi Step Modulator is a function that modulates the value of various parameters according to a sixteen-step sequence. On the V-Synth XT, the patterns of this sequence are managed as “tracks.” You can simultaneously use up to four tracks, with each track containing a different sequence. You can use the panel knobs to freely modify the sequence pattern.

1 Make sure the PATCH PLAY screen is displayed.

If the PATCH PLAY screen is not displayed, press [EXIT] once or twice until the PATCH PLAY screen appears.

2 At the bottom of the screen, touch < Com >.

3 At the left side of the screen, touch < Step Mod >.

The Multi Step Modulator screen appears.

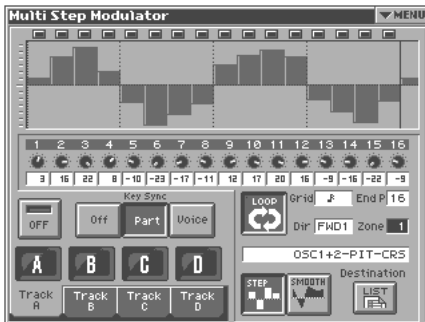

4 At the top of the screen, turn < Step Switch > ON.

The Multi Step Modulator will be applied to the currently selected patch.

5 While you play the external MIDI keyboard to hear the sound, input steps 1–16.

If you touch <▼ MENU > and select Hand Draw, you'll be able to draw the graph directly with your finger.

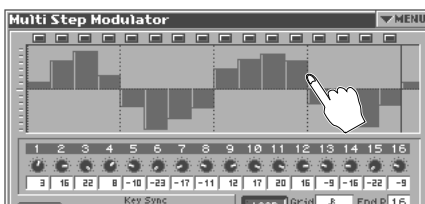

6 To exit the step sequencer, turn < Step Switch > OFF at the top of the screen.

MEMO

You can also turn on the Multi Step Modulator by using the buttons of the PATCH PLAY screen shown below.

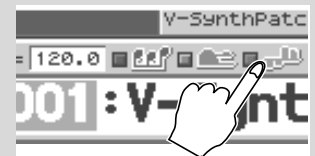

Hand

For details on using the Arpeggiator, refer to “Using steps to vary the sound (Multi Step Modulator)” (p. 68).

Holding the notes you play (Key Hold)

The Key Hold function changes the way in which the patch will play when you press a note on the MIDI keyboard. If Key Hold is on, the patch will start or stop sounding each time you press a note. In other words, the patch will begin sounding when the V-Synth XT receives a note-on, and will stop sounding when the next note-on is received.

- 1 In the upper right of the screen, touch <▼ MENU>.

A pulldown menu appears.

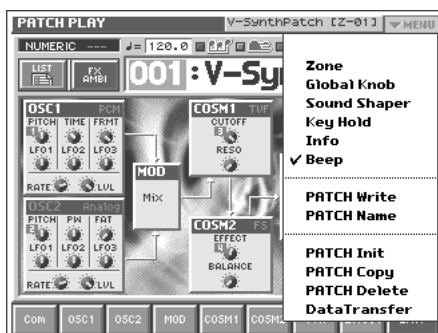

- 2 In the pulldown menu, touch < Key Hold >.

The Key Hold window will appear.



- 3 Turn < Hold Switch > ON.

- 4 Play the MIDI keyboard.

The patch will sound according to the key you pressed. When you press the same key once again, the patch will stop sounding.

* If the Key Hold function is turned on, and you forget which key you pressed, the patch will simply continue sounding. In such cases, press the key that is assigned as the "Panic Key" in the Key Hold window. All notes that are being sounded by the Key Hold function will stop sounding.

* If you change the Panic Key assignment, you must save the system settings as described in "Saving the System Settings (Write)" (p. 122).

MEMO

The Key Hold function is turned "off" when you power up the V-Synth XT.

Creating a Patch

This chapter explains the steps for creating a patch on the V-Synth XT. Broadly speaking, there are two ways to create a patch.

Using a template to create a patch intuitively (the Sound Shaper function)

You can easily create a patch just by choosing a group and template.

 Refer to “**Creating a patch intuitively (Sound Shaper)**” (p. 40).

Creating a patch from scratch

This section explains the basic procedure for creating a patch on the V-Synth XT.

 Refer to “**Initializing Patch Settings**” (p. 42).

Creating a patch intuitively (Sound Shaper)

The “Sound Shaper” function lets you create a patch simply by choosing a group and template, and operating knobs and buttons to edit the relevant aspects of the sound, just like a professional sound designer.

1 Make sure that the PATCH PLAY screen is displayed.

2 At the upper right of the screen, touch <▼ MENU >.

A pulldown menu will appear.

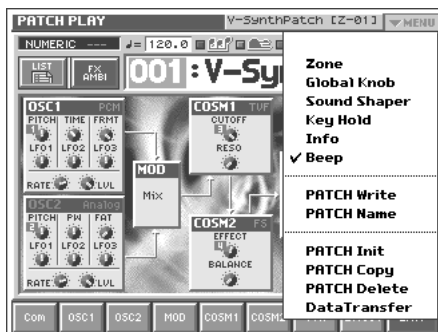

3 In the pulldown menu, touch < Sound Shaper >.

The following window will appear.



Choose the “Group” and “Template” that are closest to the sound you want to create. Use the list at the left to choose a group, and use the list at the right to choose a template. Then touch < Enter >.

- 4** A window like the following will appear. While playing the external MIDI keyboard, use the eight switches and knobs to adjust the sound.

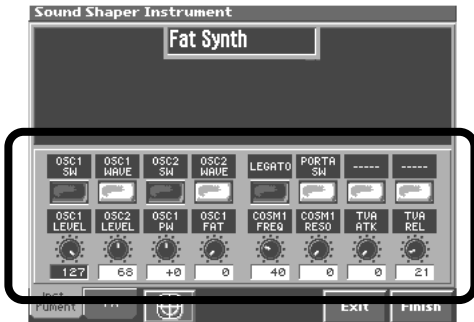

- The [E1]–[E8] knobs correspond to the knobs in the screen.

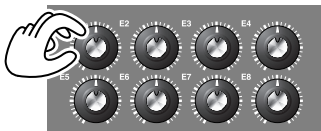

- Some buttons have an on/off function, while others select choices from a list.

- 5** At the bottom of the screen, touch the < FX > tab to make effect settings.



From the top, the effects are MFX (multi-effect), chorus, and reverb.

- You can use the button for each effect to turn it on/off.
- If you want to switch the type of an effect, touch the effect name to highlight it, and then turn the VALUE dial or use [INC][DEC].
- In the Sound Shaper you can edit only the main parameters of each effect, using the on-screen knobs.

- 6** In the lower right of the screen, touch < Write > to open the “Patch Write” screen, where you can save the patch you created.



To save your patch, use the procedure described in “Saving Patches (PATCH Write)” (p. 53)

MEMO

For each template, the most suitable parameters have been automatically selected for each of the eight switches and knobs.



For details on each effect, refer to “Effects List” (p. 164).



For more about the Sound Shaper function, refer to “Creating a patch intuitively (Sound Shaper)” (p. 77).

Initializing Patch Settings

This section explains the basic procedure for creating a patch on the V-Synth XT from scratch.

First we will return the settings of the currently selected patch to a standard set of values.

1 Make sure that the PATCH PLAY screen is displayed.

2 Touch <▼ MENU> in the upper right of the screen.

A pulldown menu appears.

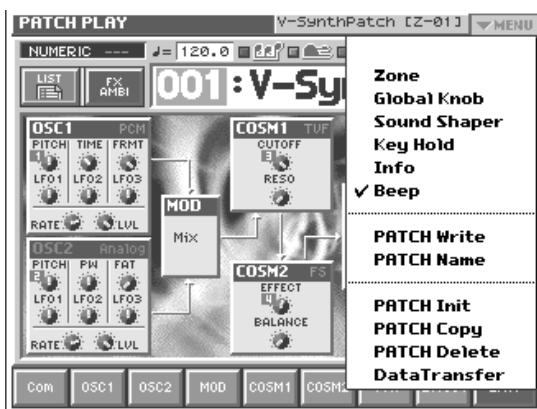

3 Touch <PATCH Name> in the pulldown menu.

A window like the following appears.



4 Touch <EXECUTE>.

The initialization will be carried out, and you'll be returned to the PATCH PLAY screen.

Selecting a Structure Type

The sounds of the V-Synth XT are produced by six elements (sections). Here's how to select the Structure Type, which determines how these elements are combined.

| Section name | Function |
|--------------|---|
| OSC1, OSC2 | This section generates the sound on which a patch is based. The sound is produced either by built-in preset waves or sampled waves, or by calculating an analog modeling waveform. An external audio input source can also be used. |
| MOD | This section mixes and modulates the two audio signals. |
| COSM1, COSM2 | This section applies a wide variety of processing including filtering. This differs from the effects in that effects are applied to the final mix of the sound, COSM is applied to each individual note. |
| TVA | This section creates time-variant changes in volume, and sets the pan position. |

1 Make sure that the PATCH PLAY screen is displayed.

2 In the lower part of the screen, touch <COM>.

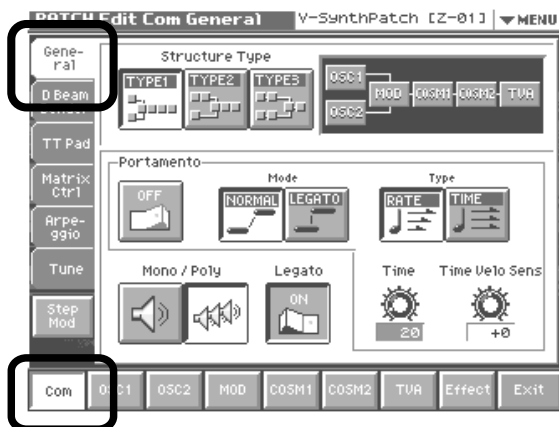

A screen like the following appears. If a different screen appears, touch the <General> tab at the left side of the screen.



Creating a Patch

3

Press Structure Type <TYPE 1>—<TYPE 3> to select a structure type.

| Structure Type | Description |
|--|---|
|  | <p>This is the most conventional structure on the V-Synth XT. The sounds from OSC1 and OSC2 are mixed by MOD, processed by COSM1 to shape their tonal character (e.g., using SBF), and then sent through COSM2 for additional tonal refinement (e.g., using TVF).</p> |
|  | <p>This structure connects OSC1 and OSC2 asymmetrically. This is effective when using a modulation that has the modulator set to anything other than “MIX.” Typically, you will use OSC1 and COSM1 to create the basic sound, then select the OSC2 sound and MOD settings to add variation, and finally select TVF in COSM2 to adjust the tone.</p> |
|  | <p>In this structure, OSC1 is paired with COSM1, and OSC2 is paired with COSM2. You can use a controller such as the Time Trip Pad to morph between the sound created by OSC1 and COSM1 and the sound created by OSC2 and COSM2.</p> |

Switching Each Section On/Off

After deciding on the structure type to use, you can switch each section within that structure on or off as desired.

- 1 Touch <Exit>. Make sure that the PATCH PLAY screen is displayed.
- 2 While holding down the [SHIFT] button on the front panel, touch the relevant sections in the PATCH PLAY screen to turn individual sections on or off as needed.

Section names shown in white characters are on, and those displayed in gray characters are off.

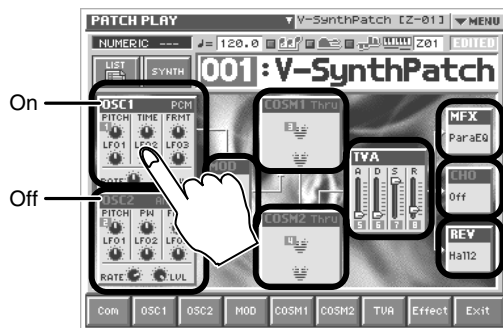

For example if "OSC1" and "OSC2" are both off, there will be no sound-producing section, and no sound will be output.

Setting Up the Oscillators (OSC1/2)

The oscillator sections produce the original sound, either by playing back an internal PCM wave or a sampled wave, or by generating an analog modeling wave.

Selecting a Wave

- 1 Make sure that the **PATCH PLAY** screen is displayed.
- 2 In the lower part of the screen, touch **<OSC1>** (or **<OSC2>**).
A screen like the following appears. If a different screen appears, touch the **<OSC Type>** tab at the left side of the screen.

Analog oscillator



PCM oscillator



- 3 Touch either **<ANALOG>** or **<PCM>** to select the type of oscillator.
- 4 In the **Waveform** area, select the wave you wish to use.
Make your selection while playing your external MIDI keyboard to hear the sounds.



For more about the oscillator settings, refer to **"Modifying Waveforms (OSC1/OSC2)"** (p. 86).

Mixing/Modulating Two Sounds (Mod)

The Modulator mixes and modulates the two audio signals.

Selecting a Modulator Type

- 1 In the lower part of the screen, touch <Mod>. A screen like the following appears.

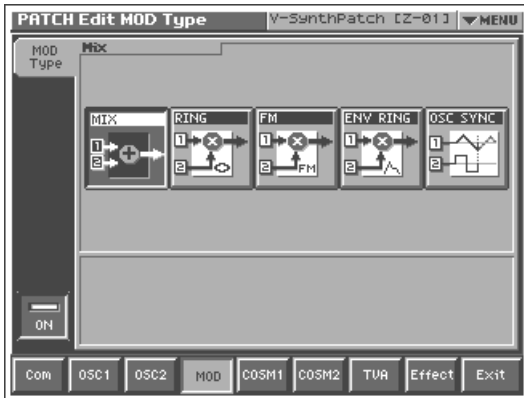

- 2 In the Modulator Type area, select the modulator type you wish to use.

| Modulator Type | Description |
|-----------------|---|
| MIX | Add OSC1 and OSC2. |
| RING | Use OSC2 to apply ring modulation to OSC1. |
| FM | Use OSC2 to apply FM (frequency modulation) to OSC1. |
| ENV RING | Use the envelope of OSC2 to control the volume of OSC1. |
| OSC SYNC | Synchronize the output waveform of OSC1 to the output waveform of OSC2. |

NOTE

OSC SYNC is valid only when OSC2 is an analog oscillator.



For more about the modulator settings, refer to “**Mixing/Modulating Two Sounds (MOD)**” (p. 93).

Applying COSM Modeling to Oscillators (COSM1/2)

The COSM sections modify the sound in various ways, including filtering the sound. COSM differs from the Effects section in that while Effects are applied to the final mix of the sound, COSM is applied individually to each note.

Selecting a COSM Type

- 1 In the lower part of the screen, touch <COSM1> (or <COSM2>).

A screen like the following appears.



- 2 Press the desired COSM type button to select the form of COSM.

Make your selection while playing your external MIDI keyboard to hear the sounds.



For more about COSM settings, refer to “Applying Various Effects to Each Note You Play (COSM1/COSM2)” (p. 93).

Shaping a Sound's Volume Over Time (TVA)

You can adjust the way in which the patch's volume changes over time, or modify the attack or decay of the sound.

- 1 In the lower part of the screen, touch <TVA>.

A screen like the following appears.

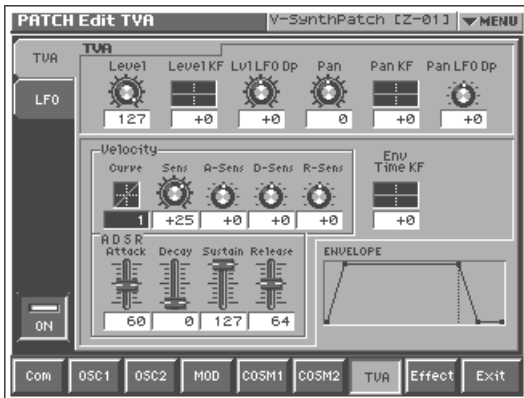

- 2 Use the "ENVELOPE" sliders in the lower left of the screen to adjust the shape of each note's volume.

"ENVELOPE" in the lower right of the screen shows a graphical representation of the envelope produced by the current settings.

| Slider | Function |
|--------|--|
| [A] | Attack Time Sets the time required for the volume of each note to reach its peak. This time increases as you raise the slider. |
| [D] | Decay Time Determines the time it takes for the note's volume to drop from its peak to its sustain level. If the sustain level is at its maximum, this has no effect. |
| [S] | Sustain Level Determines the level at which the volume is maintained after the peak has been reached. As long as you continue to press a key on the keyboard, its note keeps sounding at this level. |
| [R] | Release Time Sets the time it takes for a note's volume to reach zero after you release your finger from a key on a keyboard. |

For example, if you shorten a note's attack time and lengthen its release time, the note's volume may be shaped like a note on a piano. If the sustain level is at maximum, it may sound like an organ, and if the attack time is long, it may sound like a string section.



For details about volume settings, refer to "Adjusting the Volume and Pan (TVA)" (p. 94).

Adding the V-Synth XT Effects

Since the V-Synth XT effects have such a profound impact on its sounds, turn them on to listen to the sound itself so you can better evaluate the changes you're making. Actually, sometimes just changing effects settings can give you the sound you want. Three separate effects are always available in the V-Synth XT. You can independently edit each effect's settings.

| | |
|----------------------------|--|
| MFX (Multi-Effects) | The V-Synth XT contains 41 different multi-effects, including distortion and a rotary-speaker simulation. |
| Chorus | Chorus adds a sense of depth and spaciousness to patches. |
| Reverb | Reverb adds ambience that emulates the sound of various physical spaces, such as concert halls or auditoriums. |



For details about effect settings, refer to "**Setting Effects for a Patch (Effect)**" (p. 97).

Saving Patches You've Created

When you edit the settings of a patch, the PATCH PLAY screen displays <EDITED> to remind you that the patch's settings have been modified. If <EDITED> is displayed, you will lose your edited patch settings if you switch to another patch or turn off the power. If you want to keep a patch whose settings you have edited, assign a name to the patch and then perform the **Save** operation.

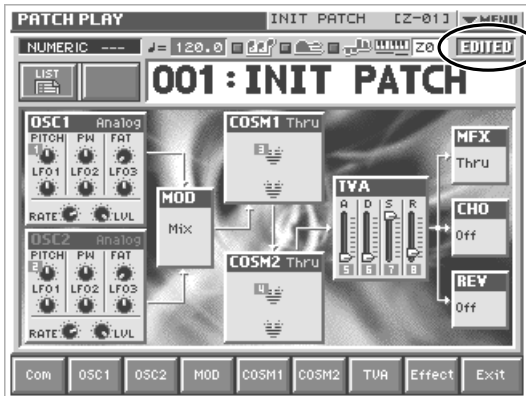

Naming Patches (PATCH Name)

Before you save your patch, give it a new name as follows.

- 1 Make sure that the patch you want to name is selected.
- 2 Touch <▼ MENU> in the upper right of the screen.
A pulldown menu appears.

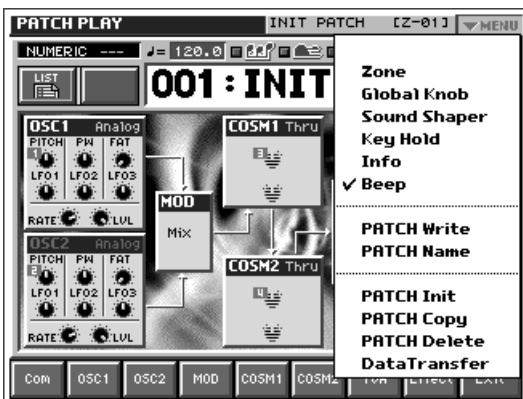

Creating a Patch

- 3 Touch <PATCH Name> in the pulldown menu.

The PATCH Name window appears.



- 4 Enter a name into the text box by touching the desired characters. For this example, let's enter "My Patch1" as the currently selected patch's name.

4-1. Touch <Clear> to erase all characters from the text box.

4-2. Touch <Shift> to turn it on, and then touch <M> to enter a capital "M."

4-3. Touch <Shift> to turn it off, and then touch <y> to enter a lower-case "y."

4-4. Touch <=> to move the cursor one character to the right.

4-5. Touch <Shift> to turn it on, and then touch <P> to enter "P."

4-6. Touch <Shift> to turn it off, and then successively touch <a><t><c><h><1>.

- 5 When you've finished entering the name, touch <OK> to close the PATCH Name window.

Saving Patches (PATCH Write)

After you've named your patch, save it as follows.

- 1 Make sure that the patch you want to save is selected.
- 2 Touch <▼ MENU> in the upper left area of the display.
A pulldown menu appears.

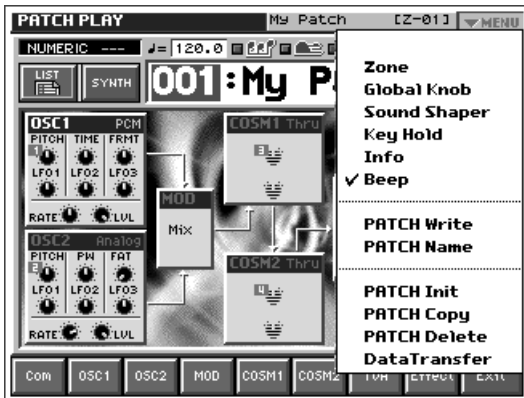

- 3 Touch <PATCH Write> in the pulldown menu.
The PATCH Write window appears.



- 4 Choose the save destination (Destination). Turn the VALUE dial to select an unused patch number.

* The patch you select (as the save destination) will be erased when it is overwritten by the newly saved patch.

- To move through the patches more quickly, you can hold down [SHIFT] and turn the VALUE dial.
- If you touch < Compare > you'll be able to play the external MIDI keyboard to audition the patch that is at the save destination you choose (the Compare function).
- If you touch < List >, the PATCH List window will open, allowing you to choose a save-destination patch from a list.

- 5 Touch <Execute>.

NOTE

When shipped from the factory, the V-Synth XT already contains a collection of patches. When you save your own patches, you replace the factory patches. If you wish to restore the original patches, use the Factory Reset operation (p. 147).

Turning Off the Power

- 1** Before you turn off the power, consider these two questions:
 - Have the volume controls for the V-Synth XT and all connected audio devices been turned to their lowest settings?
 - Have you saved your V-Synth XT sounds or other data you've created? (p. 53)
- 2** Turn off the power for all connected audio devices.
- 3** Turn off the **POWER** switch located on the front panel of the V-Synth XT.

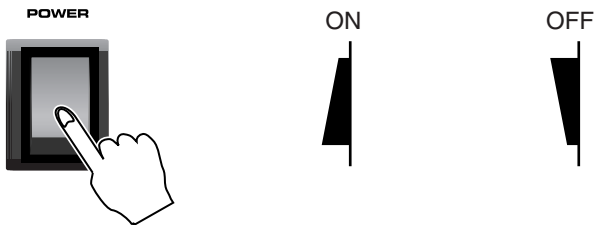

* If you need to turn off the power completely, first turn off the **POWER** switch, then unplug the power cord from the power outlet. Refer to **Power Supply** (p. 4).

Reference

Overview of the V-Synth XT

How the V-Synth XT Is Organized

Basic Structure

Sound Generator Section

The sounds you play on the V-Synth XT are called **patches**. Each patch consists of a **structure** (an arrangement of its six sections), **zones** (which allow for sixteen individual setups for sixteen key ranges), and three **effects**.

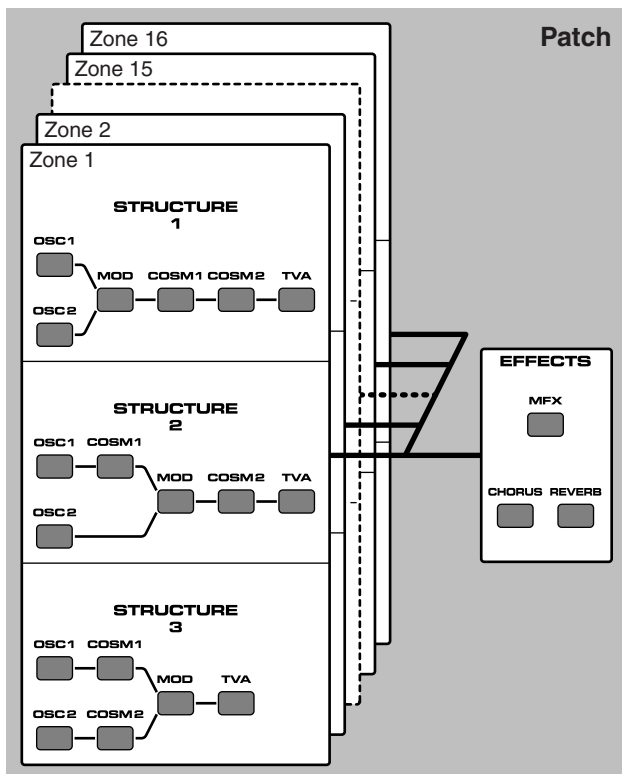

| Section name | Function |
|--------------|---|
| OSC1, OSC2 | This section generates the sound on which a patch is based. The sound is produced either by built-in preset waves or sampled waves, or by calculating an analog modeling waveform. An external audio input source can also be used. |
| MOD | This section mixes and modulates the two audio signals. |
| COSM1, COSM2 | This section applies a wide variety of processing including filtering. This differs from the effects in that effects are applied to the final mix of the sound, COSM is applied to each individual note. |
| TVA | This section creates time-variant changes in volume, and sets the pan position. |

| Effects | function |
|---------|---|
| MFX | The multi-effects are multi-purpose effects that can completely change the nature of the patch's sound. There are 41 different effects types; select and use the type that suits your aims. |
| CHORUS | Applies a chorus effect to give the sound depth and spaciousness. |
| REVERB | Applies a reverb effect to add ambience to the sound. |

Polyphony

The maximum polyphony of the V-Synth XT depends on the OSC and COSM types used by the patch.

MEMO

Changing the effect type or switching effects on/off does not affect the available polyphony.

About Multitimbral Performance

The V-Synth XT allows up to 16-part multitimbral operation, and can be played multitimbrally by performance data sent from an external device. You can use the V-Synth XT to play the sounds of a song you created on your sequencer, or as part of an ensemble. From the MIDI keyboard you can play only the patch that is assigned to part 1. The PATCH Information window shows you the patch that is assigned to each part (p. 147).

A sound module that allows you to control multiple sounds independently in this way is called a **multitimbral sound module**.

Memory

Memory Structure

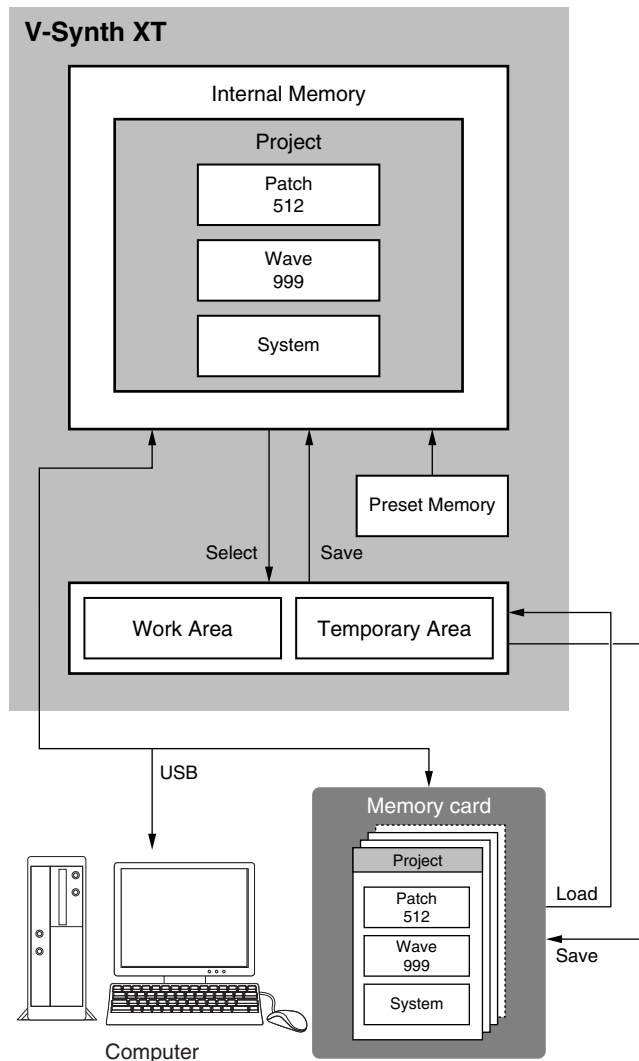

Project

The largest unit of memory used by the V-Synth XT is the **project**. A project contains up to 512 patches, up to 999 waves, and various system settings.

The V-Synth XT uses one project at a time.

Internal Memory

The V-Synth XT has **internal memory** that stores a project. When the V-Synth XT is shipped from the factory, this memory already contains patch and wave data, but you are free to overwrite any of this. You can always restore the memory to the factory-set contents (Factory Reset).

Work Area/Temporary Area

When you turn on the power of the V-Synth XT, or when you load a project in Disk mode, the project data is placed in temporary memory called the **work area**.

Sampling and sample editing operations modify the data that is in the work area.

The currently playable patch data is then further placed (from the work area) into a location called the **temporary area**. This means that even after editing a patch, you can return to the unedited condition by once again recalling that patch.

Since sample data and patch data that you edit will disappear if you simply turn off the power, you must **save** (SAVE/WRITE) it if you want to keep your changes.

Memory cards

Internal memory can hold only one project, but you can use commercially available memory cards to store additional projects.

Sampling Memory

The amount of memory you can use for sampling will depend on the state of the project that is currently loaded into the work area. With the factory-set project, there is approximately 115 seconds (stereo) / 230 seconds (monaural) of sampling memory. If you delete the factory-set waves, you will be able to use a maximum of approximately 280 seconds (stereo) / 560 seconds (monaural) of sampling memory. However since a maximum of approximately 56 seconds (stereo) / 113 seconds (monaural) can be saved in internal memory, you will need to use a commercially available memory card if you want to store more samples than this.

* The above values are for when the sample is encoded using the "LITE" type (p. 119).

MEMO

The factory-set waves can be restored using the Factory Reset operation (p. 147) even if they have been erased.

Preset Memory

Preset memory contains the state of the internal memory when the unit is shipped from the factory. If, after erasing the internal memory, you once again want to use the factory-set patches or waves, you can either perform the Factory Reset operation or use Disk mode to import the factory data from preset memory.

USB

If you connect the V-Synth XT to your computer via a USB cable, projects, patches, and wave data in the V-Synth XT's internal memory or on a memory card can be saved (backed up) to the hard disk or other media on your computer.

In addition, wave data created on the V-Synth XT can also be used by software running on your computer, or wave data created by your computer software can be used on the V-Synth XT.

Overview of the V-Synth XT

Basic Operation of the V-Synth XT

Changing Operating Modes ([MODE])

The V-Synth XT has nine operating modes: Patch mode, Rhythm mode, Sample mode, System mode, Disk mode, USB mode, Calibration mode, Factory reset mode and Demo mode. To access the desired V-Synth XT feature, you must select the appropriate mode.

Here's how to change modes.

1. Press [MODE].

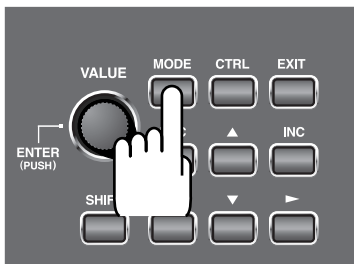

The V-SYNTH XT MODE MENU window appears.

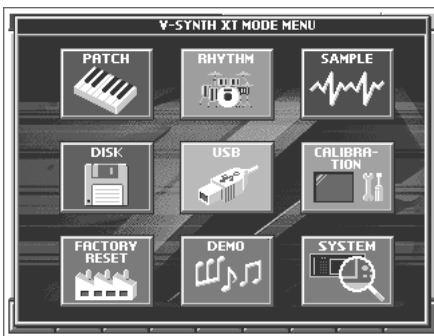

2. Touch the touch screen to select the desired mode.

When you select a mode, the screen for that mode appears. The currently selected mode is shown in the upper left of each screen.

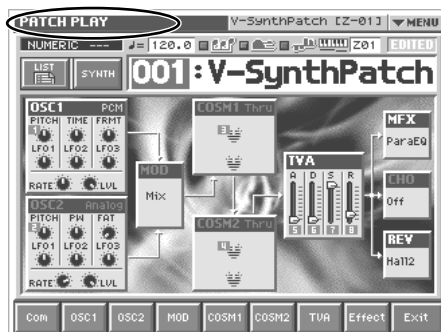

Patch Mode (p. 60, p. 72)

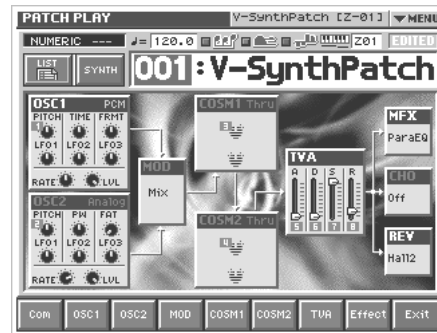

In this mode you can play a single patch from the keyboard, and edit patch settings.

Rhythm Mode (p. 102)



In this mode you can play a rhythm kit from the keyboard, and edit rhythm kit settings.

Sample Mode (p. 104)

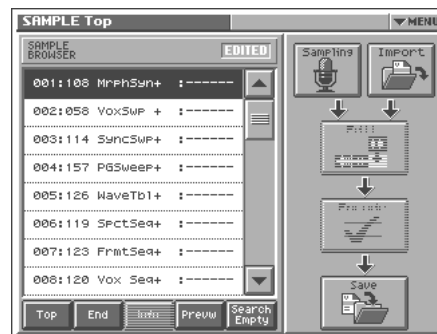

In this mode, you can sample the waves that form the basis of the sounds you create, and edit the sampled waves.

Disk Mode (p. 131)

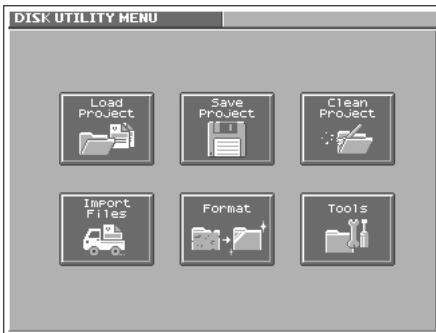

In this mode, you can perform operations related to disks, such as saving data on a disk or loading data from a disk.

USB Mode (p. 138)



In this mode, you can connect the V-Synth XT to your computer and exchange patch or wave data.

Calibration Mode (p. 148)

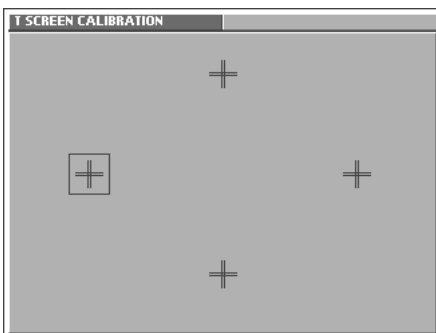

In this mode you can adjust the response of the touch screen.

Factory Reset Mode (p. 147)



In this mode, you can reset to default factory settings.

Demo Mode

This is a demo screen mode that introduces you to the V-Synth XT's functionality.

System Mode (p. 122)



In this mode, you can set the overall behavior of the V-Synth XT, such as its tuning and how it handles received MIDI messages.

Playing in Patch Mode

Patch mode is the mode in which you can play the keyboard using a single sound (patch or rhythm set).

About the PATCH PLAY Screen

Displaying PATCH PLAY Screen

To access the PATCH PLAY screen, use the following procedure.

1. Press [MODE].

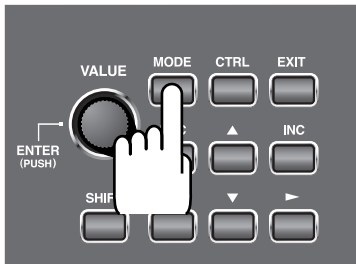

The V-SYNTH XT MODE MENU window appears.

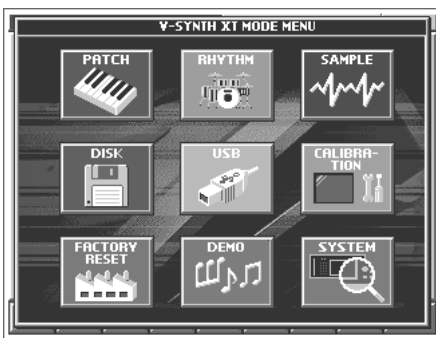

2. Touch <PATCH>.

You will enter Patch mode, and the PATCH PLAY screen appears.

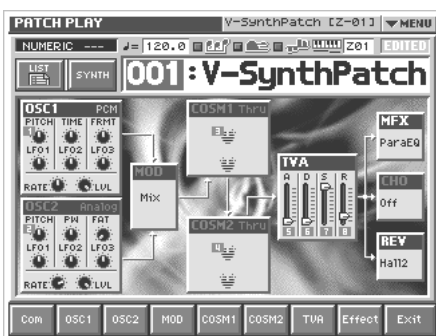

Functions in the PATCH PLAY Screen

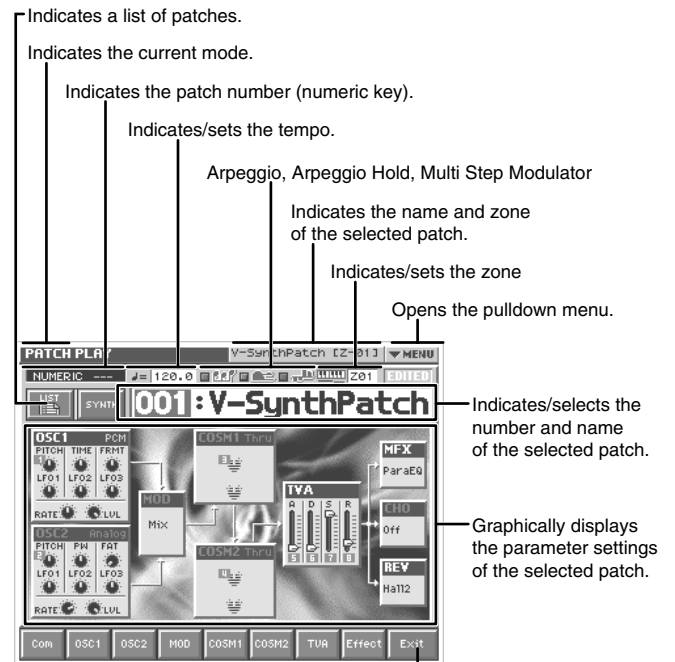

Displays the various patch setting screens. Return to the PATCH PLAY screen.

Selecting a Patch

V-Synth XT contains 512 patches for you to select and use.

All of these patches can be overwritten.

1. Access the PATCH PLAY screen (p. 60).

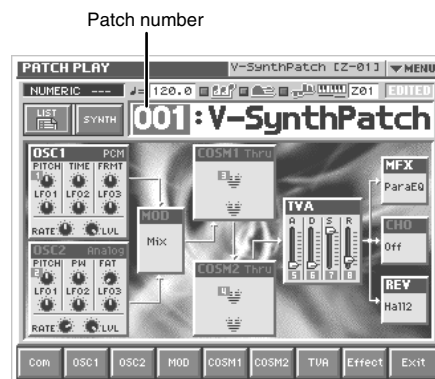

2. Move the cursor to the patch number, either by using the cursor buttons or by touching the patch number display.
3. Turn the VALUE dial, or press [INC][DEC] to select a patch number. You can also do this by dragging on the touch screen.



You can also touch the patch number display area and use the numeric keys to switch patches (p. 27).

Selecting Favorite Patches (Patch Palette)

You can bring together your favorite and most frequently used patches in one place by registering them into the patch palette. By using this function, you can rapidly select favorite patches from internal memory or a Wave Expansion Board.

In each patch palette you can register eight patches, corresponding to the [1]–[8] keys. By using the [BANK] button to switch between the eight banks, you can register a total of 64 patches.



For details on how to register a patch in the patch palette, refer to “Registering a Favorite Patch (Patch Palette)” (p. 76).

1. Access the PATCH PLAY screen (p. 60).

* The Patch Palette is available only in the PATCH PLAY screen.

2. Press [KEY PAD]. The Patch Palette will appear in the screen.

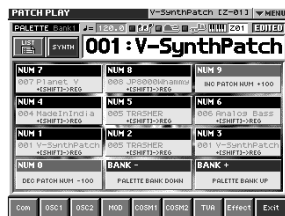
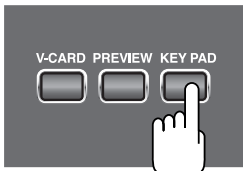

3. Press Numeric Key [1]–[8] to select a patch.

You can also select patches by touching the screen.

MEMO

The [0] key and the [9] key increment or decrement the patch number in steps of 100.

4. To switch between patch palette banks, press [BANK-] / [BANK+].

5. To exit the Patch Palette, press [KEY PAD] once again.

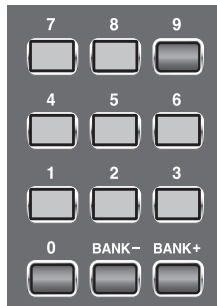

Selecting Patches by Category

The V-Synth XT provides a Patch Search function which allows you to specify a type (category) of patch so that you can quickly find the desired patch. There are a total of 16 categories.

1. Access the PATCH PLAY screen.

2. Touch the category button in the upper left area of the display.

The PATCH List window appears, and the categories will be displayed at both sides of the screen.

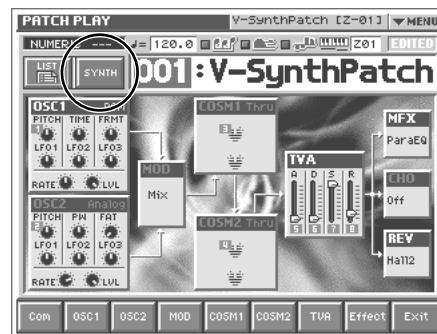

Page navigation button

Playing in Patch Mode

3. Touch the desired category, and select a patch from the list.

You can move to a different page within the same category by touching a page navigation button in the bottom of the screen.

| Category | | Contents |
|------------------|------------------------|--|
| SYNTH | Synth | Synth |
| LEAD | Lead | Lead |
| PAD/STING | Pad/Strings | Pad/Strings |
| VOX/CHOIR | Vox/Choir | Voice/Choir |
| PIANO/KBD | Piano/Keyboards | Piano/Keyboards |
| BASS/GUITAR | Bass/Guitar | Bass/Guitar |
| WINDS | Winds | Winds |
| BELL/ MALLETT | Bell/Mallet/Hit | Bell/Mallet/Hit |
| MELO SEQ | Melodic Sequence | Melodic (i.e., pitched) sequences |
| RHY SEQ | Rhythmic Sequence | Rhythmic (i.e., non-pitched) sequences |
| ARPEG | Arpeggio | Arpeggio |
| FX/AMBI | FX/Noise/ Ambient | Effect/Noise/ Ambient |
| ETHNIC | Ethnic | Ethnic |
| DRUM/PERC | Drum/Percussion | Drum/Percussion |
| COMBI/ OTHERS | Combination/ Others | Combinations using zones/other |
| NO ASSIGN | No Assign | No Assign |



“Assigning the Category of a Patch” (p. 74)

Selecting Patches from the List

You can display a list of patches and select a patch from that list.

1. Access the PATCH PLAY screen (p. 60).

2. Touch <List> in the upper left area of the display.

The PATCH List window appears.



3. Select a patch from the list.

Either turn the VALUE dial or use [INC][DEC] to select a patch. You can also select a patch by touching it on the display.

HINT

If you select a patch in the list and play the external MIDI keyboard, the selected patch will sound. This is a useful way to audition the sound of a patch.

4. To view other patches, touch <017-032>—<241-256>, located at either side of the screen. To view higher-numbered patches, touch <257-512>, located at the bottom of the screen.

5. Touch <OK>.

The patch is selected and the PATCH List window closes.

Playing Single Notes (Mono)

When using a patch for a naturally monophonic instrument such as sax or flute, it is effective to play in mono.

1. Access the PATCH PLAY screen (p. 60).
2. At the bottom of the screen, touch <Com>.
3. In the left side of the screen, touch the <General> tab.
The Patch Edit Com General screen appears.



4. In the “Mono/Poly” field, touch < >.
Now you can play in mono mode.

Creating Smooth Pitch Changes (Portamento)

Portamento is an effect which smoothly changes the pitch from the first-played key to the next-played key. By applying portamento when Mono mode is selected (see the preceding item), you can simulate performance effects such as slurring on a violin.

1. Access the PATCH Edit Com General screen (p. 63).



2. In the “Portamento” field, touch the on/off switch to turn it “ON.”
You’re ready to play portamento.
3. When you want to change the portamento setting, edit the following parameters in the screen of step 2.
Mode (Portamento Mode), **Type** (Portamento Type), **Time** (Portamento Time), **Time Velo Sens** (Portamento Time Velocity Sens)



See p. 79 for each parameter’s functions.

Making Controller-related Settings (Control)

On the panel, press [CTRL] to access the Control screen.

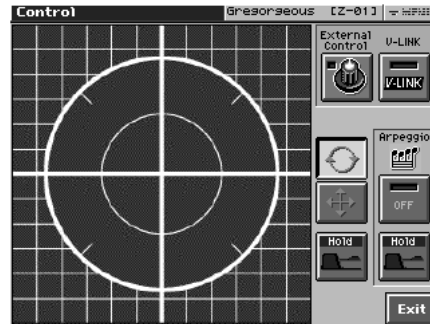

The Control screen provides the following functions.

< External Control >

If this button is on, the E1–E8 knobs will control an external MIDI device. The MIDI controller number that is transmitted when you turn the E1–E8 knobs is specified by “E1 - E8 ExtCC (E1–E8 External CC)” (p. 129).

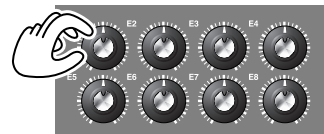

< V-LINK >

If you turn this button on, the V-Synth XT will be in V-LINK mode, where it can control video equipment (p. 71).

< Time Trip Pad >

This lets you use the “Time Trip Pad” function (p. 69) which allows you to apply various effects to the sound by moving your finger over the pad displayed in the screen.

< Arpeggio >

This switches the Arpeggio function (p. 64) on/off.

Playing Arpeggios (Arpeggiator)

The V-Synth XT comes with an **arpeggiator** that can play arpeggios automatically. Once you turn on the arpeggiator, the keys you press will automatically be played as an arpeggio.

1. Access the PATCH PLAY screen (p. 60).
2. Press Arpeggio <ON/OFF> to make the indicator light.
The arpeggiator is turned on.

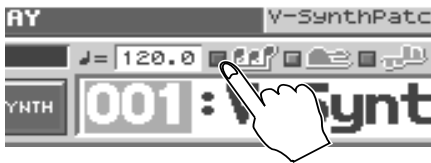

3. Play your external MIDI keyboard.
The V-Synth XT arpeggiates what you've played.
4. To adjust the tempo of the arpeggio, touch <TEMPO> in the location shown below, and turn the [VALUE] dial.
Turning the dial toward the right makes the tempo faster, and turning it toward the left makes the tempo slower. Hold down [SHIFT] as you move the VALUE dial to increase value increments to make large value changes more quickly.

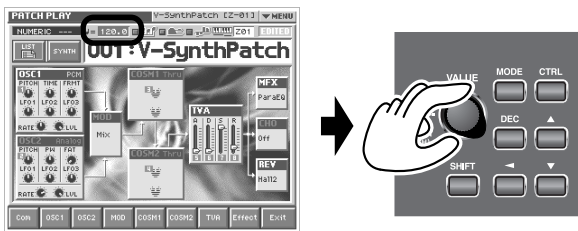

5. To finish listening to the Arpeggio, press Arpeggio <ON/OFF> again so its indicator turns off.

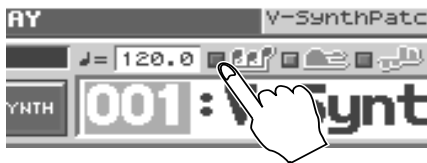

Holding an Arpeggio

By using the following procedure, you can produce arpeggios even without continuing to press the keyboard.

1. Press Arpeggio <ON/OFF> to turn the Arpeggiator on.

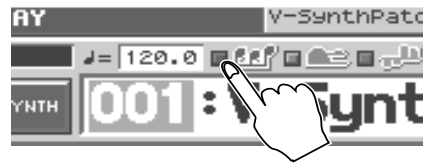

2. Press Arpeggio <HOLD> to make the indicator light.



3. Play the MIDI keyboard.
4. If you play a different chord or notes while the arpeggio is being held, the arpeggio will change accordingly.
5. To cancel Arpeggio Hold, press Arpeggio <HOLD> again.

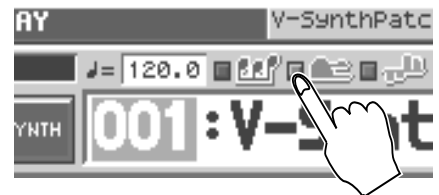

When Using a Hold Pedal

If you play an arpeggio while pressing the hold pedal, the arpeggio will continue to be played even if you release the keyboard.

1. Connect a pedal switch (DP series) to the HOLD PEDAL jack of your external MIDI keyboard.
2. Press Arpeggio <ON/OFF> to turn the Arpeggiator on.

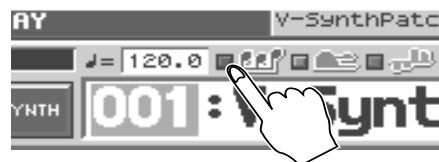

3. Play the keyboard while pressing the hold pedal.
4. To play another chord, release the pedal, press it again as you play the next chord.

Making Arpeggiator Settings

1. Access the PATCH PLAY screen (p. 60).
2. At the bottom of the screen, touch <Com>.
3. In the left side of the screen, touch the <Arpeggio> tab.

The PATCH Edit Com Arpeggio screen appears.

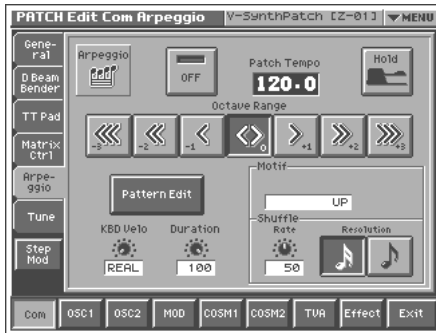

In this screen you can set the following arpeggiator parameters.

Arpeggio Switch: Switches the Arpeggiator on/off.

Hold: Switch between Hold On/Hold Off for the Arpeggiator performance.

Patch Tempo: Specify the tempo of an arpeggio.

Octave Range: Specify the range of the arpeggio performance, in octave units.

KBD Velo: Specify the note strength of the keys you play.

Duration: Vary the strength and note length of the accents to modify the rhythmic feel (groove) of the performance.

Motif: Specifies how the arpeggio will be sounded.

Shuffle Rate: Create shuffle rhythms by modifying the timing at which notes are sounded.

Shuffle Resolution: Specify the timing of the notes in terms of note value.



For details regarding each parameter, refer to “Arpeggio” (p. 82).



Arpeggiator settings can be saved with each patch as part of the patch settings. This means that you can create patches that contain the most effective settings.

Creating an Original Arpeggio Pattern (Pattern Edit)

You can create your own **arpeggio pattern** that specifies how an arpeggio will be sounded. This gives you even more interesting ways to use arpeggios.

An arpeggio pattern is a set of data that can be up to 32 steps (horizontally) x 16 lines (vertically).



An arpeggio pattern can be saved for an individual patch as part of the patch settings. This means that you can create a patch designed specifically for that arpeggio pattern.

About the Pattern Edit Window

1. Access the PATCH Edit Com Arpeggio screen (p. 65).
2. Touch <Pattern Edit>.

The Pattern Edit window will appear.

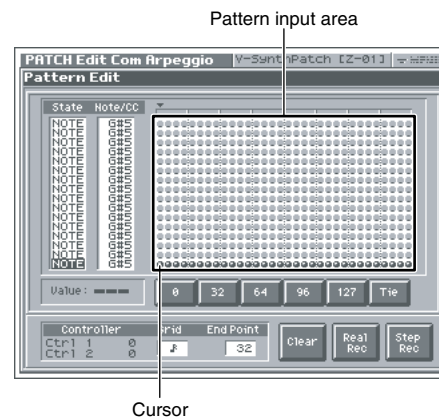

State

Specifies the status of each line.

NOTE: Note pitch

CTRL: Control change

Note/CC (Note/Control Change)

Specifies the note number or control change number assigned to each line. If Status is “NOTE,” this will be a note number (C-1–G9). If Status is “CTRL,” this will be a control change number (0–127).

Pattern Input Area

This area is where you input or edit notes or control changes. The symbols have the following meaning:

●: Note

=: Tie

○: Control change

Value

Shows the velocity of the note or the value of the control change selected in the pattern input area.

Playing in Patch Mode

0, 32, 64, 96, 127, Tie/Clr

When inputting notes: When you touch one of these buttons, a note with the velocity shown on that button will be input at the cursor location within the pattern input area. When you touch <Tie>, a tie will be input at the cursor location.

When inputting control changes: A control change with the value shown on that button will be input at the cursor location within the pattern input area. When you touch <Clr>, the selected control change will be erased.

When you are editing, these buttons modify the velocity of the note that is selected in the pattern input area, or the value of the control change.

HINT

You can also input the note velocity or control change value by using the VALUE dial or [INC][DEC].

Grid

Specifies the note value that will correspond to “one step” of the arpeggio pattern.

♪ (Quarter note), ♪ (Eighth note), ♪. (Dotted eighth note),
♩ (Sixteenth note), ♩. (Dotted sixteenth note), ♪ (Thirty-second note)

End Point

Specifies the pattern length as a number of steps (1–32).

Clear

Erases the pattern data (p. 67).

Real Rec (Realtime Recording)

Use realtime recording to create a pattern (p. 66).

Step Rec (Step Recording)

Use step recording to create a pattern (p. 67).

Creating a Pattern by Playing in Real Time (Real Rec)

This method lets you create a pattern in a way similar to realtime recording on a sequencer. Your playing on the MIDI keyboard and your controller operations will be recorded “as is.”

1. Specify the Grid and End Point of the arpeggio pattern that you will be creating.

Move the cursor to each value box and set the value.

2. Touch <Real Rec>.

The V-Synth XT will be in realtime-input standby mode, and the metronome will sound a guide rhythm.

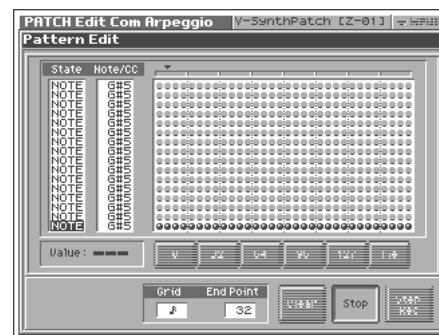

3. In time with the guide rhythm sounded by the metronome, play the MIDI keyboard and operate the controllers.

You can repeatedly record over the pattern length (number of steps) you specified in step 1. On each pass, you can add new notes and control changes to build up the pattern.

NOTE

The notes (specified pitches) and control changes in a single pattern cannot exceed a total of 16. All further (seventeenth and later) notes having a new pitch or control changes will not be recorded.

4. When you are finished with realtime input, touch <Stop>.

The metronome guide will stop sounding.

Creating a Pattern by Inputting One Step at a Time (Step Rec)

This method lets you create a pattern in a way similar to step-recording on a sequencer. You can record notes and control changes by inputting them one by one.

1. Specify the End Point of the arpeggio pattern that you want to create.

Move the cursor to the End Point value box and make the setting.

2. Touch <Step Rec>.

The V-Synth XT will be in step-input standby mode.

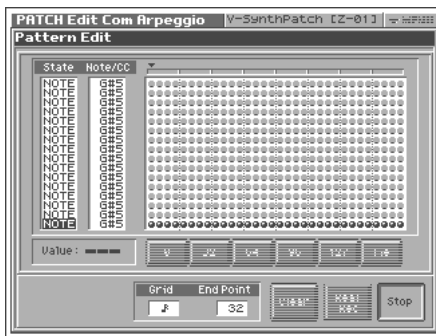

3. Play the MIDI keyboard or operate a controller to input the first step.

You can repeatedly record over the pattern length (number of steps) you specified in step 1. On each pass, you can add new notes and control changes to build up the pattern.

HINT

- To input a tie, hold down the key of the note that you want to tie and press [▶]. You will advance as many steps as the number of times you press [▶].
- Step input records the strength (velocity) with which you press the key, and this will be reflected in the level or dynamics of the arpeggiated notes.
- Control changes will be input with the value that was in effect when you pressed [▶].

NOTE

- The notes (specified pitches) and control changes in a single pattern cannot exceed a total maximum of 16. A newly pitched note or a control change that would exceed this total will not be recorded.
- Be aware that if you input another note while still holding down the key for the previously input note, these notes will be input as a chord located at the same step.

4. When you are finished with step input, touch <Stop>.

Erasing a Pattern (Clear)

Here's how to erase data from the pattern. You can erase a specific line or the entire pattern.

1. To specify a line that you want to erase, move the cursor to that line.

2. Touch <Clear>.

A window like the following will appear.

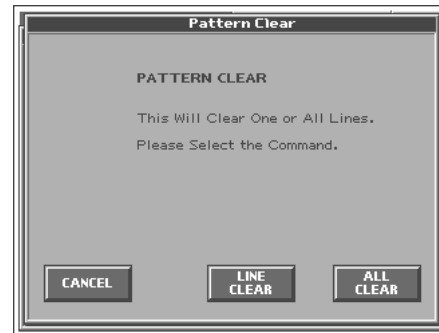

3. To erase a line of data, touch <LINE CLEAR>. To erase the entire pattern, touch <ALL CLEAR>. If you decide you don't want to clear anything, touch <CANCEL>.

Using steps to vary the sound (Multi Step Modulator)

The Multi Step Modulator is a function that modulates the value of various parameters according to a sixteen-step sequence. On the V-Synth XT, the patterns of this sequence are managed as “tracks.” You can simultaneously use up to four tracks, with each track containing a different sequence. You can use the panel knobs to freely modify the sequence pattern.

1. Access the PATCH PLAY screen (p. 60).
2. At the bottom of the screen, touch <Com>.
3. In the left side of the screen, touch <Step Mod>.



The Multi Step Modulator screen appears.



4. At the top of the screen, turn < Step Switch > ON.

The Multi Step Modulator will be applied to the currently selected patch.

MEMO

You can also turn on the Multi Step Modulator by using the buttons of the PATCH PLAY screen shown below.

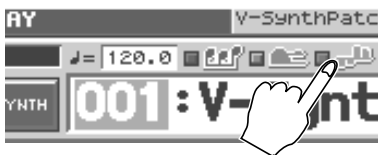

5. Press < A >—< D > to turn tracks on/off as desired.

* If you turn all of the tracks off, there will be no effect even if < Step Switch > is ON.

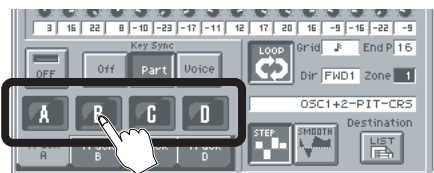

6. Make settings for the track.

Touch one of the tabs for a track name you turned ON in step 5.

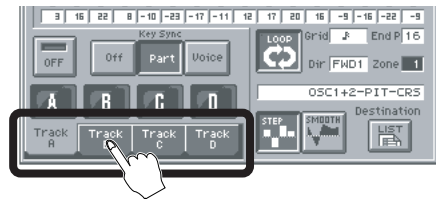

7. While playing the external MIDI keyboard to hear the sound, input steps 1–16.

The V-Synth XT's E1–E8 knobs correspond to knobs 1–8 and 9–16. To switch between 1–8 and 9–16, hold down the [SHIFT] key and use the cursor up/down [▲][▼] buttons (the frame in the screen will move).

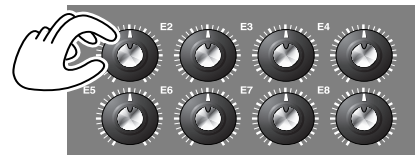

HINT

If you touch <▼ MENU > and select Hand Draw, you'll be able to draw the graph directly with your finger.

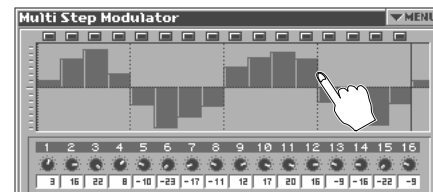

HINT

If you touch < SMOOTH >, the graph will be smoothed. This will make the change in the sound occur gradually, producing a more LFO-like result.

HINT

The step bar shown at the far right (number 17) is the same as the one that appears at the far left (number 1). This is helpful when you're setting up a looping sequence.

HINT

The parameter that is modulated by each track will depend on the patch. In the screen, you can touch Destination < List > to change the assigned parameter.

8. In the same way, make settings for other tracks you turned on in step 5.

9. If you want to stop using the step sequence, turn < StepSwitch > OFF in the screen.



For details regarding each parameter, refer to “Multi Step Modulator” (p. 83).

Applying Various Effects to the Sound

The V-Synth XT provides numerous ways in which you can make your performance more expressive, such as the Time Trip pad and E1 – E8 knobs.

Applying an Effect by Touching Your Finger to the Pad (Time Trip Pad)

You can apply a variety of effects by touching your fingertip to the Time Trip pad located at the left side of the V-Synth XT.

What is the Time Trip function?

One of the advantages of VariPhrase is that the playback location and speed of the wave can be changed in real time. The Time Trip function takes advantage of this ability to manually control the playback location and speed of the wave. In patches that use VariPhrase, switch the Time Trip Pad function to “TIME TRIP” to use this function. While playing the keyboard, touch the Time Trip pad and the currently sounding wave will stop at the current playback location. Then as you move your finger from that point in a circle, the wave playback will advance in the direction of conventional playback (clockwise), or the reverse (counterclockwise). Unlike “scratching” on a turntable, this lets you control the playback without affecting the pitch, so you can play the sound at the pitch you specify from the keyboard.

1. Access the PATCH PLAY screen (p. 60).
2. Press [CTRL] to access the Control screen.

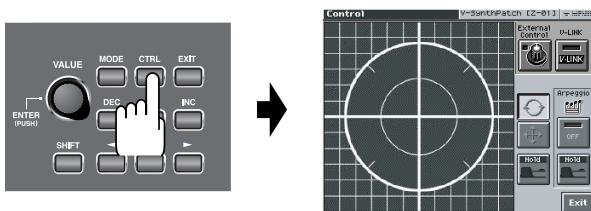

3. Choose the function that you want to control from the Time Trip pad, and press the TIME TRIP PAD button for that function.

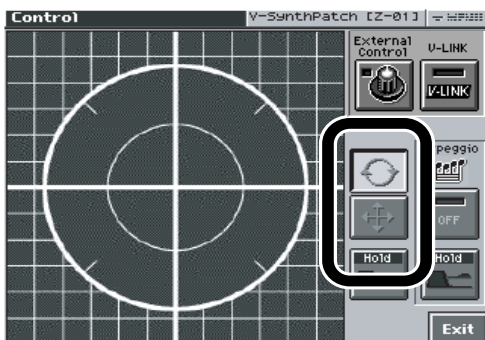

< [Time Trip Icon] >: Apply the Time Trip effect.

< [Matrix Control Icon] >: Apply the effect that is specified by each patch.

If < [Matrix Control Icon] > is on, the effect is applied via matrix control. This means that matrix control settings must be made separately. Set the matrix control **Source** to “PAD-X” or “PAD-Y,” and specify the parameter to be controlled in **Destination**. For details on these settings, refer to “Matrix Ctrl” (p. 81).

By setting matrix control **Source** to “TRIP-R,” you can apply the Time Trip effect and the matrix control effect simultaneously. In this case, turn < [Time Trip Icon] > on.

4. While you play the keyboard to produce sound, place your fingertip on the Time Trip pad and move your finger in the following way.

If < [Time Trip Icon] > is on

The effect will be applied when you move your finger in a circle on the Time Trip pad.

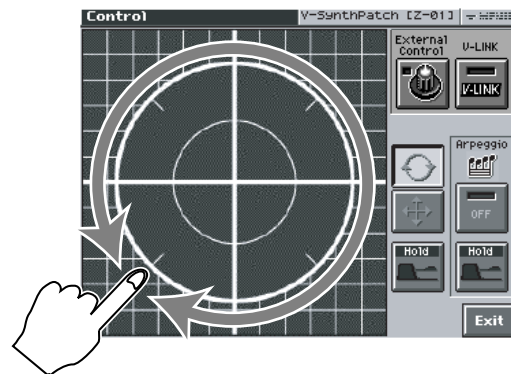

If you are using matrix control as well, the effect will be applied when you move your finger from the circumference of the Time Trip pad toward the center.

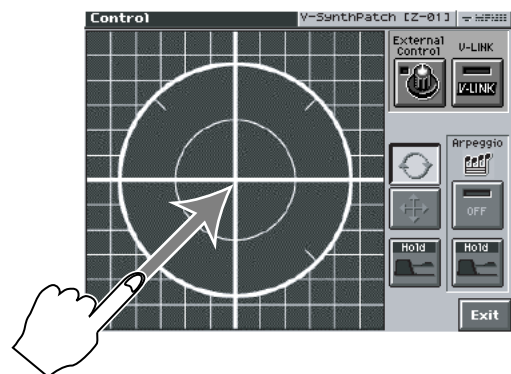

Playing in Patch Mode

If  is on

The effect will be applied when you move your finger up/down/left/right on the Time Trip pad.

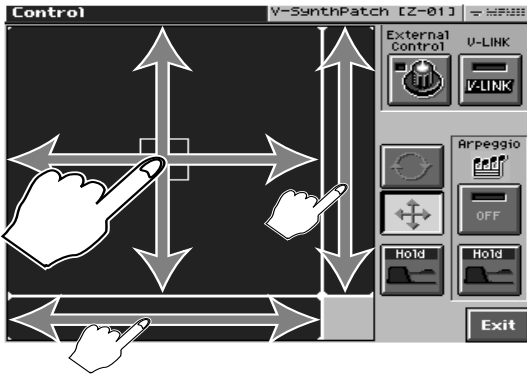

HINT

- By pressing TIME TRIP PAD <HOLD>, you can cause the effect to be held even after you take your finger off the Time Trip pad.



- The Time Trip Pad settings are saved with each patch. This means that you can create patches that contain Time Trip Pad settings you like.

Applying an Effect by Turning a Knob (E1–E8 knobs)

By turning the E1–E8 knobs while you play, you can control the various functions that've been assigned to them.

1. Make sure the PATCH PLAY screen is displayed.

If the PATCH PLAY screen is not displayed, press [EXIT] once or twice until the PATCH PLAY screen appears.

2. While playing your external MIDI keyboard to produce sound, turn the E1–E8 knobs

The sound will change according to the function assigned to each knob.

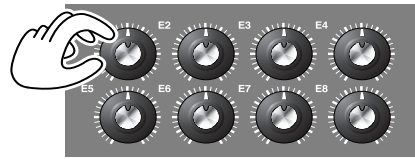

As shown in the following illustration, numbers (1–8) will appear in the PATCH PLAY screen (p. 60); these correspond to E1–E8.

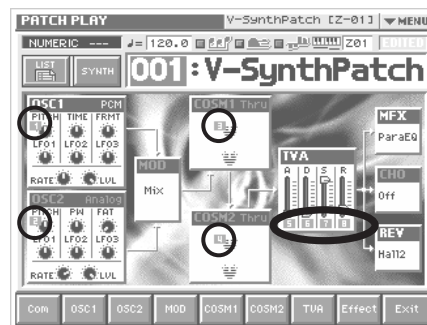

In the PATCH PLAY screen, you can hold down the [SHIFT] key and use the cursor up/down [▲] [▼] buttons to switch the parameters that will be controlled.

In the Sound Shaper screen (p. 77), these correspond directly to the eight on-screen knobs.

HINT

By assigning MIDI controller numbers to the E1–E8 knobs, you can turn [E1]–[E8] to control an external MIDI device that is connected. For details, refer to “E1–E8 Assign” (p. 129).

Synchronizing Music and Video While You Play the V-Synth XT (V-LINK)

The V-Synth XT lets you use the Time Trip pad and E1-E8 knobs to control an externally connected video device that supports V-LINK. This means that your performance on the V-Synth XT can control not only sound but also images, producing sound and video effects that are linked to your playing.

V-LINK (**V-LINK**) is a function that allows music and images to be performed together. By using MIDI to connect two or more V-LINK compatible devices, you can easily enjoy performing a wide range of visual effects that are linked to the expressive elements of a music performance.

Example Connections

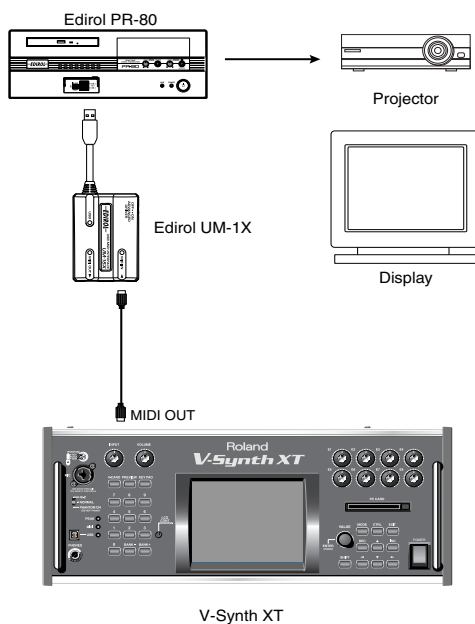

Enter V-LINK Mode

1. Access the PATCH PLAY screen (p. 60).
2. Press [CTRL] to access the Control screen.

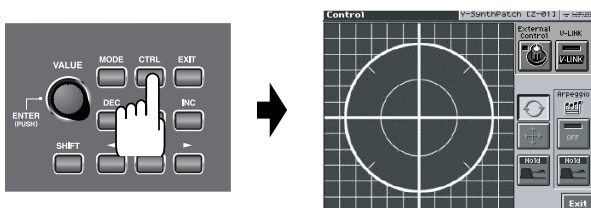

3. Press <V-LINK> so the indicator lights.

“V-LINK” appears in the PATCH PLAY screen (p. 60), and the V-Synth will enter V-LINK mode.



In this screen you can view the V-LINK functions that are assigned to the various controllers.



For details on how to assign V-LINK functions to the controllers, refer to “V-LINK Settings (V-LINK)” (p. 129).

4. To exit V-LINK mode, press <EXIT V-LINK>.

V-LINK Functions that the V-Synth XT Can Control and MIDI Messages

You can assign the following functions to the V-Synth XT’s controllers to control a V-LINK compatible video device.

| V-LINK function | Transmitted MIDI message |
|---|-----------------------------------|
| Playback Speed | CC 10 (Panpot) |
| Dissolve Time (amount time the video clips overlap) | CC 5 (Portamento Time) |
| Audio (Volume of audio playback) | CC 7 (Volume) |
| Color Cb (color-difference signal) | CC 72 (Release) |
| Color Cr (color-difference signal) | CC 71 (Resonance) |
| Brightness | CC 74 (Cutoff) |
| VFX1 (Visual Effects 1) | CC 1 (Modulation) |
| VFX2 (Visual Effects 2) | CC 91 (Reverb) |
| VFX3 (Visual Effects 3) | CC 94 (Celeste) |
| VFX4 (Visual Effects 4) | CC 95 (Phaser) |
| Output Fade | CC 73 (Attack) |
| T Bar | CC 11 (Expression) |
| Dual Stream | CC 64 (Hold 1) |
| Time Trip | CC 92 (Tremolo) CC 93 (Chorus) |
| Palette1-8 (Selecting a palette) | CC 0 (Bank Select): 00H-07H |
| Clip1-8 (Selecting a video clip) | Program Change: 00H-07H |

Creating a Patch

With the V-Synth XT, you have total control over a wide variety of settings. Each item that can be set is known as a **parameter**. When you change the values of parameters, you are doing what is referred to as **Editing**. This chapter explains the procedures used in creating patches, and the functions of the patch parameters.

How to Make the Patch Settings

Start with an existing patch and edit it to create a new patch. The sound of a patch is created by six sections of parameters (p. 43). When editing a patch, you need to be aware of how each section affects the overall sound.

Five Tips for Editing Patches

● Use the Sound Shaper function (p. 77)

The Sound Shaper function makes it easy to design sounds intuitively. Simply choose the appropriate group and template for the type of sound you want to create, and turn the knobs to edit the relevant parameters just like a professional sound designer.

● Select a patch that is similar to the sound you wish to create.

It's hard to create a new sound that's exactly what you want if you just select a patch and modify its parameters at random. It makes sense to start with a patch whose sound is related to what you have in mind.

● Check the Structure setting.

The structure type is an important parameter which determines how the six sections are combined. Before you actually begin editing, you should understand how the sections are related to each other (p. 43).

● Decide which section(s) you will use.

When creating a patch, it is very important to decide which section(s) you will use. In the Edit screen of each section, use the on/off switch to specify whether that section will be used (on) or not used (off).

● Turn Effects off.

Since the V-Synth XT effects have such a profound impact on its sounds, turn them off to listen to the sound itself so you can better evaluate the changes you're making. Since you will hear the original sound of the patch itself when the effects are turned off, the results of your modifications will be easier to hear.

Actually, sometimes just changing effects settings can give you the sound you want.

1. Access the **PATCH PLAY** screen, and select the patch whose settings you wish to modify (p. 60).

HINT

If you want to create all your patches from the ground up, rather than the patches that have already been prepared, carry out the **Initialize** operation (p. 73).

2. The parameters are organized into several editing groups. Touch one of the buttons at the bottom of the screen to select the edit group containing the parameters you want to set.

HINT

In the **PATCH PLAY** screen, you can touch the display area for each section to jump to the setting screen for that section.

3. Touch one of the tabs in the left of the screen to select the desired editing screen.



For details on how the parameters are grouped, refer to "**Patch Parameters**" (p. 150).

4. In each editing screen, touch the touch screen to set the parameters.



For details on how to use the touch screen, refer to "**Basic Touch Screen Operation**" (p. 24).

5. When editing a parameter that requires you to specify a value, move the cursor to the value box of that parameter. Then modify the value by either turning the **VALUE** dial or pressing **[INC]** or **[DEC]**. You can also modify a value by dragging over the touch screen.

6. Repeat steps 2–5 to complete a patch.

7. If you wish to save the changes you've made, perform the **Save** operation (p. 74). If you do not wish to save changes, press **[EXIT]** to return to the **PATCH PLAY** screen.

If you return to the **PATCH PLAY** screen without saving, the display will indicate "EDITED," reminding you that the patch settings have been modified.

NOTE

If you turn off the power or select a different patch while the display indicates "EDITED," your edited patch will be lost.

Initializing Patch Settings (PATCH Init)

“Initialize” means to return the settings of the currently selected patch to a standard set of values.

NOTE

The Initialize operation will affect only the currently selected patch in temporary area; the patches that are stored in internal memory and work area will not be affected. If you wish to restore all of the V-Synth XT’s settings to their factory values, perform a Factory Reset (p. 147).

1. Access the PATCH PLAY screen, and select the patch that you wish to initialize (p. 60).
2. Touch <▼ MENU> in the upper right of the screen.
A pulldown menu appears.

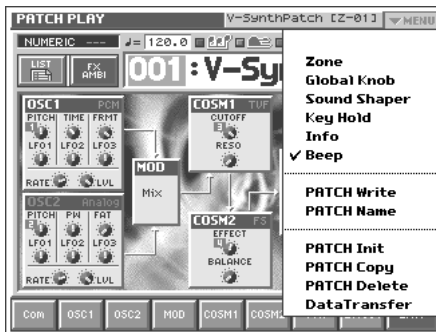

3. In the pulldown menu, touch <PATCH Init>.
A window like the following appears.



4. Touch <EXECUTE>.
The initialization will be carried out, and you’ll be returned to the Patch Edit screen.

Copying Patch Settings (PATCH Copy)

This operation copies the settings of any desired patch to the currently selected patch. You can use this feature to make the editing process faster and easier.

1. Access the PATCH PLAY screen, and select the copy-destination patch (Dest Patch) (p. 60).

2. Touch <▼ MENU> in the upper right of the screen.
A pulldown menu appears.

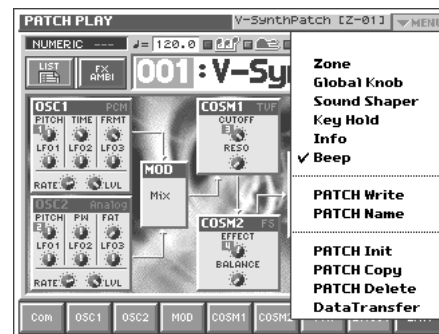

3. In the pulldown menu, touch <PATCH Copy>.
The PATCH Copy window appears.

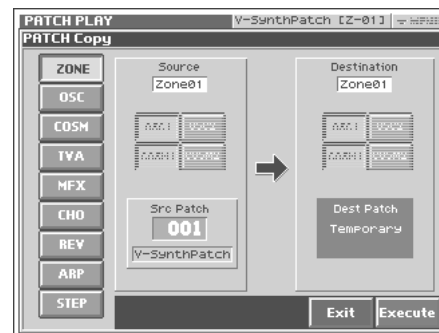

4. Touch a button in the left side of the screen to select the object you want to copy.
<ZONE>: Copy patch settings for one zone.
<OSC>: Copy oscillator parameter settings. Specify the copy-source (Source) and copy-destination (Destination) oscillator (OSC1/OSC2).
<COSM>: Copy COSM parameter settings. Specify the copy-source (Source) and copy-destination (Destination) COSM section (COSM1/COSM2).
<TVA>: Copy TVA parameter settings.
<MFX>: Copy MFX settings.
<CHO>: Copy chorus settings.
<REV>: Copy reverb settings.
<ARP>: Copy arpeggiator settings.
<STEP>: Copy Multi Step Modulator settings.

5. Specify the zone (Zone 01–Zone 16) for the copy source (Source) and copy destination (Destination). Move the cursor to “Zone***” and make your selection.
6. Move the cursor to “Src Patch” and select the copy-source patch number.

HINT

For the Zone Copy, Oscillator Copy, COSM Copy, and TVA Copy operations, you can specify the currently selected patch as the copy source by setting “SrcPatch” to “TEMP.”

7. Touch <Execute> to execute the copy operation.

Naming a Patch (PATCH Name)

Before you save the patch, here's how to give it a new name.

1. Make sure that the patch that you want to name is selected.

2. Touch <▼ MENU> in the upper right of the screen.

A pulldown menu appears.

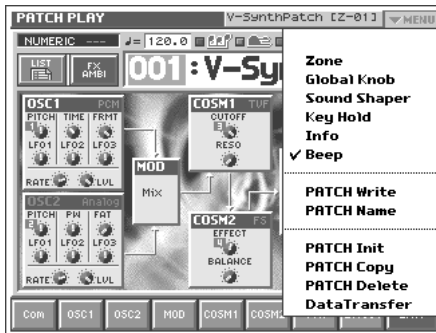

3. In the pulldown menu, touch <PATCH Name>.

The PATCH Name window appears.



4. Touch the on-screen alphabetic or numeric keys to enter the new name in the text box.

The on-screen keys have the following functions.

<<->>: Move the cursor in the text box to the desired input location.

<Shift>: Turn this on when you want to input uppercase letters or symbols.

<Insert>: Turn this on when you want to insert a character at the cursor location.

<Clear>: Erases all characters in the text box.

<Delete>: Deletes the character at the cursor location.

<Back>: Deletes the character that precedes the cursor location.

HINT

You can also move the input location cursor by pressing the [◀] [▶] cursor buttons. Pressing [▲] will change the character at the cursor location to uppercase, and pressing [▼] will change it to lowercase.

5. When you have finished inputting, touch <OK> to finalize the patch name.

* You will lose your edited patch settings if you switch to another patch or turn off the power. If you want to keep a patch whose settings you have edited, then perform the Save operation (p. 75).

Assigning the Category of a Patch

If you assign a category to your patches, you'll be able to search for them by category in the PATCH List window.

MEMO

If no category is assigned to a patch, its category name will be "No Assign."

1. Make sure that the patch that you want to category is selected.

2. Touch <▼ MENU> in the upper right of the screen.

A pulldown menu appears.

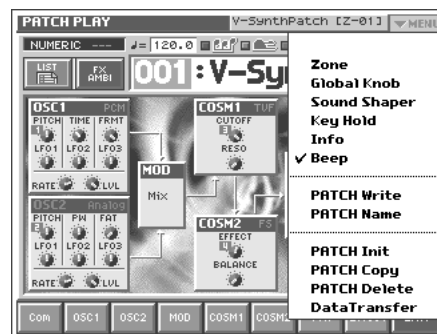

3. In the pulldown menu, touch <PATCH Name>.

The PATCH Name window appears.



4. Touch <Category> tab in the lower area of the display.



5. Select a category from the list.

6. Touch <OK> to finalize the category.

MEMO

You can also assign a category by touching <Category> in the Patch Write window.



* You will lose your edited patch settings if you switch to another patch or turn off the power. If you want to keep a patch whose settings you have edited, then perform the Save operation (p. 75).

Saving Patches (PATCH Write)

Changes you make to sound settings are temporary, and will be lost if you turn off the power or select another sound. If you want to keep the modified sound, you must save it in the internal (internal memory).

When you modify the settings of a patch, the PATCH PLAY screen will indicate "EDITED." Once you save the patch into internal memory, the "EDITED" indication goes away.

NOTE

When you perform the save procedure, the data that previously occupied the save destination will be lost. However, the factory setting data can be recovered by performing the Factory Reset (p. 147).

1. Make sure that the patch you wish to save is selected.
2. Touch <▼ MENU> in the upper right of the screen. A pulldown menu appears.

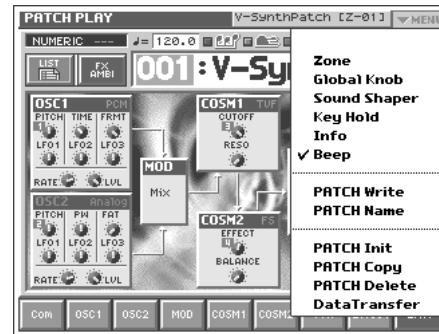

3. In the pulldown menu, touch <PATCH Write>. The PATCH Write window appears.



4. Turn the VALUE dial to specify the save-destination patch.

Creating a Patch

HINT

- You can touch <Compare> and play your external MIDI keyboard to hear the patch that currently occupies the save destination (Compare function).
- When you touch <List>, the PATCH List window will appear, allowing you to select the save-destination patch from the list.



5. Touch <Execute> to execute the Save operation.

Auditioning the Save-Destination Patch (Compare)

Before you save a patch, you can audition the patch which currently occupies the save destination to make sure that it is one you don't mind overwriting. This can help prevent important patches from being accidentally overwritten and lost.

1. Follow the procedure in "Saving Patches (PATCH Write)" through step 4 to select the save destination.

2. Touch <Compare> to turn it on.

Now you can play the patch that is in the currently selected save destination.



3. Play the MIDI keyboard to sound the save destination patch, then check whether you really want to overwrite it.

NOTE

The patch auditioned using the Compare function may sound slightly different than when it is played normally.

4. If you wish to change the save destination, re-specify the save-destination patch by using the VALUE dial.
5. Touch <Execute> to execute the Save operation.

Registering a Favorite Patch (Patch Palette)

You can bring together your favorite and most frequently used patches in one place by registering them into the patch palette. By using this function you can rapidly select favorite patches from internal memory.



For details on how to select patches that are registered in the patch palette, refer to "Selecting Favorite Patches (Patch Palette)" (p. 61).

1. Access the PATCH PLAY screen, and select the patch that you wish to register (p. 60).
2. Press [KEY PAD].

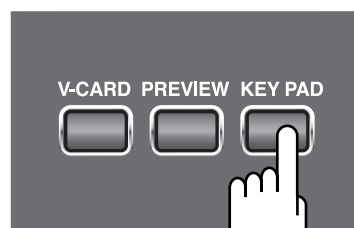

The Patch Palette will appear in the screen.



3. Press [BANK-] / [BANK+] to select the bank in which you wish to register the sound.
4. While holding down [SHIFT], touch the Patch Palette in the screen (or a numeric key on the front panel). The patch will be registered in the Patch Palette you touched.

Deleting Patches (PATCH Delete)

Delete unneeded patches from the internal memory.

1. Touch <▼ MENU> in the upper right of the screen.
A pulldown menu appears.

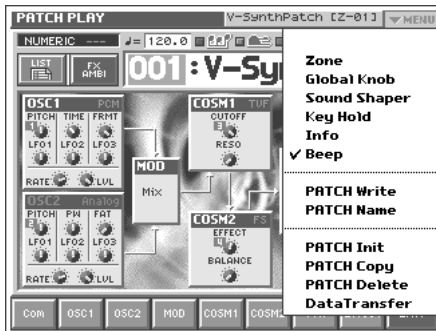

2. In the pulldown menu, touch <PATCH Delete>.
The PATCH Delete List window appears.



3. From the list, select the patch that you want to delete.
Either turn the VALUE dial or use [INC][DEC] to select a patch.
You can also select a patch by touching it on the display.

HINT

Each screen in the PATCH Delete List window shows a group of 16 patches. To view other patches, touch <017-032>-<241-256>, located at either side of the screen. To view higher-numbered patches, touch <257-512>, located at the bottom of the screen.

4. Touch <Execute>.
The selected patch will be deleted.
5. If you want to continue deleting other patches, repeat steps 3 and 4.
6. Press [EXIT].
The PATCH Delete List window closes.

Creating a patch intuitively (Sound Shaper)

The Sound Shaper function lets you create a sound simply by choosing the appropriate group and template for the type of sound you want to create, and using the knobs and buttons to edit the relevant parameters just like a professional sound designer.

1. Make sure that the PATCH PLAY screen is displayed.
A pulldown menu appears.

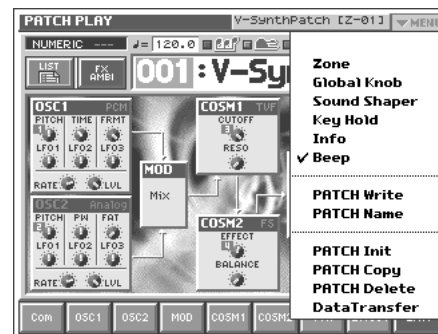

3. In the pulldown menu, touch <Sound Shaper>.
A window like the following appears.

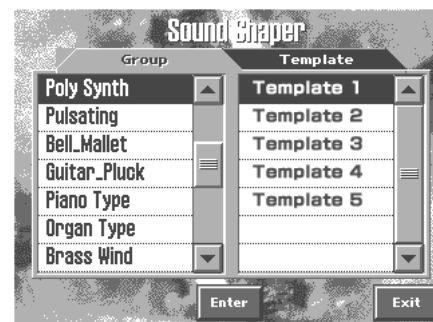

Choose the "group" and "template" that are closest to the type of sound you want to create.
Choose the group from the list at left, choose the template from the list at right, then touch < Enter >.

Creating a Patch

4. A window like the following will appear. While playing the external MIDI keyboard to hear the sound, use the eight switches and knobs to make changes.



MEMO

The eight switches and knobs are automatically assigned to the most appropriate parameters for each template.

MEMO

The [E1]–[E8] knobs correspond to the knobs in the screen.



MEMO

Some buttons act as on/off switches, while others choose items from a list.

MEMO

You can press the pad (⊕) button located in the bottom of the screen to open the Virtual Pad screen.

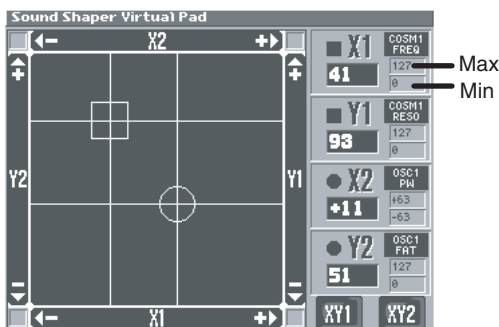

- In this screen you can simultaneously edit the four parameters X1, Y1, X2, and Y2. (The most appropriate parameters for each template are automatically selected for X1, Y1, X2, and Y2.)
- By turning on the <XY1> and <XY2> buttons located in the lower right of the screen, and rubbing your finger over the virtual pad, you can edit these parameters in real time.
- Even if each <XY> button is off, you can edit the four parameters individually by touching the X1, Y1, X2, and Y2 areas at the four corners of the pad.
- To exit the Virtual Pad screen, press the [EXIT] button located on the front panel.

MEMO

If the value of each parameter is outside its upper limit or lower limit, an arrow icon pointing in that direction will appear.

5. At the bottom of the screen, touch the <FX> tab to make effect settings.



- From the top, the effects are MFX (multi-effect), chorus, and reverb.
- Use the button for each effect to turn it on/off.
- To change the type of each effect, touch the effect name to highlight it, then turn the VALUE dial or use [INC][DEC].
- The Sound Shaper function lets you edit only the most important parameters of each effect using the on-screen knobs.



For details on each effect, refer to “Effects List” (p. 164).

6. When you touch < Write > in the lower right of the screen, the “Patch Write” screen will appear, where you can save the patch you created.



Save your patch as described in “Saving Patches (PATCH Write)” (p. 75).

Functions of Patch Parameters

This section explains the functions the different patch parameters have, as well as the composition of these parameters.

MEMO

Parameters marked by “★” can be controlled by specific MIDI messages (Matrix Control). In the PATCH Edit Com Matrix Ctrl screen you can specify how the parameter will be controlled (p. 81).

Settings Common to the Entire Patch (Common)

General



Structure Type

Specifies how the various sound-creating elements will be combined.

Value

TYPE1: This is the most conventional structure. Different sounds from OSC1 and OSC2 are mixed by MOD, processed by COSM1 to create the tonal character (e.g., using SBF (Side Band Filter)), and then processed by COSM2 to adjust the tone (e.g., using TVF).

TYPE2: This structure connects OSC1 and OSC2 asymmetrically. This is effective when using a modulation that has the modulator set to anything other than “MIX.” Typically, you will use OSC1 and COSM1 to create the basic sound, then select the OSC2 sound and MOD settings to add variation, and finally select TVF in COSM2 to adjust the tone.

TYPE3: In this structure, OSC1 is paired with COSM1, and OSC2 is paired with COSM2. You can use a controller such as the Time Trip Pad to morph between the sound created by OSC1 and COSM1 and the sound created by OSC2 and COSM2.

Portamento (Portamento Switch)

Specifies whether the portamento effect will be applied (ON) or not (OFF).

Value: OFF, ON

Portamento

Portamento is an effect which smoothly changes the pitch from the first-played key to the next-played key. By applying portamento when the Mono/Poly parameter is monophonic, you can simulate slide performance techniques on a violin or similar instrument.

Mode (Portamento Mode)

Specifies the performance conditions for which portamento will be applied.

Value

NORMAL: Portamento will always be applied.

LEGATO: Portamento will be applied only when you play legato (i.e., when you press the next key before releasing the previous key).

Type (Portamento Type)

Specifies the type of portamento effect.

Value

RATE: The time it takes will depend on the distance between the two pitches.

TIME: The time it takes will be constant, regardless of how far apart in pitch the notes are.

Time (Portamento Time)

When portamento is used, this specifies the time over which the pitch will change. Higher settings will cause the pitch change to the next note to take more time.

Value: 0–127

Time Velo Sens (Portamento Time Velocity Sensitivity)

This allows keyboard dynamics to affect the portamento Time. If you want portamento Time to be speeded up for strongly played notes, set this parameter to a positive (+) value. If you want it to be slowed down, set this to a negative (-) value.

Value: -63– +63

Mono/Poly

Specifies whether the patch will play monophonically or polyphonically. The monophonic setting is effective when playing a solo instrument patch such as sax or flute.

Value



: Only the last-played note will sound.



: Two or more notes can be played simultaneously.

Creating a Patch

Legato (Legato Switch)

Legato is valid when the Mono/Poly parameter is set to monophonic. This setting specifies whether the Legato function will be used (ON) or not (OFF).

Value: OFF, ON

HINT

With the Legato Switch parameter “ON,” pressing a key while continuing to press a previous key causes the note to change pitch to the pitch of the most recently pressed key, sounding all the while. This creates a smooth transition between notes, which is effective when you wish to simulate the hammering-on and pulling-off techniques used by a guitarist.

Bender



Octave Shift

Adjusts the pitch of the patch's sound up or down in units of an octave (+/-3 octaves).

Value: -3– +3

Bend Range Up (Pitch Bend Range Up)

Specifies the degree of pitch change in semitones when the Pitch Bend lever of the external MIDI keyboard is all the way right. For example, if this parameter is set to “12,” the pitch will rise one octave when the pitch bend lever is moved to the right-most position.

Value: 0–48

Bend Range Down (Pitch Bend Range Down)

Specifies the degree of pitch change in semitones when the Pitch Bend lever of the external MIDI keyboard is all the way left. For example if this is set to “-48” and you move the pitch bend lever all the way to the left, the pitch will fall 4 octaves.

Value: 0–48

TT Pad

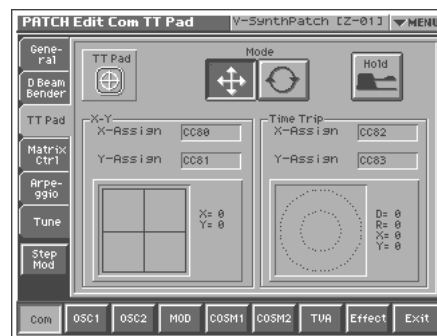

Mode (Time Trip Pad Mode)

Specifies the operating mode of the Time Trip pad.

Value



: XY mode. The effect will be applied when you move your finger up/down/left/right on the Time Trip pad.



: Time Trip mode. The effect will be applied when you move your finger in a circle over the Time Trip pad.

Hold (Time Trip Pad Hold Switch)

Specifies whether the current value will be maintained (ON) when you remove your finger from the Time Trip pad, or not maintained (OFF).

Value: OFF, ON



For details on settings for the Time Trip effect, refer to “Matrix Ctrl” (p. 81) and “TT Pad” (p. 130).

Matrix Ctrl

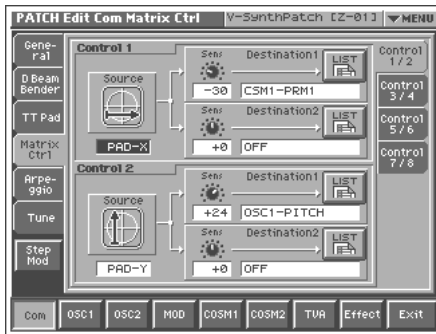

Matrix Control

Ordinarily, if you wanted to change tone parameters using an external MIDI device, you would need to send System Exclusive messages—MIDI messages designed exclusively for the V-Synth XT. However, System Exclusive messages tend to be complicated, and the amount of data that needs to be transmitted can get quite large.

For that reason, a number of the more typical of the V-Synth XT's patch parameters have been designed so they accept the use of Control Change (or other) MIDI messages for the purpose of making changes in their values. This provides you with a variety of means of changing the way patches are played. For example, you can use the Pitch Bend lever to change the LFO cycle rate, or use the keyboard's touch to open and close a filter.

The function which allows you use MIDI messages to make these changes in realtime to the tone parameters is called the **Matrix Control**.

To use the Matrix Control, specify which MIDI message (Source parameter) will be used to control which parameter (Destination parameter), and how greatly (Sns parameter).

Up to eight Matrix Controls can be used in a single patch. In the right side of the screen, touch the "Control 1/2"-"Control 7/8" tabs to select the matrix control that you want to use.

Source (Matrix Control Source)

Sets the MIDI message used to change the patch parameter with the Matrix Control.

Value

OFF: Matrix control will not be used.

CC01–31, 33–95: Controller numbers 1–31, 33–95

BEND: Pitch Bend

AFT: Aftertouch

+PAD-X: Time Trip pad (horizontal direction from the center)

+PAD-Y: Time Trip pad (vertical direction from the center)

PAD-X: Time Trip pad (horizontal direction)

PAD-Y: Time Trip pad (vertical direction)

TRIP-R: Time Trip pad (center from the circumference)

BEAM-L*: D-Beam Left

BEAM-R*: D-Beam Right

KNOB1*: Assignable Controller ([C1])

KNOB2*: Assignable Controller ([C2])

VELO: Velocity (pressure you press a key with)

KEYF: Note Number

* Parameters marked by * will not function since the V-Synth XT (rack-mount) does not have the corresponding controller. They will function if a patch created on the V-Synth XT is played on the V-Synth (keyboard), or if you connect the V-Synth (keyboard) to the V-Synth XT as an external MIDI controller.

Sens (Matrix Control Sens)

Sets the amount of the Matrix Control's effect that is applied. If you wish to modify the selected parameter in a positive (+) direction – i.e., a higher value, toward the right, or faster etc. – from its current setting, select a positive (+) value. If you wish to modify the selected parameter in a negative (-) direction – i.e., a lower value, toward the left, or slower etc. – from its current setting, select a negative (-) value. When both positive and negative are selected, the changes are greater as the value increases. Set it to "0" if you don't want this effect.

Value: -63– +63

Destination 1, 2 (Matrix Control Destination 1, 2)

Specifies the parameters that will be controlled by the matrix controllers. When not controlling parameters with the Matrix Control, set this to "OFF." Up to two parameters can be specified for each Matrix Control, and controlled simultaneously.

Value

You can control the following parameters. For details on each parameter, refer to the corresponding reference page.

MEMO

In this manual, Parameters that can be controlled using the Matrix Control are marked with a "★."

OSC1/2-PITCH: Oscillator Pitch (p. 88)

OSC1/2-TIME/PW: Time/Pulse Width (p. 91)

OSC1/2-FORMA/FAT: Formant/Fat (p. 89, p. 92)

OSC1/2-LVL: Level (p. 92)

OSC1/2-PENV-ATK: Pitch Envelope Attack Time (p. 95)

OSC1/2-PENV-DCY: Pitch Envelope Decay Time (p. 95)

OSC1/2-PENV-REL: Pitch Envelope Release Time (p. 95)

OSC1/2-TENV-ATK: Time Envelope Attack Time (p. 95)

OSC1/2-TENV-DCY: Time Envelope Decay Time (p. 95)

OSC1/2-TENV-REL: Time Envelope Release Time (p. 95)

OSC1/2-FENV-ATK: Formant Envelope Attack Time (p. 95)

OSC1/2-FENV-DCY: Formant Envelope Decay Time (p. 95)

OSC1/2-FENV-REL: Formant Envelope Release Time (p. 95)

OSC1/2-AENV-ATK: Oscillator TVA Envelope Attack Time (p. 95)

OSC1/2-AENV-DCY: Oscillator TVA Envelope Decay Time (p. 95)

OSC1/2-AENV-REL: Oscillator TVA Envelope Release Time (p. 95)

Creating a Patch

- OSC1/2-LFO-RATE:** Oscillator LFO Rate (p. 96)
OSC1/2-LFO-PCH: Oscillator Pitch LFO Depth (p. 88)
OSC1/2-LFO-TM/PW: Time/Pulse Width LFO Depth (p. 88, p. 91)
OSC1/2-LFO-FR/FT: Formant/Fat LFO Depth (p. 89, p. 92)
OSC1/2-LFO-LVL: Oscillator Level LFO Depth (p. 92)
CSM1/2-PRM1: (p. 159)
CSM1/2-PRM2: (p. 159)
CSM1/2-ENV1-ATK: COSM Envelope Attack Time (p. 95)
CSM1/2-ENV1-DCY: COSM Envelope Decay Time (p. 95)
CSM1/2-ENV1-REL: COSM Envelope Release Time (p. 95)
CSM1/2-ENV2-ATK: COSM Envelope Attack Time (p. 95)
CSM1/2-ENV2-DCY: COSM Envelope Decay Time (p. 95)
CSM1/2-ENV2-REL: COSM Envelope Release Time (p. 95)
CSM1/2-LFO-RATE: COSM LFO Rate (p. 96)
CSM1/2-LFO-PRM1: (p. 159)
CSM1/2-LFO-PRM2: (p. 159)
TVA-LVL: Level (p. 94)
TVA-ENV-ATK: TVA Envelope Attack Time (p. 95)
TVA-ENV-DCY: TVA Envelope Decay Time (p. 95)
TVA-ENV-REL: TVA Envelope Release Time (p. 95)
TVA-LFO-RATE: TVA LFO Rate (p. 96)
TVA-LFO-LVL: Level LFO Depth (p. 94)
TVA-LFO-PAN: Pan LFO Depth (p. 94)
MFX-SEND: MFX Send Level (p. 97)
CHO-SEND: Chorus Send Level (p. 97)
REV-SEND: Reverb Send Level (p. 97)
MFX1-3: (p. 164)
TVA-PAN: Pan (p. 94)

HINT

When you touch <List>, the Destination List window will appear, allowing you to select the Matrix Control Destination from the list.

Arpeggio



Arpeggio Switch

Switches the Arpeggiator on/off.

Value: OFF, ON

Patch Tempo

Specify the tempo of an arpeggio. When Clock Source parameter (p. 125) is set to "INTERNAL," this setting value is effective.

Value: 20.0–250.0

Hold (Arpeggio Hold Switch)

Switch between Hold On/Hold Off for the Arpeggiator performance.

Value: OFF, ON

Octave Range (Arpeggio Octave Range)

Sets the key range in octaves over which arpeggio will take place. If you want the arpeggio to sound using only the notes that you actually play, set this parameter to "0." To have the arpeggio sound using the notes you play and notes 1 octave higher, set this parameter to "+1." A setting of "-1" will make the arpeggio sound using the notes you play and notes 1 octave lower.

Value: -3– +3

Pattern Edit

Press this when you want to create an original arpeggio pattern.



For details on creating an arpeggio pattern, refer to "Creating an Original Arpeggio Pattern (Pattern Edit)" (p. 65).

KBD Velo (Arpeggio Keyboard Velocity)

Specifies the loudness of the notes that you play.

If you want the velocity value of each note to depend on how strongly you play the keyboard, set this parameter to "REAL." If you want each note to have a fixed velocity regardless of how strongly you play the keyboard, set this parameter to the desired value (1–127).

Value: REAL, 1–127

Duration (Arpeggio Duration)

Modifies the length of the notes to adjust the “groove” feel of the arpeggio. A setting of “100%” will produce the most pronounced groove feel.

Value: 0–100%

Motif (Arpeggio Motif)

Sets the order in which notes of the chord will sound.

Value

UP: Notes you press will be sounded, beginning from low to high.

DOWN: Notes you press will be sounded, from high to low.

UP&DOWN: Notes you press will be sounded, from low to high, and then back down from high to low.

RANDOM: Notes you press will be sounded, in random order.

NOTE ORDER: Notes you press will be sounded in the order in which you pressed them. By pressing the notes in the appropriate order you can produce melody lines. Up to 128 notes will be remembered.

RHYTHM: Unlike a conventional arpeggio, the notes that you specified when inputting the pattern will always sound. The keys that you press while performing will not affect the result; the specified pattern will play regardless of the pitch of the keys you play. This is suitable for playing a drum patch (p. 101).

PHRASE: Pressing a single key will sound the phrase based on the pitch of that key. If multiple keys are pressed, the last-pressed key will be valid.

AUTO: The timing at which the keys are sounded is assigned automatically, starting at the lowest key that you pressed.

Shuffle Rate (Arpeggio Shuffle Rate)

This setting lets you modify the note timing to create shuffle rhythms.

With a setting of “50%” the notes will be spaced evenly. As the value is increased, the note timing will have more of a “dotted” (shuffle) feel.

Value: 0–100%



Shuffle Resolution (Arpeggio Shuffle Resolution)

Specify the timing resolution in terms of a note value. The note value can be specified as either an 16th note or an eighth note.

Value: ,

Multi Step Modulator



Step (Step Indicator)

This indicates the current location within the step sequence.

Step Bar

This graphically shows the sixteen steps. The step bar shown at the far right (number 17) is the same as the one that appears at the far left (number 1). This is helpful when you're setting up a looping sequence.

HINT

If you touch <▼ MENU > and select Hand Draw, you'll be able to draw the changes by directly touching the graph.

HINT

If you touch <SMOOTH >, the graph will become a (smooth) line graph.

If you touch <STEP >, the graph will become a bar graph.

Step knob (Step knobs)

Use these knobs to input the sixteen steps.

HINT

The V-Synth XT's E1–E8 knobs correspond to knobs 1–8 and 9–16. To switch between 1–8 and 9–16, hold down the [SHIFT] key and use the cursor up/down [▲] [▼] buttons (the frame in the screen will move).

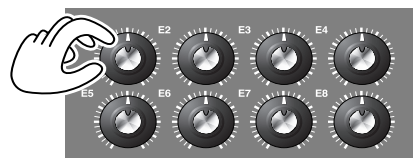

Step Switch (Step modulator switch)

This turns the multi step modulator on/off.

Value: OFF, ON

* This setting applies to all tracks (Track A–D).

Creating a Patch

Key Sync (Step modulator key sync)

This specifies whether the step sequence will be reset (i.e., will play from the beginning) when a note-on occurs.

Value

Off: The step sequence will not be reset when a note-on occurs.

Part: The step sequence will be reset when a note-on occurs, but will not be reset if the key was played legato.

Voice: The step sequence will be reset each time a note-on occurs.

* This setting applies to all tracks (Track A–D).

Track Button A–D (Step modulator track buttons A–D)

These turn the multi step modulator on/off for the four tracks (A–D).

Value: OFF, ON

Track TAB A–D (Step modulator track tabs A–D)

These access the editing screens for the four multi step modulator tracks (A–D).

Loop (Step modulator loop switch)

This turns looping on/off for the step sequence.

Value: OFF, ON

Grid (Step grid)

This specifies the note value of each step.

Value:

♩ (Quarter note), ♪ (Eighth note), ♪. (Dotted eighth note),
 ♪ (Sixteenth note), ♪. (Dotted sixteenth note), ♪ (Thirty-second note)

End P (Step modulator end point)

This specifies the sequence length as a number of steps.

Value: 1–16

Dir (Step modulator direction)

This specifies the direction in which the step sequence will play.

Value:

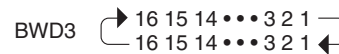
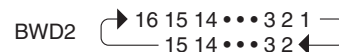
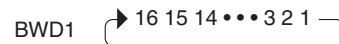
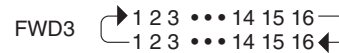
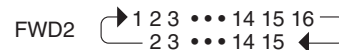
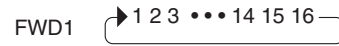

Zone (Step modulator zone)

This specifies the zone to which the step modulator will be applied.

Value: 1–16

Destination (Step modulator destination)

The parameter that is controlled by the step sequence will depend on the patch. Touch < List > to change the parameter that is controlled.

STEP/SMOOTH (Step/Smooth switch)

Touch < SMOOTH > to select a line graph (smooth change), or touch < STEP > to select a bar graph (stepped change).

Value: STEP, SMOOTH

Multi Step Modulator menu

In the Multi Step Modulator screen you can touch < ▼ MENU > to access the following menu.

| | |
|----------------------|---|
| Reset Value | Resets the step bar |
| Invert Value | Inverts the step bar in the vertical direction |
| Reverse Value | Inverts the step bar in the left/right direction |
| Shift Value R | Moves the step bar one step toward the right |
| Shift Value L | Moves the step bar one step toward the left |
| Preset... | Recalls a preset graph |
| Copy Graph... | Copies the step bar graph. You can copy a graph between patches or tracks (A–D). |
| Hand Draw | If this is checked, you can draw the graph by directly touching the step bars with your finger. |

Tune

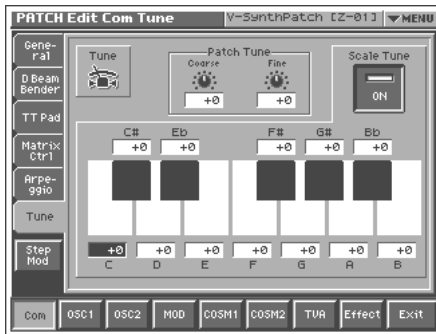

Patch Coarse Tune

Adjusts the pitch of the patch's sound up or down in semitone steps (+/-4 octaves).

Value: -48- +48

Patch Fine Tune

Adjusts the pitch of the patch's sound up or down in 1-cent steps (+/-50 cents).

Value: -50- +50

MEMO

One cent is 1/100th of a semitone.

Scale Tune (Scale Tune Switch)

Turn this on when you wish to use a tuning scale other than equal temperament.

Value: OFF, ON

The V-Synth XT allows you to play the keyboard using temperaments other than equal temperament. The pitch is specified in one-cent units relative to the equal tempered pitch.

MEMO

- One-cent is 1/100th of a semitone.
- The selected scale applies to MIDI messages received from an external MIDI device.

Equal Temperament

This tuning divides the octave into 12 equal parts, and is the most widely used method of temperament used in Western music. The V-Synth XT employs equal temperament when the Scale Tune Switch is set to "OFF."

Just Temperament (Tonic of C)

Compared with equal temperament, the principle triads sound pure in this tuning. However, this effect is achieved only in one key, and the triads will become ambiguous if you transpose.

Arabian Scale

In this scale, E and B are a quarter note lower and C#, F# and G# are a quarter-note higher compared to equal temperament. The intervals between G and B, C and E, F and G#, Bb and C#, and Eb and F# have a natural third—the interval between a major third and a minor third. On the V-Synth XT, you can use Arabian temperament in the three keys of G, C and F.

<Example>

| Note name | Equal temperament | Just Temperament (tonic C) | Arabian Scale |
|-----------|-------------------|----------------------------|---------------|
| C | 0 | 0 | -6 |
| C# | 0 | -8 | +45 |
| D | 0 | +4 | -2 |
| Eb | 0 | +16 | -12 |
| E | 0 | -14 | -51 |
| F | 0 | -2 | -8 |
| F# | 0 | -10 | +43 |
| G | 0 | +2 | -4 |
| G# | 0 | +14 | +47 |
| A | 0 | -16 | 0 |
| Bb | 0 | +14 | -10 |
| B | 0 | -12 | -49 |

Scale Tune C-B

Make scale tune settings.

Value: -100- +100

Modifying Waveforms (OSC1/OSC2)

Oscillator Switch

Switches the oscillator on/off.

Value: OFF, ON

OSC Type

Analog Oscillator



PCM Oscillator



Oscillator Type

Selects the type of oscillator.

If you choose "EXT IN," the signal from the front panel MIC jack, the rear panel INPUT jacks, or an audio signal being received from a USB-connected computer via USB audio will be used as the oscillator. This lets you play the externally input signal from the keyboard.

Value

ANALOG: Analog Oscillator

PCM: PCM Oscillator

EXT IN: External Input Oscillator

Wave Gain

Sets the gain (amplification) of the waveform.

Value: -12- +12 dB

ANALOG OSC

Waveform (Analog Oscillator Waveform)

Selects the wave upon which the sound is to be based when using an analog oscillator.

Value

| Waveform | Third tab | Fourth tab |
|--|--------------------|-------------------------------|
| SAW: Sawtooth wave | Pulse Width (P.88) | Fat (P.89) / Detune (P.89) *1 |
| SQUARE: Square wave | Pulse Width (P.88) | Fat (P.89) / Detune (P.89) *1 |
| TRI: Triangle wave | Pulse Width (P.88) | Fat (P.89) / Detune (P.89) *1 |
| SINE: Sine wave | Pulse Width (P.88) | Fat (P.89) / Detune (P.89) *1 |
| RAMP: Ramp wave | Pulse Width (P.88) | Fat (P.89) / Detune (P.89) *1 |
| JUNO: Modulated sawtooth wave | Pulse Width (P.88) | Fat (P.89) / Detune (P.89) *1 |
| HQ-SAW: High quality sawtooth wave | Pulse Width (P.88) | Fat (P.89) |
| HQ-SQUARE: High quality square wave | Pulse Width (P.88) | Fat (P.89) |
| NOISE: Noise wave | Pulse Width (P.88) | Fat (P.89) |
| LA-SAW: LA sawtooth wave *2 | Pulse Width (P.88) | Fat (P.89) / Detune (P.89) *1 |
| LA-SQUARE: LA square wave *2 | Pulse Width (P.88) | Fat (P.89) / Detune (P.89) *1 |
| SUPER-SAW: Super Saw *3 | Detune (P.89) | Mix (P.90) |
| FEEDBACK-OSC: Feedback Oscillator *3 | Harmonics (P.90) | FBK Amount (P.90) |
| X-MOD-OSC: Cross Modulation Oscillator *3 | X-MOD (P.91) | Fat (P.89) |

*1 If you use the sub-oscillator (P.87), the Fat will change to the Detune.

*2 "LA-SAW" and "LA-SQR" simulate waveforms used in the LA (Linear Arithmetic) sound generator of the Roland D-50. These produce a more mild and fat sound than the conventional "SAW" and "SQR."

*3 "SUPER-SAW," "FEEDBACK-OSC," and "X-MOD-OSC" simulate waveforms used in the Roland JP-8000/JP-8080. The V-Synth XT significantly enhances this functionality by letting you control these parameters by an envelope and by applying COSM.

SUPER-SAW (Super Saw)

This sounds like seven sawtooth waveforms sounding simultaneously. Pitch-shifted sounds are added to a central sound. It is especially suitable for creating thick string-type sounds.

FEEDBACK OSC (Feedback Oscillator)

This sound is similar to electric guitar feedback. It is suitable for creating hard and aggressive sounds that stand out.

X-MOD-OSC (Cross Modulation Oscillator)

Cross Modulation is when OSC2 modify the frequency of OSC1.

Sub-Oscillator (ANALOG)

The sub-oscillator adds a low pitch to create a thicker sound. You can use the Detune parameter to add a detune effect.

MEMO

Detune is the effect or technique of adding (layering) a sound at a slightly different pitch. When using the sub-oscillator, you can apply a detune effect by setting Detune to a value other than “0.”

Octave Select (Sub Oscillator Octave Select)

When using the sub-oscillator, this specifies the number of octaves below the basic pitch at which it will be sounded.

Value

OFF: The sub-oscillator will not be used.

-2: The sub-oscillator will be added two octaves below the basic pitch.

-1: The sub-oscillator will be added one octave below the basic pitch.

0: The sub-oscillator will be added at the same pitch as the basic pitch.

NOTE

If you use the sub-oscillator (i.e., when the value is -2, -1, or 0), the Fat parameter will be ignored.

Sub Level (Sub Oscillator Level)

Specifies the volume of the sub oscillator.

Value: 0–127

Impact (Analog Oscillator Impact)

Specifies the sharpness of the attack of the analog oscillator. Higher settings will produce a sharper attack.

Value: 0.0–4.0

PCM OSC

Waveform (PCM Oscillator Waveform)

Selects the wave upon which the sound is to be based when using a PCM oscillator.

Value: 1–999 (wave number)

HINT

When you touch <List>, the Wave List window will appear, allowing you to select the wave from the list.

MEMO

When you select a wave, the wave name, encoding type, and stereo/mono will also be displayed.

Start Offset (PCM Oscillator Start Offset)

Specifies the starting address of the wave.

Value: 0–**

Playback Mode (PCM Oscillator Playback Mode)

Specifies how the wave will be assigned to each key.

Value

RETRIGGER: The sample will play back from the beginning each time you play a key.

LEGATO: When you play legato, the playback point will be synchronized with the currently playing sound.

STEP: Each time you play a key, the sample will play back to the next event (p. 120) and then stop.

EVENT: The sample will be divided at each event and assigned to separate keys. Each time you press a key, the sample will play from the beginning of the corresponding event.

Vari Sw (PCM Oscillator Vari Switch)

Switches whether the sound will be produced using Vari Phrase (ON) or linearly (OFF).

Value: OFF, ON

Time Trip Sw (Time Trip Switch)

Selects whether Time Trip will operate (ON) or not (OFF).

Value: OFF, ON

Beat Keep (Time Trip Beat Keep)

After Time Trip is operated, this selects whether you will “chase” to the beat location where you otherwise would have been if Time Trip had not been operated (ON), or whether this “chase” will not occur (OFF).

Value: OFF, ON

Loop (PCM Oscillator Loop Switch)

Specifies whether the wave will be played as a loop (ON) or not (OFF).

Value: OFF, ON

Robot Voice (PCM Oscillator Robot Voice Switch)

Specifies whether the pitch of the wave will be held steady (ON) or not (OFF).

Value: OFF, ON

Tempo Sync (PCM Oscillator Tempo Sync Switch)

Specifies whether the wave will be sounded in sync with the tempo clock (ON) or not (OFF).

Value: OFF, ON

Creating a Patch

Pitch



Pitch (Oscillator Pitch) ★

Adjusts the pitch of the oscillator.

Value: -63– +63

Pitch KF (Oscillator Pitch Key Follow)

This specifies the amount of pitch change that will occur when you play a key one octave higher (i.e., 12 keys upward on the keyboard). If you want the pitch to rise one octave as on a conventional keyboard, set this to “+100.” If you want the pitch to rise two octaves, set this to “+200.” Conversely, set this to a negative value if you want the pitch to fall. With a setting of “0,” all keys will produce the same pitch.

Value: -200– +200

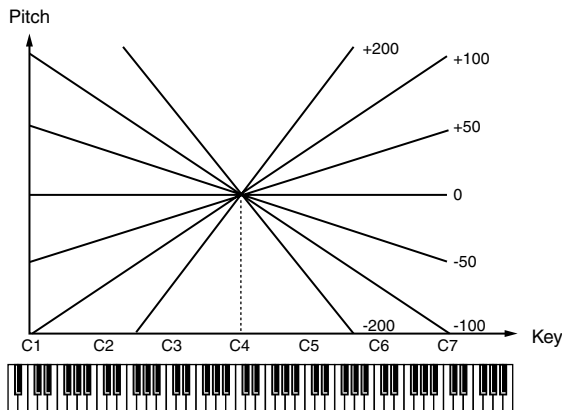

Coarse (Oscillator Coarse Tune)

Adjusts the pitch of the oscillator up or down in semitone steps (+/-4 octaves).

Value: -48– +48

Fine (Oscillator Fine Tune)

Adjusts the pitch of the oscillator up or down in 1-cent steps (+/-50 cents).

Value: -50– +50

MEMO

One cent is 1/100th of a semitone.

Random (Oscillator Random Pitch Depth)

This specifies the width of random pitch deviation that will occur each time a key is pressed. If you do not want the pitch to change randomly, set this to “0.” These values are in units of cents (1/100th of a semitone).

Value: 0, 1, 2, 3, 4, 5, 6, 7, 8, 9, 10, 20, 30, 40, 50, 60, 70, 80, 90, 100, 200, 300, 400, 500, 600, 700, 800, 900, 1000, 1100, 1200

Pit LFO Dp (Oscillator Pitch LFO Depth) ★

Specifies how deeply the LFO will affect pitch.

Value: -63– +63



In this screen you can make settings for the envelope that affects the pitch. For details on envelope settings, refer to “**Making Envelope Settings**” (p. 95).

Pulse Width (ANALOG)

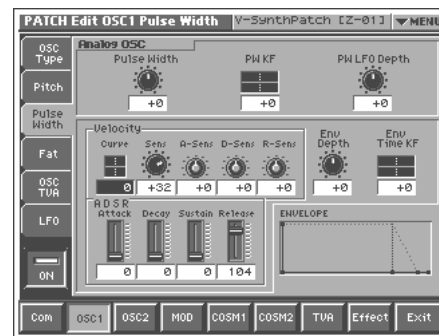

Pulse Width ★

Specifies the amount by which the wave shape will be modified.

Value: -63– +63

PW KF (Pulse Width Key Follow)

Specifies the amount by which the pulse width value will be affected by the key you play.

Value: -200– +200

PW LFO Depth (Pulse Width LFO Depth) ★

Specifies how deeply the LFO will affect pulse width.

Value: -63– +63



In this screen you can make settings for the envelope that affects the pulse width. For details on envelope settings, refer to “**Making Envelope Settings**” (p. 95).

Fat (ANALOG)



Fat ★

Emphasizes the low-frequency region of the sound.

Value: 0–127

Fat KF (Fat Key Follow)

Specifies the amount by which the fat value will be affected by the key you play.

Value: -200– +200

Fat LFO Depth ★

Specifies how deeply the LFO will affect fat.

Value: -63– +63



In this screen you can make settings for the envelope that affects the fat. For details on envelope settings, refer to “**Making Envelope Settings**” (p. 95).

Detune (ANALOG, when using Sub OSC)



Detune

Specifies the detuning (pitch difference) of the sub-oscillator. This setting is valid if the Sub-Oscillator Octave Select is set to “-2, -1, or 0.”

Value: -63–+63

Detune KF (Detune Key Follow)

Specifies the amount by which the detune value will be affected by the key you play.

Value: -200- +200

Detune LFO Depth

Specifies how deeply the LFO will affect detune.

Value: -63- +63



In this screen you can make settings for the envelope that affects the detune. For details on envelope settings, refer to “**Making Envelope Settings**” (P.95).

Detune (ANALOG, when SUPER-SAW is selected)



Detune

Adjust the degree of pitch detuning. As the knob is rotated to the right, the pitch will be detuned more greatly, making the sound more spacious.

Value: -63+63

Detune KF (Detune Key Follow)

Specifies the amount by which the detune value will be affected by the key you play.

Value: -200- +200

Detune LFO Depth

Specifies how deeply the LFO will affect detune.

Value: -63- +63



In this screen you can make settings for the envelope that affects the detune. For details on envelope settings, refer to “**Making Envelope Settings**” (P.95).

Creating a Patch

Mix (ANALOG, when SUPER-SAW is selected)



Mix

Adjust the volume of the detuned sounds relative to the central sound. As the knob is rotated to the right, the detuned sounds will become louder, making the sound thicker.

Value: -63+63

Mix KF (Mix Key Follow)

Specifies the amount by which the Mix value will be affected by the key you play.

Value: -200- +200

Mix LFO Depth

Specifies how deeply the LFO will affect Mix.

Value: -63- +63



In this screen you can make settings for the envelope that affects the Mix. For details on envelope settings, refer to “Making Envelope Settings” (P.95).

Harmonics (ANALOG, when FEEDBACK-OSC is selected)

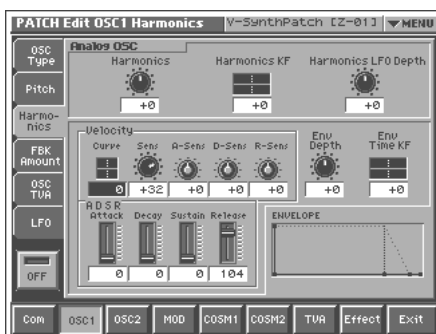

Harmonics

Vary the sound of the harmonics.

Value: -63+63

Harmonics KF (Harmonics Key Follow)

Specifies the amount by which the Harmonics value will be affected by the key you play.

Value: -200- +200

Harmonics LFO Depth

Specifies how deeply the LFO will affect Harmonics.

Value: -63- +63



In this screen you can make settings for the envelope that affects the Harmonics. For details on envelope settings, refer to “Making Envelope Settings” (P.95).



You can create distinctive effects by applying an LFO or envelope to HARMONICS or FBK AMOUNT.

FBK Amount (ANALOG, when FEEDBACK-OSC is selected)



FBK Amount (Feedback Amount)

Adjust the amount of feedback to adjust the level of the harmonics.

Value: -63+63

Amount KF (Amount Key Follow)

Specifies the amount by which the feedback value will be affected by the key you play.

Value: -200- +200

Amount LFO Depth

Specifies how deeply the LFO will affect feedback.

Value: -63- +63



In this screen you can make settings for the envelope that affects the feedback. For details on envelope settings, refer to “Making Envelope Settings” (P.95).



You can create distinctive effects by applying an LFO or envelope to HARMONICS or FBK AMOUNT.

X-MOD (ANALOG, when X-MOD-OSC is selected)



X-MOD (Cross Modulation Depth)

Cross Modulation is when OSC2 modify the frequency of OSC1. [X-MOD] adjusts the depth of this Cross Modulation. As the knob is rotated toward the right, the sound of OSC1 will become more complex, with more overtones, and will be suitable for creating metallic sounds and sound effects.

Value: -63+63



“Cross Modulation Depth” can be selected only for OSC1.



“Cross Modulation Depth” does nothing if OSC2 is off.

X-MOD KF (X-MOD Key Follow)

Specifies the amount by which the Cross Modulation value will be affected by the key you play.

Value: -200- +200

X-MOD LFO Depth

Specifies how deeply the LFO will affect Cross Modulation.

Value: -63- +63



In this screen you can make settings for the envelope that affects the Cross Modulation. For details on envelope settings, refer to “Making Envelope Settings” (p. 95).

Time (PCM)



Time ★

This sets the range of change in playback speed (time).

Value: -63+ 63

<How the Time parameter is related to playback speed>

| Time | -40 | -20 | 0 | 20 | 40 |
|------|------------------|------------------|------------------|--------------|--------------|
| FWD | Reverse playback | Stop | Normal speed | 2x speed | 4x speed |
| ZERO | -2x speed | Reverse playback | Stop | Normal speed | 2x speed |
| BWD | 4x speed | -2x speed | Reverse playback | Stop | Normal speed |

Time KF (Time Key Follow)

Specifies the amount by which the time value will be affected by the key you play.

Value: -200- +200

Time Offset

Specifies the basic speed for a time value of “0”.

Value

BWD: Specifies a backward direction.

ZERO: Specifies a pause.

FWD: Specifies a forward direction.

Time LFO Depth ★

Specifies how deeply the LFO will affect time.

Value: -63- +63



In this screen you can make settings for the envelope that affects the time. For details on envelope settings, refer to “Making Envelope Settings” (p. 95).

Creating a Patch

Formant (PCM)

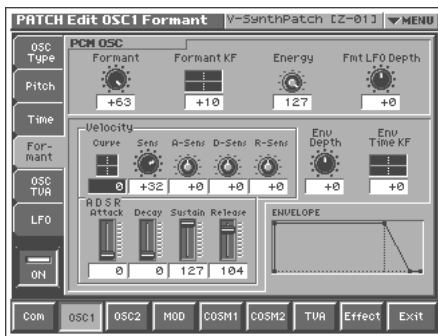

NOTE

The parameters of this screen are ignored when the Vari switch (p. 87) is off and when the Encode Type (p. 119) is "BACKING" or "ENSEMBLE."

Formant ★

This sets the range of change in vocal quality (formant).

Value: -63– +63

Formant KF (Formant Key Follow)

Specifies the amount by which the formant value will be affected by the key you play.

Value: -200– +200

Energy

Specifies how much the fundamental pitch will be emphasized in order to make the sound more well-defined. Set this to "OFF" if you do not want to use the Energy parameter.

Value: OFF, 1–127

Fmt LFO Depth (Formant LFO Depth) ★

Specifies how deeply the LFO will affect formant.

Value: -63– +63



In this screen you can make settings for the envelope that affects the formant. For details on envelope settings, refer to "Making Envelope Settings" (p. 95).

OSC TVA



Level ★

Specifies the volume of the oscillator.

Value: 0–127

Level KF (Level Key Follow)

Use this parameter if you want the volume of the oscillator to change according to the key that is pressed. Relative to the volume at the C4 key (center C), positive (+) settings will cause the volume to rise for notes higher than C4, and negative (-) settings will cause the volume to fall for notes higher than C4. Larger settings will produce greater change.

Value: -200– +200

Level LFO Dp (Level LFO Depth) ★

Specifies how deeply the LFO will affect the volume of the oscillator.

Value: -63– +63



In this screen you can make settings for the envelope that affects the sub TVA. For details on envelope settings, refer to "Making Envelope Settings" (p. 95).

LFO



In this screen you can make settings for the LFO that affects the oscillator. For details on LFO settings, refer to "Making LFO Settings" (p. 96).

Mixing/Modulating Two Sounds (MOD)

Modulator Switch

Switches the modulator on/off.

Value: OFF, ON

Mod Type

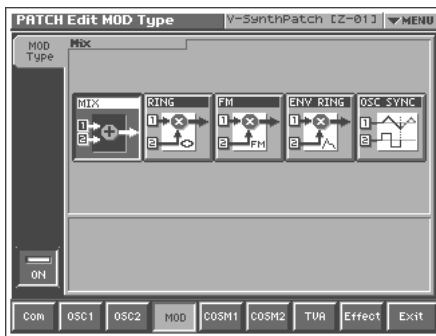

Modulator Type

Selects the type of modulator.

Value

MIX: Add OSC1 and OSC2.

RING: Use OSC2 to apply ring modulation to OSC1.

FM: Use OSC2 to apply FM (frequency modulation) to OSC1.

ENV RING: Use the envelope of OSC2 to control the volume of OSC1.

OSC SYNC: Synchronize the output waveform of OSC1 to the output waveform of OSC2.

NOTE

OSC SYNC is valid only when OSC2 is an analog oscillator.

Original Level (Modulator Original Level)

Specifies the volume for the original sound of OSC1.

Value: 0–127

MEMO

This can be set if Modulator Type is set to “RING” or “FM.”

Attack (Modulator Attack Time)

Specifies the attack time of the OSC2 envelope.

Value: 0–127

MEMO

This can be set if Modulator Type is set to “ENV RING.”

Release (Modulator Release Time)

Specifies the release time of the OSC2 envelope.

Value: 0–127

MEMO

This can be set if Modulator Type is set to “ENV RING.”

Applying Various Effects to Each Note You Play (COSM1/COSM2)

COSM Switch

Switches the COSM on/off.

Value: OFF, ON

COSM Type



COSM Type

Use this parameter to select from among the 16 available COSMs.

For details on COSM parameters, refer to “COSM Parameters” (p. 159).

Value: THRU, OD/DS, W-SHAPE, AMP, SPEAKER, RESONATOR, SBF1/2, COMB, DUAL, TVF, DYN-TVF, COMP, LIMITER, F-SHIFT, LO-FI, TB FILTER

LFO



NOTE

For some COSM selections that you choose in COSM Type, you can make LFO settings. For details on LFO settings, refer to “Making LFO Settings” (p. 96).

Creating a Patch

Adjusting the Volume and Pan (TVA)

TVA Switch

Switches the TVA on/off.

Value: OFF, ON

TVA

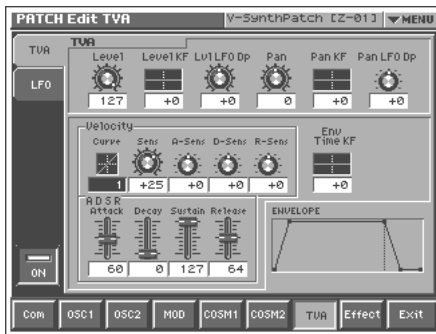

Level ★

Specifies the volume of the patch.

Value: 0–127

Level KF (Level Key Follow)

Use this parameter if you want the volume of the patch to change according to the key that is pressed. Relative to the volume at the C4 key (center C), positive (+) settings will cause the volume to rise for notes higher than C4, and negative (-) settings will cause the volume to fall for notes higher than C4. Larger settings will produce greater change.

Value: -200– +200

Lvl LFO Dp (Level LFO Depth) ★

Specifies how deeply the LFO will affect the volume of the patch.

Value: -63– +63

Pan

Specifies the pan of the patch. “L64” is far left, “0” is center, and “63R” is far right.

Value: L64–0–63R

Pan KF (Pan Key Follow)

Use this parameter if you want key position to affect panning. Positive (+) settings will cause notes higher than C4 key (center C) to be panned increasingly further toward the right, and negative (-) settings will cause notes higher than C4 key (center C) to be panned toward the left. Larger settings will produce greater change.

Value: -200– +200

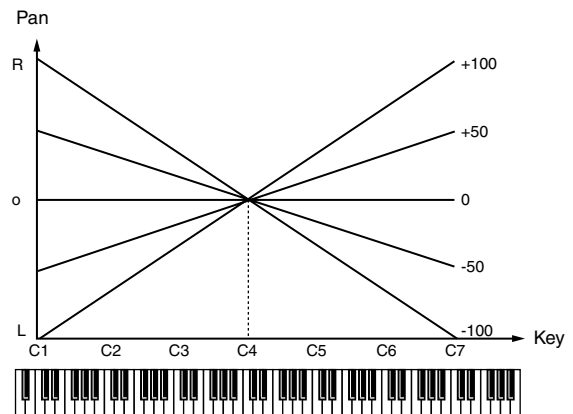

Pan LFO Dp (Pan LFO Depth) ★

Specifies how deeply the LFO will affect the pan.

Value: -63– +63



In this screen you can make settings for the envelope that affects the TVA. For details on envelope settings, refer to “**Making Envelope Settings**” (p. 95).

LFO



In this screen you can make settings for the LFO that affects the TVA. For details on LFO settings, refer to “**Making LFO Settings**” (p. 96).

Making Envelope Settings

This section explains the envelope setting screens.

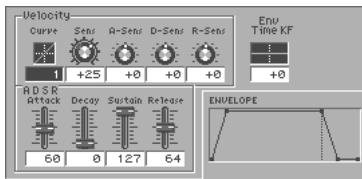

Velocity Curve (Envelope Velocity Curve)

Choose from the following seven curves to specify how your keyboard playing strength will affect the envelope depth. If you don't want your keyboard playing strength to affect the envelope depth, set this to "0".

Value: 0-7

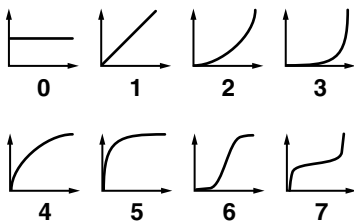

Velocity Sens (Envelope Velocity Sensitivity)

Keyboard playing dynamics can be used to control the depth of the envelope. If you want the envelope to have more effect for strongly played notes, set this parameter to a positive (+) value. If you want the pitch envelope to have less effect for strongly played notes, set this to a negative (-) value.

Value: -63- +63

Velocity A-Sens (Envelope Attack Time Velocity Sensitivity)

This allows keyboard dynamics to affect the attack time of the envelope. If you want attack time to be speeded up for strongly played notes, set this parameter to a positive (+) value. If you want it to be slowed down, set this to a negative (-) value.

Value: -63- +63

Velocity D-Sens (Envelope Decay Time Velocity Sensitivity)

This allows keyboard dynamics to affect the decay time of the envelope. If you want decay time to be speeded up for strongly played notes, set this parameter to a positive (+) value. If you want it to be slowed down, set this to a negative (-) value.

Value: -63- +63

Velocity R-Sens (Envelope Release Time Velocity Sensitivity)

The parameter to use when you want key release speed to control the release time value of the envelope. If you want release time to be speeded up for quickly released notes, set this parameter to a positive (+) value. If you want it to be slowed down, set this to a negative (-) value.

Value: -63- +63

ADSR Attack (Envelope Attack Time) ★

Specifies the attack time of the envelope (the time from when you press a key until the envelope level reaches the maximum value).

Value: 0-127, Note

ADSR Decay (Envelope Decay Time) ★

Specifies the decay time of the envelope (the time from when the envelope level reaches the maximum value until it falls to a constant value).

Value: 0-127, Note

ADSR Sustain (Envelope Sustain Level) ★

Specifies the sustain level of the envelope (the level at which the envelope remains constant).

Value: 0-127

ADSR Release (Envelope Release Time) ★

Specifies the release time of the envelope (the time from when you release a key until the envelope level reaches 0).

Value: 0-127, Note

MEMO

"ENVELOPE" in the lower right of the screen shows a graphical representation of the envelope produced by the current settings.

Env Time KF (Envelope Time Key Follow)

Make this setting when you want the decay time and subsequent times of the envelope to be affected by the location of the key you play. Based on the envelope times for the C4 key (center C), positive (+) settings will cause notes higher than C4 to have increasingly shorter times, and negative (-) settings will cause them to have increasingly longer times. Larger settings will produce greater change.

Value: -200- +200

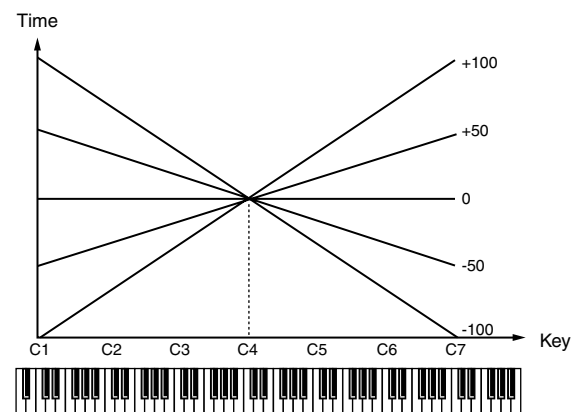

Creating a Patch

Making LFO Settings

This section explains the LFO setting screens.

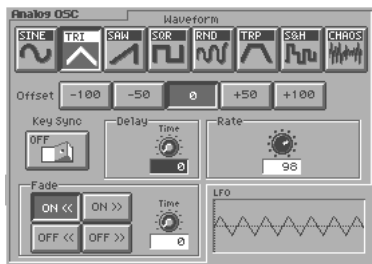

Waveform (LFO Waveform)

Selects the waveform of the LFO.

Value

SIN: Sine wave

TRI: Triangle wave

SAW: Sawtooth wave

SQR: Square wave

RND: Random wave

TRP: Trapezoidal wave

S&H: Sample & Hold wave (one time per cycle, LFO value is changed)

CHAOS: Chaos wave

MEMO

"LFO" in the lower right of the screen shows a wave graphic that corresponds to the current settings.

Offset (LFO Offset)

Raises or lowers the LFO waveform relative to the central value. Positive (+) settings will move the waveform so that modulation will occur from the central value upward. Negative (-) settings will move the waveform so that modulation will occur from the central value downward.

Value: -100, -50, 0, +50, +100

Key Sync (LFO Key Sync Switch)

This specifies whether the LFO cycle will be synchronized to begin when the key is pressed (ON) or not (OFF).

Value: OFF, ON

Delay Time (LFO Delay Time)

Delay Time (LFO Delay Time) specifies the time elapsed before the LFO effect is applied (the effect continues) after the key is pressed (or released).

Value: 0-127

MEMO

After referring to "How to Apply the LFO" (p. 97), change the setting until the desired effect is achieved.

Rate (LFO Rate) ★

Adjusts the modulation rate, or speed, of the LFO.

Value: 0-127, Note

LFO Rate sets the beat length for the synchronized tempo when the tempo that specifies the LFO cycle (Patch Tempo) is synchronized with the tempo set in a external sequencer.

(Example)

For a tempo of 120 (120 quarter notes occur in 1 minute (60 seconds))

| Setting | Delay time |
|------------------|--|
| ♩ (half note) | 1 second (60 / 60 = 1 (second)) |
| ♩ (quarter note) | 0.5 seconds (60 / 120 = 0.5 (seconds)) |
| ♩ (eighth note) | 0.25 seconds (60 / 240 = 0.25 (seconds)) |

NOTE

This setting will be ignored if the Waveform parameter is set to "CHAOS."

MEMO

"LFO" in the lower right of the screen shows a diagram of the wave cycle that corresponds to the current settings.

Fade Mode (LFO Fade Mode)

Specifies how the LFO will be applied.

Value: ON <<, ON >>, OFF <<, OFF >>

MEMO

After referring to "How to Apply the LFO" (p. 97), change the setting until the desired effect is achieved.

Fade Time (LFO Fade Time)

Specifies the time over which the LFO amplitude will reach the maximum (minimum).

Value: 0-127

MEMO

After referring to "How to Apply the LFO" (p. 97), change the setting until the desired effect is achieved.

How to Apply the LFO

● Apply the LFO gradually after the key is pressed

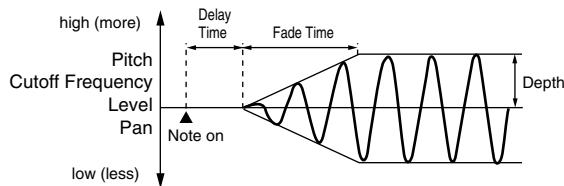

Fade Mode: ON <<

Fade Time: The time over which the LFO amplitude will reach the maximum after the Delay Time has elapsed.

Delay Time: The time from when the keyboard is played until the LFO begins to be applied.

● Apply the LFO immediately when the key is pressed, and then gradually begin to decrease the effect

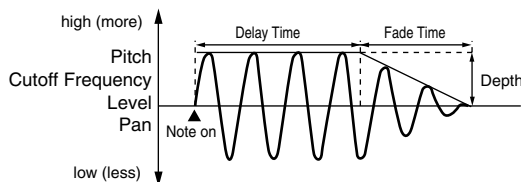

Fade Mode: ON >>

Fade Time: The time over which the LFO amplitude will reach the minimum after the Delay Time has elapsed.

Delay Time: The time that the LFO will continue after the keyboard is played.

● Apply the LFO gradually after the key is released

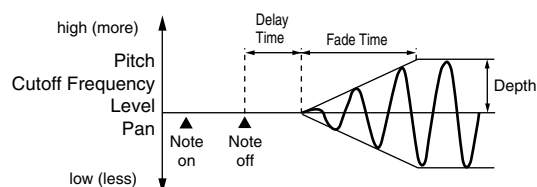

Fade Mode: OFF <<

Fade Time: The time over which the LFO amplitude will reach the maximum after the Delay Time has elapsed.

Delay Time: The time from when the keyboard is released until the LFO begins to be applied.

● Apply the LFO from when the key is pressed until it is released, and gradually begin to decrease the effect when the key is released

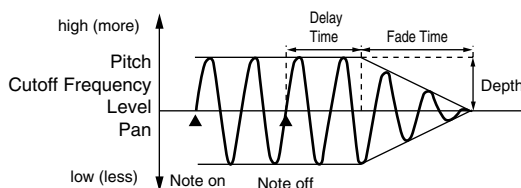

Fade Mode: OFF >>

Fade Time: The time over which the LFO amplitude will reach the minimum after the Delay Time has elapsed.

Delay Time: The time that the LFO will continue after the keyboard is released.

Setting Effects for a Patch (Effect)

Routing

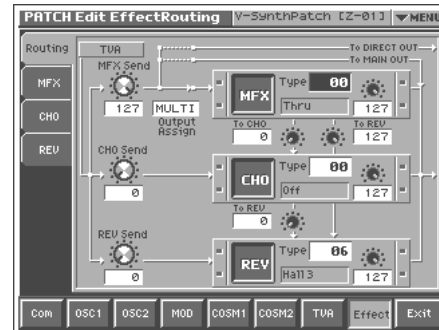

MFX Send (MFX Send Level) ★

Sets the level of the signal sent to MFX.

Value: 0–127

CHO Send (Chorus Send Level) ★

Sets the level of the signal sent to chorus.

Value: 0–127

REV Send (Reverb Send Level) ★

Sets the level of the signal sent to reverb.

Value: 0–127

Output Assign

Sets the direct sound's output method.

Value

MULTI: Output in stereo through MFX. You can also apply chorus or reverb to the sound that passes through MFX.

MAIN: Output to the MAIN OUT jacks in stereo without passing through MFX.

DIR: Output to the DIRECT OUT jacks in stereo without passing through MFX. Make this setting when you want to use external effects.

MFX (MFX On/Off Switch)

Switches MFX on and off.

Value: (OFF), (ON)

MFX Type

Use this parameter to select from among the 41 available MFX. For details on MFX parameters, refer to "MFX Parameters" (p. 164).

Value: 00 (Thru)–41

MFX Master Level

Adjusts the volume of the sound that has passed through the MFX.

Value: 0–127

Creating a Patch

MFX To CHO (MFX Chorus Send Level)

Adjusts the amount of chorus for the sound that passes through MFX. If you don't want to add the Chorus effect, set it to "0."

Value: 0–127

MFX To REV (MFX Reverb Send Level)

Adjusts the amount of reverb for the sound that passes through MFX. If you don't want to add the Reverb effect, set it to "0."

Value: 0–127

CHO (Chorus On/Off Switch)

Switches chorus on and off.

Value: (OFF), (ON)

CHO Type (Chorus Type)

Use this parameter to select from among the 8 available chorus. For details on chorus parameters, refer to "Chorus Parameters" (p. 186).

Value: 00 (Off)–08

CHO Master Level (Chorus Master Level)

Adjusts the volume of the sound that has passed through chorus.

Value: 0–127

CHO To REV (Chorus Reverb Send Level)

Adjusts the amount of reverb for the sound that passes through chorus. If you don't want to add the Reverb effect, set it to "0."

Value: 0–127

REV (Reverb On/Off Switch)

Switches reverb on and off.

Value: (OFF), (ON)

REV Type (Reverb Type)

Use this parameter to select from among the 10 available reverb. For details on reverb parameters, refer to "Reverb Parameters" (p. 186).

Value: 00 (Off)–10

REV Master Level (Reverb Master Level)

Adjusts the volume of the sound that has passed through reverb.

Value: 0–127

MFX

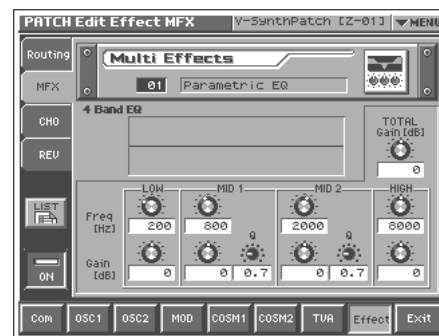

MFX Type

Use this parameter to select from among the 41 available MFX. For details on MFX parameters, refer to "MFX Parameters" (p. 164).

Value: 00 (Thru)–41

In this setting screen, you can edit the parameters of the MFX that is selected by the MFX Type setting. For details on the parameters that can be edited, refer to "MFX Parameters" (p. 164).



When you touch <List>, the MFX List window will appear, allowing you to select the MFX from the list.

MFX Switch

Switches the MFX on/off.

Value: OFF, ON

CHO



CHO Type (Chorus Type)

Use this parameter to select from among the 8 available chorus. For details on chorus parameters, refer to "Chorus Parameters" (p. 186).

Value: 00 (Off)–08

In this setting screen, you can edit the parameters of the chorus that is selected by the CHO Type setting. For details on the parameters that can be edited, refer to "Chorus Parameters" (p. 186).



When you touch <List>, the Chorus List window will appear, allowing you to select the chorus from the list.

Chorus Switch

Switches the Chorus on/off.

Value: OFF, ON

REV

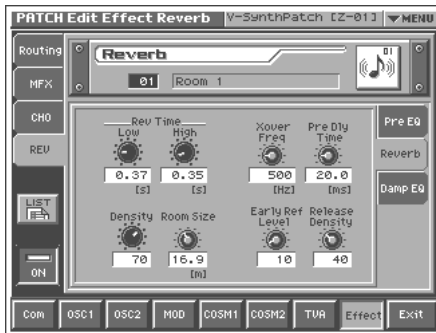

REV Type (Reverb Type)

Use this parameter to select from among the 10 available reverb. For details on reverb parameters, refer to “Reverb Parameters” (p. 186).

Value: 00 (Off)–10

In this setting screen, you can edit the parameters of the reverb that is selected by the REV Type setting. For details on the parameters that can be edited, refer to “Reverb Parameters” (p. 186).

HINT

When you touch <List>, the Reverb List window will appear, allowing you to select the reverb from the list.

Reverb Switch

Switches the Reverb on/off.

HINT

Value: OFF, ON

Zone Settings (Zone)

V-Synth XT lets you divide the keyboard into as many as sixteen zones, with each zone playing a different sound.

MEMO

The zone is shown in the upper right of the PATCH PLAY screen or EDIT screen. To move between zones, hold down [SHIFT] and use the left/right cursor ([◀], [▶]) keys.



MEMO

The following patch settings are applied in common to each of the individual sounds that are divided by zone.

- Common group settings (except for Structure Type)
- Effect group settings for MFX, Chorus, and Reverb type, and effect settings

Splitting the Keyboard to Play Different Sounds (Split)

A patch that contains settings to play different patches in each keyboard zone is called a **split patch**. Here’s how to create a split patch.

An indication of the note you play

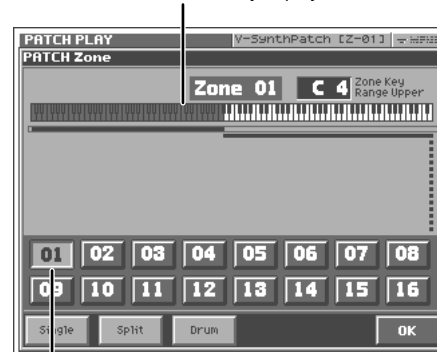

An indication of the zone for the note you play

1. Access the PATCH PLAY screen, and select the patch whose settings you wish to modify (p. 60).

HINT

If you want to create all your patches from the ground up, rather than the patches that have already been prepared, carry out the **Initialize** operation (p. 73).

Creating a Patch

2. Touch <▼ MENU> in the upper right of the screen.

A pulldown menu appears.

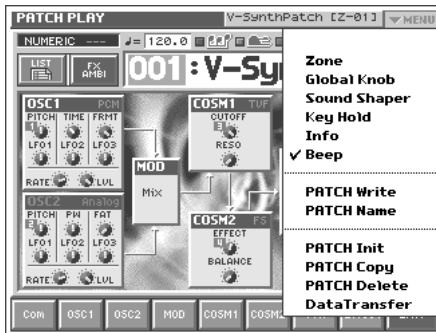

3. In the pulldown menu, touch <Zone>.

The PATCH Zone window appears.

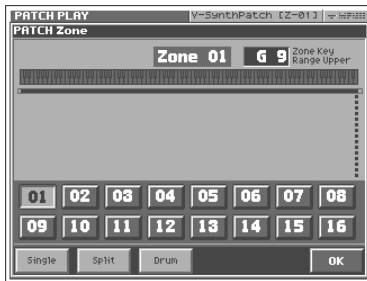

4. In the lower part of the screen, touch <Split>.

A window like the following appears.



5. Touch <01>.

Zone 01 will be selected, and the top note number of zone 01 will be displayed in the upper right of the screen.

6. Specify the split point between zones 01 and 02. Either turn the VALUE dial or use [INC][DEC] to specify the note number.

HINT

If you want to divide the keyboard into three zones, lower the top note of zone 02, and specify the split point between zones 02 and 03. By lowering the top note of the highest zone in this way, you can add more zones. You can specify a maximum of sixteen zones.

7. Touch <OK>.

The zones will be established, and you will return to the PATCH PLAY screen.

8. In this state, zone 01 is selected. Specify the sound that you want to play in zone 01.

9. After you have specified the sound that you want to play in zone 01, next specify the sound for zone 02.

The zone is shown in the upper right of the PATCH PLAY screen or EDIT screen. To move between zones, hold down [SHIFT] and use the left/right cursor ([◀], [▶]) keys.



10. Specify the sound that you want to play in zone 02.

In this way you can create a patch that plays different sounds on either side of the split point you specified in step 6.

11. To save the patch you created, perform the Write operation (p. 74).

Creating a Drum Patch (Drum)

By dividing the keyboard into sixteen zones and assigning a percussion instrument sound to each zone, you can create a patch that lets you play drums. Such a patch is called a **drum patch**. You can think of a drum patch as a group containing various percussion instrument sounds. Since percussion instrument sounds are not usually used to play melodies, you do not need to be able to use the keyboard to play a scale.

1. Access the PATCH PLAY screen, and select the patch whose settings you wish to modify (p. 60).

HINT

If you want to create all your patches from the ground up, rather than the patches that have already been prepared, carry out the **Initialize** operation (p. 73).

2. Touch <▼ MENU> in the upper right of the screen.
A pulldown menu appears.

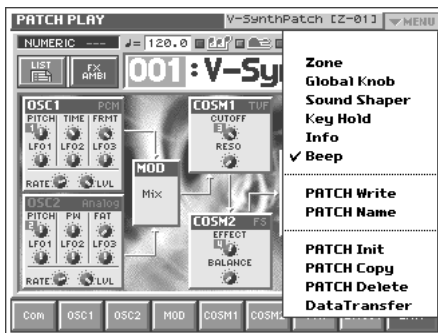

3. In the pulldown menu, touch <Zone>.
The PATCH Zone window appears.

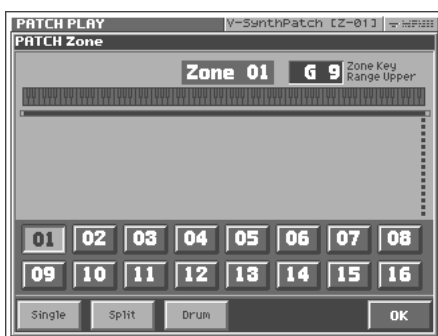

4. In the lower part of the screen, touch <Drum>.
A window like the following appears.

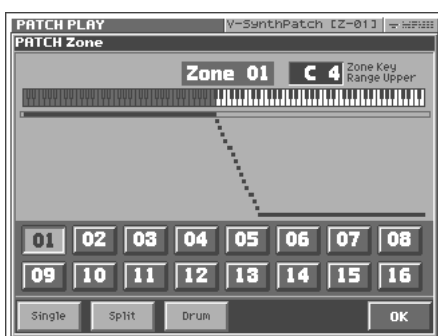

5. To change the split point of each zone, refer to the procedure described in the preceding section, "Splitting the Keyboard to Play Different Sounds (Split)."
6. Specify the sounds (percussion instrument sounds) that you want to play in each zone. For the procedure, refer to the procedure described in the preceding section, "Splitting the Keyboard to Play Different Sounds (Split)."
In this way you can create a patch that plays various percussion instrument sounds when you press different notes of the keyboard.
7. To save the patch you created, perform the Write operation (p. 74).

Creating a Rhythm Kit (Rhythm Mode)

Rhythm mode lets you assign a different V-Synth sound to each note of the keyboard. This means that you can play numerous different sounds from the keyboard, just as when using a rhythm kit like those often provided by synthesizer sound generators. Since the sound assigned to each key is a fully editable V-Synth sound, you can have a variety of sounds ranging from analog-style kicks to VariPhrase drum loops all standing by for immediate play.

The concept of a Rhythm Kit

The rhythm kits you play in Rhythm mode let you assign different sounds to each of the 61 notes. Each rhythm kit consists of up to five Drum Patches (p. 101).

| | | | | | | | | | |
|-----------------|----|------------|----|------------|----|------------|----|------------|----|
| C2 | B2 | C3 | B3 | C4 | B4 | C5 | B5 | C6 | C7 |
| PATCH: 493 | | PATCH: 494 | | PATCH: 495 | | PATCH: 496 | | PATCH: 497 | |
| Rhythm kit: R01 | | | | | | | | | |
| C2 | B2 | C3 | B3 | C4 | B4 | C5 | B5 | C6 | C7 |
| PATCH: 498 | | PATCH: 499 | | PATCH: 500 | | PATCH: 501 | | PATCH: 502 | |
| Rhythm kit: R02 | | | | | | | | | |
| C2 | B2 | C3 | B3 | C4 | B4 | C5 | B5 | C6 | C7 |
| PATCH: 503 | | PATCH: 504 | | PATCH: 505 | | PATCH: 506 | | PATCH: 507 | |
| Rhythm kit: R03 | | | | | | | | | |
| C2 | B2 | C3 | B3 | C4 | B4 | C5 | B5 | C6 | C7 |
| PATCH: 508 | | PATCH: 509 | | PATCH: 510 | | PATCH: 511 | | PATCH: 512 | |
| Rhythm kit: R04 | | | | | | | | | |

* As shown in the illustration, rhythm kits use patches number 493 and follows. Refer to the above illustration for the patch numbers used by each rhythm kit.

MEMO

A drum patch (p. 101) lets you specify up to sixteen zones of rhythm instrument sounds. To play these in Rhythm mode, you will use one octave of notes (12 notes) for each drum patch. However, as shown in the above illustration, the C6–C7 patch uses thirteen notes as an exception.

MEMO

The following patch settings are shared by the sounds you specify for each note.

- Arpeggiator settings
- MFx, chorus, and reverb types and effect parameter settings in the Effect group

These settings are saved in the first drum patch of the rhythm kit.

NOTE

In Rhythm mode, you can use eleven parts (non-rhythm parts) simultaneously. For this reason, the “Part MIDI” (p. 126) setting functions as follows.

- Part 1: The MIDI receive channel of the Rhythm part
- Part 2–12: Other parts (non-rhythm parts)
- Part 13–16: Not used

Playing in Rhythm mode

1. Press [MODE].
2. In the V-SYNTH XT MODE MENU window that appears, touch < RHYTHM >.

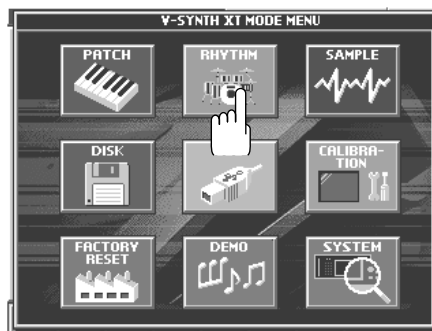

3. Use the keyboard or an external MIDI device to play the rhythm kit.
4. To switch rhythm kits, touch the area where the patch number is displayed to highlight it, then turn the VALUE dial or use [INC][DEC].



5. To exit RHYTHM mode, press [MODE], and then touch < PATCH > in the V-SYNTH XT MODE MENU window that appears.

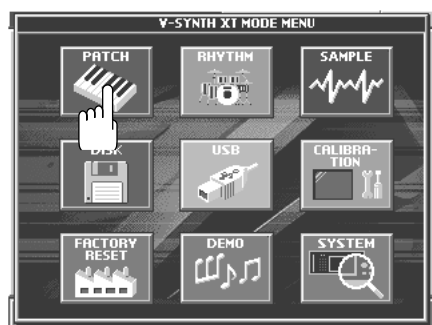

Creating a Rhythm Kit

In Rhythm mode, the level, panpot, and MFX (multi-effect)/chorus/reverb send levels for each note can all be edited conveniently in the Setup screen.

1. Access the RHYTHM PLAY screen, and select the rhythm kit whose settings you want to edit.

2. Touch < SETUP >

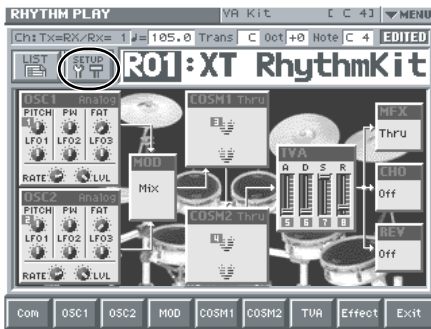

MEMO

Or, in the upper right of the RHYTHM PLAY screen, touch < MENU >, and then touch < SETUP > in the pulldown menu. The Setting window will appear.



In this screen, the level, panpot, and MFX (multi-effect)/chorus/reverb send levels for each note can be conveniently edited together.

- [◀ ▶] buttons: move between notes.
- Level, Pan, MFX, Cho, Rev knobs:
Edit the level, panpot, and MFX (multi-effect)/chorus/reverb send levels of each note.
- Level, Pan, MFX, Cho, Rev tabs:
Switch the on-screen graph between level, panpot, or MFX (multi-effect)/chorus/reverb send levels.
- If you turn on the < Select Note by KBD > located at the bottom of the screen, the note you play on the external MIDI keyboard will be selected.

3. Touch < OK >.

The note is determined, and you're returned to the RHYTHM PLAY screen.

In Rhythm mode, the current note is shown in the upper right of the RHYTHM PLAY screen.

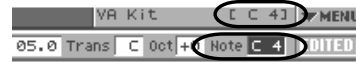

MEMO

You can also switch between notes by holding down [SHIFT] and using the left/right cursor ([◀], [▶]) keys.

4. In this state, the note C4 is selected. Specify the sound that you want the C4 note to play.
5. When you've specified a sound for the C4 note, you can then specify the sound for another note.
6. In this way, make settings for all of the notes you want to use.
7. If you want to save the rhythm kit you created, perform the same Save procedure as for a patch (p. 75).

Creating and Editing Samples (Sample Mode)

In this chapter, we will explain the procedures for:

- Sampling (p. 104)
- Editing samples (p. 113)
- Converting samples so the VariPhrase function can be used (Encoding) (p. 118)



For details on loading samples, refer to p. 133.

Sampling

Settings Before You Sample (What Is a Template?)

A sampling template is something that holds a collection of settings for sampling (the setup settings, pre-effect settings, and metronome settings described below).

You can store eight different sampling templates. When you sample, you will always select one of these eight templates.

With the factory settings, eight sampling templates are preset.



For details on modifying the settings, refer to “**Sampling Procedure**” (p. 105).



Sampling templates are system settings (with the exception of some metronome parameters). They are remembered even when you turn off the power. If you wish to restore all eight sampling templates to the factory settings, perform the Factory Reset operation (p. 147).

Applications of Each Template

The preset templates cover different input settings and pre-effect types.

| | |
|-----------------|--|
| Mic | Sample in mono from a mic. Connect a mic to the front panel MIC jack. |
| Line | Sample in stereo from a CD. Connect your CD player to the rear panel INPUT jacks. |
| Coaxial | Sample a digital signal. Connect your audio device to the rear panel COAXIAL IN connector. |
| Resampl | Play a sample on the V-Synth XT and sample the result. This is called “resampling.” For details on resampling, refer to p. 109. |
| Comp | Use the compressor pre-effect. The sample will be recorded from the rear panel INPUT jacks (or from the front panel MIC jack). |
| Limiter | Use the limiter pre-effect. The sample will be recorded from the rear panel INPUT jacks (or from the front panel MIC jack). |
| MIDI | Start sampling when a sequencer start (system realtime message: FA) is received. The sample will be recorded from the rear panel INPUT jacks (or from the front panel MIC jack). |
| USB (XT) | Sampling from a PC USB Audio. |

Factory Settings of Each Template

| Setup | Mic | Line | Coaxial | Resampl |
|--------------|------------|------------|-------------|----------------|
| SamplingType | 1 (MIX) | 0 (Stereo) | 0 (Stereo) | 0 (Stereo) |
| InputSource | 0 (Analog) | 0 (Analog) | 2 (Coaxial) | 3 (Resampling) |
| TriggerMode | 0 (Manual) | 2 (Level) | 2 (Level) | 3 (Note) |
| TriggerLevel | -12 (dB) | -12 (dB) | -24 (dB) | -12 (dB) |
| PreTrigger | 0 (0msec) | 0 (0msec) | 0 (0msec) | 0 (0msec) |
| PreGain | 0 (0dB) | 0 (0dB) | 0 (0dB) | 0 (0dB) |
| PreFxType | 0 (off) | 0 (off) | 0 (off) | 0 (off) |
| PreFxCS-Sus | 0 | 0 | 0 | 0 |
| PreFxCS-Atk | 0 | 0 | 0 | 0 |
| PreFxCS-Tone | 0 | 0 | 0 | 0 |
| PreFxCS-Lvl | 0 | 0 | 0 | 0 |
| PreFxLM-Thr | -48 | -48 | -48 | -48 |
| PreFxLM-Rel | 0 | 0 | 0 | 0 |
| PreFxLM-Rati | 0 | 0 | 0 | 0 |
| PreFxLM-Tone | 0 | 0 | 0 | 0 |
| PreFxLM-Lvl | 0 | 0 | 0 | 0 |
| PreFxNS-Thr | -60 | -60 | -60 | -60 |
| PreFxNS-Rel | 0 | 0 | 0 | 0 |
| CountIN | 1 (1MES) | 0 (0MES) | 0 (0MES) | 1 (1MES) |
| MetroType | 1 (REC) | 1 (REC) | 1 (REC) | 1 (REC) |

| Setup | Comp | Limiter | MIDI | USB (XT) |
|--------------|------------|------------|------------|------------|
| SamplingType | 0 (Stereo) | 0 (Stereo) | 0 (Stereo) | 0 (Stereo) |
| InputSource | 0 (Analog) | 0 (Analog) | 0 (Analog) | 4 (USB) |
| TriggerMode | 0 (Manual) | 0 (Manual) | 1 (MIDI) | 2 (Level) |
| TriggerLevel | -12 (dB) | -12 (dB) | -12 (dB) | -24 (dB) |
| PreTrigger | 0 (0msec) | 0 (0msec) | 0 (0msec) | 0 (0msec) |
| PreGain | 0 (0dB) | 0 (0dB) | 0 (0dB) | 0 (0dB) |
| PreFxType | 1 (COMP) | 2 (LIMIT) | 0 (off) | 0 (off) |
| PreFxCS-Sus | 64 | 0 | 0 | 0 |
| PreFxCS-Atk | 12 | 0 | 0 | 0 |
| PreFxCS-Tone | 0 | 0 | 0 | 0 |
| PreFxCS-Lvl | 0 | 0 | 0 | 0 |
| PreFxLM-Thr | -48 | -36 | -48 | -48 |
| PreFxLM-Rel | 0 | 80 | 0 | 0 |
| PreFxLM-Rati | 0 | 2 | 0 | 0 |
| PreFxLM-Tone | 0 | 0 | 0 | 0 |
| PreFxLM-Lvl | 0 | 0 | 0 | 0 |
| PreFxNS-Thr | -60 | -60 | -60 | -60 |
| PreFxNS-Rel | 0 | 0 | 0 | 0 |
| CountIN | 1 (1MES) | 1 (1MES) | 0 (0MES) | 0 (0MES) |
| MetroType | 1 (REC) | 1 (REC) | 1 (REC) | 1 (REC) |

Sampling Procedure

Here's how to input a sound from the input jacks and sample it. For resampling, refer to the following section.

The V-Synth XT has the following input jacks.

- INPUT L, R
- MIC
- DIGITAL AUDIO INTERFACE
 - OPTICAL IN
 - COAXIAL IN
- USB

Use the input jack that is appropriate for your situation.

- Monaural sampling from a mic → MIC
- Sampling from an analog source → INPUT L, R
- Sampling from a digital source → OPTICAL IN or COAXIAL IN
- Sampling from a PC USB Audio → USB

MEMO

The on/off status of the MIC jack and INPUT jacks and the gain setting for the INPUT JACKS are adjusted using the System parameter “**Audio I/F**” (p. 126).

The impedance type selection and phantom power supply for the MIC jack are specified by “**MIC Switch**” (p. 14).

NOTE

Howling could be produced depending on the location of microphones relative to speakers. This can be remedied by:

1. Changing the orientation of the microphone(s).
2. Relocating microphone(s) at a greater distance from speakers.
3. Lowering volume levels.

When sampling, you must make sure that the following two items are set correctly. If these two settings are incorrect, the sample will not be recorded as you intend.

- What type of sample are you recording? (stereo or mono)
→ In the SAMPLING General screen, set Sampling Type.
- Which input are you sampling from? (select the input jack)
→ In the SAMPLING General screen, set Input Source.

MEMO

If you have set the metronome (p. 111), the metronome sound will be output from the DIRECT OUT jack during sampling. However, the sound that is assigned to the DIRECT OUT jack (p. 97) will not be output.

1. Press [MODE].

The V-SYNTH XT MODE MENU window appears.

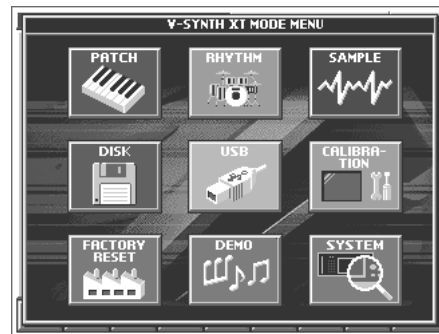

2. Touch <SAMPLE>.

The SAMPLE Top screen appears.

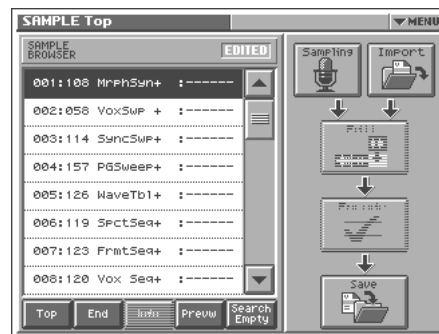

Creating and Editing Samples (Sample Mode)

3. Select the location (sample number) that you wish to sample.

Move the cursor to the desired sample. Normally, you will select a sample that has no wave; i.e., a sample number whose name is "NO SAMPLE."

In this screen you can use the following functions.

- Select a sample by directly touching it.
- Change the number in steps of eight by pressing [◀] [▶].
- Change the number in steps of one by touching <▲><▼> located beside the sample list, by pressing [▲] [▼] [INC] [DEC], or by turning the VALUE dial.
- Scroll the sample list by dragging the scroll bar located beside the sample list up or down.
- Move to the number 001 sample by touching <Top>.
- Move to the number 999 sample by touching <End>.
- Display information on the currently selected sample by touching <Info> (p. 112). However, this information will not be displayed for the factory-set waves.
- Audition the currently selected sample by touching <Prevw>.
- When you touch <Search Empty>, you will jump to the "NO SAMPLE" sample number that follows the current sample number.

4. Touch <Sampling>.

The SAMPLING Template screen appears.

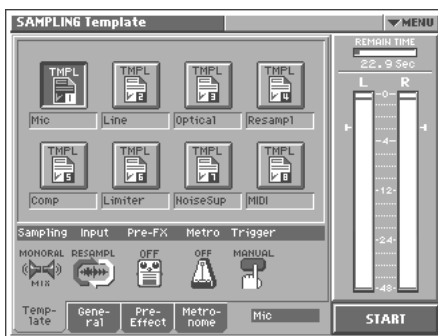

5. Touch <TMPL 1>—<TMPL 8> to select a sampling template.

If you want to modify the settings of the selected sampling template, perform the following steps 6–8.

6. Touch one of the tabs displayed at the bottom of the screen to access the corresponding setting screen.

<General>: Setup settings (p. 109)

<Pre-Effect>: Pre-effect settings (p. 110)

<Metronome>: Metronome settings (p. 111)



For details on each parameter, refer to the page references given.

7. In each setting screen, touch the touch panel to set the parameters.



For details on operations in the touch panel, refer to "Basic Touch Screen Operation" (p. 24).

8. To set the value of a parameter, move the cursor to the value box of the parameter that you want to edit. Then adjust the value by turning the VALUE dial or by using [INC] [DEC]. You can also adjust the value by dragging on the touch screen.

9. Adjust the sampling level.

Adjust the volume of the device that is producing the sound.

- When sampling from the MIC jack, adjust the level by turning the front panel INPUT knob.
- When sampling from the INPUT jacks, setting the "INPUT Jack Gain" (p. 126).
- If you are sampling from the DIGITAL AUDIO INTERFACE IN connector, use the setup Pre-gain (p. 110) or the pre-effect Output Level (p. 110, p. 111) settings to adjust the level.

10. Touch <START> to start sampling.

The way in which sampling will start depends on the Trigger Mode setting in the SAMPLING General screen, as follows.

If "MANUAL" is selected, sampling will start after a count of the number of measures specified by the metronome Count-In setting.

If "MIDI" is selected, sampling will wait for the sequencer to start (system realtime message: FA). Sampling will begin when the sequencer start message is received.

If "LEVEL" is selected, sampling will wait for an input signal. Sampling will begin when the input signal exceeds the level specified by Trigger Level (p. 110).

If "NOTE" is selected, Sampling will begin when you play the keyboard or note message is received.

HINT

If you have selected "MIDI" or "LEVEL," you can touch <START> once again to begin sampling without waiting for the sequencer to start or the input signal to be received.

MEMO

In the SAMPLING window, "Remain Time" indicates the remaining time (in seconds) available for sampling.

NOTE

If memory becomes full, sampling will be halted. If this occurs, delete unneeded samples from memory (p. 109).

11. When you are finished sampling, touch <STOP>.

The display will indicate "COMPLETED!" Touch <PREVIEW> to hear the sound that you sampled, and check whether the sample was recorded as you wish.

12. Operations from this point will depend on what you want to do.

<Cancel>: Discard the sample that you just recorded, and return to the SAMPLING Template screen.

<OK>: Finalize the sample that you just recorded, and register it in the sample list.

<RETRY>: Discard the sample that you just recorded, and sample once again.

Naming a Sample (SAMPLE Name)

Assign a new name to the sample. You can assign a name consisting of up to twelve characters.

1. Access the SAMPLE Top screen, and select the sample that you want to name (p. 105).
2. Touch <▼ MENU> in the upper right of the screen.
A pulldown menu appears.

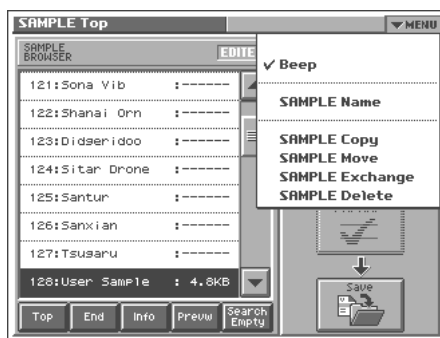

3. In the pulldown menu, touch <SAMPLE Name>.
The SAMPLE Name window appears.

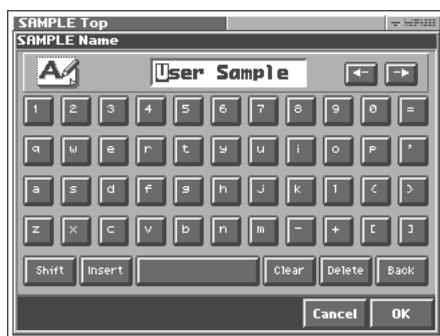

4. Touch the on-screen alphabetic or numeric keys to enter the new name in the text box.

The on-screen keys have the following functions.

<<-><->>: Move the cursor in the text box to the desired input location.

<Shift>: Turn this on when you want to input uppercase letters or symbols.

<Insert>: Turn this on when you want to insert a character at the cursor location.

<Clear>: Erases all characters in the text box.

<Delete>: Deletes the character at the cursor location.

<Back>: Deletes the character that precedes the cursor location.

HINT

You can also move the input location cursor by pressing the [◀] [▶] cursor buttons. Pressing [▲] will change the character at the cursor location to uppercase, and pressing [▼] will change it to lowercase.

5. When you have finished inputting, touch <OK> to finalize the sample name.

Copying a Sample (SAMPLE Copy)

1. Access the SAMPLE Top screen (p. 105).
2. Touch <▼ MENU> in the upper right of the screen.
A pulldown menu appears.

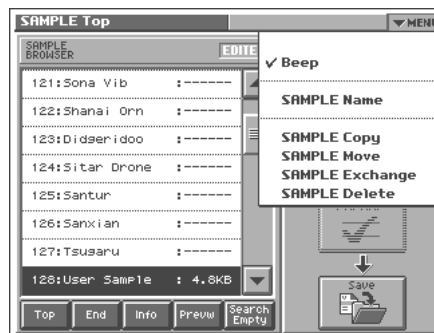

3. In the pulldown menu, touch <SAMPLE Copy>.
The SAMPLE Copy window appears.

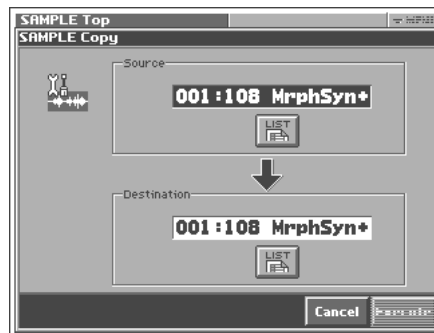

4. Move the cursor to "Source" and select the copy-source sample.
5. Move the cursor to "Destination" and select the copy-destination sample.

HINT

When you touch <List>, the Sample List window will appear, allowing you to select the sample from the list.

6. Touch <Execute> to execute the copy operation.
7. Press [EXIT].
The SAMPLE Copy window closes.

Creating and Editing Samples (Sample Mode)

Moving a Sample (SAMPLE Move)

1. Access the SAMPLE Top screen (p. 105).
2. Touch <▼ MENU> in the upper right of the screen.
A pulldown menu appears.

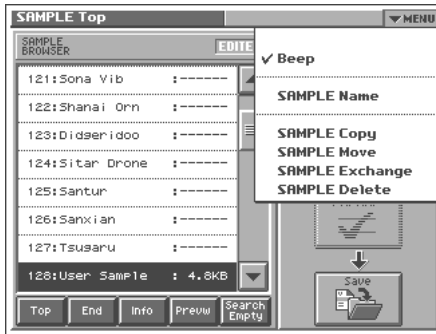

3. In the pulldown menu, touch <SAMPLE Move>.
The SAMPLE Move window appears.

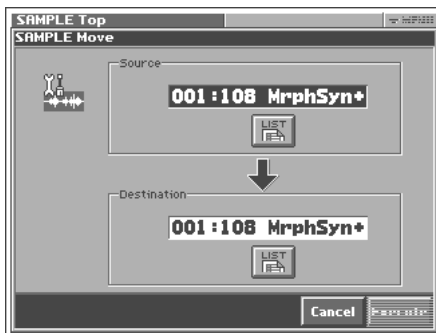

4. Move the cursor to "Source" and select the move-source sample.
5. Move the cursor to "Destination" and select the move-destination sample.

HINT

When you touch <List>, the Sample List window will appear, allowing you to select the sample from the list.

6. Touch <Execute> to execute the move operation.

Exchanging a Sample (SAMPLE Exchange)

1. Access the SAMPLE Top screen (p. 105).
2. Touch <▼ MENU> in the upper right of the screen.
A pulldown menu appears.

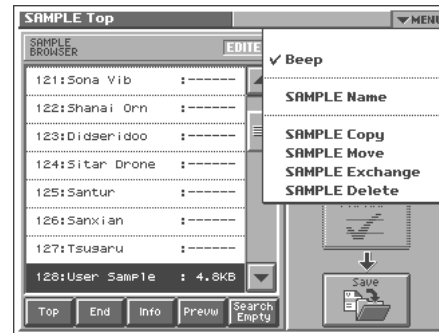

3. In the pulldown menu, touch <SAMPLE Exchange>.
The SAMPLE Exchange window appears.

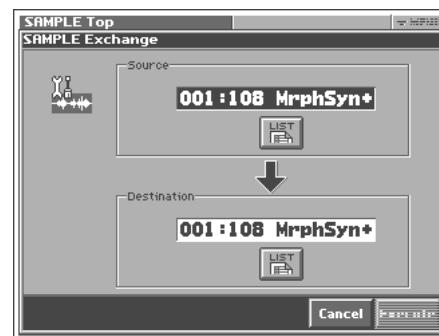

4. Move the cursor to "Source" and select the exchange-source sample.
5. Move the cursor to "Destination" and select the exchange-destination sample.

HINT

When you touch <List>, the Sample List window will appear, allowing you to select the sample from the list.

6. Touch <Execute> to execute the exchange operation.

Deleting a Sample (SAMPLE Delete)

1. Access the SAMPLE Top screen (p. 105).
2. Touch <▼ MENU> in the upper right of the screen.
A pulldown menu appears.

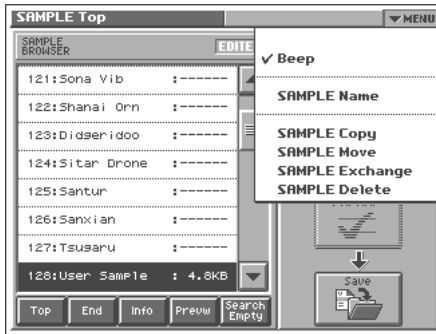

3. In the pulldown menu, touch <SAMPLE Delete>.
The SAMPLE Delete List window appears.

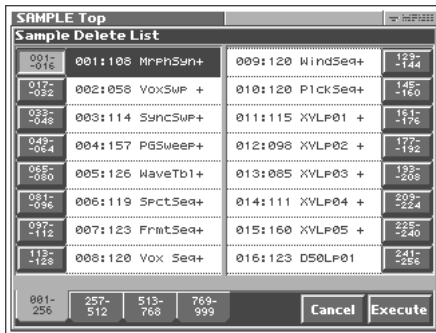

4. From the list, select the sample that you want to delete.
Either turn the VALUE dial or use [INC][DEC] to select a patch.
You can also select a patch by touching it on the display.

HINT

Each screen in the SAMPLE Delete List window shows a group of 16 samples. To view other samples, touch <017-032>-<241-256>, located at either side of the screen. To view higher-numbered samples, touch <257-512>-<769-999>, located at the bottom of the screen.

5. Touch <Execute>.
The selected sample will be deleted.
6. If you want to continue deleting other samples, repeat steps 4 and 5.
7. Press [EXIT].
The SAMPLE Delete List window closes.

Resampling

The V-Synth XT is able to resample samples from its internal memory. This is called **resampling**. In actuality, the sounds that are output from the rear panel MAIN OUT L(MONO), R jacks are sampled.

For example, you could sample multiple samples played simultaneously, and record them as a single sample. You can conserve voices in this way.

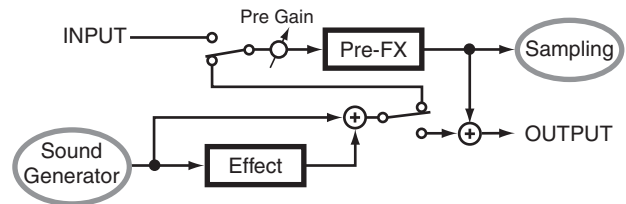

Before you enter Resampling mode, make settings so that you can play the sample(s) you wish to resample.

The resampling procedure is essentially the same as the “Sampling Procedure” described in the preceding section. However, please be aware of the following points.

- You must set the Input Source in the SAMPLING General screen to “RESAMPL.”
- To adjust the sampling level, adjust the setup Pre-gain (p. 110) and the pre-effect Output Level (p. 110, p. 111).

Setup Settings

SAMPLING General

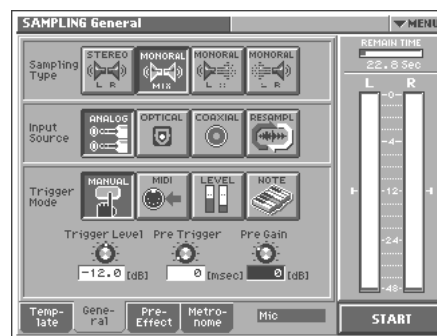

Sampling Type

Select the type of sampling.

Value

STEREO L R: Sample in stereo.

MONO MIX: Mix the signals input to L and R, and sample in monaural.

MONO L: Sample the L input signal in monaural.

MONO R: Sample the R input signal in monaural.

Creating and Editing Samples (Sample Mode)

Input Source

Select the input from which the sound will be sampled.

Value

ANALOG: INPUT jacks / MIC jack

OPTICAL: OPTICAL IN connector

COAXIAL: COAXIAL IN connector

RESAMPL: Select this when you wish to resample. The sound that is output to MAIN OUT L(MONO) and R will be sampled.

USB: USB audio

Trigger Mode

Specifies how sampling will be started.

Value

MANUAL: Sampling will begin when you touch <START>.

MIDI: Sampling will begin when an external sequencer start message (system realtime message: FA) is received.

LEVEL: Sampling will start when the input signal exceeds the level specified by the Trigger Level setting.

NOTE: Sampling will begin when you play the keyboard or note message is received.

Trigger Level

Specifies the input level at which sampling will begin when the Trigger Mode is set to "LEVEL." The trigger level is shown by the "■" and "■" in the level meter located at the right of the screen.

Value: -∞-00 dB



If Trigger Mode is set to other than "LEVEL," this parameter has no effect.

Pre Trigger

After the selected trigger to start sampling has been received, previously received data for the length of time specified here will be included in the sampled data. When the Trigger Mode is set to "LEVEL" and the early portion of the sample is being lost, you can use this setting to include the early portion.

Value: 0-1000 msec

Pre Gain

Adjusts the input gain. This will apply to the sound that is received from all input jacks. It will also be applied to the sound being resampled. With positive (+) values, the gain will be higher than originally, and with negative (-) values the gain will be lower than originally.

Value: -12- +36 dB

Pre-Effect Settings

SAMPLING Pre-Effect



There are three pre-effects: compressor, limiter, and noise suppressor. By using these you can adjust the level of the sound being sampled.

Compressor:

By reducing high levels and raising low levels, this effect smoothes out unevenness in volume.

Limiter:

By compressing sounds that exceed a specified volume level, this effect prevents the sound from distorting.

Noise suppressor:

This effect leaves the original sound untouched, but mutes the noise that is heard during periods of silence.

Type (Pre-Effect Type)

Value

OFF: No pre-effect will be used.

COMP+NS: Compressor and noise suppressor settings can be made.

LMT+NS: Limiter and noise suppressor settings can be made.

NS: Noise suppressor settings can be made.

■ Compressor

Sustain

Specifies the time over which a low-level signal is raised until it reaches a fixed volume.

Value: 0-127

Attack (Attack Time)

Specifies the attack time of the input sound.

Value: 0-127

Tone

Adjusts the tone quality of the compressor.

Value: -50- +50

Level (Output Level)

Adjusts the output volume.

Value: 0- +24 dB

■ **Limiter**

Thres (Threshold Level)

Specifies the level (threshold level) at which the limiter will begin to function.

Value: -60–0 dB

Release (Release Time)

Specifies the time from when the input level drops below the threshold level until the limiter turns off.

Value: 0–127

Tone

Adjusts the tonal quality of the limiter.

Value: -50– +50

Level (Output Level)

Adjusts the output volume.

Value: 0– +24 dB

Ratio

Specifies the compression ratio.

Value: 1.5:1, 2:1, 4:1, 100:1

■ **Noise Suppressor**

Threshold (Threshold Level)

Specifies the level at which the noise suppressor will begin to operate. When the signal falls below the specified level, it will be muted.

Value: -60–0 dB

Release (Release Time)

Specifies the time from when the noise suppressor begins to operate until the volume reaches 0.

Value: 0–127

Metronome Settings

Metronome



Metro Type (Metronome Type)

Specifies when you want the metronome to sound.

Value

OFF: The metronome will not sound.

REC: The metronome will sound only during sampling.

ALWAYS: The metronome will sound whenever you sample (including while you are making settings in preparation for sampling).

Level (Metronome Level)

Specifies the volume of the metronome.

Value: 0–127

Count In

Specifies the number of measures for the count-in that will occur before sampling.

Value

OFF: A count will not be sounded.

1MEASURE: A one-measure count will be sounded.

2MEASURE: A two-measure count will be sounded.

NOTE

If Trigger Mode is set to other than "MANUAL," this parameter has no effect.

Tempo

Specifies the tempo of the metronome.

Value: 20.0–250.0

Beat

Specifies the time signature of the metronome.

Value

Numerator: 1–31

Denominator: 2, 4, 8, 16, 32

Creating and Editing Samples (Sample Mode)

Naming a Template (Template Name)

A template can be given a name of up to eight characters.

1. Access the **SAMPLE Top** screen, and select the sample that you want to name (p. 105).
2. Touch **<▼ MENU>** in the upper right of the screen.
A pulldown menu appears.

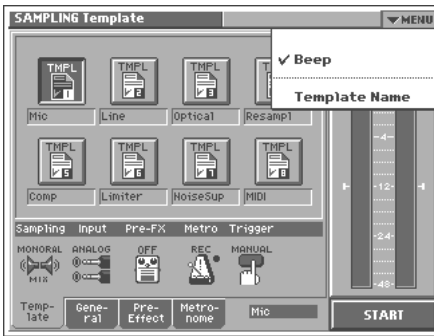

3. In the pulldown menu, touch **<Template Name>**.
The SAMPLING Template Name window appears.

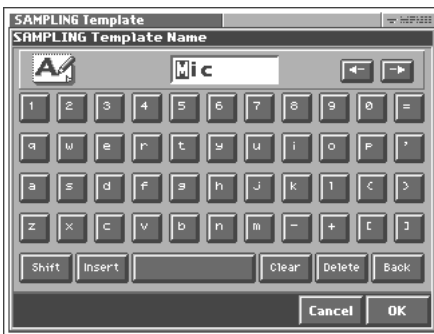

4. Touch the on-screen alphabetic or numeric keys to enter the new name in the text box.

The on-screen keys have the following functions.

<<->>: Move the cursor in the text box to the desired input location.

<Shift>: Turn this on when you want to input uppercase letters or symbols.

<Insert>: Turn this on when you want to insert a character at the cursor location.

<Clear>: Erases all characters in the text box.

<Delete>: Deletes the character at the cursor location.

<Back>: Deletes the character that precedes the cursor location.

HINT

You can also move the input location cursor by pressing the [◀] [▶] cursor buttons. Pressing [▲] will change the character at the cursor location to uppercase, and pressing [▼] will change it to lowercase.

5. When you have finished inputting, touch **<OK>** to finalize the template name.

Checking Sample Information

1. Access the **SAMPLE Top** screen (p. 105).
2. Touch **<Info>**.
The **SAMPLE Information** screen appears.

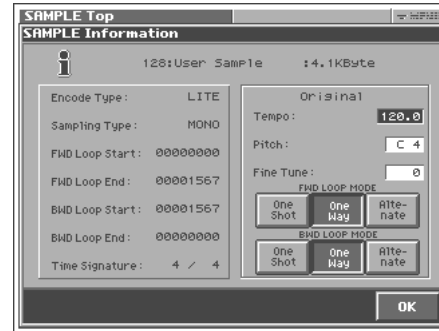

In the **SAMPLE Information** screen you can check the following information for the sample.

- Encode type (p. 119)
- Sampling type (p. 109)
- Loop point location (Loop Start, Loop End) (p. 117)
- Time signature (p. 118)
- Original tempo (p. 118)
- Original pitch
- Original fine tune

MEMO

Original Tempo, Original Pitch, and Original Fine Tune can be modified in this screen.

NOTE

If you want to set an accurate original tempo, make settings in the sample editing screen (p. 118).

Original Pitch

Specifies the key that will play the sample at the pitch at which it was sampled.

Value: C-1 (0)-G9 (127)

Original Fine Tune

Adjusts the current pitch in one-cent steps (1/100 of a semitone) over a range of 1/2 semitone upward or downward.

Value: -50+50

LOOP MODE

One Shot: The sample will not loop, regardless of the Loop Switch (p. 87) setting of the patch.

One Way: If the Loop Switch (p. 87) of the patch is on, the sample will loop in the forward direction between "LOOP START" and "LOOP END."

Alternate: If the Loop Switch (p. 87) of the patch is on, the sample will loop alternately backward and forward between the "LOOP START" and "LOOP END."

3. When you have finished viewing the information, touch **<OK>** to close the window.

Importing a Sample

To import samples you will use the Disk Save Project screen of Disk mode.

1. Access the **SAMPLE Top** screen (p. 105).
2. Touch **<Import>**.

Jump to the DISK Import Files screen in the Disk mode.



For details on operations in this screen, refer to “**Importing Individual Patch or Wave Files (Import Files)**” (p. 133).

Editing a Sample

When you have finished sampling, you can edit the sample data. You can also edit samples that you loaded (p. 133).

When editing a sample, touching **<PREVIEW>** will play the sample so you can check whether it was edited as you expect.

NOTE

- When the editing screens are displayed, playing the keyboard will not produce sound.
- It is not possible to edit two or more samples simultaneously.
- With some exceptions, editing a sample that has been encoded will cause the encoding data to be discarded. In this case, you must encode the data once again (p. 118).
- The factory-set waves (preset waves) cannot be edited.

Common Procedure for Editing Displaying the Sample Edit Screen

1. Press **[MODE]**.

The V-SYNTH XT MODE MENU window appears.

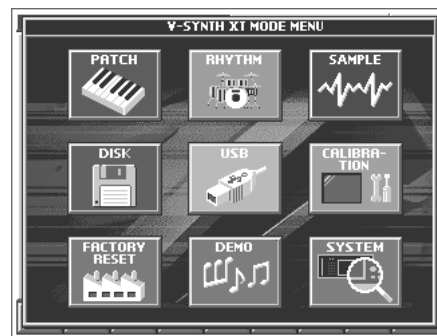

2. Touch **<SAMPLE>**.

The **SAMPLE Top** screen appears.



3. Select the sample that you wish to edit.

For details on making this selection, refer to “**Sampling Procedure**” (p. 105).

Creating and Editing Samples (Sample Mode)

4. Touch <Edit>.

The SAMPLE Loop FWD screen appears.

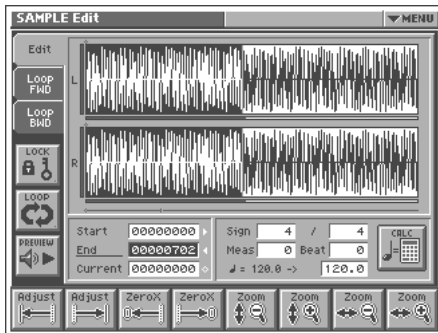

5. Touch one of the tabs in the left side of the screen to access the desired editing screen.

<Edit>: Edit the sample of the specified region (p. 115)

<Loop FWD>: Specify the loop region for forward playback (p. 117)

<Loop BWD>: Specify the loop region for backward playback (p. 117)



For details on each editing operation, refer to the corresponding page.

6. When you have finished making settings, press [EXIT] to return to the SAMPLE Top screen.

Functions Common to All Editing Screens

“Start,” “End,” and “Current” Settings

The V-Synth XT uses seven terms to indicate locations within a sample.

Sample Start: Beginning of the sample

Sample End: End of the sample

Loop Start, Loop End: When the Loop Play is ON, the region between these two points will be played repeatedly.

Edit Start, Edit End: Editing will affect the region between these two points.

Current: This is the currently selected location of the sample.

Move the cursor to “Start,” “End,” or “Current” to select the point that you want to specify. Then specify the location by turning the VALUE dial, by using [INC][DEC], or by dragging your finger over the sample in the screen.

MEMO

- The region of the sample between Edit Start and Edit End is displayed with the color inverted.
- When Current = Loop/Edit Start, moving Loop/Edit Start will cause Current to change as well.

NOTE

It is not possible to move Loop/Edit Start to the right of Loop/Edit End.



(LENGTH LOCK)

This locks the length of the region between the start point (Start) and end point (End) of the sample. It is convenient to use this when you already know the length of the sample that you need, and want to find the right region to use.

After the length has been locked, you can turn the VALUE dial, use [INC] [DEC], or drag your finger over the sample in the screen to adjust the Start and End locations while maintaining the distance between these two points.

HINT

You can also use Adjust (p. 114) or Zero Cross Search (p. 115) while the length of the sample is locked.



(LOOP)

This switches loop playback on/off. Turn this on if you want the loop region specified in the Loop FWD/BWD screen to play repeatedly.



(PREVIEW)

This plays the sample. During playback, you can touch this once again to stop playback.







(Adjust)

In the Loop FWD/BWD screen, the Adjust function moves the Loop Start, Loop End, or Current locations to the nearest of the following locations 1–5.

In edit screens, the Adjust function moves the Edit Start, Edit End, or Current locations to the nearest of the following locations 1–7.

- 1 Sample Start location
- 2 Sample End location
- 3 Loop Start location
- 4 Loop End location
- 5 Current location
- 6 Edit Start location
- 7 Edit End location

Move the cursor to the point that you want to adjust (“Start,” “End,” or “Current”), and touch  or .

Touching  will move the point toward the left, and touching  will move it toward the right.

MEMO

In the SAMPLE Encode screen (p. 118), this will move the Current location to the closest event.

HINT

For example, if you wish to touch <PREVIEW> to check whether the results of your editing were satisfactory, you can jump the current location.

NOTE

In some cases nothing may happen, due to the relation between points or the Length Lock setting.

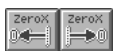

(Zero Cross Search)

This function searches for locations where the sample has a value of zero. When setting loop points or when cutting the sample, you should search for locations where the sample value is zero so that noise is not heard when you play the sample.

Move the cursor to the point ("Start," "End," or "Current") for which you want to find a zero-cross point, and then touch or . Touching will search toward the left, and touching will search toward the right.



(Zoom)

This expands or shrinks the displayed sample.

In any screen that displays the sample, you can touch the following buttons to expand or shrink the displayed sample.

- : Shrink vertically
- : Expand vertically
- : Shrink horizontally
- : Expand horizontally

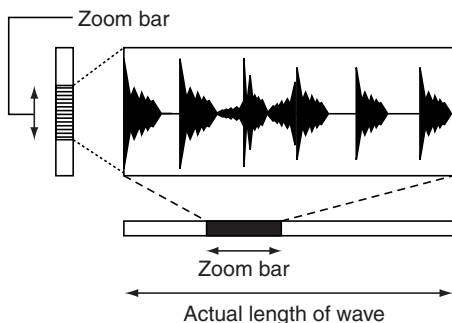

The vertical zoom bar indicates the magnification of the sample in the vertical direction. The horizontal zoom bar indicates the magnification of the sample in the horizontal direction, and shows the current location. As the display is magnified, the zoom bar will become narrower.

Editing the Specified Region of the Sample

You can specify a region of the sample, and edit the region by cutting or copying.

Basic Operation

1. Access the SAMPLE Edit screen (p. 113).
2. Specify the region that you want to edit (Edit Start–Edit End), or the Current location (p. 114).
3. Touch <▼ MENU> in the upper right of the screen. A pull-down menu appears.



4. In the pull-down menu, touch the editing function that you want to execute. A window appears, asking you to confirm the operation.

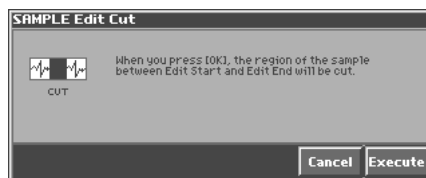

MEMO

Some editing functions require you to input a numerical value. For details, refer to the following explanations of each editing function.

5. Touch <EXECUTE> to execute the editing function.

HINT

- If you want to cancel without executing, touch <Cancel>.
- By touching "Undo" in the pull-down menu, you can return to the state prior to executing the operation (Undo). Depending on the type of edit function you execute, or on the state of the work area, there may be cases in which the Undo function cannot be executed. In such cases, you will not be able to select <Undo>.

6. If you want to save the edited result, perform the Save operation (p. 121).

Sample Editing Functions



Cut

The region of the sample between Edit Start and Edit End will be cut.

Truncate

The region of the sample between Edit Start and Edit End will be kept, and the remainder of the sample will be deleted.

Copy

The sample between Edit Start and Edit End will be copied.

Clear

The sample between Edit Start and Edit End will be set to values of zero.

Paste

The copied data will be overwritten, beginning at the current location.

NOTE

If there is any sample data following the current location, it will be lost as far as the pasted portion extends.

Insert

The copied data will be inserted at the current location.

HINT

You can cut, paste, and insert between different samples. After copying, press [EXIT] to return to the SAMPLE Top screen. Select a different sample, access the SAMPLE Edit screen, and then paste or insert.

Zero Insert

This operation inserts silent space at the current location. It can also be used to lengthen a sample to a precise number of measures and beats. In the SAMPLE Edit Zero Insert window, specify the length of the silent region that you want to insert. This setting is made in terms of a number of samples. Data in the V-Synth XT is handled as 44.1 kHz data, meaning that one second contains 44,100 data samples.

HINT

For example, if you wish to insert one second of silence, you would specify "44100" and execute Zero Insert.

NOTE

If the amount of remaining memory is small, it may not be possible to execute Copy, Paste, Insert, or Zero Insert. In such cases, delete unneeded samples from memory (p. 109).

LR-Mix

The stereo sample will be mixed to L, converting it into a monaural sample. If this is set to monaural, less wave memory will be used. This will also decrease the number of voices.

Trim (Trimming)

If the beginning and end of the sample are values other than zero, noise will be heard when you play the sample. Trim sets the values at the beginning and end of the sample to zero.

In the SAMPLE Edit Trim window, specify the length that you want to trim. This setting is made in terms of a number of samples. Data in the V-Synth XT is handled as 44.1 kHz data, meaning that one second contains 44,100 data samples.

HINT

For example, trimming at 100 samples. This will connect the first data sample and the one hundredth data sample by a smooth line of one hundred points. Similarly, the last data sample and the data sample one hundred samples before it will be connected by a smooth line of one hundred points.

Normalize

The Normalize operation is used to uniformly increase or decrease the level of the entire sample without allowing it to distort. This is used when you wish to make the volume consistent with other samples. In the SAMPLE Edit Normalize window, specify the degree of normalization that you want to use. The value is specified in terms of a percentage.

HINT

For example, let's suppose that 100 is the maximum volume at which the volume does not distort. Executing the Normal operation at a setting of 90% will make the maximum value of the sample be 90.

NOTE

If you normalize at a low setting and then normalize at a high setting, the audio quality will deteriorate. This means that if you intend to normalize several times, you should start from the higher value and work downward.

Reverse

The sample will be reversed between Edit Start and Edit End. If you want the sample to play backwards, execute Reverse to reverse the sample from the beginning.

Region

The region of the sample between Edit Start and Edit End can be stored in internal memory as a separate sample. The original sample will remain unchanged.

Perform the following procedure.

1. Select the region that you want to extract as a separate sample, and execute Region.
2. In the SAMPLE Edit Region window, select the sample number to which you want to paste the extracted region of the sample, and touch <OK>.
3. Assign a name to the new sample, and touch <OK>.

MEMO

If in step 2 you select a sample number that already has a sample, the sample data between Edit Start and Edit End will be added to the end of the selected sample.

Loop Region Settings

When the loop switch (p. 114) is ON, you can specify the region that will be played back as a loop. The region of the sample between Loop Start and Loop End will be played back repeatedly.

In the SAMPLE Loop FWD screen that appears when you touch <Loop FWD>, specify the loop region for forward playback. In the SAMPLE Loop BWD screen that appears when you touch <Loop BWD>, specify the loop region for backward playback.

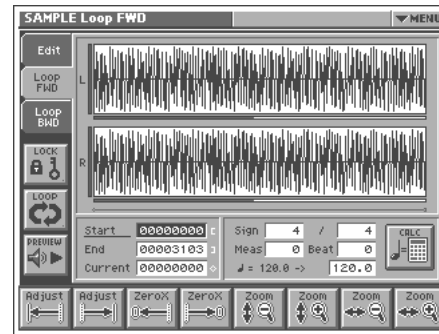

Immediately after sampling or loading a sample, Loop Start will be set to the beginning of the sample and Loop End to the end of the sample.

If you set Loop Start and Loop End to locations within the sample, the sample will play back from the beginning, and then the region between Loop Start and Loop End will play back repeatedly.

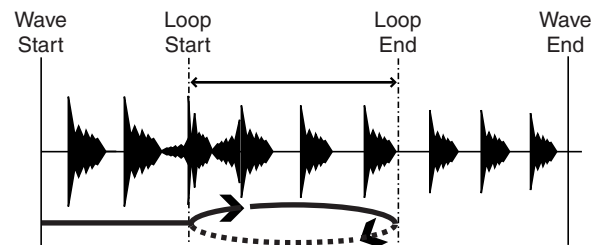

MEMO

The data in the V-Synth XT is handled as 44.1 kHz data, which means there are 44,100 data samples per second. The shortest possible loop that can be set is 16 data samples.

NOTE

Loop range settings are ignored when the Playback Mode (p. 87) is set to "STEP" or "EVENT."

Creating and Editing Samples (Sample Mode)

Original Tempo Setting

The Original Tempo is the reference tempo of the sample used when synchronizing it to the master tempo.

Example: A sample whose original tempo is 100

If the master tempo is set to 200 and the sample is synchronized, the sample will play back at double the speed at which it was recorded. If you set the master tempo to 50 and synchronize the sample, it will play back at half the speed at which it was



The exact original tempo can be calculated from the time signature, number of measures, and number of beats for the sample length between Loop Start and Loop End. This means that you must first specify the loop region, and then set the original tempo.

NOTE

If you wish to play back a loop while simultaneously synchronizing another sample, you must specify the correct original tempo. If you fail to do this, the sounds will drift out of synchronization.

1. Move the cursor to the item that you wish to set.
2. Either turn the VALUE dial or press [INC][DEC] to set the "Sign" (time signature), "Meas" (measure), and Beat values.
3. Touch .

The precise tempo will be displayed at the right of the "->." The tempo displayed here is the original tempo.

HINT

You can also move the cursor to the original tempo, and set it by rotating the VALUE dial or by using [INC][DEC].

Converting the Sample to V-Synth XT Data (Encode)

After you have finished editing the sample, you should encode it. By using the encoding that is appropriate for the sample, you'll be able to maintain a higher quality of audio while controlling the pitch, time, and format.

NOTE

The factory-set waves (preset waves) cannot be encoded.

Displaying the Encode Screen

NOTE

Samples whose wave is too short (0.1 sec or less) cannot be encoded, and the SAMPLE Encode screen cannot be accessed for such samples.

1. Press [MODE].

The V-SYNTH XT MODE MENU window appears.

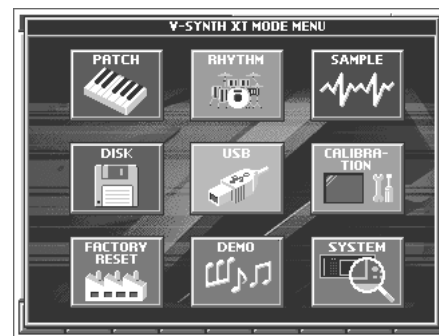

2. Touch <SAMPLE>.

The SAMPLE Top screen appears.

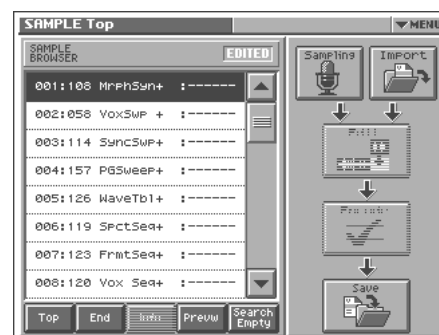

3. Select the sample number that you wish to encode.

For details on how to select a sample, refer to "Sampling Procedure" (p. 105).

4. Touch <Encode>.

The SAMPLE Encode screen appears.

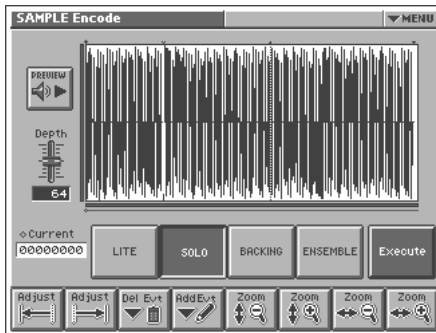

To Execute the Encode Operation

In the SAMPLE Encode screen, select the encode type, set the encode depth, and delete or add events. Then touch <Execute>.

If you wish to stop the encode during the operation, touch <Abort>.

When encoding is completed, you will return to the SAMPLE Top screen.



For details on these settings, refer to the following sections.



The amount of time required by the encoding process will depend on the sample. You may need to wait a certain amount of time for encoding to be completed.

Selecting the Encoding Type

You can choose from the following four types of encoding. Touch the appropriate button to select a type.



LITE

This is the simplest encoding type. When you sample on the V-Synth XT, this type is selected by default. This type can be used with a variety of sounds, but to obtain the highest quality we recommend that you encode using one of the other types.

SOLO

This is suitable for monophonic vocals or monophonic wind instruments (such as sax, trumpet, or flute). If you encode the sample using this type, you will be able to control the formant (p. 92) and use the robot voice function (p. 87). Even if you encode using SOLO, you can still play the sample polyphonically.

BACKING

This is suitable for decay-type instruments. It is particularly suitable for phrases that include instruments with a clear attack (such as drums, percussion, and guitar chords).

ENSEMBLE

This is suitable for sustain-type instruments. It is particularly suitable when there are smooth changes in tone (such as choir or strings).

NOTE

- If the data is encoded using "BACKING" or "ENSEMBLE," it will not be possible to use the formant control or robot voice functions.
- Once a sample has been encoded, editing that sample (except for some operations) will cause the encoded data to be discarded. If you then access the SAMPLE Encode screen in this state, "LITE" will always be selected as the encoding type. Select the appropriate encoding type, and then re-encode the sample.
- Depending on the sample, encoding with "SOLO" may cause the sound to be different than you expect, such as changes in pitch being incorrect by one octave. If this occurs, re-encode the sample using "BACKING" or "ENSEMBLE."
- If a sample that contains large amounts of reverb or delay is encoded using "SOLO," it may not sound as you expect. If this occurs, re-encode the sample using "BACKING" or "ENSEMBLE."

Automatically Detecting Events

By specifying the Depth, you can automatically detect and “▼” mark locations where there is a strong attack (i.e., locations where the volume changes abruptly). Such marked locations are called **events**.

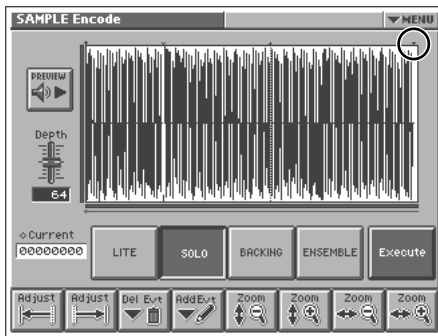

Depth (Encode Depth)

In the SAMPLE Encode screen, move the cursor to “Depth” and set the value. The higher the value you set, the more events will be assigned.



Value: 0–127

MEMO

If the Playback Mode (p. 87) is “STEP,” the sample will play to the next event, and then stop each time you play the key. When the Playback Mode is set to “EVENT,” the sample will be divided at event locations, and assigned to each key.

NOTE

- If you set Depth to a high value, a large number of events may be detected. If you encode in such a state, the interval between events will be too short, and the expected result will not be obtained when you play back in event units.
- If you change the location of an event after encoding, you must re-encode the sample. When you encode, the newly detected event locations will take effect.

Deleting and Adding Events



Setting the Encode Depth and automatically detecting events does not guarantee that the events will be added at the locations that you expect. If necessary, you can delete or add events as you like.

In the SAMPLE Encode screen, you can touch <PREVIEW> to play the sample from the current location until the next event. By touching <PREVIEW>, you can play the sample to see whether events have been assigned to the locations that you expect.

NOTE

- Be aware that if you change the encode depth after deleting or adding events, the events that were modified manually will be discarded, and the events that were detected by depth will be displayed.
- If you modify the location of events after encoding, you must re-encode. The modified location of the events will take effect when you encode.

Deleting an Event

1. Move the cursor to “Current.”
2. By turning the VALUE dial, pressing [INC][DEC], or dragging your finger over the sample in the screen, set Current to the location of the event that you want to delete.
3. Touch either  or  .
The Current location will move to the location of the next event toward the left or right.
4. Repeat step 3 to move Current to the location of the event that you wish to delete.
5. Touch  to delete the event.

NOTE

The events at the beginning and end of a sample cannot be deleted.

Adding an Event

1. Move the cursor to “Current.”
2. By turning the VALUE dial, pressing [INC][DEC], or dragging your finger over the sample in the screen, move Current to the location at which you want to add the event.
3. Touch  to add the event.

Saving a Sample

Samples that you sample or encode will be lost when you turn off the power. If you want to keep these samples, use the Disk Save Project screen in the Disk mode.

1. Access the **SAMPLE Top** screen (p. 105).

2. Touch **<Save>**.

Jump to the **DISK Save Project** screen in the Disk mode.

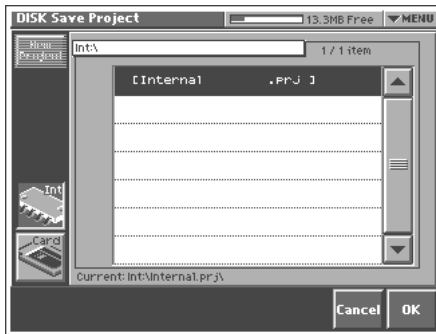

For details on operations in this screen, refer to “**Saving Project on Disk (Save Project)**” (p. 132).

Settings Common to All Modes (System Mode)

Settings that affect the entire operating environment of the V-Synth XT, such as tuning and MIDI message reception, are referred to as **system functions**. This section explains how to make settings for the System functions and describes the functions of the different System parameters.

How to Make the System Function Settings

1. Press [MODE].

The V-SYNTH XT MODE MENU window appears.

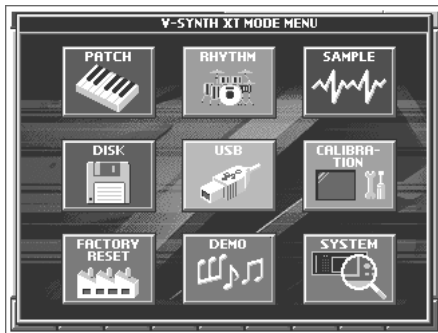

2. Touch <SYSTEM>.

The SYSTEM Com Master screen appears.



3. The parameters are organized into several editing groups. Touch one of the buttons at the bottom of the screen to select the edit group containing the parameters you want to set.

4. Touch one of the tabs in the left of the screen to select the desired editing screen.



For details on how the parameters are grouped, refer to “**System Parameters**” (p. 156).

5. In each editing screen, touch the touch screen to set the parameters.



For details on how to use the touch screen, refer to “**Basic Touch Screen Operation**” (p. 24).

6. When editing a parameter that requires you to specify a value, move the cursor to the value box of that parameter. Then modify the value by either turning the VALUE dial or pressing [INC] or [DEC]. You can also modify a value by dragging over the touch screen.
7. Repeat steps 3–6 to make the settings for the System function.

Saving the System Settings (Write)

Changes you make to the System function settings are only temporary—they will be discarded as soon as the power is turned off. If you want to keep any changes you’ve made in the system settings, you must save them in internal memory.

NOTE

When you perform the save procedure, the data that previously occupied the save destination will be lost. However, the factory setting data can be recovered by performing the Initialization procedure.

1. After you have edited the settings of the System function, touch <Write>, located in the lower right of the screen.

Initializing the System Settings (Init)

The current settings of the system functions can be restored to a set of standard settings, or to the factory settings.

1. Access the System Edit screen.
2. Touch <Init>, located in the lower right of the screen.

HINT

If you want the factory settings to be in effect the next time the V-Synth XT is powered up, touch <Write> to save the settings.

Functions of System Parameters

This section explains what the different System parameters do, and also how these parameters are organized.

Settings Common to the Entire System (Common)

Master



Master Tune

Adjusts the overall tuning of the V-Synth XT. The display shows the frequency of the A4 note (center A).

Value: 415.3–466.2 Hz

Master Key Shift

Shifts the overall pitch of the V-Synth XT in semitone steps.

Value: -24– +24

Master Level

Adjusts the volume of the entire V-Synth XT.

Value: 0–127

Patch Remain (Patch Remain Switch)

Specifies whether currently sounding notes will continue sounding when another patch is selected (ON), or not (OFF).

Also, when this is “ON,” changes produced by incoming MIDI messages such as Volume (CC 7) or Pan (CC 10), as well as tonal quality and volume changes produced by the various controllers will be inherited.

Value: OFF, ON

NOTE

Effects settings change as soon as you switch to a new patch, without being influenced by the Patch Remain setting. Because of this, certain effects settings can cause notes that were until then sounding to no longer be heard, even though Patch Remain has been set to on.

Powerup Mode

Specifies the condition that the V-Synth XT will be in when the power is turned on.

Value

LAST SET: Reinstates the patch selected at the time the V-Synth XT was last turned off.

DEFAULT: The V-Synth XT will be ready to play Patch “001.”

IO

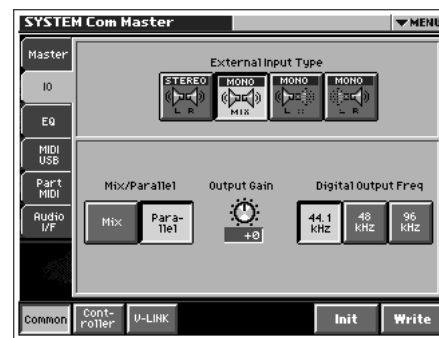

External Input Type

Selects the type of external input used when Oscillator Type (p. 86) is set to “EXT IN.”

Value

STEREO L R: Input in stereo.

MONO MIX: Mix the L and R input signals and input in monaural.

MONO L: Input the L signal in monaural.

MONO R: Input the R signal in monaural.

External Input Source

Selects the source of external input used when Oscillator Type (p. 86) is set to “EXT IN.”

Value

Analog (MIC/INPUT): The MIC jack or INPUT jacks will be the input source.

USB Audio: The USB audio from a computer connected to the V-Synth XT will be the input source.

Settings Common to All Modes (System Mode)

Mix/Parallel

Specifies how the sound of the entire V-Synth XT will be output.

Value

Mix: Set this to have the collective output of all sounds output from the OUTPUT A (MIX) jacks. When you want to check the final overall sound being output, set to MIX.

HINT

Sounds output from the PHONES jack are the same as those output from the MAIN OUT jacks. Therefore, any sounds set with Output Assign to be output from the DIRECT OUT jacks is not output from the PHONES jack. Be sure to have any sound you want to hear through the headphones set to "MIX."

Parallel: Output according to each Output Assign settings.

Output Gain

This adjusts the output gain from the V-Synth XT's Analog Out and Digital Out. When, for example, there are relatively few voices being sounded, boosting the output gain can let you attain the most suitable output level for recording and other purposes.

Value: -12--+12 dB

Digital Output Freq (Digital Output Frequency)

Sets the sampling frequency of the digital output.

Value: 44.1, 48, 96 KHz

EQ



4 Band EQ (4-Band Equalizer Switch)

Switch the 4-Band equalizer on/off.

Value: OFF, ON

LOW Freq (Low Frequency)

Selects the frequency of the low range.

Value: 50, 63, 80, 100, 125, 160, 200, 250, 315, 400, 500, 630, 800, 1000, 1250, 1600, 2000, 2500, 3150, 4000 Hz

LOW Gain

Adjusts the gain of the low frequency. Positive (+) settings will emphasize the low-frequency range.

Value: -15- +15 dB

MID 1 Q

Adjusts the width of the middle range 1. Set a higher value for Q to narrow the range to be affected.

Value: 0.5, 0.7, 1.0, 2.0, 4.0, 8.0

MID 1 Freq (Mid 1 Frequency)

Selects the frequency of the middle range 1.

Value: 50, 63, 80, 100, 125, 160, 200, 250, 315, 400, 500, 630, 800, 1000, 1250, 1600, 2000, 2500, 3150, 4000, 5000, 6300, 8000, 10000, 12500, 16000, 20000 Hz

MID 1 Gain

Adjusts the gain of the middle range 1. Positive (+) settings will emphasize the middle range 1.

Value: -15--+15 dB

MID 2 Q

Adjusts the width of the middle range 2. Set a higher value for Q to narrow the range to be affected.

Value: 0.5, 0.7, 1.0, 2.0, 4.0, 8.0

MID 2 Freq (Mid 2 Frequency)

Selects the frequency of the middle range 2.

Value: 50, 63, 80, 100, 125, 160, 200, 250, 315, 400, 500, 630, 800, 1000, 1250, 1600, 2000, 2500, 3150, 4000, 5000, 6300, 8000, 10000, 12500, 16000, 20000 Hz

MID 2 Gain

Adjusts the gain of the middle range 2. Positive (+) settings will emphasize the middle range 2.

Value: -15--+15 dB

High Freq (High Frequency)

Selects the frequency of the high range.

Value: 2000, 4000, 5000, 6300, 8000, 10000, 12500, 16000, 20000 Hz

HIGH Gain

Adjusts the gain of the high frequency. Positive (+) settings will emphasize the high-frequency range.

Value: -15- +15 dB

TOTAL Gain

Adjusts the total gain.

Value: -15- +15 dB

MIDI/USB

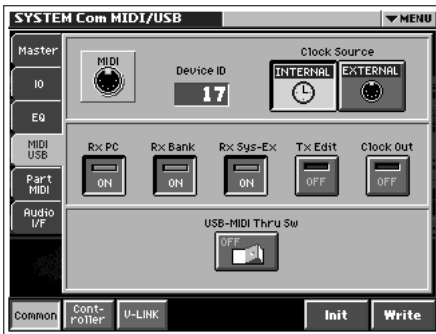

Device ID (Device ID Number)

When you want to transmit or receive System Exclusive messages, set this parameter to match the Device ID number of the other MIDI device.

Value: 17–32

Clock Source

The LFO cycle or multi-effects changes can be synchronized to a clock (tempo). When this is used by the patch, this Clock Source setting determines the clock which will be used.

Value

INTERNAL: The Patch Tempo will be used.

EXTERNAL: Synchronize to the clock of an external sequencer.

Rx PC (Receive Program Change Switch)

Specifies whether Program Change messages will be received (ON) or not (OFF).

Value: OFF, ON

Rx Bank (Receive Bank Select Switch)

Specifies whether Bank Select messages will be received (ON) or not (OFF).

Value: OFF, ON

Rx Sys-Ex (Receive System Exclusive Switch)

Specifies whether System Exclusive messages will be received (ON) or not (OFF).

Value: OFF, ON

Tx Edit (Transmit Edit Data Switch)

Specify whether changes you make in the settings of a patch will be transmitted as system exclusive messages (ON), or will not be transmitted (OFF).

Value: OFF, ON

Clock Out

Specifies whether MIDI clock will be transmitted (ON) or not (OFF).

Value: OFF, ON

USB-MIDI Thru Sw (USB-MIDI Thru Switch)

This switch specifies whether MIDI messages received at the MIDI connector will be re-transmitted from the MIDI OUT connector (ON) or not (OFF).

Value: OFF, ON

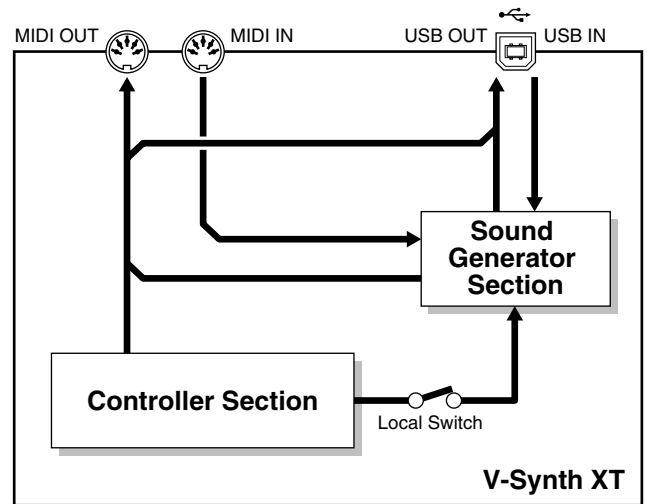

USB-MIDI Thru Sw=OFF

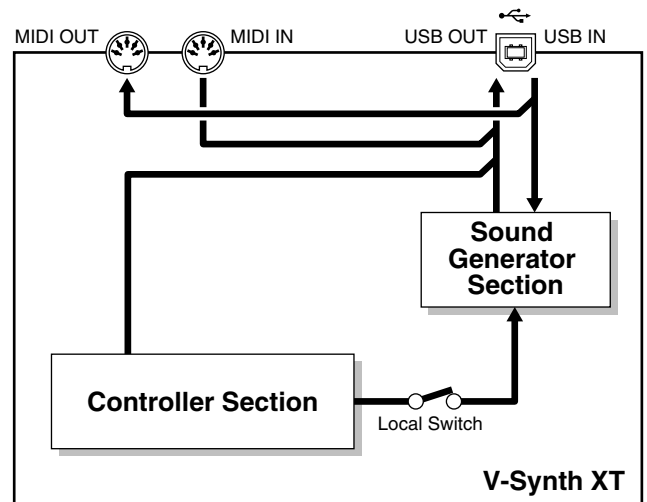

USB-MIDI Thru Sw=ON

Settings Common to All Modes (System Mode)

Part MIDI

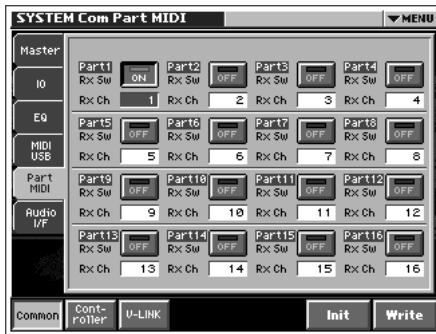

Part 1–16 Rx Sw (Part 1–16 Receive Switch)

For each part, specify whether MIDI messages will be received (ON), or not (OFF).

If this is “ON,” you can play that part from an external MIDI device. Normally, you will select “ON” only for part 1 which you play from the keyboard.

Value: OFF, ON

Part 1–16 Rx Ch (Part 1–16 Receive Channel)

Specifies the MIDI receive channel for each part.

Value: 1–16

NOTE

Performance data directed to the V-Synth XT itself will be transmitted on the channel you specified for part 1.

NOTE

In Rhythm mode, you can use eleven parts (non-rhythm parts) simultaneously. For this reason, the “Part MIDI” setting functions as follows.

- Part 1: The MIDI receive channel of the Rhythm part
- Part 2–12: Other parts (non-rhythm parts)
- Part 13–16: Not used

Audio I/F

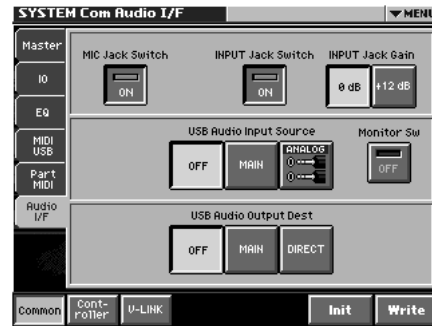

MIC Jack Switch

Specifies whether the front panel MIC jack will be enabled (ON) or disabled (OFF).

Value: ON, OFF

INPUT Jack Switch

Specifies whether the rear panel INPUT jacks will be enabled (ON) or disabled (OFF).

Value: ON, OFF

INPUT Jack Gain

Sets the gain of the rear panel INPUT jacks.

Value: 0db, +12db

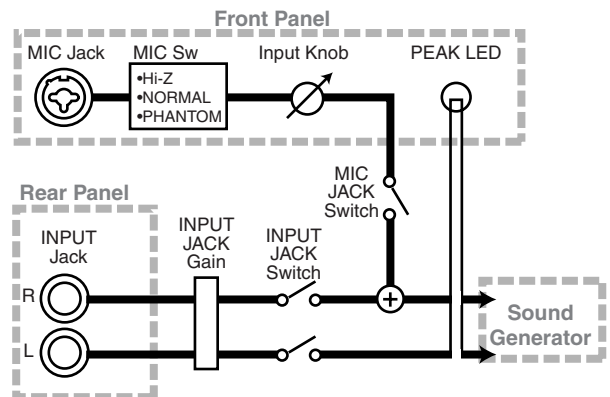

USB Audio Input Source

When the V-Synth XT is connected via USB to your computer, this specifies the source of the USB audio that will be output to the computer.

Value: OFF, MAIN, ANALOG

USB Audio Input Monitor Sw

Specifies whether USB Audio Input Source monitoring will be sent from the V-Synth XT's MAIN OUT (ON) or will not be sent (OFF).

Value: ON, OFF

USB Audio Output Dest

When the V-Synth XT is connected via USB to your computer, this specifies the output destination of the USB audio that is received from the computer.

Value: OFF, MAIN, DIR

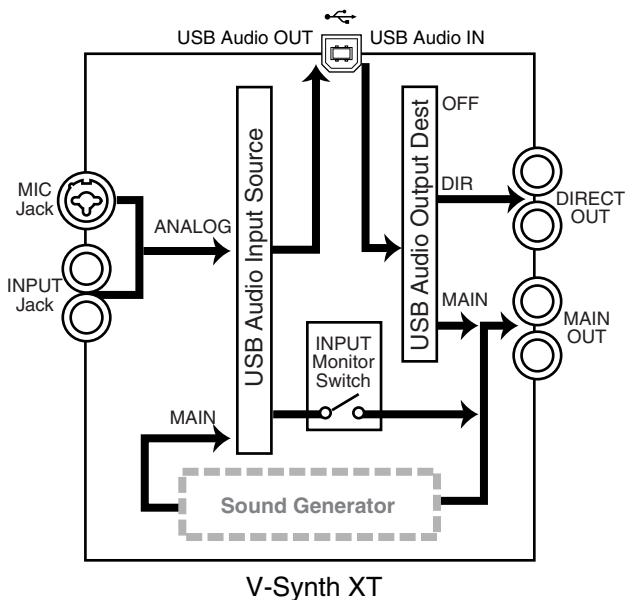

Controller Settings (Controller)

Tx



Patch Tx Ch (Patch Transmit Channel)

Specifies the transmit channel of MIDI messages in Patch mode. If you do not want to transmit MIDI messages to external MIDI devices, turn this parameter "OFF." If you want the transmit channel to always match the Patch Receive Channel, set this parameter to "RX CH."

Value: 1-16, RX CH, OFF

Tx PC (Transmit Program Change Switch)

Specifies whether Program Change messages will be transmitted (ON) or not (OFF).

Value: OFF, ON

Tx Bank (Transmit Bank Select Switch)

Specifies whether Bank Select messages will be transmitted (ON) or not (OFF).

Value: OFF, ON

Tx Active Sens (Transmit Active Sensing Switch)

Specifies whether Active Sensing messages will be transmitted (ON) or not (OFF).

Value: OFF, ON

Settings Common to All Modes (System Mode)

KBD



Local Sw (Local Switch)

The Local Switch determines whether the internal sound generator is disconnected (OFF) from the controller section (Time Trip Pad and so on); or not disconnected (ON). Normally this is left "ON."

Value: OFF, ON

Key Hold Panic Key

This specifies the key (note) that will stop all sounds being held by the Key Hold function (p. 39).

Value: C2–C7

TT Pad



X Assign-XY

Specifies the MIDI controller number that will be transmitted by movements in the 'X' (horizontal) direction when the Time Trip pad is in XY mode.

Value

OFF: No message will be transmitted.

CC01–31, 33–95: Controller numbers 1–31, 33–95

Y Assign-XY

Specifies the MIDI controller number that will be transmitted by movements in the 'Y' (vertical) direction when the Time Trip pad is in XY mode.

Value

OFF: No message will be transmitted.

CC01–31, 33–95: Controller numbers 1–31, 33–95

X Assign-TT (X Assign-Time Trip)

Specifies the MIDI controller number that will be transmitted by movements in the 'X' (horizontal) direction when the Time Trip pad is in Time Trip mode.

Value

OFF: No message will be transmitted.

CC01–31, 33–95: Controller numbers 1–31, 33–95

Y Assign-TT (Y Assign-Time Trip)

Specifies the MIDI controller number that will be transmitted by movements in the 'Y' (vertical) direction when the Time Trip pad is in Time Trip mode.

Value

OFF: No message will be transmitted.

CC01–31, 33–95: Controller numbers 1–31, 33–95

E1 - E8 Knob

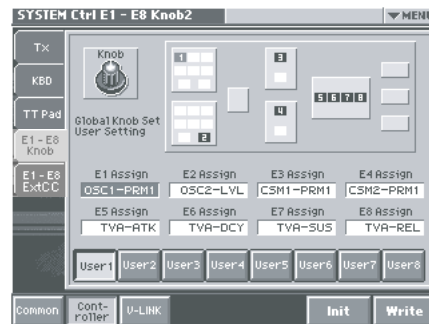

Here you can create user sets (1–8) for the E1–E8 knobs. You can assign the E1–E8 knobs to the knobs shown in the PATCH PLAY screen.

Procedure:

1. Touch the user set that you want to edit ([User1]–[User8]).

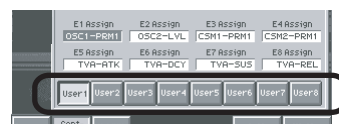

2. Touch the knob that you want to assign (E1–E8 Assign).



3. Use [INC]/[DEC] or the VALUE dial to select a parameter. The screen shows the corresponding location in the PATCH PLAY screen.

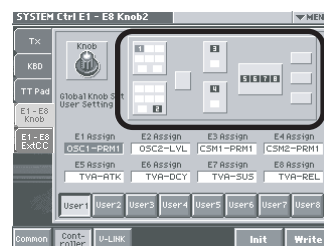

4. Repeat steps 2. and 3. until you've assigned all of the knobs.
5. When you're finished, touch <Write>.

E1 - E8 ExtCC (E1-E8 External CC)

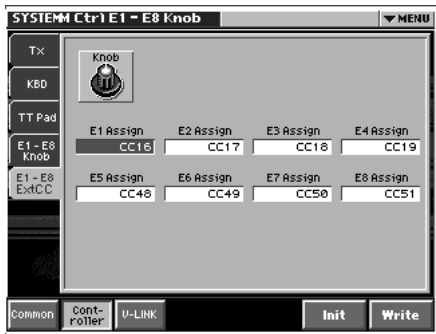

E1-E8 Assign

Specifies the MIDI controller number that will be transmitted by movements in the E1-E8 knobs.

Value

OFF: No message will be transmitted.

CC01-31, 33-95: Controller numbers 1-31, 33-95



If you want to use the E1-E8 knobs to transmit MIDI to an external device, press the [CTRL] button to access the Control screen and turn < External Control > "ON" (p. 63).

V-LINK Settings (V-LINK)

Tx



MIDI Channel (V-LINK MIDI Channel)

Specifies the channel used to transmit MIDI messages for V-LINK control.

Value: 1-16

Audio (V-LINK Audio Switch)

Specifies whether sound from the externally connected video device will be played (ON) or not played (OFF).

Value: OFF, ON

KBD Output (V-LINK Keyboard Output Fade Switch)

Specifies whether the video output from the video device will be stopped (ON) or will not be stopped (OFF) when you are not holding down a key.

Value: OFF, ON

Palette Local Sw (V-LINK Patch Palette Local Switch)

Specify whether you will press PATCH PALETTE NUMBER [1]-[8] in V-LINK mode to switch patches (ON) or not (OFF)

Value: OFF, ON

Settings Common to All Modes (System Mode)

TT Pad



TT Pad Local Sw (V-LINK Time Trip Pad Local Switch)

Specify whether the Time Trip pad and the internal sound generator will be disconnected in V-LINK mode (OFF) or not disconnected (ON).

Value: OFF, ON

X Assign-XY (V-LINK X Assign-XY)

Specify the V-LINK function that will be controlled when you operate the Time Trip pad in the X (horizontal) direction in XY mode.

Value

OFF: The time trip pad will not be used.

PLAYBACK-SPEED: Playback speed

DISSOLVE-TIME: Dissolve time (time over which the image switches)

AUDIO LEVEL: Volume during audio playback

COLOR-CB: Color Cb (color-difference signal)

COLOR-CR: Color Cr (color-difference signal)

BRIGHTNESS: Brightness

VFX1: Visual effects 1

VFX2: Visual effects 2

VFX3: Visual effects 3

VFX4: Visual effects 4

OUTPUT-FADE: Output fade

T-BAR: T bar

Y Assign-XY (Link Y Assign-XY)

Specify the V-LINK function that will be controlled when you operate the Time Trip pad in the Y (vertical) direction in XY mode.

Value

OFF: The time trip pad will not be used.

PLAYBACK-SPEED: Playback speed

DISSOLVE-TIME: Dissolve time (time over which the image switches)

AUDIO LEVEL: Volume during audio playback

COLOR-CB: Color Cb (color-difference signal)

COLOR-CR: Color Cr (color-difference signal)

BRIGHTNESS: Brightness

VFX1: Visual effects 1

VFX2: Visual effects 2

VFX3: Visual effects 3

VFX4: Visual effects 4

OUTPUT-FADE: Output fade

T-BAR: T bar

Assign-TT (V-LINK Assign-Time Trip)

Specify the V-LINK function that will be controlled when you operate the Time Trip pad in Time Trip mode.

Value

OFF: The time trip pad will not be used.

TIME-TRIP: Time trip

E1-E8 Knob



E1-E8 Assign (V-LINK Knob E1-E8 Assign)

Specify the V-LINK function that will be controlled when you turn the E1-E8 knobs.

Value

OFF: The assignable controller will not be used.

PLAYBACK-SPEED: Playback speed

DISSOLVE-TIME: Dissolve time (time over which the image switches)

AUDIO LEVEL: Volume during audio playback

COLOR-CB: Color Cb (color-difference signal)

COLOR-CR: Color Cr (color-difference signal)

BRIGHTNESS: Brightness

VFX1: Visual effects 1

VFX2: Visual effects 2

VFX3: Visual effects 3

VFX4: Visual effects 4

OUTPUT-FADE: Output fade

Knob Local Sw (V-LINK Knob E1-E8 Local Switch)

Specify whether the assignable controller knobs E1-E8 will be disconnected from the internal sound generator in V-LINK mode (OFF) or not disconnected (ON).

Value: OFF, ON

Disk-Related Functions (Disk Mode)

Here you can load a project from disk into the internal work area (Load), or save the project that is in the work area (Save). You can also format a disk, or copy files and folders.

MEMO

In this chapter, we will collectively refer to internal memory and memory cards as “disks.”

About Disk Utility

Disk Utility contains the following functions. In the DISK UTILITY MENU screen, you can select the desired function and execute it.

Load Project

This function loads project data from disk into the V-Synth XT's work area. → p. 132

Save Project

This function saves project data to disk. → p. 132

Clean Project

Clean up a disk by deleting unwanted files. → p. 133

Import Files

Import individual patch or wave files. → p. 133

Format

Initialize (format) a disk. → p. 134

Tools

Copy or move a file or folder. → p. 135

Basic Disk Utility Operations

1. If you are using a memory card, insert the appropriate memory card into the PC CARD slot.
2. Press [MODE] to access the V-SYNTH XT MODE MENU window.
3. Touch <DISK>.

The DISK UTILITY MENU screen appears.



4. Touch the button for the function that you want to execute. The screen for the function you intend to execute appears.

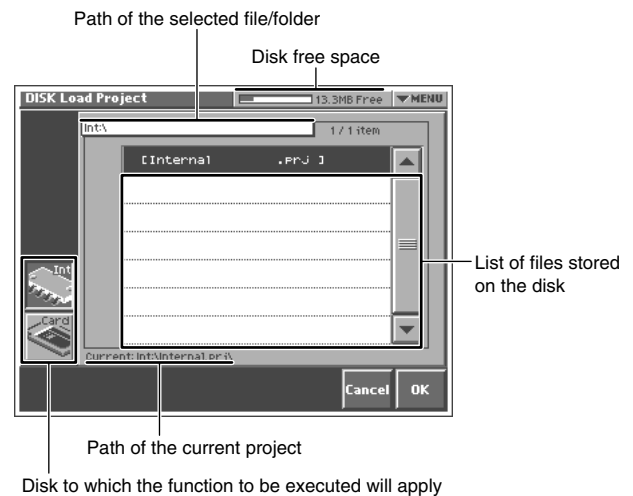

For details on operations in the Disk Utility screens, refer to the explanations on the following pages.

5. Verify the contents of the screen, and touch <OK> to execute.

When the operation is completed, the display will briefly indicate “COMPLETED!”

HINT

To cancel the operation, touch <Cancel>.

6. Press [EXIT] to exit Disk mode.

NOTE

Never turn off the power of the V-Synth XT while performing an operation in Disk mode. Doing so may destroy the files.

Disk-Related Functions (Disk Mode)

Sorting the Files Displayed in the File List

In each Disk Utility screen, you can change the order of the files displayed in the file list.

1. In the upper right of the disk utility screen, touch **<▼ MENU>**.

A pulldown menu like the following appears.

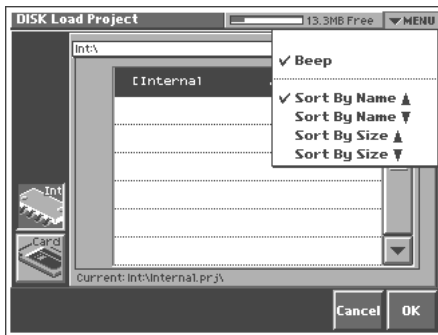

2. Choose the desired sorting order from the pull-down menu.
<Sort By Name ▲>: Sort in alphabetical order of file name.
<Sort By Name ▼>: Sort in reverse alphabetical order of file name.
<Sort By Size ▲>: Sort in ascending order of file size.
<Sort By Size ▼>: Sort in descending order of file size.

Loading a Project from Disk into the V-Synth XT (Load Project)

This function loads a project on disk into the V-Synth XT's work area.

NOTE

Be aware that if patches created on a V-Synth with a system version older than 2.0 (i.e., versions 1.00 through 1.51 of the system) use preset PCM waves, those patches will not play correctly on version 2.0.

■ Patches that use a PCM oscillator

Patches that use preset waves

Not compatible
Will NOT play correctly in version 2.0

Patches that use user waves

Upwardly compatible
Can be imported and played in version 2.0

■ Patches that use an analog oscillator

■ Patches that use an external input oscillator

Upwardly compatible
Can be imported and played in version 2.0

NOTE

When a project is loaded, work area will be rewritten. If work area contains important data, you must save it to disk before you load other data.

1. Access the DISK UTILITY MENU screen (p. 131).

2. Touch **<Load Project>**.

The Disk Load Project screen appears.

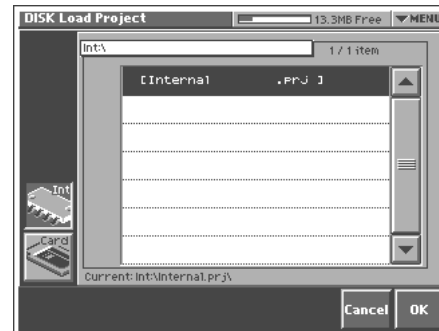

3. To load from internal memory, touch **<Int>**. To load from a memory card, touch **<Card>**. Then select the project that you want to load.

4. Touch **<OK>**.

A WARNING window like the following appears.



HINT

If you want to cancel the procedure at this point, touch **<CANCEL>**.

5. Touch **<EXECUTE>** to execute the operation.

Saving Project on Disk (Save Project)

Save the project in the work area to disk.

1. Access the DISK UTILITY MENU screen (p. 131).

2. Touch **<Save Project>**.

The Disk Save Project screen appears.

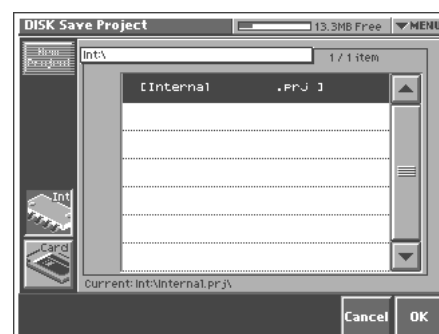

3. To save to internal memory, touch <Int>. To save to memory card, touch <Card>. Then select the save-destination project.

HINT

If you want to save the data as a new project, touch <New Project>. The PROJECT Name window will appear. Assign a name to the new project.

4. Touch <OK>.

A WARNING window like the following appears.



HINT

If you want to cancel the procedure at this point, touch <CANCEL>.

5. Touch <EXECUTE> to execute the operation.

Delete Unneeded Files (Clean Project)

This lets you clean up the contents of the disk by deleting files that cannot be used by the V-Synth XT or waves that are not used by patches. Executing this operation can increase the free space available on the disk. This operation can also be used to renumber the patches/waves so that any numbers that weren't being used are put to use, thus bringing up the slack.

* Patch numbers (493–512) used by Rhythm mode (p. 102) will not be renumbered.

MEMO

If the current project is in Internal memory, all internal memory will be cleaned up. If the current project is on a memory card, only the current project will be cleaned up.

1. Access the DISK UTILITY MENU screen.

2. Touch <Clean Project>.

The DISK Clean Project screen appears.

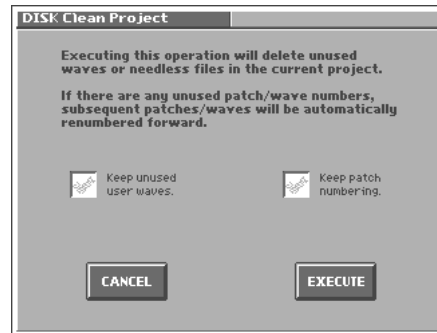

3. Touch the check boxes to choose what the Clean Project command is to do.

Keep unused user waves.:

Check this box if you want to keep all the waves you've sampled or imported from an external device (user waves).

Keep patch numbering.:

Check this box if you don't want patches to be renumbered to fill up any unused patch numbers.

4. Touch <EXECUTE> to execute the operation.

Importing Individual Patch or Wave Files (Import Files)

You can import individual patch or wave files or folders into the work area of the V-Synth XT.

NOTE

Be aware that if patches created on a V-Synth with a system version older than 2.0 (i.e., versions 1.00 through 1.51 of the system) use preset PCM waves, those patches will not play correctly on version 2.0.

- Patches that use a PCM oscillator
 - Patches that use preset waves
 - ✗ Not compatible
 - Will NOT play correctly in version 2.0
 - Patches that use user waves
 - Upwardly compatible
 - Can be imported and played in version 2.0
- Patches that use an analog oscillator
- Patches that use an external input oscillator
 - Upwardly compatible
 - Can be imported and played in version 2.0

NOTE

The data will be imported into unused patch/wave numbers. Importing is not possible if there are no empty patches or waves.

1. Access the DISK UTILITY MENU screen (p. 131).

Disk-Related Functions (Disk Mode)

2. Touch <Import Files>.

The Disk Import Files screen appears.



3. Touch <Patch> if you want to import a patch, or touch <Wave> if you want to import a wave.

4. Touch <Preset> if you want to import from preset memory, touch <Int> if you want to import from internal memory, or touch <Card> if you want to import from a memory card.

5. From the file list, select the file/folder that you want to import.

Here you can use the following functions. Touch the appropriate button to execute.

Prevw: Preview (audition) the selected file (.w00/.wav/.aif).

Info: View information for the selected file.

Mark All: Mark all files/folders in the file list.

Mark: Mark the selected file/folder in the file list.

Open: Open the selected folder.

Close: Move to the next higher folder.

MEMO

If you have selected a patch whose oscillator type is "PCM," the wave used by that patch will also be imported.

6. Touch <OK>.

A WARNING window like the following appears.



HINT

If you want to cancel the procedure at this point, touch <CANCEL>.

7. Touch <EXECUTE> to execute the operation.

Initializing a Disk (Format)

You can initialize (format) a disk, erasing all data from it.

1. Access the DISK UTILITY MENU screen (p. 131).

2. Touch <Format>.

The Disk Format screen appears.

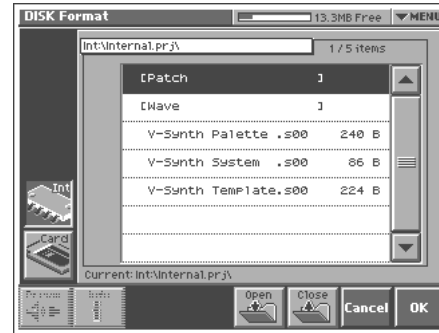

3. If you want to format the internal memory, touch <Int>. If you want to format a memory card, touch <Card>.

Here you can use the following functions. Touch the appropriate button to execute.

Prevw: Preview (audition) the selected file (.w00/.wav/.aif).

Info: View information for the selected file.

Mark All: Mark all files/folders in the file list.

Mark: Mark the selected file/folder in the file list.

Open: Open the selected folder.

Close: Move to the next higher folder.

4. When you format a memory card, the VOLUME Name window will appear, allowing you to assign a new volume name.

5. Touch <OK>.

A WARNING window like the following appears.



HINT

If you want to cancel the procedure at this point, touch <CANCEL>.

6. Touch <EXECUTE> to execute the operation.

Functions Related to Files and Folders (Tools)

You can manage files or folders by copying or moving them.

Copying Files/Folders (Copy)

1. Access the DISK UTILITY MENU screen (p. 131).

2. Touch <Tools>.

The Disk Tools screen appears.

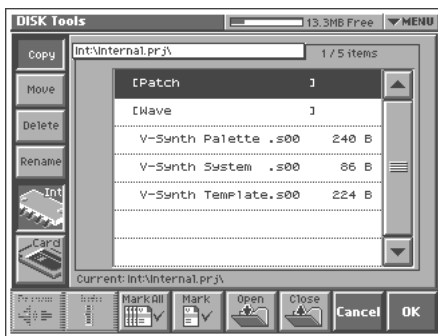

3. Touch <Copy>.

4. If you want to copy from internal memory, touch <Int>. If you want to copy from a memory card, touch <Card>.

5. In the file list, select the file or folder that you want to copy.

Here you can use the following functions. Touch the appropriate button to execute.

Prevw: Preview (audition) the selected file (.w00/.wav/.aif).

Info: View information for the selected file.

Mark All: Mark all files/folders in the file list.

Mark: Mark the selected file/folder in the file list.

Open: Open the selected folder.

Close: Move to the next higher folder.

6. Touch <OK>.

The Disk Tools Copy Destination screen appears.



7. If you want to copy to internal memory, touch <Int>. If you want to copy to a memory card, touch <Card>.

8. In the file list, select the copy-destination file or folder.

Here you can use the following functions. Touch the appropriate button to execute.

Prevw: Preview (audition) the selected file (.w00/.wav/.aif).

Info: View information for the selected file.

Open: Open the selected folder.

Close: Move to the next higher folder.

9. Touch <OK>.

A WARNING window like the following appears.



HINT

If you want to cancel the procedure at this point, touch <CANCEL>.

10. Touch <EXECUTE> to execute the operation.

Moving Files/Folders (Move)

1. Access the DISK UTILITY MENU screen (p. 131).

2. Touch <Tools>.

The Disk Tools screen appears.



3. Touch <Move>.

4. If you want to move a file or folder from internal memory, touch <Int>. If you want to move it to a memory card, touch <Card>.

Disk-Related Functions (Disk Mode)

5. In the file list, select the file or folder that you want to move.

Here you can use the following functions. Touch the appropriate button to execute.

Prevw: Preview (audition) the selected file (.w00/.wav/.aif).

Info: View information for the selected file.

Mark All: Mark all files/folders in the file list.

Mark: Mark the selected file/folder in the file list.

Open: Open the selected folder.

Close: Move to the next higher folder.

6. Touch <OK>.

The Disk Tools Move Destination screen appears.



7. If you want to move the file or folder to internal memory, touch <Int>. If you want to move it to a memory card, touch <Card>.

8. In the file list, select the move-destination file or folder.

Here you can use the following functions. Touch the appropriate button to execute.

Prevw: Preview (audition) the selected file (.w00/.wav/.aif).

Info: View information for the selected file.

Open: Open the selected folder.

Close: Move to the next higher folder.

9. Touch <OK>.

A WARNING window like the following appears.



HINT

If you want to cancel the procedure at this point, touch <CANCEL>.

10. Touch <EXECUTE> to execute the operation.

Deleting Files/Folders (Delete)

1. Access the DISK UTILITY MENU screen (p. 131).

2. Touch <Tools>.

The Disk Tools screen appears.



3. Touch <Delete>.

4. If you want to delete a file or folder from internal memory, touch <Int>. If you want to delete it from a memory card, touch <Card>.

5. In the file list, select the file or folder that you want to delete.

Here you can use the following functions. Touch the appropriate button to execute.

Prevw: Preview (audition) the selected file (.w00/.wav/.aif).

Info: View information for the selected file.

Mark All: Mark all files/folders in the file list.

Mark: Mark the selected file/folder in the file list.

Open: Open the selected folder.

Close: Move to the next higher folder.

6. Touch <OK>.

A WARNING window like the following appears.



HINT

If you want to cancel the procedure at this point, touch <CANCEL>.

7. Touch <EXECUTE> to execute the operation.

Renaming a Files/Folders (Rename)

1. Access the DISK UTILITY MENU screen (p. 131).

2. Touch <Tools>.

The Disk Tools screen appears.



3. Touch <Rename>.

4. If you want to rename a file or folder in internal memory, touch <Int>. If you want to rename a file or folder in a memory card, touch <Card>.

5. In the file list, select the file or folder that you want to rename.

Here you can use the following functions. Touch the appropriate button to execute.

Prevw: Preview (audition) the selected file (.w00/.wav/.aif).

Info: View information for the selected file.

Open: Open the selected folder.

Close: Move to the next higher folder.

6. Touch <OK>.

The Rename window appears.



7. Touch the on-screen alphabetic or numeric keys to enter the new name in the text box.

The on-screen keys have the following functions.

<←><→>: Move the cursor in the text box to the desired input location.

<Shift>: Turn this on when you want to input uppercase letters or symbols.

<Insert>: Turn this on when you want to insert a character at the cursor location.

<Clear>: Erases all characters in the text box.

<Delete>: Deletes the character at the cursor location.

<Back>: Deletes the character that precedes the cursor location.

HINT

You can also move the input location cursor by pressing the [◀] [▶] cursor buttons. Pressing [▲] will change the character at the cursor location to uppercase, and pressing [▼] will change it to lowercase.

8. When you have finished inputting, touch <OK> to execute the operation.

Connecting to Your Computer via USB (USB Mode)

About USB Functions

The V-Synth XT has three functions of USB functionality: **storage function** for transferring files, **MIDI function** for sending and receiving MIDI messages, and The **USB audio device function**.

System Requirements:

- Windows XP/2000/Me
- Mac OS X 10.2.3 or later
- Mac OS 9.0.4 or later

Driver Installation and Settings

In order to use the V-Synth XT as a USB device from your computer, you must first install the USB driver.

The correct driver and the installation procedure will depend on your system and on the other programs you are using. Be sure to read the Readme file on the CD-ROM before installation.

Windows XP/2000

→ \Driver\V-SynthXT\Usb_xp2k\README_E.HTM

Windows Me

→ \Driver\V-SynthXT\Usb_me\README_E.HTM

Mac OS X

→ \Driver\V-SynthXT\MacOSX\Readme_E.htm

Mac OS 9

→ \Driver\V-SynthXT\MacOS9\English\Readme_E.htm

Exchanging MIDI Messages with Your Computer (MIDI function)

What is the USB MIDI Driver?

The USB MIDI Driver is a software which passes data between the V-Synth XT and the application (sequencer software, etc.) that is running on the USB-connected computer.

The USB MIDI Driver sends data from the application to the V-Synth XT, and passes data from the V-Synth XT to the application.

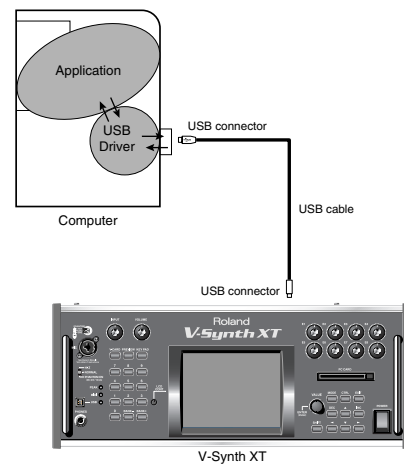

USB audio signal flow (USB audio device function)

USB audio signal flow is shown in the illustration below. For details on making USB audio settings, refer to “Audio I/F” (p. 126).

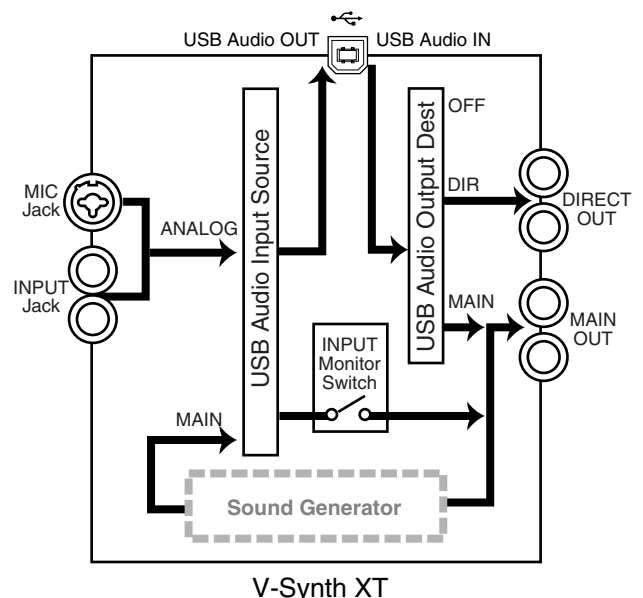

Transferring Files to or from Your Computer (Storage Function)

By connecting the V-Synth XT with your computer via a USB cable, you can transfer files such as projects, patches, and wave data from internal memory or a memory card to and from the hard disk or other media of your computer, in order to back up your data. You can use software on your computer to edit wave data you've created on the V-Synth XT. Conversely, wave data that you've created on your computer can be used on the V-Synth XT. In this way, USB Storage function lets you transfer files such as patch and waves to or from a connected computer.

NOTE

Never connect or disconnect the USB cable or turn off the power while data is being transferred.

For the rest of the procedure, read either "Windows Me/2000/XP users" or "Macintosh users" as appropriate.

Windows users: Read from page 139.

Macintosh users: Read from page 141.

Windows Users

Windows XP/2000/Me or later Users

Connecting the V-Synth XT to Your Computer

1. Make sure that the power of the V-Synth XT is turned off.
2. Start up your computer.
3. Connect the V-Synth XT and your computer using a USB cable.

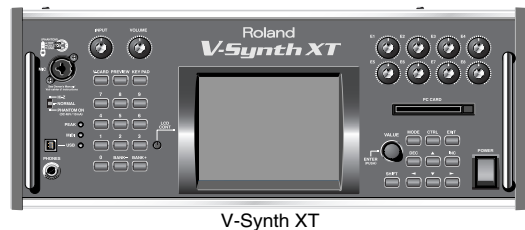
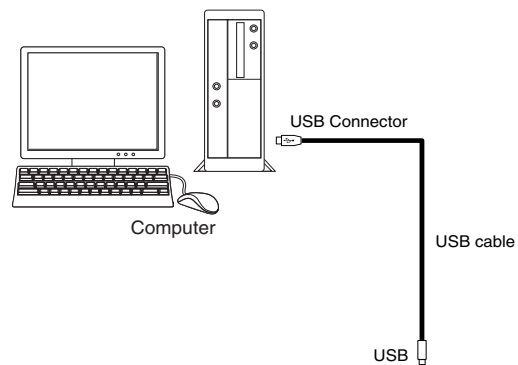

V-Synth XT

4. Turn on the power of V-Synth XT.
5. If you are using a memory card, insert that memory card into the PC CARD slot.
6. Press [MODE] to access the V-SYNTH XT MODE MENU window.
7. Touch <USB>.
The USB Storage screen appears.

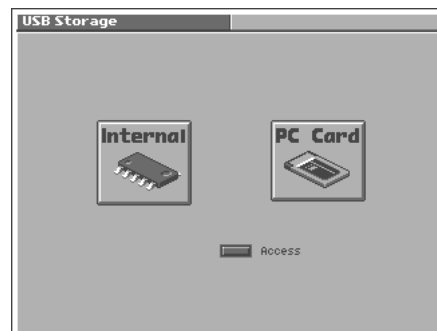

Connecting to Your Computer via USB (USB Mode)

8. Touch <Internal> or <PC Card> to establish the connection with your computer.

<Internal>: Mounts the internal memory as an external drive on your computer.

<PC Card>: Mounts the memory card as an external drive on your computer.

NOTE

You cannot select "PC Card" unless a memory card is inserted in the PC CARD slot.

9. When the USB connection is established, the driver installation will begin. A dialog box of "Found new hardware" will appear near the Windows task tray.

Installation is completely automatic. Please wait for it to be completed.

10. When installation is completed, open My Computer and you will see a new drive icon.

In Windows Me/2000, a drive icon named "Removable Disk" will appear. In Windows XP, the drive icon will be named "V-SYNTH XT" if you selected "Internal." If you selected "PC Card," it will show the volume label that you assigned when formatting the card. If you formatted the card on the V-Synth XT, the volume label will be "PC CARD."

11. Once the V-Synth XT is connected, you can transfer files by operating your computer.

NOTE

Do not perform the following actions while "Access" (the access indicator) in the USB Storage screen is blinking. Doing so may cause your computer to freeze, and may also damage the files in the drive.

- Do not disconnect the USB cable
- Do not remove the memory card while it is being accessed
- Do not suspend (standby), hibernate, restart, or shut down your computer
- Do not turn off the power of V-Synth XT.

Switching the Connected Drive

When USB-connected, here's how to switch between "Internal" (the V-Synth XT's internal memory) and "PC Card" (the memory card inserted in the V-Synth XT).

1. In the V-Synth XT's USB Storage screen, make sure that "Access" (the access indicator) is not blinking.
2. In My Computer, right-click the "Removable Disk" icon and execute "Eject."
3. In the V-Synth XT's USB Storage screen, touch <Internal> or <PC Card> to change drives.

Closing the USB Storage Screen

1. In the V-Synth XT's USB Storage screen, make sure that "Access" (the access indicator) is not blinking.
2. In My Computer, right-click the "Removable Disk" icon and execute "Eject."
3. Press [EXIT].

The USB Storage screen will close.

NOTE

If you press [EXIT] without performing the "Eject" operation on your computer, a WARNING window like the following will appear.



Touch <EXECUTE> to close this window only if you are unable to perform the "Eject" operation on your computer.

Canceling the USB Connection

Once you have connected the V-Synth XT and your computer in Storage function, you must cancel the USB connection on your computer before you do either of the following actions:

- Disconnect the USB cable
- Turn off the V-Synth XT's power while the USB cable is connected

1. Use "Eject hardware" (displayed in the task bar in the lower right of the screen) to cancel the connection with the V-Synth XT.

The "Removable Disk" drive icon will disappear from My Computer, and the USB connection will be cancelled.

🍏 Macintosh Users

Connecting the V-Synth XT to Your Computer

1. Make sure that the power of the V-Synth XT is turned off.
2. Start up your computer.
3. Connect the V-Synth XT and your computer using a USB cable.

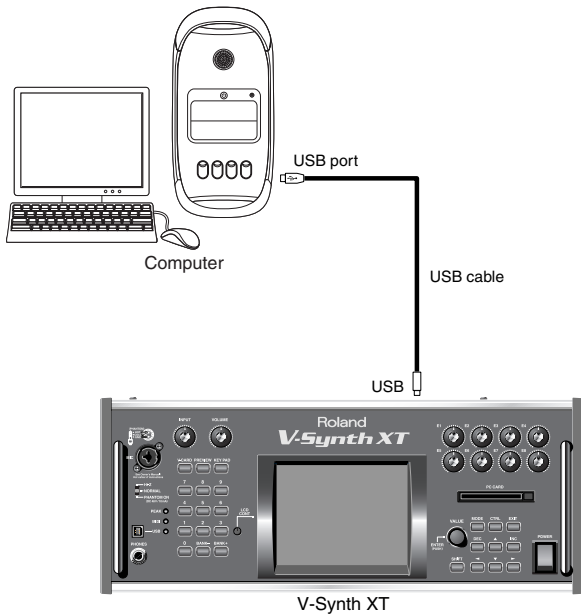

4. Turn on the power of V-Synth XT.
5. If you are using a memory card, insert that memory card into the PC CARD slot.
6. Press [MODE] to access the V-SYNTH XT MODE MENU window.
7. Touch <USB>.

The USB Storage screen appears.



8. Touch <Internal> or <PC Card> to establish the connection with your computer.
 - <Internal>: Mounts the internal memory as an external drive on your computer.
 - <PC Card>: Mounts the memory card as an external drive on your computer.

NOTE

You cannot select "PC Card" unless a memory card is inserted in the PC CARD slot.

9. When the USB connection is established, a new drive icon will appear on your desktop.

If you have selected "Internal," a drive icon named "V-SYNTH XT" will appear. If you selected "PC Card," it will show the volume label that you assigned when formatting the card. If you formatted the card on the V-Synth XT, the volume label will be "PC CARD."

10. Once the V-Synth XT is connected, you can transfer files by operating your computer.

NOTE

Do not perform the following actions while "Access" (the access indicator) in the USB Storage screen is blinking. Doing so may cause your computer to freeze, and may also damage the files in the drive.

- Do not disconnect the USB cable
- Do not remove the memory card while it is being accessed
- Do not sleep, restart, or shut down your computer
- Do not turn off the power of V-Synth XT.

Switching the Connected Drive

When USB-connected, here's how to switch between "Internal" (the V-Synth XT's internal memory) and "PC Card" (the memory card inserted in the V-Synth XT).

1. In the V-Synth XT's USB Storage screen, make sure that "Access" (the access indicator) is not blinking.
2. Select the V-Synth XT drive icon on your desktop, and either choose "Eject" from the "Special" menu, or drag the icon into the trash.
3. In the V-Synth XT's USB Storage screen, touch <Internal> or <PC Card> to change drives.

Closing the USB Storage Screen

1. In the V-Synth XT's USB Storage screen, make sure that "Access" (the access indicator) is not blinking.
2. Select the V-Synth XT drive icon on the desktop, and drag it into the "trash."
Alternatively, you can select one of the following menu commands:
 - In OS X: From the "Files" menu, select "Eject "V-SYNTH XT""
 - In OS 9: From the "Special" menu, select "Eject"
3. Press [EXIT].
The USB Storage screen will close.

NOTE

If you press [EXIT] without performing the "Eject" operation on your computer, a WARNING window like the following will appear.



Touch <EXECUTE> to close this window only if you are unable to perform the "Eject" operation on your computer.

Canceling the USB Connection

Once you have connected the V-Synth XT and your computer in Storage function, you must cancel the USB connection on your computer before you do either of the following actions:

- Disconnect the USB cable
 - Turn off the V-Synth XT's power while the USB cable is connected
1. Select the V-Synth XT drive icon on the desktop, and drag it into the "trash."
Alternatively, you can select one of the following menu commands:
 - In OS X: From the "Files" menu, select "Eject "V-SYNTH XT""
 - In OS 9: From the "Special" menu, select "Eject"

Examples of Using Storage Function

Backing Up Patch and Wave Data (Project) from the V-Synth XT

When using USB in Storage function, the data within the V-Synth XT may be damaged if you operate your computer incorrectly or if your computer crashes. As a precaution against such occurrences, we recommend that you create a backup as described below.

Backing Up the V-Synth XT's Internal Data onto Your Computer

1. Use a USB cable to connect the V-Synth XT to your computer as described in "Connecting the V-Synth XT to your computer" (p. 139, p. 141).
2. Using your computer, copy the V-Synth XT's files and folders onto a drive (e.g., hard disk) of your computer.
3. Cancel the USB connection (p. 140, p. 142).

Loading Backup Data from Your Computer into the V-Synth XT

1. Use a USB cable to connect the V-Synth XT to your computer as described in "Connecting the V-Synth XT to your computer" (p. 139, p. 141).
2. Using your computer, copy the files and folders that you previously saved on your computer to the V-Synth XT.
3. Cancel the USB connection (p. 140, p. 142).

Loading an Audio File (WAV/AIFF format) from Your Computer into the V-Synth XT (Import)

WAV/AIFF format audio files created by another device can be loaded into the V-Synth XT and used in the same way as data you've sampled on the V-Synth XT.

1. Use a USB cable to connect the V-Synth XT to your computer as described in "Connecting the V-Synth XT to your computer" (p. 139, p. 141).
2. From your computer, copy (drag & drop) the audio file saved on your computer into the *****.prj folder within the V-Synth XT.
3. Cancel the USB connection (p. 140, p. 142).
4. Use the Import menu (Import Files, p. 133) in the V-Synth XT's Disk mode to import the file you copied in step 2.
5. Use the Sample mode's Preview function (p. 114) to verify that the imported data will sound correctly.
6. Use the Sample mode's Save command (or the Disk mode's Save Project command) to save the project.
7. Use the Disk mode's Tools menu (Tools, p. 135) to delete the data you copied in step 2.

Connecting to Your Computer via USB (USB Mode)

The V-Synth XT's File Structure

As seen from your computer, the V-Synth XT's file structure is as follows.

Do not perform operations on your computer to erase (format) or rename these folders or files.

If the V-Synth XT stops operating correctly, break the USB connection between the computer and the V-Synth XT (p. 140, p. 142), and then execute the Factory Reset command (p. 147).

This will erase all the data that has been saved on the V-Synth XT. As a precaution against such occurrences, we recommend that you always make a backup of your data (p. 143).

Internal Memory

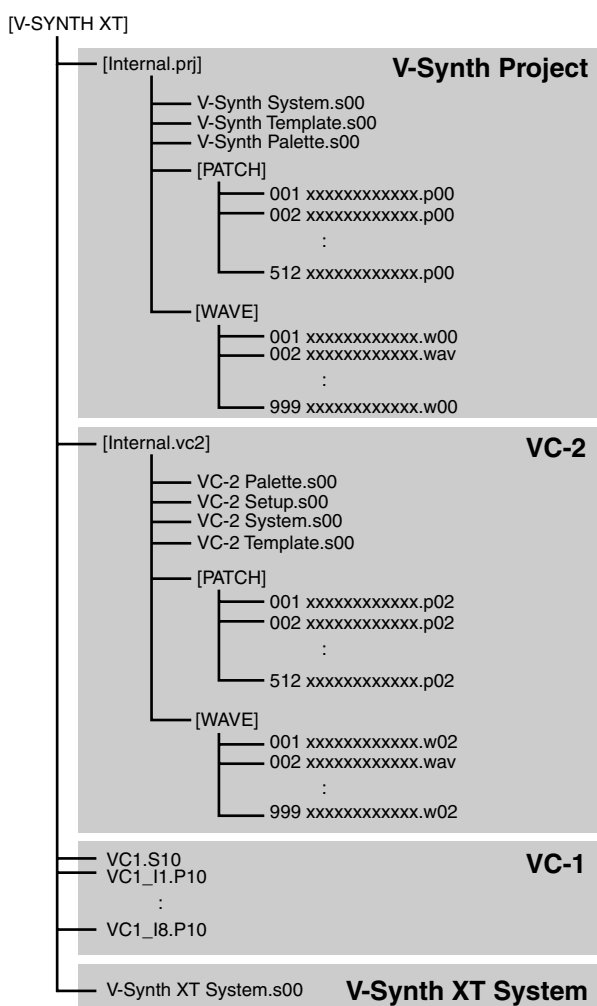

PC Card

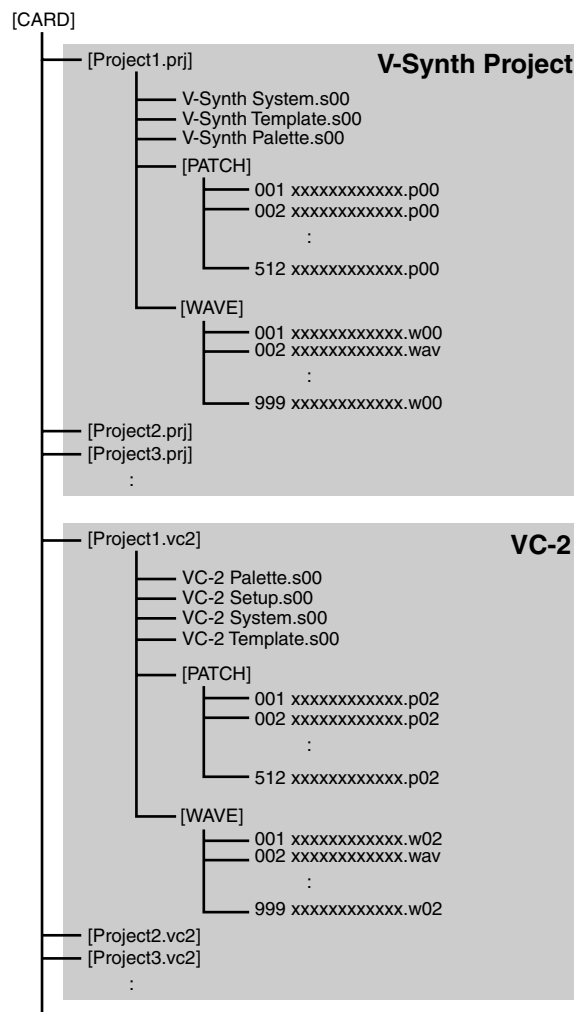

* The VC-1 that is built into the V-Synth XT cannot directly load files from the PC card. (It uses only internal memory.)

Using V-Synth Librarian

V-Synth Librarian is an application that lets you use your computer to manage projects, patches, and waves in the V-Synth XT's internal memory or on a PC card as a data library.

NOTE

V-Synth Librarian can handle only "V-Synth" projects, patches, and waves. It does not support "V-Card (VC-1, VC-2)" data.

Features of V-Synth Librarian

- You can drag and drop patches or wave data to copy or move them between multiple projects while preserving the links between patches.
- You can easily bring together the desired patches from multiple projects, and arrange them in the order in which you will actually use them in your song.
- Since you can import various types of wave data (WAV/AIFF/VPW), audio data created using other software on your computer can be used in a V-Synth project.

* *Once you've saved a completed project on your PC's hard disk, send it via USB to the V-Synth XT's internal memory or PC card so that it can be used. For details on using this software, click "Help"- "Using V-Synth Librarian" in the menu that appears after the software has been started up.*

Installation

Windows users

To install the software, double-click the installer icon located in \Librarian.

MacOS users

To install the software, double-click the installer icon located in \Librarian\English.

System Requirements

Windows

Operating System:

Microsoft® Windows® XP Home/XP Professional
Microsoft® Windows® 2000 Professional
Microsoft® Windows® Me

CPU/Clock:

Pentium®/Celeron™ processor 400 MHz or higher
Pentium® III 500 MHz or higher (recommended)

Memory (RAM):

128 MB or more
256 MB or more (recommended)

Display/Colors:

1024 x 768 or higher / 65,536 colors (16 bit High Color) or more

Hard Disk:

32 MB or more

MacOS

Operating System:

Mac OS (Classic) 9.0.4 or later
Mac OS (X) 10.2 or later

CPU/Clock:

PowerPC G3 233 MHz or higher (Classic)
PowerPC G3 500 MHz or higher (X)

Memory (RAM):

128 MB or more
256 MB or more (recommended)

Display/Colors:

1024 x 768 or higher / 32,000 colors or more

Hard Disk:

32 MB or more.

* *Roland Corporation assumes no liability whatsoever for any damages (including but not limited to loss of profit, loss of data, and other monetary damages) arising from the use of this software, or from the inability to use the software.*

* *This product has been test studied on computers that meet the above requirements, but we cannot guarantee that it will operate on any computer that meets these requirements. Please be aware that even under the same conditions, differences in the design of a particular computer or differences in the operation environment may produce differences in processing capacity.*

Other Functions

Transmitting Data to an External MIDI Device (Data Transfer)

Patch, setup and system settings will be transmitted to an external MIDI device. This operation is called **bulk dump**. Use this operation when you want to connect another V-Synth XT and play it using the same settings, or to save your data on an external MIDI device as a precaution against possible loss of sound data or system settings. To transmit data to an external MIDI device, connect the external MIDI device and V-Synth XT as shown in the diagram.

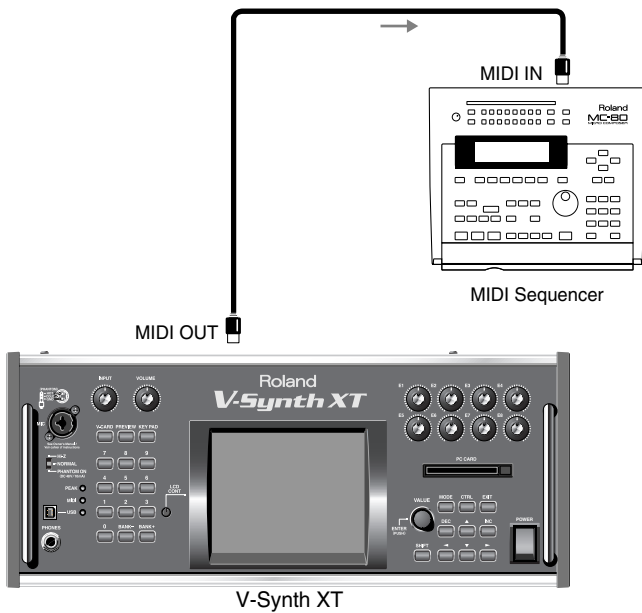

1. Touch **<▼ MENU>** in the upper right of the screen. A pulldown menu appears.

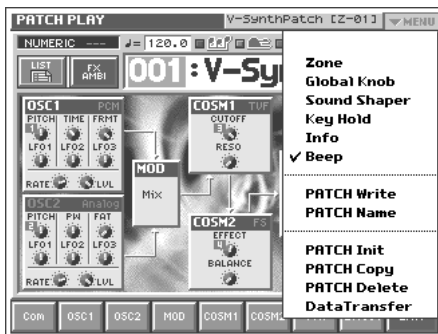

2. In the pulldown menu, touch **<Data Transfer>**. The Data Transfer window appears.

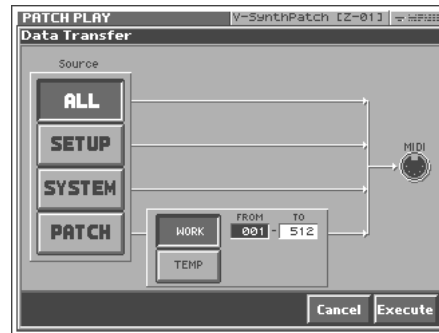

3. In "Source," select the type of data that you want to transmit.
 - <ALL>**: Patch, setup, system
 - <SETUP>**: Setup
 - <SYSTEM>**: System
 - <PATCH>**: Patch
 If you selected **<PATCH>**, specify the patch that is to be sent.
 - <WORK>**: Transmit patches from the work area. Use the "FROM" - "TO" fields to specify the range of patch numbers (001-512) that will be transmit.
 - <TEMP>**: Transmit patch from the temporary area.
4. Set the external MIDI device so that it will be ready to receive data, and touch **<Execute>** to execute data transmission. While the data is being transmitted, the display will indicate "Transmitting..." When "COMPLETED!" is displayed, the transmission has been completed.

HINT

To halt during transmission, touch **<ABORT>**.

Reset to Default Factory Settings (Factory Reset)

This restores all data in the V-Synth XT to the factory-set condition (Factory Reset).

NOTE

If there is important data you've created that's stored in the V-Synth XT's internal memory, all such data is discarded when a Factory Reset is performed. If you want to keep the existing data, save it on a memory card (p. 132), USB backing up onto a computer (p. 143) or transmit it to an external MIDI device and save it (p. 146).

1. Press [MODE].

The V-SYNTH XT MODE MENU window appears.

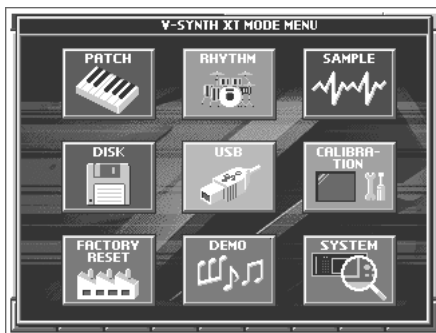

2. Touch <FACTORY RESET>.

The Factory Reset screen appears.



3. Touch <Execute> to execute the Factory Reset.

When the display indicates "COMPLETED," the factory reset operation has been completed.

Viewing Various Information (Info)

1. In the upper right of the screen, touch <▼ MENU>.

A pull-down menu appears.

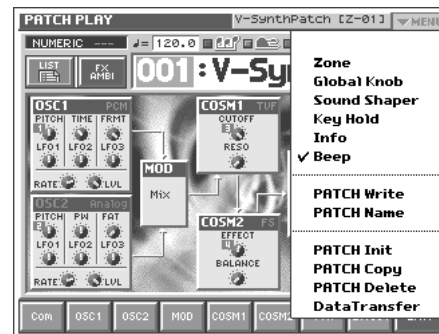

2. In the pull-down menu, touch <Info>.

The PATCH Information window appears.

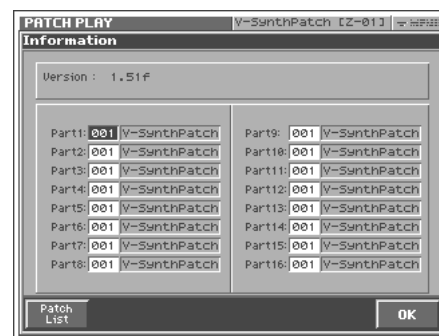

This window shows the following information.

Version: The V-Synth XT's program version

Part: The number and name of the patch assigned to each part

3. When you have finished viewing the information, touch <OK> to close the window.

Adjusting the Sensitivity of the Touch Screen (Calibration Mode)

Adjusting the Sensitivity of the Touch Screen

Perform this adjustment if the touch panel no longer responds as you expect.

1. Press [MODE].

The V-SYNTH XT MODE MENU window appears.

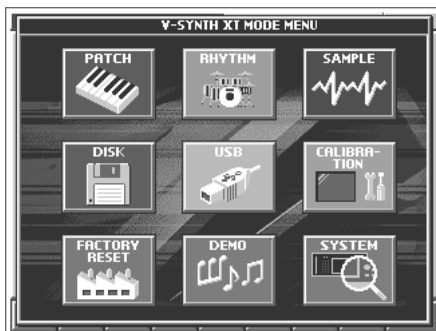

2. Touch <CALIBRATION>.

The T SCREEN CALIBRATION screen appears.

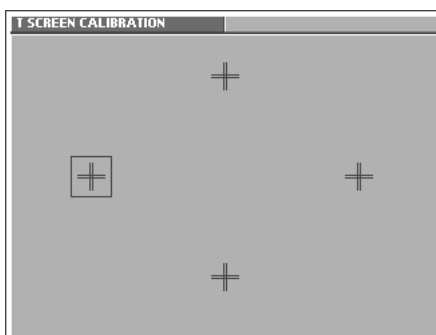

3. Touch the center of "+" symbol indicated by the square symbol in the screen, in the following order: left → top → right → bottom.

When you have touched all four points, the screen will close, and the sensitivity of the touch screen will be calibrated.

Appendices

Parameter List

Patch Parameters

Common Group (p. 79)

| Parameter | | Value |
|---------------------|--------------------------------------|---|
| General | | |
| Structure Type | | TYPE1, TYPE2, TYPE3 |
| Portamento | Portamento Switch | OFF, ON |
| Mode | Portamento Mode | NORMAL, LEGATO |
| Type | Portamento Type | RATE, TIME |
| Time | Portamento Time | 0-127 |
| Time Velo Sens | Portamento Time Velocity Sensitivity | -63- +63 |
| Mono/Poly | | Mono, Poly |
| Legato | Legato Switch | OFF, ON |
| Bender | | |
| Octave Shift | | -3- +3 |
| Bend Range Up | Pitch Bend Range Up | 0-48 |
| Bend Range Down | Pitch Bend Range Down | 0-48 |
| TT Pad | | |
| Mode | Time Trip Pad Mode | XY, TT |
| Hold | Time Trip Pad Hold Switch | OFF, ON |
| Matrix Ctrl | | |
| Source | Matrix Control Source | OFF, CC01-31, CC33-95, BEND, AFT, +PAD-X/Y, PAD-X/Y, TRIP-R, BEAM-L/R, KNOB1/2, VELO, KEYF |
| Sens | Matrix Control Sens | -63- +63 |
| Destination 1, 2 | Matrix Control Destination 1, 2 | (*) |
| Arpeggio | | |
| Arpeggio Switch | | OFF, ON |
| Patch Tempo | | 20.0-250.0 |
| Hold | Arpeggio Hold Switch | OFF, ON |
| Octave Range | Arpeggio Octave Range | -3- +3 |
| KBD Velo | Arpeggio Keyboard Velocity | REAL, 1-127 |
| Duration | Arpeggio Duration | 0-100% |
| Motif | Arpeggio Motif | UP, DOWN, UP&DOWN, RANDOM, NOTE ORDER, RHYTHM, PHRASE, AUTO |
| Shuffle Rate | Arpeggio Shuffle Rate | 0-100% |
| Shuffle Resolution | Arpeggio Shuffle Resolution |  (Sixteenth note),  (Eighth note) |
| Tune | | |
| Patch Coarse Tune | | -48- +48 |
| Patch Fine Tune | | -50- +50 |
| Scale Tune | Scale Tune Switch | OFF, ON |
| Scale Tune C-B | | -100- +100 |
| Zone | | |
| Current Zone | | Zone 01-16 |
| Zone 01-16 Range Hi | | C-1-G9 |

* OFF, OSC1/2-PITCH, OSC1/2-TIME/PW, OSC1/2-FORMA/FAT, OSC1/2-LVL, OSC1/2-PENV-ATK, OSC1/2-PENV-DCY, OSC1/2-PENV-REL, OSC1/2-TENV-ATK, OSC1/2-TENV-DCY, OSC1/2-TENV-REL, OSC1/2-FENV-ATK, OSC1/2-FENV-DCY, OSC1/2-FENV-REL, OSC1/2-AENV-ATK, OSC1/2-AENV-DCY, OSC1/2-AENV-REL, OSC1/2-LFO-RATE, OSC1/2-LFO-PCH, OSC1/2-LFO-TM/PW, OSC1/2-LFO-FR/FT, OSC1/2-LFO-LVL, CSM1/2-PRM1, CSM1/2-PRM2, CSM1/2-ENV1-ATK, CSM1/2-ENV1-DCY, CSM1/2-ENV1-REL, CSM1/2-ENV2-ATK, CSM1/2-ENV2-DCY, CSM1/2-ENV2-REL, CSM1/2-LFO-RATE, CSM1/2-LFO-PRM1, CSM1/2-LFO-PRM2, TVA-LVL, TVA-ENV-ATK, TVA-ENV-DCY, TVA-ENV-REL, TVA-LFO-RATE, TVA-LFO-LVL, TVA-LFO-PAN, MFX-SEND, CHO-SEND, REV-SEND, MFX-PRM1-3, TVA-PAN

OSC1/OSC2 Group (p. 86)

| Parameter | | Value |
|-----------------------------|--|---|
| Oscillator Switch | | OFF, ON |
| OSC Type | | |
| Oscillator Type | | ANALOG, PCM, EXT IN |
| Wave Gain | | -12- +12 dB |
| Waveform | Analog Oscillator Waveform | SAW, SQUARE, TRIANGLE, SINE, RAMP, JUNO, HQ-SAW, HQ-SQUARE, NOISE, LA-SAW, LA-SQUARE, SUPER-SAW, FEEDBACK-OSC, X-MOD-OSC |
| Impact | Analog Oscillator Impact | 0.0-4.0 |
| Time Trip Sw | Time Trip Switch | OFF, ON |
| Beat Keep | Time Trip Beat Keep | OFF, ON |
| Waveform | PCM Oscillator Waveform | 000-999 |
| Vari Sw | PCM Oscillator Vari Switch | OFF, ON |
| Start Offset | PCM Oscillator Start Offset | 0-** |
| Playback Mode | PCM Oscillator Playback Mode | RETRIGGER, LEGATO, STEP, EVENT |
| Loop | PCM Oscillator Loop Switch | OFF, ON |
| Robot Voice | PCM Oscillator Robot Voice Switch | OFF, ON |
| Tempo Sync | PCM Oscillator Tempo Sync Switch | OFF, ON |
| Pitch | | |
| Pitch | Oscillator Pitch | -63 - +63 |
| Pitch KF | Oscillator Pitch Key Follow | -200- +200 |
| Coarse | Oscillator Coarse Tune | -48- +48 |
| Fine | Oscillator Fine Tune | -50- +50 |
| Random | Oscillator Random Pitch Depth | 0, 1, 2, 3, 4, 5, 6, 7, 8, 9, 10, 20, 30, 40, 50, 60, 70, 80, 90, 100, 200, 300, 400, 500, 600, 700, 800, 900, 1000, 1100, 1200 |
| Pit LFO Dp | Oscillator Pitch LFO Depth | -63- +63 |
| Velocity Curve | Envelope Velocity Curve | 0-7 |
| Velocity Sens | Envelope Velocity Sensitivity | -63- +63 |
| Velocity A-Sens | Envelope Attack Time Velocity Sensitivity | -63- +63 |
| Velocity D-Sens | Envelope Decay Time Velocity Sensitivity | -63- +63 |
| Velocity R-Sens | Envelope Release Time Velocity Sensitivity | -63- +63 |
| ADSR Attack | Envelope Attack Time | 0-127, note (*) |
| ADSR Decay | Envelope Decay Time | 0-127, note (*) |
| ADSR Sustain | Envelope Sustain Level | 0-127 |
| ADSR Release | Envelope Release Time | 0-127, note (*) |
| Env Depth | Envelope Depth | -63- +63 |
| Env Time KF | Envelope Time Key Follow | -200- +200 |
| Pulse Width (ANALOG) | | |
| Pulse Width | | -63- +63 |
| PW KF | Pulse Width Key Follow | -200- +200 |
| PW LFO Depth | Pulse Width LFO Depth | -63- +63 |
| Velocity Curve | Envelope Velocity Curve | 0-7 |
| Velocity Sens | Envelope Velocity Sensitivity | -63- +63 |
| Velocity A-Sens | Envelope Attack Time Velocity Sensitivity | -63- +63 |
| Velocity D-Sens | Envelope Decay Time Velocity Sensitivity | -63- +63 |
| Velocity R-Sens | Envelope Release Time Velocity Sensitivity | -63- +63 |
| ADSR Attack | Envelope Attack Time | 0-127 |
| ADSR Decay | Envelope Decay Time | 0-127 |
| ADSR Sustain | Envelope Sustain Level | 0-127 |
| ADSR Release | Envelope Release Time | 0-127 |
| Env Depth | Envelope Depth | -63- +63 |
| Env Time KF | Envelope Time Key Follow | -200- +200 |

Parameter List

| Parameter | Value |
|----------------------|--|
| Fat (ANALOG) | |
| Fat | 0-127 |
| Fat KF | Fat Key Follow -200- +200 |
| Fat LFO Depth | -63- +63 |
| Velocity Curve | Envelope Velocity Curve 0-7 |
| Velocity Sens | Envelope Velocity Sensitivity -63- +63 |
| Velocity A-Sens | Envelope Attack Time Velocity Sensitivity -63- +63 |
| Velocity D-Sens | Envelope Decay Time Velocity Sensitivity -63- +63 |
| Velocity R-Sens | Envelope Release Time Velocity Sensitivity -63- +63 |
| ADSR Attack | Envelope Attack Time 0-127, note (*) |
| ADSR Decay | Envelope Decay Time 0-127, note (*) |
| ADSR Sustain | Envelope Sustain Level 0-127 |
| ADSR Release | Envelope Release Time 0-127, note (*) |
| Env Depth | Envelope Depth -63- +63 |
| Env Time KF | Envelope Time Key Follow -200- +200 |
| Time (PCM) | |
| Time | -63- +63 |
| Time KF | Time Key Follow -200- +200 |
| Time Offset | BWD, ZERO, FWD |
| Time LFO Depth | -63- +63 |
| Velocity Curve | Envelope Velocity Curve 0-7 |
| Velocity Sens | Envelope Velocity Sensitivity -63- +63 |
| Velocity A-Sens | Envelope Attack Time Velocity Sensitivity -63- +63 |
| Velocity D-Sens | Envelope Decay Time Velocity Sensitivity -63- +63 |
| Velocity R-Sens | Envelope Release Time Velocity Sensitivity -63- +63 |
| ADSR Attack | Envelope Attack Time 0-127, note (*) |
| ADSR Decay | Envelope Decay Time 0-127, note (*) |
| ADSR Sustain | Envelope Sustain Level 0-127 |
| ADSR Release | Envelope Release Time 0-127, note (*) |
| Env Depth | Envelope Depth -63- +63 |
| Env Time KF | Envelope Time Key Follow -200- +200 |
| Formant (PCM) | |
| Formant | -63- +63 |
| Formant KF | Formant Key Follow -200- +200 |
| Energy | OFF, 1-127 |
| Fmt LFO Depth | Formant LFO Depth -63- +63 |
| Velocity Curve | Envelope Velocity Curve 0-7 |
| Velocity Sens | Envelope Velocity Sensitivity -63- +63 |
| Velocity A-Sens | Envelope Attack Time Velocity Sensitivity -63- +63 |
| Velocity D-Sens | Envelope Decay Time Velocity Sensitivity -63- +63 |
| Velocity R-Sens | Envelope Release Time Velocity Sensitivity -63- +63 |
| ADSR Attack | Envelope Attack Time 0-127, note (*) |
| ADSR Decay | Envelope Decay Time 0-127, note (*) |
| ADSR Sustain | Envelope Sustain Level 0-127 |
| ADSR Release | Envelope Release Time 0-127, note (*) |
| Env Depth | Envelope Depth -63- +63 |
| Env Time KF | Envelope Time Key Follow -200- +200 |
| OSC TVA | |
| Level | 0-127 |
| Level KF | Level Key Follow -200- +200 |
| Level LFO Dp | Level LFO Depth -63- +63 |
| Velocity Curve | Envelope Velocity Curve 0-7 |
| Velocity Sens | Envelope Velocity Sensitivity -63- +63 |
| Velocity A-Sens | Envelope Attack Time Velocity Sensitivity -63- +63 |
| Velocity D-Sens | Envelope Decay Time Velocity Sensitivity -63- +63 |
| Velocity R-Sens | Envelope Release Time Velocity Sensitivity -63- +63 |
| ADSR Attack | Envelope Attack Time 0-127, note (*) |
| ADSR Decay | Envelope Decay Time 0-127, note (*) |
| ADSR Sustain | Envelope Sustain Level 0-127 |
| ADSR Release | Envelope Release Time 0-127, note (*) |
| Env Time KF | Envelope Time Key Follow -200- +200 |

| Parameter | | Value |
|------------|---------------------|---|
| LFO | | |
| Waveform | LFO Waveform | SINE, TRI, SAW, SQR, RND, TRP, S&H, CHAOS |
| Offset | LFO Offset | -100, -50, 0, +50, +100 |
| Key Sync | LFO Key Sync Switch | OFF, ON |
| Delay Time | LFO Delay Time | 0-127 |
| Rate | LFO Rate | 0-127, note (*) |
| Fade Mode | LFO Fade Mode | ON <<, ON >>, OFF <<, OFF >> |
| Fade Time | LFO Fade Time | 0-127 |

*

(Thirty-second note), (Sixteenth note), (Eighth-note triplet), (Dotted sixteenth note), (Eighth note), (Quarter-note triplet),
 (Dotted eighth note), (Quarter note), (Half-note triplet), (Dotted quarter note), (Half note), (Whole-note triplet),
 (Dotted half note), (Whole note), (Double-note triplet), (Dotted whole note), (Double note)

Mod Group (p. 93)

| Parameter | | Value |
|------------------|--------------------------|-----------------------------------|
| Modulator Switch | | OFF, ON |
| Mod Type | | |
| Modulator Type | | MIX, RING, FM, ENV RING, OSC SYNC |
| Original Level | Modulator Original Level | 0-127 |
| Attack | Modulator Attack Time | 0-127 |
| Release | Modulator Release Time | 0-127 |

COSM1/COSM2 Group (p. 93)

| Parameter | | Value |
|------------------|---------------------|---|
| COSM Switch | | OFF, ON |
| COSM Type | | |
| COSM Type | | THRU, OD/DS, W-SHAPE, AMP, SPEAKER, RESONATOR, SBF1, SBF2, COMB, DUAL, TVF, DYN-TVF, COMP, LIMITER, F-SHIFT, LO-FI, TB-FILTER |
| LFO | | |
| Waveform | LFO Waveform | SINE, TRI, SAW, SQR, RND, TRP, S&H, CHAOS |
| Offset | LFO Offset | -100, -50, 0, +50, +100 |
| Key Sync | LFO Key Sync Switch | OFF, ON |
| Delay Time | LFO Delay Time | 0-127 |
| Rate | LFO Rate | 0-127, note (*) |
| Fade Mode | LFO Fade Mode | ON <<, ON >>, OFF <<, OFF >> |
| Fade Time | LFO Fade Time | 0-127 |

*

(Thirty-second note), (Sixteenth note), (Eighth-note triplet), (Dotted sixteenth note), (Eighth note), (Quarter-note triplet),
 (Dotted eighth note), (Quarter note), (Half-note triplet), (Dotted quarter note), (Half note), (Whole-note triplet),
 (Dotted half note), (Whole note), (Double-note triplet), (Dotted whole note), (Double note)



For details on the parameters of each COSM section, refer to “**COSM Parameters**” (p. 159).

Parameter List

TVA Group (p. 94)

| Parameter | | Value |
|-----------------|--|---|
| TVA Switch | | OFF, ON |
| TVA | | |
| Level | | 0-127 |
| Level KF | Level Key Follow | -200- +200 |
| Lvl LFO Dp | Level LFO Depth | -63- +63 |
| Pan | | L64-0-63R |
| Pan KF | Pan Key Follow | -200- +200 |
| Pan LFO Dp | Pan LFO Depth | -63- +63 |
| Velocity Curve | Envelope Velocity Curve | 0-7 |
| Velocity Sens | Envelope Velocity Sensitivity | -63- +63 |
| Velocity A-Sens | Envelope Attack Time Velocity Sensitivity | -63- +63 |
| Velocity D-Sens | Envelope Decay Time Velocity Sensitivity | -63- +63 |
| Velocity R-Sens | Envelope Release Time Velocity Sensitivity | -63- +63 |
| ADSR Attack | Envelope Attack Time | 0-127, note (*) |
| ADSR Decay | Envelope Decay Time | 0-127, note (*) |
| ADSR Sustain | Envelope Sustain Level | 0-127 |
| ADSR Release | Envelope Release Time | 0-127, note (*) |
| Env Time KF | Envelope Time Key Follow | -200- +200 |
| LFO | | |
| Waveform | LFO Waveform | SINE, TRI, SAW, SQR, RND, TRP, S&H, CHAOS |
| Offset | LFO Offset | -100, -50, 0, +50, +100 |
| Key Sync | LFO Key Sync Switch | OFF, ON |
| Delay Time | LFO Delay Time | 0-127 |
| Rate | LFO Rate | 0-127, note (*) |
| Fade Mode | LFO Fade Mode | ON <<, ON >>, OFF <<, OFF >> |
| Fade Time | LFO Fade Time | 0-127 |

*

(Thirty-second note), (Sixteenth note), (Eighth-note triplet), (Dotted sixteenth note), (Eighth note), (Quarter-note triplet),
 (Dotted eighth note), (Quarter note), (Half-note triplet), (Dotted quarter note), (Half note), (Whole-note triplet),
 (Dotted half note), (Whole note), (Double-note triplet), (Dotted whole note), (Double note)

Effect Group (p. 97)

| Parameter | | Value |
|------------------|--------------------------|------------------|
| Routing | | |
| MFX Send | MFX Send Level | 0–127 |
| CHO Send | Chorus Send Level | 0–127 |
| REV Send | Reverb Send Level | 0–127 |
| Output Assign | | MULTI, MAIN, DIR |
| MFX | MFX On/Off Switch | OFF, ON |
| MFX Type | | 00 (Thru)–41 |
| MFX Master Level | | 0–127 |
| MFX To CHO | MFX Chorus Send Level | 0–127 |
| MFX To REV | MFX Reverb Send Level | 0–127 |
| CHO | Chorus On/Off Switch | OFF, ON |
| CHO Type | | 00 (Off)–08 |
| CHO Master Level | Chorus Master Level | 0–127 |
| CHO To REV | Chorus Reverb Send Level | 0–127 |
| REV | Reverb On/Off Switch | OFF, ON |
| REV Type | | 00 (Off)–10 |
| REV Master Level | Reverb Master Level | 0–127 |
| MFX | | |
| MFX Type | | 00 (Thru)–41 |
| CHO | | |
| CHO Type | Chorus Type | 00 (Off)–08 |
| REV | | |
| REV Type | Reverb Type | 00 (Off)–10 |



- For details on the parameters of each MFX section, refer to “**MFX Parameters**” (p. 164).
- For details on the parameters of each chorus section, refer to “**Chorus Parameters**” (p. 186).
- For details on the parameters of each reverb section, refer to “**Reverb Parameters**” (p. 186).

Parameter List

System Parameters

Common Group (p. 123)

| Parameter | | Value |
|----------------------------|---------------------------------|---|
| Master | | |
| Master Tune | | 415.3–466.2 Hz |
| Master Key Shift | | -24+ +24 |
| Master Level | | 0–127 |
| Patch Remain | Patch Remain Switch | OFF, ON |
| Powerup Mode | | Last Set, Default |
| IO | | |
| External Input Type | | STEREO L R, MONO MIX, MONO L, MONO R |
| External Input Source | | Analog (MIC/INPUT), USB Audio |
| Mix/Parallel | | MIX, PARALLEL |
| Output Gain | | -12+ +12 dB |
| Digital Output Freq | Digital Output Frequency | 44.1, 48, 96 KHz |
| EQ | | |
| 4 Band EQ | 4-Band Equalizer Switch | OFF, ON |
| LOW Freq | Low Frequency | 50, 63, 80, 100, 125, 160, 200, 250, 315, 400, 500, 630, 800, 1000, 1250, 1600, 2000, 2500, 3150, 4000 Hz |
| LOW Gain | | -15+ +15 dB |
| MID 1 Q | | 0.5, 0.7, 1.0, 2.0, 4.0, 8.0 |
| MID 1 Freq | Mid 1 Frequency | 50, 63, 80, 100, 125, 160, 200, 250, 315, 400, 500, 630, 800, 1000, 1250, 1600, 2000, 2500, 3150, 4000, 5000, 6300, 8000, 10000, 12500, 16000, 20000 Hz |
| MID 1 Gain | | -15+ +15 dB |
| MID 2 Q | | 0.5, 0.7, 1.0, 2.0, 4.0, 8.0 |
| MID 2 Freq | Mid 2 Frequency | 50, 63, 80, 100, 125, 160, 200, 250, 315, 400, 500, 630, 800, 1000, 1250, 1600, 2000, 2500, 3150, 4000, 5000, 6300, 8000, 10000, 12500, 16000, 20000 Hz |
| MID 2 Gain | | -15+ +15 dB |
| HIGH Freq | High Frequency | 2000, 4000, 5000, 6300, 8000, 10000, 12500, 16000, 20000 Hz |
| HIGH Gain | | -15+ +15 dB |
| TOTAL Gain | | -15+ +15 dB |
| MIDI/USB | | |
| Device ID | Device ID Number | 17–32 |
| Clock Source | | INTERNAL, EXTERNAL |
| Rx PC | Receive Program Change Switch | OFF, ON |
| Rx Bank | Receive Bank Select Switch | OFF, ON |
| Rx Sys-Ex | Receive System Exclusive Switch | OFF, ON |
| Tx Edit | Transmit Edit Data Switch | OFF, ON |
| Clock Out | | OFF, ON |
| USB–MIDI Thru Sw | USB–MIDI Through Switch | OFF, ON |
| Part MIDI | | |
| Part 1–16 Rx Sw | Part 1–16 Receive Switch | OFF, ON |
| Part 1–16 Rx Ch | Part 1–16 Receive Channel | 1–16 |
| Audio I/F | | |
| MIC Jack Switch | | OFF, ON |
| INPUT Jack Switch | | OFF, ON |
| INPUT Jack Gain | | 0db, -12db |
| USB Audio Output Dest | | OFF, MAIN, DIRECT |
| USB Audio Input Source | | OFF, MAIN, ANALOG |
| USB Audio Input Monitor Sw | | OFF, ON |

Controller Group (p. 127)

| Parameter | | Value |
|--------------------|--------------------------------|--|
| Tx | | |
| Patch Tx Ch | Patch Transmit Channel | 1–16, RX CH, OFF |
| Tx PC | Transmit Program Change Switch | OFF, ON |
| Tx Bank | Transmit Bank Select Switch | OFF, ON |
| Tx Active Sens | Transmit Active Sensing Switch | OFF, ON |
| KBD | | |
| Local Sw | Local Switch | OFF, ON |
| Panic Key | Panic Key | C2–C7 |
| TT Pad/ | | |
| X Assign-XY | | OFF, CC01–31, CC33–95 |
| Y Assign-XY | | OFF, CC01–31, CC33–95 |
| X Assign-TT | X Assign-Time Trip | OFF, CC01–31, CC33–95 |
| Y Assign-TT | Y Assign-Time Trip | OFF, CC01–31, CC33–95 |
| E1–E8 Knob | | |
| E1–E8 Assign | Knob E1–E8 Assign | OSC1-PRM1, OSC1-PRM2, OSC1-PRM3, OSC1-LFO1, OSC1-LFO2, OSC1-LFO3, OSC1-RATE, OSC1-LVL, OSC2-PRM1, OSC2-PRM2, OSC2-PRM3, OSC2-LFO1, OSC2-LFO2, OSC2-LFO3, OSC2-RATE, OSC2-LVL, CSM1-PRM1, CSM1-PRM2, CSM2-PRM1, CSM2-PRM2, TVA-ATK, TVA-DCY, TVA-SUS, TVA-REL |
| E1–E8 ExtCC | | |
| E1–E8 Assign | Knob E1–E8 Assign | OFF, CC01–31, CC33–95 |

Parameter List

V-LINK Group (p. 129)

| Parameter | | Value |
|-------------------|-----------------------------------|---|
| Tx | | |
| Channel | V-LINK MIDI Channel | 1-16 |
| Audio | V-LINK Audio Switch | OFF, ON |
| Local Sw | V-LINK Patch Palette Local Switch | OFF, ON |
| TT Pad | | |
| Local Sw | V-LINK Time Trip Pad Local Switch | OFF, ON |
| X Assign-XY | V-LINK X Assign-XY | OFF, PLAYBACK-SPEED, DISSOLVE-TIME, AUDIO-LEVEL, COLOR-CB, COLOR-CR, BRIGHTNESS, VFX1, VFX2, VFX3, VFX4, OUTPUT-FADE, T-BAR |
| Y Assign-XY | V-LINK X Assign-XY | OFF, PLAYBACK-SPEED, DISSOLVE-TIME, AUDIO-LEVEL, COLOR-CB, COLOR-CR, BRIGHTNESS, VFX1, VFX2, VFX3, VFX4, OUTPUT-FADE, T-BAR |
| Assign-TT | V-LINK Assign-Time Trip | OFF, TIME-TRIP |
| E1-E8 Knob | | |
| Local Sw | V-LINK Knob Local Switch | OFF, ON |
| E1-E8 Assign | V-LINK Knob E1-E8 Assign | OFF, PLAYBACK-SPEED, DISSOLVE-TIME, AUDIO-LEVEL, COLOR-CB, COLOR-CR, BRIGHTNESS, VFX1, VFX2, VFX3, VFX4, OUTPUT-FADE |

COSM List

COSM Parameters

COSM provides 16 types. This section explains the features of each COSM, and the functions of the parameters.



Explanations for each COSM Type are given on the following pages.

| | | |
|--------------------------|-----------|----------|
| Overdrive / Distortion | OD/DS | (p. 159) |
| Wave Shape | W-SHAPE | (p. 159) |
| Amp Simulator | AMP | (p. 160) |
| Speaker Simulator | SPEAKER | (p. 160) |
| Resonator | RESONATOR | (p. 160) |
| 1st order SideBandFilter | SBF1 | (p. 160) |
| 2nd order SideBandFilter | SBF2 | (p. 161) |
| Comb Filter | COMB | (p. 161) |
| Dual Filter | DUAL | (p. 161) |
| TVF | TVF | (p. 162) |
| Dynamic TVF | DYN-TVF | (p. 162) |
| Polyphonic Compressor | COMP | (p. 162) |
| Polyphonic Limiter | LIMITER | (p. 162) |
| Frequency Shifter | F-SHIFT | (p. 163) |
| Lo-Fi Processor | LO-FI | (p. 163) |
| TB Filter | TB Filter | (p. 163) |



Parameters marked by "#1"–"#4" can be selected as a destination parameter for matrix control (Destination). These correspond as follows.

- #1: Destination CSM1/2-PRM1
- #2: Destination CSM1/2-PRM2
- #3: Destination CSM1/2-LFO-PRM1
- #4: Destination CSM1/2-LFO-PRM2



Overdrive / Distortion

Overdrive produces a natural-sounding distortion similar to that produced by a vacuum tube amplifier. Distortion produces a more intense distortion than the overdrive effect.

| Parameter | Value | Description |
|---|------------|---|
| COSM Type | | |
| Drive Type | OD, DS | Selects whether to use overdrive (OD) or distortion (DS). |
| Output Level | 0–127 | Output Level |
| Drive | | |
| Drive #1 | 0–127 | Degree of distortion |
| Drive LFO Depth #3 | -63– +63 | Amount of LFO applied to distortion |
| * For details on envelope settings, refer to "Making Envelope Settings" (p. 95). | | |
| Tone | | |
| Tone #2 | 0–127 | Tonal character |
| Tone KF | -200– +200 | Key follow setting for tone |
| Tone LFO Depth #4 | -63– +63 | Amount of LFO applied to tone |
| * For details on envelope settings, refer to "Making Envelope Settings" (p. 95). | | |
| LFO | | |
| * For details on LFO settings, refer to "Making LFO Settings" (p. 96). | | |



Wave Shape

You can use a variety of waveforms to create and distort the sound.

| Parameter | Value | Description |
|---|------------|-------------------------------------|
| COSM Type | | |
| Shape Type | 1–6 | Type of waveform |
| Output Level | 0–127 | Output Level |
| Drive | | |
| Drive #1 | 0–127 | Degree of distortion |
| Drive LFO Depth #3 | -63– +63 | Amount of LFO applied to distortion |
| * For details on envelope settings, refer to "Making Envelope Settings" (p. 95). | | |
| Tone | | |
| Tone #2 | 0–127 | Tonal character |
| Tone KF | -200– +200 | Key follow setting for tone |
| Tone LFO Depth #4 | -63– +63 | Amount of LFO applied to tone |
| * For details on envelope settings, refer to "Making Envelope Settings" (p. 95). | | |
| LFO | | |
| * For details on LFO settings, refer to "Making LFO Settings" (p. 96). | | |



Amp Simulator

Simulates an amp.

| Parameter | Value | Description |
|---|----------|-------------------------------------|
| COSM Type | | |
| Amp Type | 1-3 | Type of guitar amp |
| Bass | 0-127 | Tone of the bass/mid/treble range |
| Middle | | |
| Treble | | |
| Output Level | 0-127 | Output Level |
| Gain | | |
| Gain #1 | 0-127 | Degree of distortion |
| Gain LFO Depth #3 | -63- +63 | Amount of LFO applied to distortion |
| * For details on envelope settings, refer to "Making Envelope Settings" (p. 95). | | |
| LFO | | |
| * For details on LFO settings, refer to "Making LFO Settings" (p. 96). | | |



Speaker Simulator

Simulates the speaker type.

| Parameter | Value | Description |
|------------------|-------|-------------|
| COSM Type | | |
| Speaker Type | 1-12 | |



Resonator

Simulates the resonance of a guitar body.

| Parameter | Value | Description |
|---|-----------------------|--|
| COSM Type | | |
| Filter Type | BANJO, AC.GTR, RE.GTR | Type of filter (guitar) |
| Size | | |
| Size #1 | 0-127 | Body size |
| Size KF | -200- +200 | Key follow setting for guitar body |
| Size LFO Depth #3 | -63- +63 | Amount of LFO applied to guitar body |
| * For details on envelope settings, refer to "Making Envelope Settings" (p. 95). | | |
| Balance | | |
| Balance #2 | 0-127 | Volume balance between the direct sound and the effect sound |
| Balance LFO Depth #4 | -63- +63 | Amount of LFO applied to the volume balance |
| * For details on envelope settings, refer to "Making Envelope Settings" (p. 95). | | |
| LFO | | |
| * For details on LFO settings, refer to "Making LFO Settings" (p. 96). | | |



1st order SideBandFilter

By boosting the fundamental and overtones, you can apply a pitch to unpitched input sounds such as a noise or a drum phrase.

| Parameter | Value | Description |
|---|------------|--|
| COSM Type | | |
| HPF | 0-127 | Cutoff frequency of the high pass filter |
| LPF | 0-127 | Cutoff frequency of the low pass filter |
| LPF KF | -200- +200 | Key follow setting for cutoff frequency of low-pass filter |
| Sub | -100- +100 | Sub detune |
| Octave | -2, -1, 0 | Octave setting |
| Width | | |
| Width #1 | 0-127 | Bandwidth |
| Width KF | -200- +200 | Key follow setting for bandwidth |
| Dyn Env | -63- +63 | Envelope depth for the input sound |
| Width LFO Depth #3 | -63- +63 | Amount of LFO applied to bandwidth |
| * For details on envelope settings, refer to "Making Envelope Settings" (p. 95). | | |
| Detune | | |
| Detune #2 | 0-127 | Detune |
| Dyn Env | -63- +63 | Envelope depth for the input sound |
| Detune LFO Depth #4 | -63- +63 | Amount of LFO applied to detune |
| * For details on envelope settings, refer to "Making Envelope Settings" (p. 95). | | |
| LFO | | |
| * For details on LFO settings, refer to "Making LFO Settings" (p. 96). | | |



2nd order SideBandFilter

By boosting the fundamental and overtones, you can apply a pitch to unpitched input sounds such as noise or a drum phrase. This lets you create a stronger effect than the first-order sideband filter.

| Parameter | Value | Description |
|---|------------|---|
| COSM Type | | |
| Q | 0–127 | Frequency bandwidth |
| LPF | 0–127 | Cutoff frequency of the low pass filter |
| LPF KF | -200– +200 | Key follow setting for cut-off frequency of low-pass filter |
| Octave | -2, -1, 0 | Octave setting |
| Width | | |
| Width #1 | 0–127 | Bandwidth |
| Width KF | -200– +200 | Key follow setting for bandwidth |
| Dyn Env | -63– +63 | Envelope depth for the input sound |
| Width LFO Depth #3 | -63– +63 | Amount of LFO applied to bandwidth |
| * For details on envelope settings, refer to “ Making Envelope Settings ” (p. 95). | | |
| Detune | | |
| Detune #2 | 0–127 | Detune |
| Dyn Env | -63– +63 | Envelope depth for the input sound |
| Detune LFO Depth #4 | -63– +63 | Amount of LFO applied to detune |
| * For details on envelope settings, refer to “ Making Envelope Settings ” (p. 95). | | |
| LFO | | |
| * For details on LFO settings, refer to “ Making LFO Settings ” (p. 96). | | |



Comb Filter

A comb filter can be used to boost or cut the fundamental or overtones.

| Parameter | Value | Description |
|---|-------------------|---------------------------------|
| COSM Type | | |
| Octave | -2, -1, 0, +1, +2 | Octave setting |
| Tone | | |
| Tone #1 | 0–127 | Tonal character |
| Tone LFO Depth #3 | -63– +63 | Amount of LFO applied to tone |
| * For details on envelope settings, refer to “ Making Envelope Settings ” (p. 95). | | |
| Detune | | |
| Detune #2 | 0–127 | Detune |
| Detune LFO Depth #4 | -63– +63 | Amount of LFO applied to detune |
| * For details on envelope settings, refer to “ Making Envelope Settings ” (p. 95). | | |
| LFO | | |
| * For details on LFO settings, refer to “ Making LFO Settings ” (p. 96). | | |



Dual Filter

Two filters can be connected in series or parallel.

| Parameter | Value | Description |
|---|----------------------------|--|
| COSM Type | | |
| Filter Type | LPF/HPF, LPF->HPF, BPF/BPF | Type of filter |
| Filter1/2 | | |
| Freq #1/#2 | 0–127 | Cutoff frequency of the filter |
| Freq KF | -200– +200 | Key follow setting for filter cutoff frequency |
| Reso | 0–127 | Resonance |
| Freq LFO Depth #3/#4 | -63– +63 | Amount of LFO applied to filter cutoff frequency |
| * For details on envelope settings, refer to “ Making Envelope Settings ” (p. 95). | | |
| LFO | | |
| * For details on LFO settings, refer to “ Making LFO Settings ” (p. 96). | | |



TVF

Cuts off a specific frequency band to change a sounds brightness, thickness, and other qualities.

| Parameter | Value | Description |
|---|--------------------------------|--|
| COSM Type | | |
| Filter Type | LPF, BPF, HPF, NOTCH, PEAK | Type of filter |
| db/Octave | -24dB/oct, -12dB/oct, -6dB/oct | Amount of attenuation per octave |
| Cutoff | | |
| Freq #1 | 0-127 | Cutoff frequency of the filter |
| Freq KF | -200- +200 | Key follow setting for filter cutoff frequency |
| LFO Dp #3 | -63- +63 | Amount of LFO applied to filter cutoff frequency |
| * For details on envelope settings, refer to “Making Envelope Settings” (p. 95). | | |
| Resonance | | |
| Reso #2 | 0-127 | Resonance |
| R LFO Depth #4 | -63- +63 | Amount of LFO applied to resonance |
| * For details on envelope settings, refer to “Making Envelope Settings” (p. 95). | | |
| LFO | | |
| * For details on LFO settings, refer to “Making LFO Settings” (p. 96). | | |



Dynamic TVF

Cuts off a specific frequency band to change a sounds brightness, thickness, and other qualities. A wah effect can be applied by using the volume of the input sound to vary the center frequency.

| Parameter | Value | Description |
|---|--------------------------------|--|
| COSM Type | | |
| Filter Type | LPF, BPF, HPF, NOTCH, PEAK | Type of filter |
| db/Octave | -24dB/oct, -12dB/oct, -6dB/oct | Amount of attenuation per octave |
| Cutoff | | |
| Freq #1 | 0-127 | Cutoff frequency of the filter |
| Freq KF | -200- +200 | Key follow setting for filter cutoff frequency |
| Dyn | -63- +63 | Envelope depth for the input sound |
| LFO Dp #4 | -63- +63 | Amount of LFO applied to filter cutoff frequency |
| * For details on envelope settings, refer to “Making Envelope Settings” (p. 95). | | |
| Resonance | | |
| Reso #2 | 0-127 | Resonance |
| Dyn Env | -63- +63 | Envelope depth for the input sound |
| R LFO Dp #4 | -63- +63 | Amount of LFO applied to resonance |
| * For details on envelope settings, refer to “Making Envelope Settings” (p. 95). | | |
| LFO | | |
| * For details on LFO settings, refer to “Making LFO Settings” (p. 96). | | |



Polyphonic Compressor

Flattens out high levels and boosts low levels, smoothing out unevenness in volume.

| Parameter | Value | Description |
|------------------|-------|---------------|
| COSM Type | | |
| Attack #1 | 0-127 | Attack time |
| Sustain #2 | 0-127 | Sustain level |
| Output Level | 0-127 | Output Level |



Polyphonic Limiter

Compresses signals that exceed a specified volume level, preventing distortion from occurring.

| Parameter | Value | Description |
|------------------|-----------------------|--|
| COSM Type | | |
| Thres | 0-127 | Sets the volume level at which the compression begins. |
| Ratio | 2:1, 4:1, 16:1, 100:1 | Compression ratio |
| Attack #1 | 0-127 | Attack time |
| Release #2 | 0-127 | Release time |
| Output | 0-127 | Output Level |



Frequency Shifter

By shifting the frequency relationship of the fundamental and overtones, a human voice can be given a “groaning” character.

| Parameter | Value | Description |
|---|------------|--|
| Effect | | |
| Effect #1 | 0–127 | Effect depth |
| Effect KF | -200– +200 | Key follow setting for the effect volume |
| Effect LFO Depth #3 | -63– +63 | Amount of LFO applied to the effect volume |
| * For details on envelope settings, refer to “ Making Envelope Settings ” (p. 95). | | |
| Balance | | |
| Balance #2 | 0–127 | Volume balance between the direct sound and the effect sound |
| Balance LFO Depth | -63– +63 | Amount of LFO applied to the volume balance |
| * For details on envelope settings, refer to “ Making Envelope Settings ” (p. 95). | | |
| LFO | | |
| * For details on LFO settings, refer to “ Making LFO Settings ” (p. 96). | | |



Lo-Fi Processor

By changing the bit count and sample rate, this effect recreates the Lo-Fi (Low-Fidelity) sounds of the early digital samplers and similar machines. After the Lo-Fi processor, a filter to change the tone is arranged in series.

| Parameter | Value | Description |
|---|-----------------------------------|--|
| COSM Type | | |
| Bit Down | 0–15 | This setting is for reducing the bit count. |
| Sample Rate Down | Normal, 1/2, 1/4, 1/8, 1/16, 1/32 | Sets the fraction of current sampling rates to be used for processing. |
| Filter | | |
| Filter #1 | 0–127 | Cutoff frequency of the filter |
| Filter KF | -200– +200 | Key follow setting for filter cutoff frequency |
| Filter LFO Depth #3 | -63– +63 | Amount of LFO applied to filter cutoff frequency |
| * For details on envelope settings, refer to “ Making Envelope Settings ” (p. 95). | | |
| Balance | | |
| Balance #2 | 0–127 | Volume balance between the direct sound and the effect sound |
| Balance LFO Depth | -63– +63 | Amount of LFO applied to the volume balance |
| LFO | | |
| * For details on LFO settings, refer to “ Making LFO Settings ” (p. 96). | | |



TB Filter

This filter simulates the circuitry of the Roland TB-303. If Reso Follow is set to a value other than “0,” the resonance will change according to the LFO cutoff frequency.

| Parameter | Value | Description |
|---|-----------|---|
| COSM Type | | |
| Gain | 0–127 | Output Level |
| LPF | | |
| Freq #1 | 0–127 | Cutoff frequency of the low pass filter |
| Freq KF | -200–+200 | Key follow setting for low pass filter cutoff frequency |
| Freq LFO Depth | -63–+63 | Amount of LFO applied to low pass filter cutoff frequency |
| Reso #2 | 0–127 | Resonance of the low pass filter |
| Reso Follow | -63–+63 | Amount of resonance applied to low pass filter cutoff frequency |
| HPF | | |
| Freq | 0–127 | Cutoff frequency of the high pass filter |
| Freq KF | -200–+200 | Key follow setting for high pass filter cutoff frequency |
| Freq LFO Depth | -63–+63 | Amount of LFO applied to high pass filter cutoff frequency |
| * For details on envelope settings, refer to “ Making Envelope Settings ” (p. 95). | | |

You can control the “#1” and “#2” parameters using the PATCH PLAY screen COSM1/COSM2 knobs and the matrix control Destination parameters “CSM1/2-PRM1” and “CSM1/2-PRM2.”

Effects List

MFX Parameters

MFX (Multi-Effects) provides 41 types of effect. This section explains the features of each MFX, and the functions of the parameters.

MEMO

Parameters marked by "#1"–"#3" can be selected as a destination parameter for matrix control (Destination MFX1–MFX3). These correspond as follows.

#1: Destination MFX1

#2: Destination MFX2

#3: Destination MFX3



Explanations for each MFX Type are given on the following pages.

| | | |
|--------------------------|-----------|----------|
| 01: Parametric EQ | Para EQ | (p. 165) |
| 02: Graphic EQ | Graph EQ | (p. 165) |
| 03: Resonant Filter | ResoFilt | (p. 165) |
| 04: Isolator and Filter | Isolator | (p. 166) |
| 05: Distortion / OD | DS / OD | (p. 166) |
| 06: Amp Simulator | Gtr Amp | (p. 167) |
| 07: Auto Wah | Auto Wah | (p. 168) |
| 08: Humanizer | Humanizer | (p. 168) |
| 09: Dynamic Processor | Dynamic | (p. 169) |
| 10: Tape Echo Simulator | TapeEcho | (p. 169) |
| 11: Stereo Delay | St Delay | (p. 170) |
| 12: Multi Tap Delay | TapDelay | (p. 171) |
| 13: Reverse Delay | RvsDelay | (p. 171) |
| 14: Vocal Echo | VocalEcho | (p. 172) |
| 15: Band Pass Delay | BP Delay | (p. 172) |
| 16: Analog Delay→Chorus | AD->Cho | (p. 173) |
| 17: Digital Chorus | DigiCho | (p. 173) |
| 18: Space Chorus | SpaceCho | (p. 174) |
| 19: Hexa Chorus | Hex Cho | (p. 174) |
| 20: Analog Flanger | Ana Flgr | (p. 174) |
| 21: BOSS Flanger | BOSSFlgr | (p. 175) |
| 22: Step Flanger | StepFlgr | (p. 175) |
| 23: Analog Phaser | Ana Phsr | (p. 176) |
| 24: Digital Phaser | DigiPhsr | (p. 176) |
| 25: Rotary | Rotary | (p. 177) |
| 26: Tremolo/Auto Pan | Trem/Pan | (p. 177) |
| 27: Stereo Pitch Shifter | PitchSft | (p. 178) |
| 28: OD/DS→Cho/Flg | OD->Cho | (p. 178) |
| 29: OD/DS→Delay | OD->Dly | (p. 179) |
| 30: Cho/Flg→Delay | Cho->Dly | (p. 179) |
| 31: Enh→Cho/Flg | Enh->Cho | (p. 180) |
| 32: Enh→Delay | Enh->Dly | (p. 180) |
| 33: Vocal Multi | VocalMt | (p. 181) |
| 34: Guitar Multi | GuitarMt | (p. 181) |
| 35: Bass Multi | BASS Mt | (p. 182) |
| 36: EP Multi | EP Mt | (p. 183) |
| 37: Keyboard Multi | Kbd Mt | (p. 183) |
| 38: Phonograph | Phonogrp | (p. 184) |
| 39: Radio Tuning | Radio | (p. 185) |
| 40: Bit Rate Converter | Bit Conv | (p. 185) |
| 41: Pseudo Stereo | PseudoSt | (p. 185) |

01: Parametric EQ (Parametric Equalizer)

This is a 4 band (low range, midrange x 2, high range) stereo parametric equalizer.

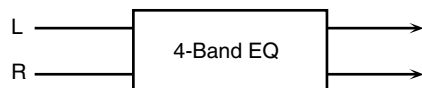

| Parameter | Value | Description |
|------------|------------------------------|---|
| Low Freq | 50–4000 Hz | Frequency of the low range |
| Low Gain | -15– +15 dB | Gain of the low range |
| Mid 1 Freq | 50–20000 Hz | Frequency of the middle range 1 |
| Mid 1 Q | 0.5, 0.7, 1.0, 2.0, 4.0, 8.0 | Width of the middle range 1 Set a higher value for Q to narrow the range to be affected. |
| Mid 1 Gain | -15– +15 dB | Gain of the middle range 1 |
| Mid 2 Freq | 50–20000 Hz | Frequency of the middle range 2 |
| Mid 2 Q | 0.5, 0.7, 1.0, 2.0, 4.0, 8.0 | Width of the middle range 2 Set a higher value for Q to narrow the range to be affected. |
| Mid 2 Gain | -15– +15 dB | Gain of the middle range 2 |
| Hi Freq | 2000–20000 Hz | Frequency of the high range |
| Hi Gain | -15– +15 dB | Gain of the high range |
| Total Gain | -15– +15 dB | Output Level |

02: Graphic EQ (Graphic Equalizer)

This simulates a 12-band stereo graphic equalizer.

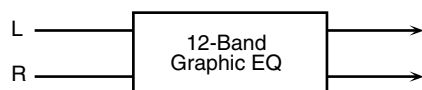

| Parameter | Value | Description |
|---------------|-------------|-----------------------------|
| 180Hz Gain | -15– +15 dB | Gain of each frequency band |
| 250Hz Gain | | |
| 355Hz Gain | | |
| 500Hz Gain | | |
| 710Hz Gain | | |
| 1000Hz Gain | | |
| 1400Hz Gain | | |
| 2000Hz Gain | | |
| 2800Hz Gain | | |
| 4000Hz Gain | | |
| 5600Hz Gain | | |
| 8000Hz Gain | -15– +15 dB | Output Level |
| Total Gain #1 | | |

03: Resonant Filter

It allows for cyclical control of the cutoff frequency using an LFO. It allows you to make drastic changes in the frequency response of the input signal by the cutoff frequency and feedback, making the sound brighter or darker, or giving it a distinctive character.

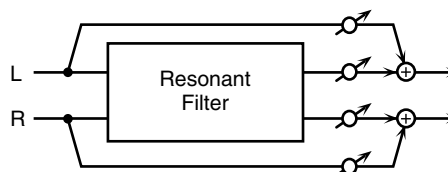

| Parameter | Value | Description |
|----------------|--|---|
| Cutoff Freq | 50–20000 Hz | Basic frequency of the filter The LFO will control the cutoff frequency with this value as its maximum level. |
| Resonance | 0–127 | Filter's resonance level Raising the setting increases resonance near the cutoff frequency, producing a uniquely characteristic sound. |
| Band Mode | LOW, MID, HIGH, LOW+MID, MID+HIGH, ALL | Frequency range to which the filter will be applied LOW: low frequency band MID: mid-range frequency HIGH: high frequency LOW+MID: low and middle range frequency MID+HIGH: middle and high range frequency ALL: all ranges |
| Sweep Waveform | TRI, SAWUP, SAWDN, SQR | LFO waveform TRI: Triangle wave SAWUP: Sawtooth Wave SAWDN: Sawtooth Wave SQR: Square wave |
| | | |
| Sweep Rate | 0.05–10.0 Hz, note | Frequency of the LFO modulation |
| Sweep Depth | 0–127 | Modulation depth of the LFO |
| Balance | DRY100:0WET–DRY0:100WET | Volume balance between the direct sound (DRY) and the effect sound (WET) |

04: Isolator and Filter

A 3-band isolator, filter, and low booster are connected in stereo in series.

Isolator is an equalizer which cuts the volume greatly, allowing you to add a special effect to the sound by cutting the volume in varying ranges.

The filters allow you to modify the frequency response of the input sound widely and give sound a character.

The low booster emphasizes the bottom to create a heavy bass sound.



| Parameter | Value | Description |
|-------------------|----------------------------|--|
| Low Band Level #1 | -60- +4 dB | These specify each level of the Low, Mid, and High frequency ranges. At -60 dB, the sound becomes inaudible. 0 dB is equivalent to the input level of the sound. |
| Mid Band Level #2 | | |
| Hi Band Level #3 | | |
| AP Low Sw | OFF, ON | Turns the Anti-Phase function on and off for the Low frequency ranges. When turned on, the counter-channel of stereo sound is inverted and added to the signal. |
| AP Low Level | 0-127 | Adjusts the level settings for the Low frequency ranges. Adjusting this level for certain frequencies allows you to lend emphasis to specific parts. (This is effective only for stereo source.) |
| AP Mid Sw | OFF, ON | Settings of the Anti-Phase function for the Middle frequency ranges The parameters are the same as for the Low frequency ranges. |
| AP Mid Level | 0-127 | |
| Filter Type | THRU, LPF, BPF, HPF, NOTCH | Type of filter THRU: no filter is used LPF: Passes frequencies below the Cutoff. BPF: Passes frequencies near the Cutoff. HPF: Passes frequencies above the Cutoff. NOTCH: Passes frequencies other than those near the Cutoff. |
| | | |

| Parameter | Value | Description |
|------------------|---------------|--|
| Filter Slope | -12, -24 dB/O | Filter's attenuation slope -24 dB per octave: steep -12 dB per octave: gentle |
| Filter Cutoff | 0-127 | Cutoff frequency of the filter The closer to zero it is set, the lower the cutoff frequency becomes; set it closer to 127, and the cutoff frequency becomes higher. |
| Filter Resonance | 0-127 | Resonance level of the filter Raising the setting increases resonance near the cutoff frequency, giving the sound a special characteristic. |
| Filter Gain | 0- +24 dB | Compensates for the volume dropped in the cut frequency range with some filters. The level of compensation increases as the value is increased, and raise the volume. |
| LowBoost Level | -15- +15 dB | Increasing this value gives you a heavier low end. <i>* Depending on the Isolator and filter settings this effect may be hard to distinguish.</i> |

05: Distortion / OD (Distortion / Overdrive)

Overdrive produces a natural-sounding distortion similar to that produced by a vacuum tube amplifier. Distortion produces a more intense distortion than the overdrive effect.

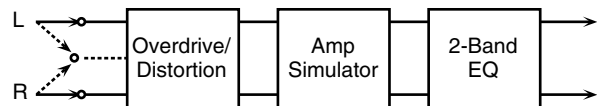

| Parameter | Value | Description |
|--------------|-----------------------------------|--|
| Input Mode | MONO, STEREO | Selects whether to input in stereo or in monaural. If MONO is selected, the left and right sound will be mixed, and input as monaural. |
| Drive Mode | OD, DS | Selects whether to use overdrive (OD) or distortion (DS). |
| Drive #1 | 0-127 | Degree of distortion |
| Amp Sim Sw | OFF, ON | Turns the Amp Simulator on/off. |
| Amp Type | SMALL, BUILT-IN, 2-STACK, 3-STACK | Type of guitar amp SMALL: small amp BUILT-IN: single-unit type amp 2-STACK: large double stack amp 3-STACK: large triple stack amp |
| Output Level | 0-127 | Output Level |
| Ps Low Freq | 50-4000 Hz | Frequency of the low range |
| Ps Low Gain | -15- +15 dB | Gain of the low range |
| Ps Hi Freq | 2000-20000 Hz | Frequency of the high range |
| Ps Hi Gain | -15- +15 dB | Gain of the high range |

06: Amp Simulator (Guitar Amp Simulator)

This is an effect that simulates an guitar amp.

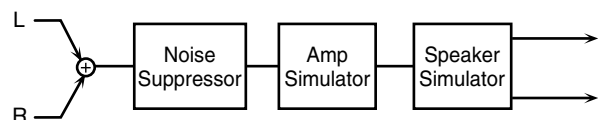

| Parameter | Value | Description |
|--------------|--|--|
| NS Sw | OFF, ON | Turns the noise suppressor on/off. The noise suppressor leaves the original sound unmodified, but mutes only the noise during the silent intervals. |
| NS Threshold | 0-127 | Adjusts the level at which the noise suppressor will begin to take effect. <i>* When the signal drops below the specified level, it will be muted.</i> |
| NS Release | 0-127 | Sets the transition time from when the noise suppression starts to the point where the volume reaches 0. |
| Amp Type | JC-120, CLEAN TWIN, MATCH DRIVE, BG LEAD, MS1959I, MS1959II, MS1959I+II, SLDN LEAD, METAL 5150, METAL LEAD, OD-1, OD-2 TURBO, DISTORTION, FUZZ | Type of guitar amp |
| | | JC-120: The sound of a Roland JC-120. CLEAN TWIN: The sound of a standard built-in type vacuum tube amp. MATCH DRIVE: The sound of a recent vacuum tube amp widely used in blues, rock, and fusion. BG LEAD: The sound of a vacuum tube amp representative of the late 70's and the 80's. MS1959 I: The sound of the large vacuum tube amp stack that was indispensable to the British hard rock of the 70's, with input I connected. MS1959 II: The same amp as MS1959 I, but with input II connected. MS1959 I+II: The same amp as MS1959 I, but with inputs I and II connected in parallel. SLDN LEAD: The sound of a vacuum tube amp usable in a wide variety of styles. METAL 5150: The sound of a large vacuum tube amp suitable for heavy metal. METAL LEAD: A metal lead sound with a distinctive mid-range. OD-1: The sound of the BOSS OD-1 compact effects processor. OD-2 TURBO: The sound of the BOSS OD-2 compact effects processor with the Turbo switch on. DISTORTION: Distortion sound. FUZZ: Fuzz sound. |

| Parameter | Value | Description |
|---------------|----------------|---|
| Volume | 0-127 | Volume and degree of distortion of the amp |
| Bass | 0-127 | Tone of the bass/mid/treble range <i>* Middle cannot be set if MATCH DRIVE is selected for the Amp Type.</i> |
| Middle | | |
| Treble | | |
| Presence | 0-127 | Tone for the ultra high frequency range |
| Master Volume | 0-127 | Volume of the entire amp |
| Brightness Sw | OFF, ON | Turning this On will produce a sharper and brighter sound. <i>* This parameter can be set if the Amp Type is set to JC-120, CLEAN TWIN, or BG LEAD.</i> |
| Gain Sw | LOW, MID, HIGH | Degree of amp distortion |
| Sp Sim Sw | OFF, ON | Turns the Speaker Simulator on/off. |
| Sp Type | (see below) | Type of speaker |
| Mic Setting | 1-10 | Adjusts the location of the mic that is recording the sound of the speaker. Increasing this value will produce the effect of the mic being further away from the center of the speaker cone. |
| Mic Level | 0-127 | Volume of the microphone |
| Direct Level | 0-127 | Volume of the direct sound |
| Level | 0-127 | Output Level |

Specifications of each Speaker Type

The speaker column indicates the diameter of each speaker unit (in inches) and the number of units.

| Type | Cabinet | Speaker | Microphone |
|-------------|---------------------------|---------|------------|
| SMALL | small open-back enclosure | 10 | dynamic |
| MIDDLE | open back enclosure | 12 x 1 | dynamic |
| JC-120 | open back enclosure | 12 x 2 | dynamic |
| BUILT IN 1 | open back enclosure | 12 x 2 | dynamic |
| BUILT IN 2 | open back enclosure | 12 x 2 | condenser |
| BUILT IN 3 | open back enclosure | 12 x 2 | condenser |
| BUILT IN 4 | open back enclosure | 12 x 2 | condenser |
| BUILT IN 5 | open back enclosure | 12 x 2 | condenser |
| BG STACK 1 | sealed enclosure | 12 x 2 | condenser |
| BG STACK 2 | large sealed enclosure | 12 x 2 | condenser |
| MS STACK 1 | large sealed enclosure | 12 x 4 | condenser |
| MS STACK 2 | large sealed enclosure | 12 x 4 | condenser |
| METAL STACK | large double stack | 12 x 4 | condenser |

Recommended combination of pre-amp and speaker

| Amp type | Speaker type |
|-------------|--------------------------------|
| BG LEAD | BG STACK 1, BG STACK 2, MIDDLE |
| MS1959 II | BG STACK 1-2, METAL STACK |
| MS1959 I+II | BG STACK 1-2, METAL STACK |
| SLDN LEAD | BG STACK 1-2, METAL STACK |
| METAL 5150 | BG STACK 1-2, METAL STACK |
| METAL LEAD | BG STACK 1-2, METAL STACK |
| OD-2 TURBO | BUILT IN 1-4 |
| DISTORTION | BUILT IN 1-4 |
| FUZZ | BUILT IN 1-4 |

07: Auto Wah

Wah is an effect that modifies the frequency characteristics of a filter over time, producing a unique tone. The wah effect can change in relation to the volume of the input signal, and/or cyclically.

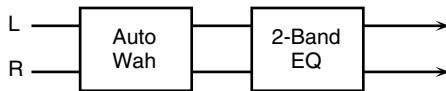

| Parameter | Value | Description |
|-----------------|--------------------|--|
| Filter Type | LPF, BPF | Type of filter LPF: The wah effect will be applied over a wide frequency range. BPF: The wah effect will be applied over a narrow frequency range |
| Polarity | DOWN, UP | When using the volume of the input signal to control the wah effect, this setting determines whether the frequency of the filter will be moved upward (UP) or downward (DOWN). |
| Frequency #1 | 0–127 | Adjusts the frequency at which the wah effect will apply. |
| Peak | 0–127 | Adjusts the amount of the wah effect that will occur in the range of the center frequency. Set a higher value for Q to narrow the range to be affected. |
| Trigger Sens #2 | 0–127 | Adjusts the sensitivity with which the wah effect is controlled. |
| Rate | 0.05–10.0 Hz, note | Frequency of modulation |
| Depth | 0–127 | Depth of modulation |
| Ps Low Freq | 50–4000 Hz | Frequency of the low range |
| Ps Low Gain | -15– +15 dB | Gain of the low range |
| Ps Hi Freq | 2000–20000 Hz | Frequency of the high range |
| Ps Hi Gain | -15– +15 dB | Gain of the high range |

08: Humanizer

This adds a vowel character to the sound, making it similar to a human voice.

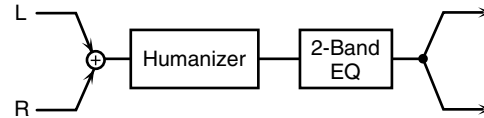

| Parameter | Value | Description |
|-----------------|--------------------|---|
| Overdrive Sw | OFF, ON | Turns Drive on/off. |
| Drive | 0–127 | Degree of distortion |
| Vowel 1 | a, e, i, o, u | First vowel |
| Vowel 2 | a, e, i, o, u | Second vowel |
| Rate #1 | 0.05–10.0 Hz, note | Frequency at which the two vowels will be switched |
| Depth | 0–127 | Effect depth With a setting of 0, it will be fixed at Vowel 1. |
| Trigger Sens #2 | -60–0 dB, LFO | Level at which the two vowels will be switched -60–0 dB: When the specified level is exceeded, the sound will change to the other vowel at the frequency (speed) specified by Rate. LFO: The two vowel sounds will alternate at the frequency specified by Rate, regardless of the level. |
| Ps Low Freq | 50–4000 Hz | Frequency of the low range |
| Ps Low Gain | -15– +15 dB | Gain of the low range |
| Ps Hi Freq | 2000–20000 Hz | Frequency of the high range |
| Ps Hi Gain | -15– +15 dB | Gain of the high range |

09: Dynamic Processor (Stereo Dynamic Processor)

A comp/limiter, enhancer, 3-band equalizer, and noise suppressor are connected in series.

Comp/Limiter is able to use as a compressor, which controls inconsistencies in sound levels by suppressing high sound levels while lifting weaker signals, or as a limiter that prevents the signal from reaching exceedingly high levels.

Enhancer regulates the high-end overtones, clarifying the sound and the sound contour.

3-Band Equalizer works in three frequency ranges: Low, Mid, and High. You can set the frequencies and boost or cut the level.

Noise Suppressor leaves the original sound unmodified, but mutes only the noise during the silent intervals.

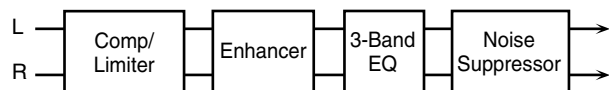

| Parameter | Value | Description |
|-------------------|------------------------------|---|
| Comp Sw | OFF, ON | Turns the comp/limiter on/off. |
| Comp Threshold #1 | -60–0 dB | Sets the volume level at which the compression begins. |
| Comp Attack | 0–127 | Sets the time after the sound volume is crossed the compressor threshold until compression begins. |
| Comp Release | 0–127 | Specifies the time from when the volume drops below the compressor threshold until compression is no longer applied. |
| Comp Ratio | 1.5:1, 2:1, 4:1, 100:1 | Sets the “source sound:output sound” compression ratio. |
| Comp Gain | -60– +12 dB | Output gain |
| Enhan Sw | OFF, ON | Turns the enhancer on/off. |
| Enhan Sens | 0–127 | Sensitivity of the enhancer |
| Enhan Frequency | 0–127 | Sets the lower limit of the frequencies to which the enhancement effect is added. |
| Enhan Mix Level | 0–127 | Level of the overtones generated by the enhancer |
| Enhan Level | 0–127 | Volume of the enhancer sound |
| EQ Low Freq | 50–4000 Hz | Frequency of the low range |
| EQ Low Gain | -15– +15 dB | Gain of the low range |
| EQ Mid Freq | 50–20000 Hz | Frequency of the middle range |
| EQ Mid Q | 0.5, 0.7, 1.0, 2.0, 4.0, 8.0 | Gain of the middle range Set a higher value for Q to narrow the range to be affected. |
| EQ Mid Gain | -15– +15 dB | Gain of the middle range |
| EQ Hi Freq | 2000–20000 Hz | Frequency of the high range |
| EQ Hi Gain | -15– +15 dB | Gain of the high range |
| NS Sw | OFF, ON | Turns the noise suppressor on/off. |
| NS Threshold #2 | 0–127 | Adjusts the level at which the noise suppressor will begin to take effect. <i>* When the signal drops below the specified level, it will be muted.</i> |
| NS Release | 0–127 | Sets the transition time from when the noise suppression starts to the point where the volume reaches 0. |

10: Tape Echo Simulator

This virtual tape echo gives you real tape delay sound. This simulates the tape echo part of Roland’s RE-201 Space Echo.

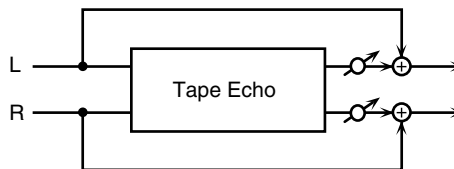

| Parameter | Value | Description |
|-----------------|-------------------------------|---|
| Mode | S, M, L, S+M, S+L, M+L, S+M+L | Sets the combination of playback heads to be used. The RE-201 had three playback heads to make different delay times (Short, Medium, and Long delay) at once. For example, to use the short and middle heads, select S+M. |
| Repeat Rate #1 | 0–127 | Sets the tape speed. This corresponds to the delay time in a contemporary delay effect. |
| Intensity #2 | 0–127 | Sets the repeat times of the delayed sound. This is analogous to a contemporary delay’s feedback setting. |
| Bass | -100– +100 | These are the echo sound’s bass and treble adjustments. When set to 0, they make no change to the sound. |
| Treble | | |
| Head S Pan | L63–63R | These are the pan (left-right) settings for each of the heads for Short, Medium, and Long delay time. <i>* This parameter does not appear on the original RE-201.</i> |
| Head M Pan | | |
| Head L Pan | | |
| Tape Distortion | 0–5 | Adds the distortion characteristic of tape. The distortion gets more intense as the value is increased. |
| W/F Rate | 0–127 | Frequency of the wow and flutter modulation The wavering of multiple pitches that appears from tape wear and irregularities in rotation is called wow and flutter. |
| W/F Depth | 0–127 | Modulation depth of the wow and flutter |
| Echo Level | 0–127 | Volume of the echo sound. |

11: Stereo Delay

This is a stereo delay. Depending on the length of the delay you set, you can get long echoes, thick sounds, or spatial sounds.

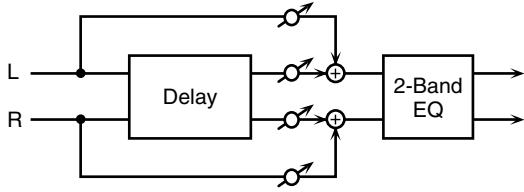

When Mode parameter is STEREO:

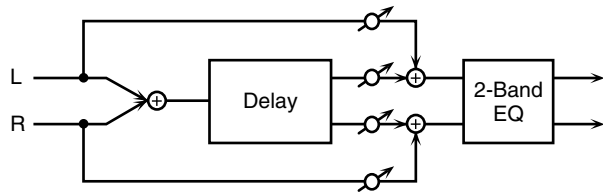

When Mode parameter is MONO or ALTERNATE:

| Parameter | Value | Description |
|------------|--|---|
| Mode | MONO, STEREO, ALTERNATE | Switches stereo, monaural, or alternate. MONO: This is a single-input, dual-output delay. Stereo sound (left and right) are mixed before being input. STEREO: This is a dual-input, dual-output delay. The delay sound output features the same stereo placement as that of the input. ALTERNATE: The left and right delay sound output alternately. (Alternate delay) |
| Delay Time | 0–1300 ms (MONO), 0–650 ms (STEREO, ALTERNATE), note | Adjusts the delay time from the direct sound until the delay sound is heard. |
| L-R Shift | 0–650 ms, note | Of the left and right delay sounds, the delay time will be increased for only one side. If the L-R order is L→R, the R sound will be later. In the case of R→L, the L sound will be later. * When the mode is set to MONO or ALTERNATE, this setting will be ignored. |
| L-R Order | L→R, R→L | In STEREO or ALTERNATE mode, this setting determines which of the left or right sides has the delay sound before the other L→R: The left side is expressed first R→L: The right side is expressed first * In MONO mode, this setting will be ignored. |

| Parameter | Value | Description |
|---------------|-------------------------|--|
| Feedback | -98– +98% | Adjusts the proportion of the delay sound that is fed back into the effect. Negative (-) settings will invert the phase. |
| Low Damp Freq | 50–4000 Hz | Adjusts the frequency below which sound fed back to the effect will be cut. The Low Damp function damps the low frequency band of the delay sound quicker than other bands, which makes for a clearer delay effect. |
| Low Damp Gain | -36–0 dB | Degree of Low Damp |
| Hi Damp Freq | 2000–20000 Hz | Adjusts the frequency above which sound fed back to the effect will be cut. High Damp, by attenuating the higher frequencies first, makes the delay sound more natural. |
| Hi Damp Gain | -36–0 dB | Degree of High Damp |
| Balance | DRY100:0WET–DRY0:100WET | Volume balance between the direct sound (DRY) and the delay sound (WET) |
| Ps Low Freq | 50–4000 Hz | Frequency of the low range |
| Ps Low Gain | -15– +15 dB | Gain of the low range |
| Ps Hi Freq | 2000–20000 Hz | Frequency of the high range |
| Ps Hi Gain | -15– +15 dB | Gain of the high range |

12: Multi Tap Delay

The effect has five delays. Each of the Delay Time parameters can be specified as a note length of the selected tempo. You can also set the panning and level of each delay sound.

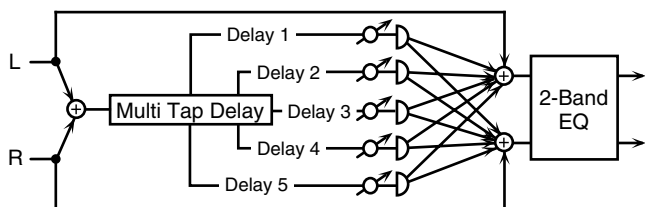

| Parameter | Value | Description |
|-----------------|-----------------|---|
| Delay 1-5 | 0-1300 ms, note | Specifies the delay time from the original sound until each delay sound (Delay 1/2/3/4/5) is heard. |
| Fbk Dly Time | 0-1300 ms, note | Adjusts the delay time for the feedback sound |
| Feedback #1 | -98- +98% | Adjusts the proportion of the delay sound that is fed back into the effect. Negative (-) settings will invert the phase. |
| Delay 1-5 Level | 0-127 | Adjusts the volume of each delay sound (Delay 1/2/3/4/5) |
| Delay 1-5 Pan | L63-63R | Adjusts the pan of each delay sound (Delay 1/2/3/4/5) |
| Low Damp Freq | 50-4000 Hz | Adjusts the frequency below which sound fed back to the effect will be cut. The Low Damp function damps the low frequency band of the delay sound quicker than other bands, which makes for a clearer delay effect. |
| Low Damp Gain | -36-0 dB | Degree of Low Damp |
| Hi Damp Freq | 2000-20000 Hz | Adjusts the frequency above which sound fed back to the effect will be cut. High Damp, by attenuating the higher frequencies first, makes the delay sound more natural. |
| Hi Damp Gain | -36-0 dB | Degree of High Damp |
| Ps Low Freq | 50-4000 Hz | Frequency of the low range |
| Ps Low Gain | -15- +15 dB | Gain of the low range |
| Ps Hi Freq | 2000-20000 Hz | Frequency of the high range |
| Ps Hi Gain | -15- +15 dB | Gain of the high range |

13: Reverse Delay

Adds the reverse of the input sound as the delay sound.

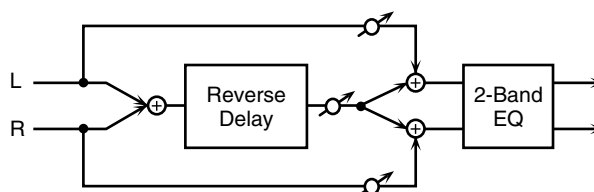

| Parameter | Value | Description |
|---------------|-------------------------|---|
| Threshold | 0-127 | Specifies the input level at which the delay will begin to apply. |
| Rvs Dly Time | 0-650 ms, note | Specifies the delay time from the original sound until the delay sound is heard. |
| Rvs Feedback | -98- +98% | Adjusts the proportion of the reverse delay sound that is fed back into the effect. Negative (-) settings will invert the phase. |
| Low Damp Freq | 50-4000 Hz | Adjusts the frequency below which sound fed back to the effect will be cut. The Low Damp function damps the low frequency band of the delay sound quicker than other bands, which makes for a clearer delay effect. |
| Low Damp Gain | -36-0 dB | Degree of Low Damp |
| Hi Damp Freq | 2000-20000 Hz | Adjusts the frequency above which sound fed back to the effect will be cut. High Damp, by attenuating the higher frequencies first, makes the delay sound more natural. |
| Hi Damp Gain | -36-0 dB | Degree of High Damp |
| Balance | DRY100:0WET-DRY0:100WET | Volume balance between the direct sound (DRY) and the effect sound (WET) |
| Ps Low Freq | 50-4000 Hz | Frequency of the low range |
| Ps Low Gain | -15- +15 dB | Gain of the low range |
| Ps Hi Freq | 2000-20000 Hz | Frequency of the high range |
| Ps Hi Gain | -15- +15 dB | Gain of the high range |

Effects List

14: Vocal Echo

This effect simulates a karaoke echo.

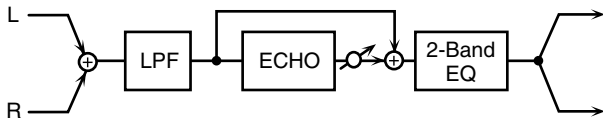

| Parameter | Value | Description |
|---------------|--------------------|---|
| Delay Time #1 | 0–650 ms, note | Adjusts the delay time from the direct sound until the delay sound is heard. |
| Pre LPF Freq | 500–15000 Hz, THRU | Sets the filter's cutoff frequency (THRU: no filter is used) |
| Mod Rate | 0.05–10.0 Hz, note | Specifies the modulation speed of the modulation effect. |
| Mod Depth | 0–127 | Specifies the modulation depth of the modulation effect. |
| Diffusion | 0–100 | Specifies the spaciousness of the delay sound. |
| Feedback #2 | -98– +98% | Adjusts the proportion of the delay sound that is fed back into the effect. Negative (-) settings will invert the phase. |
| Hi Damp Freq | 500–15000 Hz, THRU | Adjusts the frequency above which sound fed back to the effect will be cut. High Damp, by attenuating the higher frequencies first, makes the delay sound more natural. |
| Echo Level #3 | 0–127 | Volume of the echo sound |
| Ps Low Freq | 50–4000 Hz | Frequency of the low range |
| Ps Low Gain | -15– +15 dB | Gain of the low range |
| Ps Hi Freq | 2000–20000 Hz | Frequency of the high range |
| Ps Hi Gain | -15– +15 dB | Gain of the high range |

15: Band Pass Delay

This is a delay with a band pass filter (a filter that outputs only a specified frequency range) on each of five delays. A phaser is included before the delay. Phaser is an effect that adds a phase-shifted sound to the original sound to create time-varying change, modulating the sound.

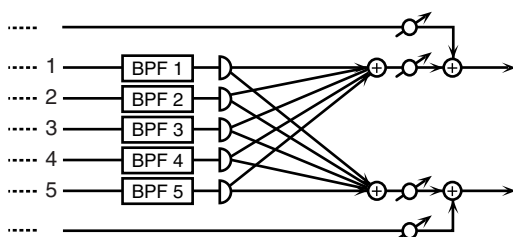
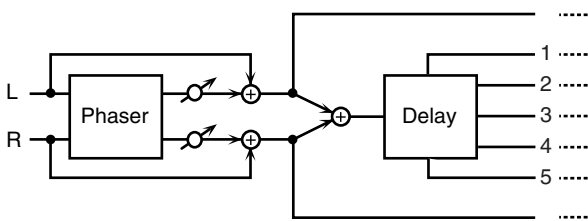

| Parameter | Value | Description |
|-------------------|-------------------------|---|
| Phaser Manual | 0–127 | Specifies the center frequency at which the sound is modulated. |
| Phaser Rate | 0.05–10.0 Hz, note | Specifies the frequency of modulation. |
| Phaser Depth | 0–127 | Specifies the depth of modulation. |
| Phaser Resonance | 0–127 | Specifies the amount of feedback for the phaser. Higher settings will give the sound a stronger character. |
| Phaser Mix Level | 0–127 | Specifies the volume of the phase-shifted sound, relative to the direct sound. |
| Delay Time | 0–1300 ms, note | Adjusts the delay time from the direct sound until the each delay sound is heard. |
| Fbk Dly Time | 0–1300 ms, note | Adjusts the delay time for the feedback sound. |
| Dly Time Dev | 0–1300 ms, note | Specifies the differences in delay time for each of the delay sounds. |
| Delay Level | 0–127 | Adjusts the volume of each delay sound. |
| Delay Feedback #1 | -98– +98% | Adjusts the proportion of the delay sound that is fed back into the effect. Negative (-) settings will invert the phase. |
| Delay Pan Type | 1–10 | Specifies the pan of each delay sound. Ten settings are provided as various panning combinations of the delay sounds (see below). |
| BPF 1–5 Freq | 50–20000 Hz | Sets the center frequency for each band pass filter (1–5). |
| BPF 1/2 Q | 0.3–24.0 | Specify the output bandwidth for each band pass filter (1–5). |
| BPF 3/4/5 Q | | |
| Balance #2 | DRY100:0WET–DRY0:100WET | Volume balance between the direct sound (DRY) and the delay sound (WET) |

Delay Pan Type

| Values | Dly 1 | Dly 2 | Dly 3 | Dly 4 | Dly 5 |
|--------|-------|-------|-------|-------|-------|
| 1 | L63 | L32 | 0 | 32R | 63R |
| 2 | L63 | 32R | L32 | 63R | 0 |
| 3 | L63 | 63R | L32 | 32R | 0 |
| 4 | 32R | L32 | L63 | 0 | 63R |
| 5 | 63R | 0 | L63 | L32 | 32R |
| 6 | L32 | 32R | L63 | 63R | 0 |
| 7 | 0 | 63R | L63 | 32R | L32 |
| 8 | 0 | 63R | L32 | 32R | L63 |
| 9 | 0 | 32R | L32 | 63R | L63 |
| 10 | 63R | 32R | 0 | L32 | L63 |

16: Analog Delay → Chorus

This effect reproduces the sound of the BOSS CE-1 Chorus Ensemble. To reproduce the sound of the unit at the time, a monaural analog-type delay is first inserted in series.

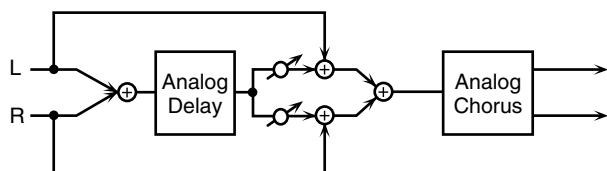

| Parameter | Value | Description |
|---------------------|------------------|--|
| Dly Sw | OFF, ON | Turns the delay on/off. |
| Dly Repeat Rate #1 | 0–127 | Corresponds to the delay time in a delay effects. |
| Dly Intensity #2 | 0–127 | Corresponds to the feedback setting in a delay effects. |
| Dly Level | 0–127 | Sets the volume of the delay sound. |
| Chorus Sw | OFF, ON | Turns chorus or vibrato on/off. |
| Chorus Mode | CHORUS, VIBRATO | Switches the sound between chorus and vibrato modes. |
| Chorus Intensity #3 | 0–127 | When Chorus Mode is CHORUS, this sets the pitch vibrato speed. |
| Vibrato Depth | 0–127 | When Chorus Mode is VIBRATO, this sets the pitch vibrato depth. |
| Vibrato Rate | 0–127 | When Chorus Mode is VIBRATO, this sets the pitch vibrato speed. |
| Chorus Out Mode | MONO, ST-1, ST-2 | Switches the output format (mono/stereo). MONO: Output is monaural. ST-1: Chorus sound of the pitch vibration which phase is inverted between left and right is mixed with the source sound. This is a broader chorus, with a weaker feeling of placement. ST-2: The left output contains the source sound, and the right side has the wavering chorus sound. |

17: Digital Chorus

This is a stereo chorus or flanger. Equalizers are provided before (Pre) and after (Post) the chorus (or flanger).

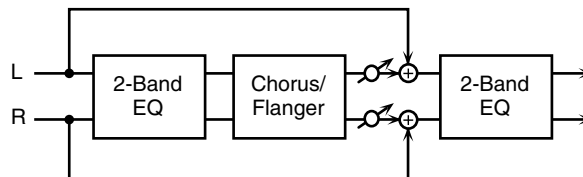

| Parameter | Value | Description |
|------------------|--------------------|--|
| Mode | CHORUS, FLANGER | Selects either chorus or flanger. |
| Rate #1 | 0.05–10.0 Hz, note | Sets the cycle for the chorus or flanger sound undulations. |
| Depth | 0–127 | Adjusts the depth of modulation for the chorus or flanger. |
| Phase | 0–180 deg | Specifies the spaciousness of the chorus or flanger sound. |
| Pre Low Freq | 50–4000 Hz | Frequency of the low range (Pre) |
| Pre Low Gain | -15– +15 dB | Gain of the low range (Pre) |
| Pre Hi Freq | 2000–20000 Hz | Frequency of the high range (Pre) |
| Pre Hi Gain | -15– +15 dB | Gain of the high range (Pre) |
| Pre Dly Time | 0–50.0 ms | Adjusts the delay time from the direct sound until the chorus or flanger sound is heard. |
| Feedback | -98– +98% | Adjusts the proportion of the chorus or flanger sound that is fed back into the effect. Negative (-) settings will invert the phase. |
| Xover LowFreq | 50–4000 Hz | Attenuates the effect in the range below the specified frequency. |
| Xover Low Gain | -36–0 dB | Specifies how greatly the low range will be attenuated. |
| Xover HiFreq | 2000–20000 Hz | Attenuates the effect in the range above the specified frequency. |
| Xover Hi Gain | -36–0 dB | Specifies how greatly the high range will be attenuated. |
| Modulation Level | 0–127 | Volume of the chorus or flanger sound. |
| Ps Low Freq | 50–4000 Hz | Frequency of the low range (Post) |
| Ps Low Gain | -15– +15 dB | Gain of the low range (Post) |
| Ps Hi Freq | 2000–20000 Hz | Frequency of the high range (Post) |
| Ps Hi Gain | -15– +15 dB | Gain of the high range (Post) |

Effects List

18: Space Chorus

This effect reproduces the sound of Roland's SDD-320 spatial expression effects. Greater breadth is added.

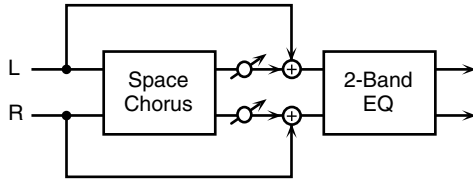

| Parameter | Value | Description |
|-----------------|---------------------------|---|
| Mode | 1, 2, 3, 4, 1+4, 2+4, 3+4 | Selects the way in the chorus will change. The SDD-320 features four mode buttons for changing the effect. This setting determines which buttons are to be pressed. ("1+4" represents the condition when Buttons 1 and 4 are pressed simultaneously.) |
| Chorus Level #1 | 0-127 | Volume level of the chorus sound |
| Ps Low Freq | 50-4000 Hz | Frequency of the low range |
| Ps Low Gain | -15- +15 dB | Gain of the low range |
| Ps Hi Freq | 2000-20000 Hz | Frequency of the high range |
| Ps Hi Gain | -15- +15 dB | Gain of the high range |

19: Hexa Chorus

Hexa-chorus is a six-stage chorus which adds depth and spaciousness to the sound. (Six chorus sounds with different delay times are overlaid.) An equalizer is provided before (Pre) and after (Post) the hexa chorus.

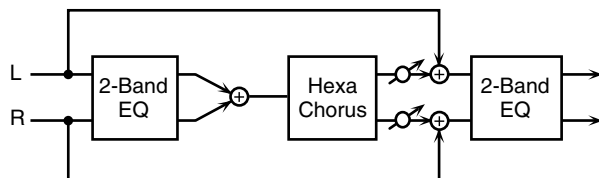

| Parameter | Value | Description |
|-----------------|--------------------|---|
| Pre Dly Time | 0-50.0 ms | Adjusts the delay time from the direct sound until the chorus sound is heard. |
| Pre Dly Dev | 0-50.0 ms | Specifies the differences in Pre Delay time for each of the chorus sounds |
| Rate #1 | 0.05-10.0 Hz, note | Specifies the modulation frequency of the chorus sound. |
| Depth | 0-127 | Specifies the modulation depth of the chorus sound. |
| Depth Deviation | 0-127 | Specifies the difference in modulation depth between each of the chorus sounds. |

| Parameter | Value | Description |
|-----------------|---------------|--|
| Pan Deviation | L63-63R | Specifies the difference in stereo position between each of the chorus sounds. 0: All of the chorus sounds will be panned to the center. L20/R20: each chorus sound will be placed in 30 degree intervals relative to the center position. |
| Chorus Level #2 | 0-127 | Volume level of the chorus sound |
| Pre Low Freq | 50-4000 Hz | Frequency of the low range (Pre) |
| Pre Low Gain | -15- +15 dB | Gain of the low range (Pre) |
| Pre Hi Freq | 2000-20000 Hz | Frequency of the high range (Pre) |
| Pre Hi Gain | -15- +15 dB | Gain of the high range (Pre) |
| Ps Low Freq | 50-4000 Hz | Frequency of the low range |
| Ps Low Gain | -15- +15 dB | Gain of the low range |
| Ps Hi Freq | 2000-20000 Hz | Frequency of the high range |
| Ps Hi Gain | -15- +15 dB | Gain of the high range |

20: Analog Flanger

This effect reproduces the sound of Roland's SBF-325 analog flanger. You can get three different types of flanger sounds (adding a metallic swelling sound to the source sound) and chorus like effect.

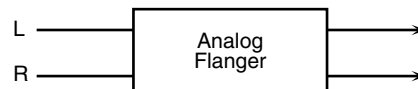

| Parameter | Value | Description |
|----------------|--------------------|---|
| Mode | FL1, FL2, FL3, CHO | Sets the effect type. FL1: A general monaural flanger FL2: A stereo flanger that utilizes the stereo placement of the source sound FL3: A cross mix flanger that providing a more intense effect CHO: Chorus effect |
| Rate #1 | 0.02-5.00 Hz, note | Sets the rate of the swelling of the flanger sound. |
| Depth #2 | 0-127 | Specifies the modulation depth of the flanger sound. |
| Manual | 0-127 | Adjusts the center frequency to which the flanger effect is applied. |
| Feedback #3 | 0-127 | Sets the intensity of the flanger's effect. * When the mode is set to CHO, this setting will be ignored. |
| CH-R Mod Phase | NORM, INV | Sets the phase of the right channel. This is usually set to Normal (NORM). Setting this to Invert (INV) inverts the phase of the modulation (rise and fall) in the right channel. |
| CH-L Phase | NORM, INV | Sets the phase of the left and right channels when the source sound is mixed with the flanging sound. |
| CH-R Phase | | NORM: Positive phase (+) INV: negative phase (-) |

21: BOSS Flanger

This effect features a pair of the same flanger circuits used in the BOSS compact flangers, connected in parallel for stereo input. This adds a particular metallic-sounding modulation to the source sound.

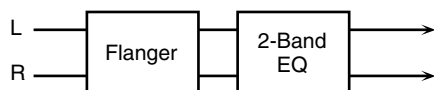

| Parameter | Value | Description |
|-----------------|--------------------|---|
| Type | NORMAL, HI-BAND | Selects the model of flanger simulated. NORMAL: Normal type (BOSS BF-2) HI-BAND: High-Band type (BOSS HF-2). Setting HI-B raise the flanging sound one octave above that at the NORM. |
| Manual | 0–127 | Sets the center frequency for the effect. |
| Depth #1 | 0–127 | Sets the depth of the swelling of the flanger sound. |
| Rate #2 | 0.05–10.0 Hz, note | Adjusts the modulation speed of the flanger effect. |
| Resonance | 0–127 | Sets the intensity of the flanger's effect. <i>* If the Feedback Mode is CROSS, this setting is ignored.</i> |
| Phase | 0–180 deg | Specifies the spaciousness of the flanger sound. |
| Feedback Mode | NORMAL, CROSS | Specifies the input destination to which the flanger sound will be returned. NORMAL: The left flanger sound will be returned to the left input, and the right flanger sound to the right input. CROSS: The left flanger sound will be returned to the right input, and the right flanger sound to the left input. |
| Feedback | -98– +98% | This setting makes the flanging sound of each of right and left channels return to the input of the opposite channel. Negative (-) settings will invert the phase. <i>* When the Feedback Mode is set to NORMAL, this setting will be ignored.</i> |
| Cross Mix Level | -100– +100 | This setting makes the flanging sound from each of the right and left channels mix it with the flanging sound of the opposite channel. Negative (-) settings will invert the phase. |
| Ps Low Freq | 50–4000 Hz | Frequency of the low range |
| Ps Low Gain | -15– +15 dB | Gain of the low range |
| Ps Hi Freq | 2000–20000 Hz | Frequency of the high range |
| Ps Hi Gain | -15– +15 dB | Gain of the high range |

22: Step Flanger

This is a flanger in which the flanger pitch changes in steps. The speed at which the pitch changes can also be specified in terms of a note-value of a specified tempo.

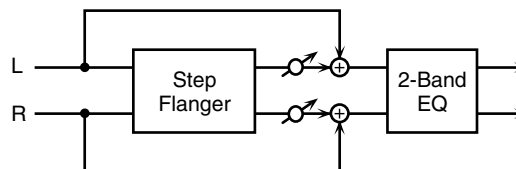

| Parameter | Value | Description |
|---------------|--------------------|--|
| Pre Dly Time | 0–50.0 ms | Specifies the time delay from the original sound until the flanger sound is heard. |
| Rate #1 | 0.05–10.0 Hz, note | Specifies the modulation frequency of the flanger sound. |
| Depth | 0–127 | Specifies the modulation depth of the flanger sound. |
| Feedback | -98– +98% | Adjusts the proportion of the flanger sound that is fed back into the effect. Negative (-) settings will invert the phase. |
| Phase | 0–180 deg | Specifies the spaciousness of the flanger sound. |
| Step Rate #2 | 0.05–10.0 Hz, note | Specifies the frequency of pitch change. |
| Flanger Level | 0–127 | Volume of the flanger sound |
| Ps Low Freq | 50–4000 Hz | Frequency of the low range |
| Ps Low Gain | -15– +15 dB | Gain of the low range |
| Ps Hi Freq | 2000–20000 Hz | Frequency of the high range |
| Ps Hi Gain | -15– +15 dB | Gain of the high range |

23: Analog Phaser

This effect features two analog-type phasers arranged in parallel, making it stereo compatible. The sound as it cyclically drifts in and out of phase is added to the source sound, creating the modulation with the characteristic of phasers.

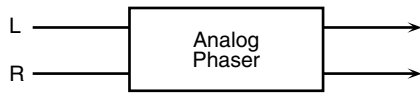

| Parameter | Value | Description |
|----------------|-----------------------|--|
| Shift Mode | 4STAGE, 8STAGE | Sets the number of stages in the phase shift circuit (four (4STAG) or eight (8STAGE)). Setting this to eight stages (8STAGE) increases the number of the frequency points that sound is canceled, giving a sharper effect. |
| | | |
| | | |
| Center Freq #1 | 0-127 | Sets the center frequency to which the phaser effect is applied. Increasing this value moves the effect point of the phaser into higher frequency ranges. |
| Resonance | 0-127 | Amount of feedback. Increasing this value gives a more distinctive sound to the effect. |
| LFO 1/2 Rate | 0.02-5.00 Hz, note | Sets the rate of the swelling sound. |
| LFO 1/2 Depth | 0-127 | Specifies the depth of modulation. |
| LFO 1/2 Phase | NORM, INV | Sets the phase of both left and right swelling. NORM: The left and right phase will be the same. INV: The left and right phase will be opposite. |

24: Digital Phaser

Phaser is an effect that adds a phase-shifted sound to the original sound to create time-varying change, modulating the sound.

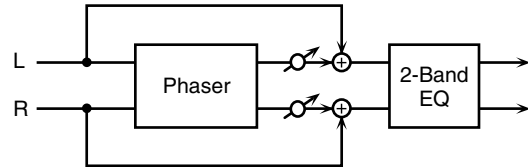

| Parameter | Value | Description |
|-------------|-----------------------|--|
| Shift Mode | 4STAGE, 8STAGE | Sets the number of stages in the phase shift circuit (four (4STAG) or eight (8STAGE)). Setting this to eight stages (8STAGE) increases the number of the frequency points that sound is canceled, giving a sharper effect. |
| | | |
| | | |
| Manual | 0-127 | Specifies the center frequency at which the sound is modulated. |
| Rate #1 | 0.05-10.0 Hz, note | Specifies the frequency of modulation. |
| Depth #2 | 0-127 | Specifies the depth of modulation. |
| Phase | NORM, INV | Sets the phase of both left and right swelling. NORM: The left and right phase will be the same. INV: The left and right phase will be opposite. |
| Resonance | 0-127 | Specifies the amount of feedback for the phaser. Higher settings will give the sound a stronger character. |
| Mix Level | 0-127 | Volume of the phase-shifted sound, relative to the direct sound |
| Ps Low Freq | 50-4000 Hz | Frequency of the low range |
| Ps Low Gain | -15- +15 dB | Gain of the low range |
| Ps Hi Freq | 2000-20000 Hz | Frequency of the high range |
| Ps Hi Gain | -15- +15 dB | Gain of the high range |

25: Rotary

The Rotary effect simulates the sound of the rotary speakers often used with the electric organs of the past. Since the movement of the high range and low range rotors can be set independently, the unique type of modulation characteristic of these speakers can be simulated quite closely. This effect is most suitable for electric organ Patches.

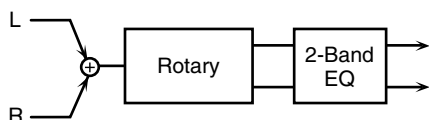

| Parameter | Value | Description |
|------------------|--------------------|---|
| Speed | SLOW, FAST | Simultaneously switch the rotational speed of the low frequency rotor and high frequency rotor SLOW: Slows down the rotation to the Slow Rate. FAST: Speeds up the rotation to the Fast Rate. |
| Low Slow Rate | 0.05–10.0 Hz, note | Slow speed (SLOW) of the low frequency rotor |
| Low Fast Rate | 0.05–10.0 Hz, note | Fast speed (FAST) of the low frequency rotor |
| Low Acceleration | 0–15 | Adjusts the time it takes the low frequency rotor to reach the newly selected speed when switching from fast to slow (or slow to fast) speed. |
| Low Level | 0–127 | Volume of the low frequency rotor |
| Hi Slow Rate | 0.05–10.0 Hz, note | Slow speed (SLOW) of the high frequency rotor |
| Hi Fast Rate | 0.05–10.0 Hz, note | Fast speed (FAST) of the high frequency rotor |
| Hi Acceleration | 0–15 | Adjusts the time it takes the high frequency rotor to reach the newly selected speed when switching from fast to slow (or slow to fast) speed. |
| Hi Level | 0–127 | Volume of the high frequency rotor |
| Separation #1 | 0–127 | Spatial dispersion of the sound |
| Ps Low Freq | 50–4000 Hz | Frequency of the low range |
| Ps Low Gain | -15– +15 dB | Gain of the low range |
| Ps Hi Freq | 2000–20000 Hz | Frequency of the high range |
| Ps Hi Gain | -15– +15 dB | Gain of the high range |

26: Tremolo/Auto Pan

This is a stereo tremolo or auto-pan effect. Tremolo cyclically modulates the volume to add tremolo effect to the sound. The Auto Pan effect cyclically modulates the stereo location of the sound.

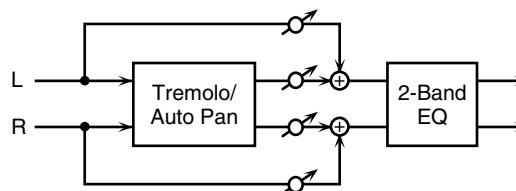

| Parameter | Value | Description |
|-------------|-----------------------------|---|
| Mode | TREMOLO, AUTO PAN | Selects whether to use tremolo or auto pan. |
| Waveform | TRI, SAWUP, SAWDN, SQR, SIN | Selects the type of modulation. TRI: Triangle wave SAWUP/SAWDN: Sawtooth Wave SQR: Square wave SIN: Sine wave |
| | | |
| Rate #1 | 0.05–10.0 Hz, note | Frequency of modulation |
| Depth #2 | 0–127 | Depth of modulation |
| Balance | DRY100:0WET–DRY0:100WET | Volume balance between the direct sound (DRY) and the effect sound (WET) |
| Ps Low Freq | 50–4000 Hz | Frequency of the low range |
| Ps Low Gain | -15– +15 dB | Gain of the low range |
| Ps Hi Freq | 2000–20000 Hz | Frequency of the high range |
| Ps Hi Gain | -15– +15 dB | Gain of the high range |

27: Stereo Pitch Shifter

This effect features two pitch shifters arranged in parallel, making it stereo compatible. It can shift the pitch of the input signal up to one octave up or down.

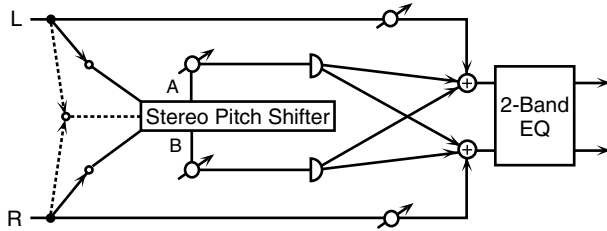

| Parameter | Value | Description |
|------------------------|-------------------|---|
| Input Mode | MONO, STEREO | Selects either stereo input or monaural input. |
| Grade | 1-5 | Sets the grade of the effect sound. The higher the value is set, the more natural-sounding can be obtained; however, this increases the delay from the source sound as well. |
| Coarse Pitch A/B #1/#2 | -12- +12 semitone | Specifies the pitch shift amount in semitones for pitch shift A or B. |
| Fine Pitch A/B | -100- +100 cent | Adjusts the pitch shift amount in 2-cent units (1 cent = 1/100 of a semitone) for pitch shift A or B. |
| Pre Delay A/B | 0-500 ms | Adjusts the delay time from the direct sound until the pitch shift A or B sound is heard. |
| Level A/B | 0-127 | Volume of the pitch shift A or B sound. |
| Pan A/B | L63-63R | Pan of the pitch shift A or B sound. |
| Direct Level | 0-127 | Volume of the direct sound. |
| Feedback #3 | -98- +98% | Adjusts the proportion of the pitch shift sound that is fed back into the effect. Negative (-) settings will invert the phase. |
| Low Damp Freq | 50-4000 Hz | Adjusts the frequency below which sound fed back to the effect will be cut. The Low Damp function damps the low frequency band of the pitch shift sound quicker than other bands. |
| Low Damp Gain | -36-0 dB | Degree of Low Damp |
| Hi Damp Freq | 2000-20000 Hz | Adjusts the frequency above which sound fed back to the effect will be cut. High Damp, by attenuating the higher frequencies first. |
| Hi Damp Gain | -36-0 dB | Degree of High Damp |
| Ps Low Freq | 50-4000 Hz | Frequency of the low range |
| Ps Low Gain | -15- +15 dB | Gain of the low range |
| Ps Hi Freq | 2000-20000 Hz | Frequency of the high range |
| Ps Hi Gain | -15- +15 dB | Gain of the high range |

28: OD/DS → Cho/Flg (Overdrive/Distortion → Chorus/Flanger)

This effect connects either Overdrive or Distortion and either Chorus or Flanger.

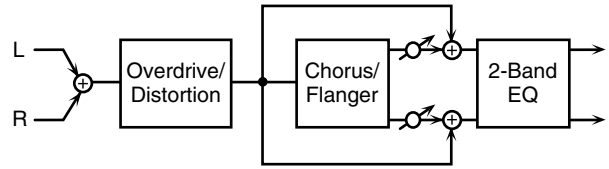

| Parameter | Value | Description |
|-----------------------------|-----------------------------------|--|
| Drive Mode | OD, DS | Selects whether to use overdrive (OD) or distortion (DS). |
| Drive #1 | 0-127 | Degree of distortion |
| Amp Sim Sw | OFF, ON | Turns the amp simulator on/off. |
| Amp Type | SMALL, BUILT-IN, 2-STACK, 3-STACK | Type of guitar amp SMALL: small amp BUILT-IN: single-unit type amp 2-STACK: large double stack amp 3-STACK: large triple stack amp |
| Distortion Level | 0-127 | Volume of the overdrive or distortion sound. |
| Mod Mode (Chorus / Flanger) | CHORUS, FLANGER | Selects whether to use chorus or flanger. |
| Mod Rate #2 | 0.05-10.0 Hz, note | Adjusts the speed of modulation for the chorus or flanger. |
| Mod Depth | 0-127 | Adjusts the depth of modulation for the chorus or flanger. |
| Mod Phase | 0-180 deg | Sets how the chorus or flanger sound is spread. |
| Mod Pre Delay | 0-50.0 ms | Adjusts the delay time from the direct sound until the chorus or flanger sound is heard. |
| Mod Feedback | -98- +98% | Adjusts the proportion of the effect sound that is fed back into the effect. Negative (-) settings will invert the phase. |
| Xover LowFreq | 50-4000 Hz | Attenuates the effect in the range below the specified frequency. |
| Xover Low Gain | -36-0 dB | Specifies how greatly the low range will be attenuated. |
| Xover HiFreq | 2000-20000 Hz | Attenuates the effect in the range above the specified frequency. |
| Xover Hi Gain | -36-0 dB | Specifies how greatly the high range will be attenuated. |
| Mod Level | 0-127 | Volume of the chorus or flanger sound. |
| Ps Low Freq | 50-4000 Hz | Frequency of the low range |
| Ps Low Gain | -15- +15 dB | Gain of the low range |
| Ps Hi Freq | 2000-20000 Hz | Frequency of the high range |
| Ps Hi Gain | -15- +15 dB | Gain of the high range |

29: OD/DS → Delay (Overdrive/Distortion → Delay)

This effect connects either Overdrive or Distortion and Delay in series.

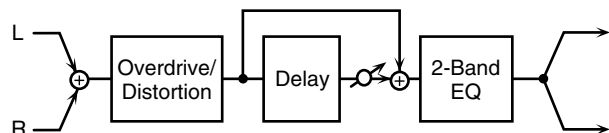

| Parameter | Value | Description |
|-------------------|-----------------------------------|--|
| Drive Mode | OD, DS | Selects whether to use overdrive (OD) or distortion (DS). |
| Drive #1 | 0–127 | Degree of distortion |
| Amp Sim Sw | OFF, ON | Turns the amp simulator on/off. |
| Amp Type | SMALL, BUILT-IN, 2-STACK, 3-STACK | Type of guitar amp SMALL: small amp BUILT-IN: single-unit type amp 2-STACK: large double stack amp 3-STACK: large triple stack amp |
| Distortion Level | 0–127 | Volume of the overdrive or distortion sound. |
| Delay Time | 0–1300 ms, note | Adjusts the delay time from the direct sound until the delay sound is heard. |
| Delay Feedback #2 | -98– +98% | Adjusts the proportion of the delay sound that is fed back into the effect. Negative (-) settings will invert the phase. |
| Low Damp Freq | 50–4000 Hz | Adjusts the frequency below which sound fed back to the effect will be cut. The Low Damp function damps the low frequency band of the delay sound quicker than other bands, which makes for a clearer delay effect. |
| Low Damp Gain | -36–0 dB | Degree of Low Damp |
| Hi Damp Freq | 2000–20000 Hz | Adjusts the frequency above which sound fed back to the effect will be cut. High Damp, by attenuating the higher frequencies first, makes the delay sound more natural. |
| Hi Damp Gain | -36–0 dB | Degree of High Damp |
| Delay Level | 0–127 | Volume of the delay sound. |
| Ps Low Freq | 50–4000 Hz | Frequency of the low range |
| Ps Low Gain | -15– +15 dB | Gain of the low range |
| Ps Hi Freq | 2000–20000 Hz | Frequency of the high range |
| Ps Hi Gain | -15– +15 dB | Gain of the high range |

30: Cho/Flg → Delay (Chorus/Flanger → Delay)

This effect connects either Chorus or Flanger and Delay in series.

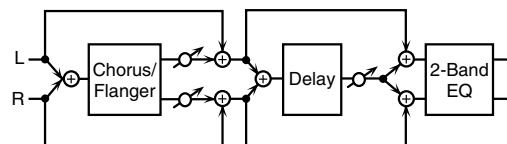

| Parameter | Value | Description |
|-----------------------------|--------------------|--|
| Mod Mode (Chorus / Flanger) | CHORUS, FLANGER | Selects whether to use chorus or flanger. |
| Mod Rate #1 | 0.05–10.0 Hz, note | Adjusts the speed of modulation for the chorus or flanger. |
| Mod Depth | 0–127 | Adjusts the depth of modulation for the chorus or flanger. |
| Mod Phase | 0–180 deg | Sets how the chorus or flanger sound is spread. |
| Mod Pre Delay | 0–50.0 ms | Adjusts the delay time from the direct sound until the chorus or flanger sound is heard. |
| Mod Feedback | -98– +98% | Adjusts the proportion of the effect sound that is fed back into the effect. Negative (-) settings will invert the phase. |
| Xover Low Freq | 50–4000 Hz | Attenuates the effect in the range below the specified frequency. |
| Xover Low Gain | -36–0 dB | Specifies how greatly the low range will be attenuated. |
| Xover Hi Freq | 2000–20000 Hz | Attenuates the effect in the range above the specified frequency. |
| Xover Hi Gain | -36–0 dB | Specifies how greatly the high range will be attenuated. |
| Mod Level | 0–127 | Volume of the chorus or flanger sound. |
| Delay Time | 0–1300 ms, note | Adjusts the delay time from the direct sound until the delay sound is heard. |
| Delay Feedback | -98– +98% | Adjusts the proportion of the delay sound that is fed back into the effect. Negative (-) settings will invert the phase. |
| Low Damp Freq | 50–4000 Hz | Adjusts the frequency below which sound fed back to the effect will be cut. The Low Damp function damps the low frequency band of the delay sound quicker than other bands, which makes for a clearer delay effect. |
| Low Damp Gain | -36–0 dB | Degree of Low Damp |
| Hi Damp Freq | 2000–20000 Hz | Adjusts the frequency above which sound fed back to the effect will be cut. High Damp, by attenuating the higher frequencies first, makes the delay sound more natural. |
| Hi Damp Gain | -36–0 dB | Degree of High Damp |
| Delay Level | 0–127 | Volume of the delay sound. |
| Ps Low Freq | 50–4000 Hz | Frequency of the low range |
| Ps Low Gain | -15– +15 dB | Gain of the low range |
| Ps Hi Freq | 2000–20000 Hz | Frequency of the high range |
| Ps Hi Gain | -15– +15 dB | Gain of the high range |

31: Enh → Cho/Flg (Enhancer → Chorus/Flanger)

This effect connects Enhancer and either Chorus or Flanger in series.

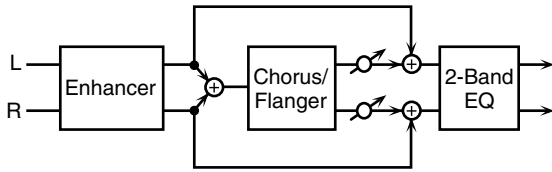

| Parameter | Value | Description |
|-----------------------------|--------------------|---|
| Enhan Sens #1 | 0–127 | Sensitivity of the enhancer |
| Enhan Frequency | 0–127 | Sets the lower limit of the frequencies to which the enhancement effect is added. |
| Enhan Mix Level | 0–127 | Level of the overtones generated by the enhancer |
| Enhan Level | 0–127 | Volume of the enhancer sound |
| Mod Mode (Chorus / Flanger) | CHORUS, FLANGER | Selects whether to use chorus or flanger. |
| Mod Rate #2 | 0.05–10.0 Hz, note | Adjusts the speed of modulation for the chorus or flanger. |
| Mod Depth | 0–127 | Adjusts the depth of modulation for the chorus or flanger. |
| Mod Phase | 0–180 deg | Sets how the chorus or flanger sound is spread. |
| Mod Pre Delay | 0–50.0 ms | Adjusts the delay time from the direct sound until the chorus or flanger sound is heard. |
| Mod Feedback | -98– +98% | Adjusts the proportion of the effect sound that is fed back into the effect. Negative (-) settings will invert the phase. |
| Xover LowFreq | 50–4000 Hz | Attenuates the effect in the range below the specified frequency. |
| Xover Low Gain | -36–0 dB | Specifies how greatly the low range will be attenuated. |
| Xover HiFreq | 2000–20000 Hz | Attenuates the effect in the range above the specified frequency. |
| Xover Hi Gain | -36–0 dB | Specifies how greatly the high range will be attenuated. |
| Mod Level | 0–127 | Volume of the chorus or flanger sound. |
| Ps Low Freq | 50–4000 Hz | Frequency of the low range |
| Ps Low Gain | -15– +15 dB | Gain of the low range |
| Ps Hi Freq | 2000–20000 Hz | Frequency of the high range |
| Ps Hi Gain | -15– +15 dB | Gain of the high range |

32: Enh → Delay (Enhancer → Delay)

This effect connects an Enhancer and a Delay in series.

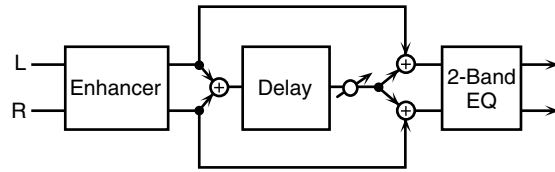

| Parameter | Value | Description |
|-------------------|-----------------|---|
| Enhan Sens #1 | 0–127 | Sensitivity of the enhancer |
| Enhan Frequency | 0–127 | Sets the lower limit of the frequencies to which the enhancement effect is added. |
| Enhan Mix Level | 0–127 | Level of the overtones generated by the enhancer |
| Enhan Level | 0–127 | Volume of the enhancer sound |
| Delay Time | 0–1300 ms, note | Adjusts the delay time from the direct sound until the delay sound is heard. |
| Delay Feedback #2 | -98– +98% | Adjusts the proportion of the delay sound that is fed back into the effect. Negative (-) settings will invert the phase. |
| Low Damp Freq | 50–4000 Hz | Adjusts the frequency below which sound fed back to the effect will be cut. The Low Damp function damps the low frequency band of the delay sound quicker than other bands, which makes for a clearer delay effect. |
| Low Damp Gain | -36–0 dB | Degree of Low Damp |
| Hi Damp Freq | 2000–20000 Hz | Adjusts the frequency above which sound fed back to the effect will be cut. High Damp, by attenuating the higher frequencies first, makes the delay sound more natural. |
| Hi Damp Gain | -36–0 dB | Degree of High Damp |
| Delay Level | 0–127 | Volume of the delay sound. |
| Ps Low Freq | 50–4000 Hz | Frequency of the low range |
| Ps Low Gain | -15– +15 dB | Gain of the low range |
| Ps Hi Freq | 2000–20000 Hz | Frequency of the high range |
| Ps Hi Gain | -15– +15 dB | Gain of the high range |

33: Vocal Multi

A limiter/de-esser, enhancer, 3-band equalizer, and delay are connected in series.

A limiter holds down high signal levels to prevent distortion.

A de-esser cuts the sibilant sounds of a voice, producing a gentler tone.

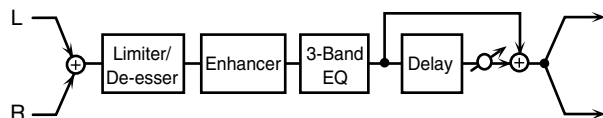

| Parameter | Value | Description |
|------------------|------------------------------|--|
| Limtr Mode | LIMITER, DE-ESSER | Selects whether the effect will function as a limiter or as a de-esser. * If the Limiter Mode is DE-ESSER, the limiter settings are ignored. Conversely, if the Limiter Mode is LIMITER, the de-esser settings are ignored. |
| Limtr Threshold | -60-0 dB | Adjusts the level (Threshold Level) at which the limiter will begin to operate. |
| Limtr Release #1 | 0-127 | Adjusts the time until when the limiter will turn off after the input level falls below the threshold level. |
| Limtr Gain | -60- +12 dB | Adjusts the gain of the sound that passes through the limiter. |
| DE Sens | 0-127 | Adjusts the sensitivity relative to the input volume, which controls how the effect is applied. |
| DE Frequency | 1000-10000 Hz | Adjusts the frequency at which the de-esser effect will apply. |
| Enhan Sens | 0-127 | Sensitivity of the enhancer |
| Enhan Frequency | 0-127 | Sets the lower limit of the frequencies to which the enhancement effect is added. |
| Enhan Mix Level | 0-127 | Level of the overtones generated by the enhancer |
| Enhan Level | 0-127 | Volume of the enhancer sound |
| EQ Low Freq | 50-4000 Hz | Frequency of the low range |
| EQ Low Gain | -15- +15 dB | Gain of the low range |
| EQ Mid Freq | 50-20000 Hz | Frequency of the middle range |
| EQ Mid Q | 0.5, 0.7, 1.0, 2.0, 4.0, 8.0 | Gain of the middle range Set a higher value for Q to narrow the range to be affected. |
| EQ Mid Gain | -15- +15 dB | Gain of the middle range |
| EQ Hi Freq | 2000-20000 Hz | Frequency of the high range |
| EQ Hi Gain | -15- +15 dB | Gain of the high range |
| Delay Time | 0-1300 ms, note | Adjusts the delay time from the direct sound until the delay sound is heard. |
| Delay Feedback | -98- +98% | Adjusts the proportion of the delay sound that is fed back into the effect. Negative (-) settings will invert the phase. |
| Low Damp Freq | 50-4000 Hz | Adjusts the frequency below which sound fed back to the effect will be cut. The Low Damp function damps the low frequency band of the delay sound quicker than other bands, which makes for a clearer delay effect. |
| Low Damp Gain | -36-0 dB | Degree of Low Damp |

| Parameter | Value | Description |
|--------------|---------------|--|
| Hi Damp Freq | 2000-20000 Hz | Adjusts the frequency above which sound fed back to the effect will be cut. High Damp, by attenuating the higher frequencies first, makes the delay sound more natural. |
| Hi Damp Gain | -36-0 dB | Degree of High Damp |
| Delay Level | 0-127 | Volume of the delay sound. |

34: Guitar Multi

Guitar Multi provides Comp/Limiter, Overdrive or Distortion, Chorus or Flanger, and Delay effects connected in series.

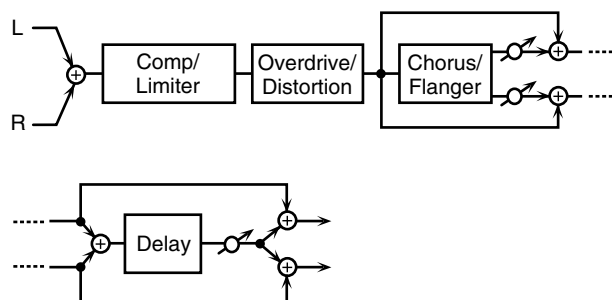

| Parameter | Value | Description |
|-----------------------------|-----------------------------------|--|
| Comp Sw | OFF, ON | Turns the comp/limiter on/off. |
| Comp Threshold | -60-0 dB | Sets the volume level at which the compression begins. |
| Comp Attack | 0-127 | Sets the time after the sound volume is crossed the compressor threshold until compression begins. |
| Comp Release | 0-127 | Specifies the time from when the volume drops below the compressor threshold until compression is no longer applied. |
| Comp Ratio | 1.5:1, 2:1, 4:1, 100:1 | Sets the "source sound:output sound" compression ratio. |
| Comp Gain | -60- +12 dB | Adjusts the output gain. |
| Distortion Sw | OFF, ON | Selects whether to use overdrive or distortion. |
| Drive Mode | OD, DS | Selects whether to use overdrive (OD) or distortion (DS). |
| Drive | 0-127 | Degree of distortion |
| Amp Sim Sw | OFF, ON | Turns the amp simulator on/off. |
| Amp Type | SMALL, BUILT-IN, 2-STACK, 3-STACK | Type of guitar amp SMALL: small amp BUILT-IN: single-unit type amp 2-STACK: large double stack amp 3-STACK: large triple stack amp |
| Distortion Level | 0-127 | Volume of the overdrive or distortion sound. |
| Mod Mode (Chorus / Flanger) | CHORUS, FLANGER | Selects whether to use chorus or flanger. |
| Mod Rate | 0.05-10.0 Hz, note | Adjusts the speed of modulation for the chorus or flanger. |
| Mod Depth | 0-127 | Adjusts the depth of modulation for the chorus or flanger. |

Effects List

| Parameter | Value | Description |
|----------------|--------------------|---|
| Mod Phase | 0–180 deg | Sets how the chorus or flanger sound is spread. |
| Mod Pre Delay | 0–50.0 ms | Adjusts the delay time from the direct sound until the chorus or flanger sound is heard. |
| Mod Feedback | -98– +98% | Adjusts the proportion of the effect sound that is fed back into the effect. Negative (-) settings will invert the phase. |
| Mod XoverLPF | 500–15000 Hz, THRU | Adjusts the cutoff frequency of the low pass filter. (THRU: no filter is used) |
| Mod XoverHPF | THRU, 50–800 Hz | Adjusts the cutoff frequency of the high pass filter. (THRU: no filter is used) |
| Mod Level | 0–127 | Volume of the chorus or flanger sound. |
| Delay Time | 0–1300 ms, note | Adjusts the delay time from the direct sound until the delay sound is heard. |
| Delay Feedback | -98– +98% | Adjusts the proportion of the delay sound that is fed back into the effect. Negative (-) settings will invert the phase. |
| Hi Damp Freq | 500–15000 Hz, THRU | Adjusts the frequency above which sound fed back to the effect will be cut. High Damp, by attenuating the higher frequencies first, makes the delay sound more natural. |
| Delay Level | 0–127 | Volume of the delay sound. |

35: Bass Multi

Bass Multi provides Comp/Limiter, Overdrive or Distortion, 3-band equalizer, and Chorus or Flanger effects connected in series. This algorithm is a multi-effects for bass.

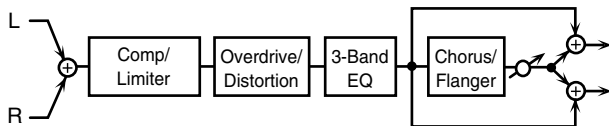

| Parameter | Value | Description |
|--------------------|------------------------|--|
| Comp Sw | OFF, ON | Turns the comp/limiter on/off. |
| Comp Thresh-old #1 | -60–0 dB | Sets the volume level at which the compression begins. |
| Comp Attack | 0–127 | Sets the time after the sound volume is crossed the compressor threshold until compression begins. |
| Comp Release | 0–127 | Specifies the time from when the volume drops below the compressor threshold until compression is no longer applied. |
| Comp Ratio | 1.5:1, 2:1, 4:1, 100:1 | Sets the “source sound:output sound” compression ratio. |
| Comp Gain | -60– +12 dB | Adjusts the output gain. |
| Distortion Sw | OFF, ON | Selects whether to use overdrive or distortion. |
| Drive Mode | OD, DS | Selects whether to use overdrive (OD) or distortion (DS). |
| Drive | 0–127 | Degree of distortion |
| Amp Sim Sw | OFF, ON | Turns the amp simulator on/off. |

| Parameter | Value | Description |
|-----------------------------|-----------------------------------|--|
| Amp Type | SMALL, BUILT-IN, 2-STACK, 3-STACK | Type of guitar amp SMALL: small amp BUILT-IN: single-unit type amp 2-STACK: large double stack amp 3-STACK: large triple stack amp |
| Distortion Level | 0–127 | Volume of the overdrive or distortion sound. |
| EQ Low Freq | 50–4000 Hz | Frequency of the low range |
| EQ Low Gain | -15– +15 dB | Gain of the low range |
| EQ Mid Freq | 50–20000 Hz | Frequency of the middle range |
| EQ Mid Q | 0.5, 0.7, 1.0, 2.0, 4.0, 8.0 | Gain of the middle range Set a higher value for Q to narrow the range to be affected. |
| EQ Mid Gain | -15– +15 dB | Gain of the middle range |
| EQ Hi Freq | 2000–20000 Hz | Frequency of the high range |
| EQ Hi Gain | -15– +15 dB | Gain of the high range |
| Mod Mode (Chorus / Flanger) | CHORUS, FLANGER | Selects whether to use chorus or flanger. |
| Mod Rate | 0.05–10.0 Hz, note | Adjusts the speed of modulation for the chorus or flanger. |
| Mod Depth | 0–127 | Adjusts the depth of modulation for the chorus or flanger. |
| Mod Phase | 0–180 deg | Sets how the chorus or flanger sound is spread. |
| Mod Pre Delay | 0–50.0 ms | Adjusts the delay time from the direct sound until the chorus or flanger sound is heard. |
| Mod Feedback | -98– +98% | Adjusts the proportion of the effect sound that is fed back into the effect. Negative (-) settings will invert the phase. |
| Mod XoverLPF | 500–15000 Hz, THRU | Adjusts the cutoff frequency of the low pass filter. (THRU: no filter is used) |
| Mod XoverHPF | THRU, 50–800 Hz | Adjusts the cutoff frequency of the high pass filter. (THRU: no filter is used) |
| Mod Level | 0–127 | Volume of the chorus or flanger sound. |

36: EP Multi

Enhancer, Phaser, Chorus or Flanger, and Tremolo or Auto-pan are connected in series. This effect is used for electric piano.

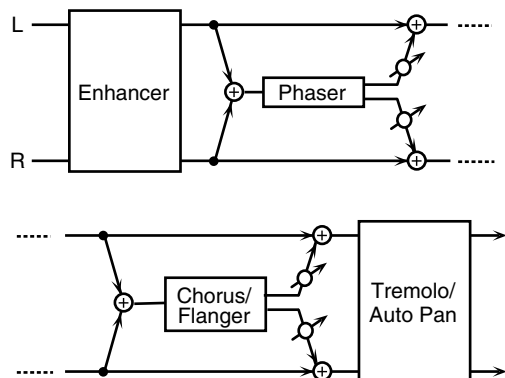

| Parameter | Value | Description |
|-----------------------------|--------------------|---|
| Enhan Sw | OFF, ON | Turns the enhancer effect on/off. |
| Enhan Sens | 0–127 | Sensitivity of the enhancer |
| Enhan Frequency | 0–127 | Sets the lower limit of the frequencies to which the enhancement effect is added. |
| Enhan Mix Level | 0–127 | Level of the overtones generated by the enhancer |
| Enhan Level | 0–127 | Volume of the enhancer sound |
| Phaser Manual | 0–127 | Specifies the center frequency at which the sound is modulated. |
| Phaser Rate | 0.05–10.0 Hz, note | Specifies the frequency of modulation. |
| Phaser Depth | 0–127 | Specifies the depth of modulation. |
| Phaser Resonance | 0–127 | Specifies the amount of feedback for the phaser. Higher settings will give the sound a stronger character. |
| Phaser Mix Level | 0–127 | Specifies the volume of the phase-shifted sound, relative to the direct sound. |
| Mod Mode (Chorus / Flanger) | CHORUS, FLANGER | Selects whether to use chorus or flanger. |
| Mod Rate | 0.05–10.0 Hz, note | Adjusts the speed of modulation for the chorus or flanger. |
| Mod Depth | 0–127 | Adjusts the depth of modulation for the chorus or flanger. |
| Mod Phase | 0–180 deg | Sets how the chorus or flanger sound is spread. |
| Mod Pre Delay | 0–50.0 ms | Adjusts the delay time from the direct sound until the chorus or flanger sound is heard. |
| Mod Feedback | -98– +98% | Adjusts the proportion of the effect sound that is fed back into the effect. Negative (-) settings will invert the phase. |
| Mod XoverLPF | 500–15000 Hz, THRU | Adjusts the cutoff frequency of the low pass filter. (THRU: no filter is used) |
| Mod XoverHPF | THRU, 50–800 Hz | Adjusts the cutoff frequency of the high pass filter. (THRU: no filter is used) |

| Parameter | Value | Description |
|---------------|-----------------------------|--|
| Mod Level | 0–127 | Volume of the chorus or flanger sound. |
| Trem/Pan Sw | OFF, ON | Turns the tremolo/auto pan effect on/off. |
| Trem Mode | TREMOLO, AUTO PAN | Selects whether to use tremolo or auto pan. |
| Trem Waveform | TRI, SAWUP, SAWDN, SQR, SIN | Selects the type of modulation. TRI: Triangle wave SAWUP/SAWDN: Sawtooth Wave SQR: Square wave SIN: Sine wave |
| | SAWUP SAWDN | |
| Trem Rate | 0.05–10.0 Hz, note | Frequency of modulation |
| Trem Depth | 0–127 | Depth of modulation |

37: Keyboard Multi

A ring modulator, 3-band equalizer, pitch shifter, phaser, and delay are connected in series.

Ring Modulator is an effect which applies ring modulation using an internal oscillator to the input signal, producing bell-like sounds.

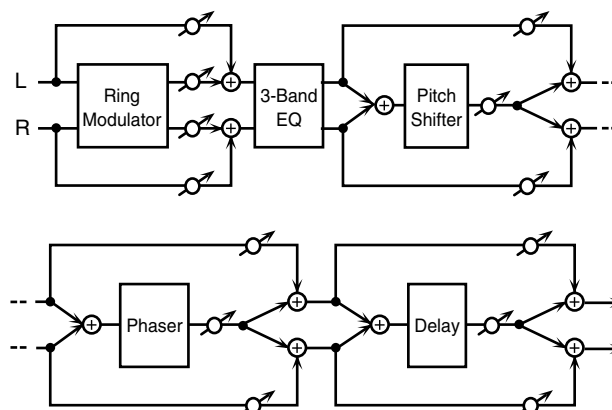

| Parameter | Value | Description |
|-----------------|------------------------------|--|
| Ring Freq | 0–127 | Frequency at which modulation will be applied |
| Ring Balance #1 | DRY100:0WET–DRY0:100WET | Volume balance between the direct sound (DRY) and the ring modulated sound (WET) |
| EQ Low Freq | 50–4000 Hz | Frequency of the low range |
| EQ Low Gain | -15– +15 dB | Gain of the low range |
| EQ Mid Freq | 50–20000 Hz | Frequency of the middle range |
| EQ Mid Q | 0.5, 0.7, 1.0, 2.0, 4.0, 8.0 | Gain of the middle range Set a higher value for Q to narrow the range to be affected. |
| EQ Mid Gain | -15– +15 dB | Gain of the middle range |
| EQ Hi Freq | 2000–20000 Hz | Frequency of the high range |
| EQ Hi Gain | -15– +15 dB | Gain of the high range |

Effects List

| Parameter | Value | Description |
|------------------|-----------------------------|--|
| PS Grade | 1–5 | Sets the grade of the effect sound. The higher the value is set, the more natural-sounding can be obtained; however, this increases the delay from the source sound as well. |
| PS Coarse | -12– +12 semitone | Specifies the pitch shift amount in semitone steps. |
| PS Fine | -100– +100 cent | Adjusts the pitch shift amount in 2-cent steps (1 cent = 1/100 of a semitone). |
| PS Balance | DRY100:0WET– DRY0:100WET | Volume balance between the direct sound (DRY) and the effect sound (WET) |
| Phaser Manual | 0–127 | Specifies the center frequency at which the sound is modulated. |
| Phaser Rate | 0.05–10.0 Hz, note | Specifies the frequency of modulation. |
| Phaser Depth | 0–127 | Specifies the depth of modulation. |
| Phaser Resonance | 0–127 | Specifies the amount of feedback for the phaser. Higher settings will give the sound a stronger character. |
| Phaser Mix Level | 0–127 | Specifies the volume of the phase-shifted sound, relative to the direct sound. |
| Delay Time | 0–650 ms, note | Adjusts the delay time from the direct sound until the delay sound is heard. |
| Delay Feedback | -98– +98% | Adjusts the proportion of the delay sound that is fed back into the effect. Negative (-) settings will invert the phase. |
| Low Damp Freq | 50–4000 Hz | Adjusts the frequency below which sound fed back to the effect will be cut. The Low Damp function damps the low frequency band of the delay sound quicker than other bands, which makes for a clearer delay effect. |
| Low Damp Gain | -36–0 dB | Degree of Low Damp |
| Hi Damp Freq | 2000–20000 Hz | Adjusts the frequency above which sound fed back to the effect will be cut. High Damp, by attenuating the higher frequencies first, makes the delay sound more natural. |
| Hi Damp Gain | -36–0 dB | Degree of High Damp |
| Delay Level | 0–127 | Volume of the delay sound. |

38: Phonograph

This effect reproduces the sound of an analog record played on a record player. This includes the various noises with the characteristic of records and the uneven rotation of older turntables.

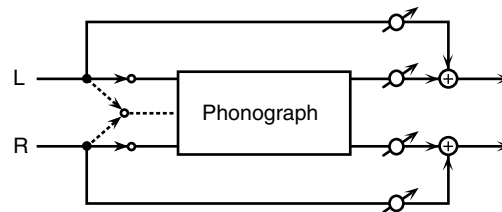

| Parameter | Value | Description |
|---|-----------------------------|--|
| Input Mode | MONO, STEREO | Use this setting to select either a stereo or monaural record player for the effect. |
| Signal Dist | 0–127 | Degree of distortion |
| Frequency Range | 0–127 | Sets the frequency response of the record player. Lowering the value degrades the frequency characteristics, making the sound resemble that from an older system. |
| Disk Type | LP, EP, SP | Sets the turntable rotation speed. LP: 33 1/3 r.p.m. EP: 45 r.p.m. SP: 78 r.p.m. |
| Total Noise #1 | 0–127 | Total noise level. |
| Scratch | 0–127 | Scratches on the record. |
| Dust | 0–127 | Dust on the record. |
| Hiss | 0–127 | Continuous hissing noise. |
| * These settings add the typical record's noise. The noises increase as the values are raised. Set each of the Scratch, Dust, and Hiss noise levels to get a balance, then adjust the overall amount of noise with the Total Noise Level control. | | |
| Total Wow/Flutter #2 | 0–127 | Total wow and flutter. |
| Wow | 0–127 | Wow, long cycle rotational irregularity. |
| Flutter | 0–127 | Flutter, short cycle rotational irregularity. |
| Random | 0–127 | Random rotational irregularity. |
| These settings determine the rotational irregularities of the record player. Set each of the Wow, Flutter, and Random levels to get a balance, then adjust the overall depth of the effect with the Total Wow/Flutter control. | | |
| Balance | DRY100:0WET– DRY0:100WET | Volume balance between the direct sound (DRY) and the effect sound (WET) |

39: Radio Tuning

This effect reproduces the sound of an AM radio playing.

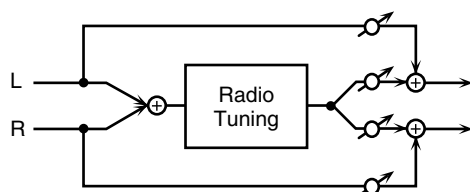

| Parameter | Value | Description |
|--------------------|-------------------------|---|
| Tuning #1 | -50- +50 | Adjusts the degree of noise that occurs when tuning a radio. |
| Noise Level #2 | 0-127 | Sets the noise level. |
| Frequency Range #3 | 0-127 | Sets the frequency response of the radio. Lowering the value worsens the frequency characteristics, making the sound appear to be coming from a tiny radio speaker. |
| Balance | DRY100:0WET-DRY0:100WET | Volume balance between the direct sound (DRY) and the effect sound (WET) |

40: Bit Rate Converter

By changing the bit count and sample rate, this effect recreates the Lo-Fi (Low-Fidelity) sounds of the early digital samplers and similar machines. After the Lo-Fi processor, a filter to change the tone is arranged in series.

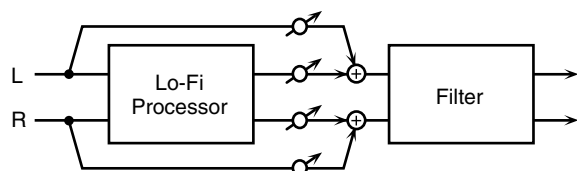

| Parameter | Value | Description |
|----------------|--------------------------------|--|
| Pre Filter Sw | OFF, ON | This is the switch of the filter placed before the Lo-Fi processing |
| Sample Rate | 1/1, 1/2, 1/4, 1/8, 1/16, 1/32 | Sets the fraction of current sampling rates to be used for processing. |
| Bit Down | 0-15 | This setting is for reducing the bit count. |
| Post Filter Sw | OFF, ON | This is the switch of the filter placed after the Lo-Fi processing. |
| Balance | DRY100:0WET-DRY0:100WET | Volume balance between the direct sound (DRY) and the effect sound (WET) |

| Parameter | Value | Description |
|------------------|----------------------------|--|
| Filter Type | THRU, LPF, BPF, HPF, NOTCH | Type of filter THRU: no filter is used LPF: Passes frequencies below the Cutoff. BPF: Passes frequencies near the Cutoff. HPF: Passes frequencies above the Cutoff. NOTCH: Passes frequencies other than those near the Cutoff. |
| | | |
| Filter Slope | -12, -24 dB/O | Filter's attenuation slope -24 dB per octave: steep -12 dB per octave: gentle |
| Filter Cutoff | 0-127 | Cutoff frequency of the filter The closer to zero it is set, the lower the cutoff frequency becomes; set it closer to 127, and the cutoff frequency becomes higher. |
| Filter Resonance | 0-127 | Resonance level of the filter Raising the setting increases resonance near the cutoff frequency, giving the sound a special characteristic. |
| Filter Gain | 0- +24 dB | Compensates for the volume dropped in the cut frequency range with some filters. The level of compensation increases as the value is increased, and raise the volume. |

41: Pseudo Stereo

Spreads the components of the monaural input sound to left and right, creating an artificial sense of stereo output.

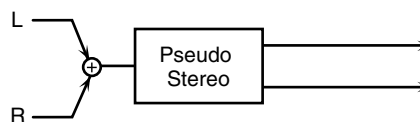

| Parameter | Value | Description |
|-----------|-------|---------------------------------|
| Depth #1 | 0-15 | Spaciousness of the sound field |

Chorus Parameters

The functions of Chorus parameters are explained.

Chorus Type

01: Chorus 1

This conventional chorus effect adds spaciousness and depth to the sound. Slow modulation frequency with less depth.

02:Chorus 2

This conventional chorus effect adds spaciousness and depth to the sound. Rapid modulation frequency with less depth.

03: Chorus 3

This conventional chorus effect adds spaciousness and depth to the sound. Slow modulation frequency with more depth.

04: Chorus 4

This conventional chorus effect adds spaciousness and depth to the sound. Rapid modulation frequency with more depth.

05: Feedback Chorus

This chorus offers a flanger-like effect, creating a soft sound.

06: Flanger

This effect sounds somewhat like a jet airplane taking off and landing.

07: Short Delay

This is a delay with a short delay time.

08: Fbk Short Delay

This is a short delay with many repeats.

Chorus Parameters

| Parameter | Value | Description |
|--------------|---------------------|--|
| Pre Low Freq | 500–15000 Hz, THRU | Frequency of the low range (THRU: no filter is used) |
| Pre Hi Freq | THRU, 50–800 Hz | Frequency of the high range (THRU: no filter is used) |
| Pre Dly Time | 0.0–50.0 ms | Adjusts the delay time from the direct sound until the chorus sound is heard. |
| Co LPF Freq | 500–15000 Hz, THRU | Adjusts the cutoff frequency of the low pass filter. (THRU: no filter is used) The effect will be applied to the frequency range below the cutoff frequency. |
| Co HPF Freq | THRU, 50–800 Hz | Adjusts the cutoff frequency of the high pass filter. (THRU: no filter is used) The effect will be applied to the frequency range above the cutoff frequency. |
| Rate | 0.05–10.00 Hz, note | Sets the cycle for the chorus or flanger sound undulations. |
| Depth | 0–127 | Adjusts the depth of modulation for the chorus or flanger. |
| Feedback | -98– +98% | Adjusts the proportion of the effect sound that is fed back into the effect. Negative (-) settings will invert the phase. |
| Cho/Flg Sw | CHORUS, FLANGER | Selects either chorus or flanger. |

Reverb Parameters

The functions of Reverb parameters are explained.



Explanations for each Reverb Type are given on the following pages.

| | |
|----------------|----------|
| 01: Room 1 | (p. 187) |
| 02: Room 2 | (p. 187) |
| 03: Room 3 | (p. 188) |
| 04: Hall 1 | (p. 188) |
| 05: Hall 2 | (p. 189) |
| 06: Hall 3 | (p. 189) |
| 07: Garage | (p. 190) |
| 08: Plate | (p. 190) |
| 09: Non-Linear | (p. 191) |
| 10: Delay | (p. 191) |

01: Room 1

Reverb which simulates the reverberation within a room. It is standard room reverb.

| Parameter | Value | Description |
|-----------------|------------------------------|--|
| Pre Low Freq | 50–4000 Hz | Frequency of the low range |
| Pre Low Gain | -15– +15 dB | Gain of the low range |
| Pre Mid Freq | 50–20000 Hz | Frequency of the middle range |
| Pre Mid Q | 0.5, 0.7, 1.0, 2.0, 4.0, 8.0 | Gain of the middle range Set a higher value for Q to narrow the range to be affected. |
| Pre Mid Gain | -15– +15 dB | Gain of the middle range |
| Pre Hi Freq | 2000–20000 Hz | Frequency of the high range |
| Pre Hi Gain | -15– +15 dB | Gain of the high range |
| Low Rev Time | 0.06–32.0 sec | Duration (time) of the reverb for the low frequency band |
| Hi Rev Time | 0.06–32.0 sec | Duration (time) of the reverb for the high frequency band |
| Xover Freq | 160–15000 Hz, THRU | The reverberation specified by the Low Rev Time will be applied to the range below this frequency, and by the Hi Rev Time to the range above this frequency. |
| Pre Dly Time | 0–200.0 ms | Adjusts the delay time from the direct sound until the delay sound is heard. |
| Density | 0–99 | Density of the reverb |
| Room Size | 5.6–32.6 m | Size of the room which is simulated |
| Early Ref Level | 0–99 | Volume level of the initial reflected sound |
| Release Density | 0–99 | Density of the sound that reaches the listener after many repeated reflections |
| Low Damp Freq | 50–4000 Hz | Adjusts the frequency below which sound fed back to the effect will be cut. The Low Damp function damps the low frequency band of the reverb sound quicker than other bands. |
| Low Damp Gain | -36–0 dB | Degree of Low Damp |
| Hi Damp Freq | 2000–20000 Hz | Adjusts the frequency above which sound fed back to the effect will be cut. High Damp, by attenuating the higher frequencies first. |
| Hi Damp Gain | -36–0 dB | Degree of High Damp |
| Post HC Freq | 160–15000 Hz, THRU | Frequency at which the high cut filter will begin to take effect (THRU: no filter is used) |

02: Room 2

This simulates the reverberation of a room. It is suitable for simulating a fairly small room, and produces a clear reverberation.

| Parameter | Value | Description |
|-----------------|------------------------------|--|
| Pre Low Freq | 50–4000 Hz | Frequency of the low range |
| Pre Low Gain | -15– +15 dB | Gain of the low range |
| Pre Mid Freq | 50–20000 Hz | Frequency of the middle range |
| Pre Mid Q | 0.5, 0.7, 1.0, 2.0, 4.0, 8.0 | Gain of the middle range Set a higher value for Q to narrow the range to be affected. |
| Pre Mid Gain | -15– +15 dB | Gain of the middle range |
| Pre Hi Freq | 2000–20000 Hz | Frequency of the high range |
| Pre Hi Gain | -15– +15 dB | Gain of the high range |
| Reverb Time | 0.06–32.00 sec | Duration (time) of the reverb |
| Pre Dly Time | 0.0–200.0 ms | Adjusts the delay time from the direct sound until the delay sound is heard. |
| Density | 0–99 | Density of the reverb |
| Room Size | 1–10 | Size of the room which is simulated |
| Early Ref Level | 0–99 | Volume level of the initial reflected sound |
| Low Damp Freq | 50–4000 Hz | Adjusts the frequency below which sound fed back to the effect will be cut. The Low Damp function damps the low frequency band of the reverb sound quicker than other bands. |
| Low Damp Gain | -36–0 dB | Degree of Low Damp |
| Hi Damp Freq | 2000–20000 Hz | Adjusts the frequency above which sound fed back to the effect will be cut. High Damp, by attenuating the higher frequencies first. |
| Hi Damp Gain | -36–0 dB | Degree of High Damp |
| Post HC Freq | 160–15000 Hz, THRU | Frequency at which the high cut filter will begin to take effect (THRU: no filter is used) |

03: Room 3

Reverb which simulates the reverberation within a room. This is suitable for simulating a fairly large room, and produces reverberation with a strong mid and low range.

| Parameter | Value | Description |
|-----------------|------------------------------|--|
| Pre Low Freq | 50–4000 Hz | Frequency of the low range |
| Pre Low Gain | -15– +15 dB | Gain of the low range |
| Pre Mid Freq | 50–20000 Hz | Frequency of the middle range |
| Pre Mid Q | 0.5, 0.7, 1.0, 2.0, 4.0, 8.0 | Gain of the middle range Set a higher value for Q to narrow the range to be affected. |
| Pre Mid Gain | -15– +15 dB | Gain of the middle range |
| Pre Hi Freq | 2000–20000 Hz | Frequency of the high range |
| Pre Hi Gain | -15– +15 dB | Gain of the high range |
| Reverb Time | 0.06–32.00 sec | Duration (time) of the reverb |
| Pre Dly Time | 0.0–200.0 ms | Adjusts the delay time from the direct sound until the delay sound is heard. |
| Density | 0–99 | Density of the reverb |
| Room Size | 1–8 | Size of the room which is simulated |
| Early Ref Level | 0–99 | Volume level of the initial reflected sound |
| Release Density | 0–99 | Density of the sound that reaches the listener after many repeated reflections |
| Low Damp Freq | 50–4000 Hz | Adjusts the frequency below which sound fed back to the effect will be cut. The Low Damp function damps the low frequency band of the reverb sound quicker than other bands. |
| Low Damp Gain | -36–0 dB | Degree of Low Damp |
| Hi Damp Freq | 2000–20000 Hz | Adjusts the frequency above which sound fed back to the effect will be cut. High Damp, by attenuating the higher frequencies first. |
| Hi Damp Gain | -36–0 dB | Degree of High Damp |
| Post HC Freq | 160–15000 Hz, THRU | Frequency at which the high cut filter will begin to take effect (THRU: no filter is used) |

04: Hall 1

This simulates the reverberation of a concert hall. It is a conventional hall reverb. You can also apply a chorus effect to the reverberation to adjust the sense of spaciousness or to create a special effect.

| Parameter | Value | Description |
|-----------------|------------------------------|--|
| Pre Low Freq | 50–4000 Hz | Frequency of the low range |
| Pre Low Gain | -15– +15 dB | Gain of the low range |
| Pre Mid Freq | 50–20000 Hz | Frequency of the middle range |
| Pre Mid Q | 0.5, 0.7, 1.0, 2.0, 4.0, 8.0 | Gain of the middle range Set a higher value for Q to narrow the range to be affected. |
| Pre Mid Gain | -15– +15 dB | Gain of the middle range |
| Pre Hi Freq | 2000–20000 Hz | Frequency of the high range |
| Pre Hi Gain | -15– +15 dB | Gain of the high range |
| Low Rev Time | 0.06–64.00 sec | Duration (time) of the reverb for the low frequency band. |
| Hi Rev Time | 0.06–64.00 sec | Duration (time) of the reverb for the high frequency band |
| Xover Freq | 160–15000 Hz, THRU | The reverberation specified by the Low Rev Time will be applied to the range below this frequency, and by the Hi Rev Time to the range above this frequency. |
| Pre Dly Time | 0.0–200.0 ms | Adjusts the delay time from the direct sound until the delay sound is heard. |
| Density | 0–99 | Density of the reverb |
| Room Size | 5.6–40.4 m | Size of the room which is simulated |
| Early Ref Level | 0–99 | Volume level of the initial reflected sound |
| Release Density | 0–99 | Density of the sound that reaches the listener after many repeated reflections |
| Low Damp Freq | 50–4000 Hz | Adjusts the frequency below which sound fed back to the effect will be cut. The Low Damp function damps the low frequency band of the reverb sound quicker than other bands. |
| Low Damp Gain | -36–0 dB | Degree of Low Damp |
| Hi Damp Freq | 2000–20000 Hz | Adjusts the frequency above which sound fed back to the effect will be cut. High Damp, by attenuating the higher frequencies first. |
| Hi Damp Gain | -36–0 dB | Degree of High Damp |
| Post HC Freq | 160–15000 Hz, THRU | Frequency at which the high cut filter will begin to take effect (THRU: no filter is used) |
| Chorus Rate | 0–127 | Rate of modulation for the reverb |
| Chorus Depth | 0–127 | Depth of modulation for the reverb |

05: Hall 2

Simulates the reverberation in a concert hall. This is suitable for simulating a smaller room, and produces a clear reverberation.

| Parameter | Value | Description |
|-----------------|------------------------------|--|
| Pre Low Freq | 50–4000 Hz | Frequency of the low range |
| Pre Low Gain | -15– +15 dB | Gain of the low range |
| Pre Mid Freq | 50–20000 Hz | Frequency of the middle range |
| Pre Mid Q | 0.5, 0.7, 1.0, 2.0, 4.0, 8.0 | Gain of the middle range Set a higher value for Q to narrow the range to be affected. |
| Pre Mid Gain | -15– +15 dB | Gain of the middle range |
| Pre Hi Freq | 2000–20000 Hz | Frequency of the high range |
| Pre Hi Gain | -15– +15 dB | Gain of the high range |
| Reverb Time | 0.06–64.00 sec | Duration (time) of the reverb |
| Pre Dly Time | 0.0–200.0 ms | Adjusts the delay time from the direct sound until the delay sound is heard. |
| Density | 0–99 | Density of the reverb |
| Room Size | 1–10 | Size of the room which is simulated |
| Early Ref Level | 0–99 | Volume level of the initial reflected sound |
| Low Damp Freq | 50–4000 Hz | Adjusts the frequency below which sound fed back to the effect will be cut. The Low Damp function damps the low frequency band of the reverb sound quicker than other bands. |
| Low Damp Gain | -36–0 dB | Degree of Low Damp |
| Hi Damp Freq | 2000–20000 Hz | Adjusts the frequency above which sound fed back to the effect will be cut. High Damp, by attenuating the higher frequencies first. |
| Hi Damp Gain | -36–0 dB | Degree of High Damp |
| Post HC Freq | 160–15000 Hz, THRU | Frequency at which the high cut filter will begin to take effect (THRU: no filter is used) |

06: Hall 3

Simulates the reverberation in a concert hall. This is suitable for simulating a fairly large room, and produces reverberation with a strong mid and low range.

| Parameter | Value | Description |
|-----------------|------------------------------|--|
| Pre Low Freq | 50–4000 Hz | Frequency of the low range |
| Pre Low Gain | -15– +15 dB | Gain of the low range |
| Pre Mid Freq | 50–20000 Hz | Frequency of the middle range |
| Pre Mid Q | 0.5, 0.7, 1.0, 2.0, 4.0, 8.0 | Gain of the middle range Set a higher value for Q to narrow the range to be affected. |
| Pre Mid Gain | -15– +15 dB | Gain of the middle range |
| Pre Hi Freq | 2000–20000 Hz | Frequency of the high range |
| Pre Hi Gain | -15– +15 dB | Gain of the high range |
| Reverb Time | 0.06–64.0 sec | Duration (time) of the reverb |
| Pre Dly Time | 0.0–200.0 ms | Adjusts the delay time from the direct sound until the delay sound is heard. |
| Density | 0–99 | Density of the reverb |
| Room Size | 1–8 | Size of the room which is simulated |
| Early Ref Level | 0–99 | Volume level of the initial reflected sound |
| Release Density | 0–99 | Density of the sound that reaches the listener after many repeated reflections |
| Low Damp Freq | 50–4000 Hz | Adjusts the frequency below which sound fed back to the effect will be cut. The Low Damp function damps the low frequency band of the reverb sound quicker than other bands. |
| Low Damp Gain | -36–0 dB | Degree of Low Damp |
| Hi Damp Freq | 2000–20000 Hz | Adjusts the frequency above which sound fed back to the effect will be cut. High Damp, by attenuating the higher frequencies first. |
| Hi Damp Gain | -36–0 dB | Degree of High Damp |
| Post HC Freq | 160–15000 Hz, THRU | Frequency at which the high cut filter will begin to take effect (THRU: no filter is used) |

Effects List

07: Garage

This simulates the reverberation of a garage. It produces the reverberation of a room surrounded by hard-surfaced walls with many reflections.

| Parameter | Value | Description |
|-----------------|------------------------------|--|
| Pre Low Freq | 50–4000 Hz | Frequency of the low range |
| Pre Low Gain | -15– +15 dB | Gain of the low range |
| Pre Mid Freq | 50–20000 Hz | Frequency of the middle range |
| Pre Mid Q | 0.5, 0.7, 1.0, 2.0, 4.0, 8.0 | Gain of the middle range Set a higher value for Q to narrow the range to be affected. |
| Pre Mid Gain | -15– +15 dB | Gain of the middle range |
| Pre Hi Freq | 2000–20000 Hz | Frequency of the high range |
| Pre Hi Gain | -15– +15 dB | Gain of the high range |
| Reverb Time | 0.06–32.00 sec | Duration (time) of the reverb |
| Pre Dly Time | 0.0–200.0 ms | Adjusts the delay time from the direct sound until the delay sound is heard. |
| Density | 0–99 | Density of the reverb |
| Room Size | 1–8 | Size of the room which is simulated |
| Early Ref Level | 0–99 | Volume level of the initial reflected sound |
| Release Density | 0–99 | Density of the sound that reaches the listener after many repeated reflections |
| Low Damp Freq | 50–4000 Hz | Adjusts the frequency below which sound fed back to the effect will be cut. The Low Damp function damps the low frequency band of the reverb sound quicker than other bands. |
| Low Damp Gain | -36–0 dB | Degree of Low Damp |
| Hi Damp Freq | 2000–20000 Hz | Adjusts the frequency above which sound fed back to the effect will be cut. High Damp, by attenuating the higher frequencies first. |
| Hi Damp Gain | -36–0 dB | Degree of High Damp |
| Post HC Freq | 160–15000 Hz, THRU | Frequency at which the high cut filter will begin to take effect (THRU: no filter is used) |

08: PLATE

Simulates plate reverberation (a reverb unit that uses the vibration of a metallic plate).

| Parameter | Value | Description |
|-----------------|------------------------------|--|
| Pre Low Freq | 50–4000 Hz | Frequency of the low range |
| Pre Low Gain | -15– +15 dB | Gain of the low range |
| Pre Mid Freq | 50–20000 Hz | Frequency of the middle range |
| Pre Mid Q | 0.5, 0.7, 1.0, 2.0, 4.0, 8.0 | Gain of the middle range Set a higher value for Q to narrow the range to be affected. |
| Pre Mid Gain | -15– +15 dB | Gain of the middle range |
| Pre Hi Freq | 2000–20000 Hz | Frequency of the high range |
| Pre Hi Gain | -15– +15 dB | Gain of the high range |
| Low Rev Time | 0.06–32.00 sec | Duration (time) of the reverb for the low frequency band. |
| Hi Rev Time | 0.06–32.00 sec | Duration (time) of the reverb for the high frequency band |
| Xover Freq | 160–15000 Hz, THRU | The reverberation specified by the Low Rev Time will be applied to the range below this frequency, and by the Hi Rev Time to the range above this frequency. |
| Pre Dly Time | 0.0–200.0 ms | Adjusts the delay time from the direct sound until the delay sound is heard. |
| Density | 0–99 | Density of the reverb |
| Room Size | 5.6–34.7 m | Size of the room which is simulated |
| Early Ref Level | 0–99 | Volume level of the initial reflected sound |
| Release Density | 0–99 | Density of the sound that reaches the listener after many repeated reflections |
| Low Damp Freq | 50–4000 Hz | Adjusts the frequency below which sound fed back to the effect will be cut. The Low Damp function damps the low frequency band of the reverb sound quicker than other bands. |
| Low Damp Gain | -36–0 dB | Degree of Low Damp |
| Hi Damp Freq | 2000–20000 Hz | Adjusts the frequency above which sound fed back to the effect will be cut. High Damp, by attenuating the higher frequencies first. |
| Hi Damp Gain | -36–0 dB | Degree of High Damp |
| Post HC Freq | 160–15000 Hz, THRU | Frequency at which the high cut filter will begin to take effect (THRU: no filter is used) |

09: Non-Linear

This uses digital processing to create an artificial reverberation that is quite different than naturally occurring reverberation.

| Parameter | Value | Description |
|-----------------|------------------------------|---|
| Pre Low Freq | 50–4000 Hz | Frequency of the low range |
| Pre Low Gain | -15– +15 dB | Gain of the low range |
| Pre Mid Freq | 50–20000 Hz | Frequency of the middle range |
| Pre Mid Q | 0.5, 0.7, 1.0, 2.0, 4.0, 8.0 | Gain of the middle range Set a higher value for Q to narrow the range to be affected. |
| Pre Mid Gain | -15– +15 dB | Gain of the middle range |
| Pre Hi Freq | 2000–20000 Hz | Frequency of the high range |
| Pre Hi Gain | -15– +15 dB | Gain of the high range |
| NLR Type | L→R, NORMAL, L←R | Method of output panning L→R: Pan from the L channel to the R channel NORMAL: Output without panning L←R: Pan from the R channel to the L channel |
| Pre Dly Time | 0.0–200.0 ms | Adjusts the delay time from the direct sound until the delay sound is heard. |
| Density | 0–99 | Density of the reverb |
| Early Ref Level | 0–99 | Volume level of the initial reflected sound |
| Feedback Time | 0.1–1000 ms | Delay time for the feedback sound |
| Feedback Level | 0–99% | Amount of feedback |
| Post HC Freq | 160–15000 Hz, THRU | Frequency at which the high cut filter will begin to take effect (THRU: no filter is used) |
| Env Time Ratio | 10–120% | The overall time will be expanded or contracted while preserving the time ratios of the various envelope times. |
| Envelope T1–T4 | 0.1–1000 ms | Time until each point (T1–T4) is reached |
| Envelope L1–L3 | 0–100 | Output level for each point (L1–L3) <i>* If the total length of Envelope times (T1+T2+T3+T4) exceeds 1000 ms, the sound of the portion that extends beyond this will be cut.</i> |

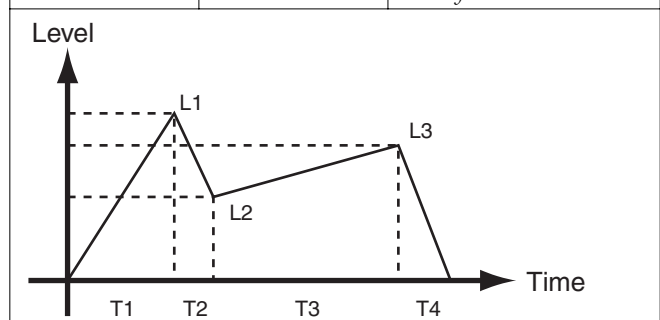

10: Delay

This is a stereo delay. Depending on the length of the delay you set, you can get long echoes, thick sounds, or spatial sounds.

| Parameter | Value | Description |
|---------------|--|---|
| Mode | MONO, STEREO, ALTERNATE | Switches stereo, monaural, or alternate. MONO: This is a single-input, dual-output delay. Stereo sound (left and right) are mixed before being input. STEREO: This is a dual-input, dual-output delay. The delay sound output features the same stereo placement as that of the input. ALTERNATE: The left and right delay sound output alternately. (Alternate delay) |
| Delay Time | 0–1300 ms (MONO), 0–650 ms (STEREO, ALTERNATE), note | Adjusts the delay time from the direct sound until the delay sound is heard. |
| L-R Shift | 0–650 ms, note | Of the left and right delay sounds, the delay time will be increased for only one side. If the L-R order is L→R, the R sound will be later. In the case of R→L, the L sound will be later. <i>* When the mode is set to MONO or ALTERNATE, this setting will be ignored.</i> |
| L-R Order | L→R, R→L | In STEREO or ALTERNATE mode, this setting determines which of the left or right sides has the delay sound before the other L→R: The left side is expressed first R→L: The right side is expressed first <i>* In MONO mode, this setting will be ignored.</i> |
| Feedback | -98– +98% | Adjusts the proportion of the delay sound that is fed back into the effect. Negative (-) settings will invert the phase. |
| Balance | DRY100:0WET–DRY0:100WET | Volume balance between the direct sound (DRY) and the delay sound (WET) |
| Low Damp Freq | 50–4000 Hz | Adjusts the frequency below which sound fed back to the effect will be cut. The Low Damp function damps the low frequency band of the delay sound quicker than other bands, which makes for a clearer delay effect. |
| Low Damp Gain | -36–0 dB | Degree of Low Damp |

Effects List

| Parameter | Value | Description |
|--------------|---------------|--|
| Hi Damp Freq | 2000–20000 Hz | Adjusts the frequency above which sound fed back to the effect will be cut. High Damp, by attenuating the higher frequencies first, makes the delay sound more natural. |
| Hi Damp Gain | -36–0 dB | Degree of High Damp |
| Ps Low Freq | 50–4000 Hz | Frequency of the low range |
| Ps Low Gain | -15– +15 dB | Gain of the low range |
| Ps Hi Freq | 2000–20000 Hz | Frequency of the high range |
| Ps Hi Gain | -15– +15 dB | Gain of the high range |

Troubleshooting

If the this unit does not function in the way you expect, first check the following points. If this does not resolve the problem, consult your dealer or a nearby Roland Service Station.

* If a message appears during operation, consult the following section **“Message List”** (p. 197).

Problems Related to the V-Synth XT

| Problem | Cause | Action |
|--|--|---|
| Power does not turn on | Is the AC cord connected correctly to the V-Synth XT and to an AC outlet? | Check the AC cord connections. |
| No Sound/Volume is low | Is the power of the connected devices turned on? | Make sure that the power of your amp or mixer system is turned on. |
| | Is the volume turned down? | Check the volume of the V-Synth XT and of the connected amp or mixer. |
| | Is there sound in the headphones? | If there is sound in the headphones, it is possible that the connection cables are broken, or that the amp or mixer is malfunctioning. Check the connection cables and your other equipment once again. |
| | Is the Patch level set too low? | Check the Level parameter setting (p. 94). |
| | Are the Effect settings correct? | Check the Effect settings ON or OFF, in the Effect Balance or Level (p. 97). |
| | Are the settings for the output destination correct? | Check the output assign settings (p. 97). |
| | Have volume messages been received from an external MIDI device to lower the volume? | Check the volume. |
| | Could the oscillator be off? | Turn on the [OSC1] or [OSC2]. |
| | Could the V-Synth XT be set to USB communication in Storage function? | Cancel USB communication (p. 140, p. 142). |
| | Does the MIDI channel of the transmitting device (e.g., MIDI keyboard) match the MIDI channel of the V-Synth XT? | Set the transmitting device (e.g., MIDI keyboard) and the V-Synth XT to the same MIDI channel. Check the “Part MIDI” (p. 126) parameter setting. |
| The volume level of the instrument connected to INPUT Jacks is too low. | Could you be using a connection cable that contains a resistor? | Use a connection cable that does not contain a resistor. |
| | Is the “INPUT Jack Gain” (p. 126) setting correct? | Check the “INPUT Jack Gain” (p. 126) setting. |
| No sound from a device connected to the INPUT jacks (or MIC jack) | Is the “MIC Jack Switch” (p. 126) or “INPUT Jack Switch” (p. 126) setting correct? | Check the “INPUT Jack Switch” (p. 126) or “INPUT Jack Switch” (p. 126) setting. |
| Pitch is wrong | Are the Pitch settings of the Oscillator section correct? | Check the Coarse Tune/Fine Tune parameter settings (p. 85). |
| | Is the Master Tune setting correct? | Check the Master Tune parameter setting (p. 123). |
| | Has a Pitch Bend message been received from an external device, leaving the pitch “hanging?” | Try moving the pitch bend lever of the connected MIDI keyboard. |
| Sound is distorted | Is an effect which distorts the sound being applied? | Check the effect settings (p. 164). |
| | Has the Patch level been turned up? | Check the Level parameter setting (p. 94). |
| Effects do not apply | [MFX], [CHO], or [REV] effect switches may have been turned off. | Turn them on. |
| | Are the various effect settings correct? | If the send level of each effect is set to 0, the effect will not be applied. Check the settings (p. 97). Even with send levels to each effect set at 0, effects are not applied if the MFX Master Level, the Chorus Master Level, or the Reverb Master Level is set to 0. Check each setting (p. 97). If Output Assign is set to other than “MULTI,” the MFX sound will not be output (p. 97). |
| | | |
| Oscillator Type has been to “EXT IN,” but no sound is heard when audio is input through the INPUT jacks (or MIC jack) | If the oscillator is set to external input (EXT IN), you will not hear sound unless you play the MIDI keyboard. | Try playing the MIDI keyboard. |
| | Is the “External Input Source” (p. 123) setting correct? | Check the “External Input Source” (p. 123) setting. |
| | Is the “MIC Jack Switch” (p. 126) or “INPUT Jack Switch” (p. 126) setting correct? | Check the “MIC Jack Switch” (p. 126) or “INPUT Jack Switch” (p. 126) setting. |

Troubleshooting

| Problem | Cause | Action |
|---|---|--|
| No sound from connected MIDI device | Is the instrument set to transmit MIDI messages? | Check the Patch Tx Ch parameter setting (p. 127). |
| | Does the MIDI transmit channel for the V-Synth XT match the MIDI receive channel for the connected MIDI device? | Check the Patch Tx Ch parameter setting (p. 127). |
| Exclusive messages are not received | Is the instrument set to receive Exclusive messages? | Set the Rx Sys-Ex parameter to ON (p. 125). |
| | Does the Device ID number of the transmitting device match the Device ID number of the V-Synth XT? | Check the Device ID parameter setting (p. 125). |
| Noise is heard while sampling | During sampling, the output frequency of the digital audio interface is fixed at 44.1 kHz, regardless of the System mode setting. Noise may be heard from connected devices at this time. | This is not a malfunction. |
| Can't edit or encode a wave | Could you have selected a preset wave? | The V-Synth XT's factory-loaded preset waves cannot be edited or encoded. Select a sample that you've sampled or imported. |
| Beep tone was turned off, but it continues to sound the next time power is turned on | The Power-up Mode is set to "Default." | Change it to "Last Set" and save the System settings (p. 123). |

Problems Related to the USB Driver (Windows)

| Problem | Cause | Action |
|--|--|--|
| When I start (or restart) my computer with the V-Synth XT connected via USB, it freezes at the startup screen and fails to work | It has been found that on some computers, starting (or restarting) the computer while the V-Synth XT is powered up and USB is connected will cause the computer to freeze at the startup screen and fail to work. | Switch off the V-Synth XT and then restart your computer. |
| When I turned off the power of the V-Synth XT, an error occurred in Windows | When using Windows Me, powering down the V-Synth XT without unmounting the drive may cause an error to occur in Windows. | You must cancel the USB connection (p. 140) before you turn off the power of the V-Synth XT. |
| When I attempt to exit Windows while leaving the V-Synth XT powered up, the computer does not turn off | On some Windows computers, it has been reported that the computer cannot be powered down if you exit Windows when the V-Synth XT is still powered up (without unmounting the drive). (The shutdown process halts before the computer's power is switched off.) | You must cancel the USB connection (p. 140) before you turn off the power of the V-Synth XT before you exit Windows. |
| When I connect the V-Synth XT via USB and wake up my computer from Suspend, it stops functioning | On some computers, waking up the computer from the Suspend state while a powered-up V-Synth XT is connected via USB will cause the computer to freeze. | Before you Suspend your computer, power down the V-Synth XT using the procedure described on p. 140. |
| V-Synth XT drive is not mounted in Windows XP | If a network drive is mounted in Windows XP, that drive number may conflict with the V-Synth XT drive, causing the V-Synth XT drive to not be recognized. | Change the assignment of the network drive. |
| "Find new hardware wizard" does not execute automatically The "Insert Disk" dialog box does not appear "Find new hardware wizard" ends before the process is completed <i>* It may take about 15 seconds (or more) after the USB cable is connected for the V-Synth XT to be detected.</i> | Is the USB cable connected correctly? | Make sure that the V-Synth XT and your computer are correctly connected via a USB cable. |
| | Is USB enabled on your computer? | Refer to the operation manual for your computer, and make sure that USB is enabled. |
| | Does your computer meet the USB specifications? | <p>If you are using a computer that does not fulfill the electrical requirements of the USB specifications, operation may be unstable. In this case, you may be able to solve the problem by connecting a USB hub.</p> <p>If the above actions do not solve the problem, it is possible that the V-Synth XT has been incorrectly detected by the computer. As described in "Deleting Incorrect Device Information" (p. 195), delete the incorrect device information, then re-install the driver.</p> |

| Problem | Cause | Action |
|---|--|--|
| “Found unknown device” appears even though you installed the driver | If your computer or USB hub has two or more USB connectors, and you connect the V-Synth XT to a USB connector to which the V-Synth XT has never been connected before, the “Unknown device” dialog box may appear even on a computer onto which you have already installed the driver. | Refer to Readme file on the included CD-ROM, and install the driver once again. This is not a malfunction. If the “Found unknown device” dialog box appears even though the V-Synth XT is connected to the same USB connector as before, it is possible that the computer has detected the V-Synth XT incorrectly. As described in “Deleting Incorrect Device Information” (p. 195), delete the incorrect device information, then re-install the driver. |
| An “Unknown driver found” dialog box appears, and you are unable to install the driver. Device Manager shows “?”, “!”, or “USB Composite Device”. Driver is not installed correctly. | It is possible that the computer has detected the V-Synth XT incorrectly. | As described in “Deleting Incorrect Device Information” (p. 195), delete the incorrect device information, then re-install the driver. |
| Can’t install/delete/use the driver in Windows XP/2000 | Did you log on to Windows as a user with administrative privileges? | In order to install/delete/re-install the driver in Windows XP/2000, you must be logged into Windows as a user with administrative privileges, such as Administrator. For details, please contact the system administrator for your computer system. |
| | Did you make “Driver Signing Options”? | In order to install/re-install the driver, you must make “Driver Signing Options.” |
| Windows XP/2000 displays a “Hardware Installation” or “Digital Signature Not Found” dialog box | Did you make “Driver Signing Options”? | In order to install/re-install the driver, you must make the settings described in “Driver Signing Options.” |

Deleting Incorrect Device Information

Use the following procedure to re-install the driver.

1. Turn off the power of your computer, and start up Windows with all USB cables disconnected (except for keyboard and mouse).
2. After Windows restarts, use a USB cable to connect the V-Synth XT to your computer.
3. Turn on the power of V-Synth XT.
4. Click the Windows Start button, and from the menu that appears, choose Settings | Control Panel.
5. Double-click the System icon. The System Properties dialog box will appear.
6. Click the Device Manager tab.
In Windows XP, select the System Properties Hardware tab, and click Device Manager.
7. Check whether “Roland V-Synth XT” with an “!” or “?” symbol is displayed below “Other Devices,” “Sound, Video, and Game Controllers,” or “Universal Serial Bus Controller.” If you find any such indication, select it and click [Delete].
8. A dialog box will ask you to confirm deletion of the device. Verify the contents of the dialog box, and then click [OK]. In the same way, delete all occurrences of “Roland V-Synth XT” that have an “!” or “?” symbol.
9. Check whether “Composite USB Device,” “USB Device,” or “USB Composite Device” with an “!” or “?” symbol is displayed below “Other Devices,” “Sound, Video, and Game Controllers,” or “Universal Serial Bus Controller.” If you find any such indication, you need to determine whether it has appeared because the V-Synth XT has been detected incorrectly, or because there is a problem with some other device. To determine this, switch off the power of the V-Synth XT.

* If the “Composite USB Device” (or other) indication disappears when you turn off the power of the V-Synth XT, then it is the V-Synth XT that has been incorrectly detected. Return to step 2 and continue the procedure, and when you reach step 8, delete the information that was detected incorrectly. If the indication does not disappear when you turn off the power of the V-Synth XT, then this indication refers to a different device. Do not delete it.

“Composite USB Device,” “USB Device,” or “USB Compatible Device” may sometimes indicate a device other than the V-Synth XT. Be careful not to accidentally delete the registration for another device. If you delete the registration for another device, you will have to reinstall the driver for that device.

10. A dialog box will ask you to confirm deletion of the device. Verify the contents of the dialog box, and click [OK]. Delete each unwanted occurrence of “Composite USB Device,” “USB Device,” or “USB composite device” indications with an “!” or “?” symbol.

11. Turn off the power of the V-Synth XT, then delete the driver.

12. Restart Windows. Then install the driver once again.

* If the problem still occurs after you have taken the above measures, please refer also to the Readme file for the USB driver. The Readme file is on the CD-ROM.

Problems Related to the USB Driver (Macintosh)

| Problem | Cause | Action |
|--|---|---|
| A message of “Drivers needed for the USB device “V-Synth XT” are not available. Would you like to look for these drivers over the internet?” is displayed | It is possible that the V-Synth XT’s USB MIDI driver has not been correctly installed in your computer. | Correctly install the USB MIDI driver as described in Readme file on the included CD-ROM. |
| | It is possible that there is a conflict with the driver (function extension) of another USB device. | We are aware of a problem that causes the V-Synth XT to not be recognized correctly if a driver for I-O Data Corporation’s USB CD-R drive is installed. In this case, disable “ISD 200 BOTBridge” or other driver file by moving it out of the Extensions folder, located within the system folder. |
| When the computer returns from the Sleep state, an indication of “MIDI off line!” appears | The V-Synth XT’s USB MIDI driver does not support the Sleep functionality of Mac OS. | Do not use the Sleep functionality of Mac OS. When you use the V-Synth XT, open the “Energy Saver” control panel and specify “Never” as the period of inactivity before the system goes to sleep. |

Message List

The V-Synth XT displays a variety of messages. There are three types of message screen.

- ERROR screen:** This will appear if you attempt to perform an incorrect operation, or if an operation could not be executed correctly.
- WARNING screen:** This will appear when caution is necessary.
- Message box:** This informs you of the current status. It will also appear if you attempt to perform an incorrect operation, or if an operation could not be executed correctly.

Messages are listed here alphabetically for each type of message screen.

ERROR Screens

If an ERROR screen appears, touch <ACCEPT> to erase the message.

| Message | Meaning | Action |
|---|--|--|
| DISK Disk Full! | The media is full, and no further writing is possible. | Delete unneeded files from the media (p. 136). Alternatively, provide other media that has free space. |
| DISK File/Folder Name Duplicate! | There is an identically named file or folder. | Assign a different name (p. 137). Alternatively, please write to a folder that does not contain an identically-named file or folder. |
| DISK File Not Found! | A patch or sample used by the project or patch was not found on disk. | Re-create the project or patch, and save it. |
| DISK File Read Error! | The data is damaged, and cannot be loaded. | Do not use this file. |
| DISK File Write Error! | The media is of a format to which the V-Synth XT cannot write. | Prepare a media that is of a format to which the V-Synth XT is able to write. |
| DISK Illegal Format! | Since the format of this file is incorrect, it cannot be loaded. | Do not use this file. |
| DISK Illegal PCM Wave! Cannot Load This Wave. | This file uses a type of compression that the V-Synth XT is unable to read. | Use the device that created the file to convert the data into an 8 bit or 16 bit wave. |
| DISK Memory Full! | Since the wave memory has become full, the operation was halted. | Delete unneeded samples from the V-Synth XT. Alternatively, individually import the patches or samples that you want to use. |
| DISK Path Duplicate! | You are attempting to write to the same hierarchical level. | Change the writing destination. |
| DISK Path Name Too Long! | The path name is too long. | Shorten the names of each folder (p. 137). Alternatively, move the entire folder to a shallower level of the hierarchy (p. 135). * The "path" indicates the hierarchical level at which the file is located. It is given together with the folder name. |
| DISK PC Card Not Ready! | The memory card is not ready. | Insert another memory card. |
| DISK Too Many Channels! Cannot Load This Wave. | This file contains waves for three or more channels, and cannot be loaded into the V-Synth XT. | Do not use this file. |
| DISK Unformatted Disk! | This disk cannot be used by the V-Synth XT. | Format the disk on the V-Synth XT. |
| DISK Unknown Disk Error! | A disk error of unknown causes has occurred. | Contact your dealer or a nearby Roland service center for service. |
| DISK You Cannot Use This Device! | The operation you attempted to execute does not support this media. | Do not select this media for this operation. |
| ENCODE Encoding Error! | For some reason, encoding is not possible. | Change the encoding type and try again. |
| ENCODE Memory Full! | Due to insufficient wave memory, encoding is not possible. | Shorten the wave (p. 115), or delete unwanted samples from the V-Synth XT's memory (p. 109). |
| IMPORT No Room for Patches! | There are no vacant patches. | Delete unneeded patches from the V-Synth XT (p. 77). |
| IMPORT No Room for Samples! | There are no vacant samples. | Delete unneeded samples from the V-Synth XT (p. 109). |
| SAMPLE EDIT Copy Buffer Not Allocated! | There is not enough wave memory to execute the Copy. | Shorten the range that will be copied (p. 115), or delete unneeded samples from the V-Synth XT (p. 109). |

Message List

| Message | Meaning | Action |
|-------------------------------------|---|---|
| SAMPLE EDIT Memory Full! | There is not enough wave memory to execute the wave editing operation (Insert, Zero Insert, Region, Paste). | Delete unneeded samples from the V-Synth XT (p. 109). |
| SAMPLING Memory Full! | Since the wave memory has become full, the operation was halted. | Delete unneeded samples from the V-Synth XT (p. 109). |

WARNING Screens

If a WARNING screen appears, follow the procedure described in the corresponding "Action."

| Message | Meaning | Action |
|--|---|---|
| CHANGE USB MODE USB Mode Will Be Changed. | USB mode will be changed. | Exit any USB MIDI-related applications on your computer. |
| COPY FILE/FOLDER Are You Sure? | The file(s) or folder(s) will be copied from the disk. Is it OK to execute? | To cancel the operation, touch <CANCEL>. To execute the operation, touch <EXECUTE>. |
| DELETE FILE/FOLDER This Will Clear the File(s)/Folder(s). Are You Sure? | The file(s) or folder(s) will be deleted from the disk. Is it OK to execute? | To cancel the operation, touch <CANCEL>. To execute the operation, touch <EXECUTE>. |
| DISCONNECT USB Disconnection Will Be Done Before Ejecting. Are You Sure? | Will disconnect before ejecting. Is it OK to execute? | Perform the Eject operation on your computer. |
| EDITED DATA EXISTS If You Need This Data, Save Immediately. | The V-Synth XT contains an unsaved patch or sample. | If you need the patch or sample, save it now. Touch <ACCEPT> to erase the message. |
| FILE/FOLDER EXISTS Overwrite Existing File/Folder? | There is an identically named file or folder at the copy- or move-destination. | To cancel the operation, touch <CANCEL>. To execute the copying or moving operation, touch <EXECUTE>. |
| FORMAT All Data on the Disk Will Be Lost. Are You Sure? | When you format, all data on the disk will be lost. Is it OK to execute? | To cancel the operation, touch <CANCEL>. To execute the formatting operation, touch <EXECUTE>. |
| IMPORT FILE Are You Sure? | The file(s) will be imported from the disk. Is it OK to execute? | To cancel the operation, touch <CANCEL>. To execute the importing operation, touch <EXECUTE>. |
| INITIALIZE PATCH Are You Sure? | The patch will be initialized. Is it OK to execute? | To cancel the operation, touch <CANCEL>. To execute the operation, touch <EXECUTE>. |
| LOAD DEMO Replace All Data. Are You Sure? | When you load the demo data, all data in the VP-9000 will be lost. Is it OK to execute the operation? | To cancel the operation, touch <CANCEL>. If you wish to load the demo data, touch <EXECUTE>. |
| LOAD PROJECT Are You Sure? | Project will be loaded. Is it OK to execute the operation? | To cancel the operation, touch <CANCEL>. If you wish to load the project, touch <EXECUTE>. |
| MOVE FILE/FOLDER Are You Sure? | The file(s) or folder(s) will be moved from the disk. Is it OK to execute? | To cancel the operation, touch <CANCEL>. To execute the operation, touch <EXECUTE>. |
| OTHER SAMPLE EXISTS Number '****' Already Contains a Sample. Clear Existing Sample? | A different sample already exists in the selected sample number '*****'. | To cancel the operation, touch <CANCEL>. If you wish to overwrite the sample of the selected number, touch <EXECUTE>. |
| PROJECT NOT FOUND Internal Project Was Loaded. | Cannot find the project specified as the current project. The internal project was loaded. | Touch <ACCEPT> to erase the message. |
| SAMPLE EDIT Copy Buffer Not Avail. Are You Sure? | When you perform the Cut or Clear sample editing operation, the data is simultaneously copied as well. However, this message indicates that in this case, there is insufficient memory remaining to copy the data. Do you still want to execute the Cut or Clear? (Since a copy will not be made, you will be unable to restore the data simply by pasting it back. The Cut or Clear operation can still be carried out, though.) | To cancel the operation, touch <CANCEL>. If you also want to Copy the data, shorten the range being Cut or Cleared (p. 115), or delete unneeded samples from the V-Synth XT (p. 109). To execute the Cut or Clear operation, touch <EXECUTE>. |
| SAMPLE EXISTS Overwrite Existing Sample? | Sample exists in the copy- or move-destination. | To cancel the operation, touch <CANCEL>. To execute the copying or moving operation, touch <EXECUTE>. |
| SAVE PROJECT Are You Sure? | Project will be saved. Is it OK to execute the operation? | To cancel the operation, touch <CANCEL>. To execute the operation, touch <EXECUTE>. |

Message Boxes

Message boxes are displayed briefly, and then disappear automatically.

| Message | Meaning | Action |
|-----------------------------------|---|--|
| Canceled! | The operation is canceled. | |
| Cannot Delete This Event! | The events at the beginning and end of a wave cannot be deleted. | |
| Checksum Error! | The received system exclusive message has an incorrect checksum value. | Correct the checksum value. |
| Completed! | The operation has been completed. | |
| Connecting... | Now establishing a connection. | |
| Disconnecting... | Now breaking the connection. | |
| Event Doesn't Exist Here! | There is no event at the specified location. | Specify a location where there is an event. |
| Event Interval Too Narrow! | The event interval is too narrow for events to be placed in it. | Move the interval further from the nearest event. |
| Improper Name! | The folder name or volume label is blank. | Assign a name before you execute (p. 137). |
| MIDI Buffer Full! | An excessive amount of MIDI data was received all at once, and could not be processed properly. | |
| MIDI Communication Error! | A MIDI hardware error has occurred. | If the same message appears repeatedly, please contact your dealer or a nearby Roland service center for service. |
| MIDI Offline! | The MIDI IN connection has been broken. | Check whether there is a problem with the MIDI cable connected to the V-Synth XT's MIDI IN, or whether the MIDI cable has been disconnected. |
| Please Wait a Minute. | Please wait a short time. | |
| Processing... | The operation is being executed. | |
| Transmitting... | The data is being transmitted. | |
| Error Receiving Data! | MIDI message could not be received correctly. | If the same message appears repeatedly, there is a problem with the content of the MIDI messages. |
| USB Offline! | USB cable is not connected. | Check whether there is a problem with the USB cable connected to the V-Synth XT's USB connector, or whether the USB cable has been disconnected. |
| Writing... | Data is being written. | |

About MIDI

MIDI (Musical Instruments Digital Interface) is a standard specification that allows musical data to be exchanged between electronic musical instruments and computers. With a MIDI cable connecting MIDI devices that are equipped with MIDI connectors, you can play multiple instruments with a single keyboard, have multiple MIDI instruments perform in ensemble, program the settings to change automatically to match the performance as the song progresses, and more.

About MIDI Connectors

The V-Synth XT is equipped with the three types of MIDI connectors, each which works differently.



MIDI IN Connector

This connector receives MIDI messages that are transmitted from external MIDI devices. The V-Synth XT can receive these messages to play notes or select sounds, etc.

MIDI OUT Connector

This connector transmits MIDI messages to external MIDI devices. The V-Synth XT's MIDI OUT connector is used for sending the performance data of the keyboard controller section as well as data used for saving various settings and patterns.

MIDI THRU Connector

MIDI messages received at MIDI IN are re-transmitted without change from this connector to an external MIDI device. Use this in situations such as when you use multiple MIDI devices simultaneously.

MIDI Channels and Multi-timbral Sound Generators

MIDI transmits many types of data over a single MIDI cable. This is made possible by the concept of **MIDI channels**. MIDI channels allow messages intended for a given instrument to be distinguished from messages intended for another instrument. In some ways, MIDI channels are similar to television channels. By changing the channel on a television set, you can view the programs that are being broadcast by different stations. In the same way, MIDI also allows a device to select the information intended for that device out of the variety of information that is being transmitted to it.

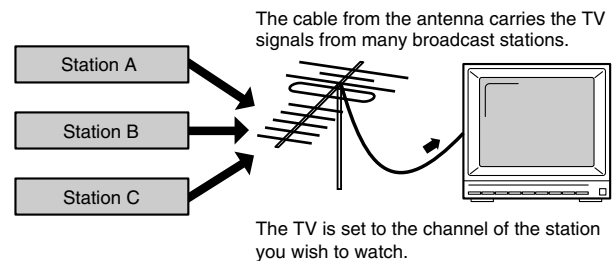

MIDI uses sixteen channels; 1 through 16. Set the receiving device so that it will receive only the channel that it needs to receive.

Example:

Set the V-Synth XT to send Channel 1 and Channel 2, then set sound module A to receive only Channel 1 and sound module B only Channel 2. With this setup, you can get an ensemble performance, with, for example, a guitar sound from sound module A and bass from sound module B.

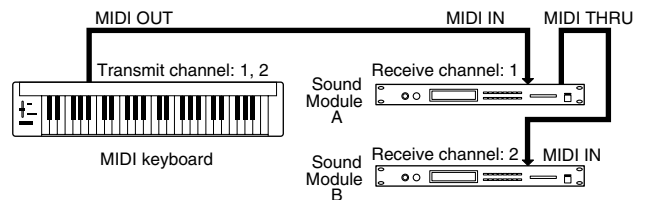

When used as a sound module, the V-Synth XT can receive on up to sixteen MIDI channels. Sound modules like the V-Synth XT which can receive multiple MIDI channels simultaneously to play different sounds on each channel are called **multi-timbral sound modules**.

Model V-Synth XT

MIDI Implementation Chart

| Function... | Transmitted | Recognized | Remarks | | |
|---|---|-----------------------------|--------------------------------------|-------------|-------------------|
| Basic Channel Default Changed | 1-16 1-16 | 1-16 1-16 | Memorized | | |
| Mode Default Messages Altered | Mode 3 Mono, Poly ***** | Mode 3 Mode 3, 4 (M = 1) | * 2 | | |
| Note Number : True Voice | X ***** | 0-127 0-127 | | | |
| Velocity Note On Note Off | X X | O O | | | |
| After Touch Key's Channel's | X X | O O | *1 *1 | | |
| Pitch Bend | X | O | *1 | | |
| Control Change | 0, 32 | O | *1 | Bank select | |
| | 1-31, 33-95 | O | *1 | X | *1 |
| | 100, 101 | X | *1 | O | RPN LSB, MSB |
| Program Change : True Number | O ***** | *1 | O 0-127 | *1 | Program No. 1-128 |
| System Exclusive | O | *3 | O | *1 | |
| System Common : Song Position : Song Select : Tune Request | X X X | | X X X | | |
| System Realtime : Clock : Commands | X X | *1 | X X | *1 | |
| Aux Messages : All Sound Off : Reset All Controllers : Local On/Off : All Notes Off : Active Sensing : System Reset | X X X X O X | *1 | O O X O (123-127) O X | | |
| Notes | * 1 O X is selectable. * 2 Recognized as M=1 even if M≠1. * 3 Transmits when Data Transfer is executed or RQ1 received. | | | | |

Mode 1 : OMNI ON, POLY
Mode 3 : OMNI OFF, POLY

Mode 2 : OMNI ON, MONO
Mode 4 : OMNI OFF, MONO

O : Yes
X : No

Specifications

V-Synth XT: Synthesizer Sound Module

● Sound Generator Configuration

Oscillator (envelope x 4 + LFO x 1) x 2
Modulator x 1
COSM (envelope x 2 + LFO x 1) x 2
TVA (envelope x 1 + LFO x 1) x 1

● Methods by Which Oscillators Produce Sound

PCM / Variphase (Preset waveforms + Sampling waveforms),
Analog Modeling (14 waves: SAW, SQUARE, TRIANGLE, SINE,
RAMP, JUNO, HQ-SAW, HQ-SQUARE, NOISE, LA-SAW,
LA-SQUARE, SUPER-SAW, FEEDBACK-OSC, X-MOD-OSC)
External Input

● Modulator

4 types (RING, FM, ENV-RING, OSC-SYNC)

● COSM

16 types (OD/DS, W-SHAPE, AMP, SPEAKER, RESONATOR, SBF1,
SBF2, COMB, DUAL, TVF, DYN-TVF, COMP, LIMITER, F-SHIFT,
LO-FI, TB-FILTER)

● Zones (Splits)

16

● Parts

16 (normally)
12 (when using a rhythm kit)

● Maximum Polyphony

24 voices
(Varies depending on the load placed on the sound generator.)

● Internal Memory

Project: 1
Patches: 512
Waves: 999
Wave memory (RAM): 50 M bytes
(When the unit ships from the factory, 32 M bytes of this is taken up
by the preset waves.)

● External Storage Device

PC CARD slot
(Microdrive, SmartMedia or CompactFlash can be used with PC card
adapter.)

● Effects

MX (Multi-effects): 41 sets
Chorus: 8 sets
Reverb: 10 sets

● System EQ

4 bands

● Internal V-Card applications (system expansion)

VC-1: D-50 Simulator
VC-2: Vocal Designer
(Switchable from the standard system while the power remains on.)

● Sampling Frequency

Internal: 44.1 kHz
Digital Audio IN/OUT: 96, 48, 44.1 kHz

● Signal Processing

Internal Processing
Sound generating section: 32 bits (floating point)
Effects section: 24 bits (fixed point)

DA Conversion: 24 bits
AD Conversion: 24 bits

● Nominal Output Level

MAIN OUT: +4 dBu
DIRECT OUT: +4 dBu

● Nominal Input Level

Input (Rear Panel): -10 / -20 dBu
Mic (Front Panel, XLR type): -50 – -10dBu
Mic (Front Panel, 1/4 inch TRS phone type): -36 – +4dBu

● Arpeggiator

Patterns: User programmable
(support use of control change messages)
Motifs: 8 types
Tempo: 20 to 250 BPM

● Multi Step Modulator

Tracks: 4
Steps: 16
Tempo: 20 to 250 BPM

● Display

Graphic 320 x 240 dot backlit LCD with touch screen

● Controllers

Assignable MIDI Control Knobs (E1–E8)

● Connectors

Headphones Jack
Main Output Jacks (L/MONO, R) (1/4 inch TRS phone type)
Direct Output Jacks (L, R) (1/4 inch phone type)
Input Jacks (L/MONO, R) (1/4 inch phone type)
Mic Jack (1/4 inch phone type / XLR type, Hi-Z, phantom power)
MIDI Connectors (IN, OUT, THRU)
USB Connector (supports USB MIDI, file transfer, and USB Audio)
Digital Audio Interface (24-bit, IEC60958)
COAXIAL (IN, OUT)
OPTICAL (IN, OUT)

AC Inlet

● Power Supply

AC 115 V, AC 117 V, AC 220 V, AC 230 V, AC 240 V (50/60 Hz)

● Power Consumption

16 W

● Dimensions

When placed on top of a table
482 (W) x 179 (D) x 165 (H) mm
19 (W) x 7-1/16 (D) x 6-1/2 (H) inches
When mounted in a rack
482 (W) x 172 (D) x 177 (H) mm
19 (W) x 6-13/16 (D) x 7 (H) inches

* EIA-4U size: A vacant rack space immediately above is required in
order to utilize the V-Synth XT's rotation feature.

● Weight

4.4 kg / 9 lbs 12 oz

● Accessories

V-Synth XT Owner's Manual
V-Card Owner's Manual
Sound List
CD-ROM (USB Driver, Librarian)
PC CARD Protector
Rotation Lock Hardware
Power Cord

(0 dBu = 0.775 V rms)

* In the interest of product improvement, the specifications and/or
appearance of this unit are subject to change without prior notice.

Index

Numerics

- 4 Band EQ 124
- 4-Band equalizer switch 124

A

- AC inlet 16
- Adjust 114
- ADSR Attack 95
- ADSR Decay 95
- ADSR Release 95
- ADSR Sustain 95
- Analog oscillator waveform 86
- Arabic scale 85
- Arpeggiator 64
- Arpeggio 82
- Arpeggio duration 83
- Arpeggio hold switch 82
- Arpeggio keyboard velocity 82
- Arpeggio motif 83
- Arpeggio octave range 82
- Arpeggio shuffle rate 83
- Arpeggio shuffle resolution 83
- Arpeggio switch 82
- [ASSIGNABLE]
 - Time trip pad 32, 69
- Assigning a name
 - Files/Folders 137
 - Patch 74
 - Sample 107
 - Template 112
- Assign-TT 130
- Attack 93, 110
- Attack time 110
- Audio 129
- Audio I/F 126

B

- Beat 111
- Beat Keep 87
- Beep tone 24
- Bend Range Down 80
- Bend Range Up 80
- Bender 80

C

- Calibration mode 59, 148
- CHO 98
- CHO Master Level 98
- CHO Send 97
- CHO To REV 98
- CHO Type 98
- Chorus master level 98
- Chorus on/off switch 98
- Chorus reverb send level 98
- Chorus send level 97
- Chorus type 98
- Clean Project 133
- Clock Out 125

- Clock Source 125
- Coarse 88
- COAXIAL IN/OUT 16
- Common
 - Patch 79
 - System 123
- Compare 76
- Compare function 76
- Controller 127
- Controller section 56
- Copy 135
 - Files/Folders 135
 - Patch 73
- COSM switch 93
- COSM1/COSM2 93
- Count In 111
- Cross Modulation Depth 91
- [CTRL] 15
- Cursor 25
- Cursor button 16, 25

D

- Data Transfer 146
- [DEC] 15, 26
- Delay Time 96
- Delete 136
 - Files/Folders 136
- Depth 120
- Destination 1, 2 81
- Detune 89
- Device ID 125
- Device ID number 125
- DIGITAL AUDIO INTERFACE connector 16
- Digital Output Freq 124
- Digital output frequency 124
- DIRECT OUT jack 16
- Disk Format 134
- Disk Load Project 132
- Disk mode 59, 131
- Disk Tools 135–137
- Disk utility 131
- DISK UTILITY MENU 131
- Drum 101
- Drum patch 101
- Duration 83

E

- E1 - E8 Knob 128
- E1 - E8 Knob2 128
- E1-E8 Assign 130
- E1-E8 Knob 130
- E1-E8 knobs 70
- Effect 97
- Effects 56
- Encode 118
- Encode depth 120
- Encoding type 119
- Energy 92

Index

- Env Time KF 95
- Envelope attack time 95
- Envelope attack time velocity sensitivity 95
- Envelope decay time 95
- Envelope release time 95
- Envelope release time velocity sensitivity 95
- Envelope settings 95
- Envelope sustain level 95
- Envelope velocity curve 95
- Envelope velocity sensitivity 95
- EQ 124
- Equal temperament 85
- Event 120
 - Add 120
 - Delete 120
- [EXIT] 15
- External Input Source 123
- External Input Type 123

- F**
- Factory Reset 147
- Factory reset mode 59
- Fade Mode 96
- Fade Time 96
- Fat 89
- Fat KF 89
- FBK Amount 90
- Feedback Amount 90
- FEEDBACK OSC 86
- Fine 88
- Fmt LFO Depth 92
- Formant 92
- Formant KF 92
- Format 134

- G**
- General 79

- H**
- Harmonics 90
- High Freq 124
- High frequency 124
- HIGH Gain 124
- [HOLD]
 - Arpeggiator 64
 - Time trip pad 70
- Hold 80, 82

- I**
- Impact 87
- Import Files 133
- [INC] 15, 26
- Info 147
- Initialize
 - Disk 134
 - Patch 73
 - System 122
- INPUT 14
- INPUT jack 16

- INPUT Jack Gain 126
- INPUT Jack Switch 126
- Input source 110
- Internal memory 57
- IO 123

- J**
- Just temperament 85

- K**
- KBD 128
- KBD Velo 82
- Key Follow
 - Patch level 94
- Key follow
 - Envelope time 95
 - Fat 89
 - Formant 92
 - Oscillator level 92
 - Oscillator pitch 88
 - Pan 94
 - Pulse width 88
 - Time 91
- Key Hold Panic Key 128
- KEY PAD Button 15
- Key Sync 96
- Knob 1, 2 Assign 129
- Knob Local Sw 130

- L**
- LA-SAW 86
- LA-SQUARE 86
- LCD contrast 15
- LCD CONTRAST knob 15
- Legato 80
- Legato switch 80
- Length lock 114
- Level 110–111
 - oscillator 92
 - Patch 94
- Level KF 92, 94
- Level LFO Dp 92
- LFO
 - COSM 93
 - Oscillator 92
 - TVA 94
- LFO delay time 96
- LFO depth
 - Fat 89
 - Formant 92
 - Oscillator level 92
 - Oscillator pitch 88
 - Pan 94
 - Patch level 94
 - Pulse width 88
 - Time 91
- LFO fade mode 96
- LFO fade time 96
- LFO key sync switch 96

- LFO offset 96
 LFO rate 96
 LFO settings 96
 Link Y assign-XY 130
 Load Project 132
 Local Sw 128
 Local switch 128
 LOCK 114
 LOOP 114
 Loop 87
 Loop region 117
 LOW Freq 124
 Low frequency 124
 LOW Gain 124
 Lvl LFO Dp 94
- M**
- MAIN OUT jack 16
 Master 123
 Master Key Shift 123
 Master Level 123
 Master Tune 123
 Matrix control 81
 Matrix control destination 1, 2 81
 Matrix control sens 81
 Matrix control source 81
 Matrix Ctrl 81
 Memory 57
 Metro Type 111
 Metronome 111
 Metronome level 111
 Metronome type 111
 MFX 97–98
 MFX chorus send level 98
 MFX Master Level 97
 MFX on/off switch 97
 MFX reverb send level 98
 MFX Send 97
 MFX send level 97
 MFX To CHO 98
 MFX To REV 98
 MFX Type 97–98
 MIC jack 14
 MIC JACK Switch 126
 MIC Switch 14
 MID 1 Freq 124
 Mid 1 frequency 124
 MID 1 Gain 124
 MID 1 Q 124
 MID 2 Freq 124
 Mid 2 frequency 124
 MID 2 Gain 124
 MID 2 Q 124
 [MIDI] 14
 MIDI Channel 129
 MIDI connector 16
 MIDI Indicator 14
 MIDI/USB 125
- Mix 90
 Mix/Parallel 124
 Mod 93
 Mod Type 93
 [MODE] 15, 58
 Mode 58, 79–80
 Modulator attack time 93
 Modulator original level 93
 Modulator release time 93
 Modulator switch 93
 Modulator Type 93
 Mono 63
 Mono/Poly 79
 Motif 83
 Move 135
 Files/Folders 135
 Multi 83
 Multitimbral 56
- N**
- numeric keys 27
- O**
- Octave Range 82
 Octave Shift 80
 Offset 96
 [ON/OFF]
 Arpeggiator 36, 64
 OPTICAL IN/OUT 16
 Original Level 93
 Original tempo 118
 OSC TVA 92
 OSC1/OSC2 86
 Oscillator coarse tune 88
 Oscillator fine tune 88
 Oscillator random pitch depth 88
 Oscillator switch 86
 Oscillator type 86
 Output Assign 97
 Output Gain 124
 Output level 110–111
- P**
- Palette Local Sw 129
 Pan 94
 Pan KF 94
 Pan LFO Dp 94
 Panic Key 128
 Part 1–16 receive channel 126
 Part 1–16 receive switch 126
 Part 1–16 Rx Ch 126
 Part MIDI 126
 Part1–16 Rx Sw 126
 Patch
 Patch settings 72
 Selecting a patch 60
 Patch Coarse Tune 85
 PATCH Copy 73

| | | | |
|--|--------|---------------------------------------|---------|
| PATCH Edit Com Arpeggio | 65 | PREVIEW Button | 15 |
| Patch Fine Tune | 85 | Project | 57 |
| PATCH Information | 147 | Pulse Width | 88 |
| PATCH Init | 73 | PW KF | 88 |
| PATCH List | 62 | PW LFO Depth | 88 |
| Patch Mode | | R | |
| Playing in Patch mode | 60 | Random | 88 |
| Patch mode | 58 | Rate | 96 |
| PATCH Name | 74 | Ratio | 111 |
| Patch palette | 61, 76 | Receive bank select switch | 125 |
| PATCH PLAY | 60 | Receive program change switch | 125 |
| Patch Remain | 123 | Receive system exclusive switch | 125 |
| Patch remain switch | 123 | Release | 93, 111 |
| Patch Tempo | 82 | Release time | 111 |
| Patch transmit channel | 127 | Rename | 137 |
| Patch Tx Ch | 127 | Resampling | 109 |
| PATCH Write | 74–75 | REV | 98–99 |
| PATCH Zone | 100 | REV Master Level | 98 |
| Pattern Edit | 82 | REV Send | 97 |
| Pattern edit | 65 | REV Type | 98–99 |
| PC card | 57 | Reverb master level | 98 |
| PC card protector | 23 | Reverb on/off switch | 98 |
| PC CARD slot | 15 | Reverb send level | 97 |
| PCM oscillator loop switch | 87 | Reverb type | 98–99 |
| PCM oscillator playback mode | 87 | Rhythm Mode | 58, 102 |
| PCM oscillator robot voice switch | 87 | Robot Voice | 87 |
| PCM oscillator start offset | 87 | Routing | 97 |
| PCM oscillator tempo sync switch | 87 | Rx Bank | 125 |
| PCM oscillator vari switch | 87 | Rx PC | 125 |
| PCM oscillator waveform | 87 | Rx Sys-Ex | 125 |
| [PEAK] | 14 | S | |
| Peak Indicator | 14 | Sample | 104 |
| PHONES jack | 14 | Edit | 113 |
| Pit LFO Dp | 88 | Import | 113 |
| Pitch | 88 | Sample edit | |
| Oscillator pitch | 88 | Clear | 116 |
| Pitch bend range down | 80 | Copy | 116 |
| Pitch bend range up | 80 | Cut | 116 |
| Pitch KF | 88 | Insert | 116 |
| Playback Mode | 87 | LR-Mix | 116 |
| Polyphony | 56 | Normalize | 116 |
| Portamento | 63, 79 | Paste | 116 |
| Portamento mode | 79 | Region | 117 |
| Portamento switch | 79 | Reverse | 117 |
| Portamento time | 79 | Trim | 116 |
| Portamento time velocity sensitivity | 79 | Truncate | 116 |
| Portamento type | 79 | Zero Insert | 116 |
| POWER switch | 16 | SAMPLE Encode | 119 |
| Powerup Mode | 123 | SAMPLE Information | 112 |
| Pre gain | 110 | SAMPLE Loop FWD | 114 |
| Pre trigger | 110 | Sample mode | 104 |
| Pre-effect | 110 | SAMPLE Name | 107 |
| Compressor | 110 | SAMPLE Top | 105 |
| Limiter | 111 | Sampling | 104 |
| Noise suppressor | 111 | SAMPLING General | 109 |
| Pre-effect type | 110 | Sampling memory | 57 |
| Preset memory | 57 | | |
| PREVIEW | 114 | | |

- SAMPLING Pre-Effect 110
- SAMPLING Template 106
- Sampling template 104
- SAMPLING Template Name 112
- Sampling type 109
- Save
- Patch 74
 - Project 132
 - Sample 121
 - System 122
- Save Project 132
- Scale Tune 85
- Scale Tune C-B 85
- Scale tune switch 85
- Sens 81
- [SHIFT] 15
- Shuffle Rate 83
- Shuffle Resolution 83
- Sound generator section 56
- Source 81
- Split 99
- Start Offset 87
- Storage function 139
- structure 56
- Structure Type 79
- Sub-Oscillator 87
- SUPER-SAW 86
- Sustain 110
- SYSTEM Com Master 122
- System mode 59, 122
- T**
- T SCREEN CALIBRATION 148
- Template Name 112
- Tempo 111
- Tempo Sync 87
- Temporary area 57
- Thres 111
- Threshold 111
- Threshold level 111
- Time 79, 91
- Time KF 91
- Time Offset 91
- [TIME TRIP]
- Time trip pad 32, 69
- Time Trip Beat Keep 87
- Time trip pad 69
- Time trip pad hold switch 80
- Time trip pad mode 80
- Time Trip Sw 87
- Time trip switch 87
- Time Velo Sens 79
- Tone 110–111
- Tools 135
- TOTAL Gain 124
- Touch screen 24
- Transmit active sensing switch 127
- Transmit bank select switch 127
- Transmit edit data switch 125
- Transmit program change switch 127
- Trigger level 110
- Trigger mode 110
- Trimming 116
- TT Pad 80
- TT Pad Local Sw 130
- TT Pad/Knob 128, 130
- Tune 83
- TVA 94
- TVA switch 94
- Tx 127, 129
- Tx Active Sens 127
- Tx Bank 127
- Tx Edit 125
- Tx PC 127
- Type 79, 110
- U**
- Undo 115
- [USB] 14
- USB 57
- USB Audio Input Monitor Sw 127
- USB Audio Input Source 127
- USB Audio Output Dest 127
- USB connector 14
- USB Indicator 14
- USB MIDI driver 138
- USB mode 59, 138
- USB Storage 139, 141
- USB-MIDI Thru Sw 125
- USB-MIDI thru switch 125
- V**
- VALUE dial 15, 26
- Vari Sw 87
- VariPhrase 13
- Velocity A-Sens 95
- Velocity Curve 95
- Velocity R-Sens 95
- Velocity Sens 95
- [V-LINK] 71
- V-LINK 71, 129
- V-LINK assign-time trip 130
- V-LINK audio switch 129
- V-LINK knob E1-E8 local switch 130
- V-LINK knob E1-E8 assign 130
- V-LINK MIDI channel 129
- V-LINK mode 71
- V-LINK patch palette local switch 129
- V-LINK time trip pad local switch 130
- V-LINK X assign-XY 130
- Volume 14
- Volume slider 14

W

| | |
|-----------------|-------|
| Wave Gain | 86 |
| Waveform | 86–87 |
| Work area | 57 |

X

| | |
|--------------------------|----------|
| X assign-time trip | 128 |
| X Assign-TT | 128 |
| X Assign-XY | 128, 130 |
| X-MOD | 86, 91 |

Y

| | |
|--------------------------|----------|
| Y assign-time trip | 128 |
| Y Assign-TT | 128 |
| Y Assign-XY | 128, 130 |

Z

| | |
|-------------------------|--------|
| Zero cross search | 115 |
| ZeroX | 115 |
| Zone | 56, 99 |
| Zoom | 115 |
| Zoom bar | 115 |

MEMO



MEMO





For EU Countries

This product complies with the requirements of European Directives EMC 89/336/EEC and LVD 73/23/EEC.

For the USA

FEDERAL COMMUNICATIONS COMMISSION RADIO FREQUENCY INTERFERENCE STATEMENT

This equipment has been tested and found to comply with the limits for a Class B digital device, pursuant to Part 15 of the FCC Rules. These limits are designed to provide reasonable protection against harmful interference in a residential installation. This equipment generates, uses, and can radiate radio frequency energy and, if not installed and used in accordance with the instructions, may cause harmful interference to radio communications. However, there is no guarantee that interference will not occur in a particular installation. If this equipment does cause harmful interference to radio or television reception, which can be determined by turning the equipment off and on, the user is encouraged to try to correct the interference by one or more of the following measures:

- Reorient or relocate the receiving antenna.
- Increase the separation between the equipment and receiver.
- Connect the equipment into an outlet on a circuit different from that to which the receiver is connected.
- Consult the dealer or an experienced radio/TV technician for help.

This device complies with Part 15 of the FCC Rules. Operation is subject to the following two conditions:

- (1) This device may not cause harmful interference, and
- (2) This device must accept any interference received, including interference that may cause undesired operation.

Unauthorized changes or modification to this system can void the users authority to operate this equipment.
This equipment requires shielded interface cables in order to meet FCC class B Limit.

For Canada

NOTICE

This Class B digital apparatus meets all requirements of the Canadian Interference-Causing Equipment Regulations.

AVIS

Cet appareil numérique de la classe B respecte toutes les exigences du Règlement sur le matériel brouilleur du Canada.

For the USA

DECLARATION OF CONFORMITY Compliance Information Statement

Model Name : V-Synth XT
Type of Equipment : Synthesizer Sound Module
Responsible Party : Roland Corporation U.S.
Address : 5100 S. Eastern Avenue, Los Angeles, CA 90040-2938
Telephone : (323) 890-3700

Information

When you need repair service, call your nearest Roland Service Center or authorized Roland distributor in your country as shown below.

AFRICA

EGYPT

Al Fanny Trading Office
9, EBN Hagar A1 Askalany Street,
ARD El Golf, Heliopolis,
Cairo 11341, EGYPT
TEL: 20-2-417-1828

REUNION

Maison FO - YAM Marcel
25 Rue Jules Hermann,
Chaudron - BP79 97 491
Ste Clotilde Cedex,
REUNION ISLAND
TEL: (0262) 218-429

SOUTH AFRICA

That Other Music Shop(PTY)Ltd.
11 Melle St., Braamfontein,
Johannesburg,
SOUTH AFRICA
TEL: (011) 403 4105
FAX: (011) 403 1234

Paul Bothner(PTY)Ltd.

17 Werdmuller Centre,
Main Road, Claremont 7708
SOUTH AFRICA
TEL: (021) 674 4030

ASIA

CHINA

Roland Shanghai Electronics Co.,Ltd.
5F, No.1500 Pingliang Road
Shanghai 200090, CHINA
TEL: (021) 5580-0800

Roland Shanghai Electronics Co.,Ltd.

(BEIJING OFFICE)
10F, No.18 3 Section Anhuaxili
Chaoyang District Beijing
100011 CHINA
TEL: (010) 6426-5050

Roland Shanghai Electronics Co.,Ltd.

(GUANGZHOU OFFICE)
2/F., No.30 Si You Nan Er Jie
Yi Xiang, Wu Yang Xin Cheng,
Guangzhou 510600, CHINA
TEL: (020) 8736-0428

HONG KONG

Tom Lee Music Co., Ltd.
Service Division
22-32 Pun Shan Street, Tsuen
Wan, New Territories,
HONG KONG
TEL: 2415 0911

Parsons Music Ltd.

8th Floor, Railway Plaza, 39
Chatham Road South, T.S.T,
Kowloon, HONG KONG
TEL: 2333 1863

INDIA

Rivera Digitec (India) Pvt. Ltd.
409, Nirman Kendra
Mahalaxmi Flats Compound
Off. Dr. Edwin Moses Road,
Mumbai-400011, INDIA
TEL: (022) 2493 9051

INDONESIA

PT Citra IntiRama
Jl. Cideng Timur No. 15J-150
Jakarta Pusat
INDONESIA
TEL: (021) 6324170

KOREA

Cosmos Corporation
1461-9, Seocho-Dong,
Seocho Ku, Seoul, KOREA
TEL: (02) 3486-8855

MALAYSIA

Roland Asia Pacific Sdn. Bhd.
45-1, Block C2, Jalan PJU 1/39,
Dataran Prima, 47301 Petaling
Jaya, Selangor, MALAYSIA
TEL: (03) 7805-3263

PHILIPPINES

G.A. Yupangco & Co. Inc.
339 Gil J. Puyat Avenue
Makati, Metro Manila 1200,
PHILIPPINES
TEL: (02) 899 9801

SINGAPORE

SWEE LEE MUSIC COMPANY PTE. LTD.
150 Sims Drive,
SINGAPORE 387381
TEL: 6846-3676

CRISTOFORI MUSIC PTE LTD

BK 3014, Bedok Industrial Park E,
#02-2148, SINGAPORE 489980
TEL: 6243-9555

TAIWAN

ROLAND TAIWAN ENTERPRISE CO., LTD.
Room 5, 9fl. No. 112 Chung
Shan N.Road Sec.2, Taipei,
TAIWAN, R.O.C.
TEL: (02) 2561 3339

THAILAND

Theera Music Co., Ltd.
330 Verng NakornKasem, Soi 2,
Bangkok 10100, THAILAND
TEL: (02) 2248821

VIETNAM

Saigon Music Suite DP-8
40 Ba Huyen Thanh Quan Street
Hochiminh City, VIETNAM
TEL: (08) 930-1969

AUSTRALIA/NEW ZEALAND

AUSTRALIA/NEW ZEALAND

Roland Corporation Australia Pty.,Ltd.
38 Campbell Avenue
Dee Why West. NSW 2099
AUSTRALIA

For Australia
Tel: (02) 9982 8266
For New Zealand
Tel: (09) 3098 715

CENTRAL/LATIN AMERICA

ARGENTINA

Instrumentos Musicales S.A.
Av.Santa Fe 2055
(1123) Buenos Aires
ARGENTINA
TEL: (011) 4508-2700

BARBADOS

A&B Music Supplies LTD
12 Webster Industrial Park
Wildely, St.Michael, Barbados
TEL: (246)430-1100

BRAZIL

Roland Brasil Ltda.
Rua San Jose, 780 Sala B
Parque Industrial San Jose
Cotia - Sao Paulo - SP, BRAZIL
TEL: (011) 4615 5666

CHILE

Comercial Fancy II S.A.
Rut.: 96.919.420-1
Nataníel Cox #739, 4th Floor
Santiago - Centro, CHILE
TEL: (02) 688-9540

COLOMBIA

Centro Musical Ltda.
Cra 43 B No 25 A 41 Bododega 9
Medellin, Colombia
TEL: (574)3812529

COSTA RICA

JUAN Bansbach Instrumentos
Musicales
Ave.1. Calle 11, Apartado 10237,
San Jose, COSTA RICA
TEL: (258)0211

CURACAO

Zeelandia Music Center Inc.
Orionweg 30
Curacao, Netherland Antilles
TEL:(305)5926866

DOMINICAN REPUBLIC

Instrumentos Fernando Giraldez
Calle Proyecto Central No.3
Ens.La Esperilla
Santo Domingo,
Dominican Republic
TEL:(809) 683 0305

ECUADOR

Mas Musica
Rumichaca 822 y Zaruma
Guayaquil - Ecuador
TEL:(593-4)2302364

EL SALVADOR

OMNI MUSIC
75 Avenida Norte y Final
Alameda Juan Pablo II,
Edificio No.4010 San Salvador,
EL SALVADOR
TEL: 262-0788

GUATEMALA

Casa Instrumental
Calzada Roosevelt 34-01,zona 11
Ciudad de Guatemala
Guatemala
TEL:(502) 599-2888

HONDURAS

Almacen Pajaro Azul S.A. de C.V.
BO.Paz Barahona
3 Ave.11 Calle S/O
San Pedro Sula, Honduras
TEL: (504) 553-2029

MARTINIQUE

Musique & Son
Z.I.Les Mangle
97232 Le Lamantin
Martinique F.W.I.
TEL: 596 596 426860

Gigamusic SARK

10 Rte De La Folie
97200 Fort De France
Martinique F.W.I.
TEL: 596 596 715222

MEXICO

Casa Veerkamp, s.a. de c.v.
Av. Toluca No. 323, Col. Olivar
de los Padres 01780 Mexico
D.F. MEXICO
TEL: (55) 5668-6699

NICARAGUA

Bansbach Instrumentos
Musicales Nicaragua
Altamira D'Este Calle Principal
de la Farmacia 5ta.Avenida
1 Cuadra al Lago.#503
Managua, Nicaragua
TEL: (505)277-2557

PANAMA

SUPRO MUNDIAL, S.A.
Boulevard Andrews, Albrook,
Panama City, REP. DE
PANAMA
TEL: 315-0101

PARAGUAY

Distribuidora De Instrumentos Musicales
J.E. Olear y ESQ. Manduvira
Asuncion PARAGUAY
TEL: (595) 21 492147

PERU

Audionet
Distribuciones Musicales SAC
Juan Flores 530
Miraflores
Lima - Peru
TEL: (511) 4461388

TRINIDAD

AMR Ltd
Ground Floor
Maritime Plaza
Barataria Trinidad W.I.
TEL: (868)638 6385

URUGUAY

Todo Musica S.A.
Francisco Acuna de Figueroa
1771
C.P.: 11.800
Montevideo, URUGUAY
TEL: (02) 924-2335

VENEZUELA

Instrumentos Musicales
Allegro,C.A.
Av.las industrias edf.Guitar
import
#7 zona Industrial de Turumo
Caracas, Venezuela
TEL: (212) 244-1122

EUROPE

AUSTRIA

Roland Elektronische Musikinstrumente HmbH.
Austrian Office
Eduard-Bodem-Gasse 8,
A-6020 Innsbruck, AUSTRIA
TEL: (0512) 26 44 260

BELGIUM/FRANCE/HOLLAND/LUXEMBOURG

Roland Central Europe N.V.
Houtstraat 3, B-2260, Oevel
(Westerlo) BELGIUM
TEL: (014) 575811

CZECH REP.

K-AUDIO
Kardasovska 626,
CZ-198 00 Praha 9,
CZECH REP.
TEL: (2) 666 10529

DENMARK

Roland Scandinavia A/S
Nordhavnsvej 7, Postbox 880,
DK-2100 Copenhagen
DENMARK
TEL: 3916 6200

FINLAND

Roland Scandinavia As, Filial Finland
Elannontie 5
FIN-01510 Vantaa, FINLAND
TEL: (09) 68 24 020

GERMANY

Roland Elektronische Musikinstrumente HmbH.
Oststrasse 96, 22844
Norderstedt, GERMANY
TEL: (040) 52 60090

GREECE

STOLLAS S.A.
Music Sound Light
155, New National Road
Patras 26442, GREECE
TEL: 2610 435400

HUNGARY

Roland East Europe Ltd.
Warehouse Area 'DEPO' Pf.83
H-2046 Torokbalint,
HUNGARY
TEL: (23) 511011

IRELAND

Roland Ireland
G2 Calmount Park, Calmount
Avenue, Dublin 12
Republic of IRELAND
TEL: (01) 4294444

ITALY

Roland Italy S. p. A.
Viale delle Industrie 8,
20020 Arese, Milano, ITALY
TEL: (02) 937-78300

NORWAY

Roland Scandinavia Avd.
Kontor Norge
Lilleakerveien 2 Postboks 95
Lilleaker N-0216 Oslo
NORWAY
TEL: 2273 0074

POLAND

MX MUSIC SP.Z.O.O.
UL. Gibraltarska 4
PL-03664 Warszawa POLAND
TEL: (022) 679 44 19

PORTUGAL

Roland Iberia, S.L.
Portugal Office
Cais das Pedras, 8/9-1 Dto
4050-465, Porto, PORTUGAL
TEL: 22 608 00 60

ROMANIA

FBS LINES
Piata Libertatii 1,
535500 Gheorgheni,
ROMANIA
TEL: (266) 364 609

RUSSIA

MuTek
3-Bogatyrskaya Str. 1.k.1
107 564 Moscow, RUSSIA
TEL: (095) 169 5043

SPAIN

Roland Iberia, S.L.
Paseo Garcia Faria, 33-35
08005 Barcelona SPAIN
TEL: 93 493 91 00

SWEDEN

Roland Scandinavia A/S
SWEDISH SALES OFFICE
Danvik Center 28, 2 tr.
S-131 30 Nacka SWEDEN
TEL: (08) 702 00 20

SWITZERLAND

Roland (Switzerland) AG
Landstrasse 5, Postfach,
CH-4452 Itingen,
SWITZERLAND
TEL: (061) 927-8383

UKRAINE

TIC-TAC
Mira Str. 19/108
P.O. Box 180
295400 Munkachevo,
UKRAINE
TEL: (03131) 414-40

UNITED KINGDOM

Roland (U.K.) Ltd.
Atlantic Close, Swansea
Enterprise Park, SWANSEA
SA7 9FJ,
UNITED KINGDOM
TEL: (01792) 702701

MIDDLE EAST

BAHRAIN

Moon Stores
No.16, Bab Al Bahrain Avenue,
P.O.Box 247, Manama 304,
State of BAHRAIN
TEL: 17 211 005

CYPRUS

Radex Sound Equipment Ltd.
17, Diagorou Street, Nicosia,
CYPRUS
TEL: (022) 66-9426

IRAN

MOCO INC.
No.41 Nike St., Dr.Shariyati Ave.,
Roberoye Cerahe Mirdamad
Tehran, IRAN
TEL: (021) 285-4169

ISRAEL

Halilit P. Greenspoon & Sons Ltd.
8 Retzif Ha'aliya Hashnya St.
Tel-Aviv-Yafo ISRAEL
TEL: (03) 6823666

JORDAN

AMMAN Trading Agency
245 Prince Mohammad St.,
Amman 1118, JORDAN
TEL: (06) 464-1200

KUWAIT

EASA HUSAIN AL-YOUSIFI & SONS CO.
Abdullah Salem Street,
Safat, KUWAIT
TEL: 243-6399

LEBANON

Chahine S.A.L.
Gerge Zeidan St., Chahine
Bldg., Achrafieh, P.O.Box: 16-
5857
Beirut, LEBANON
TEL: (01) 20-1441

OMAN

TALENTZ CENTRE L.L.C.
P.O. BOX 37, MUSCAT,
POSTAL CODE 113
TEL: 931-3705

QATAR

Al Emadi Co. (Badie Studio & Stores)
P.O. Box 62, Doha, QATAR
TEL: 4423-554

SAUDI ARABIA

aDawlah Universal Electronics APL
Corniche Road, Aldossary
Bldg., 1st Floor, Alkhobar,
SAUDI ARABIA

P.O.Box 2154, Alkhobar 31952
SAUDI ARABIA
TEL: (03) 898 2081

SYRIA

Technical Light & Sound Center
Rawda, Abdul Qader Jazairi St.
Bldg. No. 21, P.O.BOX 13520,
Damascus, SYRIA
TEL: (011) 223-5384

TURKEY

Ant Muzik Aletleri Ithalat Ve Ihracat Ltd Sti
Siraselviler Caddesi
Siraselviler Pasaji No:74/20
Taksim - Istanbul, TURKEY
TEL: (0212) 249624

U.A.E.

Zak Electronics & Musical Instruments Co. L.L.C.
Zabeel Road, Al Sherooq Bldg.,
No. 14, Grand Floor, Dubai,
U.A.E.
TEL: (04) 3360715

NORTH AMERICA

CANADA

Roland Canada Music Ltd. (Head Office)
5480 Parkwood Way
Richmond B. C., V6V 2M4
CANADA
TEL: (604) 270 6626

Roland Canada Music Ltd. (Toronto Office)

170 Admiral Boulevard
Mississauga On L5T 2N6
CANADA
TEL: (905) 362 9707

U. S. A.

Roland Corporation U.S.
5100 S. Eastern Avenue
Los Angeles, CA 90040-2938,
U. S. A.
TEL: (323) 890 3700

As of January 15, 2005 (ROLAND)