

 Roland®

TB-303

Owner's Manual

CONTENTS

	Page
BATTERY REPLACEMENT AND PRECAUTIONS	2
INTRODUCTION	
1 BASS AND THE TB-303.....	4
2 THE BASIC IDEA BEHIND THE TB-303.....	4
BASIC COURSE	
1 CONNECTION AND INITIAL SETTINGS.....	7
2 WRITING AND PLAYING A BASS LINE (PART 1)	9
INTERMEDIATE COURSE	
1 THE TONE CONTROL SECTION AND TUNING	33
2 WRITING THE LENGTH OF THE NOTES (ALTERNATIVE METHOD).....	35
3 WRITING AND PLAYING A BASS LINE (PART 2).....	38
4 TO WRITE YOUR OWN BASS LINES.....	49
ADVANCED COURSE	
1 USEFUL FUNCTIONS OF THE TRACK.....	69
2 APPLIED METHOD OF THE TB-303	73
TROUBLE SHOOTING	81
SOUND RANGE TABLE	88
SPECIFICATIONS	89

IMPORTANT NOTES

LOCATION:

- Operating the TB-303 near a neon or fluorescent lamp may cause noise interference. If so, change the angle of the TB-303.
- Avoid using the TB-303 in excessive heat or humidity or where it may be affected by direct sunlight or dust.

POWER SUPPLY:

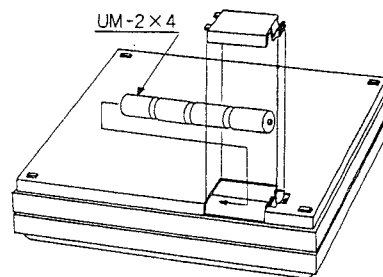
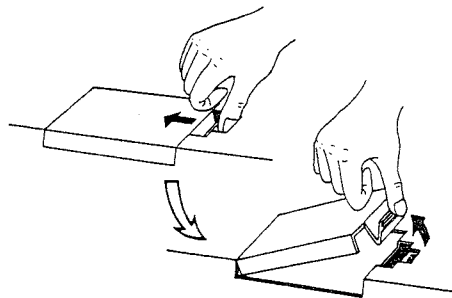
- When using an AC adaptor, use only a BOSS ACA100 or ACA220, 240 depending on your country's voltage system.

CLEANING:

- Use a soft cloth and clean only with a neutral detergent. DO NOT USE SOLVENTS SUCH AS PAINT THINNER.

BATTERY REPLACEMENT AND PRECAUTIONS:

- Replace the batteries with a complete set of new batteries when the BATTERY CHECK indicator flashes, signalling a drop in voltage, or if the sound becomes inferior.
- Replace with four 1.5v dry cell batteries (UM-2).
- The TB-303 features a non-volatile memory, which will retain patterns when switched OFF. It relies on its batteries for a backup circuit to protect these memories.
- If the batteries are changed within one minute, the memory will hold the DATA.
- Be sure to keep the batteries in the housing, even when using an AC adaptor. Then, if the AC adaptor is disconnected, operation immediately changes to battery, allowing continued performance.



TB-303 INTRODUCTION

The TB-303 is an automatic Bass machine which can memorize the Bass line of a musical piece and replay it automatically.

1 BASS AND THE TB-303

A musical bass line involves many complex factors, such as different pitches and beats, and consequently it is a difficult thing to reproduce automatically. It may vary depending on the rhythm, chord progression, style of music and the character of the musician. Sometimes it can take the role of a low melody, then it might outline the chords or

become a strong rhythmic influence in an ensemble. But overall it is a very important part of the rhythm section, following the chord progression, mainly using the root and fifth note. (As shown below) Before you enter the Basic Course, it is necessary to understand the idea behind the TB-303

● Bass line example:

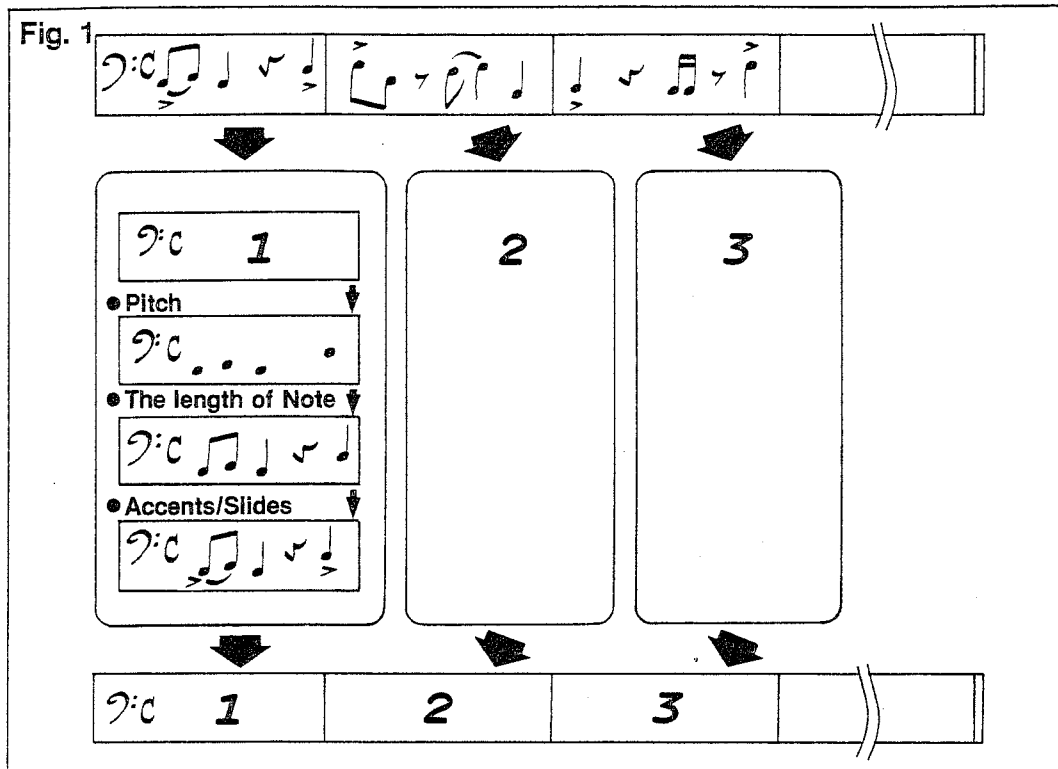
The image shows three staves of musical notation in bass clef, 4/4 time. The first staff is labeled 'C' and shows a simple bass line with notes G2, B1, D2, F2, G2, B1, D2, F2, G2, B1, D2, F2, G2. The second staff shows a chord progression: C, Am, Dm, G. The notes are G2, B1, D2, F2, G2, B1, D2, F2, G2, B1, D2, F2, G2. The third staff shows a chord progression: C(2), b, F(2), b. The notes are G2, B1, D2, F2, G2, B1, D2, F2, G2, B1, D2, F2, G2.

2 THE BASIC IDEA BEHIND THE TB-303

In order to memorize a Bass line, divide it into each measure (pattern) and memorize one pattern at a time. Each "pattern" can remember various musical factors, such as 'pitch', 'length of note' and 'accent', individually. After memorizing several patterns, these patterns may be joined in order to produce the Bass

line of a musical piece. (Fig. 1)

The following is a description only of the operation of the TB-303. For precise instructions refer to the Basic Course.



A. PITCH

1. HOW TO MEMORIZE PITCH



Press the key switches on the panel, in order, for one pattern.


2. KEY SWITCHES AND RANGE


The key switches have only one octave on the panel, but actually you can play four octaves by using the transpose switches. Then by using these additional switches, the TB-303 can easily cover the essential range of an electric or acoustic bass.

B. THE LENGTH OF NOTE

■ HOW TO MEMORIZE THE LENGTH OF THE NOTES

By pressing the correct combination of the switches labelled  and , the rhythm for one pattern can be memorized.

The use of sixteenth notes () as the basic writing tool allows highly technical

bass lines to be written into memory, while slower timings can be achieved by using combinations of this basic unit (e.g. ).

C. ACCENT

After memorizing the pitch and length of note (rhythm), particular features of BASS instruments, like accent or portamento (slide), can be written into memory where needed.

■ HOW TO MEMORIZE ACCENT OR PORTAMENTO

Whilst calling back the memorized pattern, place the accent or slide against the required note by using the switches.

One complete Bass PATTERN has now been written into memory.

D. COMPLETING THE BASS LINE

After memorizing several patterns, complete the Bass line for a piece of music by combining these patterns.

■ HOW TO MEMORIZE THE BASS LINE

To memorize the Bass line, simply select each measure, in turn, and write them into the memory. One pattern can be chosen several times, and can also be transposed into any other key. Consequently, if the Bass line is simply a repetition of one pattern, or only a transposition of that pattern, then you only need to write one pattern into memory (Fig. 2).

One complete Bass Line has now been written into memory.

E. CREATING A SOUND

The TB-303 cannot memorize the tone colour, but can make a Bass sound, just like a synthesizer, by using the TONE CONTROL SECTION. In this way, the TB-303 can create an appropriate Bass sound for the Bass line you have written.

F. HOW TO USE THIS MANUAL

The switches and control knobs have several functions, so operating the TB-303 may seem a little complicated. You may find difficulty using the TB-303 at first, because it is so different from a Bass Guitar or a keyboard instrument. Therefore, this manual includes a Basic, Intermediate and Advanced Course to help you understand these operations, step by step. However, each individual operation is quite simple, so take your time and master each step.

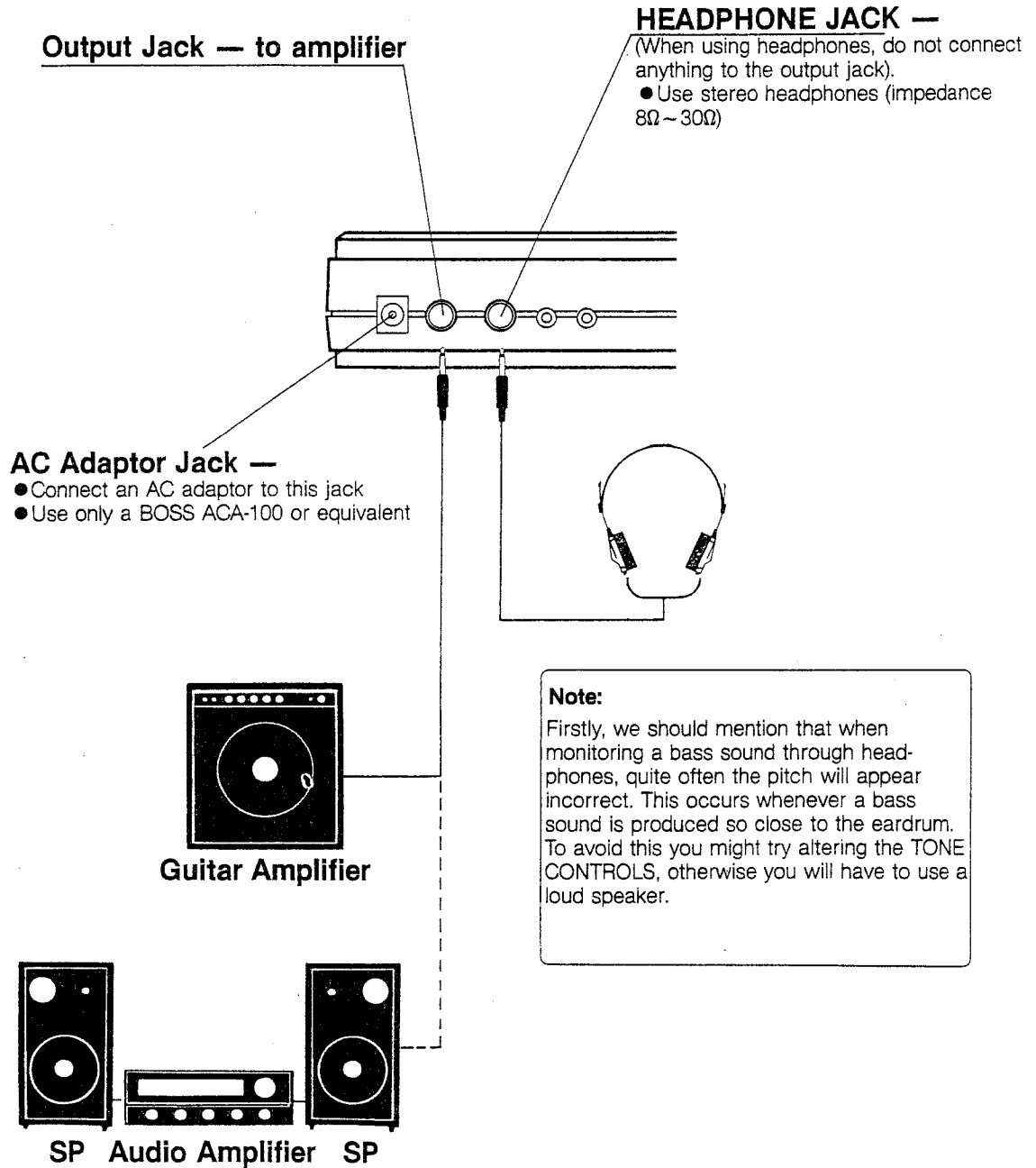
Fig. 2

The diagram shows two staves of music. The top staff is in C major and contains a sequence of notes: C2, D2, E2, F2, G2, A2, B2, C3. The first measure is labeled 'C', the second 'F', and the third 'G'. A downward arrow points to the first measure with the text 'Memorize this pattern only.' The bottom staff shows the same sequence of notes transposed. The first measure is labeled 'C', the second 'F', and the third 'G'. Below the bottom staff, there are two bullet points: '● Shifting up a perfect fourth' and '● Shifting up a perfect fifth'.

BASIC COURSE

1 CONNECTIONS AND INITIAL SETTINGS

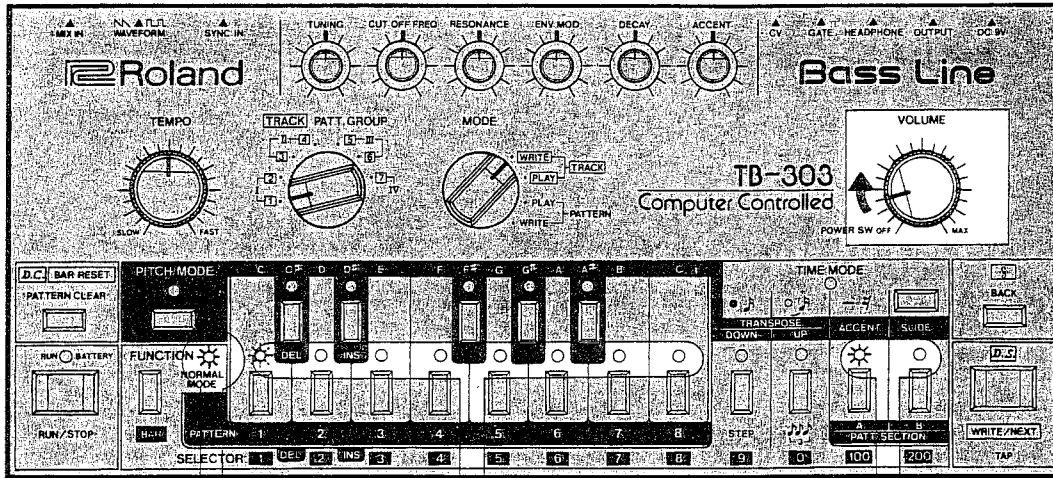
A. CONNECTIONS



B. INITIAL SETTINGS

① Complete the connections as instructed in A. CONNECTIONS on page 7.

② Turn on the POWER SWITCH/VOLUME CONTROL (A) (clockwise).

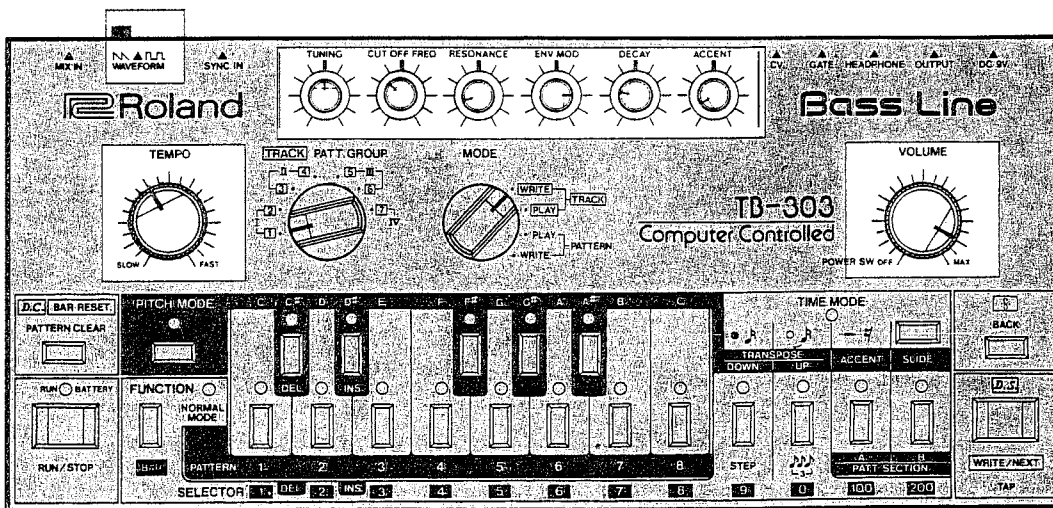


The NORMAL MODE indicator (M) lights up.

One of the SELECTOR SWITCHES 1 to 8 flashes.

One of the SELECTOR SWITCHES 100 to 200 is lit.

③ Set the control knobs on the panel as shown below.



2 WRITING AND PLAYING A BASS LINE (Part 1)

A. Operation.....Operate whilst looking at the Procedure Table as an appendix.

The TB-303 can memorize the Bass line into a computer memory by using switches, and

we call this process WRITING. Let's begin by writing the following simple four bar Bass line.

Sample Score

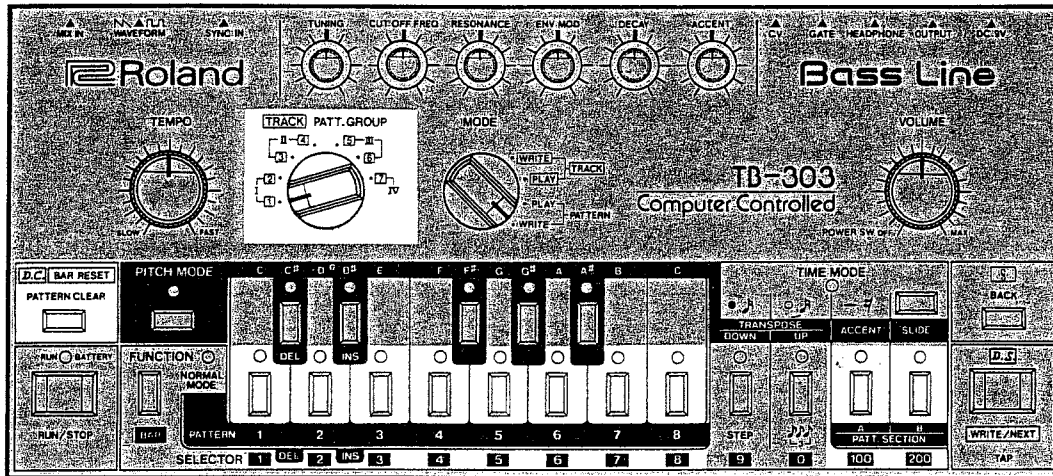
Writing Table

PITCH	C	E	G	A	C	E
TIME	● ○ ○ ○ ○ ○	● ○ ○ ○ ○ ○	● ○ ○ ○ ○ ○	● ○ ○ ○ ○ ○	● ○ ○ ○ ○ ○	● ○ ○ ○ ○ ○

1 Write the Bass pattern of the first measure (in C major) into the memory position chosen by the SELECTOR SWITCH (N) marked 1.

	Operation	Result	Operation Notes
1	Set the TB-303 according to the instructions in INITIAL SETTINGS (page 8).		Make sure the TB-303 is not running. (the BATTERY CHECK/RUN indicator button (J) is OFF).
2	Set the MODE SELECTOR (B) to PATTERN WRITE. 		The TB-303 is now ready to write a Bass pattern.

SELECTING



3	<p>Select GROUP 1 by using the TRACK/PATTERN GROUP SELECTOR (C)</p>		<p>Refer to ABOUT THE MEMORY POSITIONS on the next page.</p>
4	<p>Select PATTERN SECTION A by pressing the SELECTOR SWITCH (N) marked 100.</p>	<p>The indicator lights up.</p>	<p>Refer to ABOUT THE MEMORY POSITIONS on the next page.</p>
5	<p>Select PATTERN 1 by pressing SELECTOR SWITCH (N) marked 1.</p>	<p>The indicator starts flashing.</p>	<p>Writing switches are selected from the Selector switches (N) 1 to 8.</p>

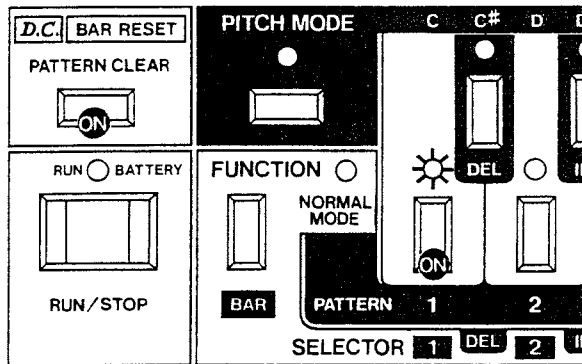
Whilst holding the SELECTOR SWITCH (N) marked **1** down, press the CLEAR/RESET button (I). This clears the chosen memory position of any previous data.

Refer to the operating note.

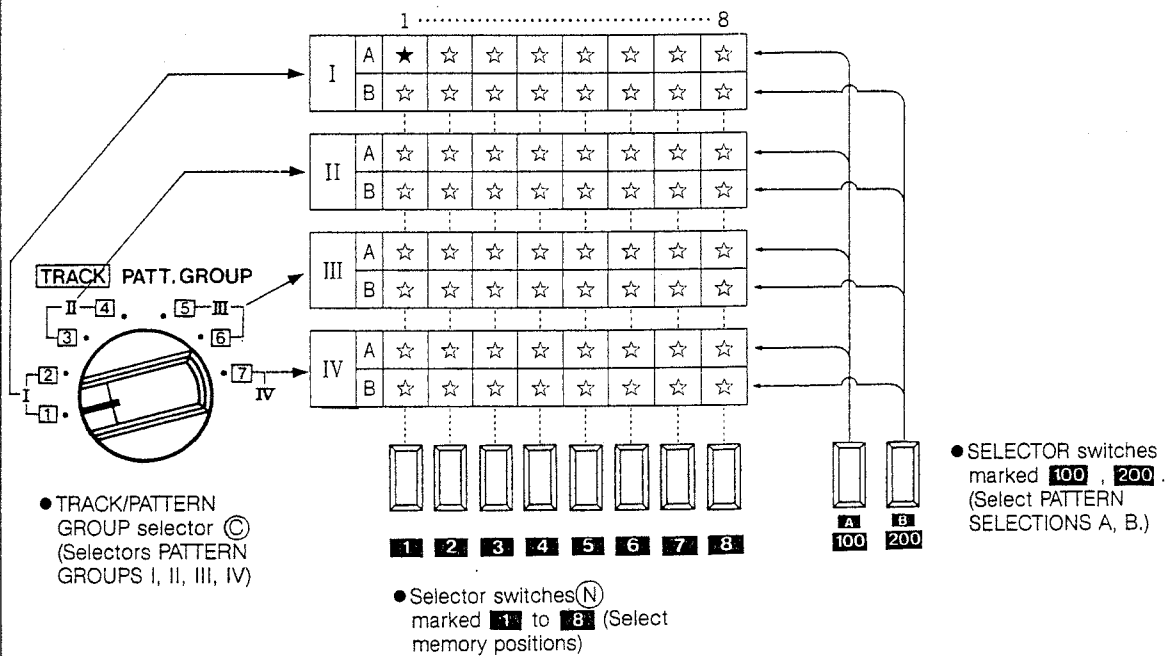
A new Bass pattern can be written into.

It is not out of order even if other indicators light up when CLEAR/RESET button and FUNCTION button are being pressed.

6



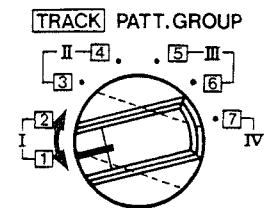
■ ABOUT THE MEMORY POSITIONS



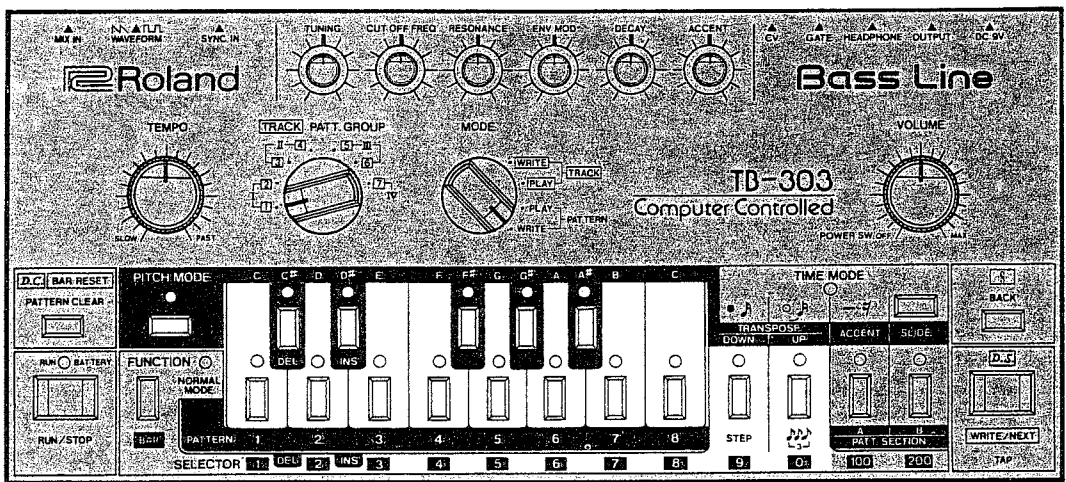
- Write the patterns into ☆ signs. (There are 64 patterns altogether.)

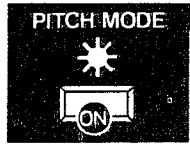
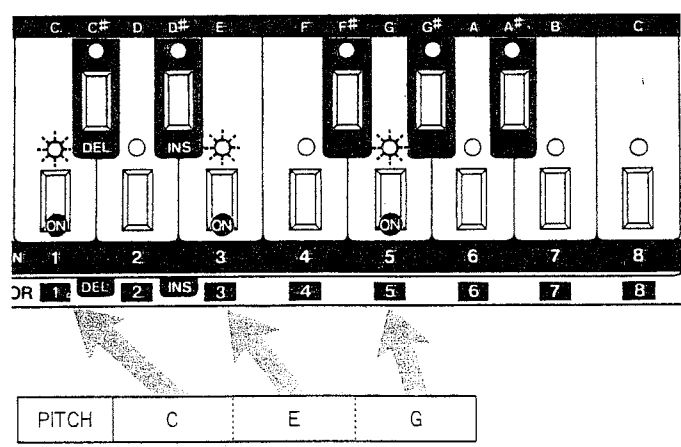
Select one pattern by operating 3 switches. (Select ☆ sign from page 10)

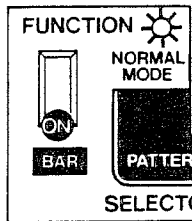
- When the PATTERN GROUP selector is between two levels, you can set the knob to either position (as shown beside).




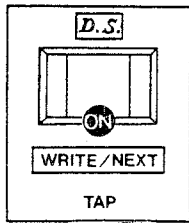
WRITING THE PITCH



7	<p>Press the PITCH MODE button (H)</p> 	<p>The PITCH MODE indicator (G) lights up.</p>	<p>The TB-303 is ready to accept the pitches.</p>				
8	<p>According to the "WRITING TABLE" for PITCH, press the key-switches representing the notes, in order, from left to right. (Refer to "How to Use the Table")</p> 	<p>The sound is heard and the indicator illuminates.</p>	<p>● HOW TO USE THE WRITING TABLE FOR</p> <table border="1" data-bbox="999 1287 1362 1340"> <tr> <td>PITCH</td> <td>C</td> <td>E</td> <td>G</td> </tr> </table> <p>→</p> <ul style="list-style-type: none"> • The letters in the table show the pitch of the notes. • There are two 'C' keys on the keyboard, the upper 'C' is marked "C". • The pitches line up, in the order of playing, from left to right. <p>If you press the wrong switch, and</p> <ol style="list-style-type: none"> wish to begin again - repeat the operation from 7. only need correct one note — refer to 'HOW TO USE THE & / BACK BUTTON'. 	PITCH	C	E	G
PITCH	C	E	G				

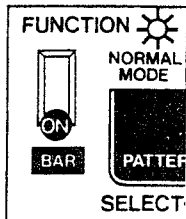
9	<p>Press the FUNCTION button (L).</p> 	<p>The NORMAL MODE indicator (M) lights up.</p>	<p>The pitches have now been written into memory, and the TB-303 is in its NORMAL MODE.</p>
<p>● HOW TO USE */BACK BUTTON</p> <p>In case of correcting the mistaken sound, press the */BACK button (Q) after pressing the wrong key-switch. When pressing the */BACK button, one sound is back to before (It is the condition of finishing writing one sound before the wrong sound), so you can re-write the right key-switch.</p>			

CHECKING THE PITCHES (This can be omitted)

10	<p>Press the PITCH MODE button (H)</p> 	<p>The PITCH MODE indicator (G) lights up.</p>	
11	<p>Press the TAP button (R) slowly three times.</p> 	<p>The indicators light up to show the written pitch. The notes are heard in order</p>	<p>Whenever you press the TAP button, the sound is heard.</p> <ul style="list-style-type: none"> • In this case, you must press the button three times because you have written three pitches. If you press the button more than three times, you will hear a random selection of notes. • If you wish to check it again, repeat the operation from 10. • Be sure not to press the key-switches this time, otherwise the pitch you have written will change.
<div style="display: flex; justify-content: space-around; align-items: center;"> <div style="border: 1px solid black; padding: 5px; text-align: center;">RIGHT</div> <div style="border: 1px solid black; padding: 5px; text-align: center;">WRONG</div> </div> <div style="display: flex; justify-content: space-around; margin-top: 20px;"> <div style="text-align: center;"> <p>Go ahead to operation 12 on the next page.</p> </div> <div style="text-align: center;"> <p>Repeat the operation from 7</p> </div> </div>			

12

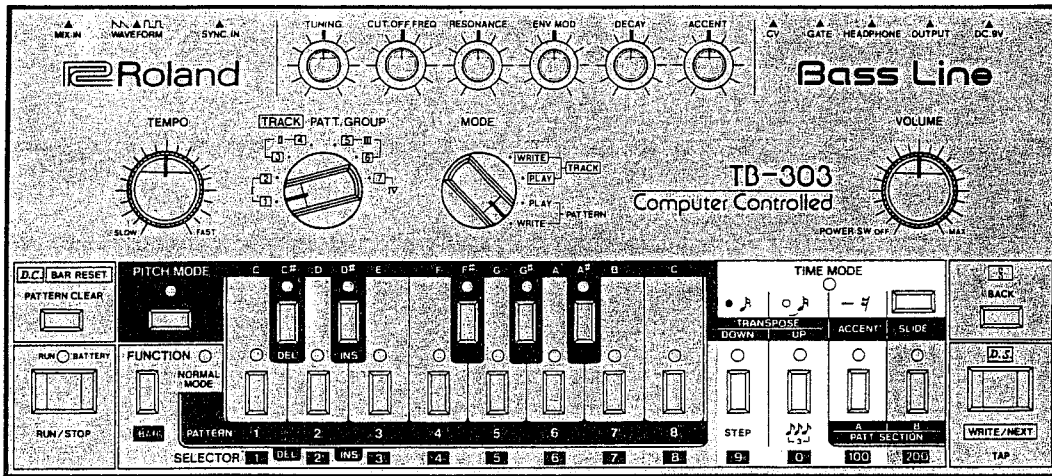
Press the FUNCTION button (L).



The NORMAL MODE indicator (M) lights up.

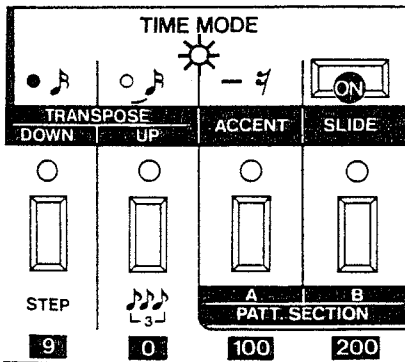
Once again the TB-303 is in NORMAL MODE.

WRITING THE LENGTH OF NOTE



13

Press the TIME MODE button (P).



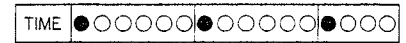
The TIME MODE indicator (O) lights up.

The length of note can be written into.

According to the Writing Table for **TIME**, press the switches. (Refer to "HOW TO USE THE WRITING TABLE")

The appropriate indicators light up, as you press each switch.

● HOW TO USE THE WRITING TABLE FOR **TIME**

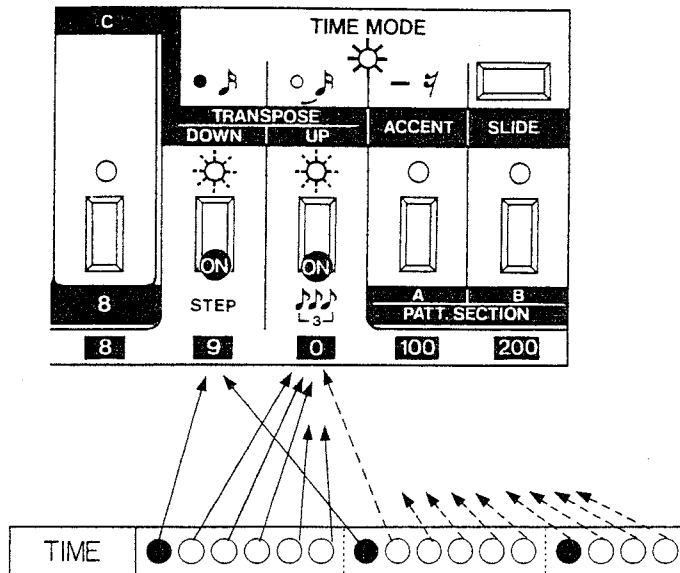


- Press the SELECTOR switch marked **9**
- Press the SELECTOR switch marked **0**
- Press the SELECTOR switch marked **100** (not used in this example).

Each sign has been drawn in order, from left to right. When writing in the TIME MODE, no sound is produced.

- Should you fail to press a switch, repeat the operation from 13.
- When you have finished writing the length of note, the TB-303 automatically changes to the NORMAL MODE.

14



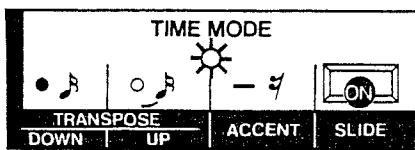
After pressing the switches 16 times, the NORMAL MODE indicator (M) lights up.

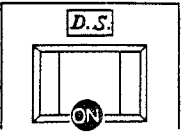
CHECKING THE LENGTH OF NOTE (This can be omitted)

15

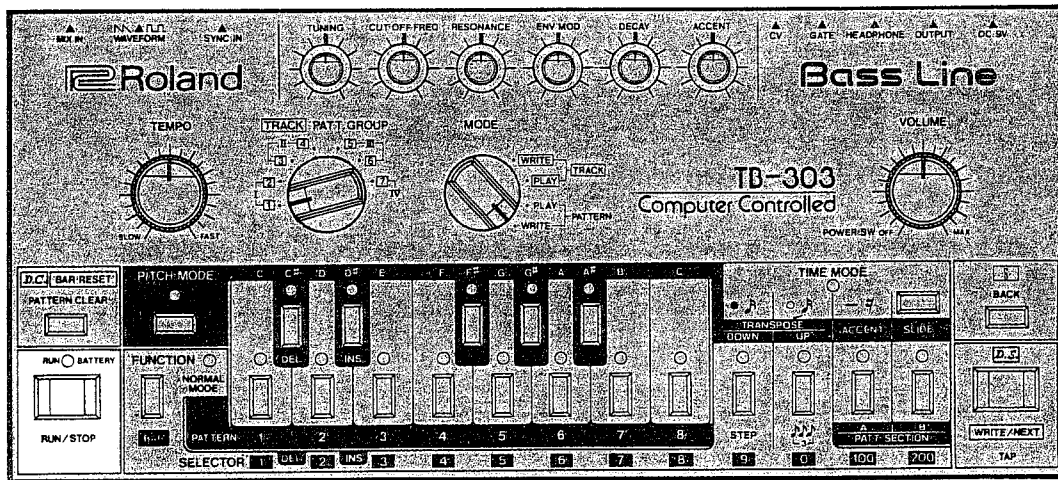
Press the TIME MODE button (P)

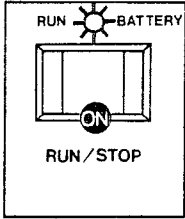
The TIME MODE indicator (O) lights up.

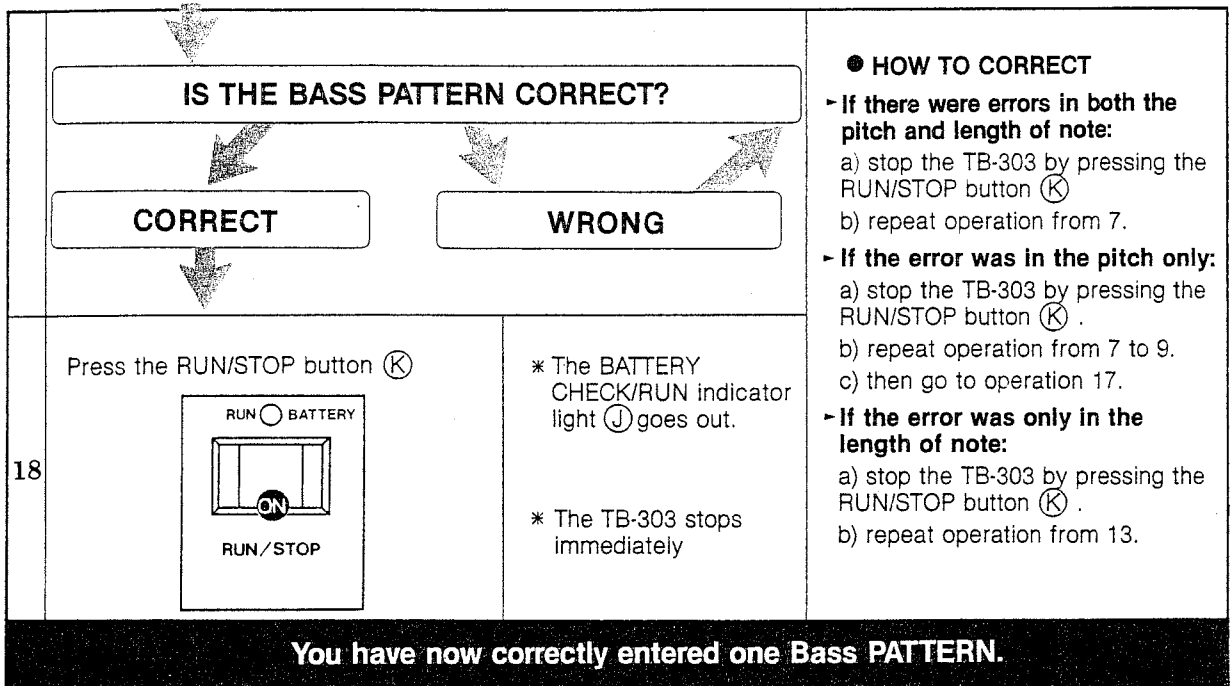


16	<p>Press the TAP button (R) slowly 16 times.</p> 	<p>The indicators illuminate in the appropriate order.</p>	<p>Remember, no sound is produced in the TIME MODE. After pressing 16 times, it automatically changes to the NORMAL MODE. If you wish to check it again, repeat the operation from 15.</p>
<p>The indicators light up in the correct order.</p> <p>Go ahead to Operation 17.</p>		<p>WRONG</p> <p>Repeat from the operation 13.</p>	

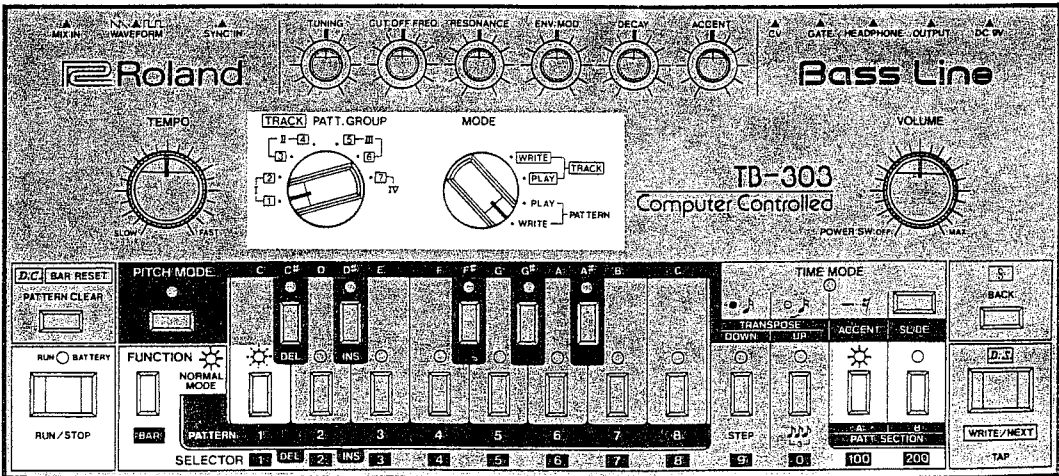
PLAY



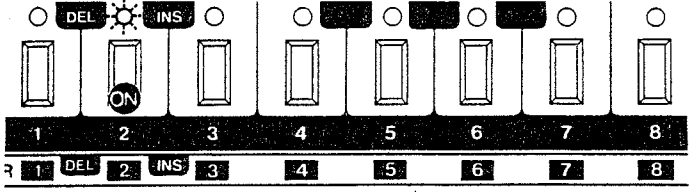
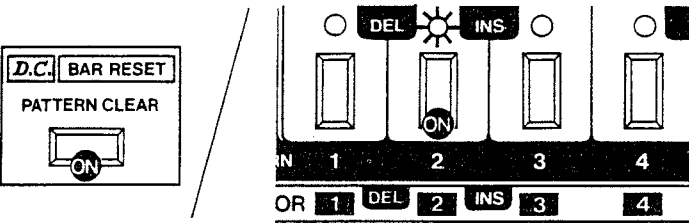
17	<p>Press the RUN/STOP button (K).</p> 	<p>The BATTERY CHECK/RUN indicator (J) lights up and the Bass pattern will play repeatedly.</p>	<p>Use the TEMPO control knob (D) and POWER SWITCH/VOLUME control knob (A) to adjust tempo and volume.</p>
----	---	---	--




2 In the same way, write the Bass pattern of the second measure (in A minor) in the SELECTOR switch (N) marked **2** (memory position 2).

Operation	Result	Operation Notes
<p>Make sure the control knobs and indicators are as shown below.</p>		
<p>1</p>		

SELECTING

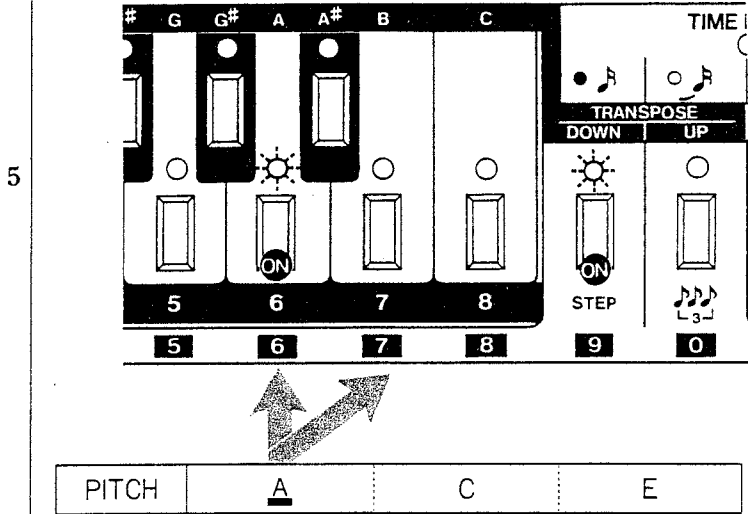
2	<p>Press the SELECTOR switch (N) marked 2.</p> 	<p>The indicators of 2 flashes.</p>	<p>Select the SELECTOR switch marked 2 (PATTERN GROUP-1, PATTERN SECTION-A). (As the PATTERN GROUP-1 and PATTERN SELECTION-A have already been selected in the previous example, this need not be changed)</p>
3	<p>Holding the SELECTOR switch (N) marked 2 down, press the CLEAR/RESET button (I).</p> 		

WRITING THE PITCH

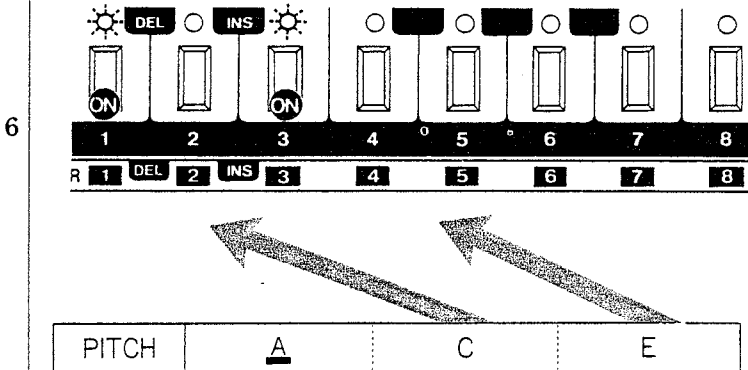
4	<p>Press the PITCH MODE button (H).</p> 	<p>The indicator lights up.</p>	
---	---	---------------------------------	--

Whilst holding the SELECTOR switch (N) marked 9 down, press the "A" key-switch. (Refer to "TRANPOSE")

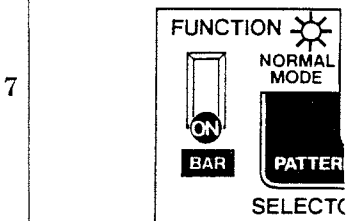
Indicatorlights up
The sound A, which is one octave lower, will be heard.



According to the Writing Table for PITCH, press the key-switches in order.



Press the FUNCTION button (L).



■ TRANSPOSE

When writing a pitch one octave down (or up) from the keyboard range, press the SELECTOR switch (N) marked **9** (TRANPOSE DOWN) or **0** (TRANPOSE UP) for moving the range of the keyboards, then press the appropriate key-switch.

The first "A" sound of the second measure is one octave down from the keyboard on the panel.

HOW TO USE THE WRITING TABLE FOR TRANSPOSE

A (black bar under the pitch letter)

.....represents a note one octave down.


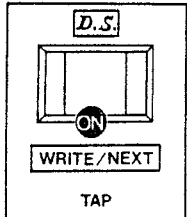
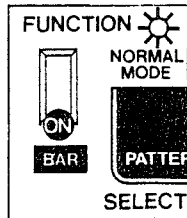
.....holding the SELECTOR switch marked **9** down, press the key-switch.

A (black bar over the pitch letter)

.....represents a note one octave up.

.....holding the SELECTOR switch marked **0** down, press the key-switch.

CHECKING THE PITCH

8	<p>Press the PITCH MODE button (H) .</p> 		
9	<p>Press the TAP button (R) for confirmation.</p> 		
10	<p>Press the FUNCTION button (L) .</p> 		

WRITING THE LENGTH OF NOTE


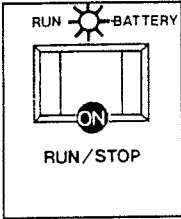

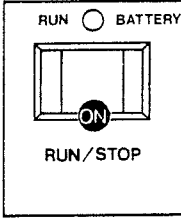
11 Press the TIME MODE button (P).

12 According to the Writing Table for **TIME**, press the appropriate switches (SELECTOR switch (N) marked **9**, and **0**, in order).

CHECKING THE LENGTH OF NOTE (This can be omitted)

13 Press the TIME MODE button (P).


14 Press the TAP button (R) for confirmation.

PLAY		
15	<p>Press the RUN/STOP button .</p> 	<p>If the pattern is wrong, refer to "HOW TO CORRECT (Page 17).</p>
16	<p>If the pattern is correct, stop the TB-303 by pressing the RUN/STOP button  again.</p> 	



Now you have correctly entered two Bass PATTERNS

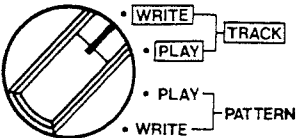
3. Complete the Bass Line of Four Measures Using these Two Patterns. (C and Am)

Sample Score



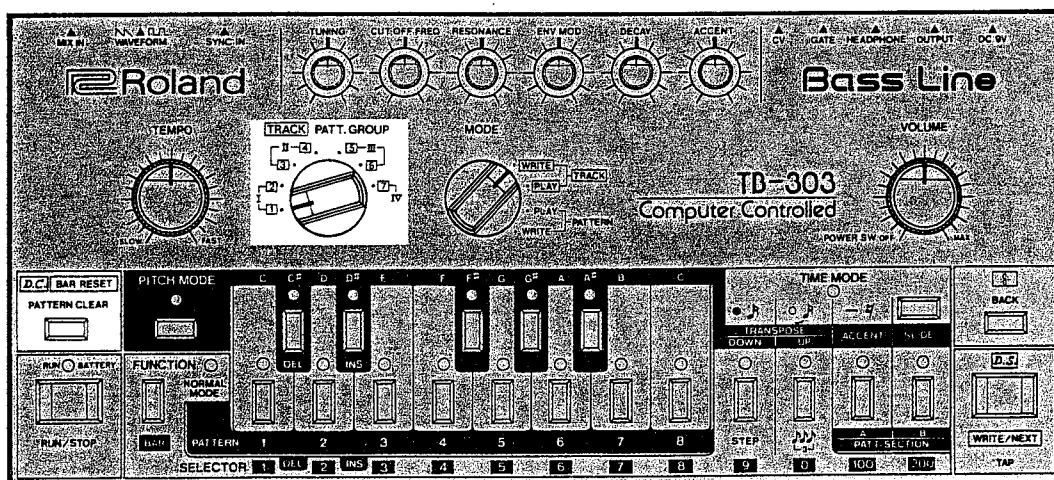
PATTERN GROUP I

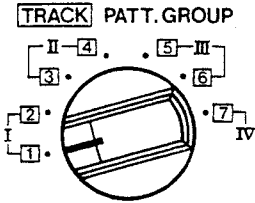
	C	Am	Dm	G7
Track Score	1 — A	2 — A	2-A 	1-A  :

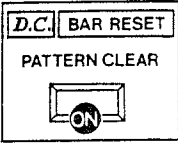
	Operation	Result	Operation Notes
I	<p>Stop the TB-303 by pressing the RUN/STOP button. Set the MODE selector (B) to TRACK WRITE.</p> <p>MODE</p> 		

SELECTING THE TRACK

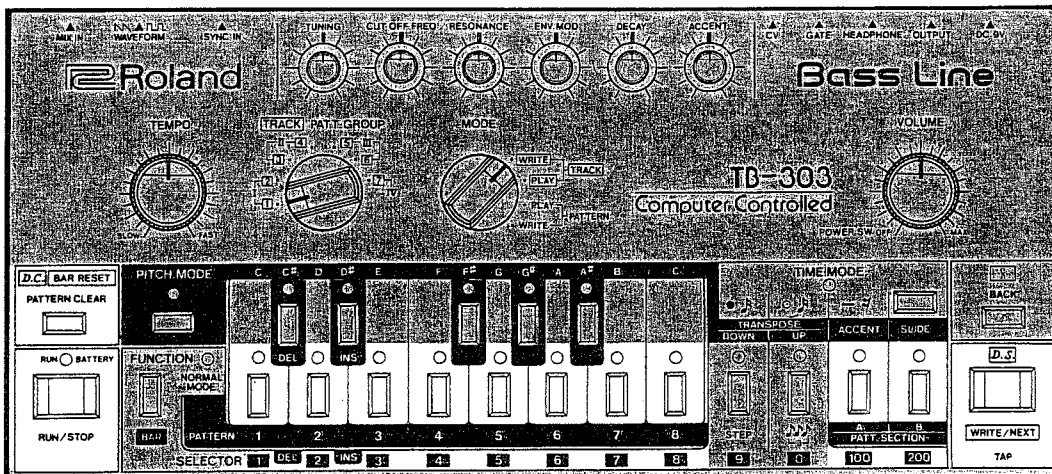
Select a TRACK in which to write the Bass line. (Refer to the Operation Notes)

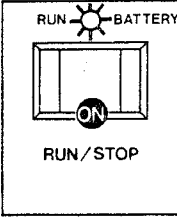


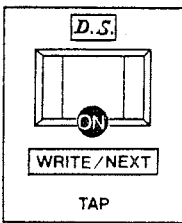
2	<p>Set the TRACK/PATTERN GROUP selector (C) to 1</p> 	<p>● TRACKS</p> <p>A Track can memorize the Bass line of a musical piece by combining several Bass Patterns in order.</p> <p>There are 7 Tracks all together and they are selected by the TRACK/PATTERN GROUP selector (C).</p> <p>The PATTERN GROUP (e.g. PATTERN GROUP-I) of the Bass Pattern to be written into the Track is also decided at the same time.</p>
---	--	--

3	<p>Press the CLEAR/RESET button (I).</p> 	<p>In the TRACK WRITE MODE, this button simply resets the track to the beginning, so that it is ready to write into the first bar of the musical piece.</p> <p>Any indicators flashing at this stage are not important and will be explained later.</p>
---	--	---

WRITING INTO THE TRACK

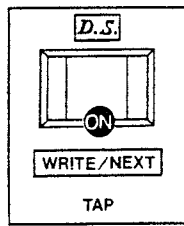


4	<p>Press the RUN/STOP button (K).</p> 	<p>The BATTERY CHECK/RUN indicator (J) lights up and the Bass Pattern will start to play.</p>	<p>For convenience, TRACK WRITING is performed while the TB-303 is playing.</p> <p>(The Bass pattern playing is the first measure of a previous composition in the selected TRACK.)</p>
---	---	---	---

<p>5</p>	<p>According to the TRACK SCORE, select the Bass Pattern of the first measure (Press the SELECTOR switch # 1 PAT. SECTION-A.....C)</p> <p>*NOTE: Even if the Bass Pattern is already at the selected position, make sure you press the switch again.</p>	<p>The indicator of the SELECTOR switch marked 100 lights up, the indicator marked 1 flashes. The Bass Pattern in 1 will be played repeatedly.</p>	<p>● HOW TO USE THE TRACK SCORE</p> <p>PATTERN GROUP-1</p> <table border="1"> <tr> <td>C</td> <td>Am</td> <td>Dm</td> <td>G7</td> </tr> <tr> <td>1 - A</td> <td>2 - A</td> <td>2 - A ⊕</td> <td>1 - A ⊕ :</td> </tr> </table> <ul style="list-style-type: none"> • The letters and numerals in a box signify the bass pattern you have selected. • Letters in a circle show the key-switch you press (refer to operation 10). • The letter on the left shoulder of the box shows the Chord name. • The title shows that all the Bass Patterns are from PATTERN GROUP-1. • The Bass Patterns line up left to right, in order. 	C	Am	Dm	G7	1 - A	2 - A	2 - A ⊕	1 - A ⊕ :
C	Am	Dm	G7								
1 - A	2 - A	2 - A ⊕	1 - A ⊕ :								
<p>6</p>	<p>Press the TAP button (R).</p> 	<p>The Bass Pattern will change.</p>	<p>When pressing the TAP button, the selected Bass Pattern (as in Operation 5) will be written into the first measure. At the same time, the TB-303 moves on to the second measure and bar 2 of the previous composition will be played.</p> <p>Now you are ready to change bar 2, if you need to.</p>								
<p>7</p>	<p>Select your Bass Pattern for the 2nd measure (SELECTOR switch # 2; PAT. SECTION-A..... Am)</p> <p>*NOTE: (Even if the Bass Pattern is already being played, make sure you press the switch once again)</p>	<p>The indicator of the SELECTOR switch marked 100 lights up, the switch marked 2 flashes, the Bass Pattern written into # 2 will be played repeatedly.</p>									

8

Press the TAP button (R) .



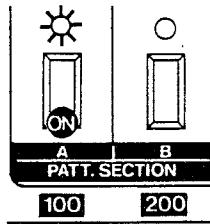
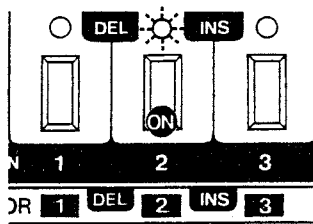
The Bass Pattern will change.

The selected Bass Pattern will be written into bar 2 and the TB-303 is ready for bar 3.

9

Select your Bass Pattern for the 3rd measure (SELECTOR switch #2, PAT. SECTION-A..... Am)

*NOTE: (Even if the Bass Pattern is already being played, make sure you press the switch once again)



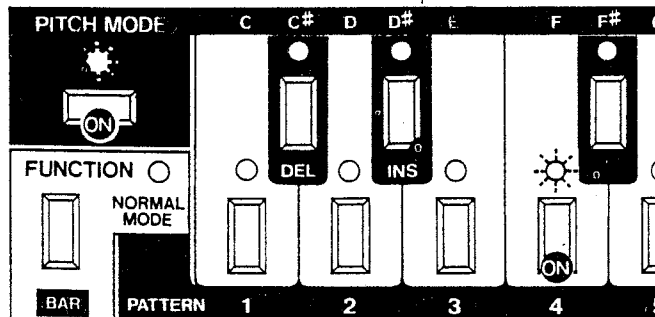
10

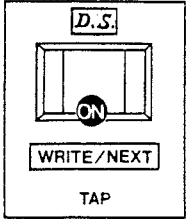
Holding the PITCH MODE button (H) down, press the key-switch "F".

THE PITCH MODE indicator (G), and the indicator of key-switch (E) light up. The Bass Pattern of Am will shift to Dm.

Shifting the key from Am to Dm by pressing the F key-switch we refer to simply as "SHIFTING" (Refer to SHIFTING on the next page)

If you press the wrong key-switch, repeat operation from 10.



11	<p>Press the TAP button (R)</p> 	<p>The Bass Pattern will change.</p>	<p>The 3rd measure, shifted to Dm in operation 10, will be written into the memory, and the TB-303 will proceed to the 4th measure.</p>
----	---	--------------------------------------	---

■ SHIFTING

The written Bass Pattern can be shifted into any other key you want by pressing the chosen key-switch. This saves a great deal of memory space while simplifying the operation of the TB-303.

● SHIFTING AND WRITING

The key of Am (the 2nd measure) and Dm (the 3rd measure) of the Sample Score are different, but the organization of the patterns is the same. So by shifting the Am Pattern up, you have the Dm Pattern.

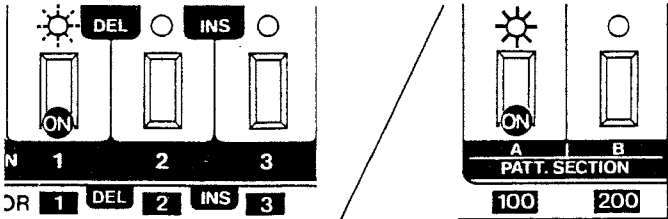
■ HOW TO CHOOSE THE KEY-SWITCHES TO "SHIFT" CORRECTLY.

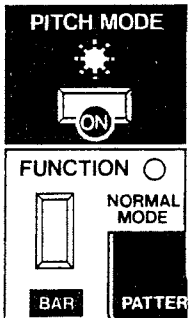
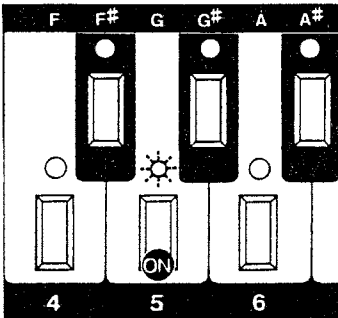

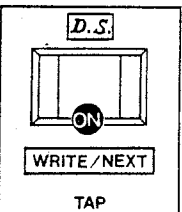
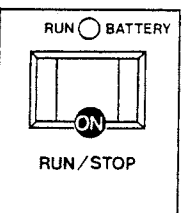
The key-switches, when shifting the Bass Pattern, are decided by the INTERVAL between the written Pattern and the shifted Pattern. This interval is then added to the TB-303, but relative to the key of C. In this case, the interval between Am and Dm is a perfect fourth. When the original key is C, F is a perfect fourth from C, so select the F key-switch. Similarly, to change an Am to Em, an interval of a perfect fifth, choose the key-switch that is a perfect fifth above C, that key-switch is G.

This method is very simple, although sometimes it can be confusing, so as an appendix to this manual, we have included a "CHORD SHIFT SCALE". Please read the explanation of this "CHORD SHIFT SCALE" carefully.

WRITING THE LAST MEASURE

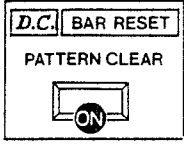
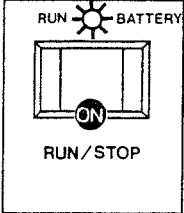
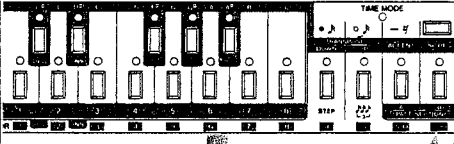

Writing the last measure (in this example, Measure 4) is a little different to writing the previous measures.

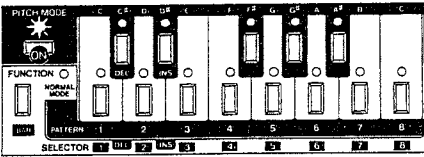
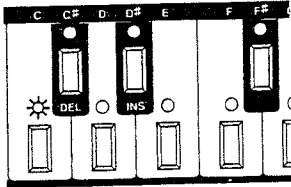
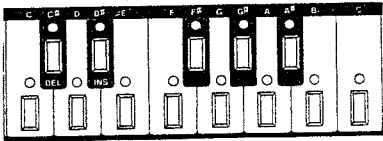
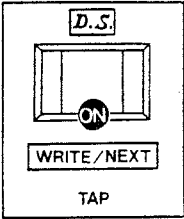
12	<p>Select your Bass Pattern for the 4th measure (SELECTOR switch # 1, PAT. SECTION.....C)</p> <p>*NOTE: Even if the Bass Pattern is already being played, make sure you press the switch once again.</p>	
----	--	--

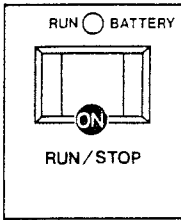
13	<p>Holding the PITCH MODE button (H) down, press the G key-switch.</p> 	<p>* The Bass Pattern in C, will shift to G.</p> 	<p>The key of the 1st measure (C), and the 4th measure (G₇), of the Sample Score are different, but the organization of the pattern is the same. Therefore you can write the G Pattern by shifting the C Pattern.</p>
14	<p>Press the CLEAR/RESET button (L).</p> 		<p>In this case, the CLEAR/RESET button assigns the sign D.C., to the 4th measure. So now the TB-303 will recognize bar 4 as the last measure and begin again at bar 1.</p>
15	<p>Press the TAP button (R).</p> 	<p>* The Bass Pattern will change.</p>	<p>The shifted G Pattern will be written into the 4th measure as in Operation 13. After writing the 4th measure, the TB-303 moves onto the 5th measure, but a D.C. sign is set at the 4th measure so the 5th measure cannot play.</p>
16	<p>Press the RUN/STOP button (K).</p> 	<p>* The BATTERY CHECK/RUN indicator (J) goes out.</p>	<p>You have now completed one full Bass Track.</p>

CHECKING & CORRECTING THE TRACK

(This can be omitted)

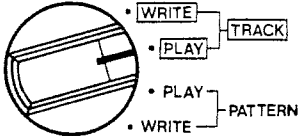
17	<p>Press the CLEAR/RESET button (I), this resets the track to the first measure.</p> 		
18	<p>Press the RUN/STOP button (K).</p> 	<p>*The BATTERY CHECK/RUN indicator (J) lights up, and the Bass Pattern of the 1st measure will be played.</p>	
19	<p>Check the Bass Pattern, is it the correct pattern, or not ?</p> <div style="display: flex; justify-content: space-around; align-items: center;"> <div style="border: 1px solid black; padding: 5px; text-align: center;">WRONG</div> <div style="border: 1px solid black; padding: 5px; text-align: center;">RIGHT</div> </div> <p>Select the right Bass Pattern again.</p> 		
20	<p>Hold the PITCH MODE button (H) down. (Right until operation 21 is completed)</p> 	<p>* The PITCH MODE indicator (G), and the indicator of the C key-switch lights up.</p>	<p>While holding the PITCH MODE button (H), you can check the amount of "shift".</p>

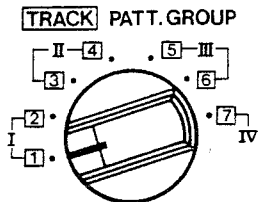
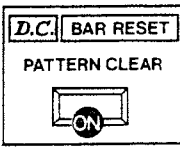
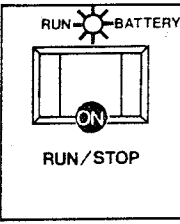
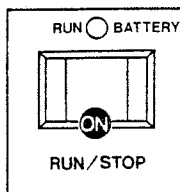
	<p>Confirm whether the written key is right or not, by watching the indicators on the keyboard.</p> <div style="display: flex; justify-content: space-around; align-items: center;"> <div style="border: 1px solid black; padding: 5px; text-align: center;">WRONG</div> <div style="border: 1px solid black; padding: 5px; text-align: center;">RIGHT</div> </div> <p>Shift the key to the right key. (Holding the PITCH MODE button H down, press the correct key-switch</p> <p>21 </p>	<p>● HOW TO USE THE INDICATORS</p> <ul style="list-style-type: none"> When writing a Pattern without a "shift", the indicator of the C key-switch lights up.  <ul style="list-style-type: none"> When writing a Pattern with a "shift", the indicator of the key-switch that you pressed when shifting lights up.  <ul style="list-style-type: none"> As the 1st measure was not shifted, the indicator of the C key-switch lights up.
22	<p>Press the TAP button R</p> 	<p>* The Bass Pattern of the 2nd measure is played. Whenever pressing the TAP button, the TB-303 moves on to the next measure.</p>
23	<p>Check the Bass Pattern of the 2nd measure by repeating Operations 19 to 21.</p>	
24	<p>Press the TAP button R</p>	<p>* The Bass Pattern of the 3rd measure is played.</p>

25	Check the Bass Pattern of the 3rd measure by repeating Operations 19 to 21.		The indicator of the F key-switch lights up, because of the shift.
26	Press the TAP button (R).	*The Bass Pattern of the 4th measure is played.	
27	Check the Bass Pattern of the 4th measure by repeating Operations 19 to 21.		The indicator of G key-switch lights up, because of the shift.
28	Press the RUN/STOP button (K) after checking. 	* The BATTERY CHECK/RUN indicator (J) goes out, and the TB-303 stops.	

You have now correctly written Bass LINE of four measures into Track **1**.

4 LET'S PLAY THE TRACK

	Operation	Result	Operation Notes
1	Set the MODE selector (B) to TRACK PLAY, while the TB-303 is stopped. This sets the TB-303 into its PLAY MODE. MODE 		

2	<p>Make sure the TRACK/PATTERN GROUP selector ① is at 1, or in other words, choose TRACK 1.</p> 		
3	<p>Press the CLEAR/RESET button ①, to reset the track to the first bar.</p> 		
4	<p>Press the RUN/STOP button ④.</p> 	<p>The BATTERY CHECK/RUN indicator ② lights up, and the Bass Line, from the 1st measure to the 4th measure, plays repeatedly.</p> <p>The indicators of the SELECTOR switches change according to the playing order.</p>	<p>If something is incorrect, repeat from Operation ③ "COMPLETE THE BASS LINE OF FOUR MEASURES USING THESE TWO PATTERNS". Page 22.</p>
5	<p>Stop the TB-303 by pressing the RUN/STOP button ④ again.</p> 	<p>* The BATTERY CHECK/RUN indicator ② goes out and the TB-303 stops immediately.</p>	<p>If you wish to play it again, press the RUN/STOP button ④, after pressing the CLEAR/RESET button ①</p>

● This is the Basic Method for Using the TB-303.

INTERMEDIATE COURSE

1 THE TONE CONTROL SECTION AND TUNING

A. TUNING

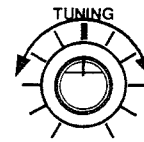
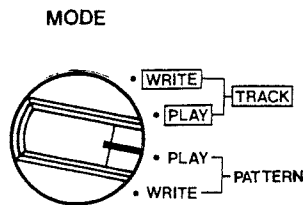
There is a control at the top of the instrument that will allow you to adjust the tuning of the TB-303 to A (220Hz) or to other instruments, like a guitar or piano.

TUNING METHOD

- ① Set the TB-303 to its initial condition, according to the section "CONNECTION AND INITIAL SETTINGS". Page 8.
- ② Set the MODE selector (B) to PATTERN PLAY.

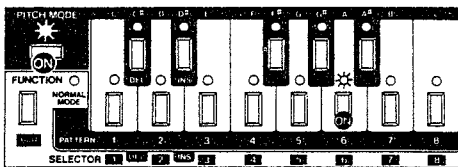
- ⑤ Adjust the TUNING control knob to tune the TB-303 to exactly A (220Hz) or to the pitch of other instruments.

- To raise the pitch, turn the knob clockwise.
- If you wish to tune to a note other than A, repeat operation 3, but press the key-switch of the pitch you want (e.g. E), then press the TAP button (R). (Shown in Diagram 1)



- ③ Holding the PITCH MODE button (H) down, press the A key-switch.

*While pressing the button, the PITCH MODE indicator (G) and the A key-switch indicator lights up.



- ④ Then, by pressing the TAP button (R), the pitch of A (approx 220Hz) will be heard. To repeat the sound, simply press the TAP button (R) again.

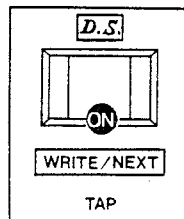
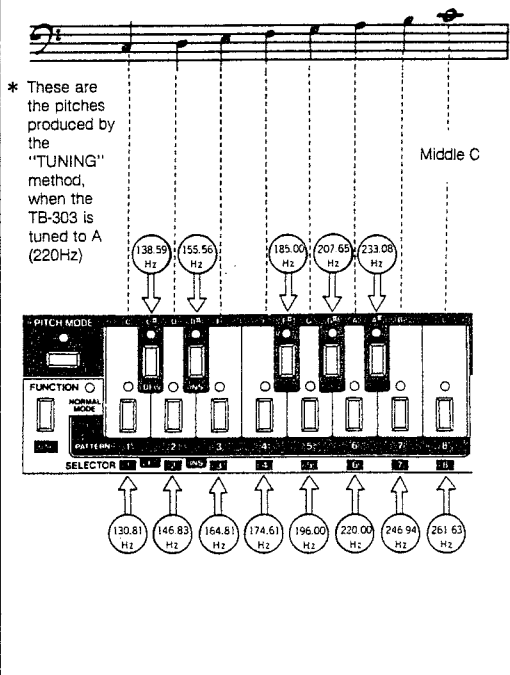


Diagram 1



B. TONE CONTROL SECTION

This section is really a small synthesizer control panel, for creating the sounds to suit your music.

1. CUTOFF FREQ (Cutoff Frequency)

This knob controls the tone colour. By turning it counter-clockwise, it will begin to shave off the upper harmonics of the sound making the tone softer and reducing the volume.

2. RESONANCE

Resonance emphasizes certain frequencies. The effect will become stronger when this knob is rotated clockwise.

3. ENV MOD (Envelope Modulation)

This knob controls the tone movement of a note. The effect will be stronger when the knob is turned clockwise.

4. DECAY

This knob controls the time a note takes to fade. Both the volume and the tone will take a longer time to fade if the knob is turned clockwise.

5. ACCENT

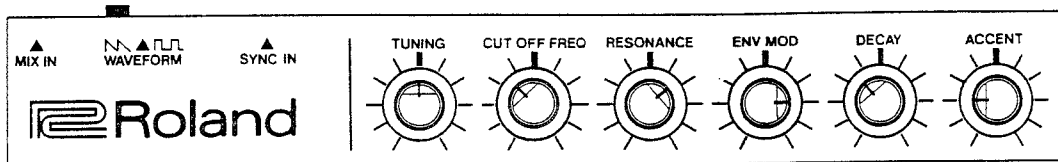
This knob controls the accent of the Bass Pattern. The effect will be stronger when the knob is turned clockwise.

6. WAVEFORM

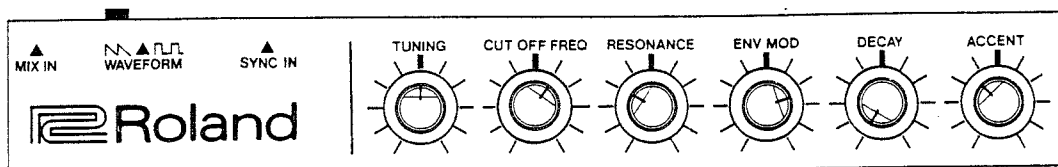
The TB-303 has two waveforms, and you can select either one of them. The tone colour will be changed by the WAVEFORM switch, even if the other dials in the TONE CONTROL SECTION are in the same position.

C. SAMPLE SOUNDS

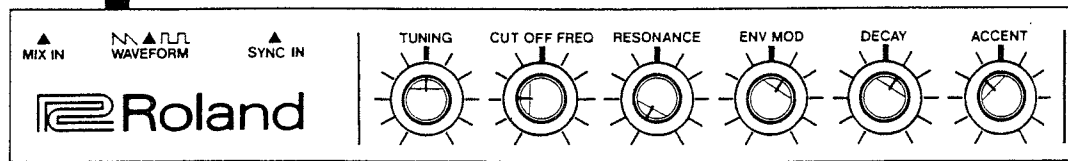
1. Electric Bass Type A



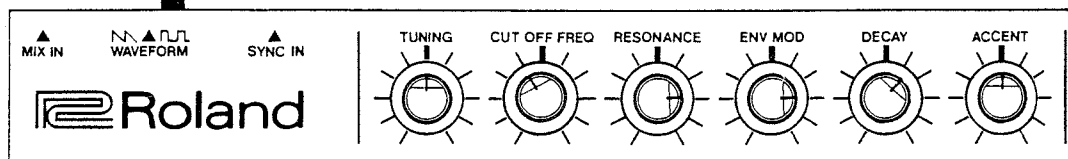
2. Electric Bass Type B



3. Acoustic Bass



4. Synthesized Bass



***NOTE:**

The tone colour will also depend on what type of amplifier, speaker or headphones you use.

2 WRITING THE LENGTH OF NOTE (ALTERNATIVE METHOD)

In the Basic Course, we wrote the length of note using the SELECTOR switches marked **9**, **0**, **100**. However, the TB-303 has an alternative method, using the TAP button.

LET'S WRITE THE NEXT BASS PATTERN WITH THIS METHOD.

Sample Score

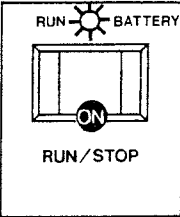

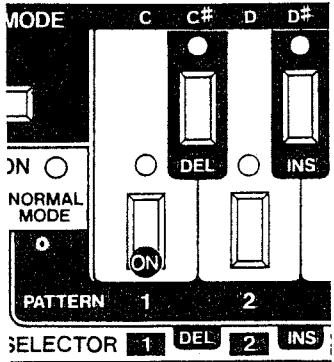
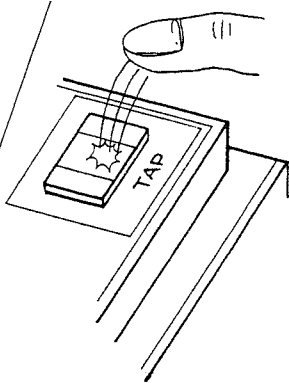
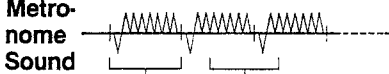
↓

Writing Table

PITCH	C	E	G	A	G
TIME	● ○ ○ ○ ○ ○	● ○ ○ ○ ○ ○	● ○ ○ ○ ○ ○	● ○ ○ ○ ○ ○	● ○ ○ ○ ○ ○

	Operation	Result	Operation Notes
1	Perform the operations up to CHECKING THE PITCH , according to the section on WRITING BASS PATTERNS in the PROCEDURE TABLE. Omit the operation SELECTING STEP MODE , SETTING STEP NUMBER	The PITCH MODE indicator lights up.	Select any memory position. (Refer to ABOUT THE MEMORY POSITIONS in the BASIC COURSE — Page 11).

WRITING THE LENGTH OF NOTE BY USING THE TAP BUTTON.

2	<p>Press the RUN/STOP button (K).</p> 	<p>The BATTERY CHECK/RUN indicator (J) lights up.</p>	<p>Although the TB-303 is now running, you cannot hear anything because, as yet, you have not written in the timing.</p>
3	<p>Press the CLEAR/RESET button (L).</p> 	<p>The metronome sound rings at eighth note intervals.</p>	<p>The lower sound of the metronome is the first step of the pattern. Control the tempo with the TEMPO control knob (D). Adjust the tone colour by using the knobs in the TONE CONTROL SECTION.</p>
4	<p>Holding the SELECTOR switch (N) marked 1 down, press the TAP button (R), using the metronome for time, as shown below and on the next page.</p>  	<p>You can hear each note played by pressing the TAP button, and at the same time the metronome sounds fade out.</p> <p>When the measure is complete, the Bass Pattern will be played repeatedly.</p>	<p>It is not out of order if you hear the sound shaking, or if the metronome fades.</p> <p>If you made an error, or if the timing is wrong, repeat the operation from 3. However, you will notice that slight errors on your part will be corrected by the TB-303.</p>  <p>Metro- nome Sound</p> <p>Tap within one measure. You cannot write correctly if tapping between two measures.</p>

4		<p>In this example, holding SELECTOR switch 1 added sustain to the notes. Any of the SELECTOR switches marked 1 to 5 work as SUSTAIN switches. If you don't need SUSTAIN, press the TAP button only. In this case the sound is heard only while pressing the TAP button, just like playing a keyboard.</p>
5	<p>Press the RUN/STOP button K if the Pattern is correct.</p>	<p>The BATTERY CHECK/RUN indicator L goes out and the TB-303 stops.</p>
<p>Now you have correctly entered the Writing PATTERN with the TAP button.</p>		

NOTE:

If you press the CLEAR/RESET button **I** after writing the length of note whilst the TB-303 is running, the memory will be cleared of the timing information, although the pitches will remain.

③ WRITING AND PLAYING A BASS LINE (PART 2).

A. WRITING AND PLAYING

This Bass line of 12 measure is a sample score of Rock 'n' Roll.

Sample Score

The sample score consists of three systems of four measures each, written in bass clef with a 4/4 time signature. The first system begins with a C chord and contains four measures of eighth and sixteenth notes. The second system begins with an F chord and also contains four measures. The third system begins with a G7 chord and contains four measures. The score includes various musical notations such as slurs, accents, and accidentals.

Outline of the Writing

In case of the Sample Score above, writing should be done as instructed below.

- ★ The 1st measure— Write
- ★ The 2nd and the 3rd measures— Repeat the 1st measure
- ★ The 4th measure— Write
- ★ The 5th and the 6th measures— Shift the 1st measure into F
- ★ The 7th measure— Repeat the 1st measure
- ★ The 8th measure— Write
- ★ The 9th measure— Shift the 10th measure into G.
- ★ The 10th measure— Write
- ★ The 11th measure— Write
- ★ The 12th measure— Write

■ BEFORE OPERATING

Follow the PROCEDURE TABLE unless stated otherwise. If you do not understand the TABLE, please repeat the BASIC COURSE.

NOTE:

- The memory position of each Bass Pattern is chosen to suit the composition. So, for convenience, please use the memory positions designated here.
- Do not change the MODE selector (B) when the BATTERY CHECK/RUN indicator (1) is alight (i.e. when the TB-303 is running). If the operation is incorrect, turn the POWER switch OFF, and it will return to the normal condition.

1 WRITING A BASS PATTERN

By following PROCEDURE TABLE WRITING A BASS PATTERN, write the Bass Patterns into the memory positions instructed (Refer to Writing Table below).

Omit the operation SELECTING THE STEP MODE and SETTING THE STEP NUMBERS.

Writing Table

WRITE INTO PATTERN GROUP II

★ The 1st measure—[Memory position 1-A]

PITCH	C	C	D [#]	E	G	G	A	G [#]	G
TIME	●	○	●	○	●	○	●	○	●
ACC.			ON						
SLIDE				ON					

Write this pattern after reading operation 2 on the next page.

★ The 10th measure—[Memory position 4-A]

PITCH	F	F	G [#]	A	C [#]	F	G [#]	A
TIME	●	○	●	○	●	○	●	○

★ The 4th measure—[Memory position 2-A]

PITCH	C	C [#]	C [#]	D	D [#]	D [#]	E	E [#]
TIME	●	○	○	●	○	○	●	○
SLIDE			ON					

Write this pattern after reading operation 2 on the next page.

★ The 11th measure—[Memory position 5-A]

PITCH	C	C [#]	A [#]	A	G [#]
TIME	●	○	○	○	○

★ The 8th measure—[Memory position 3-A]

PITCH	C [#]	C [#]	C	C	C	A [#]	A [#]	A	A
TIME	●	○	○	○	○	○	○	○	○

*Press the SELECTOR SWITCH (N) marked 100.

★ The 12th measure—[Memory position 6-A]

PITCH	G	G	G	G	A [#]	B
TIME	●	○	○	○	○	○
ACC.		ON	ON			

*Write this pattern after reading operation 2 on the next page.

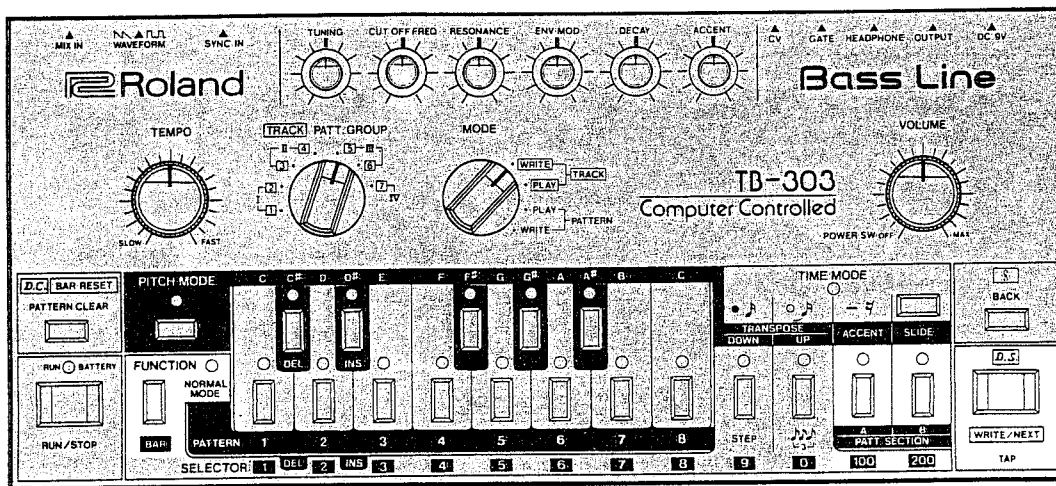
2

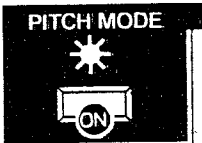
WRITING A PATTERN WITH ACCENT & SLIDE I

This method is quite different from what you have encountered so far. For example, let's write the first measure of the sample score, using the ACCENT and SLIDE.

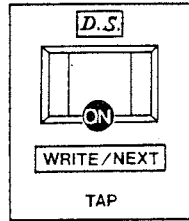
	Operation	Result	Operation Notes
1	<p>Complete all the steps up to <u>CHECKING THE LENGTH OF NOTE</u> as in the PROCEDURE TABLE</p> <p>Note:</p> <ul style="list-style-type: none"> ● Omit the operation <u>SELECTING THE STEP MODE</u> and <u>SETTING THE STEP NUMBERS</u> ● If you write the length of note by using the TAP button, use SUSTAIN. 	<p>Make sure the TB-303 is in its NORMAL MODE.</p>	<p>Select the designated memory position for bar one, from the Writing Table.</p>

WRITING ACCENT/SLIDE

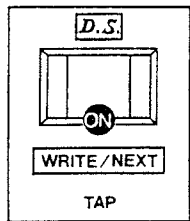


2	<p>Press the PITCH MODE button (H).</p> 	<p>The PITCH MODE indicator (G) lights up.</p>	<p>Setting is the same as that of writing pitches or checking.</p>
---	---	--	--

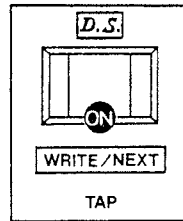
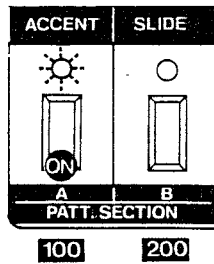
Press the TAP button (R) once, and you'll hear the first note.



● Press it once again, and you will hear the second note.



● For a third time, press and hold the TAP button (R) down, press the SELECTOR switch (N) marked 100 (Accent switch) to accent this note.



In other words, the method is similar to CHECKING THE PITCH, although to add an accent (or slide) the TAP button must be held down.

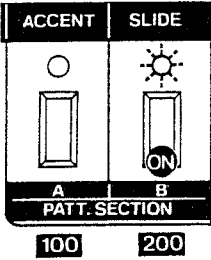
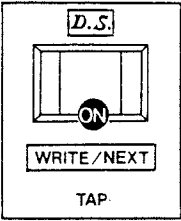
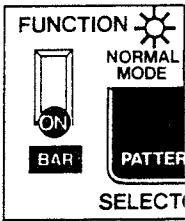
NOTE:

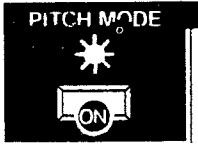
When you heard the first note (C on the keyboard) its indicator illuminated. The same applies to the other notes as they are played. Also, when you released the accent, or slide buttons, their respective indicators illuminated.

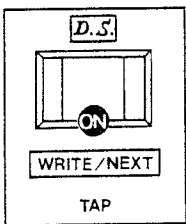
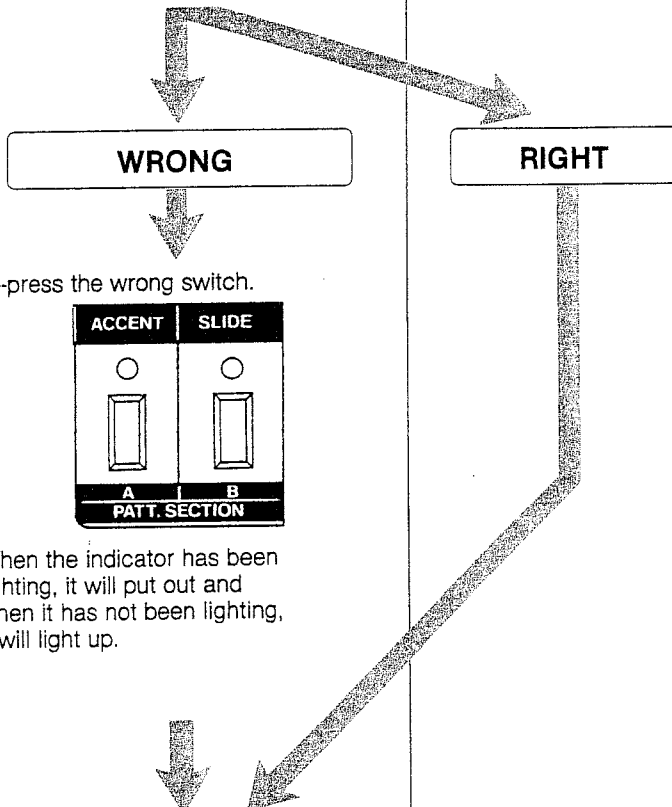
Putting the accent on the third note (Refer to the Writing Table ACC).

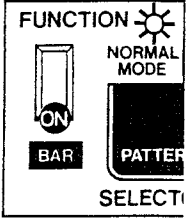
Do not release the TAP button, or you cannot write.

3

3	<ul style="list-style-type: none"> Once again, press and hold the TAP button (R) down, press the SELECTOR switch marked 200 (Slide switch) to slide from this note to the next. 		<p>Putting the slide on the fourth note (Refer to the Writing Table SLIDE).</p> 
4	<p>Press the FUNCTION button (L).</p> 	<p>The NORMAL MODE indicator (M) lights up, and the TB-303 returns to the normal mode.</p>	<p>To finish this measure, since there are no more accents or slides, simply TAP through to the end of the measure.</p>

CHECKING & CORRECTING ACCENT/SLIDE (This can be omitted)		
5	<p>Press the PITCH MODE button (H).</p> 	<p>The PITCH MODE indicator (G) lights up.</p>

6	<p>Press the TAP button (R), and hold it down.</p> 	<p>When you hear the first note (C on the keyboard), its indicator illuminates.</p>	<p>Keep holding the TAP button, even if the sound has faded away.</p>
7	<p>Confirm the accent and slide by their indicators.</p>  <p>Re-press the wrong switch.</p> <p>When the indicator has been lighting, it will put out and when it has not been lighting, it will light up.</p>		<p>● HOW TO CONFIRM</p> <p>The appropriate indicator lights up when an accent (or slide) is written. The first note does not have an accent (or slide) so its indicator will not light up. By re-pressing a switch, you can cancel or write an accent (or slide).</p>
8	<p>Repeat operations 6 and 7, and confirm the other notes.</p>		<p>The accent indicator should light up at the 3rd note, and the slide indicator should light up at the 4th note.</p>

9	<p>Press the FUNCTION button (L) after checking.</p> 	<p>The NORMAL MODE indicator (M) lights up.</p>	<p>If you want to check again, repeat from Operation 5.</p>
10	<p>To hear the result, refer to <u>PLAYING A BASS PATTERN</u> in the PROCEDURE TABLE.</p>		<p>Adjust the amount of accent by using the accent control, located in the tone control section.</p>

Now you have correctly entered the writing pattern with Accents/Slides.

NOTE:

- When re-writing the pitch after writing an accent or a slide, the accent (or slide) will be cleared. However, this is not the case when you re-write the length of notes.
- To slide from one note to another, write the slide on the first of the two notes.
- When writing a slide, if there is a rest between the two notes, the slide effect does not work.
- If you write a slide between two notes of the same pitch, the result is a "TIED" note.

4 WRITING INTO A TRACK

Compose the Bass line for this piece according to the TRACK score. Write into the designated TRACK. (Refer to WRITING INTO A TRACK in the PROCEDURE TABLE).

3 WRITING A PATTERN WITH ACCENT & SLIDE II

Write the Bass Patterns of measure 4 and 12 as operation [2] on the page 40. Refer to PROCEDURE TABLE for operating. Omit SELECTING THE STEP MODE and SETTING THE STEP NUMBER.

TRACK Score

★ Choose Track [3]

PATTERN GROUP II

C	C	C	C
1-A	1-A	1-A	2-A

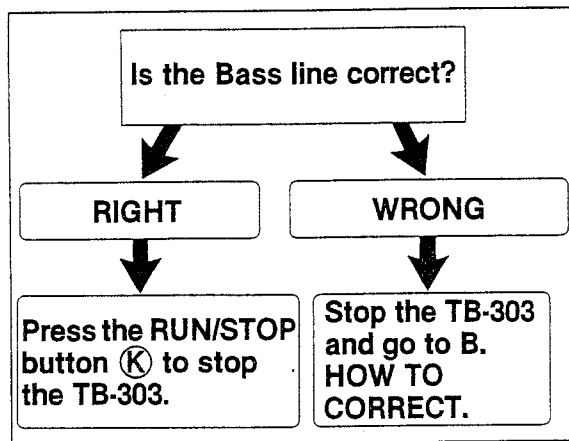
F	F	C	C
1-A ⊕	1-A ⊕	1-A	3-A

G7	F	C	G7
4-A ⊕	4-A	5-A	6-A :

D.C.

5 PLAYING/CHECKING A BASS LINE

Play the written Bass line according to the PROCEDURE TABLE "PLAYING A BASS LINE".



B. HOW TO CORRECT

	Trouble Symptom	Possible Cause	Action to be Taken
Incorrect Pattern	Wrong PITCH	Mistake in pressing the key-switch or TRANSPOSE switch	Refer to ① CORRECTING THE PITCH
	Incorrect number of Notes Length of Note is wrong	Mistake in pressing the SELECTOR switches 9 , 10 , & 100 when writing the length of note.	Refer to ② CORRECTING THE LENGTH OF NOTE.
	Accent/Slide is wrong	Mistake in pressing the switches	Refer to ③ CORRECTING ACCENT/SLIDE
Incorrect Shift	Shift is wrong	Mistake in pressing the key-switch when shifting	Refer to ④ CORRECTING PATTERNS AND SHIFTING.
	Pattern which should not be shifted is shifted.	Mistake in pressing the key-switch when shifting, or used for the previous pattern.	
Incorrect Track	Order of patterns is wrong	Mistake in selecting patterns.	Refer to ④ CORRECTING A TRACK
	Unnecessary pattern		
	Track does not play repeatedly	Mistake in setting D.C.	Refer to ⑤ CORRECTING THE D.C. POSITION.
	Incorrect number of measures	Mistake in pressing the TAP button or setting D.C.	Refer to ④ and ⑤.

1. CORRECTING THE PITCH

- ① Set the MODE selector (B) to PATTERN WRITE.
- ② Select the pattern that needs correction.
- ③ Re-write the pitch according to the PROCEDURE TABLE — WRITING THE PITCH.
- ④ Press the RUN/STOP button (K), to play the corrected pattern.
- ⑤ Stop the TB-303 if the pattern is now correct.
 - IF THE PATTERN STILL NEEDS CORRECTION, START FROM OPERATION ③.
 - When correcting the pitch, an accent (or slide) will be cleared.

2. CORRECTING THE LENGTH OF NOTES

- ① Set the MODE selector (B) to PATTERN WRITE.
- ② Select the pattern in need of correction.
- ③ Re-write the length of the notes according to the PROCEDURE TABLE — WRITING THE LENGTH OF NOTE.
- ④ Press the RUN/STOP button (K), to play the corrected pattern.
- ⑤ Stop the TB-303 if the pattern is now correct.
 - IF THE PATTERN STILL NEEDS CORRECTION, START FROM OPERATION ③.

3. CORRECTING ACCENT/SLIDE

- ① Set the MODE selector (B) to PATTERN WRITE.
- ② Select the pattern that needs correction.
- ③ Re-write the accent or slide according to CHECKING THE ACCENT/SLIDE & CORRECTION on page 42 and 43.

- ④ Press the RUN/STOP button (K) to play the corrected pattern.
- ⑤ Stop the TB-303 if the pattern is now correct.
 - IF THE PATTERN STILL NEEDS CORRECTION, START FROM OPERATION ③.

4. CORRECTING A TRACK

- ① Set the MODE selector (N) to TRACK WRITE.
- ② Select the TRACK that needs correction using the TRACK/PATTERN GROUP selector (C).
- ③ Correct the TRACK according to CHECKING & CORRECTING THE TRACK on page 29 to 31.
- ④ Play the track according to the Procedure Table — "Playing a Bass Line" after correction.
- ⑤ Stop the TB-303 if the TRACK is correct.
 - IF THE TRACK STILL NEEDS CORRECTION, START FROM OPERATION ③.

5. CORRECTING THE D.C. POSITION.

- ① Set the MODE selector (B) to TRACK WRITE.
- ② Select the TRACK that needs correction.
- ③ Reset the first measure of the TRACK by pressing the CLEAR/RESET button (K).
- ④ Press the RUN/STOP button (K). (The 1st measure of Bass Pattern is played.)
- ⑤ By pressing the TAP button (R), proceed one measure at a time until you reach the measure at which you want to set the new D.C.
- ⑥ Set the D.C. by pressing the CLEAR/RESET button (L), followed by the TAP button (R).

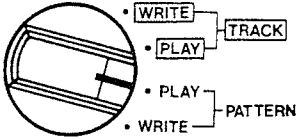
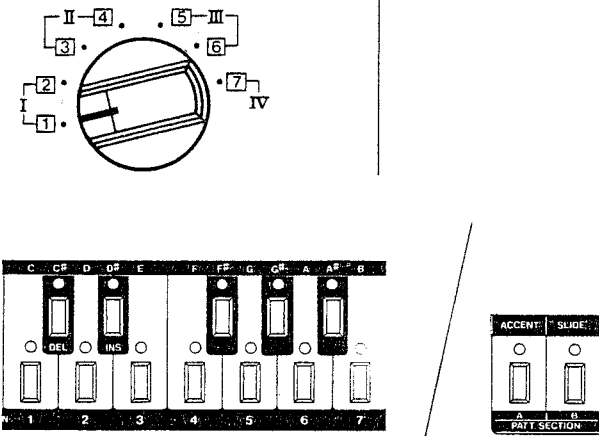
⑦ Press the RUN/STOP button (K).

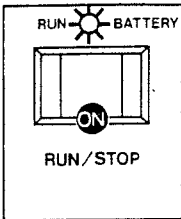
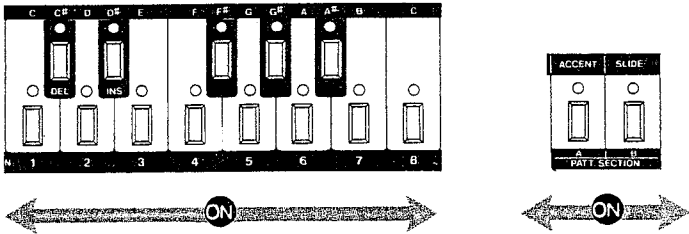
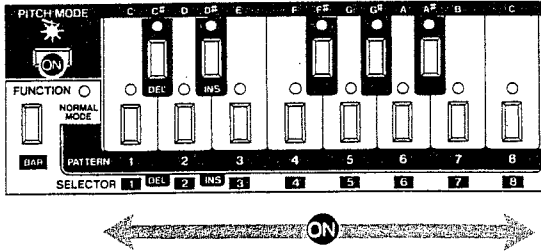
● IF THE TRACK STILL NEEDS CORRECTION, START FROM OPERATION ③.

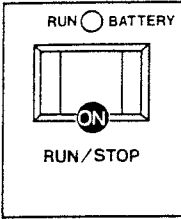
C. PLAYING THE BASS LINE (ALTERNATIVE METHOD)

In this method you control the order and amount of shift in which the patterns are played by pressing the appropriate key-

switches while the TB-303 is playing. This is a useful way of seeing how a track will sound before actually writing it into memory.

	Operation	Result	Operation Notes
1	<p>Set the MODE selector (B) to PATTERN PLAY.</p> 		
2	<p>Select the 1st pattern using the TRACK/PATTERN GROUP selector (C) and SELECTOR switches (N).</p> 	<p>One of the indicators of the chosen SELECTOR switches lights up and the other one flashes.</p>	

<p>3</p> <p>Press the RUN/STOP button (K).</p> 	<p>The BATTERY CHECK/RUN indicator (J) lights up and the Bass Pattern selected is played.</p>	
<p>4</p> <p>Change the SELECTOR switches (N) as desired.</p> 	<p>Whenever you choose a selector switch, the new pattern will begin from the first note of the next measure.</p>	<p>The SELECTOR switches marked 1 to 8 (the switches for choosing memory positions) and 100 & 200 (PAT. SECTION A & B) can be changed while the TB-303 is playing, but the PATTERN GROUP cannot change. Therefore you can only play patterns from one PATTERN GROUP at a time.</p>
<p>5</p> <p>While holding the PITCH MODE button (H) down, you can shift the key by pressing the appropriate key-switch.</p> 	<p>The shifted pattern will be played from the first note of the next measure.</p>	<p>Changing to a different pattern removes the shift.</p>

6	<p>Press the RUN/STOP button (K), the TB-303 stops immediately.</p> 	<p>The BATTERY CHECK/RUN indicator (J) goes out.</p>
<p>Now you have correctly played a Bass PATTERN.</p>		

■ **NOTE:**

- Do not press the TAP button.
- Shift cannot be done at PATTERN PLAY.

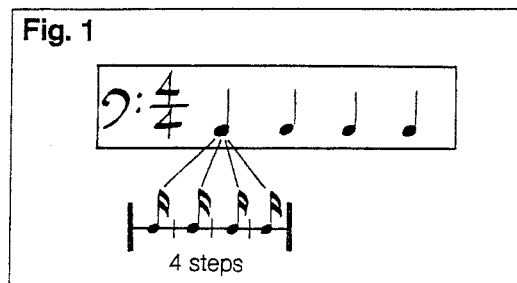
4 TO WRITE YOUR OWN BASS LINES

Firstly you must master the Basic Course up to "Writing and Playing a Bass Line (Part II)". However, in order to write more complicated Bass lines, a little extra theory is needed.

This unit of division is called the STEP. One quarter note is equal to four sixteenth notes ($\text{♩} = \text{♩} + \text{♩} + \text{♩} + \text{♩}$), so one beat equals four steps. (Fig. 1)

A. HOW TO WRITE YOUR OWN BASS PATTERNS


The TB-303 memorizes pitches, the length of notes, and other factors individually, but the most important part is to write "the length of note". A thorough understanding of this section will then make operation of the TB-303 much easier.




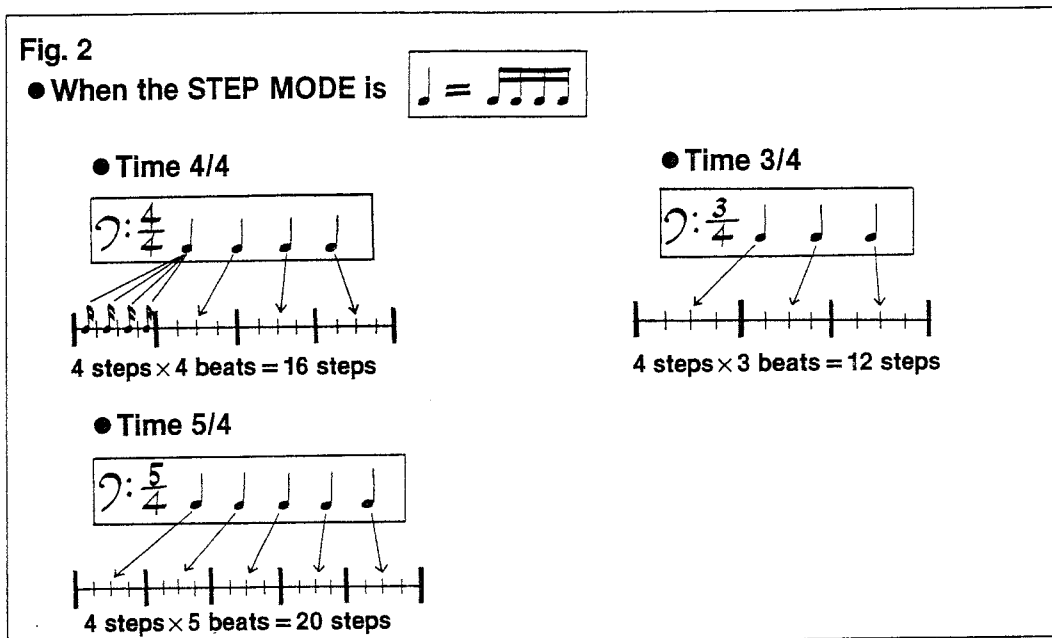
1. THE STEP




a. THE STEP AND WRITING THE LENGTH OF NOTES

With the TB-303, one measure of a Bass Pattern is divided into four quarter notes (♩), and each quarter note is divided into four sixteenth notes (♩). Using the three switches of "SOUND BEGINS (♩), SOUND CONTINUES (♩), and REST (♩)" you can write notes of any length.

The STEP MODE is shown by  when it is divided as in Fig. 1.

In this STEP MODE  the total number of STEPS per measure is shown in Fig. 2.



If each STEP has the length of one sixteenth note, by using , , or , in the correct order you can write the timing and the length of various notes.

While actually Writing, press the SELECTOR switches marked **9**, **0**, and **100** according to the WRITING TABLE FOR TIME using ●, ○, and — respectively.

Fig. 3 shows the relationship of the Writing Table, STEP, the Score and so on.

■ THE LENGTH OF NOTES AND HOW TO USE THE SWITCHES



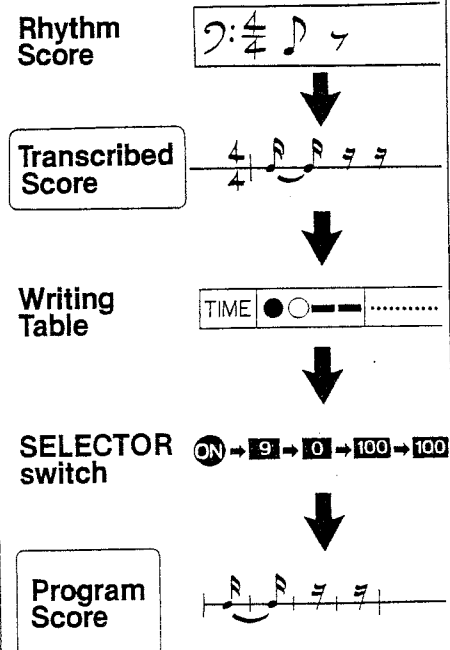
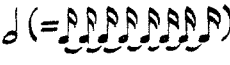
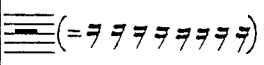
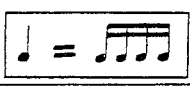

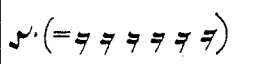

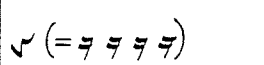
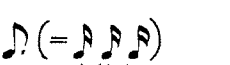
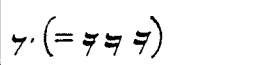
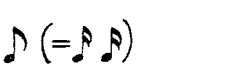
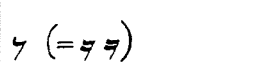





With the STEP MODE , you can write various kinds of Bass line, such as Rock 'n' Roll, using only sixteenth () notes as shown here.


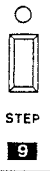




Fig. 3





* The Program Score is a transcription of the music score using only sixteenth notes and rests.


THE LENGTH OF NOTES AND HOW TO USE THE SWITCHES		*STEP MODE
 ⇒ ●○○○○○○○○	 ⇒ —————	
 ⇒ ●○○○○○	 ⇒ —————	
 ⇒ ●○○○	 ⇒ ———	
 ⇒ ●○○	 ⇒ ———	
 ⇒ ●○	 ⇒ ——	
 ⇒ ●	 ⇒ —	
 ⇒	You cannot write these with the TB-303.	
 ⇒	You cannot write triplets using the STEP MODE  .	

[NOTE]

	= ● =		The sound is heard as the length of a sixteenth note.
	= ○ =		This increases the value of the previous note by one sixteenth note value.
	= — =		Rest (no sound) for one sixteenth note

**b. ANOTHER DIVISION
(ONE BEAT = 3 STEPS)**

If you wish to write a Bass Pattern using triplets, you can set the STEP MODE by pressing the  switch (SELECTOR switch (N) marked ) before writing the length of the notes.

With the STEP MODE , the length of step automatically changes, so that one quarter note is divided into three equal eighth notes, so now one beat (♩) = 3 steps. (Fig. 4)

In this case, the total number of steps in one measure is shown in Fig. 5.

Fig. 4

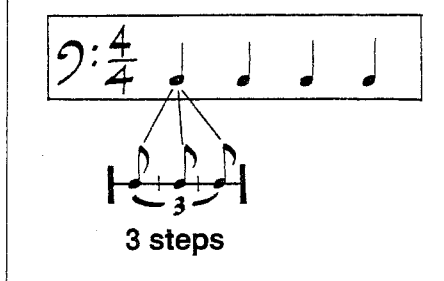
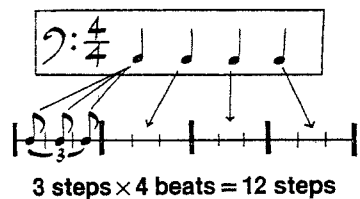
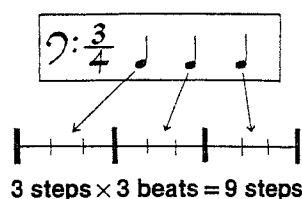


Fig. 5 When the STEP MODE is 

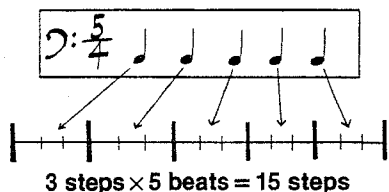
● Time 4/4




● Time 3/4



● Time 5/4












■ THE LENGTH OF THE NOTES AND HOW TO USE THE SWITCHES.

With the STEP MODE  the length of the notes, using the SELECTOR switches,

change as in Fig. 6.

Fig. 6

	➔		= ● =		This note sounds for 1/3 of a beat.
	➔		= ○ =		This increases the value of the previous note by one third of a beat.
	➔		= — =		Rest (no sound) for 1/3 of a beat

THE LENGTH OF THE NOTES AND HOW TO USE THE SWITCHES		*STEP MODE
		This cannot be written using a triplet STEP MODE

c. SELECTING THE STEP MODE AND SETTING THE STEP NUMBER

① Selecting the STEP MODE

The regular STEP MODE is set automatically at . Writing with you need to select the MODE. When returning to from simply select and clear a new memory position.

② Setting the STEP number

When you write a pattern with 16 steps, it is not necessary to set the STEP number because by pressing the CLEAR/RESET button ① as in SELECTING A MEMORY POSITION,

16 steps are set automatically. You need to set the number of steps only when it differs from the number 16.

2. AN EXAMPLE OF A DIFFERENT STEP NUMBER


A. WRITING A BASS PATTERN USING TRIPLETS.

Let's write the following Bass Pattern (1st measure)

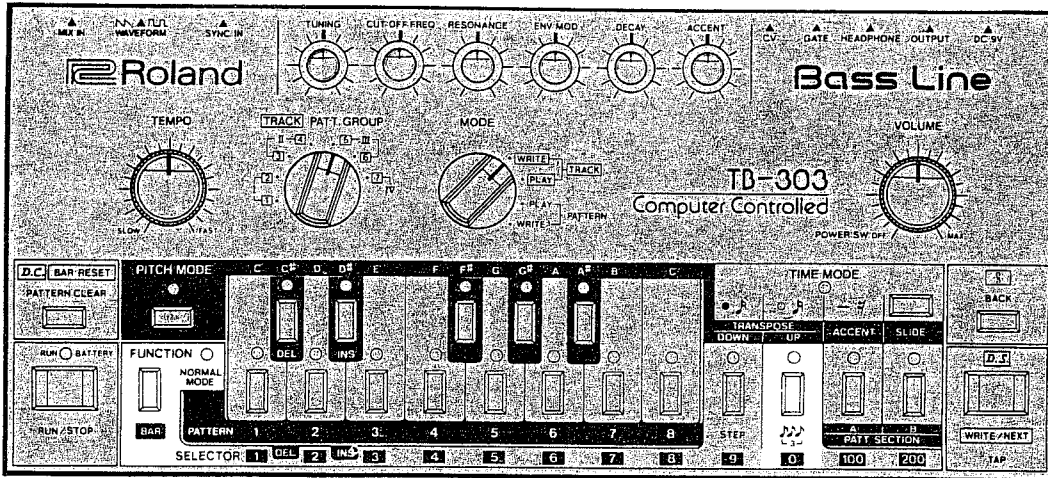
Sample Score



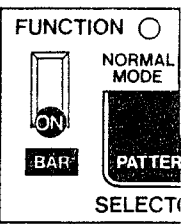

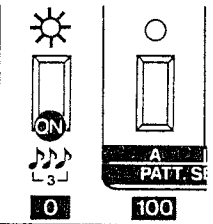


Writing Table

PITCH	C	C	E	E	G	G	A		A"	A"	A	A	G	G	E
TIME	●	○	●	●	○	●	●	○	●	○	●	●	○	●	○
STEP MODE															
STEP NUMBER	12														

	Operation	Result	Operation Notes
1	Complete the operations up to SELECTING A MEMORY POSITION according to the PROCEDURE TABLE — Writing Bass Patterns.	After selecting a memory position, make sure the TB-303 is in its NORMAL MODE.	By pressing the CLEAR/RESET button (1), the TB-303 is set automatically to a STEP MODE of  and the step number is 16.

SELECTING THE STEP MODE





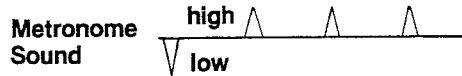
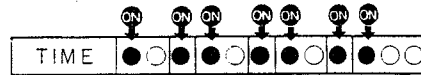
2	<p>Holding the FUNCTION button (1) down, press the SELECTOR switch (2) marked  (the switch marked ).</p> 	<p>The indicator of the  button lights up.</p> 	<p>By pressing the  switch, the STEP MODE will be set to  and the step number will be set to 12 steps, automatically.</p>
3	<p>Continue to operate from WRITING THE PITCH in the PROCEDURE TABLE — Writing Bass Patterns.</p> <p>NOTE: If you would rather use the TAP button for writing the length of the notes, refer to "USING THE TAP BUTTON FOR TIMING".</p>		<p>When writing the length of the notes after pressing the switch 12 times, the mode will change automatically to the NORMAL MODE (because the STEP number is 12). Similarly, when checking the length of the notes, press the TAP button 12 times and then change to the NORMAL MODE.</p>

Now you have correctly entered the Bass PATTERN in 3/4.

■ When you have completed the second measure, you can write the two measures into a track, using the **PROCEDURE TABLE — Writing into a Track.**

■ **USING THE TAP BUTTON FOR TIMING**

With the STEP MODE , the metronome sound rings at quarter note intervals. The writing method is the same as for the STEP MODE .



*The metronome sound rings at fourth note interval.

b. WRITING A BASS PATTERN IN 3/4


Let's write the following Bass Pattern (1st measure)

Sample Score

Writing Table

	PITCH	C			
	TIME	● ○ ○ ○	-----		

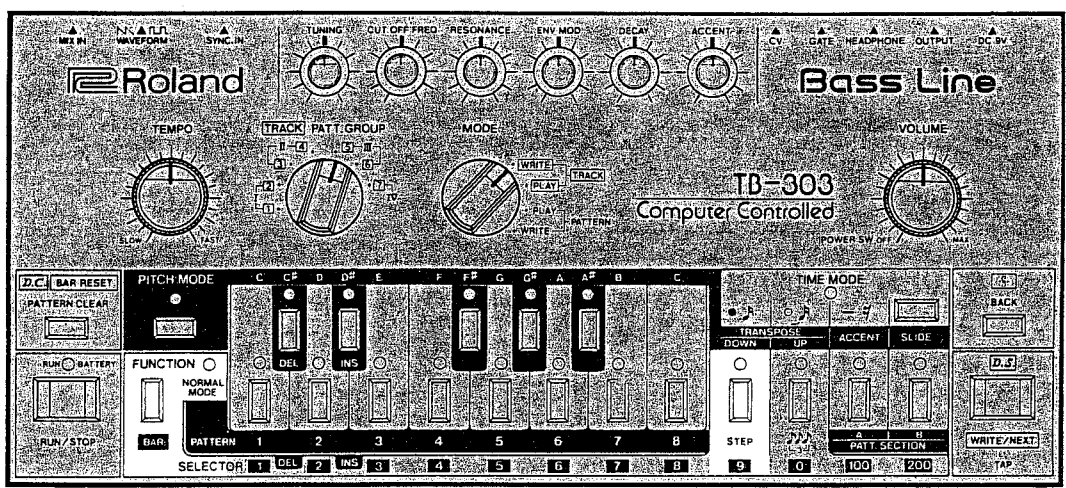
	G	A	B		
	● ○ ○ ○	● ○ ○ ○	● ○ ○ ○		

STEP MODE 

STEP NUMBER 12

	Operation	Result	Operation Notes
1	Complete the operations up to SELECTING A MEMORY POSITION in the PROCEDURE TABLE — Writing Bass Patterns.		

SETTING THE STEP NUMBERS





<p>2</p> <p>Holding the FUNCTION button (L) down, press the SELECTOR switch (N) marked 9 (STEP switch) 12 times.</p>	<p>The indicator of the STEP switch lights up.</p>	<p>Press the STEP switch according to the STEP number.</p> <p>If you make a mistake press the FUNCTION button again, and repeat.</p>
<p>3</p> <p>Continue to operate from <u>WRITING THE PITCH</u> in the PROCEDURE TABLE — Writing Bass Patterns.</p>		<p>If you wish to write the length of the notes by using the TAP button, be careful.</p> <p>The music is in 3/4 time, so the metronome sound rings 6 times, the first beat being a lower sound.</p>

Now you have correctly entered the Bass Pattern with triplet.

■ To finish the track, notice that bars 2 and 3 can be reproduced by "shifting" bar one. Write measure 4 into another memory position, then refer to the **PROCEDURE TABLE — Writing into a Track.**

■ **NOTE:**


1. You wrote in 3/4 time here, but it is easily seen that the same method can be applied to 2/4 etc.,
2. If you want to write the same 3/4 pattern, but in a triplet feel, then set the STEP MODE to  and the STEP number to 9 .

So, to write in 5/4, with a STEP MODE , it is impossible to write 4 (steps) x 5 (beats) = 20 steps into one memory position.


In this case, divide the one measure pattern into two suitable parts, and write them into two different memory positions. Join the divided pattern when writing into the TRACK, and the pattern will be played as one measure.



LET'S WRITE THE FOLLOWING BASS PATTERN INTO TWO MEMORY POSITIONS. Use the positions designated here.

c. WRITING THE PATTERN WITH A STEP NUMBER GREATER THAN 16.

The step number of a Bass Pattern written into one memory position has a maximum of sixteen steps (in the case of the STEP MODE  15 steps is the maximum).

Sample Score



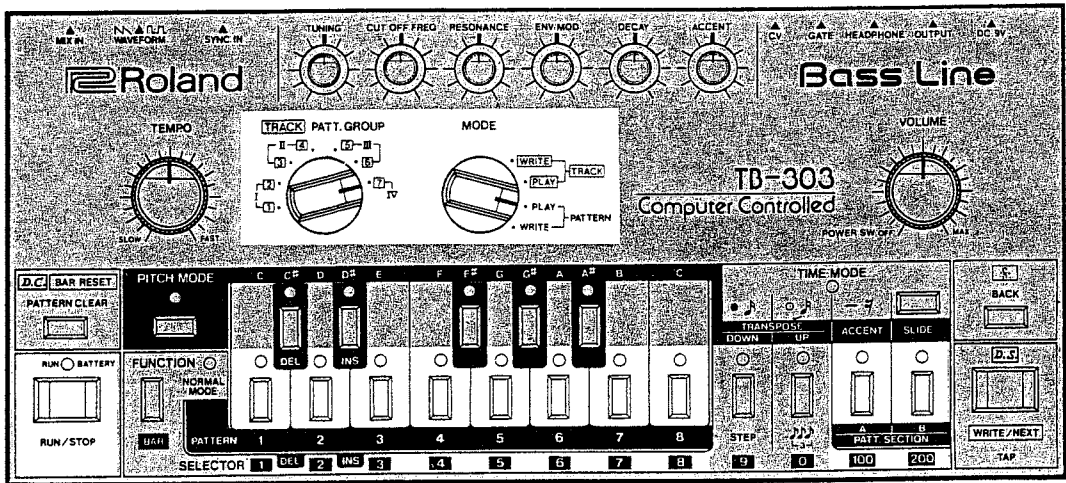
	1st half	2nd half
Writing Table	PITCH C D# E	PITCH G G A# C A# D A#
	TIME ●○ - - ●○ - - ●○ - -	TIME ●○○○ ●○●○ ●○●○ ●○●○ ●○●○ ●○●○
	STEP MODE 	STEP MODE 
	STEP NUMBER 12	STEP NUMBER 16
	*Memory position — 1-A (PATTERN GROUP IV)	*Memory position — 2-A (PATTERN GROUP IV)

	Operation	Result	Operation Notes
1	Write the first half of the pattern into 1-A (PATTERN GROUP IV)		

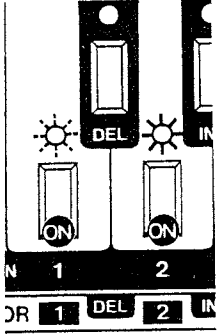
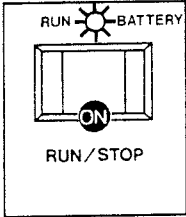
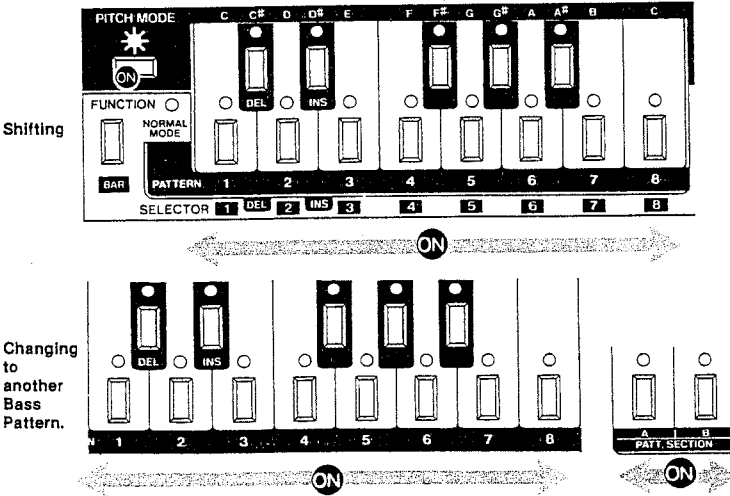
2	Write the second half of the pattern into 2-A (PATTERN GROUP IV).	
---	---	--

CONFIRMING BY CHAINING

● This is a method of playing consecutive patterns as a group. By using this method you can confirm the pattern without writing it into a TRACK.



3	<p>Set the MODE selector (B) to PATTERN PLAY.</p> <p>MODE</p>	
4	<p>Set the TRACK/PATTERN GROUP selector (C) to IV, and press the SELECTOR switch (N) marked 100</p> <p>TRACK PATT. GROUP</p> <p>PATT. SECTION</p>	

5	<p>Press the SELECTOR switches (N) marked 1 and 2 at the same time.</p> 	<p>The indicator of 1 flashes and 2 lights up.</p>	
6	<p>Press the RUN/STOP button (K).</p> 	<p>The BATTERY CHECK/RUN indicator (J) lights up and the two patterns play in series. As each pattern plays, its respective indicator flashes.</p>	
7	<p>You can shift the key and change to another Bass Pattern while the TB-303 is still playing.</p>  <p>Shifting</p> <p>Changing to another Bass Pattern.</p>	<p>Refer to PLAYING THE BASS LINE (ALTERNATE METHOD) Page 47.</p> <p>Even if you want to change to another pattern during CHAINING, the pattern does not change until the series of patterns finish.</p> <p>When shifting, both patterns are shifted.</p>	

8 Press the RUN/STOP button (K) after confirming.

Now you have correctly entered the writing pattern with more than 16 steps.

■ CHAINING

The eight writing switches are divided into two parts, shown in Fig. 1. Each "block" can play the Bass Patterns in series by pressing any two switches in the same block, at the same time. (Refer to Diagram 1)

Fig.1

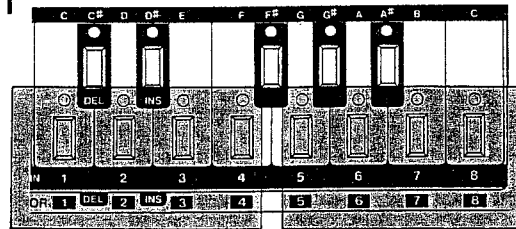


Diagram 1

● Variations of Chaining			
	How to Use the Switches		Order of Play
1		➔	
2		➔	
3		➔	
4	etc.		
<p>* The same applies to the other block, memory positions 5 to 8.</p> <p>* Pressing two switches from different blocks will not lead to CHAINING (For example 3 to 6, in this case only 3 will play.)</p> <p>* Playing from larger numbers to smaller numbers (4 - 3 - 2 - 1) cannot be done, neither can skipping memory positions (1 - 3 - 4).</p>			

NOTES:

1. The pattern is divided into the first half with 3 beats (12 steps) and the latter half with 4 beats (16 steps) here, but it can be divided into the first half with 4 beats and the latter half with 3 beats.
2. When confirming the pattern by CHAINING, select two memory positions next to each other in the same block when you write and the first half should have the lower position number, while the latter half should be the next higher number.

In this case, select memory positions in the same PATTERN GROUP and PATTERN SECTION (otherwise CHAINING cannot be achieved).
3. In CHAINING, if each memory position contains just one measure, several measures in a series can be used as a Bass line.

d. WRITING COMPLICATED PATTERNS

1 Using Two Different Step Modes

It is impossible to write using two STEP MODES in the one memory position, so to write patterns with two STEP MODES, write the pattern into two different positions. LET'S WRITE THE FOLLOWING BASS PATTERN IN TWO STEP MODES

Sample Score

1st half

PITCH	F	G#	A	C
TIME	●	○	○	●
STEP MODE				
STEP NUMBER	6			

2nd half

PITCH	D#	C	A	G#
TIME	●	○	○	●
STEP MODE				
STEP NUMBER	8			

OPERATION

- Simply follow the instructions in "c. WRITING THE PATTERN WITH A STEP NUMBER GREATER THAN 16."
- Write the pattern into two positions next to each other, in the same block, if you want to confirm by CHAINING.

NOTE:

It is better to check the MODE of each beat in the bar, one at a time, as in Example 1.

< Example 1 >

	First beat	2nd beat	3rd beat	4th beat
Suitable STEP MODE				

Write with the STEP MODE

Write with the STEP MODE

< Example 2 >

	First beat	2nd beat	3rd beat	4th beat
Suitable STEP MODE				

NOTE:

- You will need two memory positions.
- Either STEP MODE can be used for the 1st beat. Use in this case, because the 2nd beat is (If possible, use a common MODE.)

NOTE:

- In this case, use 4 positions as each beat has a different STEP MODE.
- For confirming this by CHAINING, write into 4 switches in the same block.

2. Writing a Slide between Two Patterns

It is possible to slide from one pattern to another if the last note of the first pattern has a slide written onto it. LET'S WRITE THE FOLLOWING TWO-MEASURE BASS PATTERN.

If you want to confirm the pattern by CHAINING, use two switches next to each other in the same block.

Sample Score

Writing Table

STEP MODE	$\text{♩} = \text{♪♪♪}$
STEP NUMBER	16

PITCH	E	E	G	A	B	B	A	G	E	A	A	C	D	E	E	D	C	A
TIME	●	○	●	○	●	○	●	○	●	○	●	○	●	○	●	○	●	○
SLIDE																		ON

■ METHOD

This writing method makes use of the functions of slide (refer to WRITING ACCENT/SLIDE (Page 40) not only within one pattern but also crossing between two patterns. Therefore, the first note of the second measure has a slide approaching it, no matter what this second measure may be.

(If the first note of the second measure is a rest, the slide does not work)

If the pitch of the last note of the 1st measure and the first note of the 2nd measure are the same, the two measures will be "TIED". If you continually repeat a pattern that ends with a slide, the first note of the pattern will 'receive' the slide.

3. NOTES

- The STEP number of a track is automatically set at 16 for $\text{♩} = \text{♪♪♪}$ (12 for $\text{♩} = \text{♪♪}$) whenever you select and clear a new memory position.
- All steps are written as ♩ or ♪ (♪♪ or ♪♪♪) when writing the length of the note with SUSTAIN, using the TAP button. (There are no rests (♩) in this case).
- After setting the STEP MODE for $\text{♩} = \text{♪♪♪}$, you cannot reset for $\text{♩} = \text{♪♪}$. To do this, repeat the operations from SELECTING A MEMORY POSITION.
- When writing " ♪ " (or ♪♪) at the beginning of a pattern, it is automatically re-written as " ♩ " (or $\text{♪♪$).

B. TO WRITE YOUR OWN BASS LINES

You can write your own Bass lines and play them by understanding the functions of the TRACK.

1. The TRACK

a. TRACK MEMORY

There are 7 TRACKS in the TB-303 and each TRACK can remember 64 measures. To write a piece of music that has more than 64 measures, you will have to use 2 or 3 consecutive TRACKS (Page 66). The remainder of the TRACK cannot be used (e.g. if you write 24 measures in the TRACK, the other 40 cannot be used). Even if only 1 measure is written into the TRACK, it is impossible to write into the remainder.

b. HOW TO MEMORIZE A TRACK

A TRACK can remember the order in which you want the patterns to play and also the key (shift) they should be in.

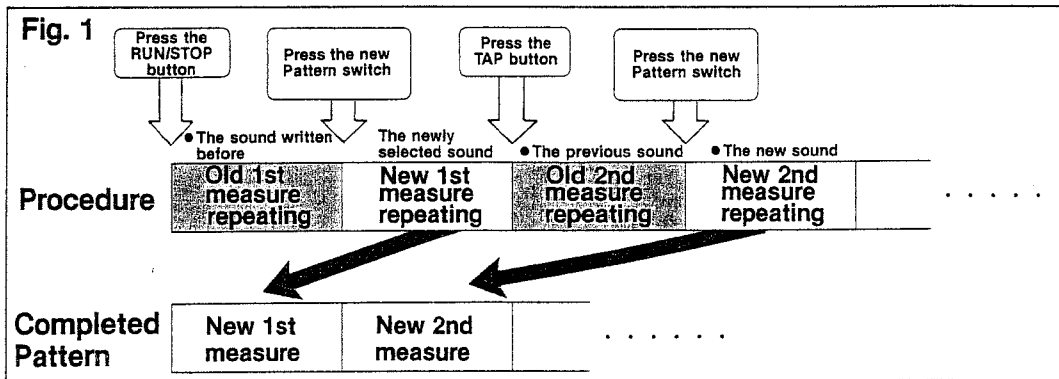
It also remembers each pattern as a complete measure, even if you have chained two patterns together to create a measure.

In this case, the TRACK will still remember each pattern as a separate measure.

c. WRITING

The new TRACK is not written in after clearing out an old one. In fact, what you do is call back (listen to) the old track, one measure at a time, and replace each measure with a new one. This means that you must

- listen to the old measure 1.
- find a new measure 1.
- Press TAP button to write in the new measure 1, and to move on to
- listen to the old measure 2.
- find a new measure 2. etc...(See Fig. 1)



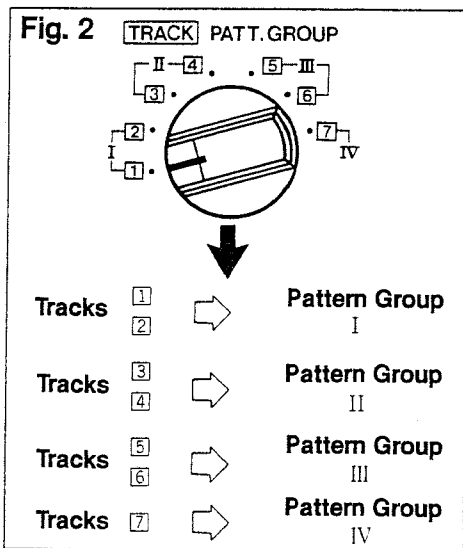
① SELECTING A PATTERN GROUP

The PATTERN GROUP is decided automatically when the TRACK is selected, so you can write using 16 patterns (8 (switches) × 2 (A, B)) in that PATTERN GROUP. (Fig. 2)

The patterns from different GROUPS cannot be used at the same time, so it is necessary to write the Bass Patterns of one piece of music into one PATTERN GROUP only.

② SETTING D.C.

When selecting the last measure of the TRACK, set D.C. This tells the TB-303 where the TRACK ends and when you play this TRACK, it will repeatedly play from the first measure to this last measure.

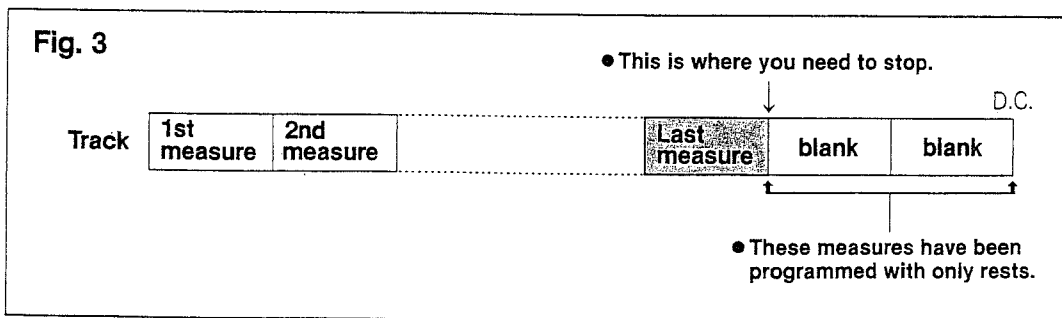


Precautions

- * Make sure you set the D.C. If you don't set a new one, the previous D.C. measure will still operate.
- * Set the D.C. at the last measure. If you set the D.C. about halfway through the TRACK, this measure is judged as the last measure and the rest of the measures will not be played.
- * Set one D.C. per TRACK
- * If you set more than one D.C. per TRACK, only the last one will operate.

③ NOTES

- When playing a TRACK, it will repeat after the D.C. measure finishes by returning to the first measure. If you only want the TRACK to play once, press the RUN/STOP button after playing the D.C. measure. If this proves difficult, write two blank measures after the last measure to give you room to stop.
- When Writing into the TRACK, you can write by using CHAINING (the patterns between two switches pressed in one BLOCK can be written together). You can also "shift" while CHAINING and the selected patterns will all be shifted to the same key.



2. WRITING AND PLAYING A BASS LINE IN TWO TRACKS

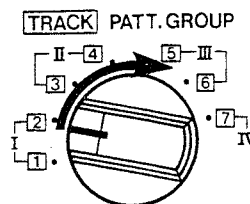
a. WRITING

The operation itself is the same as writing into a single TRACK.

① METHOD

- * Set the TRACK/PATTERN GROUP selector C at the first TRACK, and you don't need to change — the TRACK changes automatically.
- * However, be careful, there is still a maximum number of measures that can be used in this way.
- * If you exceed the limit (the maximum number of measures) the TRACK will return to the beginning and write over the first few measures.
- * The PATTERN GROUP is decided by the TRACK from which you begin to write, you cannot change the PATTERN GROUP even if the writing continues to other TRACKS. (Refer to the Example.)

< Example >



When writing, starting from TRACK 2 to TRACK 3, the PATTERN GROUP remains as PATTERN GROUP-1.

- * As before, when using this method, set only one D.C. because in effect, you are really only writing one TRACK.

② NOTES ON CORRECTION

- * Make sure you set the TRACK/PATTERN GROUP selector C to the TRACK which has the first measure of the Bass line if you need to make any corrections. (Refer to Example)

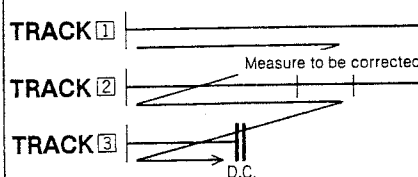
Fig. 4

Beginning of writing track		Limit (Maximum number of measure)
1	→	256
2	→	256
3	→	256
4	→	256
5	→	192
6	→	128
7	→	64

e.g. TRACK 1 → 64 × 4 = 256

TRACK 6 → 64 × 2 = 128

< Example >



Set the TRACK/PATTERN GROUP selector C to TRACK 1, not to TRACK 2 or 3.

b. PLAYING THE COMBINED TRACKS

- * Make sure you set the TRACK/PATTERN GROUP selector (C) to the TRACK which has the 1st measure to start to play. If you set it to about halfway through the TRACK, it cannot play correctly.

Fig. 5

TRACK 1

TRACK 2

TRACK 3

D.C.

- * Set the TRACK/PATTERN GROUP selector to TRACK 1.
- * Do not change to TRACK 2 or 3 after starting from TRACK 1.

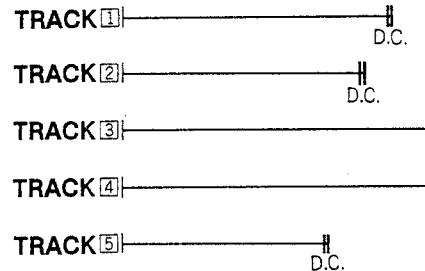
- * It is not necessary to change the TRACK/PATTERN GROUP selector (C), as the TB-303 changes automatically to the next TRACK. (If you do change the selector to the other TRACK, it cannot play correctly).

3. CHANGING THE TRACK WHILE PLAYING

a. METHOD

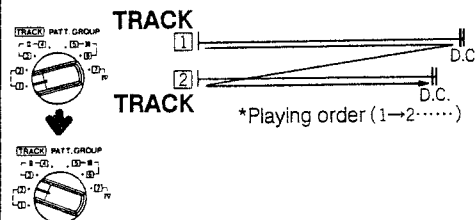
If you change the TRACK/PATTERN GROUP selector (C) to another TRACK while it is playing, then it will play through to its D.C. measure (the last measure) of the current TRACK before it changes to the first measure of the new TRACK and continues from there. (Refer to Example)

< Example >

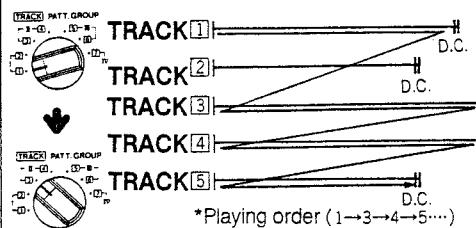


- * When the Bass line has been written as 3 pieces, such as TRACK 1, TRACK 2, and TRACK 3 to 5.

- Starting from TRACK 1 and changing to TRACK 2 during TRACK 1.



- Starting from TRACK 1 and changing to TRACK 3 during TRACK 1.



b. NOTES:

- * Make sure you change the selector to the TRACK which starts the Bass line (TRACK 3 for example) when changing to the combined TRACKS (TRACK 3 to 5 for example). If you change to about halfway through a TRACK (TRACK 4 or 5 for example) it cannot play correctly.
- * DO NOT START HALFWAY THROUGH A TRACK (TRACK 4 or 5 for example) WHEN STARTING A BASS LINE.

ADVANCED COURSE

1 USEFUL FUNCTIONS OF THE TRACK

To simplify writing a long Bass line, the TB-303 can easily do "Correction", "Confirm the measure numbers" and write a sign to repeat a section of the TRACK, the same as in writing a sheet of music.

A. PLAYING/WRITING/ CORRECTING A MEASURE/CHANGING THE D.C. FROM A DESIGNATED MEASURE

You can play or write from a designated measure about halfway through a TRACK.

1. DESIGNATING THE MEASURE NUMBER

- Set the MODE selector (B) to TRACK PLAY when playing from a designated measure, and to TRACK WRITE when writing (or correcting).

- Select the TRACK using the TRACK/PATTERN GROUP selector (C).

* If the Bass line uses combined TRACKS, set it to the TRACK which has the first measure.

- Make sure the TB-303 is not running.

- While holding the FUNCTION button (L) down, press the SELECTOR switch (N) designating the measure number. (Refer to "HOW TO SELECT THE MEASURE NUMBER" below)

* The indicator of the SELECTOR switch (N) shows the designated measure number.

- If you choose the wrong measure number, release the FUNCTION button (L) and repeat from operation 4.

● HOW TO SELECT THE MEASURE NUMBER

- The SELECTOR switches 1 to 0, 100 and 200 work as the BAR number switches (the switches for designating the measure number) when pressing the FUNCTION button (L).

- While looking at the BAR number in the examples, press the measure number

beginning with the larger figure.

● RULES OF INDICATION

- In a three digit number (say 236) the indicators of the first two numbers (2 and 3) will light up, whilst the last digit (6) will flash.
- If a number has a repeated digit (say 55) then its indicator will alternately stay alight and flash.



< e.g. >	Measure number	Switches to be pressed, in order	Indication
	131	100 → 3 → 1	1 3 100
	55	5 → 5	5 [Alternately stay alight and flash]
	101	100 → 1	1 100

5 Release the FUNCTION button (L) after you have selected the measure number.

* The indicator of the pattern designated by that number will flash.

● **NOTE:**

Do not designate a measure number greater than the last measure number (D.C. measure) of the TRACK.

2.

a. PLAYING A TRACK FROM A DESIGNATED MEASURE

Press the RUN/STOP button (K) after designating the measure number.

b. WRITING A TRACK FROM A DESIGNATED MEASURE

Follow the PROCEDURE TABLE — WRITING INTO A TRACK (from operation 4) after designating the measure number.

c. CHECKING AND CORRECTING A DESIGNATED MEASURE

Follow the CHECKING AND CORRECTING A DESIGNATED MEASURE in the Basic Course Page 29 to 31 (from Operation 18) after designating the measure number.

d. CHANGING THE POSITION OF THE D.C.

Press the RUN/STOP button (K) after designating the measure in which you want to set the new D.C. and follow the PROCEDURE TABLE — WRITING INTO THE TRACK (from Operation 9).

B. PLAYING A TRACK USING THE SIGN (D.S. and ♯)

After you set the ♯ sign at a measure in the TRACK, the TRACK goes back to the ♯ measure from any other measure by pressing the TAP button (R) during that other measure.

1. SETTING THE ♯ SIGN

① Set the MODE selector (B) to TRACK WRITE.

② Designate the measure in which you want to set the ♯ sign according to the section on DESIGNATING THE MEASURE NUMBER (Operations 2 to 5).

③ Press the RUN/STOP button (K) (The Bass pattern of the designated measure plays).

④ Press the ♯ /BACK button (Q), to write the sign ♯ into this bar.

● **You can set the sign ♯ while Writing (or correcting) the TRACK.**

* Write the Bass pattern first and select the pattern at which you want to set ♯, then press the ♯ /BACK button (Q).

NOTE:

* You can only set one ♯ sign per TRACK.

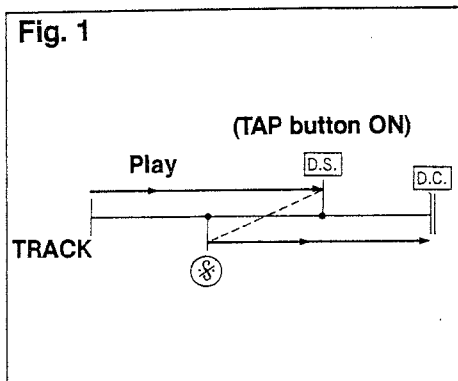
* If you set more than one ♯ per TRACK, only the last one will operate.

* Do not set the ♯ sign at the last measure (D.C. measure).

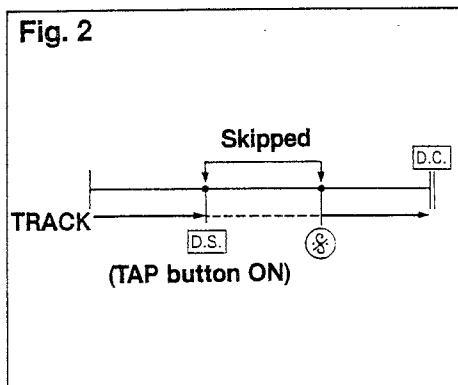
* If you do not set the ♯ sign, the previous position will be used.

2. PLAYING A TRACK USING D.S. $\&$

Whilst the TRACK is playing, press the TAP button (R) at any measure. After finishing the current measure, the TRACK will return to the $\&$ measure and continue from there. (Fig. 1)



* If you press the TAP button (R) before the $\&$ measure, the TRACK will jump to the beginning of $\&$ measure. (Fig. 2)



- * If you press the TAP button (R) during the D.C. measure, the TRACK will return to the $\&$ measure and not to the first measure.
- * In case of changing the track while playing, do not press the TAP button, as D.S. \rightarrow $\&$ function does not operate properly. (When the track is being changed, $\&$ measure is not read properly.)

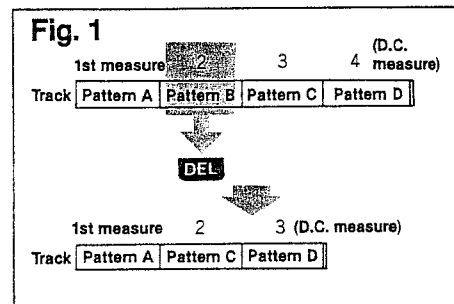
C. DELETE AND INSERT A MEASURE

The TB-303 can delete or insert a measure after writing a piece of music.

1. DELETE

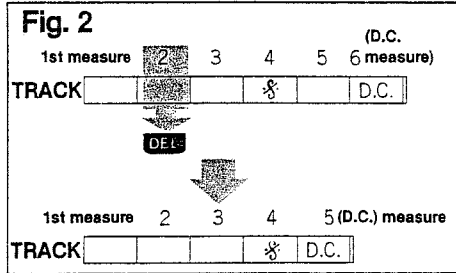
- ① Set the MODE selector (B) to TRACK WRITE.
- ② Designate the measure you want to delete, according to DESIGNATING THE MEASURE NUMBER (Operations 2 to 4).
- ③ Whilst holding the FUNCTION button (L) down, press the **DEL** switch (C = key-switch).

● The designated measure is deleted and the following measures move forward. (Fig. 1)

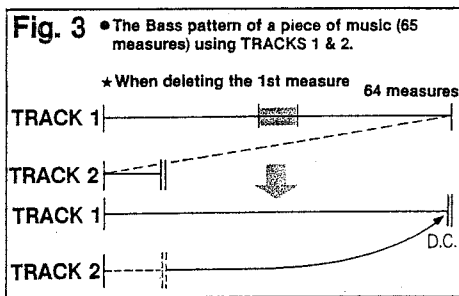


NOTE:

- * When you delete, the D.C. measure is corrected automatically but the $\&$ measure cannot be corrected. (Fig. 2 on the next page)



- * Do not delete the D.C. measure and the measures after that (It may cause trouble in the written track).
- * In Fig. 3, TRACK 2 is no longer combined with TRACK 1.

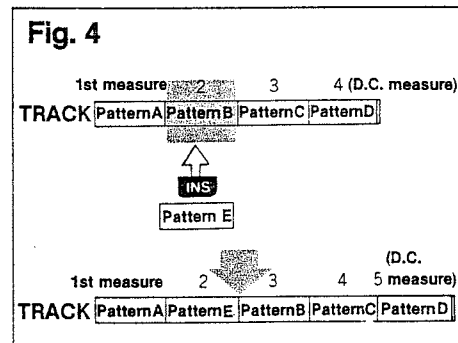


2. INSERT

- 1 Set the MODE selector (B) to TRACK WRITE.
- 2 Designate the measure before which you want to insert a BAR according to Designating the Measure Number. (Operations 2 to 5)
- e.g. If you wish to insert between the 5th and 6th measures, designate the 6th measure.
- 3 Whilst holding the FUNCTION button (L) down, press the INS switch (D = key-INS switch).
- 4 Press the RUN/STOP button (K).
- * The Bass pattern written into the designated measure plays.

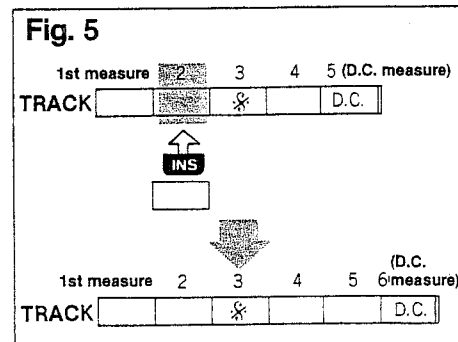
- 5 Select the Bass pattern you want to insert by using the appropriate SELECTOR switch (N).
- * The selected Bass pattern is played.
- 6 Press the TAP button (R).
- * Proceed to the next Bass pattern (this is done automatically by pressing the TAP button).
- 7 Press the RUN/STOP button (K).

- The new Bass pattern has been inserted into the designated measure and the following patterns move further back. (Fig. 4)

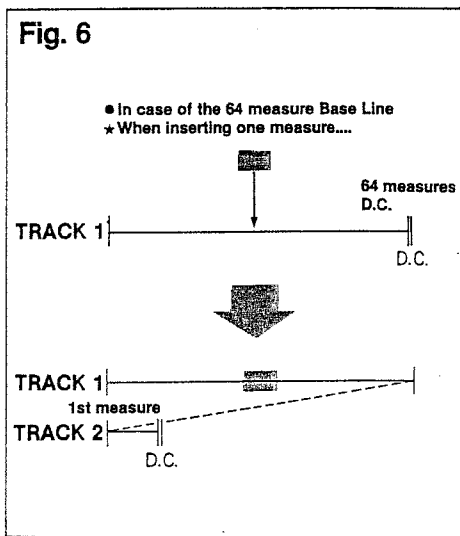


NOTE:

- * When you insert, the D.C. measure is corrected automatically but the * measure cannot be corrected (Fig. 5).



- * Do not insert after D.C. measure. (It may cause trouble in the written track.)
- * If the TRACK has more than 256 measures after a BAR has been inserted, the D.C. Measure will move to the first measure of the next TRACK.
- * In Fig. 6, the D.C. measure moves on to TRACK 2, so now TRACK 2 cannot be used without affecting TRACK 1.



D. CONFIRMATION BY USING THE INDICATORS

1. CONFIRMATION OF THE MEASURE NUMBERS

When you want to know the number of the measure which is playing at the moment, whether you are Writing the TRACK or playing, press the FUNCTION button (L), even if the TB-303 is running.

- * The indicators of the SELECTOR switches show you the measure number. (Refer to RULES OF INDICATION on P.69)
- * Whilst the TB-303 is playing, obviously the numbers will increase.

2. CONFIRMATION OF THE AMOUNT OF SHIFT

When you want to know whether you have shifted or not, and where to put the shifted pattern whilst Writing the TRACK, press the PITCH MODE button whilst the TB-303 is running.

- * The indicator of the key-switch shows the amount of shift.

3. CONFIRMATION OF D.C. AND ✖ MEASURE

- ① Set the MODE selector (B) to either TRACK PLAY or TRACK WRITE.
- ② Stop the play.
- ③ *In case of D.C. measure:
While holding the FUNCTION button (L) down, press the CLEAR/RESET button (I)

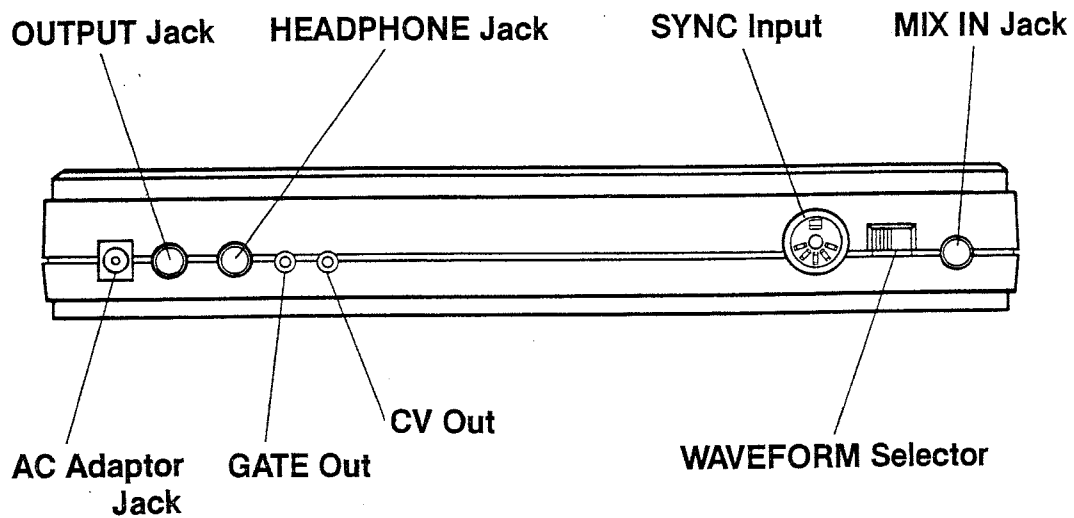
In case of ✖ measure:

While holding the FUNCTION button (L) down, press the ✖/BACK button (Q). (Refer to RULES OF INDICATION, P. 69)

2 APPLIED METHOD OF THE TB-303

The TB-303 can be synchronized with other units such as Rhythm machines and Sequencers, by using the SYNC input, and it can control other Synthesizers with its CV and GATE out.

A. REAR PANEL

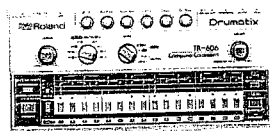


B. SYNCHRONIZATION WITH OTHER UNITS

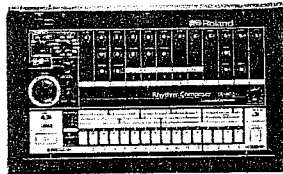
1. SYNCHRONIZATION WITH RHYTHM MACHINES

- The TB-303 can be synchronized with a TR-606, TR-808 or a CR-8000 using a standard five pin DIN cord.

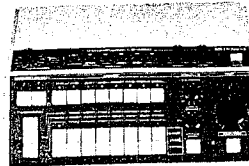
★TR-606



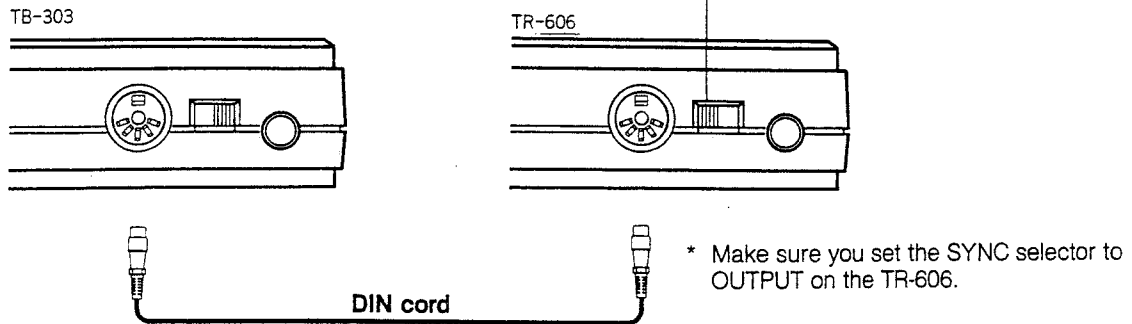
★TR-808



★CR-8000



a. SYNCHRONIZATION WITH THE TR-606

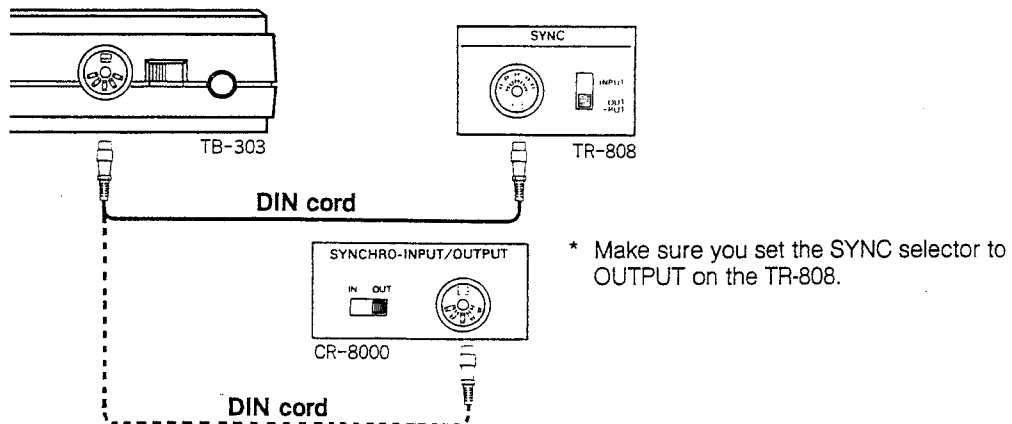


NOTE:

- * Control the tempo, start and stop functions of both units from the TR-606.
- * It may also play D.S.— ♪ again controlled by the TR-606. (When you press the TAP button of the TR-606, both units will return to the ♪ measure).
- * Writing and correcting a Bass part or a Drum part is best achieved while they are disconnected.

- * Before starting a synchronized performance, make sure you press the CLEAR/RESET button on both the TB-303 and the TR-606 (to set them both at the first measure).

b. SYNCHRONIZATION WITH THE TR-808 (OR CR-8000)



NOTE:

- * Control the tempo, start and stop functions from the TR-808 (or CR-8000).
- * The TR-808 cannot perform the D.S. function.
- * Writing and Correcting a Bass part or a Drum part is best achieved whilst they are disconnected.

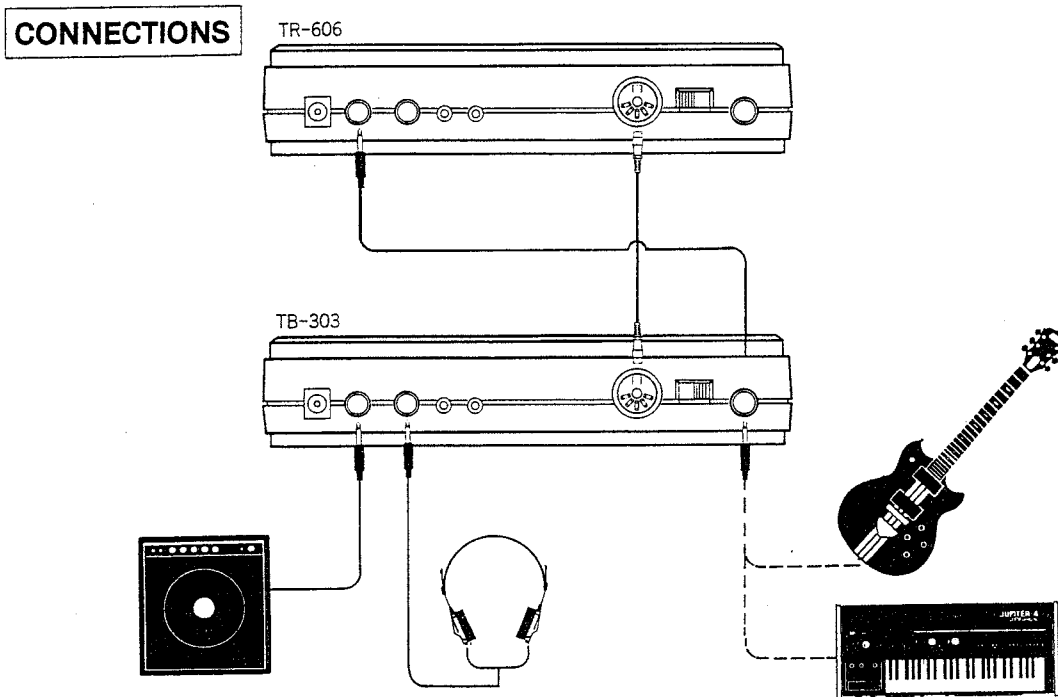
- * Before starting a synchronized performance, press the CLEAR/RESET button of the TB-303.

c. MIX IN

This Input Jack accepts other audio signals (in order to connect a Rhythm machine or an electric guitar), then both sounds come through the amplifier connection (OUTPUT), the new sound being mixed with the Bass sound of the TB-303. You can also monitor the mixed sound using headphones.

NOTE:

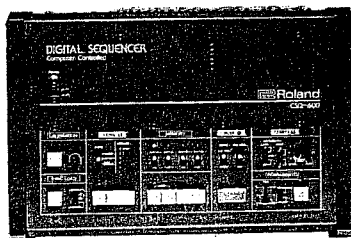
- * You cannot use the MIX IN if the POWER switch of the TB-303 is OFF.
- * The relative volume of the connected machine is controlled by itself, not the TB-303.



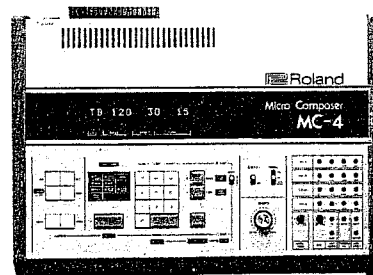
2. SYNCHRONIZATION WITH SEQUENCERS

- The TB-303 can be synchronized with sequencer units such as a CSQ-600 or an MC-4 sequencer again using a standard five pin DIN cord.

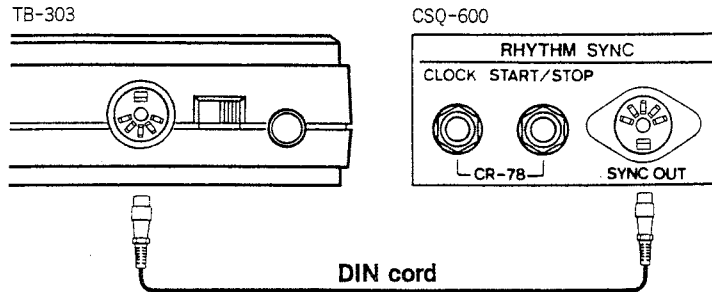
★CSQ-600



★MC-4



a. SYNCHRONIZATION WITH A CSQ-600

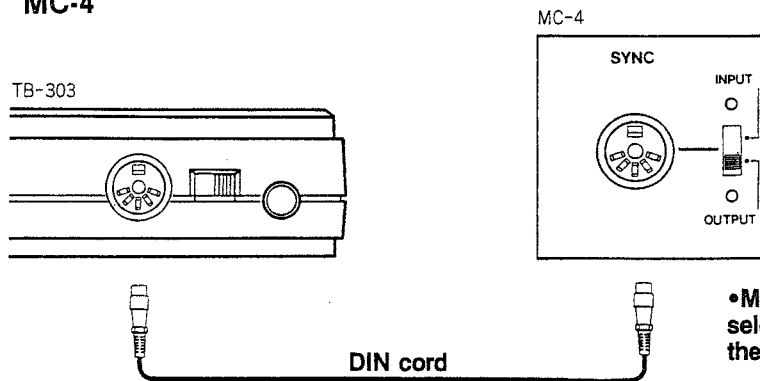


NOTE:

- * Control the tempo, start and stop functions from the CSQ-600.
- * It cannot synchronize correctly using the STOP/CONTINUE function of the CSQ-600 (DO NOT START AGAIN AFTER STOPPING HALFWAY).

- * Make sure you press the CLEAR/RESET button of the TB-303 before starting a synchronized performance.

b. SYNCHRONIZATION WITH A MC-4



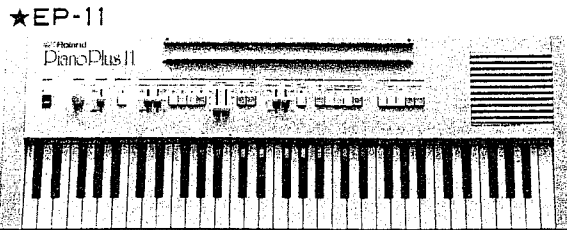
•Make sure you set the SYNC selector to OUTPUT on the TR-606

NOTE:

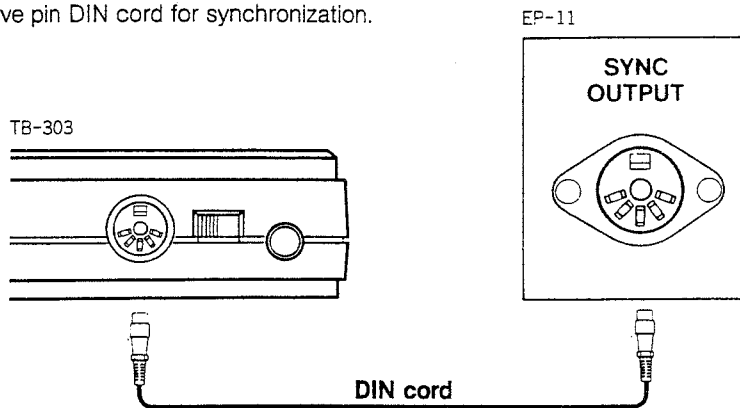
- * Control the tempo, start and stop functions from the MC-4.
- * It cannot synchronize correctly using the STOP/CONTINUE function of the MC-4 (DO NOT START AGAIN AFTER STOPPING HALFWAY).

- * Make sure you press the CLEAR/RESET button of the TB-303 before starting a synchronized performance.

3. SYNCHRONIZATION WITH THE EP-11



- Use a five pin DIN cord for synchronization.



NOTE:

- * Control the tempo, start and stop functions by using the START/STOP button in the Rhythm section of the EP-11.
- * Make sure you press the CLEAR/RESET button of the TB-303.

C. CONTROL OF SYNTHESIZERS

By using the CV and GATE out of the TB-303, you can control other synthesizers (1 volt/oct 1) using the memorized contents of the TB-303.

The TB-303 can then be used as an advanced sequencer to play a Bass line, arpeggios or even a melody line.

1. CV. GATE

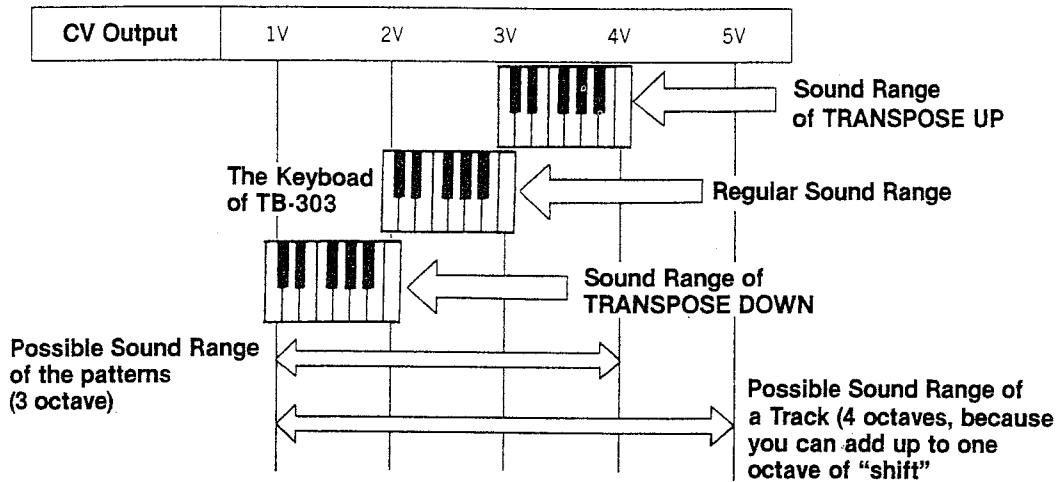
● **CV Output (Control Voltage)**

This voltage depends on the note being played, as shown in Table 1.

● **GATE OUTPUT**

The GATE output is related to the timing of the notes Written into memory, as shown in Table 2.

Table 1



NOTE:

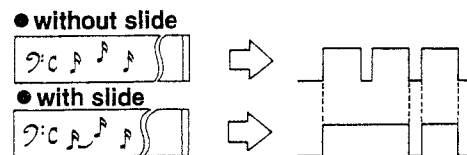
- * Normally a synthesizer will play middle C when the VCO is set for the 8' range and is given a voltage of +2 volts. Therefore to produce the same pitch as the TB-303, set the VCO at 32'. (Refer to Sound Range Diagram on P.88)
- * The slide of the TB-303 works the same way as the portamento on synthesizers, so when the pitch slides, the CV also changes smoothly.
- * Accent in the TB-303 has no effect on the CV and therefore cannot be applied to other synthesizers.
- * The CV can also be used whilst Writing (except when Writing the length of the notes).

Table 2

Length of note	GATE TIME
(=)	
(=)	
7, 7, etc	*OFF when Rest
<p>The GATE TIME is set a little shorter than the length of the note on the score. (It is the same case when STEP MODE is .)</p>	

NOTE:

- * GATE output with SLIDE — the GATE signal changes as shown beside.

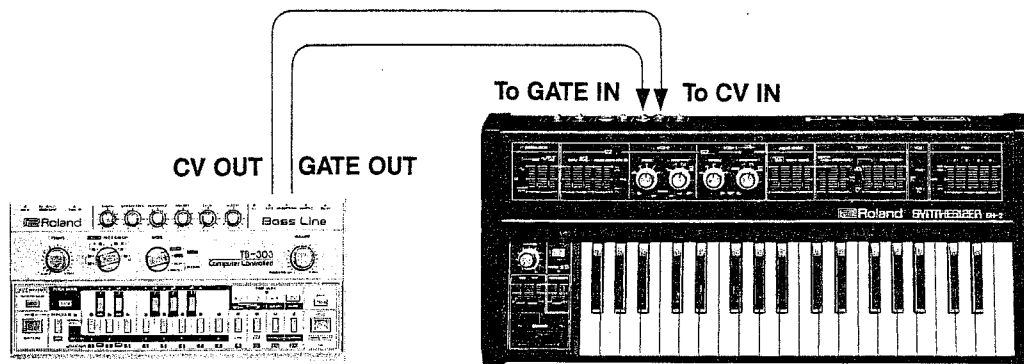


2. CONNECTION

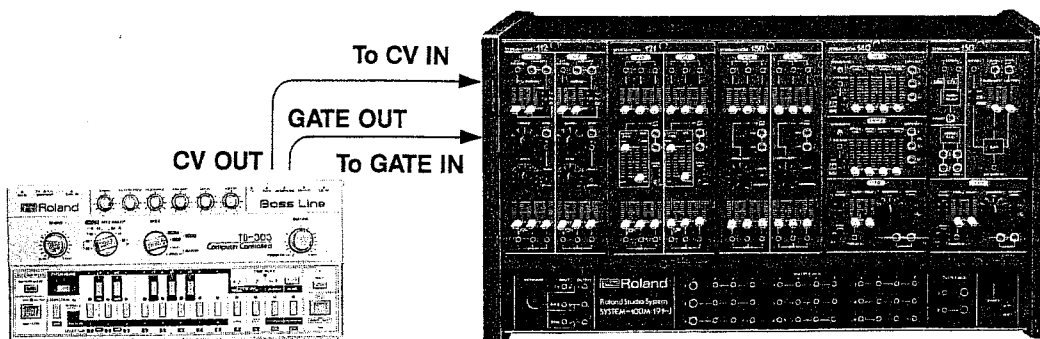
The TB-303 can be connected to any standard synthesizer (1 volt/oct) having CV IN and GATE IN Jacks.

EXAMPLE CONNECTIONS

a. TB-303 + SH-2



b. TB-303 + SYSTEM100M



SAMPLE BASS LINE

► 2 Beats

①

● All are STEP MODE , STEP NUMBER 16

2nd measure

PITCH	<u>F</u>	<u>F</u>		
TIME	● ○ ○ ○	— — — —	● ○ ○ ○	— — — —

4th measure

	<u>G</u>	<u>A</u>	<u>B</u>	
	— — — —	● ○ ○ ○	● ○ ○ ○	● ○ ○ ○

[Note] ● Shift the 2nd measure for the 1st and the 3rd measures.

②

● All are STEP MODE , STEP NUMBER 16

1st measure

PITCH	D [#]	<u>A[#]</u>		
TIME	● ○ ○ ○	— — — —	● ○ ○ ○	— — — —

4th measure

	<u>A[#]</u>	C	D	
	— — — —	● ○ ○ ○	● ○ ○ ○	● ○ ○ ○

6th measure

PITCH	D [#]	<u>G[#]</u>		
TIME	● ○ ○ ○	— — — —	● ○ ○ ○	— — — —

7th measure

	<u>A[#]</u>		<u>A[#]</u>	
	● ○ ○ ○	— — — —	● ○ ○ ○	— — — —

8th measure


PITCH	D [#]	<u>A[#]</u>	<u>D[#]</u>	
TIME	● ○ ○ ○	● ○ ○ ○	● ○ ○ ○	— — — —

[Note] ● Repeat the 1st measure for the 2nd and the 5th measures.

● Shift the 6th measure for the 3rd measure.

► 4 Beats

③

● All are **STEP MODE** , **STEP NUMBER 16**

2nd measure


PITCH	A	A	E	E
TIME	● ○ ○ ○	● ○ ○ ○	● ○ ○ ○	● ○ ○ ○

4th measure

PITCH	G	G	A	B
TIME	● ○ ○ ○	● ○ ○ ○	● ○ ○ ○	● ○ ○ ○

[Note] ● Shift the 2nd measure for the 1st and the 3rd measures.

④

● All are **STEP MODE** , **STEP NUMBER 12**

1st measure

PITCH	C	E	G	A
TIME	● ○ ○ ○	● ○ ○ ○	● ○ ○ ○	● ○ ○ ○

2nd measure

PITCH	A [#]	A	G	E
TIME	● ○ ○ ○	● ○ ○ ○	● ○ ○ ○	● ○ ○ ○

5th measure

PITCH	F	A	C [#]	A
TIME	● ○ ○ ○	● ○ ○ ○	● ○ ○ ○	● ○ ○ ○

6th measure

PITCH	F	G [#]	C [#]	G [#]
TIME	● ○ ○ ○	● ○ ○ ○	● ○ ○ ○	● ○ ○ ○


7th measure

PITCH	C [#]	A [#]	A [#]	A	G [#]	G [#]
TIME	● ○ ○ ○	● ○ ○ ○	● ○ ○ ○	● ○ ○ ○	● ○ ○ ○	● ○ ○ ○

8th measure

PITCH	G	G	G
TIME	● ● ○ ○ ○ ○	● ○ ○ ○ ○ ○	---

[Note] ● Shift the 1st measure for the 3rd measure, and the 2nd measure for the 4th.

● 1st to 6th measures can be written with **STEP MODE** , **STEP NUMBER 16**

► 8 Beats (ROCK, DISCO, BOSSANOVA)

⑤

Chords: C, Am, Dm, G, C, C7, F, Fm, G7, C

• All are STEP MODE , STEP NUMBER 16

2nd measure

PITCH	A	A	A	A
TIME	●	○	○	○

4th measure

PITCH	G	G	G [♯]	A	B
TIME	●	○	○	○	○

7th measure

PITCH	A	G [♯]	G	A	E
TIME	●	○	○	○	○

8th measure

PITCH	C	C	C		
TIME	●	○	○	○	---

[Note] • Shift the 2nd measure for the 1st, the 3rd, the 5th and the 6th measures.

⑥

Chords: F, F, C7, Bb, Bbm, F, C7, F

• All are STEP MODE , STEP NUMBER 16

1st measure

PITCH	F	F	F	C	C	C
TIME	●	○	○	---	●	○

3rd measure

PITCH	G	G	G	C	C	C
TIME	●	○	○	---	●	○

4th measure

PITCH	E	E	E	C	C	D	E
TIME	●	○	○	---	●	○	○

5th measure

PITCH	F	F	F	D [♯]	D [♯]	D [♯]
TIME	●	○	○	---	●	○

6th measure

PITCH	D	D	D	C [♯]	C [♯]	C [♯]
TIME	●	○	○	---	●	○

7th measure

PITCH	C	C	C	C	C	C
TIME	●	○	○	---	●	○

8th measure

PITCH	F	F	F		
TIME	●	○	○	---	---

[Note] • Repeat the 1st measure for the 2nd measure.

⑦

● All are STEP MODE , STEP NUMBER 16

1st measure

PITCH	C	C	D [#]	F	G	G	F	D [#]	C
TIME	●	○	●	○	●	○	●	○	●

4th measure

G	F	F	D [#]	D [#]	D	D
●	○	●	○	●	○	●

5th measure

PITCH	C	C	D [#]	F	G	G	F	D [#]	C
TIME	●	○	●	○	●	○	●	○	●

7th measure

G	G	A [#]	G	B	G	F	D [#]
●	○	●	○	●	○	●	○

8th measure

PITCH	C	C	C
TIME	●	○	○

[Note] ● Shift the 1st measure for the 2nd measure and 5th measure to the 6th.

● Repeat the 1st measure for the 3rd.

⑧

● All are STEP MODE , STEP NUMBER 16

2nd measure

PITCH	G	G	G	G	G	G	G
TIME	●	○	●	○	●	○	●

3rd measure

F	F	F	F	F	F	F [#]	F [#]
●	○	●	○	●	○	●	○

4th measure

PITCH	G	G	G	G	G	A	B
TIME	●	○	●	○	●	○	●

[Note] ● Shift the 2nd measure for the 1st measure.

⑨

• All are **STEP MODE** $J = \text{♪♪♪}$, **STEP NUMBER** 16

1st measure

PITCH	F	F	C	C
TIME	● ○ ○ ○	— — ● ○	● ○ ○ ○	— — ● ○

2nd measure

PITCH	E	E	C	C
TIME	● ○ ○ ○	— — ● ○	● ○ ○ ○	— — ● ○

3rd measure

PITCH	D [♯]	D [♯]	D	C [♯]
TIME	● ○ ○ ○	— — ● ○	● ○ ○ ○	— — ● ○

4th measure

PITCH	C	C	C	E
TIME	● ○ ○ ○	— — ● ○	● ○ ○ ○	— — ● ○

5th measure

PITCH	F	F	C	C
TIME	● ○ ○ ○	— — ● ○	● ○ ○ ○	— — ● ○

6th measure

PITCH	B	B	A [♯]	A [♯]
TIME	● ○ ○ ○	— — ● ○	● ○ ○ ○	— — ● ○

7th measure

PITCH	G [♯]	G [♯]	C	
TIME	● ○ ○ ○	— — ● ○	● ○ ○ ○	— — — —

8th measure

PITCH	F	F		
TIME	● ○ ○ ○	— — ● ○	● ○ ○ ○	— — — —

⑩

• All are **STEP MODE** $J = \text{♪♪♪}$, **STEP NUMBER** 12

4th measure

PITCH	C			
TIME	● ○ ○ ○	— — — —	— — — —	— — — —

6th measure

PITCH	D	F [♯]	A	
TIME	● ○ ○ ○	● ○ ○ ○	● ○ ○ ○	○ ○ ○ ○

7th measure

PITCH	G		G	
TIME	● ○ ○ ○	— — — —	● ○ ○ ○	○ ○ ○ ○

[Note] • Shift the 4th measure for the 1st, the 2nd, the 3rd, the 5th and the 8th measures.

► Sample

The image displays a musical score for a sample, consisting of two staves: Bass and Drums. The score is divided into 12 numbered measures, with the drum part featuring various patterns and articulations.

Measure 1: Bass line starts with a quarter note G2, followed by eighth notes A2, B2, C3, D3, E3, F3, G3. Drum part includes H.H.(close) and Bass Drum.

Measure 2: Bass line continues with quarter notes G3, A3, B3, C4, D4, E4, F4, G4. Drum part includes H.H.(close) and Bass Drum.

Measure 3: Bass line continues with quarter notes G4, A4, B4, C5, D5, E5, F5, G5. Drum part includes H.H.(close) and Bass Drum.

Measure 4: Bass line continues with quarter notes G5, A5, B5, C6, D6, E6, F6, G6. Drum part includes H.H.(close) and Bass Drum.

Measure 5: Bass line continues with quarter notes G6, A6, B6, C7, D7, E7, F7, G7. Drum part includes H.H.(close) and Bass Drum.

Measure 6: Bass line continues with quarter notes G7, A7, B7, C8, D8, E8, F8, G8. Drum part includes H.H.(close) and Bass Drum.

Measure 7: Bass line continues with quarter notes G8, A8, B8, C9, D9, E9, F9, G9. Drum part includes H.H.(close) and Bass Drum.

Measure 8: Bass line continues with quarter notes G9, A9, B9, C10, D10, E10, F10, G10. Drum part includes H.H.(close) and Bass Drum.

Measure 9: Bass line continues with quarter notes G10, A10, B10, C11, D11, E11, F11, G11. Drum part includes H.H.(close) and Bass Drum.

Measure 10: Bass line continues with quarter notes G11, A11, B11, C12, D12, E12, F12, G12. Drum part includes H.H.(close) and Bass Drum.

Measure 11: Bass line continues with quarter notes G12, A12, B12, C13, D13, E13, F13, G13. Drum part includes H.H.(close) and Bass Drum.

Measure 12: Bass line continues with quarter notes G13, A13, B13, C14, D14, E14, F14, G14. Drum part includes H.H.(close) and Bass Drum.

Drum patterns include: H.H.(close), Snare Drum, Bass Drum, Tom, and Cym.

[Note] ● As shown in the Table 1, write the patterns 1 to 12 into the corresponding switches and write these into the tracks according to the Table 2.

Table 1 ● Write all the patterns with **STEP MODE**  **STEP NUMBER** 12

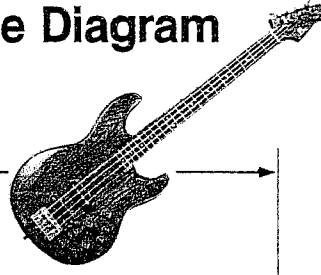
Pattern Number	Memory Positions		
	Group	Section	Switch
①			1
②			2
③			3
④		A	4
⑤	III		5
⑥			6
⑦			7
⑧			8
⑨			1
⑩		B	2
⑪			3
⑫			4

Table 2. (Track Score)

2-A ㉔	2-A ㉕	1-A	2-A	3-A	4-A	5-A	6-A
2-A ㉔	2-A ㉕	1-A	2-A	3-A	4-A	5-A	7-A
2-A	2-A ㉕	8-A	1-B	2-B	2-A ㉖	3-B	4-B
2-A ㉔	2-A ㉕	1-A	2-A	3-A	4-A	5-A	6-A

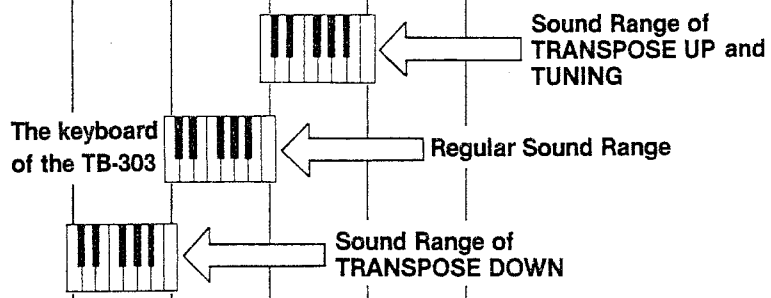
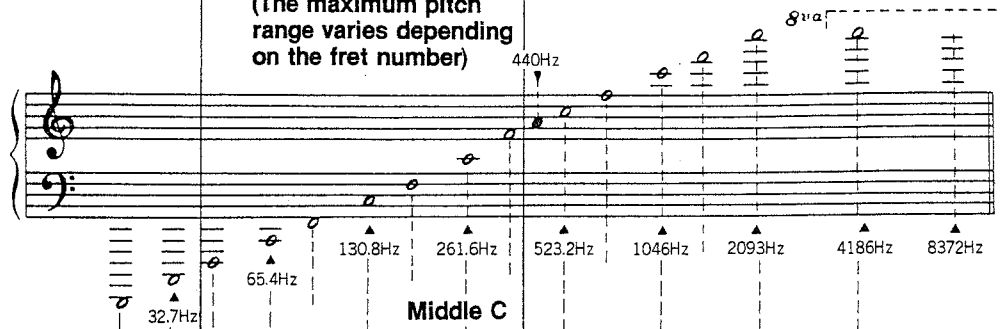
D.C.

Sound Range Diagram



[Note] All the sample scores in this manual are indicated one octave higher than the actual notes.

★ The Sound Range of a base guitar
(The maximum pitch range varies depending on the fret number)



Possible Sound Range of the patterns (3 octave)

Possible Sound Range of a Track (4 octaves, because you can add up to one octave of "Shift")

CV OUTPUT	1V	2V	3V	4V	5V
-----------	----	----	----	----	----

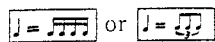
SPECIFICATIONS

■ TB-303 ■ BASS LINE

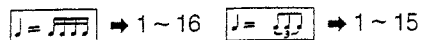
■ NUMBER OF PATTERNS:

64 patterns (8×A, B×I, II, III, IV)

- **Memorized Contents:**
Pitch, Length of Note, Accent, Slide
- **STEP MODE**



- **STEP number/1 measure**



- **Sound Range**
3 Octaves (4 octaves in a TRACK)

■ NUMBER OF TRACKS:

64 measure × 7 TRACKS (256 measures maximum)

- **Memorized Contents:**
Order of Patterns, Shift of Patterns, D.C. ✱

■ CONTROLS AND SELECTORS:

- **TONE CONTROL SECTION:**
CUTOFF FREQUENCY, RESONANCE, ENVELOPE MODULATION, DECAY, ACCENT, WAVEFORM ()
- **TUNING Control:**
(± 500 overcents)
- **TEMPO Control:**
(♩ = 40 ~ 300)
- **MODE Selector:**
PATTERN WRITE, PATTERN PLAY, TRACK WRITE, TRACK PLAY
- **TRACK/PATTERN GROUP Selector:**
- **POWER SWITCH/VOLUME Control:**

■ Switches, Button & Indicators:

- CLEAR/RESET Button:
- RUN/STOP Button;
- BATTERY CHECK/RUN Indicator:
- PITCH MODE Button:
- PITCH MODE Indicator:
- FUNCTION Button:
- NORMAL MODE Indicator:
- SELECTOR Switch & Indicator:
- TIME MODE Button:
- TIME MODE Indicator:
- ✱ /BACK Button:
- TAP Button:

■ CONNECTIONS:

- **DC9V × 1:**
AC Adaptor Jack (BOSS ACA-100)
- **Output × 1:**
Regular Jack, Output Impedance 10kΩ
- **Headphone × 1:**
Stereo Jack, Impedance 8Ω — 30Ω
- **Gate Out × 1:**
Mini-Jack, OFF: 0V; ON: = + 12V:
- **CV Out × 1:**
Mini-Jack, = + 1V — + 5V (1 volt/oct 1)
- **SYNC In × 1:**
DIN connector (for TR-606, CR-8000, MC-4, CSQ-600)
- **MIX IN × 1:**
Regular Jack, Impedance 100KΩ
Input/ Output level: 1:1

- **POWER:** BATTERY — 6V (UM-2 × 4)
AC Adaptor: 9V

CURRENT DRAIN: 80mA (MIN)
120mA (MAX)

Dimensions: 300(W) × 146(D) × 55(H)mm

Weight: 1.0kg

- **Specifications are subject to change without notice.**

ACCESSORIES:

- Compact Soft Case (SC303) × 1
- Connection Cord (PJ-1) × 1

 Roland®

10269

UPC

10269



1090:

Roland