

SPACE ECHO

RE-20

ROLAND SPACE ECHO RE-201

Owner's Manual

Thank you, and congratulations on your choice of the BOSS RE-20 Space Echo.

Before using this unit, carefully read the sections entitled: "USING THE UNIT SAFELY" and "IMPORTANT NOTES" (separate sheet).

These sections provide important information concerning the proper operation of the unit. Additionally, in order to feel assured that you have gained a good understanding of every feature provided by your new unit, this manual should be read in its entirety. The manual should be saved and kept on hand as a convenient reference.

Main Features

- The RE-20 uses COSM technology to faithfully simulate the characteristics of the famed Roland SPACE ECHO RE-201.
- Faithfully reproduces the characteristics of the RE-201, including the echo's distinctive wow- and flutter-induced wavering and the compressed sound obtained with magnetic saturation.
- The Mode Selector carries on the tradition of the RE-201, offering twelve different reverberation effects through various combinations of the three playback heads and reverb.
- You can set delay times with the TAP input pedal and use an expression pedal (sold separately) for controlling parameters.
- Equipped with a "Virtual Tape Display," which produces a visual image of a running tape.

About COSM (Composite Object Sound Modeling)

Composite Object Sound Modeling—or "COSM" for short—is BOSS/Roland's innovative and powerful technology that's used to digitally recreate the sound of classic musical instruments and effects. COSM analyzes the many factors that make up the original sound—including its electrical and physical characteristics—and creates a digital model that accurately reproduces the original.

Copyright © 2007 BOSS CORPORATION

All rights reserved. No part of this publication may be reproduced in any form without the written permission of BOSS CORPORATION.



 **BOSS**®

Contents

Main Features	1	Adjusting the Volume of the Reverb Sound	13
Panel Descriptions	3	Setting the Delay Time with the TAP Pedal (Tap Delay Time)	14
Front Panel	3	Applying the Twist Effect with the TAP Pedal	14
Rear Panel	5	Switching the Repeat Rate and Delay Time Mode	15
Installing Batteries	6	Control Using an Expression Pedal ...	16
Making the Connections	7	Setting the Function of the Expression Pedal	17
Mono Output Connection	8	About the Variation Mode.....	18
Stereo Output Connection	9	About the Playback Heads	18
Connecting to SEND/RETURN	10	About the Roland SPACE ECHO RE-201	19
With Guitar Amps	10	Troubleshooting	20
Connecting to an MTR or Mixer ...	11	Sample Settings	21
Operating the RE-20	12	Main Specifications	22
Basic Operation	12		
Adjusting the Input Volume	13		
Switching the Echo and Reverb Variations	13		
Adjusting the Volume of the Echo Sound	13		
Adjusting the Echo Interval	13		
Adjusting the Volume of the Echo's Repeat	13		
Adjusting the Tone of the Echo (BASS, TREBLE)	13		

About the Roland SPACE ECHO RE-201



The Roland SPACE ECHO RE-201 tape echo debuted in 1974. Even today, with the machine no longer in production, it remains a world-famous device that is still widely acclaimed. The sound of the RE-201, especially the pleasing chorus effect created by the subtle wavering from the movement of the tape—and the characteristic compressed sound that results from magnetic saturation of the tape—continues to intrigue numerous musicians.

Panel Descriptions

Front Panel

TREBLE Knob

Adjusts the echo's high-frequency range. The frequency response is flat when the knob is at the center position; turning the knob to the right (clockwise) boosts the high frequencies, while turning it to the left cuts the high frequencies.

BASS Knob

Adjusts the echo's low-frequency range. The frequency response is flat when the knob is at the center position; turning the knob to the right (clockwise) boosts the low frequencies, while turning it to the left cuts the low frequencies.

REPEAT RATE Knob

This adjusts the intervals between echoes. The spacing between the echoes is reduced as the knob is turned further to the right.

* *The ranges for the speed rate setting differ in Normal mode and Long mode (p. 15).*

REVERB VOLUME Knob

Adjusts the volume of the reverb. Turning the knob to the right increases the volume of the reverb.

MODE SELECTOR Knob

Turn to select one of the twelve combinations of echo and reverb (p. 18).

PEAK LEVEL Indicator

This lights when signal reaches the level at which the input sound starts to distort.

* *This also lights when the intensity is increasing and when the echo sound oscillates while the twist effect is being applied.*

INPUT VOLUME Knob

Adjusts the input levels for Inputs A and B.

* *You can adjust the input level with the INPUT VOLUME knob regardless of whether the effect is switched on or off.*

ECHO VOLUME Knob

Adjusts the volume of the echo. The volume of the echo sounds increases as the knob is turned further to the right.

INTENSITY Knob

This adjusts the volume of the echo repeat sound (the feedback volume). The volume of the feedback increases as the knob is turned further to the right. With certain sounds and knob settings, you can also produce oscillation.

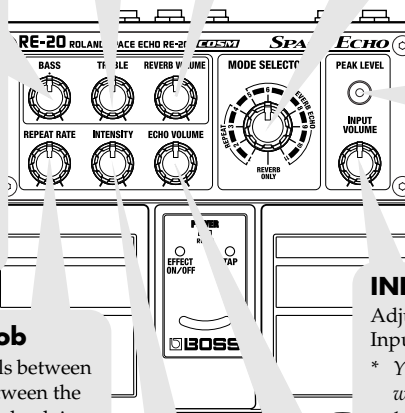

POWER Indicator

This indicator shows whether the power is on or off, and also functions as a battery-check indicator.

* When the indicator starts to dim or fails to light, the batteries are exhausted. When this occurs, install new batteries. For instructions on replacing the batteries, refer to "Installing Batteries" (p. 6).

EFFECT ON/OFF Indicator

This lights up when the effect is on.

TAP Indicator

This flashes in time with the delay time set by the tap input.

* The light is turned off when the twist effect is applied.

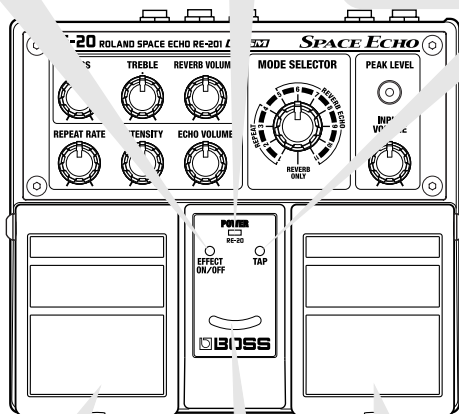

EFFECT ON/OFF Pedal

This alternately switches the effect on or off each time the pedal is pressed. Even when the effect is switched off, the echo sounds still fade gradually.

* Turning up the INTENSITY knob causes the echo sounds to continue.

TAP Pedal

You can set the delay time (tap delay time) by briefly depressing this pedal at the desired tempo (tap input). Also, you can obtain the "twist" effect by keeping the pedal depressed (p. 14).

* The maximum values that can be set for the tap delay time in Normal/Long mode and Variation mode differ (p. 18).

Virtual Tape Display

The movement of the light provides a visual image resembling a running tape.

The movement of the light is synchronized to the virtual tape speed.

Rear Panel

INPUT Jacks (INPUT A/MONO, B)

These input jacks are used for connecting electric guitars, keyboards, other instruments, and effects processors.

Connect mono instruments or effects to the A/MONO jack.

☞ “Making the Connections” (p. 7)

* *The A/MONO jack also doubles as the power switch. The power comes on when a plug is inserted into the A/MONO jack, and goes off when it is unplugged. Unplug any connected cords when the unit is not in use.*

EXP Pedal Jack

Connect an optional expression pedal (such as the Roland EV-5) to this jack.

Once connected, the pedal can be used to control the repeat rate and intensity in real time.

☞ “Control Using an Expression Pedal” (p. 16)

DIRECT Switch

This switches the direct sound on and off.

If you want to turn off output of the direct sound, set the DIRECT switch to OFF.

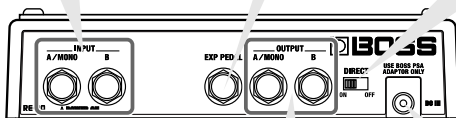

OUTPUT Jacks (OUTPUT A/MONO, OUTPUT B)

Use these jacks to connect the RE-20 to a guitar amp, a keyboard amp, or to an effects processor, mixer, multitrack recorder, or other such device.

When connected to both A/MONO and B, a stereo effect can be obtained when reverb is applied. If you are using the RE-20 in mono, connect to the A/MONO jack only.

☞ “Making the Connections” (p. 7)

DC IN (AC Adaptor) Jack

This jack is for connecting an AC adaptor (BOSS PSA series, sold separately).

Using an AC adaptor makes possible long performances without worrying about your batteries going dead.

* *When you are using an AC adaptor, be sure to use only the specified type (PSA series). Using an adaptor other than the specified type may cause the unit to malfunction, or cause damage to the unit.*

Installing Batteries

Insert the batteries as shown below, being careful to orient the batteries correctly.

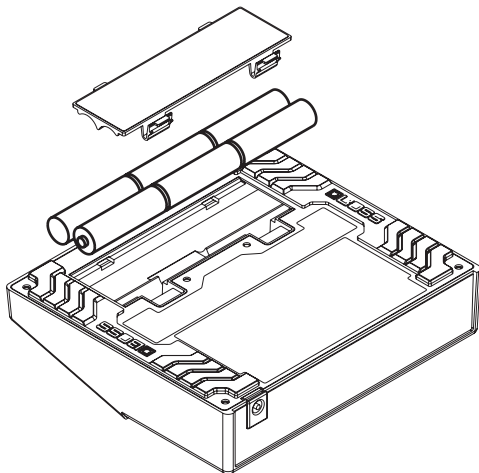

NOTE

- When turning the unit upside-down, get a bunch of newspapers or magazines, and place them under the four corners or at both ends to prevent damage to the buttons and controls. Also, you should try to orient the unit so no buttons or controls get damaged.
- When turning the unit upside-down, handle it with care to avoid dropping it, or allowing it to fall or tip over.
- Make sure the "+" and "-" ends of the batteries are oriented correctly.
- Batteries are supplied with the unit. The life of these batteries may be limited, however, since their primary purpose is to enable testing.
- When the batteries run down, the POWER indicator grows dim. If this happens, install with new batteries.
- When replacing the batteries, use six AA type batteries.
- Avoid using new batteries together with used ones. In addition, avoid mixing different types of batteries. Doing so can result in fluid leakage.
- Battery life can vary depending on battery type.

MEMO

Continuous usage time under battery power is about 32 hours with alkaline batteries and about 9 hours with carbon batteries. (This may vary according to usage conditions.)

Making the Connections

NOTE

- When using an AC adaptor, be sure to use only the specified type (PSA series; sold separately).
Using an adaptor other than the specified type may cause the unit to malfunction, or cause damage to the unit.
- To prevent malfunction and/or damage to speakers or other devices, always turn down the volume and turn off the power to all devices before making any connections.
- Noise may be produced if wireless communications devices, such as cell phones, are operated in the vicinity of this unit. Such noise could occur when receiving or initiating a call, or while conversing. Should you experience such problems, you should relocate such wireless devices so they are at a greater distance from this unit, or switch them off.
- Some connection cables contain resistors. When connection cables with resistors are used, the sound level may be extremely low, or impossible to hear. For information on cable specifications, contact the manufacturer of the cable.
- The INPUT A/MONO jack doubles as a power switch. Inserting a plug in the INPUT A/MONO jack turns on the power; the power is switched off when the plug is disconnected. Be sure to unplug the cable from this jack when the RE-20 is not in use.
- If there are batteries in the unit while an AC adaptor is being used, normal operation will continue should the line voltage be interrupted (power blackout or power cord disconnection).
- Once the connections have been completed, turn on power to your various devices in the order specified. By turning on devices in the wrong order, you risk causing malfunction and/or damage to speakers and other devices.
When powering up: Turn on the power to your guitar amp **last**.
When powering down: Turn off the power to your guitar amp **first**.
- Always make sure to have the volume level turned down before switching on power. Even with the volume all the way down, you may still hear some sound when the power is switched on, but this is normal, and does not indicate a malfunction.
- When operating on battery power only, the POWER indicator will become dim when battery power gets too low. Replace the batteries as soon as possible.
- This unit is equipped with a protection circuit. A brief interval (a few seconds) after power-up is required before the unit will operate normally.

Mono Output Connection

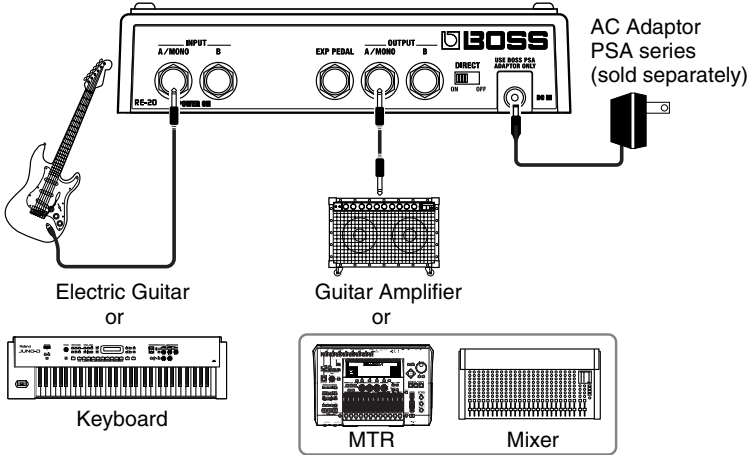

Stereo Output Connection

■ Mono Input

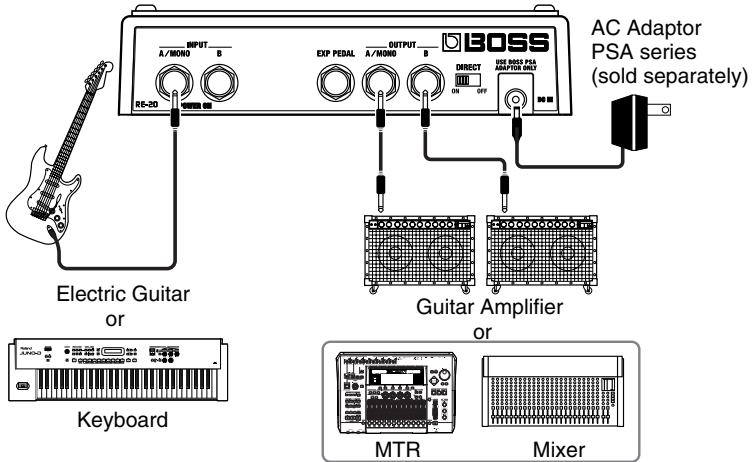

■ Stereo Input

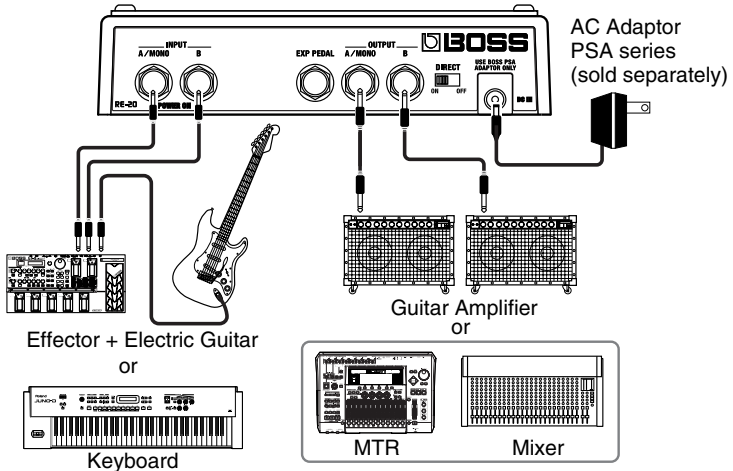

Connecting to SEND/RETURN

With Guitar Amps

■ Mono Send/Mono Return

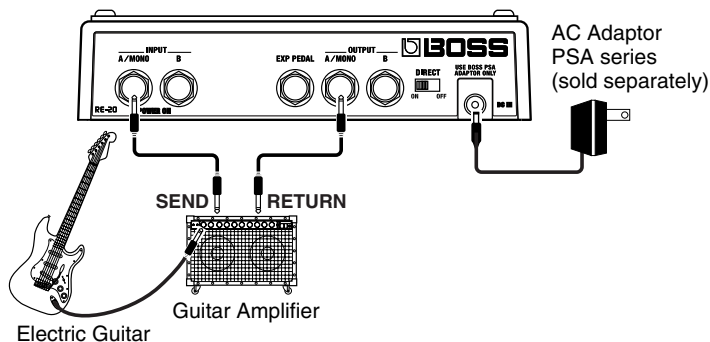

■ Mono Send/Stereo Return

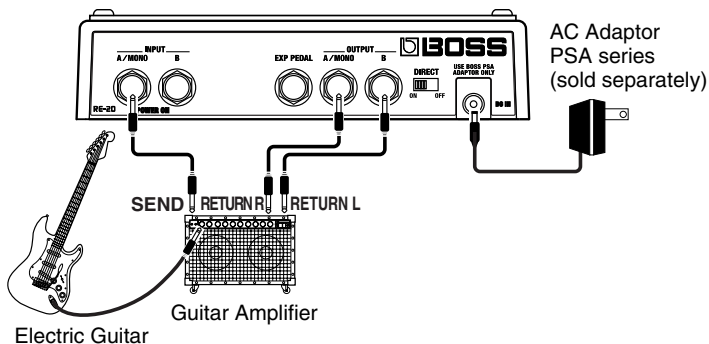

Connecting to an MTR or Mixer

If you want to turn off output of the direct sound—for example when connecting to a mixer’s SEND/RETURN—set the DIRECT switch to OFF.

■ Mono Send/Mono Return

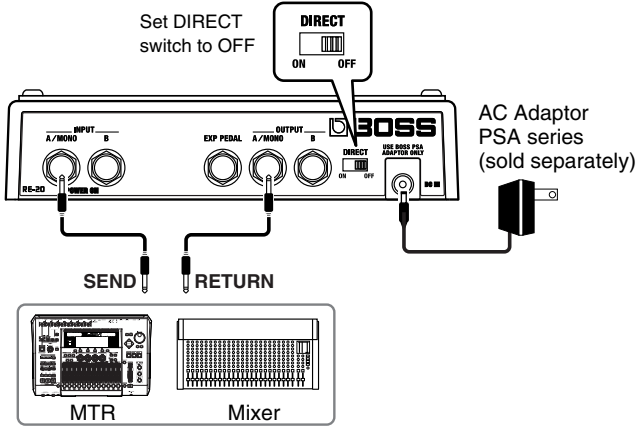

■ Stereo Send/Stereo Return

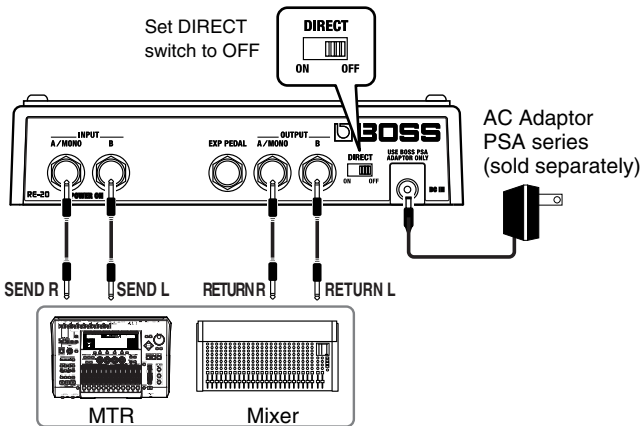

Operating the RE-20

Basic Operation

For this demonstration of using the pedals, first press the EFFECT ON/OFF pedal to switch on the effect (ON/OFF indicator lit), and set the DIRECT switch to ON.

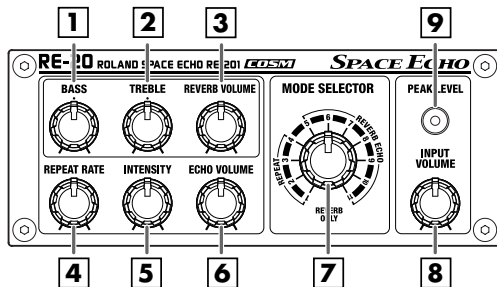

1. Set the knobs as shown in the figure.
2. Using the INPUT VOLUME knob **8** and the volume control on the connected device, adjust the input level so that the PEAK LEVEL indicator **9** lights momentarily when the instrument connected to the RE-20 is played forcefully.
3. Set the MODE SELECTOR knob **7** to the 1 position.
4. Turn the ECHO BASS knob **6** to adjust the volume of the echo.
5. Turn the REPEAT RATE knob **4** to adjust the echo interval.
6. Turn the INTENSITY knob **5** to adjust the volume of the echo's repeat.
7. Turn the BASS knob **1** to adjust the echo's low-frequency range.
8. Turn the TREBLE knob **2** to adjust the echo's high-frequency range.
9. Set the MODE SELECTOR knob **7** to the REVERB ONLY position.
10. Turn the REVERB VOLUME knob **3** to adjust the volume of the reverb.
11. Turn the MODE SELECTOR knob **7** to select the Variation mode.

* For more detailed information on the Variation mode types, refer to the "About the Variation Mode" (p. 18).

Adjusting the Input Volume

The input level can be adjusted with the INPUT VOLUME knob **8**.

* *The input level can be adjusted with the INPUT VOLUME knob regardless of whether the effect is switched on or off.*

Switching the Echo and Reverb Variations

You can use the MODE SELECTOR knob **7** to switch among the twelve Variation modes, which offer different combinations of echo and reverb.

* *For more detailed information on the Variation mode types, refer to the "About the Variation Mode" (p. 18).*

Adjusting the Volume of the Echo Sound

You can adjust the volume of the echo sound with the ECHO VOLUME knob **6**.

Adjusting the Echo Interval

You can adjust the amount of time between echoes with the REPEAT RATE knob **4**.

Adjusting the Volume of the Echo's Repeat

You can adjust the volume of the repeating echo sound (amount of feedback) with the INTENSITY knob **5**.

Adjusting the Tone of the Echo (BASS, TREBLE)

You can use the BASS **1** and TREBLE **2** knobs to adjust the low- and high-frequency ranges of the echo sound only.

Adjusting the Volume of the Reverb Sound

You can adjust the volume of the reverb sound with the REVERB VOLUME knob **3**.

* *Enabled only when the MODE SELECTOR knob is set to any position from 5 through 11 or to REVERB ONLY.*

Setting the Delay Time with the TAP Pedal (Tap Delay Time)

1. Using the MODE SELECTOR knob, select the Variation mode for which the tap delay time is to be set.

* For more on the playback heads for which the tap delay time is set, and the maximum values of the settings, refer to "About the Variation Mode" (p. 18).

2. Press the TAP pedal two or more times at the tempo you want to set.

This sets the tap delay time. The TAP indicator flashes in sync with the tap delay time.

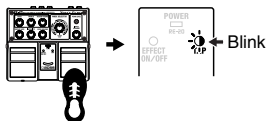

Press two or more times

* Enabled only when the MODE SELECTOR knob is set to any position from 1 through 11.

* When any of the following are carried out, the tap delay time setting changes

REPEAT RATE knob turned → changes to the value set with the REPEAT RATE knob

MODE SELECTOR knob turned → changes to the value set with the REPEAT RATE knob

Repeat rate or twist changed with an expression pedal → changes to the value set with the expression pedal

* You cannot save the tap delay time setting.

* When the twist effect is applied using the TAP pedal (from when the TAP indicator is off to when it goes on or starts flashing), you cannot set the tap delay time.

Applying the Twist Effect with the TAP Pedal

The twist effect simultaneously increases the repeat rate and the intensity, causing the echo sound to oscillate. In addition, the echo volume level is controlled.

* Enabled only when the MODE SELECTOR knob is set to any position from 1 through 11.

1. Press and hold down the TAP pedal.

The TAP indicator goes out, and application of the twist effect begins.

The echo sound begins to oscillate, then the oscillation increases as the pitch rises as well.

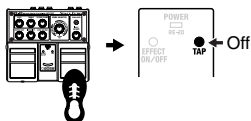

Press and hold down

* You cannot set the repeat rate and intensity while the TAP pedal is held down.

2. Release the TAP pedal.

The pitch of the oscillating sound starts to fall, and the original echo sound returns. The TAP indicator lights when the twist effect is finished.

- * *Once the TAP pedal is released, changing the repeat rate or intensity cancels the twist effect. The setting is then changed to the value set with the knob or expression pedal.*
- * *Adjusting the MODE SELECTOR knob while the twist effect is being applied cancels the twist effect.*
- * *You can apply the twist effect with an external expression pedal. For more detailed information, refer to "Control Using an Expression Pedal" (p. 16).*

Switching the Repeat Rate and Delay Time Mode

The RE-20 features two modes to select from.

Normal mode: The REPEAT RATE knob functions over the same range as the RE-201. Additionally, the maximum value that can be set for the tap delay time is three seconds (when the MODE SELECTOR knob is set to the 3 or 7 position).

Long mode: The range for the REPEAT RATE knob setting is expanded to twice the normal setting. Additionally, the maximum value that can be set for the tap delay time is six seconds (when the MODE SELECTOR knob is set to the 3 or 7 position).

1. Turn off the RE-20.

- * *Disconnecting the plug from the INPUT A/MONO jack switches off the power.*

2. While holding down the TAP pedal, turn on the power to the RE-20.

The virtual tape display flashes, and then remains lit.

- * *Connecting the plug to the INPUT A/MONO jack switches on the power.*

3. Confirm that the virtual tape display is lit, then release the TAP pedal.**4. Turn the MODE SELECTOR knob to select the mode.**

MODE SELECTOR	Mode
1	Normal mode
2	Long mode

5. Press the TAP pedal.

The TAP indicator flashes rapidly, and the setting is saved to the RE-20's memory. When the setting is saved, the TAP indicator remains lit, and the RE-20 returns to its normal operating status.

- * *Be sure not to turn off the power while the TAP indicator is flashing rapidly.*
- * *This setting is saved even after the power is turned off.*
- * *When the RE-20 is set to Long mode, the EFFECT ON/OFF indicator and TAP indicator flash rapidly immediately after the power is turned on.*
- * *The default factory setting is Normal mode.*

Control Using an Expression Pedal

You can control the following functions with an expression pedal (Roland EV-5; sold separately) connected to the EXP PEDAL jack on the rear panel.

- REPEAT RATE:** The echo interval becomes shorter as the toe of the expression pedal is pressed further. In Long mode, the range for the Repeat Rate setting is twice that of Normal mode.
- INTENSITY:** The Intensity increases as the toe of the expression pedal is pressed further, increasing the volume of the echo repeat sound (the feedback volume).
- ECHO LEVEL:** This controls the level input to the echo. The volume of the echo sounds increases as the toe of the expression pedal is pressed further.
- * This function can be controlled only with an expression pedal.
 - * The input level to the reverb is not changed.
- TWIST:** Repeat Rate and Intensity are controlled simultaneously. In addition, this controls the ECHO VOLUME according to the echo level.
- As you further press down on the toe of the expression pedal, the echo sound starts to oscillate, then the oscillation rate increases and the pitch of the oscillation sound rises.

The Repeat Rate and Intensity are set to the minimum value when the heel of the pedal is pressed down; when you press firmly on the toe of the pedal, the value changes to the value that's been set with the knob.

With the twist effect, the value that's been set with the knob is obtained when the heel of the pedal is pressed down; when you press firmly on the toe of the pedal, the value changes to the maximum value.

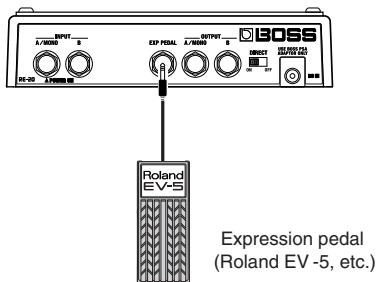

Expression pedal
(Roland EV -5, etc.)

* Use only the specified expression pedal (Roland EV-5; sold separately). By connecting any other expression pedals, you risk causing the unit to malfunction and/or damage to the unit.

Setting the Function of the Expression Pedal

1. Turn off the RE-20.

* *Disconnecting the plug from the INPUT A/MONO jack switches off the power.*

2. While holding down the TAP pedal, turn on the power to the RE-20.

The virtual tape display flashes, and then remains lit.

* *Connecting the plug to the INPUT A/MONO jack switches on the power.*

3. Turn the MODE SELECTOR knob to select a function for the expression pedal.

MODE SELECTOR	Function
3	REPEAT RATE
4	INTENSITY
5	ECHO LEVEL *1
6	TWIST

*1 This function can be controlled only with an expression pedal.

4. Press the TAP pedal to set that function.

The TAP indicator flashes rapidly, and the setting is saved to the RE-20's memory. When setting is saved, the TAP indicator remains lit, and the RE-20 returns to its normal operating status.

* *Be absolutely sure to avoid turning off the power while settings are being saved.*

* *This setting is retained even while the power is turned off.*

* *The factory default setting is REPEAT RATE.*

About the Variation Mode

You can use the MODE SELECTOR knob to switch among the twelve Variation modes, which offer different combinations of echo and reverb.

MODE SELECTOR		REPEAT				REVERB ECHO						REVERB ONLY	
		1	2	3	4	5	6	7	8	9	10		11
Play-back Heads	1	●				●			●		●	●	
	2		●		●		●		●	●		●	
	3			●	●			●		●	●	●	
REVERB						●	●	●	●	●	●	●	●

● : On

■ : The playback heads set with the tap delay times

REPEAT (MODE SELECTOR knob “1”–“4”) : Echo only

REVERB ECHO (MODE SELECTOR knob “5”–“11”) : Combined echo and reverb

REVERB ONLY (MODE SELECTOR knob “REVERB ONLY”) : Reverb only

About the Playback Heads

Relative to whatever the tap delay time is at playback head 1, the tap delay time at playback head 2 is twice that, and the tap delay time at playback head 3 is three times that.

Example: With the MODE SELECTOR knob set to the “11” position and the tap delay time set to 0.5 seconds

The setting is 0.5 seconds at playback head 1, 1 second at playback head 2, and 1.5 seconds at playback head 3.

* The maximum values that can be set for the tap delay time in Normal/Long mode and Variation mode differ.

MODE SELECTOR	Maximum Values for Tap Delay Time (Seconds)	
	Normal Mode	Long Mode
1, 5, 8, 10, 11	1	2
2, 4, 6, 9	2	4
3, 7	3	6

About the Roland SPACE ECHO RE-201

The Roland SPACE ECHO RE-201 is a reverb-equipped tape echo that debuted in 1974.

About the Configuration of the Tape Echo/Reverb

The tape echo section features an erase head, record head, and three playback heads arranged sequentially at equal intervals, such that a sound is played back three times at equal intervals.

The three playback heads are switched with the MODE SELECTOR knob, making it possible to create different variations (patterns) of echo intervals.

The reverb section is equipped with a spring reverb. The reverb signal path is connected in parallel to the tape echo section.

Changing of the Echo Sound's Pitch When REPEAT RATE is Changed

Turning the REPEAT RATE knob to the right (clockwise) gradually increases the tape speed. As this happens, sounds are played back more closely together, and the pitch begins to rise.

Simultaneously, the density of the sounds during recording gradually decreases, so when those sounds reach the playback heads, the pitches that were raised then begin to fall.

Oscillation in the Tape Speed

Even without any change in the REPEAT RATE knob setting, the tape speed is always changing slightly due to the resistance from mechanical friction, tape slippage, and other factors.

This creates oscillations in the pitch of each of the three echo sounds, automatically producing the RE-201's characteristic chorus effect.

About the Change in Sound Quality with Magnetic Saturation

Due to magnetic saturation, recording to and playing back from tape produces a sense of compression in the sound, giving it a characteristic warmth that is unique to tape.

In addition, the sonic quality of playback and recording also changes with the change in tape speed.

About the Reverb

The RE-201's reverb section includes three springs arranged in a "Z" formation. The vibration of each spring influences the motion of the others to produce the reverb's characteristic sound.

Troubleshooting

Power doesn't come on

- Is the guitar or keyboard connected correctly to the INPUT A/MONO jack?
 - Check the connections again (p. 7–p. 11).
 - * *The power will not turn on without a plug connected to the INPUT A/MONO jack.*
- Have the batteries run down?
 - Replace them with new batteries (p. 6).
 - * *The batteries included with the RE-20 are meant only to confirm that the unit is functional at the factory.*
 - * *To reduce battery consumption, be sure to disconnect the plug connected to the INPUT A/MONO jack whenever the unit is not in use.*
- Is the specified AC adaptor (PSA series; sold separately) connected correctly?
 - Check the connections again (p. 7–p. 11).
Never use any AC adaptor other than the adaptor specified.

No sound/Volume is low

- Is the other equipment connected correctly?
 - Check the connections again (p. 7–p. 11).
- Could the INPUT VOLUME knob, REVERB VOLUME knob or ECHO VOLUME knob be turned down?
 - Use the INPUT VOLUME knob, REVERB knob or ECHO VOLUME knob to raise the input level.
- Is the volume turned down on the connected guitar/keyboard, effects processor, or other device?
 - Check the settings on the connected equipment (p. 7–p. 11).
- Is the DIRECT switch off?
 - Only the effect sound is output when the DIRECT switch is set to OFF. To output the direct sound, set the switch to ON.
- Could the connected expression pedal be in the raised position?
 - When ECHO LEVEL is assigned as the function of the expression pedal, no echo sound is output unless you step on the pedal (p. 16).

Sound is distorted

- Are the INTENSITY knob and INPUT VOLUME knob positioned correctly?
 - Sounds may become distorted with the knob at certain settings. Turn down the INTENSITY knob and INPUT VOLUME knob to an appropriate level. If in spite of these measures the sound is still distorted, lower the output level of the device connected to the INPUT jacks.

Echo sounds not cancelled even when effect is switched off

- Do you have a long delay time set?
 - Try turning the ECHO VOLUME knob completely to the left (counterclockwise); this allows you to cancel the continuing sounds.
- Is the Intensity turned up?
 - Try turning the INTENSITY knob or ECHO VOLUME knob completely to the left (counterclockwise); this allows you to cancel the continuing sounds.

Sounds output even with no sound input

- Is the Intensity setting turned up?
 - With higher Intensity settings, even when no sounds are being input, the repeat sound gradually increases in volume, and oscillation in the sound may occur.
Set the INTENSITY knob at some point to the left of the center position.

Can't set tap delay time

- Are you sure the tap input you supplied was within the range that can be set for the tap delay time?
 - The maximum values that can be set for the tap delay time in Normal/Long mode and Variation mode differ (p. 18).

The volume level of the instrument connected to the INPUT jack is too low

- Could you be using a connection cable that contains a resistor?
 - Use a connection cable that does not contain a resistor.

Sample Settings

■ AMBIENCE

This sound adds a sense of space using a short delay and reverb.

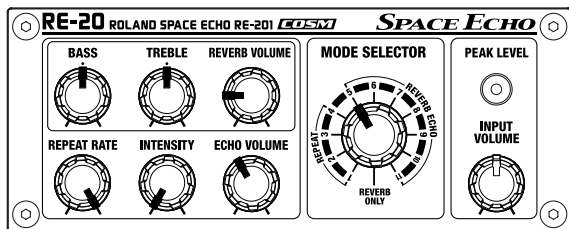

■ RICH ECHO

This is a sumptuous sound with a rich reverb added to the delay. This produces an even greater effect when played back in stereo.

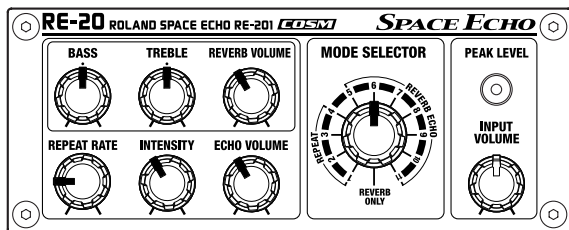

■ MULTI SLAP

Effective with muting techniques for giving the sound a prominent contour. This is even more effective with phrases timed to the repeat sound.

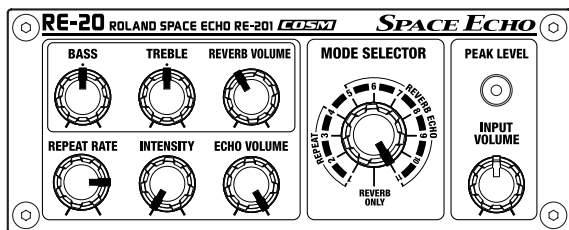

■ SPACE

Connecting an expression pedal and using the pedal to control the intensity in real time allows you to produce even more fantastic sounds. To make this setup effective, set the INTENSITY knob at a position between three o'clock and maximum.

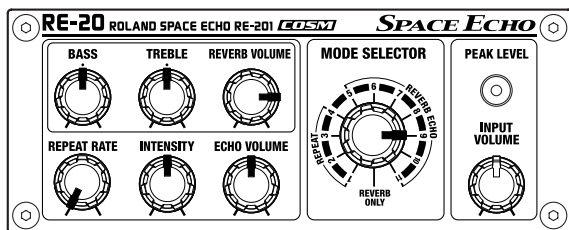

Main Specifications

RE-20: Space Echo

Nominal Input Level

-20 dBu (INPUT VOLUME knob: center),
max +4 dBu

Input Impedance

1 M Ω

Nominal Output Level

-20 dBu

Output Impedance

1 k Ω

Recommended Load Impedance

10 k Ω or greater

Display

Virtual Tape Display

Controls

EFFECT ON/OFF pedal
TAP pedal
BASS knob
TREBLE knob
REVERB VOLUME knob
REPEAT RATE knob
INTENSITY knob
ECHO VOLUME knob
MODE SELECTOR knob
INPUT VOLUME knob
DIRECT switch

Indicators

POWER indicator
(serves also as battery check indicator)
PEAK LEVEL indicator
EFFECT ON/OFF indicator
TAP indicator

Connectors

INPUT jacks A/MONO, B (1/4 inch phone type)
OUTPUT jacks A/MONO, B (1/4 inch phone type)
EXP PEDAL jack (1/4 inch TRS phone type)
DC IN jack (DC 9 V)

Power Supply

DC 9 V: Dry battery LR6/R6 (AA) type x 6,
AC Adaptor (PSA series)

Current Draw

75 mA (9 V max.)

- * *Expected battery life under continuous use:*
Carbon: 9 hours
Alkaline: 32 hours
These figures will vary depending on the actual conditions of use.

Dimensions

173 (W) x 158 (D) x 57 (H) mm
6-13/16 (W) x 6-1/4 (D) x 2-1/4 (H) inches

Weight

1.2 kg / 2 lbs 11 oz (including batteries)

Accessories

Owner's Manual
Leaflet ("USING THE UNIT SAFELY,"
"IMPORTANT NOTES," and "Information")
Dry battery R6 (AA) type (carbon) x 6

Options

AC Adaptor (PSA series)
Expression pedal (Roland EV-5)

- * $0 \text{ dBu} = 0.775 \text{ Vrms}$
- * *In the interest of product improvement, the specifications and/or appearance of this unit are subject to change without prior notice.*

For EU Countries



- UK** This symbol indicates that in EU countries, this product must be collected separately from household waste, as defined in each region. Products bearing this symbol must not be discarded together with household waste.
- DE** Dieses Symbol bedeutet, dass dieses Produkt in EU-Ländern getrennt vom Hausmüll gesammelt werden muss gemäß den regionalen Bestimmungen. Mit diesem Symbol gekennzeichnete Produkte dürfen nicht zusammen mit dem Hausmüll entsorgt werden.
- FR** Ce symbole indique que dans les pays de l'Union européenne, ce produit doit être collecté séparément des ordures ménagères selon les directives en vigueur dans chacun de ces pays. Les produits portant ce symbole ne doivent pas être mis au rebut avec les ordures ménagères.
- IT** Questo simbolo indica che nei paesi della Comunità europea questo prodotto deve essere smaltito separatamente dai normali rifiuti domestici, secondo la legislazione in vigore in ciascun paese. I prodotti che riportano questo simbolo non devono essere smaltiti insieme ai rifiuti domestici.
Ai sensi dell'art. 13 del D.Lgs. 25 luglio 2005 n. 151.
- ES** Este símbolo indica que en los países de la Unión Europea este producto debe recogerse aparte de los residuos domésticos, tal como está regulado en cada zona. Los productos con este símbolo no se deben depositar con los residuos domésticos.
- PT** Este símbolo indica que nos países da UE, a recolha deste produto deverá ser feita separadamente do lixo doméstico, de acordo com os regulamentos de cada região. Os produtos que apresentem este símbolo não deverão ser eliminados juntamente com o lixo doméstico.
- NL** Dit symbool geeft aan dat in landen van de EU dit product gescheiden van huishoudelijk afval moet worden aangeboden, zoals bepaald per gemeente of regio. Producten die van dit symbool zijn voorzien, mogen niet samen met huishoudelijk afval worden verwijderd.
- DK** Dette symbol angiver, at i EU-lande skal dette produkt opsamles adskilt fra husholdningsaffald, som defineret i hver enkelt region. Produkter med dette symbol må ikke smides ud sammen med husholdningsaffald.
- NO** Dette symbolet indikerer at produktet må behandles som spesialavfall i EU-land, iht. til retningslinjer for den enkelte regionen, og ikke kastes sammen med vanlig husholdningsavfall. Produkter som er merket med dette symbolet, må ikke kastes sammen med vanlig husholdningsavfall.
- SE** Symbolen anger att i EU-länder måste den här produkten kasseras separat från hushållsavfall, i enlighet med varje regions bestämmelser. Produkter med den här symbolen får inte kasseras tillsammans med hushållsavfall.
- FI** Tämä merkintä ilmaisee, että tuote on EU-maissa kerättävä erillään kotitalousjätteistä kunkin alueen voimassa olevien määräysten mukaisesti. Tällä merkinnällä varustettuja tuotteita ei saa hävittää kotitalousjätteen mukana.
- HU** Ez a szimbólum azt jelenti, hogy az Európai Unióban ezt a terméket a háztartási hulladéktól elkülönítve, az adott régióban érvényes szabályozás szerint kell gyűjteni. Az ezzel a szimbóllummal ellátott termékeket nem szabad a háztartási hulladék közé dobtani.
- PL** Symbol oznacza, że zgodnie z regulacjami w odpowiednim regionie, w krajach UE produktu nie należy wyrzucać z odpadami domowymi. Produktów opatrzonych tym symbolem nie można utylizować razem z odpadami domowymi.
- CZ** Tento symbol udává, že v zemích EU musí být tento výrobek sbíráán odděleně od domácího odpadu, jak je určeno pro každý region. Výrobky nesoucí tento symbol se nesmí vyhazovat spolu s domácím odpadem.
- SK** Tento symbol vyjadruje, že v krajinách EÚ sa musí zber tohto produktu vykonávať oddelene od domového odpadu, podľa nariadení platných v konkrétnej krajine. Produkty s týmto symbolom sa nesmú vyhazovať spolu s domovým odpadom.
- EE** See sümbol näitab, et EL-i maades tuleb see toode olemprügist eraldi koguda, nii nagu on igas piirkonnas määratletud. Selle sümboliga märgitud tooteid ei tohi ära visata koos olmeprügiga.
- LT** Šis simbolis rodo, kad ES šalyse šis produktas turi būti surenkamas atskirai nuo buitinių atliekų, kaip nustatyta kiekviename regione. Šiuo simboliu paženklinoti produktai neturi būti išmetami kartu su buitinėmis atliekomis.
- LV** Šis simbols norāda, ka ES valstīs šo produktu jāievāc atsevišķi no mājsaimniecības atkritumiem, kā noteikts katrā reģionā. Produkts ar šo simbolu nedrīkst izmest kopā ar mājsaimniecības atkritumiem.
- SI** Ta simbol označuje, da je treba proizvod v državah EU zbirati ločeno od gospodinskih odpadkov, tako kot je določeno v vsaki regiji. Proizvoda s tem znakom ni dovoljeno odlagati skupaj z gospodinskimi odpadki.
- GR** Το σύμβολο αυτό υποδηλώνει ότι στις χώρες της Ε.Ε. το συγκεκριμένο προϊόν πρέπει να συλλέγεται χωριστά από τα υπόλοιπα οικιακά απορρίμματα, σύμφωνα με όσα προβλέπονται σε κάθε περιοχή. Τα προϊόντα που φέρουν το συγκεκριμένο σύμβολο δεν πρέπει να απορρίπτονται μαζί με τα οικιακά απορρίμματα.



This product complies with the requirements of European Directive 89/336/EEC.

For EU Countries

FEDERAL COMMUNICATIONS COMMISSION RADIO FREQUENCY INTERFERENCE STATEMENT

This equipment has been tested and found to comply with the limits for a Class B digital device, pursuant to Part 15 of the FCC Rules. These limits are designed to provide reasonable protection against harmful interference in a residential installation. This equipment generates, uses, and can radiate radio frequency energy and, if not installed and used in accordance with the instructions, may cause harmful interference to radio communications. However, there is no guarantee that interference will not occur in a particular installation. If this equipment does cause harmful interference to radio or television reception, which can be determined by turning the equipment off and on, the user is encouraged to try to correct the interference by one or more of the following measures:

- Reorient or relocate the receiving antenna.
- Increase the separation between the equipment and receiver.
- Connect the equipment into an outlet on a circuit different from that to which the receiver is connected.
- Consult the dealer or an experienced radio/TV technician for help.

This device complies with Part 15 of the FCC Rules. Operation is subject to the following two conditions:

- (1) This device may not cause harmful interference, and
- (2) This device must accept any interference received, including interference that may cause undesired operation.

Unauthorized changes or modification to this system can void the users authority to operate this equipment. This equipment requires shielded interface cables in order to meet FCC class B Limit.

For the USA

For Canada

NOTICE

This Class B digital apparatus meets all requirements of the Canadian Interference-Causing Equipment Regulations.

AVIS

Cet appareil numérique de la classe B respecte toutes les exigences du Règlement sur le matériel brouilleur du Canada.