

PW-10 WAH PEDAL

Owner's Manual



Thank you, and congratulations on your choice of BOSS PW-10 Wah Pedal.

Before using this unit, carefully read the sections entitled: "USING THE UNIT SAFELY" and "IMPORTANT NOTES" (separate sheet). These sections provide important information concerning the proper operation of the unit. Additionally, in order to feel assured that you have gained a good grasp of every feature provided by your new unit, this manual should be read in its entirety. The manual should be saved and kept on hand as a convenient reference.

V-WAH
COSM

BOSS[®]

Main Features

- The world's first modeling wah pedal, utilizing COSM technology to create a wide variety of wah sounds
Eight different sounds include an original BOSS "ADVANCED" tone and the sound of "vintage wah" pedals that are now so hard to obtain, "DOUBLE RESONANCE," which creates an analog synth-like sound, "UNI-V," with a filter effect for that 70's sound, and even a new "VOICE" effect that produces "talking" modulation sounds and realistic human voice sounds. Also included is a CUSTOMIZE function that lets you create your own original wah sounds.
- The infrared sensor "contactless pedal position detection" system both eliminates forever the scratchy noise that has previously been a problem when changing the volume, while also providing a previously unavailable smooth pedal action.
- Features a "WAH RANGE" function that allows you to freely adjust the wah effect range.
- Also has a DRIVE function that actively supports distortion, an effect that complements the wah pedal. Allows you to use eight different "distortion" effects such as "METAL ZONE," "FUZZ," and BOOSTER."
- The MEMORY function lets you take the changes you have made to the effect type, DRIVE, and other settings, and store them as custom wah effects. You can store up to three of such custom settings. You can also use the pedal to call up UNI-V and DRIVE distortion instantly.
- A high-performance "noise suppressor" eliminates the wah pedal's characteristic filter noise.

Contents

Main Features.....	2
Installing Batteries.....	4
Part Names and Functions.....	6
Making the Connections.....	10
Operation.....	13
Storing Settings (Write Operation)	18
Changing the Operation of the Heel Switch.....	20
Creating “Custom” Wah Effects (Customize Mode).....	22
Setting the DRIVE/Noise Suppressor (DRIVE SELECT Mode).....	26
Returning Settings to Their Factory Defaults (Factory Reset)	29
Resetting the Pedal Sensitivity (PEDAL CALIBRATION Mode).....	31
Setting Mode chart	34
Troubleshooting.....	35
Sample Settings.....	37
Specifications.....	40

Copyright © 2001 BOSS CORPORATION

All rights reserved. No part of this publication may be reproduced in any form without the written permission of BOSS CORPORATION.

Installing Batteries

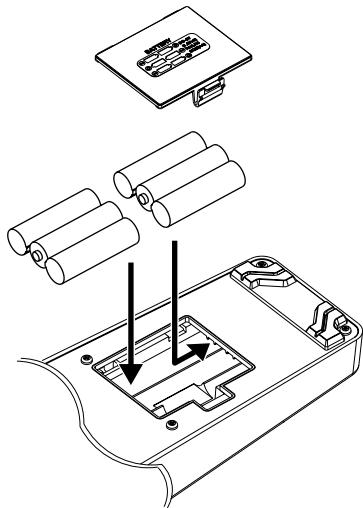

Insert the included batteries as shown in figure, being careful to orient the batteries correctly.

NOTE

- Batteries are supplied with the unit. The life of these batteries may be limited, however, since their primary purpose was to enable testing.
- When turning the unit upside-down, get a bunch of newspapers or magazines, and place them under the four corners or at both ends to prevent damage to controls. Also, you should try to orient the unit so no controls get damaged.
- Make sure the “+” and “-” ends of the batteries are oriented correctly.
- Do not mix fresh batteries with used ones, or mix batteries of different types. Doing so can result in fluid leakage.

- * *When turning the unit upside-down, handle with care to avoid dropping it, or allowing it to fall or tip over.*
- * *When the batteries run down, the ON/OFF indicator gets dim. If this happens, replace with new batteries.*
- * *When replacing the batteries, use six R6/LR6 (AA) type.*
- * *Battery life can vary depending on battery type.*
- * *Firmly close the battery cover—you should hear it click into place.*



Continuous usage time under battery power is about 38 hours with alkaline batteries and about 14 hours with carbon batteries. (This may vary according to usage conditions.)

Part Names and Functions



1. AC Adaptor Jack

This jack is for connecting an AC adaptor (BOSS PSA-series, sold separately). Using an AC adaptor makes possible long performances with no worry about batteries going dead.

2. INPUT Jack

This jack is for connection to an electric guitar or bass guitar.

** The INPUT jack also doubles as the power switch when the unit is running on battery power. The power comes on when a plug is inserted into the INPUT jack, and goes off when it is unplugged. Unplug any connected cords when the unit is not in use.*

3. OUTPUT Jack

This jack is for connection to a guitar amp or another effects processor.

4. Pedal

Controls the wah effect.

Step down hard on the pedal, and the toe switch is activated. Rock the pedal back, then put firm pressure on the heel to activate the heel switch.

You can change the pedal torque (the force or load required to pivot the pedal) by adjusting the screw located on the right side of the unit (shown by arrow).

- * Use a hexagon socket screw key (5 mm) to adjust the screw.
- * Take care not to overtighten the screw; doing so may damage the unit.



When you operate the pedal, please be careful not to get your fingers pinched between the movable part and the panel. In households with small children, an adult should provide supervision until the child is capable of following all the rules essential for the safe operation of the unit.

5. Toe Switch

Switches on/off the effect selected with the TYPE knob.

- * *The distortion remains turned on.*

6. Heel Switch

This switches between “MANUAL” and “MEMORY (1–3).”

When the heel switch is pressed continuously for two or more seconds, the ON/OFF indicator flashes, and the pedal switches to bypass mode (operating the pedal or adjusting the knobs switches the pedal out of bypass).

When bypass is in effect, guitar sounds input at the INPUT jack are output from the OUTPUT jack without being altered.

- * *You can change the way the heel switch changes between “MANUAL” and “MEMORY (1–3).” For more on how to change this setting, refer to “Changing the Operation of the heel switch” (p. 20).*

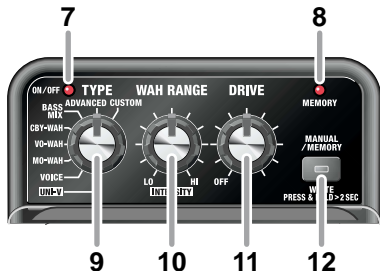

7. ON/OFF Indicator

This lights up when the wah effect selected with the TYPE knob is on. The indicator blinks when the unit is in bypass.

- * **When the batteries run down, the ON/OFF indicator gets dim. If this happens, replace with new batteries.**
- * *The ON/OFF indicator shows whether the wah effect is being applied or not. It does not indicate whether the power to the device is on or not.*

8. MEMORY Indicator

This lights up when set to “MEMORY (1–3).” The color of the light changes according to which Memory is selected.

- Memory 1 red
- Memory 2 green
- Memory 3 yellow

9. TYPE Knob

This selects the effect to be controlled with the pedal. (p. 14)

10. WAH RANGE Knob

This adjusts the range of frequencies to which the wah effect is applied.

- * *When TYPE is set to "VOICE," this knob selects the type of expression used. When set to "UNI-V," this functions as an INTENSITY knob, which adjusts the depth of the undulation. (p. 15–16)*

11. DRIVE Knob

This adjusts the amount of distortion.

- * *Although the output level of DRIVE is already set to the appropriate level, it can also be changed in DRIVE SELECT mode (p. 26), and when carrying out the write operation (p. 18).*

12. MANUAL/MEMORY Button

Pressed to select from "MANUAL" and "MEMORY (1–3)."

- **MANUAL:**
The output sound directly reflects the settings of the panel controls.
- **MEMORY:**
The MEMORY indicator lights up, and sounds are output according to the settings saved to Memories 1–3.
- * *Holding this down for two seconds or longer switches the unit to the write operation.*

Making the Connections

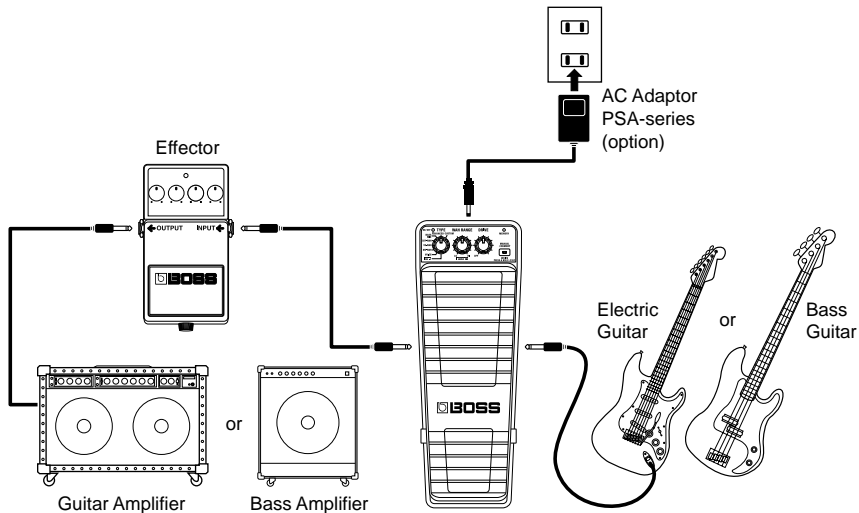

**NOTE**

- Noise may be produced if wireless communications devices, such as cell phones, are operated in the vicinity of this unit. Such noise could occur when receiving or initiating a call, or while conversing. Should you experience such problems, you should relocate such wireless devices so they are at a greater distance from this unit, or switch them off.
- Use a cable from Roland to make the connection. If using some other make of connection cable, please note the following precautions.
 - Some connection cables contain resistors. Do not use cables that incorporate resistors for connecting to this unit. The use of such cables can cause the sound level to be extremely low, or impossible to hear. For information on cable specifications, contact the manufacturer of the cable.
- To prevent malfunction and/or damage to speakers or other devices, always turn down the volume, and turn off the power on all devices before making any connections.
- If there are batteries in the unit while an AC adaptor is being used, normal operation will continue should the line voltage be interrupted (power blackout or power cord disconnection).

Turning the Power On

Once the connections have been completed, turn on power to your various devices in the order specified. By turning on devices in the wrong order, you risk causing malfunction and/or damage to speakers and other devices.

- When powering up: Turn on the power to your guitar amp **last**.
- When powering down: Turn off the power to your guitar amp **first**.
- * *When the unit is running on battery power, the power comes on when you insert the connector plug into the INPUT jack.*
- * *You may hear some sound when the power is switched on, but this is normal, and does not indicate a malfunction.*
- * *When operating on battery power only, the ON/OFF indicator will become dim when battery power gets too low. Replace the battery as soon as possible.*

Operation

So you are better able to follow along with the following explanations, you should first step down firmly on the pedal to switch on the toe switch, and turn on the wah effect (ON/OFF indicator is lit).

Also, set the WAH RANGE knob to the center position, and the DRIVE knob to OFF, and press the MANUAL/MEMORY button to set it to “MEMORY” (MEMORY indicator lighted).

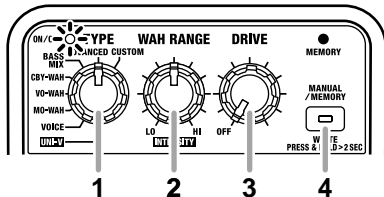

1. Select the desired effect with the TYPE knob.

TYPE	Description
CUSTOM	Your own original wah effect, created using the Customize function (p. 22).
ADVANCED	New BOSS original wah effect that provides a wider range of tone changes.
BASS MIX	New type of wah effect suitable for bass, with no attenuation of the lower range.
CBY-WAH	Models the sound of the JMI Cry Baby.
VO-WAH	Models the sound of the VOX V846.
MO-WAH	Models the sound of the Morley Bad Horsie.
VOICE	A further advancement beyond the BOSS HUMANIZER, this effect produces “talking” modulation sounds and realistic human voice sounds.
UNI-V	Models the sound of the “Uni-Vibe” effect reminiscent of the late 60’s and 70’s.

** All product names mentioned in this document are trademarks or registered trademarks of their respective owners. Those companies are not affiliated with BOSS and have not licenced or authorized BOSS's PW-10. Their marks are used solely to identify the equipment whose sound is simulated by BOSS's PW-10.*

2. Rotate the WAH RANGE knob to adjust the frequencies to which the wah effect is to be applied.

The band of frequencies to which the effect is applied rises as the knob is turned to the right (clockwise); turning the knob to the left lowers the range of frequencies.

Turning this to the left is effective when using a bass guitar.

- * *The CBY-WAH, VO-WAH, and MO-WAH effects are based on having this knob set at the center position.*
- * *When TYPE is set to "VOICE," this knob selects the type of expression used. When set to "UNI-V," this functions as an INTENSITY knob that adjusts the depth of the undulation.*

TYPE	WAH RANGE (INTENSITY)
CUSTOM ADVANCED BASS MIX CBY-WAH VO-WAH MO-WAH	Sets the peak frequency controlled with the pedal.
VOICE	Selects which of the 11 types is to be played.
UNI-V	Sets the depth of the undulation produced by the UNI-V.

VOICE Type Played

WAH RANGE	MIN	←	Pedal	→	MAX	Remarks
LO  HI	ui	←	i	→	ia	Talking modulation-like sound
	oe	←	e	→	ea	
	ua	←	a	→	ai	
	i	←	e	→	a	Realistic human voice
	u	←	a	→	i	
	o	←	i	→	e	
	u	←	i	→	a	
	o	←	e	→	i	
	u	←	a	→	o	
	o	←	i	→	a	
	u	←	e	→	i	

3. If you want to add distortion, turn the DRIVE knob to the right.

The distortion increases the more the knob is turned to the right.



You can select and store one of the eight different “distortion” types, such as “METAL ZONE,” “FUZZ,” “BOOSTER,” etc. (p. 26)

The volume level can also be stored by placing the DRIVE knob at the appropriate position at the time of a write operation. (p. 18)

4. Press the MANUAL/MEMORY button to switch the “MANUAL” and “MEMORY (1–3)” settings.

When set to “MANUAL,” sounds are output exactly as set by the panel controls.

When set to “MEMORY,” the MEMORY indicator lights up, and sounds are output according to the settings saved to Memories 1–3.



Bring the pedal back and press the heel switch to switch between “MEMORY (1–3)” and “MANUAL.”

When the heel switch is held down for two seconds or longer, the ON/OFF indicator flashes, and the pedal switches to the bypass mode. In the bypass mode, guitar sounds input at the INPUT jack are output as is from the OUTPUT jack (operating the pedal or adjusting the knobs switches the pedal out of bypass).

Storing Settings (Write Operation)

This stores the current settings to “MEMORY (1–3).”

NOTE Do not switch off the power while a write operation is in progress.

1. Hold down the **MANUAL/MEMORY** button for at least two seconds. The MEMORY indicator blink, and the PW-10 is put into write standby.

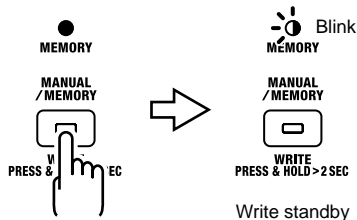

2. Press the **MANUAL/MEMORY** button to select the memory (number) to which you want to store the sound. Each time the button is pressed, the Memories (1–3) are switched as shown below, while the color of the blinking MEMORY indicator light changes at the same time.

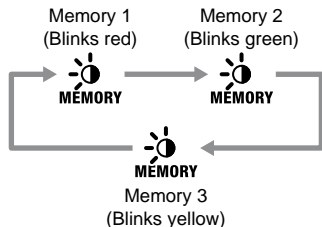

3. When you want to change the output level for DRIVE, use the DRIVE knob to adjust the volume level.

** You cannot adjust this output level if DRIVE is off when Step 1 is carried out.*

4. Hold down the MANUAL/MEMORY button for at least two seconds.

The write operation is completed when the MEMORY indicator begin to blink more rapidly.

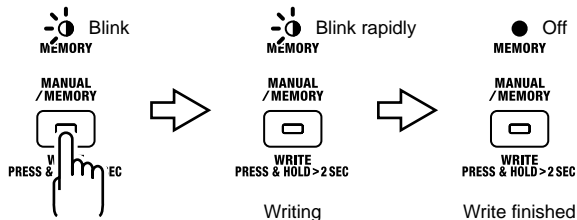

** To cancel the write operation, then before you operate the TYPE knob or the WAH RANGE knob.*

Changing the Operation of the Heel Switch

You can select either of two ways (A and B) to switch between “MANUAL” and “MEMORY 1–3” when the rear switch is pressed.

- A. Each time the heel switch is pressed, the unit switches to “MANUAL” and then through “MEMORY (1–3)” in order (factory setting).**

This setting is convenient when you want to switch among a variety of different effects.

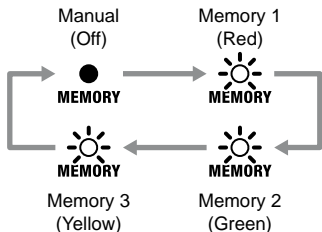

- B. Each time the heel switch is pressed, the unit toggles between “MANUAL” and only the one memory.**

This setting is convenient when you want quick toggling between two effects. Select the memory you want to call up with the MANUAL/MEMORY button.

** Memory 1 is selected when the power is switched on.*

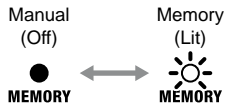

You can use the following procedure to switch the operation of the rear switch (A/B).

- 1. Turn off the power to the guitar amp.**
- 2. Switch off the PW-10's power.**
 - When running on battery power: Disconnect the connection plug from the INPUT jack.
 - When running on power from an AC adaptor: Disconnect the plug from the AC Adaptor jack.
- 3. Turn the TYPE knob to "BASS MIX."**
- 4. While holding down the MANUAL/MEMORY button, switch on the PW-10' power.**
 - When running on battery power: Insert the connection plug into the INPUT jack.
 - When running on power from an AC adaptor:

Insert the AC adaptor plug into the AC Adaptor jack.

The ON/OFF indicator blinks five times, then the MEMORY indicator blinks.

- 5. Turn on the power to the guitar amp.**
- 6. Press the MANUAL/MEMORY button.** The setting is changed, and the unit returns to normal operation ("MANUAL" mode).



The setting for the distortion added with the DRIVE knob is stored to "MEMORY." When the DRIVE knob is set to OFF after this, then by using the pedal to activate the heel switch, you can use the heel switch as a sort of DRIVE on/off switch.

Creating “Custom” Wah Effects (Customize Mode)

You can change existing wah effects to suit your own taste and playing style and even create your own original custom wah effects.

The new wah effects made with these settings are stored to the TYPE knob “CUSTOM” settings, so by turning the TYPE knob to CUSTOM, you can then use the effect just like other wahs.

- 1. With the TYPE knob, select the wah type on which you want to base your new effect, then set WAH RANGE and DRIVE to the desired positions.**
- 2. Turn off the power to the guitar amp.**
- 3. Switch off the PW-10's power.**
 - When running on battery power: Disconnect the connection plug from the INPUT jack.
 - When running on power from an AC adaptor: Disconnect the plug from the AC Adaptor jack.
- 4. Turn the TYPE knob to CUSTOM.**
- 5. While holding down the MANUAL/MEMORY button, switch on the PW-10's power.**
 - When running on battery power: Insert the connection plug into the INPUT jack.
 - When running on power from an AC adaptor: Insert the AC adaptor plug into the AC Adaptor jack.

The ON/OFF indicator blinks seven times, and the PW-10 switches to Custom-ize mode.
- 6. Turn on the power to the guitar amp.**

- 7. With the TYPE knob, select the wah type on which you want to base your custom effect.**

** Until the TYPE knob is turned, the last wah type set to CUSTOM remains selected.*

TYPE knob	Base wah type
CUSTOM (factory setting)	DOUBLE RESONANCE (p. 24)
ADVANCED	ADVANCED
BASS MIX	BASS MIX
CBY-WAH	CBY-WAH
VO-WAH	VO-WAH
MO-WAH	MO-WAH
VOICE	
UNI-V	

** When selecting DOUBLE RESONANCE, first turn the TYPE knob to a setting other than CUSTOM, then select CUSTOM again.*

- 8. Adjust the Q with the WAH RANGE knob.**

Q produces changes in the wah filter. The frequency range gets narrower as the knob is turned to the right (clockwise), creating a sharper filter with a tone with strong characteristics. Turning the knob to the left widens the frequency range, creating a less severe filter effect. When the knob is at the center position, the tone is as modeled.

- 9. Adjust the presence with the DRIVE knob (p. 25).**

The high-frequency components are attenuated more as the knob is turned to the left. There is no attenuation of the high frequencies when the knob is turned completely to the right.

When the knob is at the center position, the sonic qualities are as modeled.

- * *When selecting MO-WAH, the high frequency range is being boosted as the knob is turned to the right.*

10. When you have obtained the desired wah effect, press the MANUAL/MEMORY button.

The settings are saved, and the unit returns to normal operation (“MANUAL” mode).

11. With the TYPE knob, select CUSTOM to get the effect that has been set.

- * *You cannot switch between MANUAL and MEMORY while in Customize Mode.*
- * *In Customize mode, settings made for WAH RANGE and DRIVE in Step 4 utilize the knob positions at the time the power is turned on. You cannot change the WAH RANGE and DRIVE settings after switching to Customize mode.*

What is DOUBLE RESONANCE?

This completely new and original effect offers enhancements on the characteristic resonances produced by analog synth filters. When combined with fuzz or other rough distortion, it yields an amazingly fat tone like that from a synthesizer. And using it together with delay, reverb, chorus, and other spatial effects makes them even more effective.

The Relationship Between the Wah Input Impedance and the Tone

Pedals known as “vintage” wah pedals have a low impedance; this attenuates a guitar's high-frequency component when a guitar is connected to the pedal. However, this high-end attenuation occurs in conjunction with the wah's filter tone, the result being a pleasant-sounding effect. Rather than using a lower impedance, the PW-10 models the effect that this low impedance has on the tone. Presence controls this effect. Turning the knob completely to the right results in no attenuation of the high frequencies, while the high-frequency components become more attenuated as the knob is turned further to the left.

Setting the knob at the center position results in the tone produced when connecting guitars equipped with single-coil pickups, while setting the knob to the ten-o'clock position produces the degree of attenuation you get when connecting guitars with humbucking pickups.

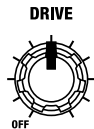

Single-coil

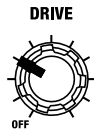

Humbucking

Setting the DRIVE/Noise Suppressor (DRIVE SELECT Mode)

* The “ADVANCED” wah effect is selected in DRIVE SELECT mode.

* Changing the DRIVE type does not change the distortion tone saved to memory.

- 1. Turn off the power to the guitar amp.**
- 2. Switch off the PW-10's power.**
 - When running on battery power: Disconnect the connection plug from the INPUT jack.
 - When running on power from an AC adaptor: Disconnect the plug from the AC Adaptor jack.
- 3. Turn the TYPE knob to ADVANCED.**
- 4. While holding down the MANUAL/MEMORY button, switch on the PW-10's power.**
 - When running on battery power: Insert the connection plug into the INPUT jack.
 - When running on power from an AC adaptor: Insert the AC adaptor plug into the AC Adaptor jack.

The ON/OFF indicator blinks six times, and the PW-10 switches to DRIVE SELECT mode.
- 5. Turn on the power to the guitar amp.**

6. With the TYPE knob, select the DRIVE type.

DRIVE Type List

TYPE knob	DRIVE Type	Description
CUSTOM (Factory Setting)	METAL ZONE	Models the sound of the BOSS "MT-2" METAL ZONE.
ADVANCED	MUFF FUZZ	Models the sound of the Electro-Harmonix Big Muff π .
BASS MIX	VINTAGE OD	Models the sound of the BOSS "OD-1" OverDrive.
CBY-WAH	GUV DIST	Models the sound of the Marshall GUV'NOR.
VO-WAH	DISTORTION	Models the sound of the BOSS "OD-1" Distortion.
MO-WAH	TURBO OD	Models the sound of the BOSS "OD-2" OverDrive.
VOICE	BLUES OD	Models the sound of the BOSS "BD-2" Blues Driver.
UNI-V	BOOSTER	Booster with flat response.

* All product names mentioned in this document are trademarks or registered trademarks of their respective owners. Those companies are not affiliated with BOSS and have not licenced or authorized BOSS's PW-10. Their marks are used solely to identify the equipment whose sound is simulated by BOSS's PW-10.

7. With the WAH RANGE knob, set the Noise Suppressor threshold level.

You can eliminate louder noises the more the knob is turned to the right.

The Noise Suppressor is turned off when the knob is turned completely to the left.

8. When you have set the threshold, press the MANUAL/MEMORY button.

The MEMORY indicator blinks.

9. When you want to change the output level for DRIVE, use the DRIVE knob to adjust the volume level.

** You cannot adjust this output level if DRIVE is off when Step 8 is carried out.*

10. When you have finished making the settings, press the MANUAL/MEMORY button.

After the MEMORY indicator blinks and the settings are saved, the PW-10 returns to normal operation (“MANUAL” mode).

** You cannot switch between MEMORY and MANUAL while in DRIVE Mode.*

Returning Settings to Their Factory Defaults (Factory Reset)

You can restore the following settings to their factory-set values.

Memory Settings	Memory 1: red (p. 37)	Combination of wah and distortion
	Memory 2: green (p. 37)	Combination of UNI-V and distortion
	Memory 3: yellow (p. 37)	Analog synth-like sound
CUSTOM Wah Type (p. 23)		DOUBLE RESONANCE
CUSTOM DRIVE Type (p. 27)		METAL ZONE
Operation the Heel Switch (p. 20)		MEMORY → MEMORY 1 → MEMORY 2 → MEMORY 3 → MANUAL



Carrying out the following procedure completely clears the content currently stored in the memories (1-3).

* *The pedal sensitivity cannot be changed.*

Returning Settings to Their Factory Defaults (Factory Reset)

- 1. Turn off the power to the guitar amp.**
- 2. Switch off the PW-10's power.**
 - When running on battery power: Disconnect the connection plug from the INPUT jack.
 - When running on power from an AC adaptor: Disconnect the plug from the AC Adaptor jack.
- 3. Turn the TYPE knob to VO-WAH.**
- 4. While holding down the MANUAL/MEMORY button, switch on the PW-10's power.**
 - When running on battery power: Insert the connection plug into the INPUT jack.
 - When running on power from an AC adaptor: Insert the AC adaptor plug into the AC Adaptor jack.

The ON/OFF indicator blinks three times, and the MEMORY indicator blinks.
- 5. Turn on the power to the guitar amp.**
- 6. Press the MANUAL/MEMORY button.** Factory Reset is carried out, then the unit returns to normal operation ("MANUAL" mode).

Resetting the Pedal Sensitivity (PEDAL CALIBRATION Mode)



The PW-10's pedal sensitivity has been adjusted at the factory, so this procedure is not usually necessary. However, if the wah effect is not being applied when you press the pedal, if the effect sounds strange, or if the pedal exhibits other such problems, use the following procedure to make the settings.

- 1. Turn off the power to the guitar amp.**
- 2. Switch off the PW-10's power.**
 - When running on battery power: Disconnect the connection plug from the INPUT jack.
 - When running on power from an AC adaptor: Disconnect the plug from the AC Adaptor jack.
- 3. Turn the TYPE knob to CBY-WAH.**
- 4. While holding down the MANUAL/MEMORY button, switch on the PW-10's power.**
 - When running on battery power: Insert the connection plug into the INPUT jack.
 - When running on power from an AC adaptor: Insert the AC adaptor plug into the AC Adaptor jack.

The ON/OFF indicator flashes four times, and the PW-10 switches to PEDAL CALIBRATION mode.
- 5. Turn on the power to the guitar amp.**

- 6. With the toe of the pedal completely depressed, press and then release the MANUAL/MEMORY button.**

The MEMORY indicator lights up red when the pedal position is acknowledged.

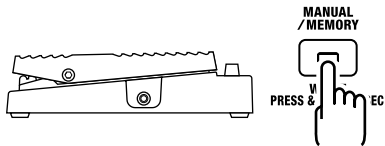

- 7. With the pedal all the way back, press and then release the MANUAL/MEMORY button.**

The MEMORY indicator lights up green when the pedal position is acknowledged.

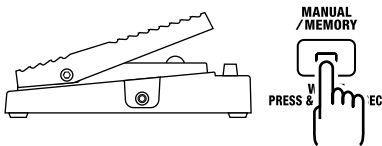

- * *If the pedal is not positioned correctly, the MEMORY indicator blinks red. Reposition the pedal correctly, then carry out the procedure again.*
- * *If the MEMORY indicator blinks even when the pedal position is correct, it may indicate a problem with the device.*

- * *If the pedal is not positioned correctly, the MEMORY indicator blinks green. Reposition the pedal correctly, then carry out the procedure again from Step 4.*
- * *If the MEMORY indicator blinks even when the pedal position is correct, it may indicate a problem with the device.*

8. Press the pedal forward and then press the toe switch.

When pressing of the switch is acknowledged, the MEMORY indicator lights up yellow.

9. Tilt the pedal back again and press down with your heel to press the heel switch.

When pressing of the switch is acknowledged, the MEMORY indicator blinks red, then the PW-10 returns to normal operation (“MANUAL” mode).

Setting Mode chart

The following table shows the correspondence between the TYPE knob and the mode that is set when the power is switched on while the MANUAL/MEMORY button is held down.

TYPE knob	Mode set
CUSTOM	Customize mode (p. 22)
ADVANCED	DRIVE SELECT mode (p. 26)
BASS MIX	Rear switch function setting (p. 20)
CBY-WAH	PEDAL CALIBRATION mode (p. 31)
VO-WAH	Factory Reset (p. 29)
MO-WAH	---
VOICE	---
UNI-V	---

Troubleshooting

The power doesn't come on:

- **Is the guitar connected correctly to the INPUT jack?**
 - Check the connections again.
 - * *When running off batteries, the unit won't switch on unless there's something plugged into the INPUT jack. This helps conserve the batteries.*
- **Have the batteries run down?**
 - Replace with fresh batteries (p. 4).
- **Is the specified AC adaptor (PSA-series sold separately) connected correctly?**
 - Check the connections again (p. 10–11).

There is no sound/volume is too low:

- **Is the other equipment connected correctly?**
 - Check the connections again (p. 10–11).
- **Is the volume turned down on the connected guitar amp, effects processor, or other device?**
 - Check the settings on the connected equipment (p. 10–11).

Sound is distorted:

- **Is the battery low?**
 - the battery is drained, the CHECK indicator dims, and the BF-3 may start to function incorrectly. Replace with a new battery (p. 4).
- **Could the level of the sound being input be excessive?**
 - With some guitars, distortion may be produced. Be careful of your guitar's output level.

Noise is produced:

- **Is the guitar connected correctly to the INPUT jack?**
- When using an AC adaptor, the power is turned on even if no plug is inserted in the INPUT jack. Therefore, noise is produced if nothing is connected to the INPUT jack. First connect all of your gear correctly, then turn on the power to all of the devices.

Pedal not working normally:

- **Is there any debris or other foreign matter between the pedal and the PW-10?**
- Check the underside of the pedal. If there is nothing unusual there, reset the pedal sensitivity (p. 31).

The unit immediately switches out of bypass:

- **Are you moving the pedal or any knob after setting bypass?**
- Moving the pedal, knobs, or other controls switches the PW-10 out of bypass mode.

The volume level of the instrument connected to INPUT jack is too low:

- **Could you be using a connection cable that contains a resistor?**
- Use a connection cable that does not contain a resistor.

Sample Settings

Combination of wah and distortion
(Factory Default Memory 1: red)

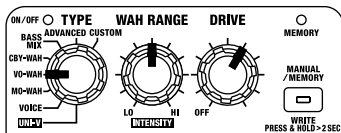

DRIVE Type (p. 26): GU DIST

Combination of UNI-V and distortion
(Factory Default Memory 2: green)

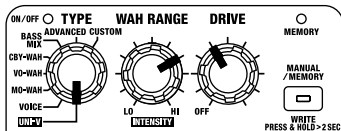

DRIVE Type (p. 26): BLUES OD

Analog synth-like sound
(Factory Default Memory 3: yellow)

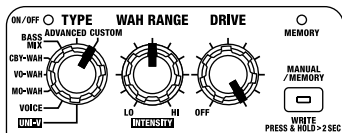

Customize Mode (p. 22):
DOUBLE RESONANCE
DRIVE Type (p. 26):
MUFF FUZZ

Vintage Wah

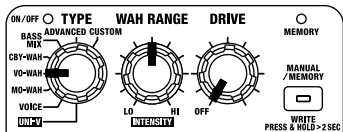

Sound with distortion added

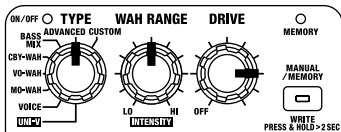

Wah with wider range

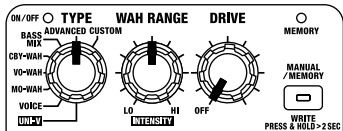

Rotary Sound

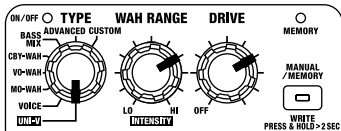

“Talking” modulation sound

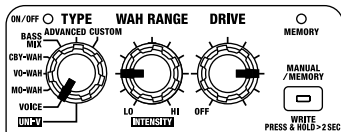

Oh Yeah!

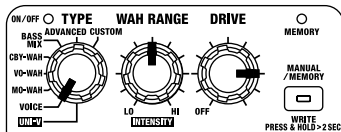

Bass Wah

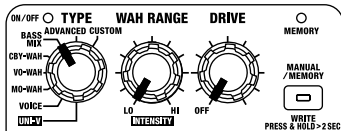

Synth bass sound

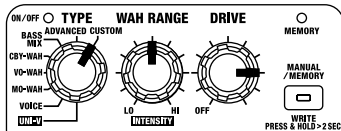

Customize Mode (p. 22):
DOUBLE RESONANCE

Specifications

PW-10: Pedal Wah

Nominal Input Level.....	-20 dBu
Input Impedance.....	1 M Ω
Nominal Output Level.....	-20 dBu
Output Impedance	1 k Ω
Recommended Load Impedance.....	10 k Ω or greater
Controls.....	Pedal Toe Switch Heel Switch MANUAL/MEMORY Button TYPE Knob WAH RANGE Knob DRIVE Knob
Indicators	ON/OFF Indicator MEMORY Indicator
Connectors.....	INPUT Jack OUTPUT Jack AC Adaptor Jack
Power Supply	DC 9V: Dry Battery (R6/LR6 (AA) type) x 6 AC Adaptor

Current Draw	55 mA
	* <i>Expected battery life under continuous use:</i>
	<i>Carbon: 14 hours</i>
	<i>Alkaline: 38 hours</i>
	<i>These figures will vary depending on the actual conditions of use.</i>
Dimensions	100 (W) x 270 (D) x 100 (H; max.) mm
	3-15/16 (W) x 10-11/16 (D) x 3-15/16 (H; max.) inches
Weight	1.3 kg/ 2 lbs 14 oz (including batteries)
Accessories.....	Owner's Manual
	Leaflet ("USING THE UNIT SAFELY," "IMPORTANT NOTES," and "Information")
	Dry battery (LR6 (AA) type) x 6
Options.....	AC Adaptor (PSA-series)

* $0 \text{ dBu} = 0.775 \text{ V}_{\text{rms}}$

* *In the interest of product improvement, the specifications and/or appearance of this unit are subject to change without prior notice.*

Setting Memo

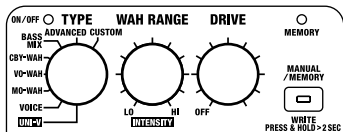
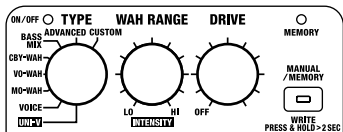
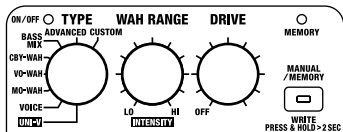
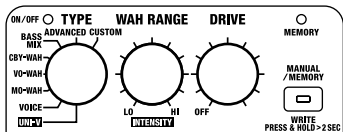



For EU Countries

This product complies with the requirements of European Directive 89/336/EEC.

For the USA

FEDERAL COMMUNICATIONS COMMISSION RADIO FREQUENCY INTERFERENCE STATEMENT

This equipment has been tested and found to comply with the limits for a Class B digital device, pursuant to Part 15 of the FCC Rules. These limits are designed to provide reasonable protection against harmful interference in a residential installation. This equipment generates, uses, and can radiate radio frequency energy and, if not installed and used in accordance with the instructions, may cause harmful interference to radio communications. However, there is no guarantee that interference will not occur in a particular installation. If this equipment does cause harmful interference to radio or television reception, which can be determined by turning the equipment off and on, the user is encouraged to try to correct the interference by one or more of the following measures:

- Reorient or relocate the receiving antenna.
- Increase the separation between the equipment and receiver.
- Connect the equipment into an outlet on a circuit different from that to which the receiver is connected.
- Consult the dealer or an experienced radio/TV technician for help.

This device complies with Part 15 of the FCC Rules. Operation is subject to the following two conditions:

- (1) This device may not cause harmful interference, and
- (2) This device must accept any interference received, including interference that may cause undesired operation.

Unauthorized changes or modification to this system can void the users authority to operate this equipment.
This equipment requires shielded interface cables in order to meet FCC class B Limit.

For Canada

NOTICE

This Class B digital apparatus meets all requirements of the Canadian Interference-Causing Equipment Regulations.

AVIS

Cet appareil numérique de la classe B respecte toutes les exigences du Règlement sur le matériel brouilleur du Canada.



BOSS Corporation

G6017356