

BOSS **PQ-4** Parametric Equalizer

INSTRUCTIONS

Thank you for purchasing the BOSS PQ-4 Parametric Equalizer. To make the best use of the PQ-4, please read the instructions carefully.

- The PQ-4 is a four-band equalizer that features Low, Middle, High and Presence bands.
- The Middle and High bands allow you to set the frequency and level for more spontaneous sound creation.
- Each band has a variable range of ± 18 dB for boosting and cutting resulting in more dynamic sound creation.
- The Level Control knob allows you to control the volume difference between the effect and straight sounds, and can also be used for adjusting the input level of different musical instruments such as a keyboard.

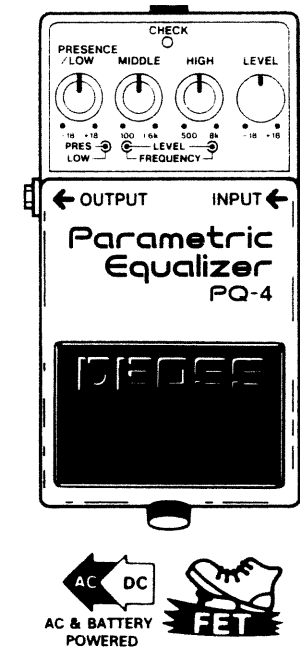

PANEL DESCRIPTION

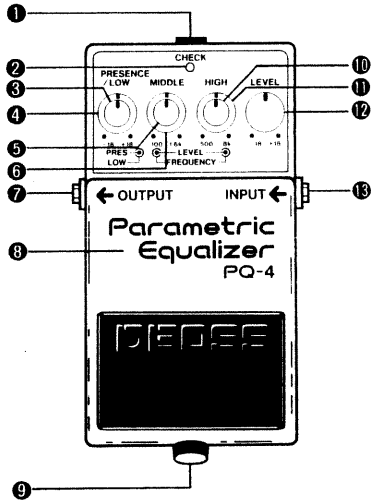

1 AC Adaptor Jack

Connect an AC adaptor (BOSS PSA-120, 220 or 240 depending on the line voltage in your country) to this jack.

* Be sure to use a BOSS AC adaptor PSA-120, 220 or 240. Use of any other type may cause damage or malfunction.

2 Check Indicator

This LED lights when the effect is turned on, and therefore can be used as an effect on/off indicator.

* The Check Indicator also serves as battery check. When the LED becomes dim or does not light at all, battery replacement is required.

3 Low Level Control Knob

This knob boosts or cuts the low frequencies (below 100 Hz).

Rotating the knob clockwise boosts the low frequencies, while rotating it counterclockwise cuts the low frequencies. The low frequencies have a variable range of ± 18 dB.

4 Presence Control Knob

This knob boosts or cuts the extremely high frequencies (above 8 kHz).

Rotating the knob clockwise boosts the extremely

high frequencies, while rotating it counterclockwise cuts the extremely high frequencies. The extremely high frequencies have a variable range of ± 18 dB.

5 Middle Level Control Knob

This knob boosts or cuts the frequencies (100Hz to 1.6kHz) you set with the Middle Frequency Control Knob 6. Rotating the knob clockwise boosts the middle frequencies, while rotating it counterclockwise cuts the middle frequencies. The middle frequencies have a variable range of ± 18 dB.

6 Middle Frequency Control Knob

This knob sets the frequency in the middle range (100Hz to 1.6kHz). Rotating the knob clockwise raises the center of the frequency band to a maximum of 1.6kHz. Rotating it counterclockwise lowers the center of the frequency band to a minimum of 100Hz.

* When the Middle Level Control Knob is set to the center position, the Middle Frequency Control Knob does not affect the sound.

7 Output Jack

Connect an amplifier or other effect unit to this jack.

8 Pedal Switch

Pressing the pedal turns the effect on and off.

9 Thumb Screw

Loosen the screw to open the cover for battery replacement. (For a detailed explanation of battery replacement, see "BATTERY REPLACEMENT")

* Do not remove the screw from the cover, or you may lose it.

10 High Level Control Knob

This knob boosts or cuts the frequencies (500Hz to 8kHz) you set with the High Frequency Control Knob 11. Rotating the knob clockwise boosts the high frequencies, while rotating it counterclockwise cuts the high frequencies.

The high frequencies have a variable range of ± 18 dB.

11 High Frequency Control Knob

This knob sets the frequency in the high range (500Hz to 8kHz). Rotating the knob clockwise raises the center of the frequency band to a maximum of 8kHz. Rotating it counterclockwise lowers the center of the frequency band to a minimum of 500Hz.

* When the High Level Control Knob is set to the center position, the High Frequency Control Knob does not affect the sound.

12 Level Control Knob

This knob adjusts the volume of the effect sound. Set this knob so that there will be no difference in volume between the effect and straight sounds. Rotating the knob clockwise increases the volume of the effect sound by up to +18dB.

Rotating it counterclockwise lowers the volume of the effect sound by up to -18dB.

* When it is set to the center position, the volume remains unchanged.

* This control knob is situated before the equalizer circuit and therefore can be used for adjusting the input level of the connected instrument.

13 Input Jack

Connect an electric or electronic musical instrument (such as an electric guitar) to this jack.

* Inserting a plug into this jack will automatically switch the unit on. Be sure to disconnect the plug from this jack when the unit is not being used.

CONNECTIONS

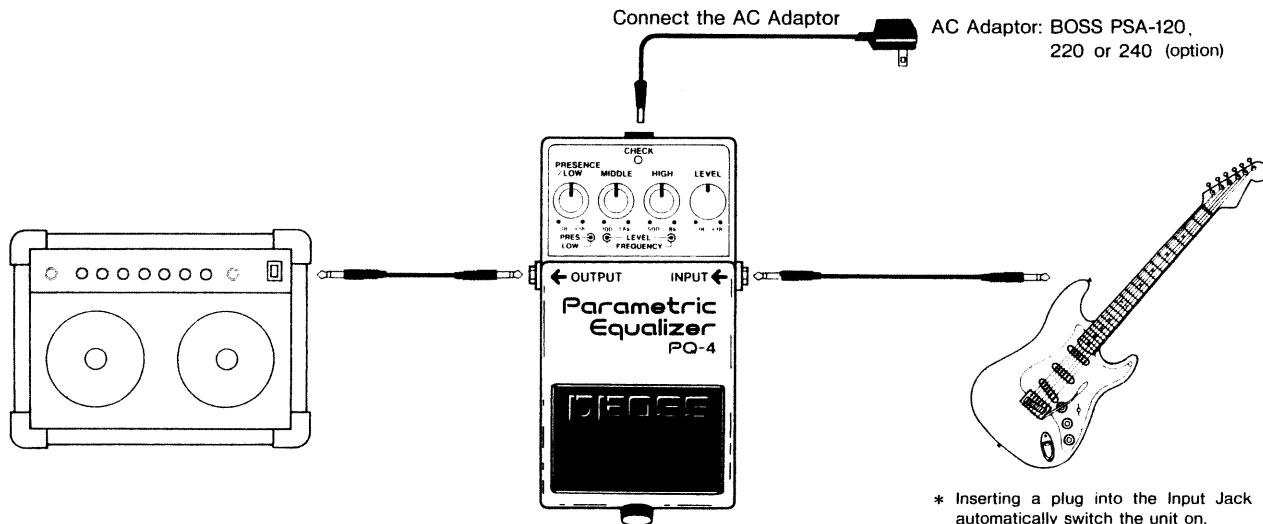

- * Inserting a plug into the Input Jack will automatically switch the unit on.
- * Before connecting or disconnecting a plug, make sure that the volume of the amplifier is turned down.

BLOCK DIAGRAM

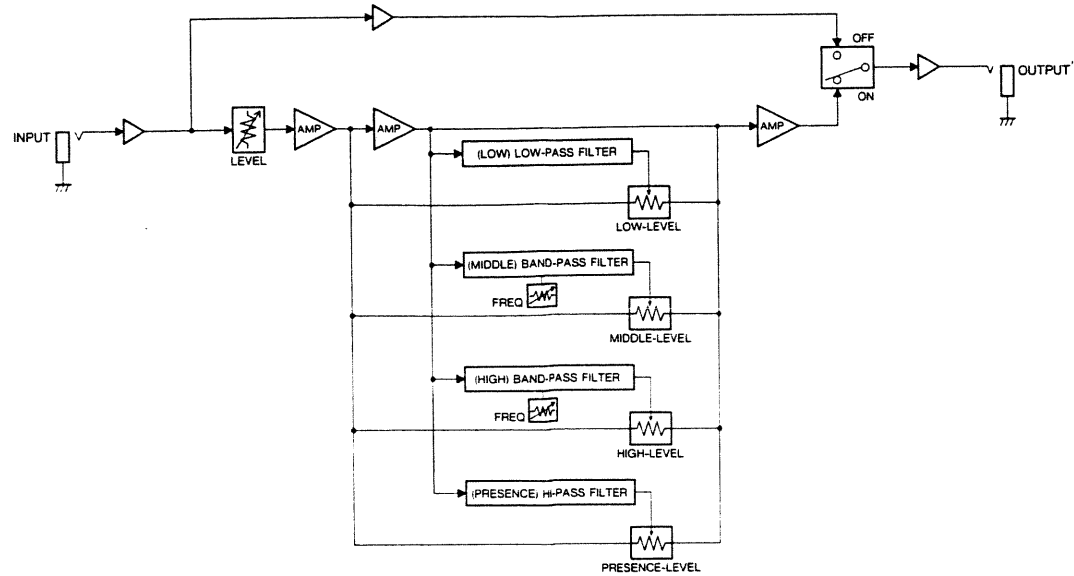

OPERATION

① Make all the necessary connections, then set the controls on the panel as shown below.

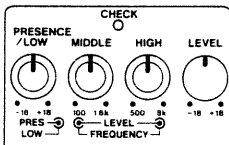

② Press the Pedal Switch ①. Make sure the Check Indicator lights.

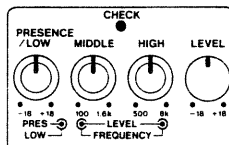

③ Boost or cut the lower frequencies using the Low Level Control Knob ②.

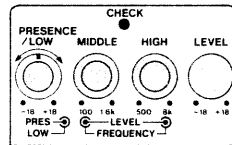

④ Boost or cut the extremely high frequencies using the Presence Control Knob ③.

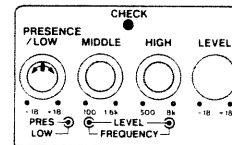

⑤ Set the center of middle frequency with the Middle Frequency Control Knob ④ (100Hz to 1.6kHz). Adjust the level using the Middle Level Control Knob ⑤.

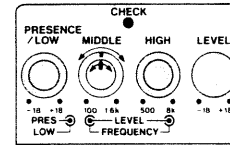

⑥ Set the high frequency center with the High Frequency Control Knob ⑥ (500Hz to 8kHz). Adjust the level using the High Level Control Knob ⑥.

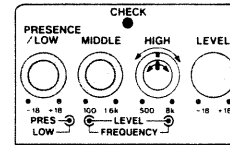

⑦ Using the Level Control Knob ⑦, adjust the volume of the effect sound so that there will be no difference in volume between the effect and straight sounds. The Level Control Knob ⑦ can also be used for adjusting the volume when the output sound is distorted because it is excessively boosted.

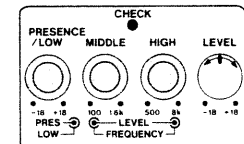

FREQUENCY CHARACTERISTICS OF EACH BAND

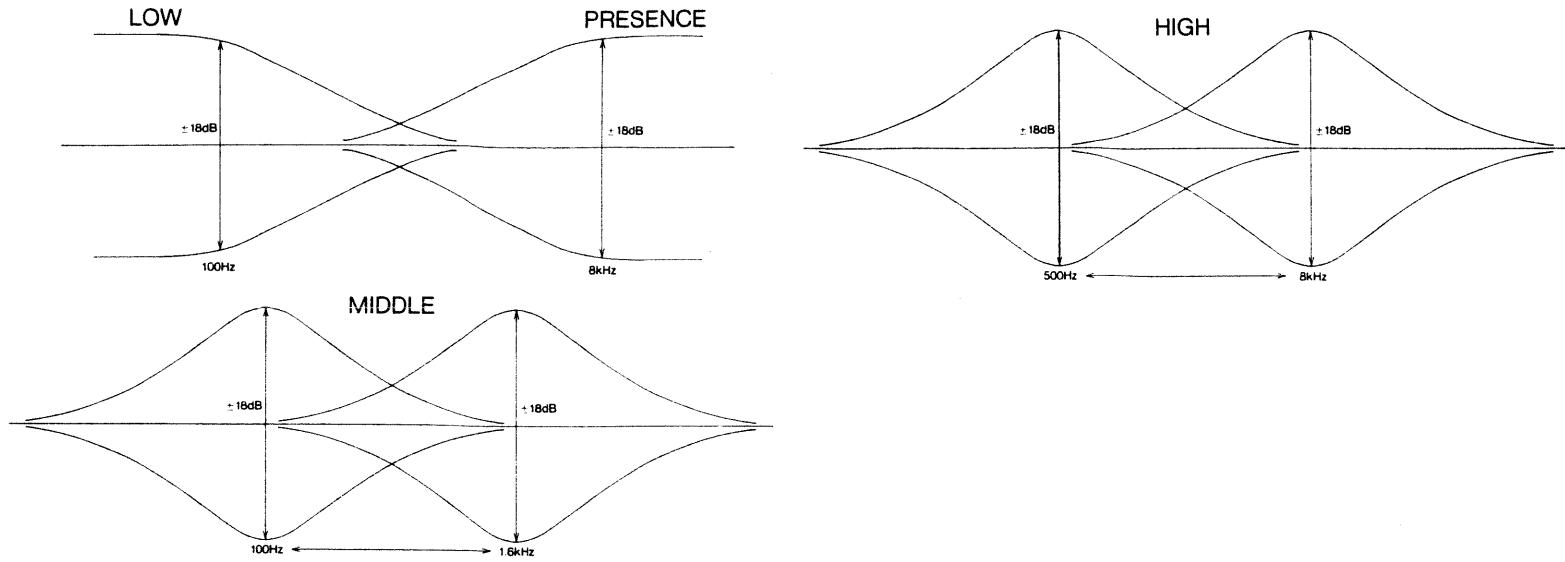

SETTING MEMO

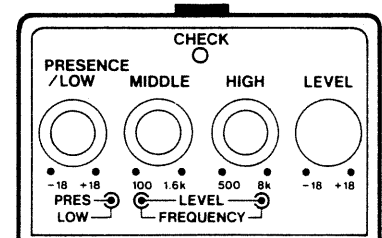
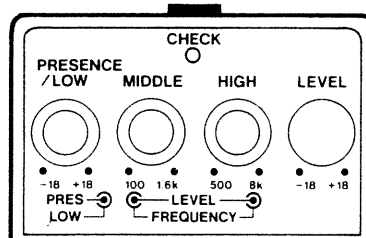
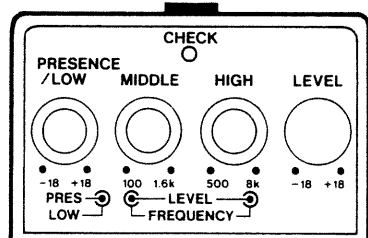
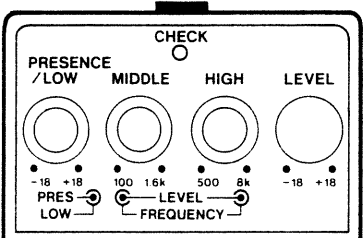
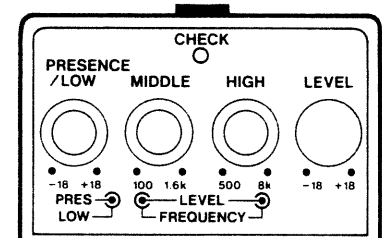
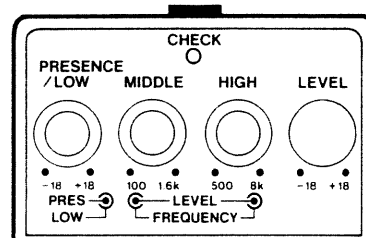
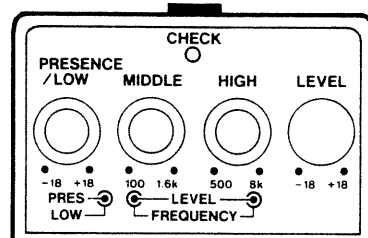
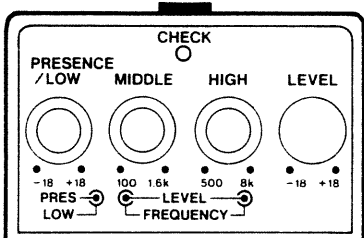

■ BATTERY REPLACEMENT

- ① Loosen the thumb screw on the pedal to open it.
- ② Take out the battery from the battery housing and disconnect the battery snap.
- ③ Connect a new battery to the battery snap, then replace the battery in to the battery housing.
* Make sure that the polarity of the battery is correct.
- ④ Push the coil spring into the spring base on the rear of the pedal, then close the pedal.
* Make sure that the snap cord is not caught in the pedal or coil spring.
- ⑤ Insert the thumb screw into the guide bush hole and firmly tighten the screw.

Use one 9-volt battery

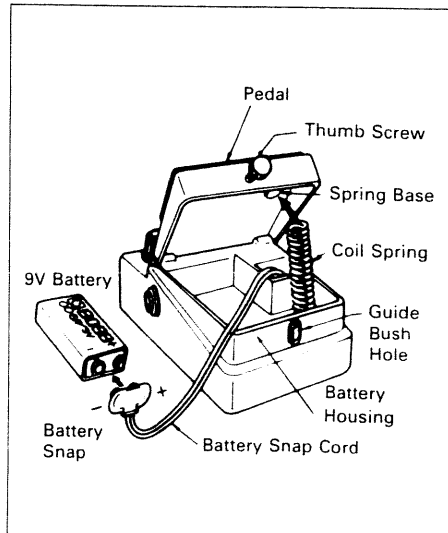

■ IMPORTANT NOTES

- Do not subject the unit to temperature extremes (eg. direct sunlight in an enclosed vehicle). Avoid using or storing the unit in dusty or humid areas or areas that are subject to high vibration levels.
- Remove the battery whenever the unit is not going to be used for an extended period of time.
- When operating solely on a battery, the unit's indicator becomes dim when the battery is depleted. Replace the battery immediately.
- If there is a battery in the unit while an AC adaptor is being used, normal operation will continue should the line voltage be interrupted (power black-out) or the power cord become disconnected.
- Should a malfunction occur (or if you suspect there is a problem) discontinue use immediately. Contact

qualified service personnel as soon as possible.

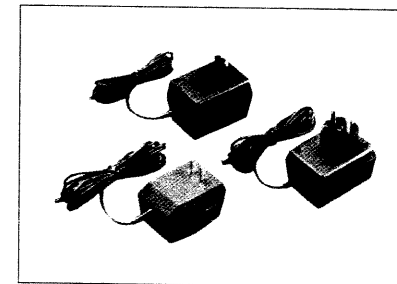

● OUT: 9VDC/200mA

■ SPECIFICATIONS

Controls : Pedal Switch, Low, Presence, Middle Level, Middle Frequency, High Level, High Frequency, Level
Indicator : Check Indicator (serves also as battery check indicator)
Jacks : Input Jack, Output Jack, AC Adaptor Jack
Input Impedance : 1M Ω
Output Impedance : 1k Ω
Recommended Load Impedance : 10k Ω or greater
Residual Noise : -98dBm or less (IHF-A) (all controls : center) 0dBm=0.775 V
Power Supply : DC9V: Dry Battery (9V type), AC Adaptor (PSA-120, 220 or 240:option)
Current Draw : 23mA (DC9V)
Dimensions : 70(W) \times 125(D) \times 55(H)mm / 2-3/4" \times 2-3/16" \times 4-15/16"
Weight : 410g / 15 oz
Accessories : Instructions, Dry Battery S-006P/9V (6F22/9V)
Options : AC Adaptor; PSA-120, PSA-220, PSA-240
Dry Battery; S-006P/9V (6F22/9V), 6AM6/9V (alkaline)

* The specifications for this product are subject to change without prior notice.

 **BOSS**
Products of Roland

Printed in Taiwan '91-1-D3-11C

 Roland®

26047487RT

UPC

26047487RT



:099:

 **BOSS**