

BOSS

ME-6B BASS MULTIPLE EFFECTS

Owner's Manual

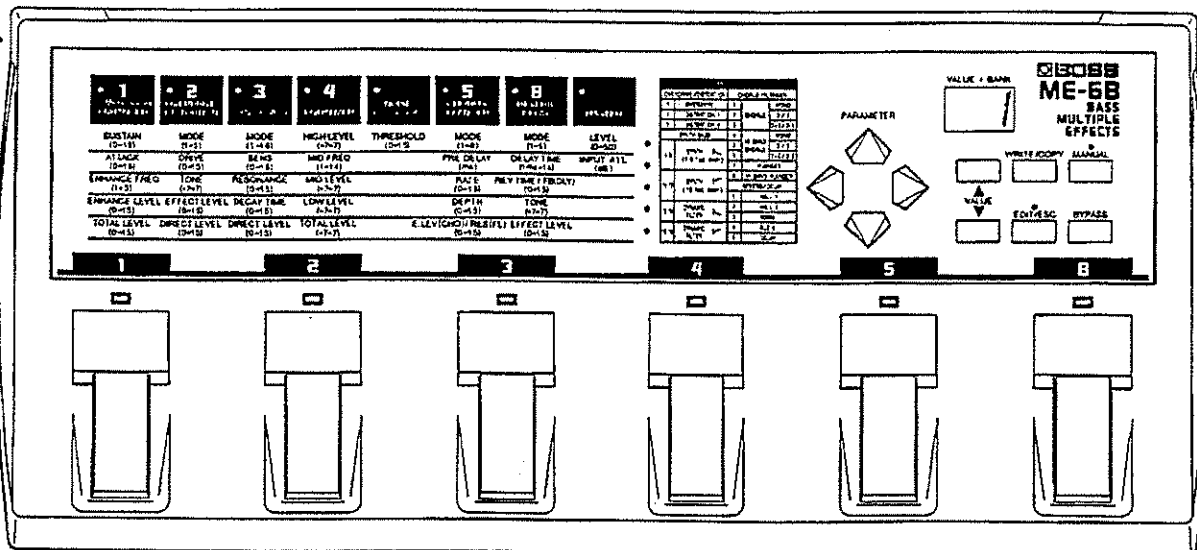

Before You Begin

We'd like to take a moment to thank you for purchasing the BOSS ME-6B Bass Multiple Effects processor. To become completely familiar with this processor, and to ensure many years of trouble-free service, we recommend that you take the time to read this Owner's Manual thoroughly.

CONTENTS

MAIN FEATURES	3	STORING THE EFFECTS SETTINGS IN MEMORY: THE WRITE OPERATION	
IMPORTANT NOTES	3	DUPLICATING EFFECTS SETTINGS WITH COPY	
PANEL DESCRIPTIONS	4	SECTION III: THE EFFECTS	
MAKING THE CONNECTION	5	COMPRESSOR/ENHANCER	
SECTION I: PLAYING THE ME-6B	6	OVERDRIVE/DISTORTION	
PLAYING THE ME-6B: PLAY MODE	6	SYNTH BASS	
SELECTING A PATCH	6	EQUALIZER	
PLAYING THE ME-6B LIKE A ROW OF PEDAL EFFECTS — THE MANUAL MODE	7	NOISE SUPPRESSOR	
SELECTING THE MANUAL MODE	7	CHORUS/FLANGER	
MANUAL MODE OPERATIONS	7	REVERB/DELAY	
DIRECT BASS SOUND: BYPASS	8	MASTER	
CONTROLLING VOLUME IN REAL TIME	8	SECTION IV: REFERENCE	
SECTION II: MODIFYING EFFECTS SETTINGS	9	BEFORE DECIDING THERE'S A PROBLEM	
YOU CAN CHANGE THINGS IN THE EDIT MODE	9	RETURNING TO THE FACTORY SETTINGS — INITIALIZATION	
CHANGING PATCH SETTINGS	9	FACTORY SETTINGS	
CANCELING EDITS	10	BLANK CHART	
		SPECIFICATIONS	

For Germany

Bescheinigung des Herstellers / Importeurs

Hiermit wird bescheinigt, daß der/die/das
BASS MULTIPLE EFFECTS ME-6B
(Gerät, Typ. Bezeichnung)

in Übereinstimmung mit den Bestimmungen der
Amtsbl. Vfg 1046 / 1984
(Amtsblattverfügung)

funk-entstört ist.
Der Deutschen Bundespost wurde das Inverkehrbringen dieses Gerätes angezeigt und die Berechtigung zur Überprüfung der Serie auf Einhaltung der Bestimmungen eingeräumt.

Roland Corporation Osaka / Japan
Name des Herstellers/Importeurs

For the USA

RADIO AND TELEVISION INTERFERENCE

WARNING— This equipment has been verified to comply with the limits for a Class B computing device, pursuant to Subpart J of Part 15, of FCC rules. Operation with non-certified or non-verified equipment is likely to result in interference to radio and TV reception.

The equipment described in this manual generates and uses radio frequency energy. If it is not installed and used properly, that is, in strict accordance with our instructions, it may cause interference with radio and television reception.

This equipment has been tested and found to comply with the limits for a Class B computing device in accordance with the specifications in Subpart J of Part 15, of FCC Rules. These rules are designed to provide reasonable protection against such interference in a residential installation. However, there is no guarantee that the interference will not occur in a particular installation.

If this equipment does cause interference to radio or television reception, which can be determined by turning the equipment on and off, the user is encouraged to try to correct the interference by the following measure:

- Disconnect other devices and their input/output cables one at a time. If the interference stops, it is caused by either the other device or its I/O cable. These devices usually require Roland designated shielded I/O cables. For Roland devices, you can obtain the proper shielded cable from your dealer. For non-Roland devices, contact the manufacturer or dealer for assistance.
- If your equipment does cause interference to radio or television reception, you can try to correct the interference by using one or more of the following measures:
 - Turn the TV or radio antenna until the interference stops.
 - Move the equipment to one side or the other of the TV or radio.
 - Move the equipment farther away from the TV or radio.
 - Plug the equipment into an outlet that is on a different circuit than the TV or radio. (That is, make certain the equipment and the radio or television set are on circuits controlled by different circuit breakers or fuses.)
 - Consider installing a rooftop televis antenna with coaxial cable lead-in between the antenna and TV. If necessary, you should consult your dealer or an experienced radio/television technician for additional suggestions. You may find helpful the following booklet prepared by the Federal Communications Commission: "How to Identify and Resolve Radio - TV Interference Problems"

This booklet is available from the U.S. Government Printing Office, Washington, D.C., 20402, Stock No. D04-000-00345 4

For Canada

CLASS B	NOTICE
This digital apparatus does not exceed the Class B limits for radio noise emissions set out in the Radio Interference Regulations of the Canadian Department of Communications.	
CLASSE	BAVIS
Cet appareil numérique ne dépasse pas les limites de la classe B au niveau des émissions de bruits radioélectriques fixés dans le Règlement des signaux parasites par le ministère canadien des Communications.	

Copyright © 1992 by BOSS CORPORATION
All rights reserved. No part of this publication may be reproduced in any form
without the written permission of BOSS CORPORATION.

MAIN FEATURES

On-board Effects

The ME-6B contains 11 different effects specially selected for bass players.

On-board Synth Bass

The ME-6B's bass synthesizer detects the pitch and envelope of the notes you play and uses them to trigger its own internal sounds. You can create a wide variety of bass sounds by selecting different filters.

Simple Editing Operations

The effects parameters are laid out for you on the top panel. This makes it easier for you to edit and create your own sounds.

Store Up to 25 Effects Settings in Memory

You can store up to 25 different effects settings in the ME-6B's internal memory. These settings can then be recalled instantly using the footswitch pedals.

Manual Mode for a "Pedal Effect" Feel

The ME-6B has a Manual Mode which lets you use the pedals to switch effects on and off during performance; you can even change effects settings this way. This allows the same amount of freedom you would have if you were using a row of pedal effects.

Long Delay and Reverb with no Cut-off

Delay and reverb will decay naturally instead of being abruptly cut off when you switch from one patch to another.

Tuner Out Jack

A special jack for use with tuners so you can tune your guitar without re-patching your setup.

Headphone Jack

You can plug in a set of headphones so you can hear yourself without going through an amp.

IMPORTANT NOTES

Be sure to use only the adaptor supplied with the unit. Use of any other power adaptor could result in damage, malfunction, or electric shock.

POWER SUPPLY

- When making any connections with other devices, always turn off the power to all equipment first; this will help prevent damage or malfunction.
- Do not use this unit on the same power circuit with any device that will generate line noise, such as a motor or variable lighting system.
- The power supply required for this unit is shown on its nameplate. Ensure that the line voltage of your installation meets this requirement.
- Avoid damaging the power cord; do not step on it, place heavy objects on it etc.
- When disconnecting the AC adaptor from the outlet, grasp the plug itself; never pull on the cord.
- If the unit is to remain unused for a long period of time, unplug the power cord.

PLACEMENT

- Do not subject the unit to temperature extremes (e.g. direct sunlight in an enclosed vehicle). Avoid using or storing the unit in dusty or humid areas or areas that are subject to high vibration levels.
- Using the unit near power amplifiers (or other equipment containing large transformers) may induce hum.
- This unit may interfere with radio and television reception. Do not use this unit in the vicinity of such receivers.
- Do not expose this unit to temperature extremes (e.g. direct sunlight in an enclosed vehicle can deform or discolor the unit) or install it near devices that radiate heat.

MAINTENANCE

- For everyday cleaning wipe the unit with a soft, dry cloth (or one that has been slightly dampened with water). To remove stubborn dirt, use a mild neutral detergent. Afterwards, be sure to wipe the unit thoroughly with a soft, dry cloth.
- Never use benzine, thinners, alcohol or solvents of any kind, to avoid the risk of discoloration and/or deformation.

ADDITIONAL PRECAUTIONS

- Protect the unit from strong impact.
- Do not allow objects or liquids of any kind to penetrate the unit. In the event of such an occurrence, discontinue use immediately. Contact qualified service personnel as soon as possible.
- Before using the unit in a foreign country, consult with qualified service personnel.
- Should a malfunction occur (or if you suspect there is a problem) discontinue use immediately. Contact qualified service personnel as soon as possible.
- To prevent the risk of electric shock, do not open the unit or its AC adaptor.

PANEL DESCRIPTIONS

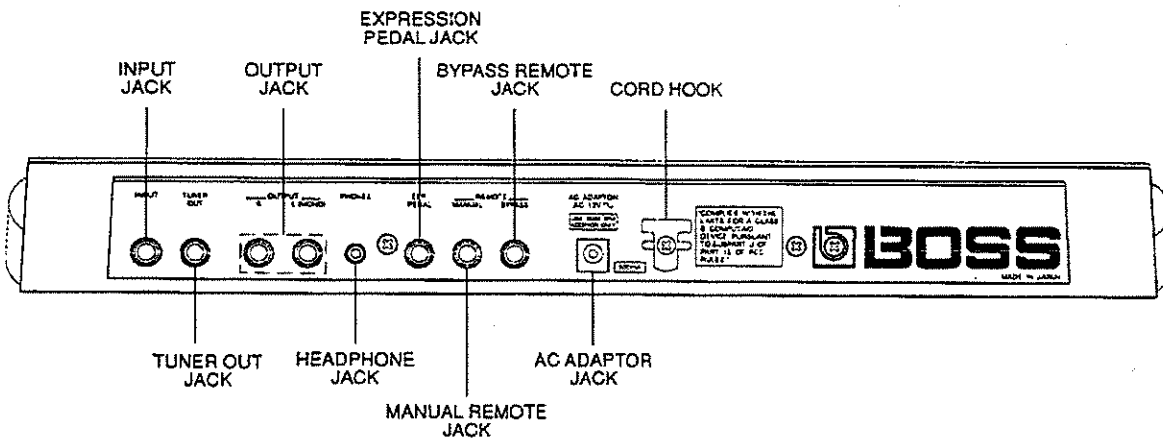
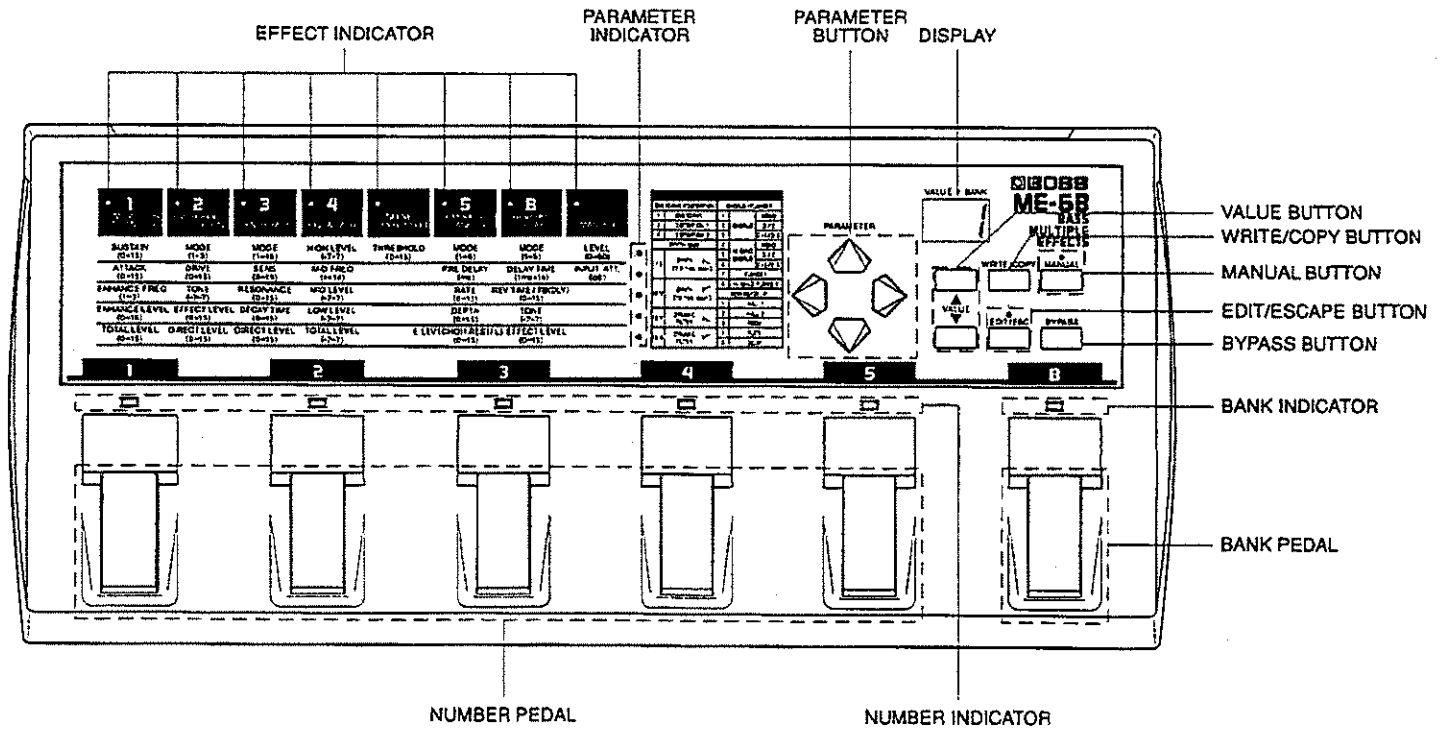

MAKING THE CONNECTION

The diagram below shows you how to connect the included ME-6B AC adaptor, a bass guitar and bass guitar amp. As soon as the AC adaptor is plugged in and you turn the power on, the ME-6B is in the "Play Mode," ready to go.

**When making any connections, be sure all devices are turned off and the volume on your amp is at zero. If you try to connect everything with the power on, you may get voltage spike 'pops' that can damage speakers or cause trouble down the line.*

**After you've turned everything on, you can turn up the amp.*

**If you require a mono output, use the OUTPUT L (MONO) jack.*

**After turning on the ME-6B, give it a minute to let the voltage stabilize.*

**If you have an Expression Pedal (optional) plugged into the EXP. PEDAL jack, turn the volume on it to MIN. For more information, refer to page 8.*

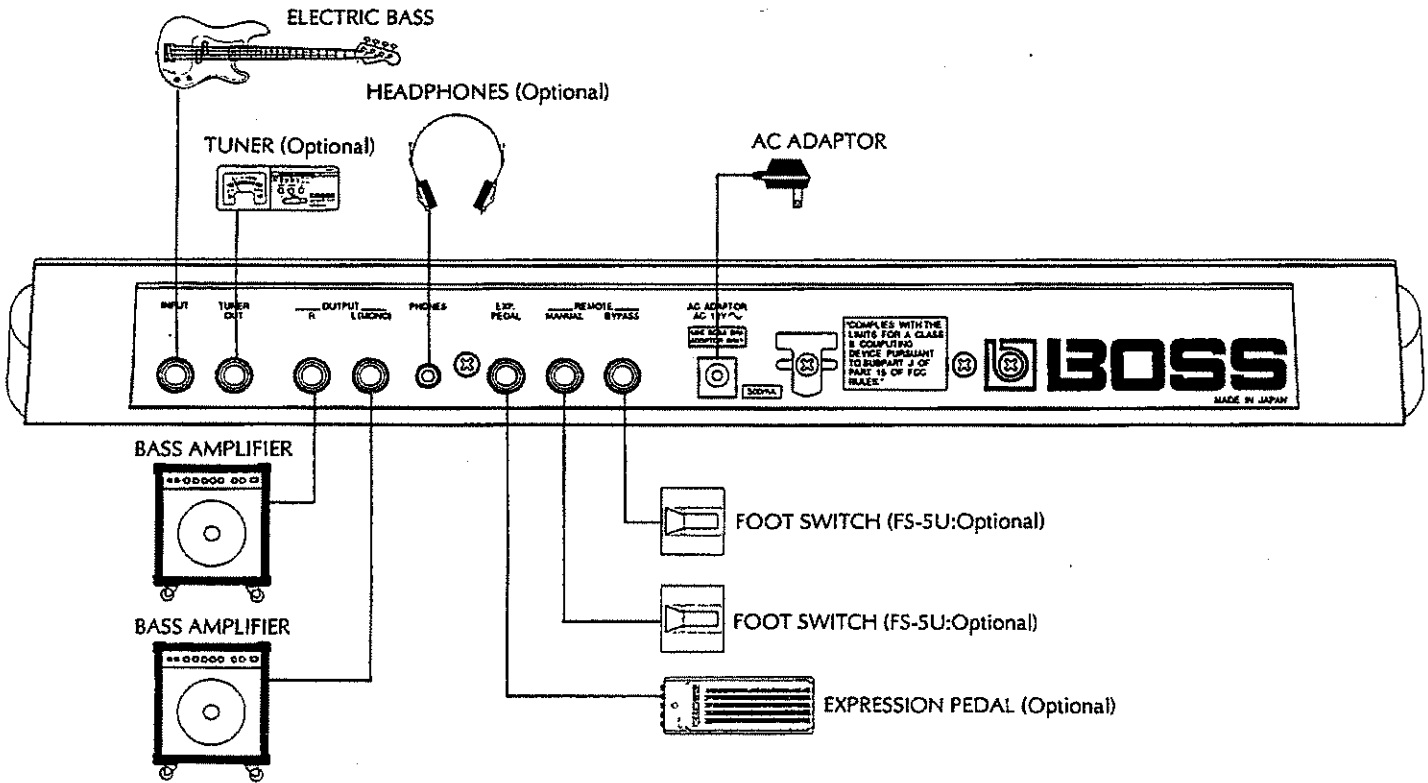

**Loop the AC adaptor cord around the cord hook. This will help prevent the cord from being accidentally disconnected.*

**Set the polarity switch as shown below for each remote footswitch (FS-5U; optional) that you connect.*

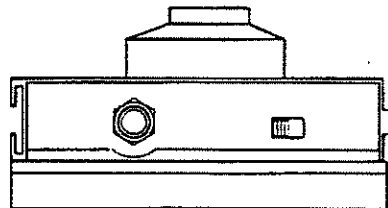
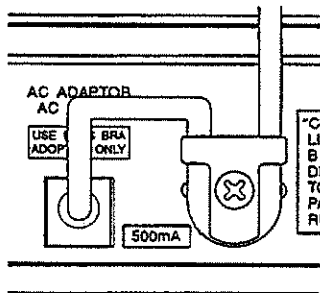

SECTION I: PLAYING THE ME-6B

PLAYING THE ME-6B: PLAY MODE

<What's a Patch?>

The ME-6B can store 25 different combinations of effects, settings and parameters in memory. Each collection of settings is called a "patch". These 25 patches are split up into five memory "banks", each containing five patches.

Each patch in the ME-6B is identified by a combination of a bank number and a patch number within that bank. You'll use this system to 'call up' the patches you need during play.

		BANK				
		1	2	3	4	5
NUMBER	1	1	6	11	16	21
	2	2	7	12	17	22
	3	3	8	13	18	23
	4	4	9	14	19	24
	5	5	10	15	20	25

***When you first turn the power on, BANK: 1 NUMBER: 1 is automatically selected.**

SELECTING A PATCH

1. Select the Bank

1 Depress the Bank Pedal.

The bank number will flash in the display.

2 Depress a Number pedal.

You switch to the desired bank number by depressing the corresponding Number Pedal (1 through 5).

Depressing a Number Pedal at this point only changes the bank number, it does not select a new patch. The patch is not actually selected until you choose a number within that bank.

***Depress the Bank [B] Pedal again if you wish to return to the original patch without changing banks.**

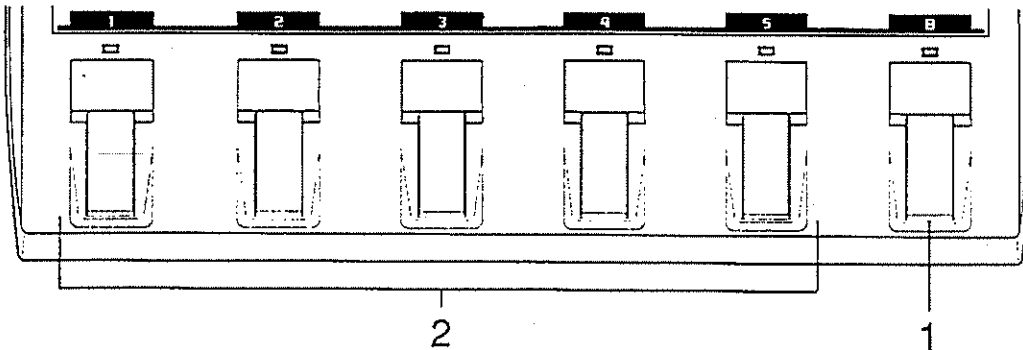

2. Select the Number

Depress the desired Number Pedal (1 through 5), and the display will change to that number. The patch identified by that bank/number combination is now selected.

***If you wish to select a different patch within the same bank, you don't have to reselect the bank; just depress the appropriate Number Pedal.**

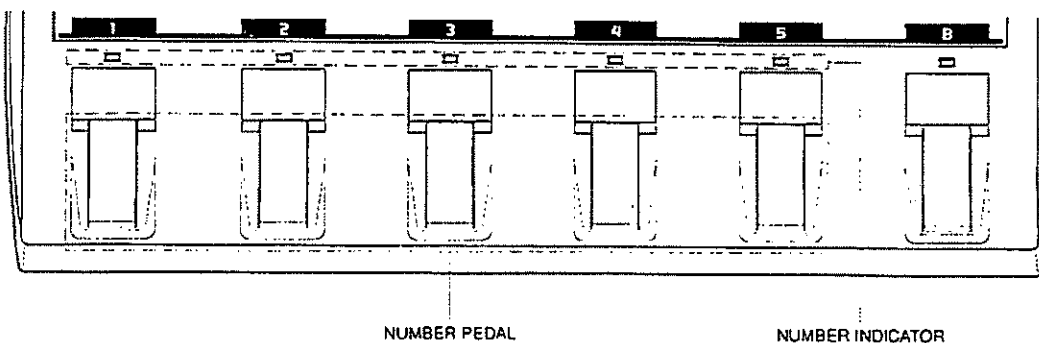

PLAYING THE ME-6B LIKE A ROW OF PEDAL EFFECTS — THE MANUAL MODE

A "Manual Mode" setting is also stored with each of the patches in the ME-6B's memory. The "Manual Mode" is where you can turn effects on and off by depressing the Number Pedals or the Bank Pedal. This makes the ME-6B feel just like a series of "pedal effect" effects.

The Manual Mode effects setting will be just the way you it them when you return to it again.

SELECTING THE MANUAL MODE

<Using the Panel Buttons>

Press the [MANUAL] button to switch between Manual Mode ON/OFF. The MANUAL Indicator will be on while you are in the Manual Mode.

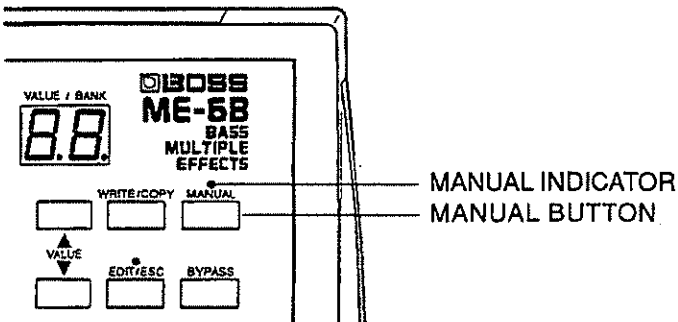

<Using the Footswitch>

When you have a footswitch (FS-5U; optional) connected to the MANUAL REMOTE jack, you can also use it to turn the Manual Mode ON/OFF. It works in the same way as using the panel buttons.

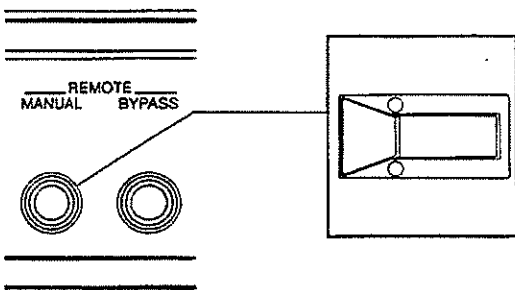

MANUAL MODE OPERATIONS

<<Switching Effects ON/OFF>>

In the Manual Mode, you can switch effects on or off using the Number/Bank Pedals. When the indicator over a pedal is lit, that effect is on. The effects are assigned to the pedals as follows:

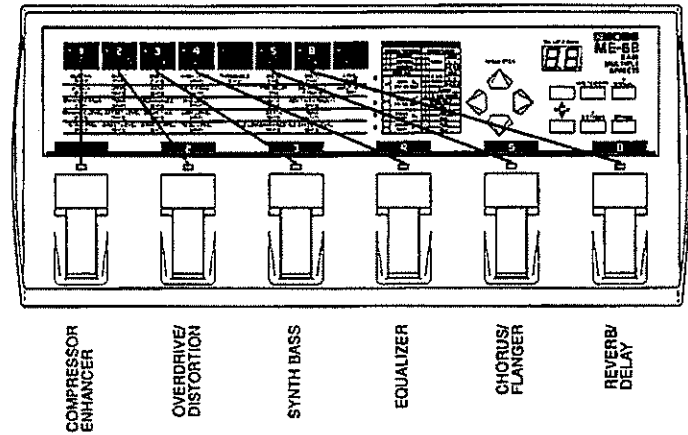

**The Noise Suppressor is on all the time, and can't be turned on and off like the others.*

<<Setting and Changing Parameters>>

You can set or edit parameters for any effect in real-time. Here's how:

1 Select the parameter to be edited.

Select the effect to be edited with the PARAMETER [◀][▶] buttons, and the parameter to be edited with the PARAMETER [△][▽] buttons. The exact parameter you will be editing is beneath the flashing Effect indicator and across from the lit Parameter indicator. Its current setting will be shown in the display.

**If you select a parameter for an effect which is currently turned off, the value in the display will flash.*

2 Change the setting with the VALUE [▲][▼] buttons.

While holding the [▲] button, you can increase the scrolling speed by pressing the button for the opposite direction, [▼]. This procedure works for either button.

Repeat steps 1 and 2 to change other parameter settings.

DIRECT BASS SOUND: BYPASS

When Bypass is ON, you'll hear the direct sound (without effects) of the guitar connected to the ME-6B.

<Using the Panel Buttons>

Press the [BYPASS] button to switch between Bypass ON/OFF. When it's ON, the display will read "bP".

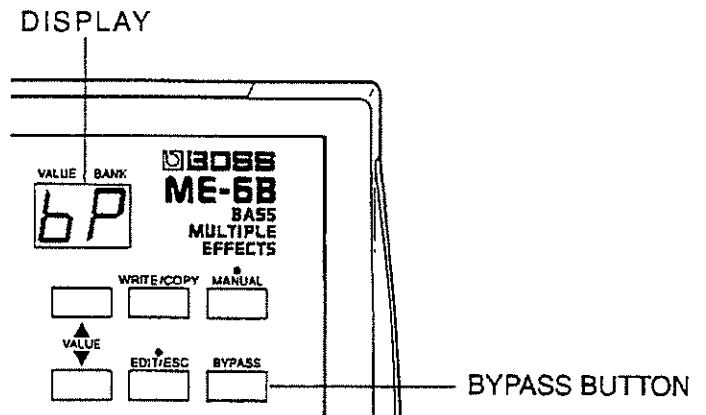

<Using the Footswitch>

When you have a footswitch (FS-5U; optional) connected to the BYPASS REMOTE jack, you can use it to switch between Bypass ON/OFF. It works in the same way as using the panel buttons.

**The Bypass setting cannot be stored in memory as part of a patch.*

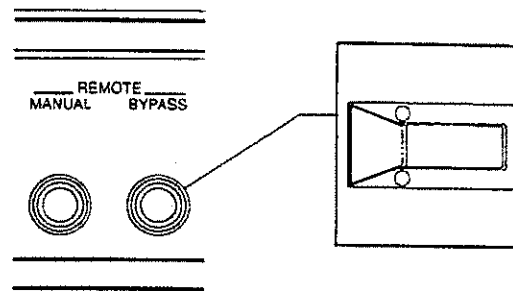

CONTROLLING VOLUME IN REAL TIME

An expression pedal (optional) connected to the EXP. PEDAL jack will let you control the volume output in real-time. In addition, if you cut the volume with expression pedal control, lingering effects like delay and reverb will decay naturally instead of being suddenly cut off.

**Be sure to use the minimum volume setting (MIN) on the expression pedal you have connected to the EXP. PEDAL jack.*

In fact, the expression pedal is inserted into the effects chain as shown in the diagram below.

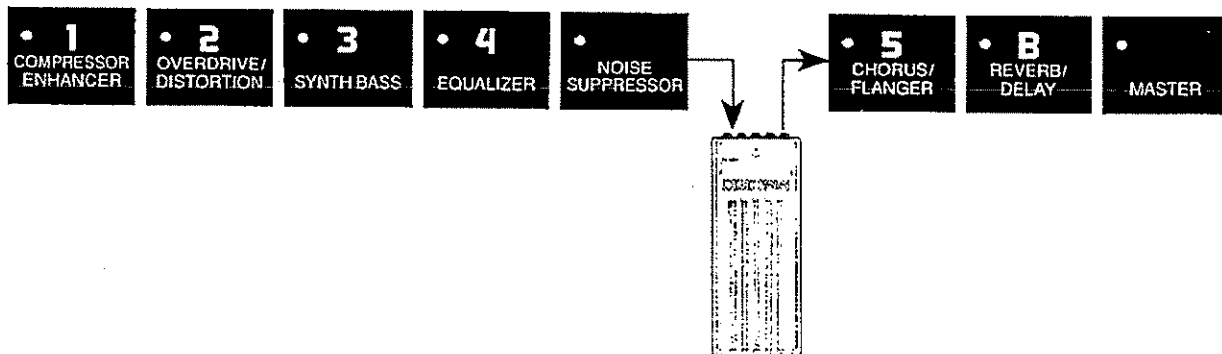

SECTION II: MODIFYING EFFECTS SETTINGS

YOU CAN CHANGE THINGS IN THE EDIT MODE

It's easy to change effects settings and save them as a patch. We'll show you how to do just that in this section.

CHANGING PATCH SETTINGS

Each of the 25 patches stored in the ME-6B has 'default' settings made at the factory. By changing these settings, you can make up your own original effects sounds. This is what we mean by "editing".

The following steps allow you to edit a patch.

1 From the Play Mode, call up the patch you wish to edit. (Refer to page 6 if you want a refresher on how to call up patches.)

2 Press the [EDIT/ESC] button.

This selects the Edit Mode (the EDIT/ESC indicator will light). The parameter settings you select will be shown in the display.

3 Turning effects ON/OFF.

Turn effects on or off by pressing the appropriate Bank/Number Pedals. You can check the indicator over each of the pedals to see if that effect is on or off. The effects are assigned to the pedals as follows:

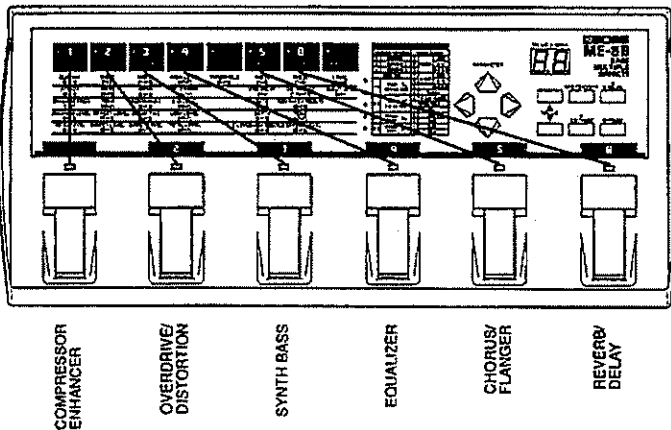

**The Noise Suppressor is on all the time, and can't be turned on and off like the others.*

4 Now select the parameter you want to edit.

Press the PARAMETER [◀][▶] buttons to select the effect to be edited, then the parameter you wish to edit with the PARAMETER [▲][▼] buttons. Cross-indexing the effect and parameter indicator lights will show you which parameter is selected, and the parameter setting will be shown in the display.

**If you select a parameter for an effect that is turned off, its setting will flash in the display.*

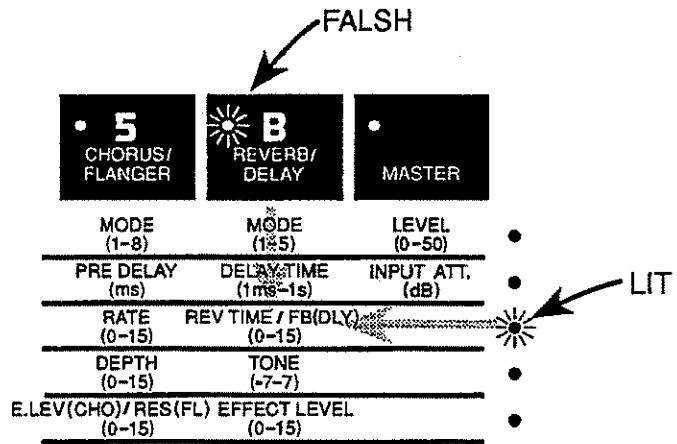

5 Change the parameter values.

Watch the display, and change the parameter values with the VALUE [▲][▼] buttons.

Repeat steps 3 through 5 until the settings are as you want them.

**At this point, if you turn off the ME-6B the patch will revert back to its pre-edit settings. If you want to actually store the patch settings after editing, you must perform the Write operation as described on page 10.*

CANCELING EDITS

After editing a patch, but before saving it with the Write operation, you can cancel the edits and return to the pre-edit settings. Here's how:

1 Press the [EDIT/ESC] button.

The EDIT/ESC indicator will flash rapidly.

**To continue editing the patch, press a PARAMETER or VALUE button.*

**Actually, if you press this button in the Edit Mode and you haven't turned any effects on or off and didn't change any settings, you will be returned immediately to the Play Mode.*

2 Press [EDIT/ESC] one more time.

The EDIT/ESC indicator will go out and you're back in the Play Mode. All the changes you have made to the patch during editing are lost, and you're back to the original settings again.

STORING THE EFFECTS SETTINGS IN MEMORY: THE WRITE OPERATION

Even after you've edited a patch, and played with it a while, the changes you have made will be lost if the power is turned off. To save the patch with edits intact, you must store it with the Write operation.

<<Storing a Patch in Memory>>

1 Press the [WRITE/COPY] button.

The EDIT/ESC indicator will flash (at a slow rate), and the display and pedal indicator lights will reflect the settings for the current patch.

2 Select a patch into which you'll store this data.

Check out "Selecting a Patch" on page 6 for more information on how patches are designated.

**If you are saving an edited patch back to its original patch number, well, you're already at that patch number so there is no need to reselect the patch. Skip step 2 and go to step 3.*

**If you save an edited patch to a different patch number, the patch you started from remains unchanged and in its original location.*

**To cancel a Write operation, press a Parameter or Value button. You'll be returned to the Edit Mode.*

3 Press the [WRITE/COPY] button again.

This stores the edited patch in memory. When the operation is complete, you'll be transferred to that new patch number and returned to the Play Mode.

<<Storing Manual Mode Settings>>

1 Press the [WRITE/COPY] button.

The EDIT/ESC indicator will flash slowly, and the display and number indicators will reflect the settings for the current patch.

2 Press the [MANUAL] button.

The MANUAL indicator will light to show that you're now storing Manual setting.

**Press the [MANUAL] button again (the MANUAL indicator will go out), and you're back to where you can store patch data.*

**To cancel a Write operation, press a PARAMETER or VALUE button. You'll be returned to the Edit Mode.*

3 Press the [WRITE/COPY] button again.

This stores the Manual settings for that patch along with the patch data. When the operation is over, the MANUAL indicator will come on to show that you're now in the Manual Mode.

DUPLICATING EFFECTS SETTINGS WITH COPY

Sometimes you may want the contents of one patch copied to another patch location. Not only can you copy from one patch to another, you can also copy between patches and Manual setting.

<<Copying From One Patch To Another>>

1 Select the patch to copy from.

Check out "Selecting A Patch" on page 6 for more information on how to do this.

2 Press the [WRITE/COPY] button.

The EDIT/ESC indicator will flash slowly, and the display and pedal indicators will show the current patch.

**To cancel the Copy and return to the Play Mode, press the [EDIT/ESC] button.*

3 Select the patch to copy to.

4 Press the [WRITE/COPY] button once more.

The contents of the "from" patch will be copied to the "to" patch. When the copying is complete, you'll be moved to the "to" patch and be in the Play Mode.

<<Copying the Contents of a Patch to Manual>>

1 Select the Patch to Copy From.

Check out "Selecting A Patch" on page 6 if you need more information on how to do this.

2 Press the [WRITE/COPY] button.

The EDIT indicator will flash slowly.

3 Press the [MANUAL] button.

The MANUAL indicator will come on, indicating the "copy to" is a Manual setting.

**Press the [MANUAL] button again (the MANUAL indicator will go out), and you can once again save to patches.*

**To cancel the Copy operation and return to the Play Mode, press the [EDIT/ESC] button.*

4 Press the [WRITE/COPY] button again.

The patch contents are now copied into the Manual setting. When the copy operation is complete, you'll be in the Manual Mode.

<<Copying the Manual Setting to a Patch>>

1 Press the [MANUAL] button to enter the Manual Mode (the MANUAL indicator will come on).

2 Press the [WRITE/COPY] button.

The EDIT/ESC indicator will flash slowly, and the display and indicator lights will show the current patch.

3 Select a patch to copy to.

See "Selecting a Patch" on page 6 for more information on this.

**To cancel this Copy operation and return to the Manual Mode, press the [EDIT/ESC] button.*

4 Press the [WRITE/COPY] button again.

The Manual setting is now copied to the selected patch. When the copy operation is complete, you'll be returned to that patch and be in the Play Mode.

SECTION III: THE EFFECTS

With the ME-6B you can create your own sounds by combining effects and changing their parameters. In this section we'll tell you about what each of the effects does, and what changes you can make with the parameters.

COMPRESSOR / ENHANCER

This effect "compresses" high input signals and "expands" low input signals (i.e. makes loud sounds a little softer and soft sounds a little louder). By making the overall volume more uniform, a distortion-free sustain effect is produced. In addition, the "Enhancer" processes the harmonic components of a sound and then mixes them with original sound before output. This fills out the sound and makes it clearer and more distinct.

**This effect will be disabled (even if it's on) if the Synth Bass is on.*

SUSTAIN (0 to 15)

Expands low input signals and adjusts the range (time) over which the volume is made more uniform. Larger values mean longer sustain. With smaller values of this parameter, this effect can be used as a "limiter" to suppress only the highest input signals.

ATTACK (0 to 15)

Adjusts the picking time and attack intensity. Larger values make the start of each note cleaner and improve articulation of the sound.

ENHANCE FREQUENCY (1 to 3)

The higher this number, the higher the frequency range over which the Enhancer effect is applied.

ENHANCE LEVEL (0 to 15)

Increasing this value increases the level of the enhanced signal in the mix.

TOTAL LEVEL (0 to 15)

Adjusts the volume of the Compressor/Enhancer. This is used for adjusting the balance between effects as they are turned on and off.

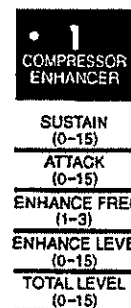

OVERDRIVE/DISTORTION

This effect distorts the sound and gives it a long sustain. The different "modes" are different kinds of distortion effects that you can tailor to match your needs.

MODE (1/2/3)

Selects the distortion type. Overdrive gives you a mild distortion that sounds like it came from a tube amp. The Distortions settings (1 and 2) give you a harder sound.

- Mode 1: Overdrive
- Mode 2: Distortion 1
- Mode 3: Distortion 2

DRIVE (0 to 15)

This parameter adjusts the sound of the distortion. The larger this number, the more intense the distortion effect.

TONE (-7 to +7)

Adjusts the timbre of the Overdrive/Distortion effect. Positive values boost the treble, making it brighter.

EFFECT LEVEL (0 to 15)

Adjusts the level of sound output by the Overdrive/Distortion.

DIRECT LEVEL (0 to 15)

Adjusts the volume of the Direct sound.

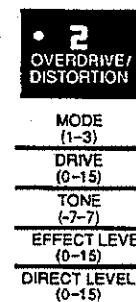

SYNTH BASS

The Bass Synth detects the pitch and envelope of the notes you play and uses them to trigger the ME-6B's own internal sounds. It is also equipped with dynamic filters that let you add 'auto-wah' effects to the sound.

• 3
SYNTH BASS
MODE (1-16)
SENS (0-15)
RESONANCE (0-15)
DECAY TIME (0-15)
DIRECT LEVEL (0-15)

MODE (1 to 16)

Selects the type of Synth Bass or dynamic filter effect.

<<Some Tips on Using the Synth Bass>>

Modes 1 to 12 are Synth Bass modes. There are a few things to keep in mind when using them:

**The Synth Bass gets 'confused' when it tries to play chords, so stick to single notes.*

**Play as cleanly as possible, muting the previous note before making a distinct, crisp attack on the next note.*

**When you get a note that jumps around and won't settle on the right pitch, that's a sign that the attack was not clean enough for the ME-6B to detect.*

MODES 1 to 6 [Synth Bass

In these Modes, the Synth Bass is filtered as shown in the figure. The different Modes correspond to different filter characteristics.

MODES 7 to 9 [Synth Bass

These modes use the same filter as Modes 1 to 6, but the Synth Bass functions one octave lower. The different Modes correspond to different filter characteristics.

MODES 10 & 11 [Synth Bass

In these Modes, the Synth Bass is filtered as shown in the figure. Modes 10 and 11 have different filter characteristics.

MODE 12 [Synth Bass

This mode uses the same filter as Modes 10 and 11, but the Synth Bass functions one octave lower.

MODES 13 & 14 [Dynamic Filter

Higher input levels increase the filter cutoff frequency in these Modes. Mode 14 is a really sharp filter with distortion applied.

MODES 15 & 16 [Dynamic Filter

Higher input levels decrease the filter cutoff frequency in these Modes. Mode 16 is a really sharp filter with distortion applied.

SENS (0 to 15)

Synth Bass

Adjusts the Synth Bass input sensitivity. A higher setting increases the responsiveness of the on-board tone generator. Too high a setting, however, will make the Synth Bass so sensitive that it triggers a note at even the slightest touch of a string. The ideal setting for SENS is just below this point.

Dynamic Filter

Adjusts the amount of effect applied in proportion to the input level. A higher setting means the effect will be applied when playing softly. A lower setting means you have to play a little harder to hear the effect.

RESONANCE (0 to 15)

Synth Bass

Adjusts the amount of boost to the harmonics provided by the filter. In general, higher values create a more 'synthetic' quality.

Dynamic Filter

Adjusts the peak level of the filter. Higher values increase the "Q" of the filter, creating a more 'synthetic' quality.

DECAY TIME (0 to 15)

Adjusts the time period over which the filter modulation is applied. Longer delay times mean the modulation is applied more smoothly.

**The Decay Time setting has no effect when dynamic filter Modes 13 to 16 are selected.*

DIRECT LEVEL (0 to 15)

Adjusts the volume of the output bass sound when Synth Bass is on.

EQUALIZER

A three-band equalizer with parametric control in the mid-range; the most important frequency range for a bass guitar.

• 4

EQUALIZER

HIGH LEVEL
(+7-7)

MID FREQ
(1-14)

MID LEVEL
(+7-7)

LOW LEVEL
(-7-7)

TOTAL LEVEL
(-7-7)

HIGH LEVEL (-7 to +7)

This parameter adjusts the treble. Positive values boost treble, negative values cut it.

MIDDLE FREQUENCY (1 to 10)

Sets the central frequency of the mid-range that will be adjusted by the Middle Level control. Larger values indicate higher frequencies.

MIDDLE LEVEL (-7 to +7)

This parameter adjusts the mid-range level. Positive values boost the level, negative values cut it.

LOW LEVEL (-7 to +7)

This parameter adjusts the bass. Positive values boost the bass, negative values cut it.

TOTAL LEVEL (-7 to +7)

This parameter adjusts the volume of the Equalizer. It is used for adjusting the balance between effects as they are turned on and off.

NOISE SUPPRESSOR

Suppresses induced hum and noise from the bass guitar pickup. By taking into account the bass guitar sound 'envelope' (variation of volume over time of the guitar sound), we're able to reduce the noise, without affecting the resonance of your bass guitar. This creates a more natural sound.

**The Noise Suppressor is always on.*

NOISE
SUPPRESSOR

THRESHOLD
(0-15)

THRESHOLD (0 to 15)

Adjustable for the noise level: high for high noise; low for low noise. Set this so that you can hear the bass guitar notes decay naturally.

**If the threshold is set too high, it may cut out soft bass guitar notes as well as noise! (This might be the problem if you are playing and nothing is heard.)*

CHORUS / FLANGER

Chorus makes the sound "thicker" and "fatter," while the Flanger adds an undulating effect to the timbre of the sound.

• 5
CHORUS/ FLANGER
MODE (1-8)
PRE DELAY (ms)
RATE (0-15)
DEPTH (0-15)
E.LEV(CHO)/RES(FL) (0-15)

MODE (1/2/3/4/5/6/7/8)

Selects the kind of effect (Chorus or Flanger) to be applied.

Modes 1, 2 & 3: Chorus

A standard Chorus effect.

Modes 4, 5 & 6: Hi Band Chorus

Chorus is applied only to the upper harmonics of the sound so that the bass end is not thinned out.

Mode 1/4: Chorus:Mono

The direct sound (pre-Chorus) and effect sound (after Chorus is applied) are combined and then output. The signal in the left and right channels is identical. This is the mode to use when you want to use a mono output.

Mode 2/5: Chorus:D/E

A stereo only mode. The direct and effect sounds are output separately (to the left and right channels, respectively). This gives you a really broad chorus sound by using air rather than electronics to mix the direct and effect sounds.

Mode 3/6: Chorus D+E/D-E

Another stereo only mode. The left and right channels are output out of phase with each other, creating a pseudo-stereo effect.

**You will not get a chorus effect if you use this mode in mono.*

Mode 7: Flanger

Applies the standard Flanger effect.

Mode 8: Hi Band Flanger

Applies the Flanger effect only to the upper frequencies so that the fundamental is not affected.

PRE DELAY

Adjusts the time between output of the direct sound and the effect sound. This has a different effect, depending on whether Chorus or Flanger is selected:

Chorus: (1 to 30 ms)

Increasing the pre-delay parameter creates a "doubling effect" (like several instruments playing in unison).

Flanger: (Flanger: 1.1 to 4.0 ms)

(Hi Band Flanger: 0.1 to 3.0 ms)

Adjusting the pre-delay parameter varies the central frequency of the flanging effect. The shorter this pre-delay time, the higher the central frequency, and vice-versa. Ordinarily this would be a "Manual" parameter.

RATE (0 to 15)

This parameter adjusts the rate of undulations in the Chorus or Flanger sound. Larger values create faster variations.

DEPTH (0 to 15)

This parameter adjusts the depth of the Chorus and Flanger modulations. Larger values create deeper modulations.

EFFECT LEVEL (Chorus) (0 to 15)

RESONANCE (Flanger) (0 to 15)

Chorus:

Adjusts the volume of the effect sound. Larger values increase the volume of the effect sound, and at "15" the direct and effect volumes are equal.

Flanger:

Adjusts the Flanger resonance volume (feedback volume). The larger the value, the more pronounced the effect.

REVERB/DELAY

This combines a reverb (simulating natural acoustic reverberations), with a delay (electronically delayed signals which create an echo-like effect).

B
REVERB/ DELAY
MODE (1-5)
DELAY TIME (1ms-1s)
REV TIME / FB(DLY) (0-15)
TONE (-7-7)
EFFECT LEVEL (0-15)

MODE (1/2/3/4/5)

Selects the kind of effect (Reverb or Delay).

1 (Hall-1):

Simulates the clear reverb sound of a concert hall.

2 (Hall-2):

Simulates the reverb of a concert hall; a gentle, well-controlled reverb sound.

3 (Room):

Simulates the bright reverb of a very "live" room.

4 (Plate):

Simulates a plate reverb (an analog device that uses a suspended metal plate).

The treble frequencies are boosted to create a metallic-sounding resonance.

5 (Delay):

Adds an electronically "delayed" signal to the original sound. This enhances and 'fattens' the sound. The delayed signal can be used for special effects as well.

DELAY TIME (1 ms to 1 s)

Adjusts the delay time (the amount of time between the signal and its first repeat).

Modes 1 to 4 are primarily Reverb, so any Delay Time settings you make will have no effect.

Delay times are shown in the display as follows:

1 ms to 99 ms: 1 to 99 (in units of msec)

100 ms to 990 ms: 10 to 99 (in units of 10 msec)

1.0s: 10 (in units of seconds)

REVERB TIME (Reverb)

FEEDBACK (Delay) (0 to 15)

Reverb:

Adjusts the reverberation time. Larger values correspond to longer reverberation times.

Delay:

Adjusts the feedback volume of the delayed sound, i.e., controls the number of audible "repeats" of the initial sound. Larger values mean more repeats, while a setting of "0" gives you a single repeat of the delayed sound.

TONE (-7 to +7)

Adjusts the timbre (quality) of the reverb or delay sound. Positive values boost the treble frequencies.

EFFECT LEVEL (0 to 15)

Adjusts the volume of the effect sound (reverb sound). A higher value increases the effect level.

MASTER

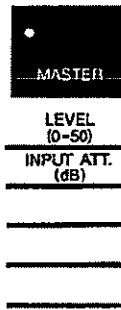

LEVEL (0 to 50)

Adjusts the overall output volume of the ME-6B.

**Set this to "43" if you want the input bass signal to be the same volume as the output when all effects are turned off.*

INPUT ATTENUATOR (0 / -6dB)

Some electric basses (especially those driven by two or more 9V batteries) put out a very "hot" signal that can overdrive the ME-6B and cause distortion.

Ordinarily you can leave the input attenuator set at "0," but if you have one of these high-output basses, set it to "-6" to trim the volume at the input.

SECTION IV: REFERENCE

BEFORE DECIDING THERE'S A PROBLEM...

If no sound is produced, or if things are not working as expected, check the following items. Do not attempt to service the product beyond that described in the user-maintenance instructions.

No Sound/Low Level Sound

- Are other devices hooked up correctly?
- Is the connected amp or mixer turned off, or maybe the volume is set too low?
- Are the patch settings set correctly? This includes things like checking to see that the parameter LEVEL settings are not set too low.
- Is the expression pedal volume all the way down?

Can't Select a Patch

- The patch won't change until you've depressed a Number Pedal.
- Is Bypass on?
- Are you in the Manual Mode?
- Are you in the Edit Mode?

RETURNING TO THE FACTORY SETTINGS — INITIALIZATION

You can return all the settings to the way they were at the factory (initialization). There is also a way to initialize just one patch, or all the patches.

<<Initialize Just One Patch>>

- 1 Turn the power off.
- 2 Press and hold the PARAMETER [Δ] and [\square] buttons and turn the power on again. The EDIT/ESC indicator will flash.
- 3 Select the patch you want to initialize. See page 6 for more information on selecting patches.
**To cancel the initialization at this time, press the [EDIT/ESC] button. You'll be moved to the Play Mode.*
- 4 Press the [WRITE] button. The selected patch will be initialized.
- 5 Press the [EDIT/ESC] button. You'll be moved to the Play Mode. If you want to continue initializing individual patch numbers, simply repeat steps 3 and 4.

<<Initialize All Patches>>

- 1 Turn the power off.
- 2 Press and hold the PARAMETER [\diamond] and [\square] buttons and turn the power on again. The EDIT/ESC indicator will flash and the display will read "L d".
**To cancel the initialization at this time, press the [EDIT/ESC] button. You will be returned to the Play Mode.*
- 3 Press the [WRITE] button. When the initialization is complete, you'll be moved to the Play Mode.

FACTORY SETTINGS

EFFECTOR	BANK NUMBER	1					2					3					4					5														
		1	2	3	4	5	1	2	3	4	5	1	2	3	4	5	1	2	3	4	5	1	2	3	4	5										
COMPRESSOR ENHANCER	SUSTAIN	0	15	2	13	15	9	6	1	12	14	8	6	2	14	14	3	1	3	2	3	9	11	15	1	12	13	9	11	15	3	1	15	12	14	13
	ENHANCE FREQ	2	13	15	3	9	1	12	14	3	9	2	14	3	15	15	1	3	15	15	15	1	12	13	2	15	15	3	1	15	0	7	7	7	7	7
	ENHANCE LEVEL	10	8	14	7	11	13	8	5	13	14	9	11	14	7	11	8	9	9	11	11	7	4	9	14	9	12	9	14	14	14	9	9	9	9	12
	TOTAL LEVEL	5	10	12	7	11	0	2	12	8	8	0	2	12	8	8	4	0	0	0	4	0	0	0	7	7	11	0	0	0	0	0	0	0	0	0
	MODE	5	9	8	0	11	-1	8	3	0	0	4	0	0	0	0	4	0	0	0	0	0	0	0	0	0	0	-2	9	3	4	-2	10	10	10	10
OVERDRIVE/DISTORTION	DRIVE	20	8	10	12	14	20	8	10	12	14	20	8	10	12	14	20	8	10	12	14	20	8	10	12	14	14	20	8	10	12	14	14	14	14	14
	TONE	5	10	12	7	11	5	10	12	7	11	5	10	12	7	11	5	10	12	7	11	5	10	12	7	11	11	5	10	12	7	11	11	11	11	11
	EFFECT LEVEL	5	10	12	7	11	5	10	12	7	11	5	10	12	7	11	5	10	12	7	11	5	10	12	7	11	11	5	10	12	7	11	11	11	11	11
	DIRECT LEVEL	5	10	12	7	11	5	10	12	7	11	5	10	12	7	11	5	10	12	7	11	5	10	12	7	11	11	5	10	12	7	11	11	11	11	11
	MODE	5	9	8	0	11	-1	8	3	0	0	4	0	0	0	0	4	0	0	0	0	0	0	0	0	0	0	-2	9	3	4	-2	10	10	10	10
SYNTH BASS	SENS	5	10	12	7	11	5	10	12	7	11	5	10	12	7	11	5	10	12	7	11	5	10	12	7	11	11	5	10	12	7	11	11	11	11	11
	RESONANCE	5	10	12	7	11	5	10	12	7	11	5	10	12	7	11	5	10	12	7	11	5	10	12	7	11	11	5	10	12	7	11	11	11	11	11
	DECAY TIME	5	10	12	7	11	5	10	12	7	11	5	10	12	7	11	5	10	12	7	11	5	10	12	7	11	11	5	10	12	7	11	11	11	11	11
	DIRECT LEVEL	5	10	12	7	11	5	10	12	7	11	5	10	12	7	11	5	10	12	7	11	5	10	12	7	11	11	5	10	12	7	11	11	11	11	11
	MODE	5	9	8	0	11	-1	8	3	0	0	4	0	0	0	0	4	0	0	0	0	0	0	0	0	0	0	-2	9	3	4	-2	10	10	10	10
EQUALIZER	HIGH LEVEL	5	10	12	7	11	5	10	12	7	11	5	10	12	7	11	5	10	12	7	11	5	10	12	7	11	11	5	10	12	7	11	11	11	11	11
	MIDDLE FREQ	5	10	12	7	11	5	10	12	7	11	5	10	12	7	11	5	10	12	7	11	5	10	12	7	11	11	5	10	12	7	11	11	11	11	11
	MIDDLE LEVEL	5	10	12	7	11	5	10	12	7	11	5	10	12	7	11	5	10	12	7	11	5	10	12	7	11	11	5	10	12	7	11	11	11	11	11
	LOW LEVEL	5	10	12	7	11	5	10	12	7	11	5	10	12	7	11	5	10	12	7	11	5	10	12	7	11	11	5	10	12	7	11	11	11	11	11
	TOTAL LEVEL	5	10	12	7	11	5	10	12	7	11	5	10	12	7	11	5	10	12	7	11	5	10	12	7	11	11	5	10	12	7	11	11	11	11	11
N.SUPPRESSOR	THRESHOLD	5	10	12	7	11	5	10	12	7	11	5	10	12	7	11	5	10	12	7	11	5	10	12	7	11	11	5	10	12	7	11	11	11	11	11
	MODE	5	9	8	0	11	-1	8	3	0	0	4	0	0	0	0	4	0	0	0	0	0	0	0	0	0	0	-2	9	3	4	-2	10	10	10	10
	PRE DELAY	5	10	12	7	11	5	10	12	7	11	5	10	12	7	11	5	10	12	7	11	5	10	12	7	11	11	5	10	12	7	11	11	11	11	11
	RATE	5	10	12	7	11	5	10	12	7	11	5	10	12	7	11	5	10	12	7	11	5	10	12	7	11	11	5	10	12	7	11	11	11	11	11
	DEPTH	5	10	12	7	11	5	10	12	7	11	5	10	12	7	11	5	10	12	7	11	5	10	12	7	11	11	5	10	12	7	11	11	11	11	11
REVERB/DELAY	E.LEV/RES	5	10	12	7	11	5	10	12	7	11	5	10	12	7	11	5	10	12	7	11	5	10	12	7	11	11	5	10	12	7	11	11	11	11	11
	MODE	5	9	8	0	11	-1	8	3	0	0	4	0	0	0	0	4	0	0	0	0	0	0	0	0	0	0	-2	9	3	4	-2	10	10	10	10
	DELAY TIME	5	10	12	7	11	5	10	12	7	11	5	10	12	7	11	5	10	12	7	11	5	10	12	7	11	11	5	10	12	7	11	11	11	11	11
	REV TIME/F.BACK	5	10	12	7	11	5	10	12	7	11	5	10	12	7	11	5	10	12	7	11	5	10	12	7	11	11	5	10	12	7	11	11	11	11	11
	TONE	5	10	12	7	11	5	10	12	7	11	5	10	12	7	11	5	10	12	7	11	5	10	12	7	11	11	5	10	12	7	11	11	11	11	11
MASTER LEVEL INPUT ATTENUATOR	EFFECT LEVEL	5	10	12	7	11	5	10	12	7	11	5	10	12	7	11	5	10	12	7	11	5	10	12	7	11	11	5	10	12	7	11	11	11	11	11
	MODE	5	9	8	0	11	-1	8	3	0	0	4	0	0	0	0	4	0	0	0	0	0	0	0	0	0	0	-2	9	3	4	-2	10	10	10	10
	DELAY TIME	5	10	12	7	11	5	10	12	7	11	5	10	12	7	11	5	10	12	7	11	5	10	12	7	11	11	5	10	12	7	11	11	11	11	11
	REV TIME/F.BACK	5	10	12	7	11	5	10	12	7	11	5	10	12	7	11	5	10	12	7	11	5	10	12	7	11	11	5	10	12	7	11	11	11	11	11
	TONE	5	10	12	7	11	5	10	12	7	11	5	10	12	7	11	5	10	12	7	11	5	10	12	7	11	11	5	10	12	7	11	11	11	11	11

ME-6B Blank Chart



EFFECTOR	BANK				
	1	2	3	4	5
COMPRESSOR					
ENHANCER					
OVERDRIVE/ DISTORTION					
SYNTH BASS					
EQUALIZER					
N.SUPPRESSOR					
CHORUS/FLANGER					
REVERB/DELAY					
MASTER LEVEL					
INPUT ATTENUATOR					

ME-6B Blank Chart



EFFECTOR	BANK NUMBER				
	1	2	3	4	5
COMPRESSOR ENHANCER	SUSTAIN				
	ATTACK				
	ENHANCE FREQ				
	ENHANCE LEVEL				
	TOTAL LEVEL				
OVERDRIVE/ DISTORTION	MODE				
	DRIVE				
	STONE				
	EFFECT LEVEL				
	DIRECT LEVEL				
SYNTH BASS	MODE				
	SENS				
	RESONANCE				
	DECAY TIME				
	DIRECT LEVEL				
EQUALIZER	HIGH LEVEL				
	MIDDLE FREQ				
	MIDDLE LEVEL				
	LOW LEVEL				
	TOTAL LEVEL				
N.SUPPRESSOR	THRESHOLD				
	MODE				
	PRE DELAY				
	RATE				
	DEPTH				
CHORUS/FLANGER	E.LEV/RES				
	MODE				
	DELAY TIME				
	REV TIME/F.BACK				
	STONE				
REVERB/DELAY	EFFECT LEVEL				
	MASTER LEVEL				
	INPUT ATTENUATOR				

SPECIFICATIONS

ME-6B: Bass Multiple Effects

Signal Processing

AD Conversion: 16 bit linear

DA Conversion: 16 bit linear

Sampling Frequency: 44.1kHz

Patches: 25 + Manual Setting

Effects: Compressor Enhancer, Overdrive/Distortion, Synth Bass, Equalizer, Noise Suppressor, Chorus/Flanger, Reverb/Delay

Nominal Input Level: -20dBm

Input Impedance: 1M Ω

Nominal Output Level: -20dBm

Output Impedance: 5.7k Ω

Recommended Load Impedance: 47k Ω or greater

Display: 7 segments, 2 characters (LED)

Connectors: Input Jacks (1/4 inch phone type)
Output Jacks (1/4 inch phone type) X 2 (L(MONO), R)
Tuner Out Jack (1/4 inch phone type)
Expression Pedal Jack
Manual Remote Jack
Bypass Remote Jack
Headphone Jack (stereo mini type)
AC Adaptor Jack (AC 12V)

Power Supply: AC12V: AC Adaptor BRA Series

Current Draw: 480mA

Dimensions: 442 (W) X 200 (D) X 52.5 (H) mm
17-7/16 X 7-7/8 X 2-1/8 inches

Weight: 2.2kg / 4 lbs 14 oz

Accessories: AC Adaptor BRA Series
Owner's Manual

Options: Footswitch FS-5U
Foot Volume/Expression FV-300L with PCS-33
Expression Pedal EV-5
Stereo Cord PCS-33
Chromatic Tuner TU Series

*0dBm=0.775Vrms

*The specifications for this product are subject to change without prior notice.

Roland®

10989

UPC 10989



10989

BOSS
Products of Roland

26050259 '92-10-B3-115E