

Roland®

# KR-7/5

DIGITAL  
INTELLIGENT PIANO

## Owner's Manual

Before using this unit, carefully read the sections entitled: "IMPORTANT SAFETY INSTRUCTIONS" (p. 2), "USING THE UNIT SAFELY" (p. 3), and "IMPORTANT NOTES" (p. 5). These sections provide important information concerning the proper operation of the unit. Additionally, in order to feel assured that you have gained a good grasp of every feature provided by your new unit, Owner's Manual should be read in its entirety. The manual should be saved and kept on hand as a convenient reference

Copyright © 2002 ROLAND CORPORATION

All rights reserved. No part of this publication may be reproduced in any form without the written permission of ROLAND CORPORATION.

	<b>CAUTION</b> RISK OF ELECTRIC SHOCK DO NOT OPEN	
<b>ATTENTION:</b> RISQUE DE CHOC ELECTRIQUE NE PAS OUVRIR		
<b>CAUTION:</b> TO REDUCE THE RISK OF ELECTRIC SHOCK, DO NOT REMOVE COVER (OR BACK). NO USER-SERVICEABLE PARTS INSIDE. REFER SERVICING TO QUALIFIED SERVICE PERSONNEL.		



The lightning flash with arrowhead symbol, within an equilateral triangle, is intended to alert the user to the presence of uninsulated "dangerous voltage" within the product's enclosure that may be of sufficient magnitude to constitute a risk of electric shock to persons.



The exclamation point within an equilateral triangle is intended to alert the user to the presence of important operating and maintenance (servicing) instructions in the literature accompanying the product.

INSTRUCTIONS PERTAINING TO A RISK OF FIRE, ELECTRIC SHOCK, OR INJURY TO PERSONS.

## IMPORTANT SAFETY INSTRUCTIONS SAVE THESE INSTRUCTIONS

**WARNING** - When using electric products, basic precautions should always be followed, including the following:

1. Read these instructions.
2. Keep these instructions.
3. Heed all warnings.
4. Follow all instructions.
5. Do not use this apparatus near water.
6. Clean only with a dry cloth.
7. Do not block any of the ventilation openings. Install in accordance with the manufacturers instructions.
8. Do not install near any heat sources such as radiators, heat registers, stoves, or other apparatus (including amplifiers) that produce heat.
9. Do not defeat the safety purpose of the polarized or grounding-type plug. A polarized plug has two blades with one wider than the other. A grounding type plug has two blades and a third grounding prong. The wide blade or the third prong are provided for your safety. When the provided plug does not fit into your outlet, consult an electrician for replacement of the obsolete outlet.
10. Protect the power cord from being walked on or pinched particularly at plugs, convenience receptacles, and the point where they exit from the apparatus.
11. Only use attachments/accessories specified by the manufacturer.
12. Never use with a cart, stand, tripod, bracket, or table except as specified by the manufacturer, or sold with the apparatus. When a cart is used, use caution when moving the cart/apparatus combination to avoid injury from tip-over.
13. Unplug this apparatus during lightning storms or when unused for long periods of time.
14. Refer all servicing to qualified service personnel. Servicing is required when the apparatus has been damaged in any way, such as power-supply cord or plug is damaged, liquid has been spilled or objects have fallen into the apparatus, the apparatus has been exposed to rain or moisture, does not operate normally, or has been dropped.



**For the U.K.**

**IMPORTANT:** THE WIRES IN THIS MAINS LEAD ARE COLOURED IN ACCORDANCE WITH THE FOLLOWING CODE.



BLUE: NEUTRAL  
BROWN: LIVE

As the colours of the wires in the mains lead of this apparatus may not correspond with the coloured markings identifying the terminals in your plug, proceed as follows:  
 The wire which is coloured BLUE must be connected to the terminal which is marked with the letter N or coloured BLACK.  
 The wire which is coloured BROWN must be connected to the terminal which is marked with the letter L or coloured RED.  
 Under no circumstances must either of the above wires be connected to the earth terminal of a three pin plug.







# USING THE UNIT SAFELY

## INSTRUCTIONS FOR THE PREVENTION OF FIRE, ELECTRIC SHOCK, OR INJURY TO PERSONS

About  WARNING and  CAUTION Notices

 <b>WARNING</b>	Used for instructions intended to alert the user to the risk of death or severe injury should the unit be used improperly.
 <b>CAUTION</b>	Used for instructions intended to alert the user to the risk of injury or material damage should the unit be used improperly. * Material damage refers to damage or other adverse effects caused with respect to the home and all its furnishings, as well to domestic animals or pets.

About the Symbols

	The  symbol alerts the user to important instructions or warnings. The specific meaning of the symbol is determined by the design contained within the triangle. In the case of the symbol at left, it is used for general cautions, warnings, or alerts to danger.
	The  symbol alerts the user to items that must never be carried out (are forbidden). The specific thing that must not be done is indicated by the design contained within the circle. In the case of the symbol at left, it means that the unit must never be disassembled.
	The  symbol alerts the user to things that must be carried out. The specific thing that must be done is indicated by the design contained within the circle. In the case of the symbol at left, it means that the power-cord plug must be unplugged from the outlet.

### ALWAYS OBSERVE THE FOLLOWING

#### WARNING

- Before using this unit, make sure to read the instructions below, and the Owner's Manual. 



---

- Do not open or perform any internal modifications on the unit. 

---

- Do not attempt to repair the unit, or replace parts within it (except when this manual provides specific instructions directing you to do so). Refer all servicing to your retailer, the nearest Roland Service Center, or an authorized Roland distributor, as listed on the "Information" page. 

---

- Never use or store the unit in places that are:
  - Subject to temperature extremes (e.g., direct sunlight in an enclosed vehicle, near a heating duct, on top of heat-generating equipment); or are 
  - Damp (e.g., baths, washrooms, on wet floors); or are 
  - Humid; or are
  - Exposed to rain; or are
  - Dusty; or are
  - Subject to high levels of vibration.

---

- Make sure you always have the unit placed so it is level and sure to remain stable. Never place it on stands that could wobble, or on inclined surfaces. 

---

- The unit should be connected to a power supply only of the type described in the operating instructions, or as marked on the unit. 

---

- Use only the attached power-supply cord. 



#### WARNING

- Do not excessively twist or bend the power cord, nor place heavy objects on it. Doing so can damage the cord, producing severed elements and short circuits. Damaged cords are fire and shock hazards! 

---

- This unit, either alone or in combination with an amplifier and headphones or speakers, may be capable of producing sound levels that could cause permanent hearing loss. Do not operate for a long period of time at a high volume level, or at a level that is uncomfortable. If you experience any hearing loss or ringing in the ears, you should immediately stop using the unit, and consult an audiologist. 

---

- Do not allow any objects (e.g., flammable material, coins, pins); or liquids of any kind (water, soft drinks, etc.) to penetrate the unit.   



---

- In households with small children, an adult should provide supervision until the child is capable of following all the rules essential for the safe operation of the unit. 



---

- Protect the unit from strong impact. (Do not drop it!) 







---

- Do not force the unit's power-supply cord to share an outlet with an unreasonable number of other devices. Be especially careful when using extension cords—the total power used by all devices you have connected to the extension cord's outlet must never exceed the power rating (watts/amperes) for the extension cord. Excessive loads can cause the insulation on the cord to heat up and eventually melt through. 



**⚠ WARNING**

- Before using the unit in a foreign country, consult with your retailer, the nearest Roland Service Center, or an authorized Roland distributor, as listed on the “Information” page. 
- Do not put anything that contains water (e.g., flower vases) on this unit. Also, avoid the use of insecticides, perfumes, alcohol, nail polish, spray cans, etc., near the unit. Swiftly wipe away any liquid that spills on the unit using a dry, soft cloth. 

**⚠ CAUTION**

- The unit should be located so that its location or position does not interfere with its proper ventilation. 
- Always grasp only the plug on the power-supply cord when plugging into, or unplugging from, an outlet or this unit. 
- Try to prevent cords and cables from becoming entangled. Also, all cords and cables should be placed so they are out of the reach of children. 
- Never climb on top of, nor place heavy objects on the unit. 
- Never handle the power cord or its plugs with wet hands when plugging into, or unplugging from, an outlet or this unit. 
- If you need to move the instrument, take note of the precautions listed below. At least two persons are required to safely lift and move the unit. It should be handled carefully, all the while keeping it level. Make sure to have a firm grip, to protect yourself from injury and the instrument from damage. 
  - Check to make sure the knob bolts securing the unit to the stand have not become loose. Fasten them again securely whenever you notice any loosening.
  - Disconnect the power cord.
  - Disconnect all cords coming from external devices.
  - Raise the adjusters on the stand (p. 20).
  - Close the lid.
  - Fold down the music stand.
- Before cleaning the unit, turn off the power and unplug the power cord from the outlet (p. 18). 

**⚠ CAUTION**

- Whenever you suspect the possibility of lightning in your area, pull the plug on the power cord out of the outlet. 
- Be careful when opening/closing the lid so you do not get your fingers pinched (p. 19). Adult supervision is recommended whenever small children use the unit. 
- Should you remove the screws fastening the stand, make sure to put them in a safe place out of children’s reach, so there is no chance of them being swallowed accidentally. 

# IMPORTANT NOTES

In addition to the items listed under “IMPORTANT SAFETY INSTRUCTIONS” and “USING THE UNIT SAFELY” on pages 2, 3 and 4, please read and observe the following:

## Power Supply

- Do not use this unit on the same power circuit with any device that will generate line noise (such as an electric motor or variable lighting system).
- Before connecting this unit to other devices, turn off the power to all units. This will help prevent malfunctions and/or damage to speakers or other devices.
- Although the LCD and LEDs are switched off when the POWER switch is switched off, this does not mean that the unit has been completely disconnected from the source of power. If you need to turn off the power completely, first turn off the POWER switch, then unplug the power cord from the power outlet. For this reason, the outlet into which you choose to connect the power cord’s plug should be one that is within easy reach.

## Placement

- Using the unit near power amplifiers (or other equipment containing large power transformers) may induce hum. To alleviate the problem, change the orientation of this unit; or move it farther away from the source of interference.
- This device may interfere with radio and television reception. Do not use this device in the vicinity of such receivers.
- Noise may be produced if wireless communications devices, such as cell phones, are operated in the vicinity of this unit. Such noise could occur when receiving or initiating a call, or while conversing. Should you experience such problems, you should relocate such wireless devices so they are at a greater distance from this unit, or switch them off.
- Observe the following when using the unit’s floppy disk drive. For further details, refer to “Before Using Floppy Disks” (p. 6).
  - Do not place the unit near devices that produce a strong magnetic field (e.g., loudspeakers).
  - Install the unit on a solid, level surface.
  - Do not move the unit or subject it to vibration while the drive is operating.
- Do not expose the unit to direct sunlight, place it near devices that radiate heat, leave it inside an enclosed vehicle, or otherwise subject it to temperature extremes. Also, do not allow lighting devices that normally are used while their light source is very close to the unit (such as a piano light), or powerful spotlights to shine upon the same area of the unit for extended periods of time. Excessive heat can deform or discolor the unit.
- To avoid possible breakdown, do not use the unit in a wet area, such as an area exposed to rain or other moisture.
- Do not allow rubber, vinyl, or similar materials to remain on the unit for long periods of time. Such objects can discolor or otherwise harmfully affect the finish.

- Do not allow objects to remain on top of the keyboard. This can be the cause of malfunction, such as keys ceasing to produce sound.
- Do not paste stickers, decals, or the like to this instrument. Peeling such matter off the instrument may damage the exterior finish.

## Maintenance

- To clean the unit, use a dry, soft cloth; or one that is slightly dampened. Try to wipe the entire surface using an equal amount of strength, moving the cloth along with the grain of the wood. Rubbing too hard in the same area can damage the finish.
- Never use benzine, thinners, alcohol or solvents of any kind, to avoid the possibility of discoloration and/or deformation.
- The pedals of this unit are made of brass. Brass eventually darkens as the result of the natural oxidization process. If the brass becomes tarnished, polish it using commercially available metal polisher.

### For KR-5-PE

- Since your piano has a polished finish that is as delicate as that found on finely crafted wooden furniture, it needs careful, periodic care. A few important suggestions concerning the proper care of the unit follow.
  - **For dusting, wipe the instrument with a soft cloth that has been soaked with water, then squeezed dry.** Be sure to wipe gently. Even the tiniest grains of sand or grit can leave scratches on the surface if too much force is applied while wiping. Do not use any cleaners or detergents, since they might deteriorate the surface of the cabinet, and produce cracks. Do not use dusting cloths that contain chemicals.

## Additional Precautions

- Please be aware that the contents of memory can be irretrievably lost as a result of a malfunction, or the improper operation of the unit. To protect yourself against the risk of losing important data, we recommend that you periodically save a backup copy of important data you have stored in the unit’s memory on a floppy disk.
- Unfortunately, it may be impossible to restore the contents of data that was stored on a floppy disk once it has been lost. Roland Corporation assumes no liability concerning such loss of data.
- Use a reasonable amount of care when using the unit’s buttons, sliders, or other controls; and when using its jacks and connectors. Rough handling can lead to malfunctions.
- Never strike or apply strong pressure to the display.
- When connecting / disconnecting all cables, grasp the connector itself—never pull on the cable. This way you will avoid causing shorts, or damage to the cable’s internal elements.
- A small amount of heat will radiate from the unit during normal operation.

## IMPORTANT NOTES

- To avoid disturbing your neighbors, try to keep the unit's volume at reasonable levels. You may prefer to use headphones, so you do not need to be concerned about those around you (especially when it is late at night).
- When you need to transport the unit, pack it in shock-absorbent material. Transporting the unit without doing so can cause it to become scratched or damaged, and could lead to malfunction.
- Do not pull the music stand too far forward when setting/releasing its latches.
- Use a cable from Roland to make the connection. If using some other make of connection cable, please note the following precautions.
  - Some connection cables contain resistors. Do not use cables that incorporate resistors for connecting to this unit. The use of such cables can cause the sound level to be extremely low, or impossible to hear. For information on cable specifications, contact the manufacturer of the cable.

## Before Using Floppy Disks

### Handling the Floppy Disk Drive



- Install the unit on a solid, level surface in an area free from vibration. If the unit must be installed at an angle, be sure the installation does not exceed the permissible range: upward.
- Avoid using the unit immediately after it has been moved to a location with a level of humidity that is greatly different than its former location. Rapid changes in the environment can cause condensation to form inside the drive, which will adversely affect the operation of the drive and/or damage floppy disks. When the unit has been moved, allow it to become accustomed to the new environment (allow a few hours) before operating it.
- To insert a disk, push it gently but firmly into the drive—it will click into place. To remove a disk, press the EJECT button firmly. Do not use excessive force to remove a disk which is lodged in the drive.
- Never eject a disk while reading or writing is in progress, since that can damage the magnetic surface of the disk, rendering it unusable. (The disk drive's indicator will light up at full brightness when the drive is busy reading or writing data. Ordinarily, the indicator will be less brightly lit, or be extinguished.)
- Remove any disk from the drive before powering up or down.
- To prevent damage to the disk drive's heads, always try to hold the floppy disk in a level position (not tilted in any direction) while inserting it into the drive. Push it in firmly, but gently. Never use excessive force.
- To avoid the risk of malfunction and/or damage, insert only floppy disks into the disk drive. Never insert any other type of disk. Avoid getting paper clips, coins, or any other foreign objects inside the drive.

## Handling Floppy Disks

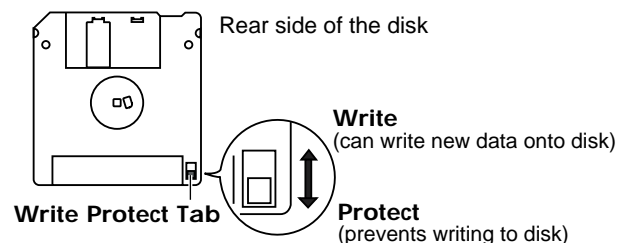
- Floppy disks contain a plastic disk with a thin coating of magnetic storage medium. Microscopic precision is required to enable storage of large amounts of data on such a small surface area. To preserve their integrity, please observe the following when handling floppy disks:
  - Never touch the magnetic medium inside the disk.
  - Do not use or store floppy disks in dirty or dusty areas.
  - Do not subject floppy disks to temperature extremes (e.g., direct sunlight in an enclosed vehicle). Recommended temperature range: 10 to 50° C (50 to 122° F).
  - Do not expose floppy disks to strong magnetic fields, such as those generated by loudspeakers.
- Floppy disks have a "write protect" tab which can protect the disk from accidental erasure. It is recommended that the tab be kept in the PROTECT position, and moved to the WRITE position only when you wish to write new data onto the disk.



- The identification label should be firmly affixed to the disk. Should the label come loose while the disk is in the drive, it may be difficult to remove the disk.
- Store all disks in a safe place to avoid damaging them, and to protect them from dust, dirt, and other hazards. By using a dirty or dust-ridden disk, you risk damaging the disk, as well as causing the disk drive to malfunction.
- Disks containing performance data for this unit should always be locked (have their write protect tab slid to the "Protect" position) before you insert them into the drive on some other unit (except the PR-300, or a product in the HP-G, MT, KR, or Atelier families), or into a computer's drive. Otherwise (if the write protect tab remains in the "Write" position), when you perform any disk operations using the other device's disk drive (such as checking the contents of the disk, or loading data), you risk rendering the disk unreadable by this unit's disk drive.

- \* GS (  ) is a registered trademark of Roland Corporation.
- \* XG lite (  ) is a registered trademark of Yamaha Corporation.
- \* Apple and Macintosh are registered trademark of Apple Computer, Inc.
- \* IBM and IBM PC are registered trademark of International Business Machines Corporation.
- \* All product names mentioned in this document are trademarks or registered trademarks of their respective owners.

# Introduction

Thank you, and congratulations on your choice of the Roland KR-7/5 Intelligent Piano. While the KR-7/5 Intelligent Piano certainly allows you to achieve authentic piano performances, it also features easy-to-use Automatic Accompaniment and numerous other useful functions. In order to enjoy reliable performance of your new keyboard for many years to come, please take the time to read through this manual in its entirety.

## Main Features

---

### ○ Piano Sounds with Rich Resonance and Wide-Ranging Expressiveness

The stereo sampling piano sound generator realistically reproduces even the sound of the hammers striking the strings, producing the tones of a high-quality concert grand piano.

Maximum polyphony of 128 notes (KR-7) or 64 notes (KR-5) ensures that you can use the pedal freely without running out of notes.

The KR-7 features a new speaker system, “grand piano presence system,” to provide sounds with depth and spatial realism.

### ○ Pursuing the Playing Feel of a Grand Piano

These instruments feature a progressive hammer action keyboard, which duplicates the touch of a grand piano, with a heavier touch in the lower register, and a lighter touch in the upper register. In addition, on the KR-7, even the distinctive “click” that you feel when pressing a key on a grand piano has been faithfully simulated (escapement mechanism).

The pedal is designed for good-feeling response, and allows subtle performance nuances to be expressed.

### ○ Get Easy Results with the Main Buttons

You can play songs, display scores, play the Automatic Accompaniment, select Tones, and perform other main KR functions easily by pressing the main buttons found on both sides of the screen.

With the **[Select/Listen to a Song] button**, you can select over 150 internal songs, from songs for piano practice to the latest hits. Pressing the **[Score Display] button** lets you display not only the score for any of the internal songs, but for your own recorded songs and songs on floppy disks.

With the **[Music Assistant] button** you can select a song you want to play, call up Automatic Accompaniment settings that match that song, and while looking at the chord score, perform with accompaniment added.

Thanks to the **[Select Various Tones] button**, which is used to select suggested Tones from the more than 600 internal Tones; the **[Song Stylist] button** (KR-7), which allows you to listen to a variety of arrangements of the internal popular songs, and transform them into rock, jazz, or other forms of music; and the **[Session Partner] button** (KR-7), which lets you leave the chords and rhythm to the backing band, and give your performances the feel of a group session, you can enjoy playing the KR in a great variety of creative ways.

### ○ **A Variety of Support Functions for Fostering Rich Musical Abilities**

In addition to score displays that let you see note names and fingerings, and a bouncing ball that keeps track of the notes currently being played, you can also enjoy other powerful practice functions, like repeated practice of a specified segment, and simple playback and recording of each hand's part—features that only a digital piano can provide.

Other useful practice features include a “Replay” pedal that you can press to stop the performance and go back when you have trouble with what you're playing, and “Touch the Note,” a function that lets you confirm how a note sounds by touching the note on the screen.

Features geared specifically for young children include “Wonderland,” where kids can enjoy touching a variety of instruments; and the “Game,” an ear-training feature which helps build their listening abilities with all the fun of a game.

### ○ **“Rhythm Partner” Provides Natural-Sounding Tempo**

Along with a wide variety of metronome functions that allow you to change the tone and note divisions (patterns), the KR also includes built-in rhythm functions. Now you can perform with a natural tempo that matches the rhythm.

### ○ **Connector for External Display for Enlarged Scores and Lyrics (KR-7)**

The KR-7 features a built-in connector for external displays.

By displaying scores and lyrics on a bigger screen, everyone playing in your group should be able to get a clear view.

### ○ **Adjustable Music Stand (KR-7)**

In addition to allowing you to adjust the angle of the stand, and move it forward or backward, the music holders accommodates even thick score books.



---

## How To Use This Manual

---

The KR-7/5 Owner's Manual consists of two volumes, **Quick Start** and the **Owner's Manual**.

Please start out by reading "Before You Start Playing" (p. 18) in the **Owner's Manual** (this volume). This explains how to connect the KR's power cord and how to turn on the instrument's power.

After turning on the KR's power, please continue by reading **Quick Start**.

By trying out the various procedures while reading the **Quick Start**, you can easily learn how to play the KR and make use of its major functions (especially procedures that involve use of the "main buttons").

The **Owner's Manual** describes procedures, from basic operation to procedures for special applications (for example, using the KR as an accompanist and creating songs), that will help you master the KR's many performance functions.

### ■ Conventions Used in This Manual

This manual uses the following conventions in the interest of simpler, more concise instructions.

- Button names are enclosed in square brackets "[ ]", as in One Touch Program [Piano] button.
- On screen text is enclosed in angled brackets "< >", as in <Exit>.
- The act of lightly contacting the Touch Screen with your finger is called "touching."
- An asterisk (\*) or a **NOTE** at the beginning of a paragraph indicates a note or precaution. These should not be ignored.
- (p. \*\*) refers to pages within the manual.
- The text incorporates KR-7 screen shots and panel diagrams. Thus, there will be some portions where the information differs from that for the KR-5.

# Panel Descriptions

## KR-7

\* The panel diagrams shown in this owner's manual are those of the KR-7.

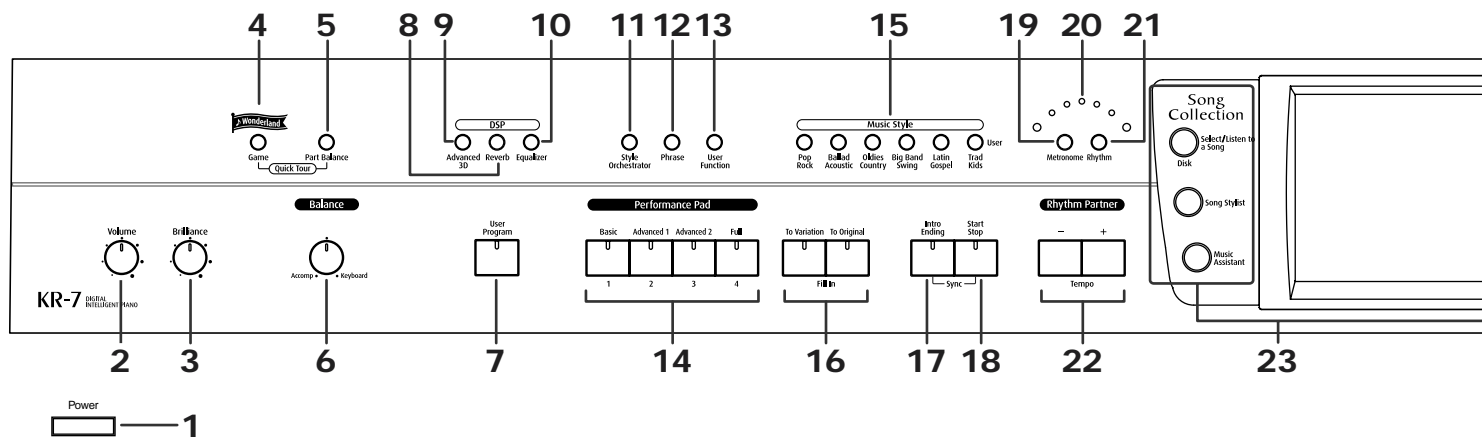

### 1. [Power] switch

Pressed to switch the power on and off (p. 19).

### 2. [Volume] knob

Adjusts the overall volume (p. 20).

### 3. [Brilliance] knob

Adjusts the brightness of the sound (p. 20).

### 4. [Wonderland/Game] button

Here you can learn about instruments while having fun.

→ See the Quick Start

## Balance

### 5. [Part Balance] button

This adjusts the relative volume levels of each of the performance parts (p. 67).

### 6. [Balance] knob

Changes the volume balance for sounds played with the keyboard and for songs and accompaniments (p. 67).

### 7. [User Program] button

Stores the selected functions and states of the buttons (p. 112).

## DSP

### 8. [Reverb] button

Adds reverberation to the sound (p. 31).

### 9. [Advanced 3D] button

Adds three-dimensional breadth to the accompaniment sounds (p. 32).

### 10. [Equalizer] button

Allows you to adjust the tone quality with the equalizer (p. 34).

### 11. [Style Orchestrator] button

This is used to change the arrangement type for automatic accompaniment with the Performance Pads (p. 62).

### 12. [Phrase] Button

This is used to play a short phrase with the Performance Pads (p. 63).

## 10

### 13. [User Function] Button

This is used to assign a variety of functions to the Performance Pads (p. 147).

## Performance Pads

### 14. [1]-[4]

The operation of each is changed depending on the buttons numbered 11-13.

### 15. Music Style buttons

Selects a Music Style for automatic accompaniment (p. 54). Pressing the [User] button selects a User Style that you've made yourself or a Music Style on floppy disk (p. 55).

### 16. Fill In buttons

Inserts a fill-in in an automatic accompaniment and changes the accompaniment pattern (p. 61).

[To Variation] button

[To Original] button

### 17. [Intro/Ending] button

Play an intro or ending during automatic accompaniment (p. 58).

### 18. [Start/Stop] button

Starts and stops automatic accompaniment (p. 58).

## Rhythm Partner

### 19. [Metronome] button

Activates the built-in metronome (p. 44).

You can change the count sound settings (p. 151).

### 20. Beat Indicator

This lights up in correspondence with the beat of the selected song or accompaniment.

### 21. [Rhythm] button

Plays the Rhythm pattern (p. 48).

### 22. Tempo [-] [+] buttons

Adjusts the tempo.

Press the [-] and [+] buttons at the same time to return to the original tempo.

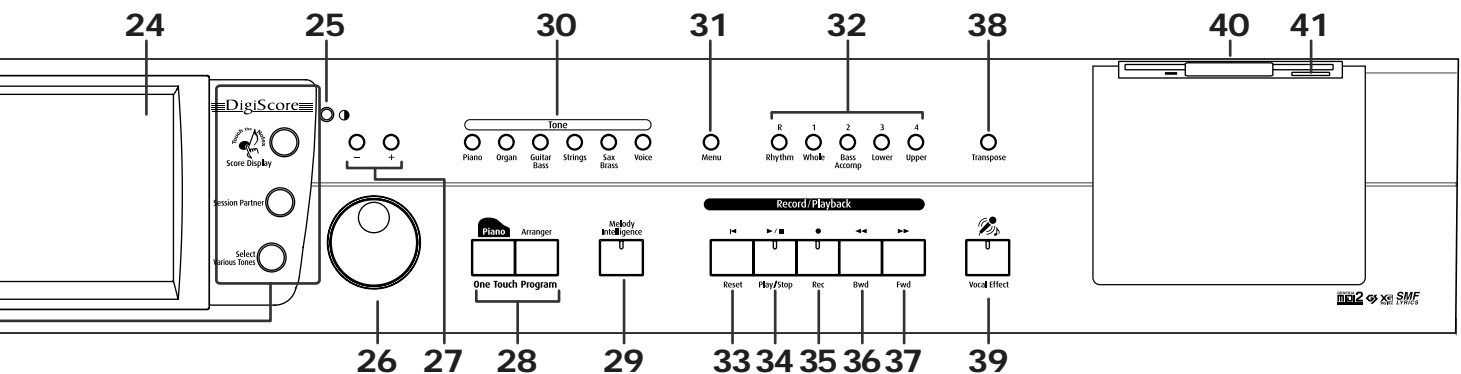

## 23. Main Buttons

→ See the Quick Start

[Select/Listen to a Song], [Disk] button

Use this button to select internal songs or songs from floppy disk (p. 69).

[Song Stylist] button

[Music Assistant] button

[Score Display] button

Displays scores (p. 74).

You can use the practice function (p. 78).

[Session Partner] button

[Select Various Tones] button

## 24. Touch Screen

This lets you perform a variety of operations just by touching the screen (p. 22).

## 25. Contrast knob

Adjusts the contrast of the screen (p. 22).

## 26. Dial

Use this to change on-screen values.

## 27. [-] [+] buttons

Allow you to change on-screen values.

## 28. One Touch Program button

[Piano] button

Makes the optimal settings for a piano performance (p. 24).

[Arranger] button

Makes the optimal settings for playing with automatic accompaniment (p. 51).

## 29. [Melody Intelligence] Button

Adds harmony to the sounds played with the keyboard (p. 64).

## 30. [Tone] buttons

Select the Tones that will be played from the keyboard (p. 25).

## Record/Playback

### 31. [Menu] button

You can select functions for playing back, recording or editing a song (p. 92, p. 117, p. 134).

### 32. Track buttons

Used to play back or record each track of a song (p. 86, p. 101).

### 33. [⏮ (Reset)] button

Resets the song playback-start location to the beginning of the song.

### 34. [▶/■ (Play/Stop)] button

Starts and stops playback or recording a song.

### 35. [● (Rec)] button

When pressed, this button places the instrument in recording standby (p. 96, p. 117).

### 36. [⏪ (Bwd)] button

Rewinds the song.

### 37. [⏩ (Fwd)] button

Fast-forwards the song.

### 38. [Transpose] button

Transposes the pitch of the keyboard or the song being played (p. 90).

### 39. [Vocal Effect] Button

Applies a variety of effects to vocals from the microphone (p. 37).

## 40. Disk Drive

You can insert a floppy disk for playing back or saving songs (p. 69, p. 106).

## 41. Eject Button

Ejects a floppy disk from the disk drive (p. 104).

## KR-5

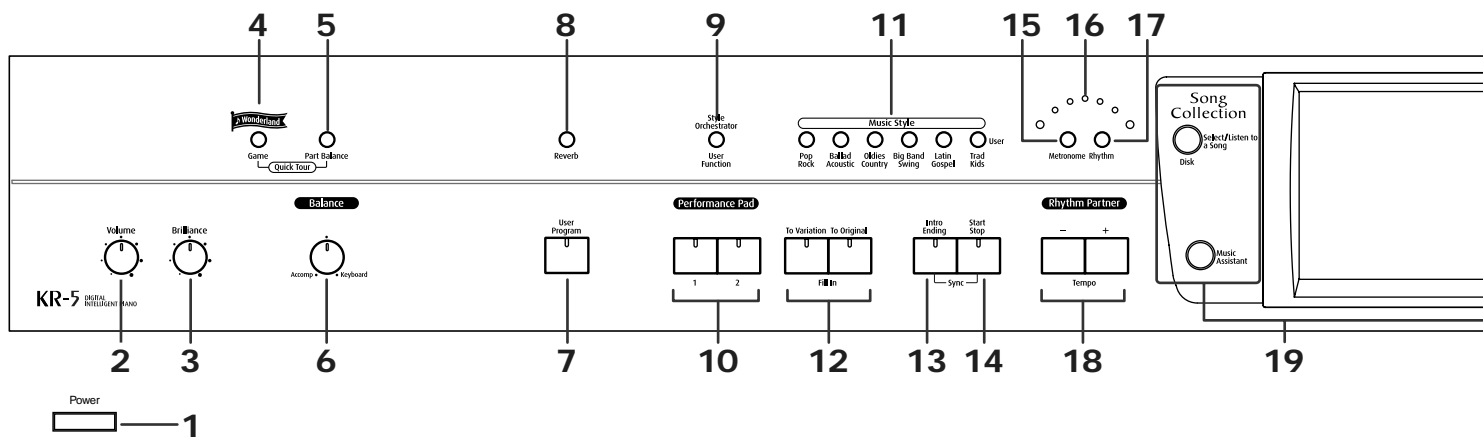

### 1. [Power] switch

Pressed to switch the power on and off (p. 19).

### 2. [Volume] knob

Adjusts the overall volume (p. 20).

### 3. [Brilliance] knob

Adjusts the brightness of the sound (p. 20).

### 4. [Wonderland/Game] button

Here you can learn about instruments while having fun.

→ **See the Quick Start**

## Balance

### 5. [Part Balance] button

This adjusts the relative volume levels of each of the performance parts (p. 67).

### 6. [Balance] knob

Changes the volume balance for sounds played with the keyboard and for songs and accompaniments (p. 67).

### 7. [User Program] button

Stores the selected functions and states of the buttons (p. 112).

### 8. [Reverb] button

Adds reverberation to the sound (p. 31).

### 9. [Style Orchestrator/User Function] button

Switch the function of the Performance Pads.

This is used to change the arrangement type for automatic accompaniment with the Performance Pads (p. 62), and used to assign a variety of functions to the Performance Pads (p. 147).

## Performance Pads

### 10. [1], [2]

The operation of each is changed depending on the [Style Orchestrator/User Function] button.

### 11. Music Style buttons

Selects a Music Style for automatic accompaniment (p. 54).

Pressing the [User] button selects a User Style that you've made yourself or a Music Style on floppy disk (p. 55).

### 12. Fill In buttons

Inserts a fill-in in an automatic accompaniment and changes the accompaniment pattern (p. 61).

[To Variation] button

[To Original] button

### 13. [Intro/Ending] button

Play an intro or ending during automatic accompaniment (p. 58).

### 14. [Start/Stop] button

Starts and stops automatic accompaniment (p. 58).

## Rhythm Partner

### 15. [Metronome] button

Activates the built-in metronome (p. 44).

You can change the count sound settings (p. 151).

### 16. Beat Indicator

This lights up in correspondence with the beat of the selected song or accompaniment.

### 17. [Rhythm] button

Plays the Rhythm pattern (p. 48).

### 18. Tempo [-] [+] buttons

Adjusts the tempo.

Press the [-] and [+] buttons at the same time to return to the original tempo.

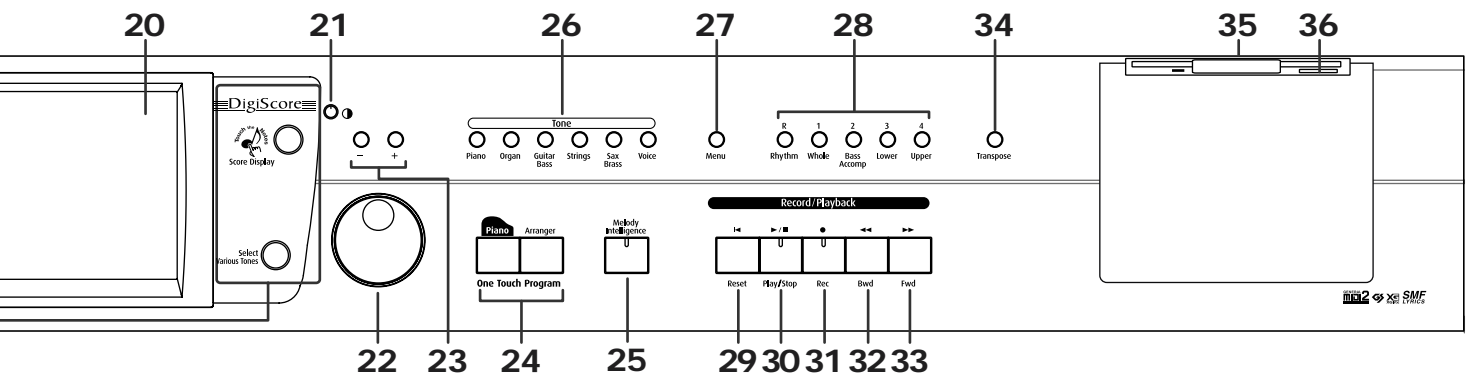

## 19. Main Buttons

→ See the Quick Start

[Select/Listen to a Song], [Disk] button

Use this button to select internal songs or songs from floppy disk (p. 69).

[Music Assistant] button

[Score Display] button

Displays scores (p. 74).

You can use the practice function (p. 78).

[Select Various Tones] button

## 20. Touch Screen

This lets you perform a variety of operations just by touching the screen (p. 22).

## 21. Contrast knob

Adjusts the contrast of the screen (p. 22).

## 22. Dial

Use this to change on-screen values.

## 23. [-] [+] buttons

Allow you to change on-screen values.

## 24. One Touch Program button

[Piano] button

Makes the optimal settings for a piano performance (p. 24).

[Arranger] button

Makes the optimal settings for playing with automatic accompaniment (p. 51).

## 25. [Melody Intelligence] Button

Adds harmony to the sounds played with the keyboard (p. 64).

## 26. [Tone] buttons

Select the Tones that will be played from the keyboard (p. 25).

## Record/Playback

### 27. [Menu] button

You can select functions for playing back, recording or editing a song (p. 92, p. 117, p. 134).

### 28. Track buttons

Used to play back or record each track of a song (p. 86, p. 101).

### 29. [⏪ (Reset)] button

Resets the song playback-start location to the beginning of the song.

### 30. [▶/■ (Play/Stop)] button

Starts and stops playback or recording a song.

### 31. [● (Rec)] button

When pressed, this button places the instrument in recording standby (p. 96, p. 117).

### 32. [⏮ (Bwd)] button

Rewinds the song.

### 33. [⏭ (Fwd)] button

Fast-forwards the song.

### 34. [Transpose] button

Transposes the pitch of the keyboard or the song being played (p. 90).

### 35. Disk Drive

You can insert a floppy disk for playing back or saving songs (p. 69, p. 106).

### 36. Eject Button

Ejects a floppy disk from the disk drive (p. 104).

# Rear Panel

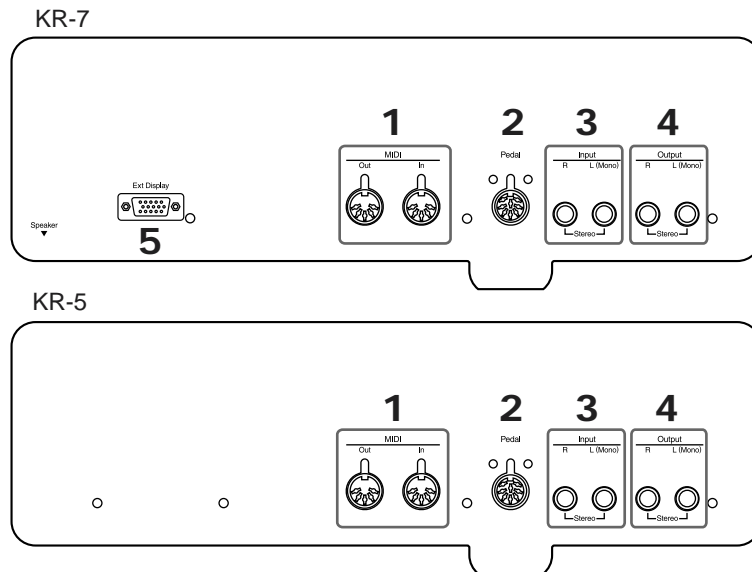

### 1. MIDI Out/In connectors

These can be connected to an external MIDI device to exchange performance data (p. 158).

\* There is also a MIDI In connector on the bottom panel. The two MIDI In connectors cannot be used simultaneously.

### 2. Pedal connector

Connect the pedal cable of the stand to this connector (p. 18).

### 3. Input jacks

These jacks can be connected to another sound generating device or an audio device, so that the sound of that device will be output from the KR-7/5's speakers (p. 162).

### 4. Output jacks

These jacks can be connected to your audio system to enjoy more powerful sound. They can also be connected to a tape recorder or similar device in order to record your performance on a cassette tape (p. 162).

### 5. Ext Display connector (KR-7)

Connect an external display. You can put scores on the screen and display lyrics (p. 21).

# Bottom Panel

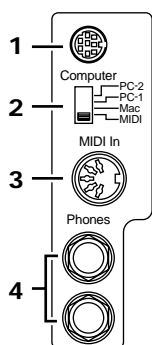

### 1. Computer connector

You can connect a computer to this connector to exchange performance data (p. 163).

### 2. Computer switch

The setting for this switch made depending on the computer connected - Mac/PC-1/PC-2. Switches the connections for the MIDI connectors and the computer port (p. 163).

\* You can't use the MIDI Out/In connector and the Computer connector at the same time.

### 3. MIDI In connector

An external MIDI device can be connected here to receive performance data (p. 158).

\* There is also a MIDI In connector on the rear panel of the KR-7/5. The two MIDI In connectors cannot be used simultaneously.

### 4. Phones jacks

A set of headphones can be connected here (p. 20).

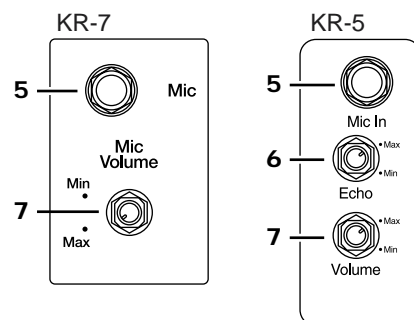

### 5. Mic In jack

Used for connecting microphones (p. 21).

### 6. Echo knob (KR-5)

Adjusts the echo level (p. 21).

### 7. Mic Volume knob

Adjusts the volume level for the microphone (p. 21).

# Contents

USING THE UNIT SAFELY .....	3
IMPORTANT NOTES .....	5
<b>Introduction .....</b>	<b>7</b>
Main Features .....	7
How To Use This Manual .....	9
Conventions Used in This Manual .....	9
<b>Panel Descriptions .....</b>	<b>10</b>
KR-7 .....	10
KR-5 .....	12
Rear Panel .....	14
Bottom Panel .....	14
<b>Before You Start Playing .....</b>	<b>18</b>
Connect the Pedal Cable .....	18
Connect the Speaker Cable (KR-7) .....	18
Connect the Power Cord .....	18
Setting Up the Music Stand (KR-5) .....	18
Setting Up the Music Stand (KR-7) .....	18
Adjusting the Position of the Music Stand .....	19
Folding Down the Music Stand .....	19
Using the Music Holders .....	19
Removing the Music Stand .....	19
Opening/Closing the Lid .....	19
Turning the Power On and Off .....	19
About the Pedals .....	20
Adjusting the Sound's Volume and Brilliance .....	20
Connecting Headphones .....	20
Connecting a Microphone .....	21
Connecting an External Display (KR-7) .....	21
Making the Connections .....	21
About the Touch Screen .....	22
Adjusting the Contrast of the Screen .....	22
Main Screens .....	23
Piano Screen .....	23
Basic Screen .....	23
Using the Main Icons .....	23
<b>Chapter 1 Performance .....</b>	<b>24</b>
Playing the Keyboard Like a Piano (One-Touch Piano) .....	24
Performing with a Variety of Tones (Tone Buttons) .....	25
Playing Percussion Instruments or Sound Effects .....	26
Using Keywords to Search for Tones (Tone Search) .....	27
Performing with Two Sounds Layered Together (Layer) .....	28
Playing Different Tones with the Left and Right Hands (Split) .....	29
Shifting the Keyboard Pitch in Octave Steps (Octave Shift) .....	30
Adding Reverberation to the Sound (Reverb) .....	31
Adding Three-Dimensional Breadth to the Sounds You Play (Advanced 3D) (KR-7) .....	32
Adjusting the Sound to Achieve the Preferred Tone Quality (Equalizer) (KR-7) .....	34
Adding Effects to Each Tone and Voice .....	36
Applying Effects to the Sound (Effects) .....	36
Adding Effects to Mic Vocals (Vocal Effect) (KR-7) .....	37
Enjoying Karaoke Performances with Music Files .....	43
Using the Metronome and Rhythm (Rhythm Partner) .....	44
Using the Metronome .....	44
Changing the Metronome Settings .....	45
Playing Rhythm .....	48
Changing the Rhythm settings .....	48
<b>Chapter 2 Automatic Accompaniment .....</b>	<b>50</b>
Music Styles and Automatic Accompaniment .....	50
Performing Using Automatic Accompaniment (One-Touch Arranger) .....	51
About Chords .....	52
Playing Chords with Simple Fingering (Chord Intelligence) .....	52
Viewing Chord Fingerings (Chord Finder) .....	53
Selecting Music Styles (Music Style Buttons) .....	54
Selecting Music Styles on Disks .....	55
Using Keywords to Search for Music Styles (Style Search) .....	56
Playing Only Music Style Rhythm Patterns .....	57
Adjusting the Accompaniment Tempo .....	57
Starting and Stopping the Accompaniment .....	58
Having the Accompaniment Start Simultaneously When You Play the Keyboard (Sync) .....	58
Stopping Automatic Accompaniment .....	59
Having a Count Sound Play at the End of the Intro (Countdown) .....	60
Modifying an Accompaniment .....	61
Changing the Accompaniment Pattern (Fill In Buttons) .....	61
Changing the Instrumental Makeup of Music Styles (Style Orchestrator) .....	62
Playing Phrases (Phrase) (KR-7) .....	63
Adding Harmony to the Right-Hand Part (Melody Intelligence) .....	64
Playing Sounds in the Left Hand During a Performance (Lower Tone) .....	65
Playing the Piano with Accompaniment Added (Piano Style Arranger) .....	66
Adjusting the Volume Balance for Each Part (Balance) .....	67
Changing the Volume Balance between the Accompaniment and the Keyboard (Balance Knob) .....	67
Adjusting the Volume Balance for Each Performance Part (Part Balance) .....	67

# Contents

## Chapter 3 Song Playback and Practice Functions.....69

Playing a Song.....	69
Using Keywords to Search for Songs (Song Search).....	71
Registering the Songs You Like (Favorites).....	72
Removing Songs from Favorites.....	73
Displaying the Score.....	74
Touching Notes to Confirm the Sounds (Touch the Notes).....	75
Making Detailed Settings for the Score Display.....	76
Saving Scores as Image Data (KR-7).....	77
Practicing Songs with the Practice Function (KR-7).....	78
Adjusting the Tempo.....	81
Setting the Tempo by Pressing the Button in Time (Tap Tempo).....	82
Use Your Voice to Select the Tempo (Vocal Tap Tempo) (KR-7).....	84
Playing Back at a Fixed Tempo (Tempo Mute).....	84
Match the Tempo Before You Begin Playing (Count In).....	85
Muting Some Parts Before Playing (Track Buttons).....	86
Setting Markers for Repeated Practice (Marker).....	87
Placing a Marker within a Song.....	87
Playback from a Marker location.....	88
Erasing a Marker.....	88
Moving a Marker.....	88
Playing Back the Same Passage Over and Over.....	89
Transposing Keyboard Sounds and Songs Played Back (Transpose).....	90
Detailed Song Playback Settings.....	92
Changing the Tone Settings When Playing Back Songs (Play Mode).....	92
Hiding the Lyrics (Lyrics).....	93
Changing the Parts Assigned to the Track Buttons During SMF Playback (Track Assign).....	94

## Chapter 4 Recording and Saving the Performance.....95

Recording a New Song (New Song).....	96
Recording With Accompaniment.....	98
Recording Along with a Song.....	100
Recording While Selecting the Track Buttons (Redoing Recordings).....	101
Erasing Recorded Performances.....	102
Erasing the Performance on Specific Tracks.....	102
Changing How Recording Stops.....	102
Recording Songs Starting with Pickups.....	103
Using Floppy Disks.....	104
Inserting and Ejecting a Floppy Disk.....	104
Formatting Floppy Disks (Format).....	104
Saving Songs.....	106
Deleting Saved Songs.....	109
Copying Songs on Disks to Favorites (KR-7).....	110
Copying Songs Saved in Favorites to Disks (KR-7).....	111

## Chapter 5 User Program Registration..... 112

Saving Performance Settings (User Program).....	112
Calling Up Saved User Programs.....	113
Changing the Way User Programs Are Called Up.....	113
Saving the User Program Sets.....	113
Loading Saved User Program Sets.....	114
Deleting Saved User Program Sets.....	115
Copying Sets of User Programs on Disks to the User Memory (KR-7).....	115
Coping Sets of User Programs Stored in the User Memory to Disks (KR-7).....	116
Using the Pedal to Switch User Programs.....	116
Simultaneously Switching User Program and Transmitting PC Numbers.....	116

## Chapter 6 Creating and Editing Songs ..... 117

Multitrack Recording with 16 Parts (16-Track Sequencer).....	117
The 16-Track Sequencer Screen.....	117
Modifying the Settings of Each Part.....	118
Getting the Most Suitable Part Tones for the Musical Genre (Tone Set).....	119
Recording a Performance.....	119
Changing the Recording Method (Rec Mode).....	120
Recording While Erasing the Previous Recording (Replace Recording).....	121
Layering a Recording Over Previously Recorded Sounds (Mix Recording).....	121
Repeated Recording at the Same Location (Loop Recording).....	122
Re-Recording Part of Your Performance (Punch-in Recording).....	123
Composing an Accompaniment By Entering Chords (Chord Sequencer).....	124
Inputting Chords without Playing the Keyboard.....	125
Editing Songs.....	125
Basic Operation of the Editing Functions.....	125
Undoing Edits (Undo).....	126
Copying Measures (Copy).....	126
Copying Rhythm Patterns to Create Rhythm Parts.....	127
Correcting Timing Discrepancies (Quantize).....	127
Deleting Measures (Delete).....	128
Inserting Blank Measures (Insert).....	128
Transposing Individual Parts (Transpose).....	129
Making Measures Blank (Erase).....	129
Exchanging Parts (Part Exchange).....	130
Correcting Notes One by One (Note Edit).....	130
Modifying the Tone Changes in a Song (PC Edit).....	131
Changing the Beat in the Middle of a Song (Beat Map).....	131
Changing the Tempo of Recorded Songs.....	132
Changing the Tempo Within the Song.....	132
Adjusting the Tempo While Listening to a Song.....	132
Adjusting the Tempo at a Particular Measure.....	133



**Chapter 7 Creating Music Styles .....134**

Creating Original Styles (User Styles).....134

    Creating New Styles by Combining Internal Music Styles  
    (Style Composer) (KR-7) .....134

    Creating a Style from a Song You Composed Yourself  
    (Style Converter) .....136

Saving a User Style.....139

    Deleting Saved User Styles .....140

Copying Styles on Disks to the User Memory (KR-7) .....141

    Copying Styles Saved in the User Memory to Disks (KR-7) .....141

**Chapter 8 Various Settings .....142**

Changing the Settings for One-Touch Piano.....142

    Procedure .....142

    Adjusting Resonance (Resonance).....142

    Changing the Tuning (Tuning) .....143

    Changing How Rapidly Sounds Are Expressed According to  
    the Force Used to Play the Keys (Hammer Response)  
    (KR-7) .....144

    Adjusting the Resonant Sounds (String Resonance)  
    (KR-7) .....144

    Adjusting the Keyboard Touch (Key Touch) .....145

Changing the Settings for One-Touch Arranger .....145

    Procedure .....145

    Changing the Keyboard’s Split Point (Split Point).....146

    Changing Music Styles Without Changing the Tone or Tempo  
    (One Touch Setting) .....146

    Assigning Functions to Pedals and Performance Pads  
    (Pedal Setting/User Functions) .....147

    Changing the Bend Range (Pedal Setting) .....149

    Changing How Chords Are Played and Specified  
    (Arranger Config) .....150

    Placing a Marker in the Middle of a Measure.....150

Changing the Settings for the Count-In and Countdown.....151

    Settings for the Count-In.....151

    Settings for the Countdown .....151

Other Settings .....152

    Procedure .....152

    Changing Standard Pitch (Master Tune).....152

    Changing the Language (Language).....152

    Changing the Screen Message When the Power Is Turned On  
    (Opening Message) .....153

    Changing the Settings for Showing Images with the External  
    Display (External Display) (KR-7) .....153

    Selecting Images To Be Shown on the KR-7 and External  
    Displays (User Image Display) (KR-7) .....154

    Turning Off the Beat Indicator (Beat Indicator) .....155

    Remembering the Settings Even When the Power is Turned  
    Off (Memory Backup).....155

    Restoring the Factory Settings (Factory Reset) .....155

    Calibrating the Touch Screen (Touch Screen) .....156

    Clearing the “Favorites” (KR-5).....156

    Formatting the User Memory (KR-7) .....156

    Automatically Starting the Quick Tour .....157

    Disabling Functions Other Than Piano Performance  
    (Panel Lock).....157

**Chapter 9 Connecting External Devices ..... 158**

Connecting MIDI Devices .....158

    Connectors .....158

    Making the Connections .....159

Performing in Ensemble with MIDI Instruments  
(MIDI Ensemble) .....159

MIDI Settings .....160

    Selecting the Transmit Channel (Tx Channel) .....160

    Disconnecting the Internal Sound Generator and Keyboard  
    (Local Control).....160

    Sending Tone Change Messages (Program Change/Bank  
    Select MSB/Bank Select LSB) .....161

    Sending Recorded Performance Data to a MIDI Device  
    (Composer MIDI Out) .....161

Connecting to Audio Equipment.....162

    Connectors .....162

    Making the Connections .....162

Connecting a Computer .....163

    Connect to the MIDI Connectors .....163

    Connect to the Computer Connector .....163

    Connectors .....163

    Making the Connections .....163

**Appendices ..... 166**

Troubleshooting .....166

Error Messages .....169

Tone List (KR-7).....170

Tone List (KR-5).....172

Drum Set List .....174

SFX Set List.....178

Effects List .....179

Music Style List (KR-7) .....180

Music Style List (KR-5) .....181

Chord List.....182

Internal Song List .....184

Rhythm Pattern List.....187

Parameters Stored to Internal Memory.....188

Music Files That the KR-7/5 Can Use .....189

    The KR-7/5 allows you to use the following music files ..189

    About the KR-7/5 Sound Generator .....189

MIDI Implementation Chart.....190

Main Specifications .....191

**Index ..... 193**

# Before You Start Playing

## Connect the Pedal Cable

Insert the pedal cable into the Pedal connector on the rear panel of the KR-7/5.

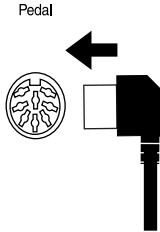

## Connect the Speaker Cable (KR-7)

As shown in the diagram, connect the speaker cable leading from the speaker box of the stand to the speaker connector located on the rear panel of the KR-7.

Push the speaker cable in until it clicks into position.

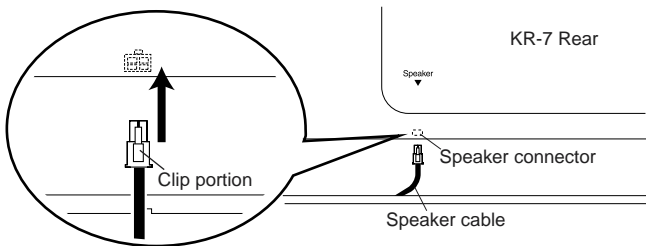

**NOTE**

Do not place containers holding liquids (such as flower vases), insecticide, perfume, alcohol, or similar substances on top of this piano.

The speakers of this piano are mounted beneath the upper surface, and face upwards. Malfunctions or accidents may occur if liquids contact any part of the speakers.

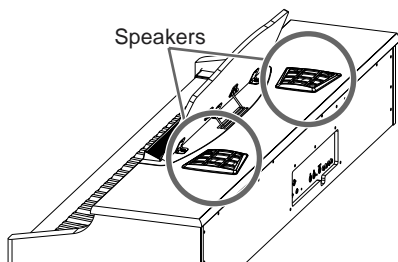

## Connect the Power Cord

Insert the included power cable into the AC inlet on the bottom panel of the KR-7/5, and then plug it into an electrical outlet.

**NOTE**

Be sure to use the supplied power cord.

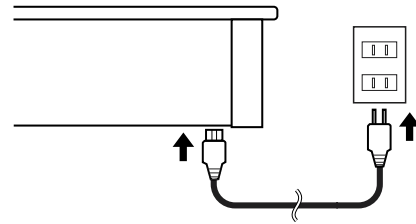

## Setting Up the Music Stand (KR-5)

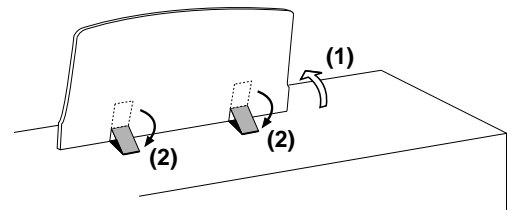

1. Gently raise the music stand, then secure it in place as shown in the figure.
2. To collapse the stand, fold in the metal fittings while supporting the stand with both hands and gently fold down the stand.

**NOTE**

Do not apply excessive force to the music stand.

## Setting Up the Music Stand (KR-7)

1. Grasping the music stand with both hands, lift it toward you until its in the upright position.
2. Use the support on the back of the music stand to keep the stand in place.

The angle of the music stand can be set to any of three positions.

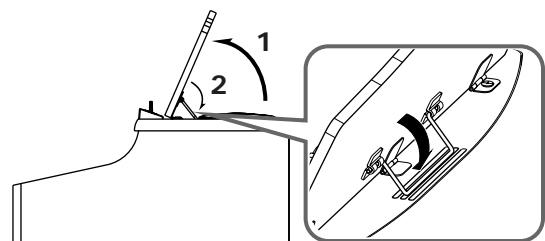

## ■ Adjusting the Position of the Music Stand

Grasp the music stand with both hands, and pull it toward yourself to adjust the position.

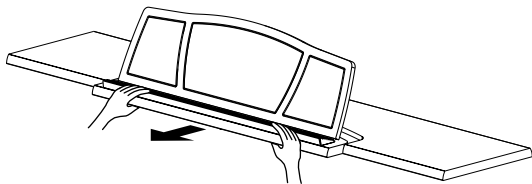

## ■ Folding Down the Music Stand

1. Grasp the music stand with both hands, and gently push it in until it stops.
2. Raise the support located on the back of the music stand, then gently fold down the music stand.

## ■ Using the Music Holders

You can use the holders to hold pages in place. When not using the holders, leave them folded down.

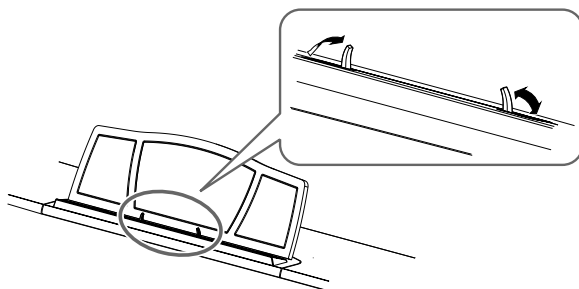

## ■ Removing the Music Stand

You can remove the music stand from the piano. This allows you to place a notebook computer on the piano.

**Position the music stand so it's upright, then remove the three screws, as shown.**

You can remove the screws using a coin.

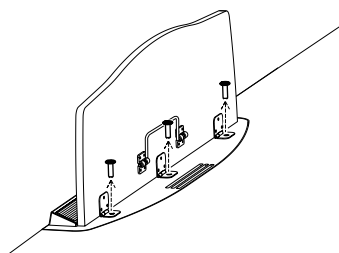

### NOTE

Be careful not to lose the screws that you removed from the music stand, or put them where they might be swallowed by small children.

## Opening/Closing the Lid

To open the lid, use both hands to lift it lightly, and slide it away from yourself.

To close the lid, pull it gently toward yourself, and lower it softly after it has been fully extended.

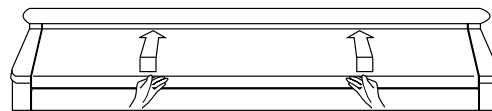

### NOTE

When opening and closing the lid, be careful not to let your fingers get caught. If small children will be using the KR-7/5, adult supervision should be provided.

### NOTE

If you need to move the piano, make sure the lid is closed first to prevent accidents.

## Turning the Power On and Off

### NOTE

Turn on power to your various devices in the order specified. By turning on devices in the wrong order, you risk causing malfunction and/or damage to speakers and other devices.

**To turn the power on, turn the [Volume] knob all the way down, and then press the [Power] switch.**

The power will turn on, and the Power indicator at the left front of the KR-7/5 will light.

After a few seconds, you will be able to play the keyboard to produce sound.

Use the [Volume] knob to adjust the volume.

### NOTE

This unit is equipped with a protection circuit. A brief interval (a few seconds) after power up is required before the unit will operate normally.

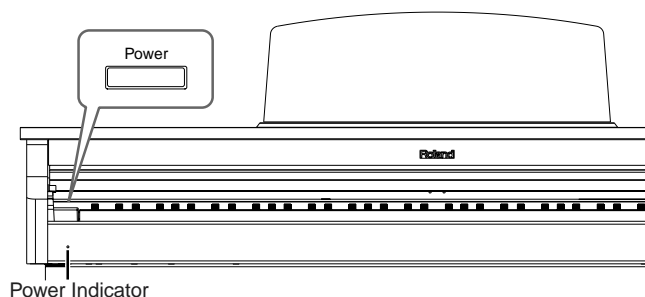

**To turn the power off, turn the [Volume] knob all the way to the left, and press the [Power] switch.**

The Power indicator at the left front of the KR-7/5 will go dark, and the power will be turned off.

## Before You Start Playing

### About the Pedals

The pedals have the following functions, and are used mainly for piano performance.

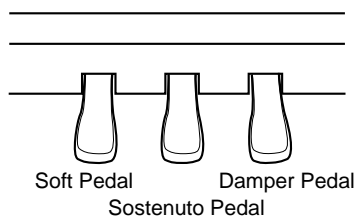

#### Damper pedal (right pedal)

While this pedal is pressed, notes will be sustained even after you take your fingers off the keys.

On an acoustic piano, holding down the damper pedal will allow the remaining strings to resonate in sympathy with the sounds that you played from the keyboard, adding a rich resonance.

The KR-7/5 simulates this sympathetic resonance.



You can change the amount of resonance applied with the damper pedal. Please refer to "Adjusting Resonance (Resonance)" (p. 142).

#### Sostenuto pedal (center pedal)

This pedal sustains only the sounds of the keys that were already played when you pressed the pedal.

#### Soft pedal (left pedal)

When you hold down this pedal and play the keyboard, the sound will have a softer tone.

### About the Adjuster

When you move the KR-7/5 or if you feel that the pedals are unstable, adjust the adjuster located below the pedals as follows.

- Rotate the adjuster to lower it so that it is in firm contact with the floor. If there is a gap between the pedals and the floor, the pedals may be damaged. In particular when placing the instrument on carpet, adjust this so that the pedals firmly contact the floor.

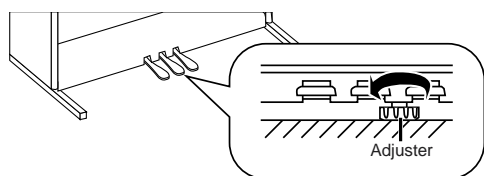

### Adjusting the Sound's Volume and Brilliance

Turn the [Volume] knob to adjust the overall volume.

Turn the [Brilliance] knob to adjust the brightness of the sound.



### Connecting Headphones

The KR-7/5 has two jacks for plugging in headphones. This allows two people to listen through headphones simultaneously, making it very useful for lessons and when performing piano pieces for four hands. Additionally, this allows you to play without having to worry about bothering others around you, even at night.

**Plug the headphones into the Phones jack located at the bottom left of the piano.**

Connecting headphones will automatically mute the sound from the internal speakers.

The headphone volume is adjusted by the [Volume] knob of the KR-7/5.

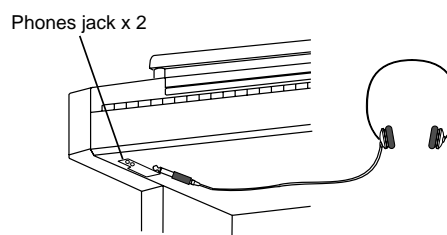

#### NOTE

Use Stereo headphones.

#### Some Notes on Using Headphones

- To prevent damage to the cord, handle the headphones only by the headset or the plug.
- Connecting the headphones when the volume of connected equipment is turned up may result in damage to the headphones. Lower the volume on the KR-7/5 before plugging in the headphones.
- Listening at excessively high volume levels will not only damage the headphones, but may also cause hearing loss. Use the headphones at a moderate volume level.

## Connecting a Microphone

You can connect a microphone into the Mic In jack, and enjoy karaoke with the KR-7/5.

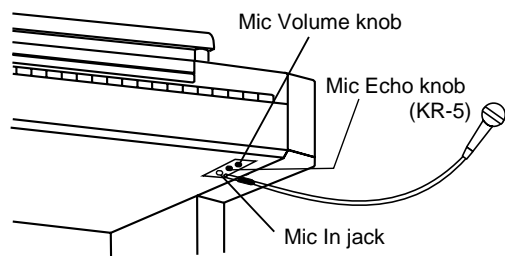

1. Connect a microphone (sold separately) to the Mic In jack on the lower-right area of the instrument.
2. Rotate the [Mic Volume] knob in front of the Mic In jack to adjust the volume level for the microphone.
3. Rotate the [Mic Echo] knob to adjust the echo level (KR-5).

The KR-7 does not feature an [Mic Echo] knob. When you want to adjust the mic echo on the KR-7, refer to “Adjusting the Echo (Echo)” (p. 38).

### Some Notes on Using a Microphone

- Be careful of high volume levels when using mikes late at night or early in the morning.
- When connecting a microphone to the KR-7, be sure to lower the volume. If the volume control is too high when the microphone is plugged in, noise may be produced by the speakers.
- Howling could be produced depending on the location of microphones relative to speakers. This can be remedied by:
  - Changing the orientation of the microphone.
  - Relocating microphone at a greater distance from speakers.
  - Lowering volume levels.

## Connecting an External Display (KR-7)

You can connect a computer monitor or other such external display to the instrument, and display scores and lyrics on the larger screen, and display whatever images as you like.

For more about the external display settings, refer to “Changing the Settings for Showing Images with the External Display (External Display) (KR-7)” (p. 153). For more on displaying images, refer to “Selecting Images To Be Shown on the KR-7 and External Displays (User Image Display) (KR-7)” (p. 154).

### Displays That Can Be Connected to This Instrument

In general, a great many of the VGA monitors and multiscan monitors that are available on the market are compatible with this instrument. However, before you connect any monitor, make sure it meets the following specifications:

- |                             |                          |
|-----------------------------|--------------------------|
| • Resolution                | 640 x 480 pixels         |
| • Horizontal scan frequency | 31.5 kHz                 |
| • Vertical scan frequency   | 60 Hz                    |
| • Connector                 | 3-row, 15-pin D-Sub type |
| • Signal                    | Analog                   |

**NOTE**

Confirm that the display to be used is compatible with the frequencies mentioned above. Using a display that is not compatible with the above frequencies may result in incorrect image output when images move, and in certain cases may even damage the display.

## ■ Making the Connections

**NOTE**

To prevent malfunction and/or damage to speakers or other devices, always turn down the volume, and turn off the power on all devices before making any connections.

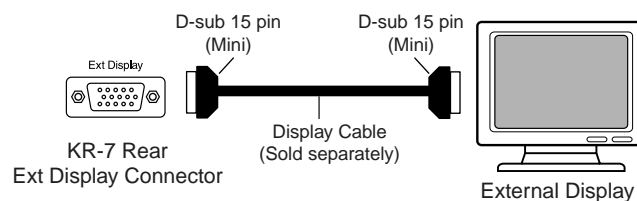

1. Turn off the power to the KR-7 and the display to be connected.
2. Use display cable (sold separately) to connect the display to the Ext Display connector on the KR-7.
3. Switch on the KR-7.
4. Switch on the connected display.

## Before You Start Playing

### MEMO

For more on handling the external display, refer to your display's owner's manual.

### MEMO

You can also remove the music stand, then place the display there so that it faces forward. For instructions on removing the music stand, refer to "Removing the Music Stand" (p. 19).

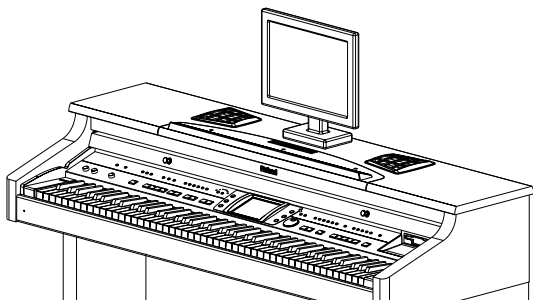

When using the KR-7 with a display placed on it, be sure to note the following precautions.

- Make sure the display sits stably on the KR-7 before use.
- Do not let the base of the display rest on any of the music stand's moving parts. Keep the base of the display within one of the areas shown by the dotted lines in the illustration below.

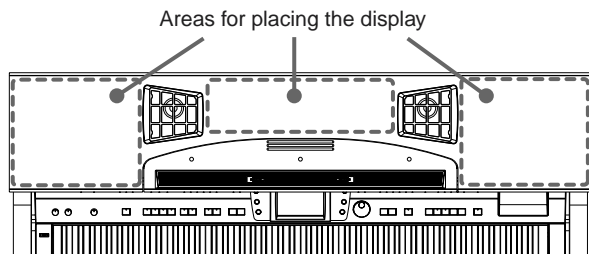

- If you are placing the display on top of the KR, we recommend using a liquid crystal display (LCD). If using a cathode ray tube (CRT) display, take extra care to ensure that the display rests stably on the instrument.

### Turning the Power Off

After use, turn off the power using the following procedure.

1. Turn the volume all the way down on the KR-7.
2. Turn off the KR-7.
3. Turn off the connected display.

## About the Touch Screen

The KR-7/5 makes use of a touch screen.

This lets you carry out a wide variety of actions just by touching the screen lightly.

### NOTE

The touch screen is operated by touching it lightly with your finger. Pressing hard, or using a hard object can damage the touch screen. Be careful not to press too hard, and be sure to use only your fingers to operate the touch screen.

### NOTE

The positioning of the touch screen may become displaced due to changes in the surrounding environment and over time. If this happens, follow the steps in "Calibrating the Touch Screen (Touch Screen)" (p. 156) to correct the pointer position.

### NOTE

Do not place items on the touch screen.

## ■ Adjusting the Contrast of the Screen

To adjust the contrast of the screen, turn the Contrast knob located at the right side of the screen.

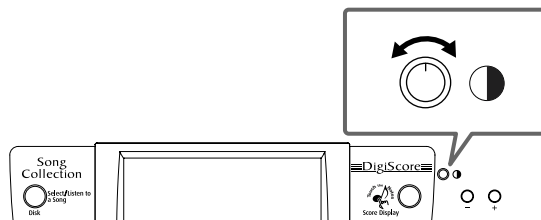

## Main Screens

### ■ Piano Screen

Immediately after the power is turned on, the Piano screen like the one below is displayed. For details, refer to p. 24.

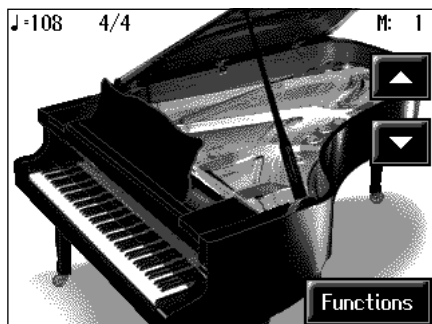

### ■ Basic Screen

The following screen is called Basic screen.

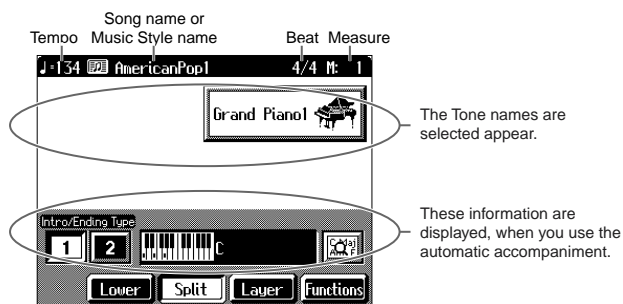

You can usually display this screen by touching <Exit> several times.

Follow either of the procedures described below to display it.

- Press the One Touch Program [Arranger] button.  
The Basic screen appears and the settings are made for automatic accompaniment.
- Press the One Touch Program [Piano] button, then press one of the Tone buttons, then touch <Exit>.

### ■ Using the Main Icons

With the KR-7/5, you can many other screens besides the Basic screen to do things. The on-screen graphics that appear three dimensional work like buttons. These are called "Icons."

The main icons you can use on these screens are as follows.

	<p>Some screens consist on two or more pages. You can display the next page or the previous page of the screen by touching these icons.</p>
	<p>Touch this to cancel the currently editing setting or exit the screen that is currently displayed. You can usually display the Basic screen by touching &lt;Exit&gt; several times.</p>
	<p>When you select an internal song or music files that includes the lyrics data, this icon appears in the Piano screen or Basic screen. Touch this to display the lyrics.</p>

**NOTE**

The explanations in this manual include illustrations that depict what should typically be shown by the display. Note, however, that your unit may incorporate a newer, enhanced version of the system (e.g., includes newer sounds), so what you actually see in the display may not always match what appears in the manual.



# Chapter 1 Performance

## Playing the Keyboard Like a Piano (One-Touch Piano)

You can create the optimal settings for a piano performance with the press of a single button.

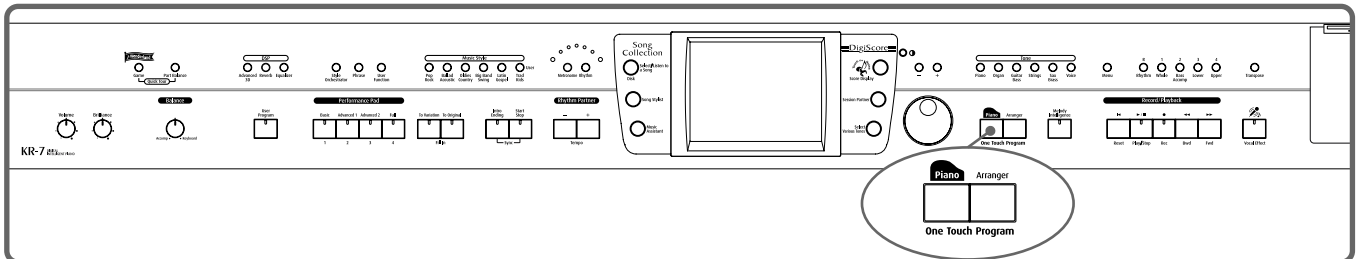

### 1. Press the One Touch Program [Piano] button.

A “Piano screen” like the one shown below will appear.

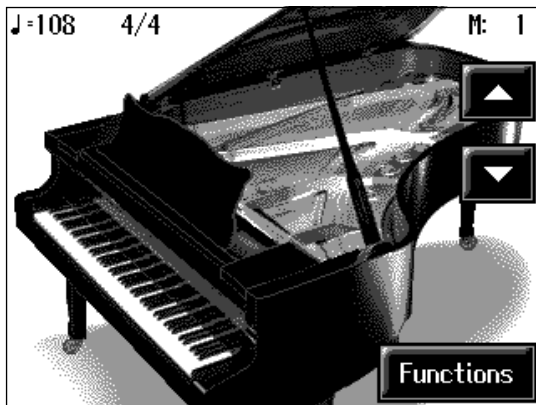

When you press the One Touch Program [Piano] button, the KR-7/5 will switch to the following settings, regardless of the current panel settings.

- If the keyboard has been split into upper and lower sections (p. 29), the keyboard returns to a single section.
- The pedals return to their usual functions (p. 20).
- The Grand Piano sound is automatically selected.
- The effect is automatically set to “Sympathetic Resonance” (p. 36).

### Changing the Piano Sound

Touch the piano lid on the screen, and listen to the tone change as you slide your

finger or touch  or  to open and close the lid.

This simulates the actual changes in sound that occur when the lid of a grand piano is set at different heights.

#### MEMO

Since this instrument faithfully reproduces real acoustic piano action and response, keys played in the top one-and-one-half-octave range continue to resonate, regardless of the damper pedal action, and the tone in this range is audibly different. The Key Transpose setting (p. 90) can also be used to change the range that is unaffected by the damper pedal.

#### MEMO

You can change the piano performance settings by touching <Functions> on the screen. For more information, take a look at “Changing the Settings for One-Touch Piano” (p. 142).

#### MEMO

When you select an internal song or music file that includes the lyrics data, <lyrics> appears in the Piano screen or Basic screen. Touch this to display the lyrics.



## Performing with a Variety of Tones (Tone Buttons)

The KR-7/5 comes with a many built-in instrument sounds and effects. This lets you enjoy perform in a wide range of musical styles.

The built-in sounds are called “Tones.” The sounds are organized into six tone groups, which are assigned to the [Tone] buttons.



For more about the names of Tones, take a look at the “Tone List” (p. 170, p. 172).

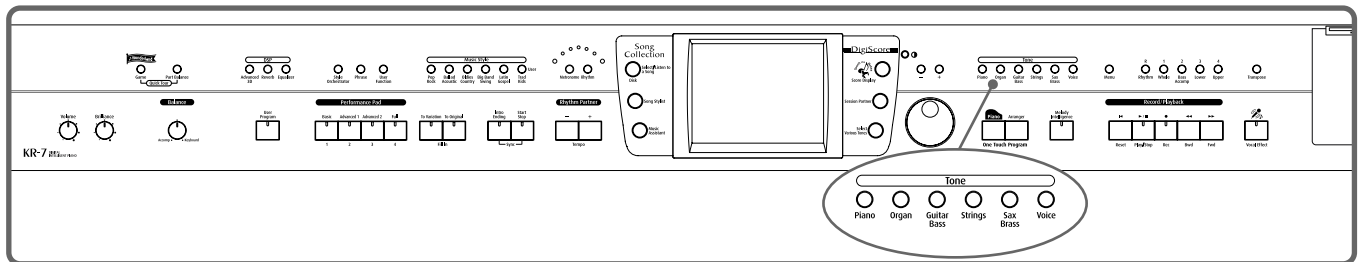

### 1. Press any one of the Tone buttons to select a tone group.

You'll see that button's indicator light up.

The screen displays the tone names included in the tone group you've selected.



This screen is called the “Tone selection screen.”

You can touch <Audition> for an audio demonstration of a particular tone.

Touch to switch the screen and display the next selection.

You can touch <Effects> to add effect sounds to a variety of tones (p. 36).

You can touch <Search> to find tones according to the search criteria you specify (p. 27).

### 2. Select a tone, then touch the tone name.

You'll hear the tone you've selected when you play the keyboard.

You can use the [-] [+] buttons and the dial to automatically switch pages and select tones.

### 3. Touch <Exit>.

This returns you to the Basic screen or the previous screen.

## ■ Playing Percussion Instruments or Sound Effects

You can use the keyboard to play percussion sounds or effects like sirens and animal sounds.

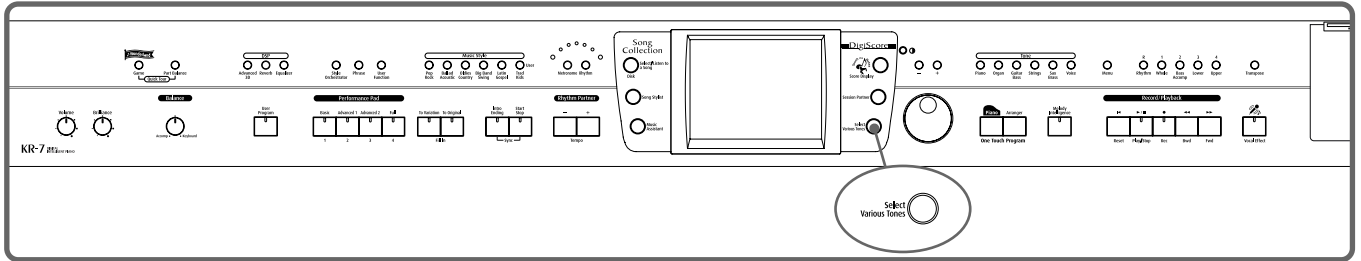

1. Press the [Select Various Tones] button and watch the indicator light up.
2. Touch <Drums> or <SFX>.

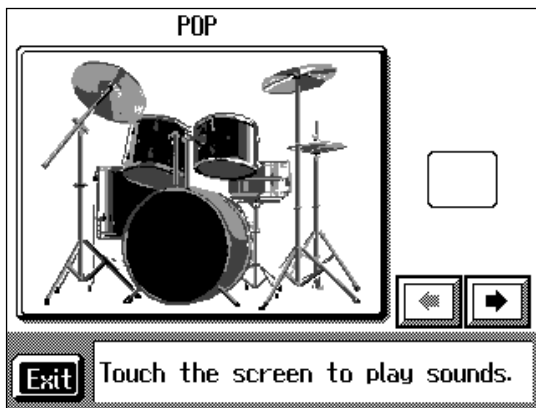

Each note of the keyboard will play a different sound.  
You can also have play sounds by touching the screen.

3. Touch <Exit> several times.  
This returns you to the Basic screen or the previous screen.

### MEMO

The combination of sounds assigned to the keyboard varies according to the drum set. Take a look at the “Drum Set List” (p. 174) and “SFX Set List” (p. 178).

## ■ Using Keywords to Search for Tones (Tone Search)

You can search for tones that match the conditions you set for instrument or musical style. You can also search the tones using the first character of the tone name.

### 1. Press any Tone button.

The tone selection screen appears.

### 2. Touch <Search>.

The following “Tone search screen” appears.

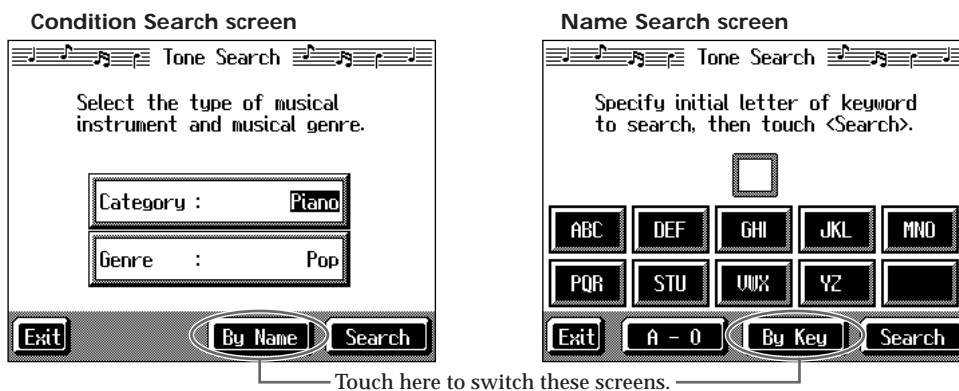

### Searching by Conditions

### 3. Touch <Category> or <Genre>, then use the [-] [+] buttons and the dial to select the search conditions.

### 4. Touch <Search>.

The search results appear in the display.

Touch the tone name to select the tone.

Touch <Exit> to return to the tone search screen.

### Searching by Tone Name

### 3 Touch <By Name>.

Touch <By Key> to go to the condition search screen.

### 4. Decide which character is to be used for the search.

Enter the character you're searching for. For example, touching <ABC> in succession cycles you through the available choices in that character group ("A" → "B" → "C"...).

Touching <A-0> selects the type of character. Each time you touch <A-0>, the character switches between alphabets and numerals.

The selected character appears in the middle of the screen.

### 5. Touch <Search>.

The search results appear in the display.

Touch the tone name to select the Tone.

Touch <Exit> several times to return to the Basic screen or the previous screen.



In condition search, tones satisfying all of the selected search criteria are sought.

## Performing with Two Sounds Layered Together (Layer)

Two tones sounding together when you press a single key is referred to as a “layer performance.”

For instance, it’s possible to play the Tones for both Piano and Strings simultaneously.

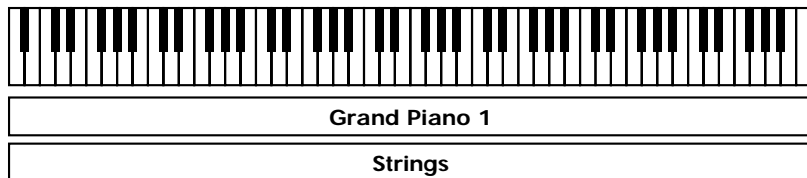

1. Touch <Layer> at the bottom of the Basic screen.



The tone that was sounding before you switched to layer performance, plus the tone indicated in the lower part of the display, are now played together.

Here, the tone appearing in the upper part of the display is called the “right-hand tone,” and the tone appearing in the lower part of the display is called the “layer tone.”

### Changing the tones

2. Touch the name of the tone to be changed.  
The tone name will be highlighted in white.
3. Press a Tone button to select the new tone (p. 25).
4. When you have selected the tone, touch <Exit>.

The display returns to the Basic screen.

### Cancelling the Layer

5. Touch <Layer>.

The <Layer> icon reverts to black, and the layer performance is cancelled.

Now when you play the keys, only the tone indicated on the screen is sounded.



When you select an internal song or music file that includes the lyrics data, <lyrics> appears in the Basic screen. Touch this to display the lyrics.



When you touch Octave <-><+> on the tone selection screen, the pitch of the keyboard’s sound is changed in octave units. To learn more, see “Shifting the Keyboard Pitch in Octave Steps (Octave Shift)” (p. 30).



You can vary the volume-level balance of the two tones. For instructions, see “Adjusting the Volume Balance for Each Performance Part (Part Balance)” (p. 67).

## Playing Different Tones with the Left and Right Hands (Split)

Dividing the keyboard into right-hand and left-hand areas, then playing different sounds in each section is called “split performance.” The boundary key is called the “split point.”

The split point key is included in the left-hand keyboard area. Each time power to the keyboard is turned on, the split point is reset to “F#3.”

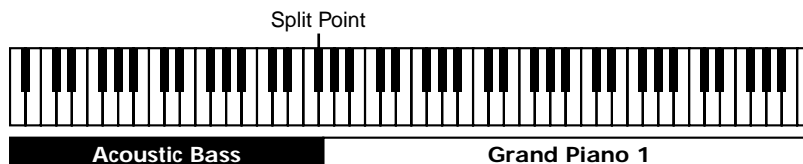

1. At the Basic screen, touch <Split>.



The tone sounding prior to the split performance is played in the right-hand section of the keyboard, and the tone indicated at the left of the screen is played in the left-hand section of the keyboard.

Here, the tone appearing at the right part of the display is called the “right-hand tone,” and the tone appearing at the left part of the display is called the “left-hand tone.”

### Changing the Tones

2. Touch the name of the tone to be changed.  
The tone name will be highlighted in white.
3. Press a Tone button to select the tone (p. 25).
4. When you have selected the tone, touch <Exit>.

The display returns to the Basic screen.

### Cancelling the Split

5. Touch <Split>.

The <Split> icon reverts to black, and the split performance is cancelled.

When you play the keys, only the tone indicated on the screen is sounded.



You can change the split point; refer to “Changing the Keyboard’s Split Point (Split Point)” (p. 146).



When you select an internal song or music file that includes the lyrics data, <lyrics> appears in the Basic screen. Touch this to display the lyrics.



When you touch Octave <-><+> in the tone selection screen, the pitch of the keyboard’s sound is changed in octave units. To learn more, see “Shifting the Keyboard Pitch in Octave Steps (Octave Shift)” (p. 30).



You can change the volume balance between the left- and right-hand parts of the keyboard; refer to “Adjusting the Volume Balance for Each Performance Part (Part Balance)” (p. 67).

### Turning On Layer and Split Performance Simultaneously

Turning on both layer performance and split performance allows you to split the keyboard into two sections while playing two layered Tones in the right-hand part.



**MEMO**

When the keyboard has been divided into upper and lower sections, the damper pedal is applied to only the upper section. If you want to add lingering reverberations to the notes of the lower section, see “Assigning Functions to Pedals and Performance Pads (Pedal Setting/User Functions)” (p. 147).

### ■ Shifting the Keyboard Pitch in Octave Steps (Octave Shift)

When using layer performance (p. 28) or split performance (p. 29), you can change the pitch of the keyboard’s sound in octave units. This function is called “Octave Shift.”

For example, when using a layer performance, you can change the pitch of each sound and layer the sounds. You can make the pitch of the keyboard’s left-hand part match the pitch of the right-hand part during split performance.

**MEMO**

You cannot use Octave Shift when using a single tone for the entire keyboard or in the right-hand Tone during layer performances.

1. On the Basic screen, touch <Layer> or <Split>.
 

The KR-7/5 switches to layer performance or split performance.
2. To apply Octave Shift, touch the name of the tone you’ve selected.
3. Press the Tone button to display the Tone selection screen.



4. Touch Octave <-> or <+> in the lower part of the screen to adjust the pitch of the sound.

Each time you touch <+>, the pitch is raised one octave.

Each time you touch <->, the pitch is lowered one octave.

The sound can be changed from two octaves lower than the original sound (-2) to two octaves above the original (+2).

Touch <Exit> to return to the Basic screen or the previous screen.

# Adding Reverberation to the Sound (Reverb)

Apply a reverb effect to the notes you play with the KR-7/5.  
 Reverb makes it sound as if you are playing in a concert hall.

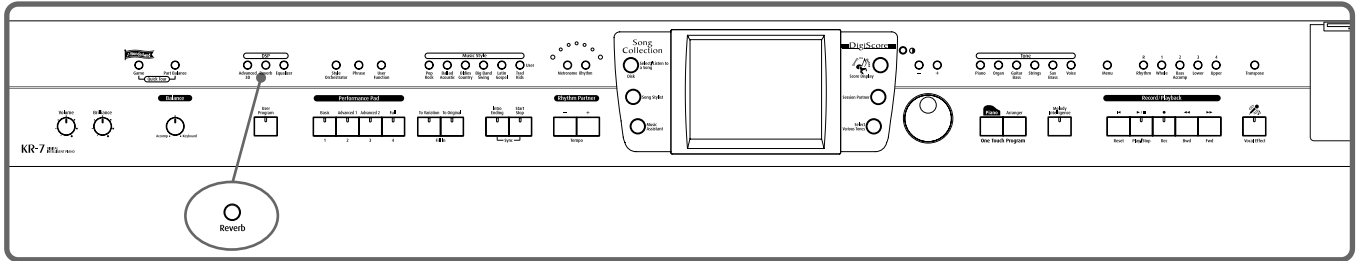

## 1. Press the [Reverb] button and watch the its indicator light up.

A “Reverb screen” like the one shown below appears.

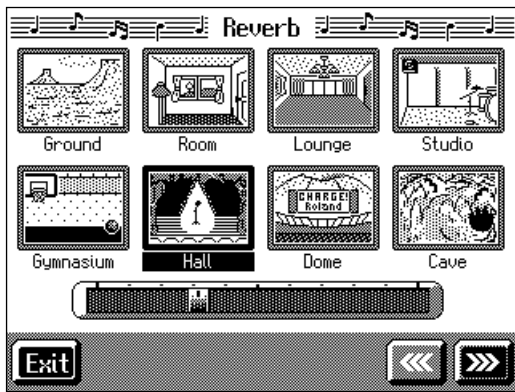

Display of the KR-7

## 2. Touch an icon to select the performance space.

Display	Explanation
Ground	Wide open space with no reverberations.
Room	Small room
Lounge	Larger room
Studio	A recording studio
Gymnasium	In a gymnasium
Hall	Large concert hall reverberation
Dome	A domed ballpark
Cave	Adds the extended reverberations found inside a cave
GS Room 1	Reproduces an indoor-type reverb. Provides a clear, expansive reverberation.
GS Room 2	
GS Room 3	
GS Hall 1	Reproduces the reverberation found in a hall. Gives reverberation with a greater sense of depth than GS Room.
GS Hall 2	
GS Plate	Reproduces a plate echo (reverberation created using the vibrations of a metal plate).
GS Delay	A delayed sound that is added to the original, similar to the reflected sounds of mountain echoes.
GS Pan Delay	The reflected sounds are panned (shifted) laterally.

**3. Touch the slider beneath the icons to adjust the effect selected.**

Touch and slide the knob on the screen to the right for a deeper reverb, and to the left for less.

You can also move the slider with the [-] [+] buttons and the dial.

Pressing the [-] [+] buttons simultaneously returns the slider to the initial value.

When you touch <Exit>, the reverb effect is activated, and you return to the previous screen.

**MEMO**

No effect is applied when the slider is moved all the way to the left. In this case, the button's indicator won't light up when you press the [Reverb] button.

**Cancelling the Effect**

**4. Press the [Reverb] button, and watch the indicator light go out.**

The reverb effect is eliminated.

**■ Adding Three-Dimensional Breadth to the Sounds You Play (Advanced 3D) (KR-7)**

You can add three-dimensional breadth to the sounds you play with automatic accompaniment (p. 50), or to internal songs or music files. With this effect, called "Advanced 3D," you seem to be surrounded by the sound of the performance.

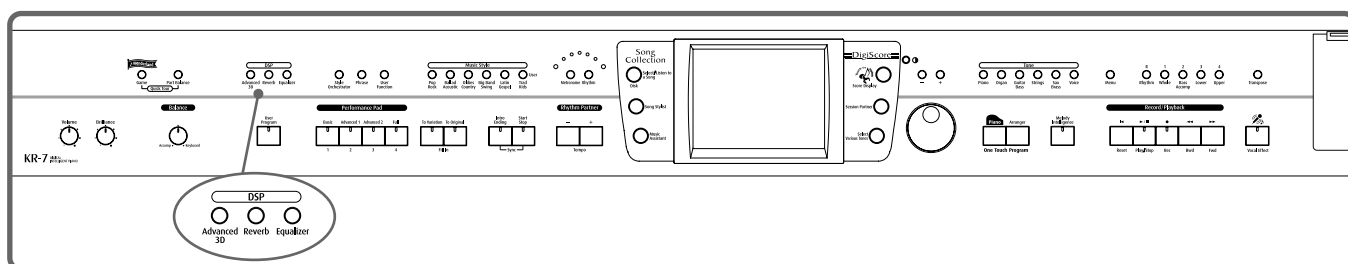

**1. Press the [Advanced 3D] button and watch the indicator light up.**

The following "Advanced 3D screen" appears.

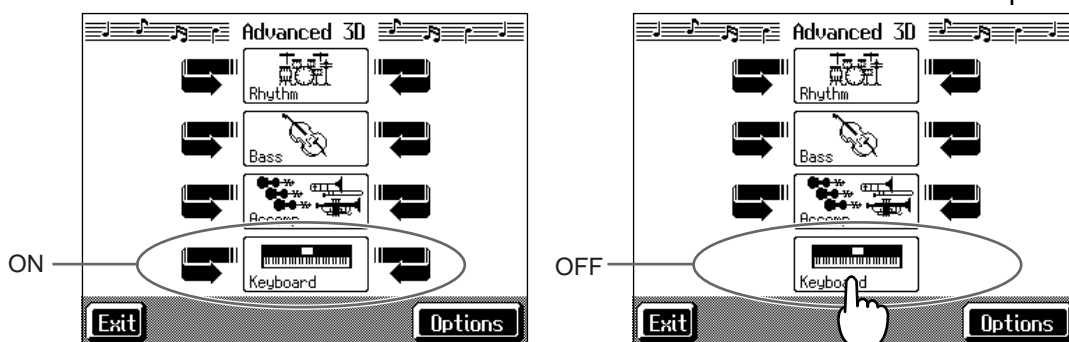

**2. Touch the icon to switch the effect on or off for each individual part.**

Three-dimensional breadth is added to the performance part you've selected.

When you touch <Exit>, the Advanced 3D effect is activated, and you return to the previous screen.

**MEMO**

If all of the parts are switched off, the [Advanced 3D] button's indicator won't light up when you press the button.

**Cancelling the Effect**

**3. Press the [Advanced 3D] button and watch the indicator goes out.**

The Advanced 3D effect is eliminated, and the effect is no longer applied to any of the parts.



## ○ Selecting the tone to which the effect is applied

With “Keyboard” in Advanced 3D set to On, you can select the parts to which the 3D effect is to be applied when the keyboard is played.

1. Press the [Advanced 3D] button and watch the indicator light up.
2. On the Advanced 3D screen, touch <Option>.

A screen like the one shown below appears.

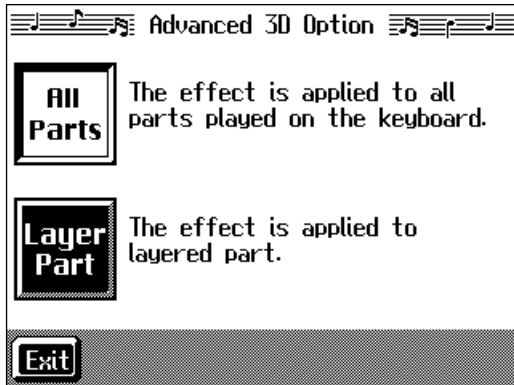

3. Touch <All Parts> or <Layer Part>.

Display	Explanation
All Parts	The effect is applied to all tones played with the keyboard (the left-hand tone, right-hand tone, and layer tone).
Layer Part	The effect is applied only to the layer part. When not using a layer performance (p. 28), the Advanced 3D effect is not applied to the keyboard performance, even if <Keyboard> on the Advance 3D screen is set to On.

When you touch <Exit>, you return to the Advanced 3D screen.

## ■ Adjusting the Sound to Achieve the Preferred Tone Quality (Equalizer) (KR-7)

The KR-7 features a built-in, five-band digital equalizer.

An equalizer boosts or cuts specific sound pitches (frequency ranges) to adjust the sound balance for the overall performance. For example, you can boost the highs to get a crisper sound, or boost the low end for a more powerful sound.

You can also adjust the sound to compensate for the acoustical characteristics of the performance space.

If raising the slider for each frequency ends up distorting the sound, you can correct the distortion with the Master Level slider.

### 1. Press the [Equalizer] button.

The “Equalizer screen” appears.

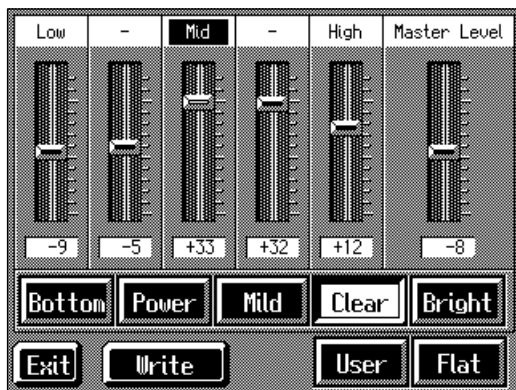

### 2. Touch the Type icon to make your selection.

Display	Explanation
Bottom	This setting greatly boosts the low end.
Power	Boosts both the low- and high-frequency ranges.
Mild	Lows and highs are restrained for a pleasant-sounding tone.
Clear	This setting slightly boosts the midrange for a simple pop feeling.
Bright	This setting boosts the high frequencies for a brilliant, sparkling sound.
Flat	All slider values are set to “0.”
User	Store your own preferred settings (p. 35).

### 3. Touch the slider to make adjustment.

Displayed	Settings Value	Description
Low	-60-0-60	Low-frequency range. This is the range of frequencies for instruments like drums, bass, organ, guitar and strings.
-	-60-0-60	Mid-low-frequency range. This is the range of frequencies for lower brass and woodwind instruments.



When <Flat> is selected (when all sliders are at “0”), then even when [Equalizer] is pressed, the indicator does not light up.

Displayed	Settings Value	Description
<b>Mid</b>	-60-0-60	Midrange. This is the range of frequencies where most instrument sounds are concentrated.
-	-60-0-60	Mid-high-frequency range. The ear is most sensitive to this frequency range.
<b>High</b>	-60-0-60	High-frequency range. These frequencies add brilliance to the sound.
<b>Master Level</b>	-60-0-60	You can temper the distortion in the sound by lowering the level. Raising the level too much may cause the sound to become distorted.

You can also move the slider with the [-] [+] buttons and the dial.

Pressing the [-] [+] buttons simultaneously returns the slider to “0.”

When you touch <Exit>, the equalization is placed in effect, and you return to the previous screen.

### Cancelling the effect

#### 4. Press the [Equalizer] button and watch the indicator light go out.

The equalizer effect is cancelled.

### ○ Storing the settings

You can store adjusted equalizer settings to <User>.

Even after editing the settings, you can touch <User> to call up your preferred settings.

#### 1. Press the [Equalizer] button and watch the indicator light up.

The Equalizer screen appears.

#### 2. Adjust the equalizer.

#### 3. Touch <Write>.

The settings are stored.

Even after editing the settings, you can touch <User> to select the stored settings.

## Adding Effects to Each Tone and Voice

### ■ Applying Effects to the Sound (Effects)

You can apply a wide range of different effects to the notes you play on the keyboard.

#### 1. First, press the Tone button to select a Tone (p. 25).

The “Tone selection screen” appears.



#### 2. Then, touch <Effects>.

The “Effect screen” appears.

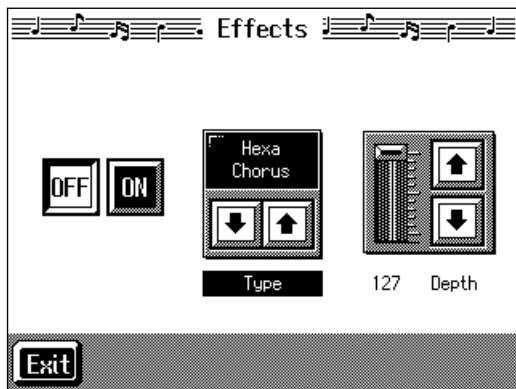

#### Applying effects to the sound

#### 3. Touch <ON>.

The effect selected with <Type> will be applied.

#### Setting the Effect

#### 4. Touch <Type> to select the type of effect.

#### 5. Touch <Depth> to adjust the amount of effect applied.

The amount increases as the value is raised.

You can also move the slider with the [-] [+] buttons and the dial.

Pressing the [-] [+] buttons simultaneously returns the slider to the initial value.

Touch <Exit> to return to the Tone selection screen.



For more on the effect types, refer to the “Effects List” (p. 179).

#### NOTE

Selecting a different effect for the left-hand Tone than the one applied to the right-hand Tone and Layer Tone may not result in the effect you want. Select the same effect as that used for the right-hand Tone.

#### NOTE

When you select an effect type that starts with “GS,” that type of effect is also applied for the chorus effect for the song or Music Style (p. 50) selected at that time.

**Cancelling the Effect**

- On the Effects screen, touch <Off>.

**About the Effect Settings**



When the effects is set to ON, the appropriate effect is applied for the currently selected sound. You can also apply different effect types to each tone (except GS tones and tones with the “” logo). Although turning off the power returns effects to their initial settings, carrying out Memory Backup (p. 155) allows you to save and store the settings even after the power is turned off.

**■ Adding Effects to Mic Vocals (Vocal Effect) (KR-7)**

With a microphone connected, you can add effects to the microphone vocals. Adding effects to the vocals is referred to as “Vocal Effect.”

**○ How to select Vocal Effect**

**MEMO**

All [Voice] button tones with a “GS” or “” logo appearing after the tone name have the same effect applied to them. If the effect for one of the tones with the “GS” or “” logo is changed, then the effects for the other tones with the “GS” or “” logo are also changed automatically.

**MEMO**

For details on connecting a microphone, refer to “Connecting a Microphone” (p. 21).

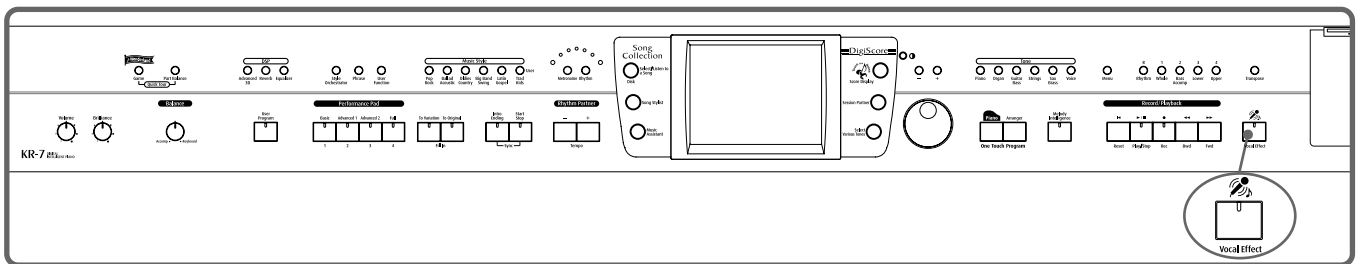

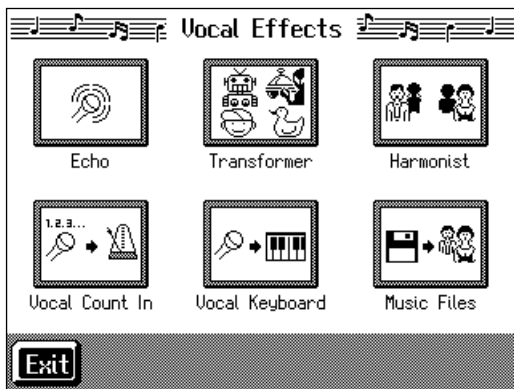

- Press the [Vocal Effect] button.

The “Vocal Effects screen” appears.



- Touch any one of the icons.

Icon	Description	Page
	Adjusts the microphone echo.	p. 38
	Alters the microphone vocals.	p. 39
	Adds harmonies to the original voice.	p. 40

Icon	Description	Page
Vocal Count In	Allows you to start songs and Automatic Accompaniment using your own tempo.	p. 41
Vocal Keyboard	Allows you to produce sounds conforming to the vocal scale.	p. 41
Music Files	You can play a specific part as harmony while playing back a song.	p. 42

- When you touch <Exit>, the effect is applied and you return to the previous screen.

**Cancelling the Vocal Effect**

- Press the [Vocal Effect] button and watch the indicator light go out.  
The Vocal Effect function is cancelled.

○ **Adjusting the Echo (Echo)**

- Touch <Echo> in Step 2 of “How to select Vocal Effect” (p. 37).

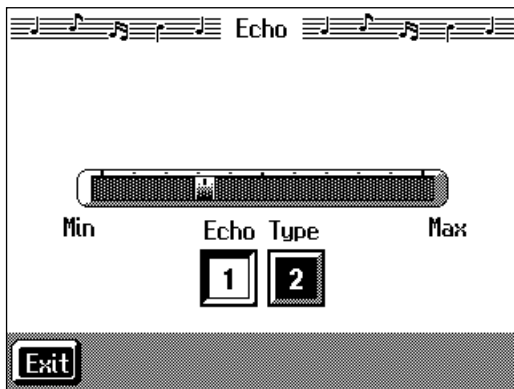

- Touch the bar graph to adjust the amount of echo applied to the vocal.
- Touch the Echo Type <1> or <2> to change the echo type.

Displayed	Description
1	Adds basic reverberations.
2	Adds reverberations for a karaoke-type echo.

Touch <Exit> to return to the Vocal Effects screen.

○ **Altering Vocals (Transformer)**

With the KR-7, you can modify the way your voice sounds through the microphone. This is called the “Voice Transformer” function.

**1. Touch <Transformer> in Step 2 of “How to select Vocal Effect” (p. 37).**

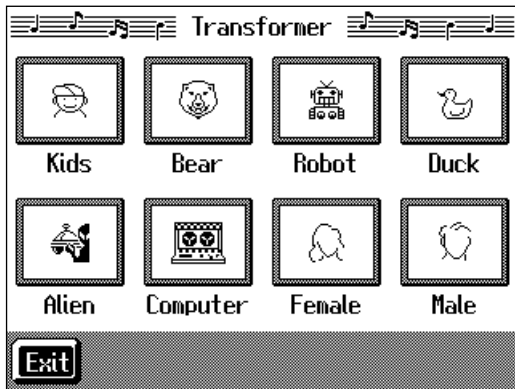

**2. Touch any one of the icons.**

Here's what the different icons do.

Display	Explanation
Child	Transforms the input into the sound of a child's voice.
Bear	Transforms the input sound into the voice of a large animal.
Robot	Transforms the input into the sound of a robot's voice.
Duck	Transforms the input into a duck's quacking sound.
Alien	Transforms the input into an alien voice.
Computer	Transforms the input into a voice like that from a computer.
Female	Transforms male voices into female voices.
Male	Transforms female voices into male voices.

**3. Sing through the microphone.**

Your voice is transformed according to the item you selected.

**Cancelling the Effect**

**4. Once again, touch the icon you selected in Step 2.**

The Voice Transformer effect is eliminated.

Touch <Exit> to return to the Vocal Effects screen.



When you use the Voice Transformer function, the resonance setting for the piano (see p. 142) may sometimes be reset.

## ○ Adding Harmonies (Harmonist)

You can sing with a harmony accompaniment, even when you're playing solo. This is called the "Harmonist" function.

### 1. Touch <Harmonist> in Step 2 of "How to select Vocal Effect" (p. 37).

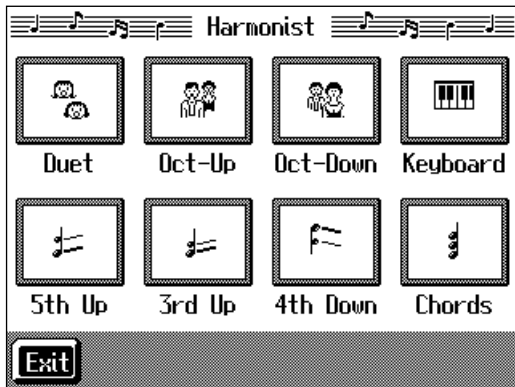

### 2. Touch any one of the icons.

Here's what the different icons do.

Display	Explanation
<b>Duet</b>	Provides an effect resembling the sound of two people singing the same melody.
<b>Oct-Up</b>	Adds another voice one octave higher than the original.
<b>Oct-Down</b>	Adds another voice one octave lower than the original.
<b>Keyboard</b>	The melody being played on the keyboard becomes the harmony.
<b>5th Up</b>	Adds harmony a fifth above the original.
<b>3rd Up</b>	Adds harmony a third above the original.
<b>4th Down</b>	Adds harmony a major fourth below the original.
<b>Chords</b>	Adds harmonies matching the chords designated with the keys.

### Cancelling the Effect

### 3. Touch the Harmonist type you selected in Step 2 again.

The Harmonist function is cancelled.

Touch <Exit> to go back to the Vocal Effects screen.



When you use the Harmonist function, the resonance setting for the piano (see p. 142) may sometimes be reset. And the effects applied to the keyboard (p. 36) may be canceled.



○ **Enabling the start of songs and automatic accompaniment with the sound of your voice (Vocal Count-In)**

You can start songs and the Automatic Accompaniment by counting into the microphone.

**1. Touch <Vocal Count In> in Step 2 of “How to select Vocal Effect” (p. 37).**

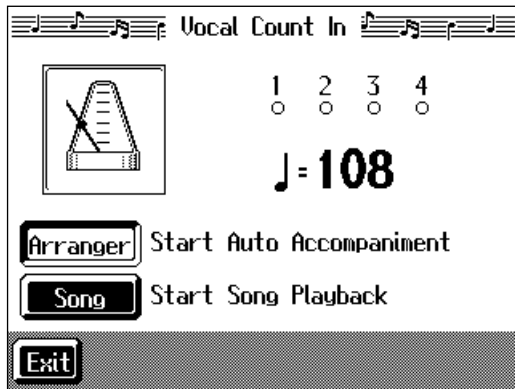

**2. Touch <Arranger> or <Song>.**

Display	Explanation
Arranger	Automatic Accompaniment starts at the tempo used for the count.
Song	The song starts at the tempo used for the count.

**3. Count to four (“One, two, three, four”) into the mic.**

Count out the number of beats per measure in the time signature of the selected song or Music Style.

For example, if you select a time signature of 4/4, then count to four; count to three when 3/4 time is selected.

The tempo is automatically set according to the interval between the counts as you speak into the microphone, and the song begins.

Touch <Exit> to return to the Vocal Effects screen.

○ **Playing instrument sounds at vocal pitches (Vocal Keyboard)**

You can have melodies sung into the microphone played with the KR-7’s internal Tones.

**1. Touch <Vocal Keyboard> in Step 2 of “How to select Vocal Effect” (p. 37).**

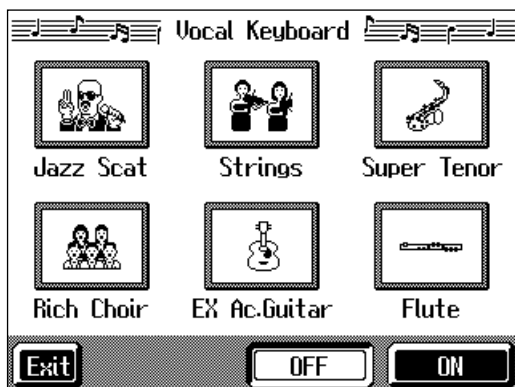

**2.** If the <OFF> icon is selected, touch the <ON> icon.

**3.** Touch any of the icons to select a Tone.

You can also select the Tone by pressing the Tone button.

When you sing into the microphone, the sung pitches are played using the selected Tone.

### Cancelling the effect

**4.** Touch <OFF>.

The Vocal Keyboard function is cancelled.

Touch <Exit> to go back to the Vocal Effects screen.

## ○ Adding harmonies to a specified part (Music Files)

When you sing while playing back a specified song data part, the harmony is added using the pitches of the specified part.

**1.** Select the song to which you want to add harmony.

If selecting a song on a disk, insert the floppy disk in the disk drive. For more on how to select songs, refer to “Playing a Song” (p. 69).

**2.** Touch <Music Files> in Step 2 of “How to select Vocal Effect” (p. 37).

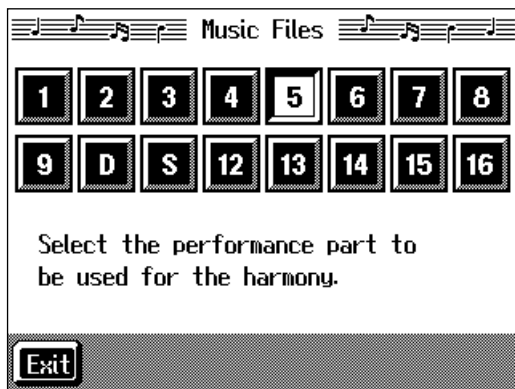

**3.** Touch the icon for the part to which you want to add harmony.

When you sing into the microphone, harmony is added using the pitches of the specified part.

### Cancelling the effect

**4.** Touch the icon you selected in Step 3 again.

The Music Files function is cancelled.

Touch <Exit> to go back to the Vocal Effects screen.



When you play the keys while using Vocal Keyboard, the tone selected for Vocal Keyboard is played.

## ■ Enjoying Karaoke Performances with Music Files

### 1. Connect a microphone.

### 2. Adjust the volume level and the amount of echo applied.

On the KR-7, use the Vocal Effect function to adjust the echo (p. 38).

You can also enjoy this effect with the Voice Transformer function (p. 39) and Harmonist function (p. 40).

On the KR-5, adjust the echo with the Echo adjustment knob on the instrument's lower panel (p. 21).

### 3. Select a song.

If selecting a song on a disk, insert the floppy disk in the disk drive. For instructions on how to select songs, refer to "Playing a Song" (p. 69).

### 4. Adjust the tempo as required with the Tempo [-] [+] buttons.

### 5. If necessary, change the key of the song (p. 90).

When you press the [ ▶ / ■ (Play/Stop)] button, the accompaniment starts playing. Sing along with the accompaniment.

When you play back a Music File with lyrics, the lyrics appear on screen.

### 6. Press the [ ▶ / ■ (Play/Stop)] button to stop the accompaniment.



Commercial music files designed for "karaoke" sing-along are also available. Consult your KR-7/5 dealer when purchasing music files. Refer to "Music Files That the KR-7/5 Can Use" (p. 189).



On the KR-7, lyrics can also be shown on an external display. Refer to "Connecting an External Display (KR-7)" (p. 21).



You can stop lyrics from being displayed. Refer to "Hiding the Lyrics (Lyrics)" (p. 93).

# Using the Metronome and Rhythm (Rhythm Partner)

The KR-7/5 features a built-in metronome. Additionally, you can have Rhythm patterns play, in the same manner as the metronome, just by pressing the [Rhythm] button.

The combination of the internal metronome and rhythm functions is called “Rhythm Partner.”



During playback of a song, or when performing with automatic accompaniment, the sound of the metronome keeps time with the beat of the song or accompaniment.

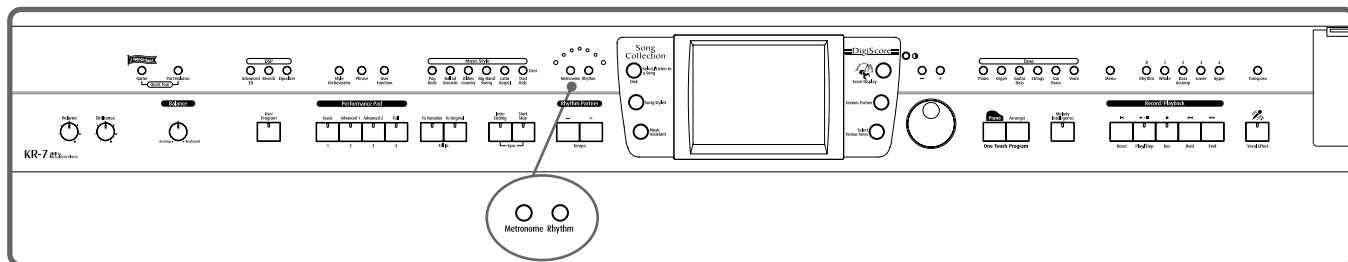

## ■ Using the Metronome

1. Press the [Metronome] button and watch the indicator light up.

You will hear the metronome.

The following “Metronome screen” appears.

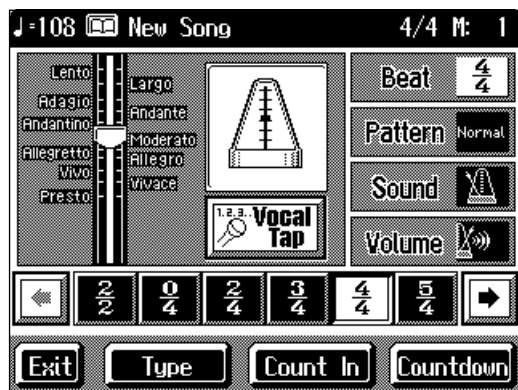

Display of the KR-7

You can touch <Exit> to have the metronome continue to play while you return to the previous screen.

### Stopping the metronome

2. Press the [Metronome] button once more, and the indicator light goes out.



It is not possible to use the metronome and rhythm (p. 48) simultaneously.

## ■ Changing the Metronome Settings

### ○ Adjusting the tempo

You can adjust the tempo of the metronome. The tempo of the metronome changes automatically if you use an Automatic Accompaniment or play back a song.

#### 1. Press the Tempo [-] or [+] buttons to adjust a tempo.

You can adjust the metronome tempo over a range of ♩ = 20–250.

The metronome is automatically set to ♩ = 108 when the power is turned on.

Pressing the [-] and [+] buttons simultaneously returns the selected song accompaniment to the basic tempo.

### ○ Determining the tempo with tempo marks

You can set the tempo by choosing a tempo indicator, such as “Allegro,” indicated on the score.

#### 1. On the Metronome screen, touch the tempo indicator bar graph.

The tempo is set to match the tempo mark.

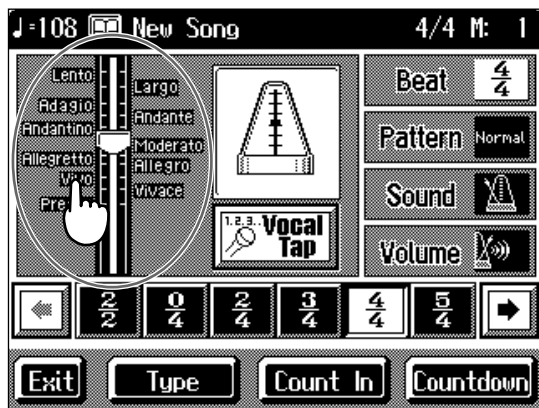

Display of the KR-7

### ○ Changing the beat of the metronome

#### 1. On the Metronome screen, touch <Beat>.

The available choices for the beat appear at the bottom of the screen.

#### 2. Choose the beat from among the selections by touching your choice.

You can scroll the display to one side or the other and show other choices for the beat

by touching  .

### MEMO

You can also use the dial to adjust the tempo. Turn it clockwise for a faster tempo, or counterclockwise for a slower tempo.

### MEMO

When  $\frac{0}{4}$  is selected, only the upbeat will sound.

## ○ Changing the volume



The volume of the metronome can be adjusted to ten different levels.

### 1. On the Metronome screen, touch <Volume>.

The available choices for the volume level appear at the bottom of the screen.

### 2. Touch the volume icon you've selected.

When you touch  , the selection moves to the side, allowing you to access other volume levels.

Choosing  sets the volume to the lowest level, and choosing  sets it to the highest level.

Choose  to silence the metronome sound.

## ○ Changing the Type of Sound







You can change the sound the metronome makes.

The setting is at “normal metronome sound” when the KR-7/5 is powered up.

### 1. On the Metronome screen, touch <Sound>.

The available choices for the type of sound appear at the bottom of the screen.

### 2. Touch one of the items in the group to select a metronome sound.

Displayed	Description	Displayed	Description
	Normal metronome sound		Electronic metronome sound
いちに	“1, 2, 3” in Japanese	One, two,	“1, 2, 3” in English
	Dog and cat sounds		Wood block
	Triangle and castanet		Hand clap

## ○ Changing the Animation

A metronome that moves along with the tempo is usually displayed at the center of the Metronome screen. You can change that picture to an animated bouncing ball, or other animation.

### 1. On the Metronome screen, touch the <Type>.

The animation type will change.

Each time you touch the icon, the animation switches between “Metronome,” “Dr. KR,” and “Bouncing Ball.”

## ○ Changing how the metronome beat (pattern) sounds

You can set the Metronome to play at even smaller intervals.







### 1. On the Metronome screen, touch <Pattern>.

The available choices for the metronome pattern appear at the bottom of the screen.

### 2. Choose a pattern by touching your choice.

You can scroll the display to one side or the other and show other pattern choices by

touching  .

Displayed	Description	Displayed	Description
Normal	Usual sound		Dotted half-note intervals
	Half-note intervals		Dotted quarter-note intervals
	Quarter-note intervals		Dotted eighth-note intervals
	Eighth-note intervals		Sixteenth-note intervals
+Doubl	Single back beat added	+Tripl	Triplet rhythm added
+Shufl	Shuffle rhythm added		

## ■ Playing Rhythm

The KR-7/5 features numerous internal rhythm patterns, which, like the metronome, can be played and stopped with the press of a single button.

Playing rhythm patterns instead of the metronome lets you enjoy performances that feel like live sessions.

### 1. Press the [Rhythm] button and watch the indicator light up.

The Rhythm will sound.

The following “Rhythm screen” appears.



When you touch <Exit>, the Rhythm sound continues to play, as you return to the previous screen.

### Stopping the Rhythm

### 2. Press the [Rhythm] button once more and the indicator light goes out.



## ■ Changing the Rhythm settings

### ○ Changing the Rhythm

#### 1. Touch a Rhythm name on the Rhythm screen.

The selected Rhythm plays.

The Rhythms available for selection will depend on the beat.

Touch   to switch the screens and show other choices.

### ○ Changing the beat of Rhythm

#### 1. In the Rhythm screen, touch <Beat>.

The available choices for the beat appear at the bottom of the screen.

#### 2. Choose the beat by touching your choice.

You can scroll the display to one side or the other and show other choices by

touching  .

### MEMO

You cannot have the metronome or automatic accompaniment play simultaneously with the Rhythm. When you start playing the metronome or automatic accompaniment while a Rhythm is playing, the Rhythm stops.

### MEMO

Depending on the beat, there may be only one Rhythm to choose from.

### MEMO

For more on the Rhythm types, refer to the “Rhythm Pattern List” (p. 187).



## ○ Changing the volume



The rhythm volume can be adjusted to ten different levels.

### 1. On the Rhythm screen, touch <Volume>.

The available choices for volume level appear at the bottom of the screen.

### 2. Select a volume icon.

When you touch  , the selection moves to the side, allowing you to access other volume levels.

Choosing  sets the volume to the lowest level, and choosing  sets it to the highest level.

Choose  OFF to silence the Rhythm sound.

# Chapter 2 Automatic Accompaniment

## Music Styles and Automatic Accompaniment

### What is Automatic Accompaniment?

Press the KR-7/5's One Touch Program [Arranger] button for Automatic Accompaniment's optimum settings. Automatic Accompaniment is a function that provides you with accompaniment in a variety of musical genres, just by specifying chords in the left hand. Automatic Accompaniment lets you play with an orchestra, even when performing alone!

### What Are Music Styles?

Accompaniment patterns in various musical genres are called "Music Styles."

There are many different kinds of music around the world, and each has its own unique features. What gives jazz or classical music their unmistakable sounds are a unique combination of elements like instrumentation, melody, and phrasing, which interact to create the musical character.

### Elements of Music Styles

A Music Style consists of a set of six sections called "divisions."

Division	Description
<b>Intro</b>	Played at the start of a song.
<b>Original</b>	The basic accompaniment pattern.
<b>Variation</b>	This is a variation on the Original accompaniment pattern.
<b>Fill In To Original</b>	This is a one-measure phrase inserted at a point where the mood changes and the accompaniment returns to the original.
<b>Fill In To Variation</b>	This is a one-measure phrase inserted at a point where the mood changes and the accompaniment moves ahead to the variation.
<b>Ending</b>	The conclusion of a song.

In addition, Music Styles are built from: "Rhythm," "Bass," "Accompaniment 1," "Accompaniment 2," and "Accompaniment 3."



For instructions on playing the Automatic Accompaniment, refer to "Selecting Music Styles (Music Style Buttons)" (p. 54).

## Performing Using Automatic Accompaniment (One-Touch Arranger)

Here's how to create the settings for Automatic Accompaniment.

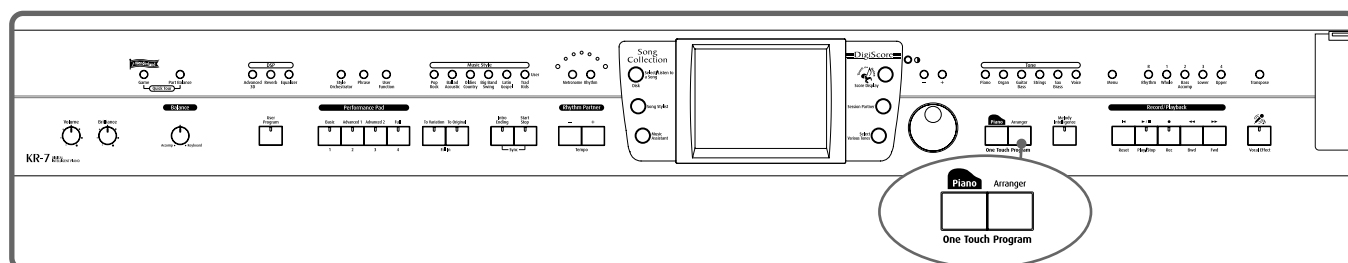

### 1. Press the One Touch Program [Arranger] button.

The Basic screen like the one shown below appears.

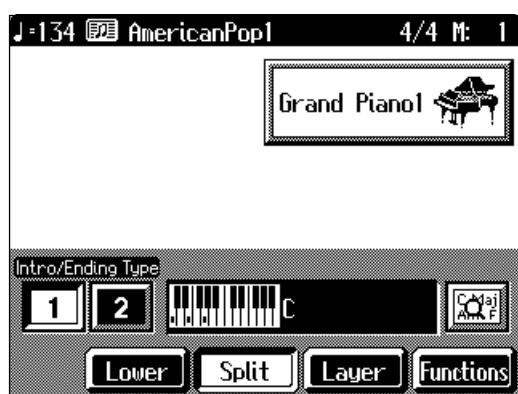

Observe the settings:

- The keyboard is split into left- and right-hand parts, with accompaniment chords specified for the left-hand side of the keyboard.
- A tone appropriate for the selected Music Style is chosen.
- The tempo and beat for the selected Music Style is set.

### 2. Play a chord on the lower-part of keyboard.

The accompaniment begins, starting from the intro.

Play chords with the left hand, and the melody with the right.

When you change chords in the left hand, the accompaniment also changes.

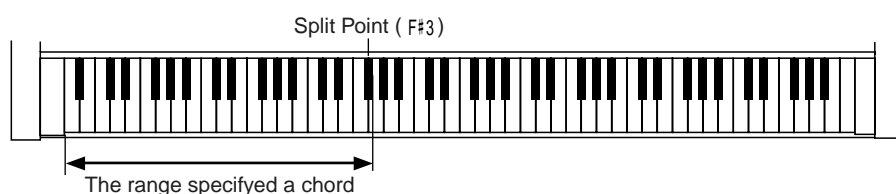

### 3. Press the [Intro/Ending] button.

After the ending plays, the accompaniment stops.

#### MEMO

When you select an internal song or music file that includes the lyrics data, <lyrics> appears in the Piano screen or Basic screen. Touch this to display the lyrics.

#### MEMO

Normally, when you change a Music Style, the tempo and tone change to selections that go well with the selected Music Style. If you do not want to change the tempo and tone, refer to “Changing Music Styles Without Changing the Tone or Tempo (One Touch Setting)” (p. 146).

#### MEMO

For instructions on selecting Music Styles, refer to “Selecting Music Styles (Music Style Buttons)” (p. 54).

#### MEMO

For instructions on starting and stopping the accompaniment, refer to “Starting and Stopping the Accompaniment” (p. 58).

#### MEMO

You can change the range in which chords are played. Please refer to “Changing the Keyboard’s Split Point (Split Point)” (p. 146).

## About Chords

A chord is produced when several notes are played simultaneously. Chords are indicated by the pitch of the fundamental note of the chord (the root) and the chord type, which is determined by the other notes of the chord.

For example, the C m chord is expressed in terms of the root note “C” and the chord type “m” (minor). C m is made up of the three notes “C,” “E ♭” and “G.”

“C m” is indicated as the chord name on the Basic screen.

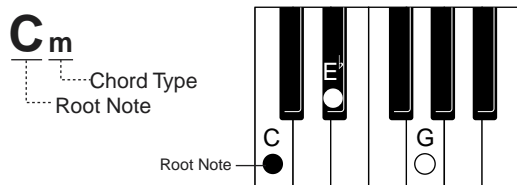

All chord roots are indicated as a letter, sometimes with # or ♭ added, and correspond to the notes shown below.

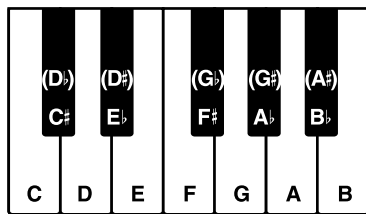

## Playing Chords with Simple Fingering (Chord Intelligence)

“Chord Intelligence” is a feature that chooses the accompaniment chords the moment you play a key.

To play a “C” chord, for example, you normally have to play the three keys C, E, and G. But with Chord Intelligence, you only have to press the C key to start a “C” chord accompaniment.

- How to play chords in the Chord Intelligence mode:

### Major

Ex: C



Play the chord root.

### Minor

Ex: C m



Play the root and the third key above it.

### Seventh

Ex: C 7



Play the root and the second key above it.

### Minor Seventh

Ex: C m7



Play the root, the third key above it, and the second key below it.

### Major Seventh

Ex: C maj 7



Play the root and the first key below it.

### Diminished

Ex: C dim



Play the root and the sixth key above it.



You can cancel the Chord Intelligence function. For more information, see “Changing How Chords Are Played and Specified (Arranger Config)” (p. 150).



For more information about chord fingering, refer to the “Chord List” (p. 182).

## ■ Viewing Chord Fingerings (Chord Finder)

Whenever you are not sure how a certain chord is fingered, you can display the notes of the chord on the screen.

1. On the Basic screen, touch .

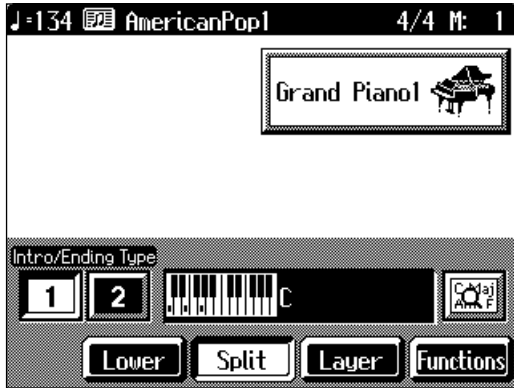

2. Touch the root of the chord you want to learn about.

The chord fingering appears on screen.

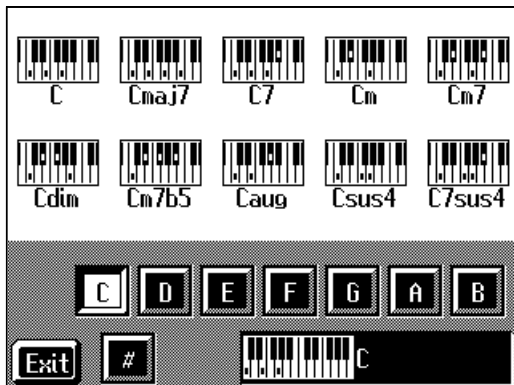

For example, if you wanted to see the fingering for a C# chord, you would touch <C>, then touch <#>.

Touch <Exit> to go back to the Basic screen.

## Selecting Music Styles (Music Style Buttons)

You can select a variety of different Music Styles by pressing the Music Style buttons. Music Styles are divided into six groups, with each assigned to one of the Music Style buttons.

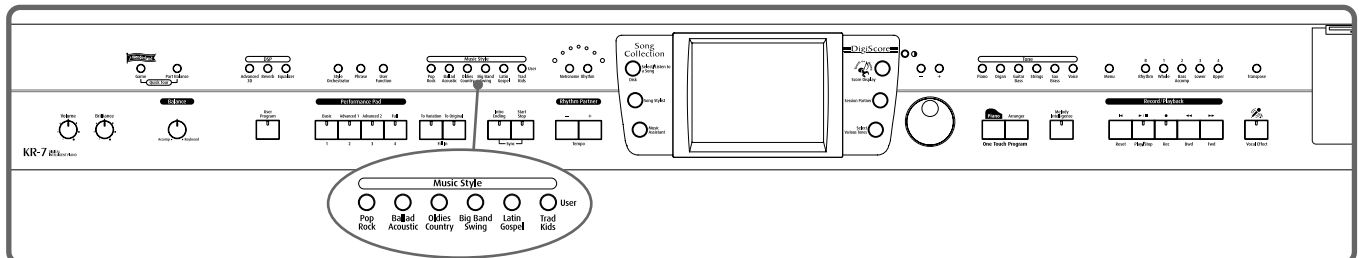

1. Press the One Touch Program [Arranger] button.
2. Press one of the Music Style buttons to select the Music Style group.



Watch the indicator button light up.

Six of the Music Styles included in that group are displayed on the screen.



This screen is called the "Style Selection screen".

You can listen to the Music Style by touching <Audition>.

Touch   to switch the screen and display the next selections.

You can touch <Search> to find Styles that match the selected criteria (p. 56).

3. Select a Music Style, and touch the Music Style name.

You can use the [-] [+] buttons and the dial to automatically switch pages and select Styles.

4. Touch Preset <A>, <B>, <C>, or <D> in the lower part of the screen.

When the Music Style is selected, Preset A is selected.

When any of the Presets from <A> through <D> are selected, the Music Style tempo, right-hand Tone, Style Orchestrator settings (p. 62) and other settings change.

### MEMO

For more on the Music Style names, refer to the "Music Style List" (p. 180, p. 181).

### MEMO

By changing the tempo and Tone, you can enjoy performing with a different ambience, even in the same Music Style.

**5. Touch <Exit>.**

The display returns to the Basic screen.

When you play a chord in the left-hand part of the keyboard, the selected Music Style is automatic.

**■ Selecting Music Styles on Disks**

You can play other User Styles saved to floppy disks or User memory (KR-7) (p. 139).

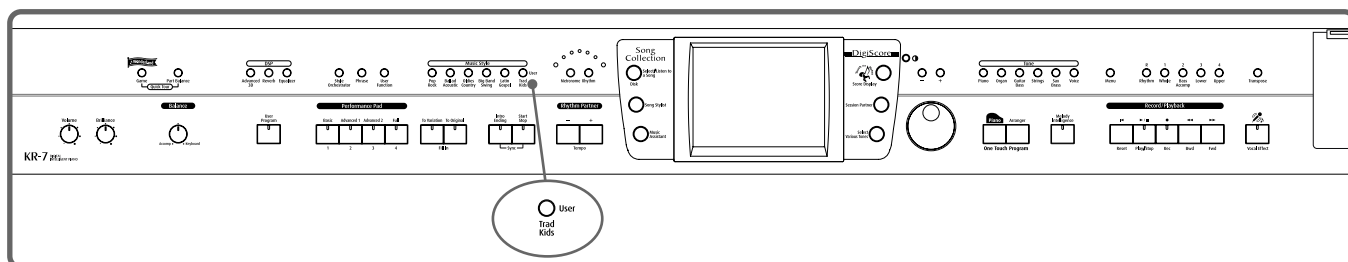

**1. Insert the floppy disk into the disk drive (p. 104).**

**2. Press the Music Style [User] button.**

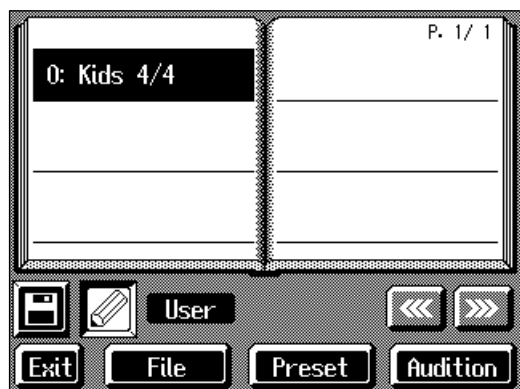

Display of the KR-7

When you touch <User/Disk> on the lower part of the screen, the screen for selecting user memory or disk Styles appears.

When you touch <Preset>, the screen for selecting “Trad/Kids” Music Styles appears.

**3. Touch . (KR-7)**

The Music Styles saved on the disk are displayed.

When you touch <>, the Music Styles stored in User memory are displayed.

**4. Select a Music Style, and touch the Music Style name.**

**5. Press the One Touch Program [Arranger] button.**

You can now perform in the selected Music Style.

Music Styles selected from floppy disks are stored until the power is turned off. Even after ejecting the floppy disk, by pressing the Music Style [User] button, you can perform using the most recently selected Music Style.

**MEMO**

If you're using the disk drive for the first time, be sure to read the important notes on p. 6.

**MEMO**

On the KR-7, you can save multiple user Styles to user memory. Take a look at “Saving a User Style” (p. 139).

## ■ Using Keywords to Search for Music Styles (Style Search)

You can search for Music Styles that match the tempo of the song, musical genre, or other criteria you set.

You can also search Music Styles using the first character of the Style names.

1. Press one of the Music Style buttons.
2. Touch <Search>.

The following “Style Search screen” appears.

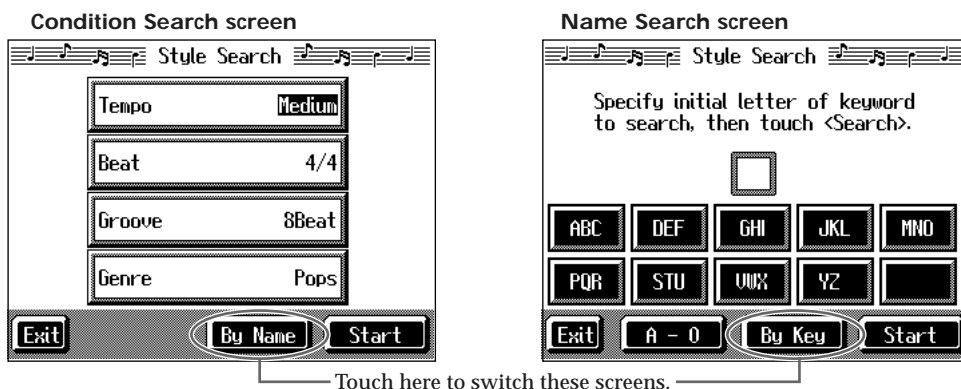

### ○ Searching by Conditions

3. Touch the parameter you want to set, then use the [-] [+] buttons and the dial to select the search conditions.
4. Touch <Search>.

The search results appear in the display.

Touch a Music Style name to select a Music Style.

Touch <Exit> to return to the Style Search screen.

### ○ Searching by Music Style name

3. Touch <By Name>.

Touch <By Key> to return to the Condition Search screen.

4. Decide which character you'll use for the search.

The selected character appears in the middle of the screen.

Enter the character you are searching for. For example, touching <ABC> in succession cycles you through the available choices in that character group (“A”→”B”→”C”...).

Touch <A-0> to toggle between alphabets and numerals.

5. Touch <Search>.

The search results appear on the display.

Touch a Music Style name to select a Music Style.

Touch <Exit> several times to return to the Basic screen or the previous screen.



Only the KR-7/5's internal Music Styles are searchable.



In a condition search, the KR-7/5 looks for Music Styles satisfying all of the selected search criteria.



## Playing Only Music Style Rhythm Patterns

You can also play only the rhythm patterns of Music Styles.

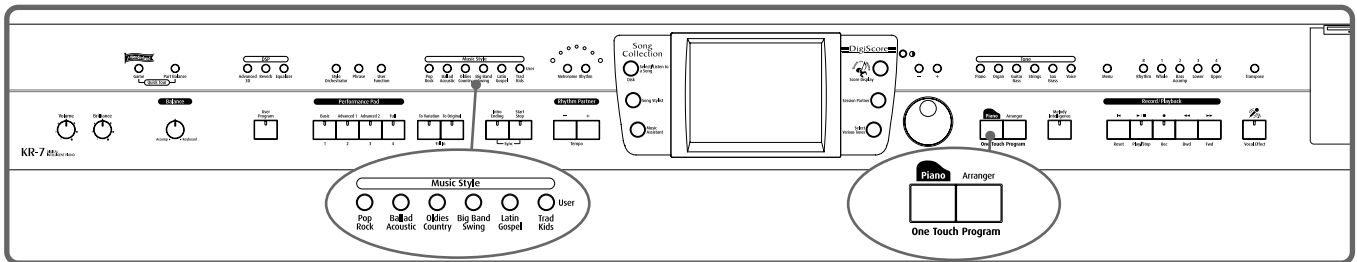

**1. Select a Music Style (p. 54).**

**2. Press the One Touch Program [Piano] button.**

The performance is set so that only the rhythm patterns are played.

**3. Press the [Intro/Ending] button.**

The Rhythm part of accompaniment begins, starting from the Intro.

Just as with regular Automatic Accompaniment, you can add intros and endings by pressing the [Intro/Ending] button, and make changes to the rhythm patterns with the Fill In button (p. 61).

**NOTE**

Some Music Styles do not include rhythm patterns. When you select these Style patterns, no rhythm patterns are played, even when you play on the left side of the keyboard.

## Adjusting the Accompaniment Tempo

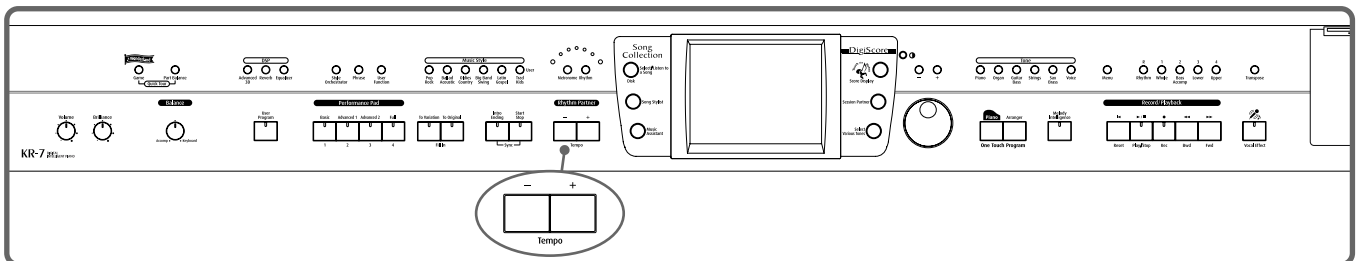

When the Basic screen is displayed, you can use the Tempo [-] [+] buttons or the [-] [+] buttons and the dial to change the tempo.

The tempo is indicated on the upper left of the screen.

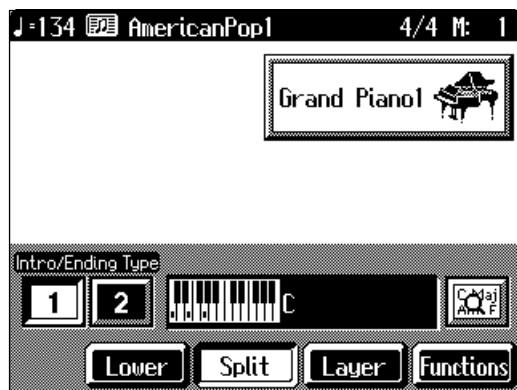

Pressing the [-] [+] buttons simultaneously returns the selected Music Style or song to the basic tempo.

You can change the tempo of Automatic Accompaniment even while the accompaniment is playing.

## Starting and Stopping the Accompaniment

Pressing the One Touch Program [Arranger] button activates Sync Start for the accompaniment (which starts the accompaniment simultaneously when you play on the lower section of the keyboard), and automatically sets an appropriate intro for the accompaniment. You can also change the way the accompaniment starts and stops.

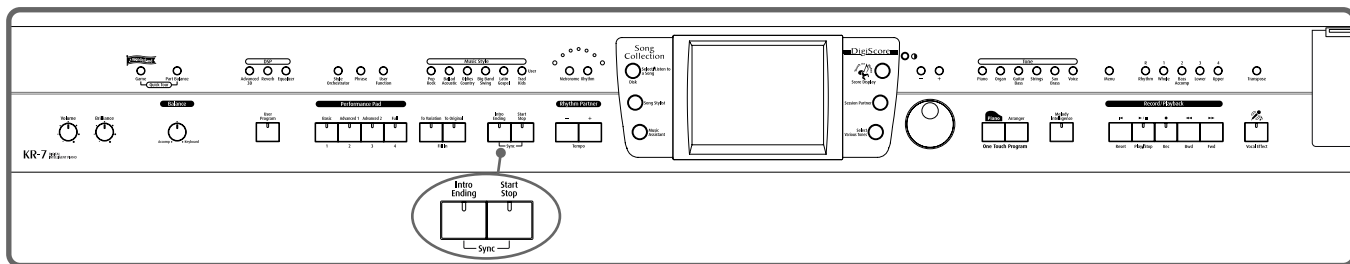

### ■ Having the Accompaniment Start Simultaneously When You Play the Keyboard (Sync)

1. Press the [Intro/Ending] button and [Start/Stop] button simultaneously, causing the indicators of both buttons to flash.

The Sync Start settings go into effect.

2. Play a chord on the lower-part of keyboard.

As you play the keys, the intro and accompaniment begins simultaneously.

#### ○ Changing the intro

When set for Sync Start (the indicators of both the [Intro/Ending] button and [Start/Stop] button are flashing), you can use the following procedure to change the intro, or prevent the intro from playing.

#### Starting without an intro

**Press the [Intro/Ending] button and watch the indicator go out.**

Now when you play a chord with the keyboard, the accompaniment starts without the intro.

#### To start with a short intro added

**On the Basic screen, touch the Intro/Ending Type <2>.**

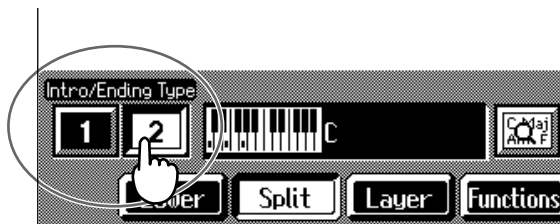

Now when you specify a chord with the keyboard, a short intro is played, and the accompaniment starts.



Sync Start is set immediately after the One Touch Program [Arranger] button is pressed.

## ○ Starting at the press of a button

1. Press the [Intro/Ending] button and [Start/Stop] button simultaneously, and the indicators lights go out.

The Sync Start function is cancelled.

2. Play a chord on the lower part of keyboard.

Choose the chord to be played when the accompaniment begins playing.

3. Press the [Intro/Ending] button or the [Start/Stop] button.

When you press the [Intro/Ending] button, the intro plays, and the accompaniment starts. When you press the [Start/Stop] button, the accompaniment starts without the intro.

When you press the [Intro/Ending] button after touching Intro/Ending Type <2> on the Basic screen, a short intro plays.

### **Chord Tones and Bass Tones**

When you play the keys in the left-hand side of the keyboard while the [Start/Stop] button's indicator is not lit, chords play. This note is called the "Chord Tone," and the root of the chord being played at the same time is called the "Bass Tone."



You can change the sound of the chord tone and bass tone. Take a look at "Changing How Chords Are Played and Specified (Arranger Config)" (p. 150).

## ■ Stopping Automatic Accompaniment

### ○ Stopping with an added ending

1. Press the [Intro/Ending] button.

An ending plays and the Automatic Accompaniment stops.

When you press the [Intro/Ending] button after touching Intro/Ending Type <2> on the Basic screen, a short ending plays.

### ○ Stopping at the same time the button is pressed

1. Press the [Start/Stop] button.

The Automatic Accompaniment stops as soon as you press the button.

## ■ Having a Count Sound Play at the End of the Intro (Countdown)

If an intro plays before your performance, you can have a count-in sound played to the end of the intro, helping you hear when to start playing.

Ex: 4/4

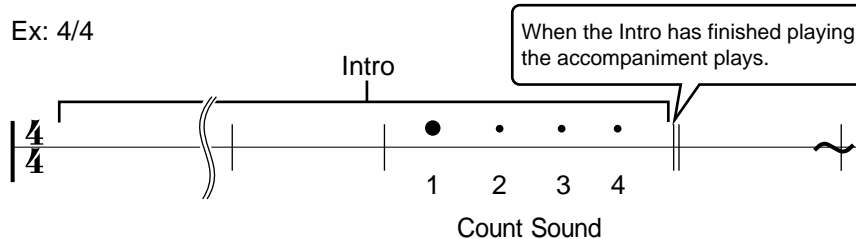

### 1. Press the [Metronome] button and watch the indicator light up.

The Metronome screen (p. 44) appears.

If you don't want the metronome to play, press the [Metronome] button and indicator light goes out.

### 2. Touch <Countdown>.

The following "Countdown settings screen" appears.



### 3. Touch <Switch> to set this to "ON."

When you press the One Touch Program [Arranger] button, the performance starts, and the countdown sound plays at the end of the intro.

## ○ Cancelling the countdown

### 1. In the Metronome screen, touch <Countdown>.

### 2. Touch <Switch> to set this to "OFF."

This sets the KR-7/5 so that the countdown does not play.



For more about settings on the Countdown screen, refer to "Settings for the Countdown" (p. 151).

## Modifying an Accompaniment

When you use Automatic Accompaniment, you can easily add Fill Ins to the accompaniment patterns, change arrangements, and make other changes.

### ■ Changing the Accompaniment Pattern (Fill In Buttons)

There are two accompaniment patterns: the Original, and a Variation. In addition, a fill-in (or short phrase) is added at the points where the accompaniment patterns change, which adds more interest to the song. It can be effective to use the simpler original pattern for the first half of the song, and the variation pattern for the second half.

#### What's a "Fill In"?

A short improvisational phrase inserted at the bar line is called a "Fill In." The KR-7/5 automatically plays the appropriate phrase for the selected Music Style.



You can add variation to the Automatic Accompaniment by assigning different functions to the Performance Pads and pedals. For more information, see "Assigning Functions to Pedals and Performance Pads (Pedal Setting/User Functions)" (p. 147).

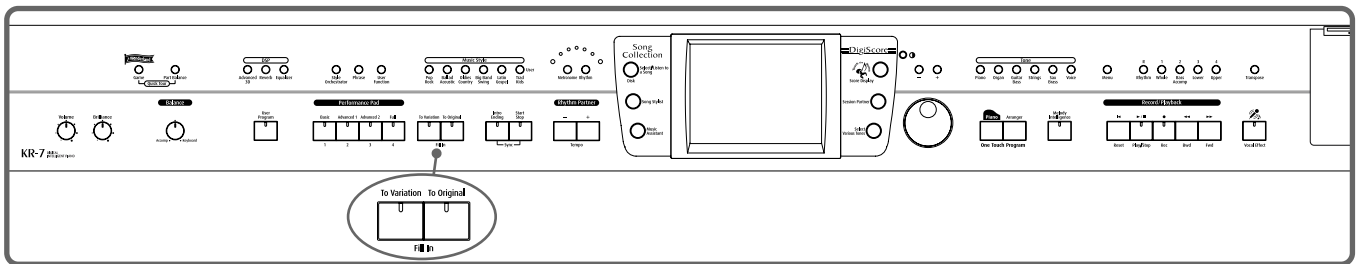

**Press the Fill In [Variation] button and watch the indicator light up.**

The instrument is set so that the variation performance pattern is played.

**Press the Fill In [Original] button and watch the indicator light up.**

The instrument is set so that the original performance pattern is played.

Pressing these buttons during a performance inserts a one-bar fill-in at the appropriate place and time.

#### Adding a fill-in without changing the accompaniment pattern

You can play only the fill-in, without changing the accompaniment pattern. Press the lit [Original] or [Variation] Fill In button during the performance.

## ■ Changing the Instrumental Makeup of Music Styles (Style Orchestrator)

You can change the arrangement of an accompaniment. This function is called “Style Orchestrator.” Each Music Style has four different accompaniment arrangements.

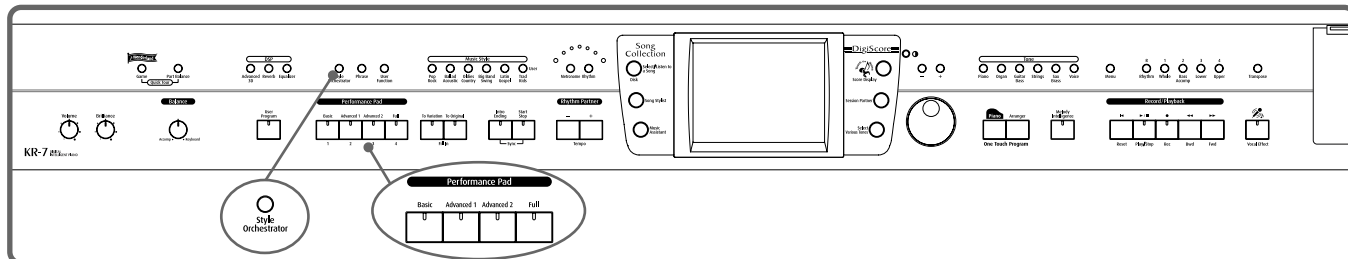

### ○ <KR-7>

1. Press the [Style Orchestrator] button and watch the indicator light up.

The instrument is set to allow you to change the arrangement with the Performance Pads.

2. Press Performance Pad [1]–[4] to change the arrangement for the accompaniment.

Watch the indicator of the button you pressed light up.

Pad [1] plays the simplest arrangement, and Pad [4] gives you the most elaborate arrangement.

### ○ <KR-5>

1. Press the [Style Orchestrator/User Function] button and watch the indicator light up.

This enables you to change the arrangement with the Performance Pad [1] or [2] button. A screen like the one shown below appears.



The Style Orchestrator value assigned to the current Pad is indicated.

Display	Explanation
Basic	This is the simplest arrangement.
Advanced 1	This is a more involved arrangement.
Advanced 2	
Full	This is the most elaborate arrangement.

You can change the arrangement assigned to Pad [1] or [2] by touching .



When you press the [Phrase] button or [User Function] buttons, the [Style Orchestrator] button's indicator goes out, and the function of the Performance Pads changes. For details refer to p. 63 and p. 147.



When simple Music Styles are selected, there may be no change in the arrangement even when you use the Style Orchestrator function.



You cannot change the orchestration of the Styles with the Performance Pad when the [Style Orchestrator/User Function] button's indicator is not lit. Refer to “Assigning Functions to Pedals and Performance Pads (Pedal Setting/User Functions)” (p. 147).

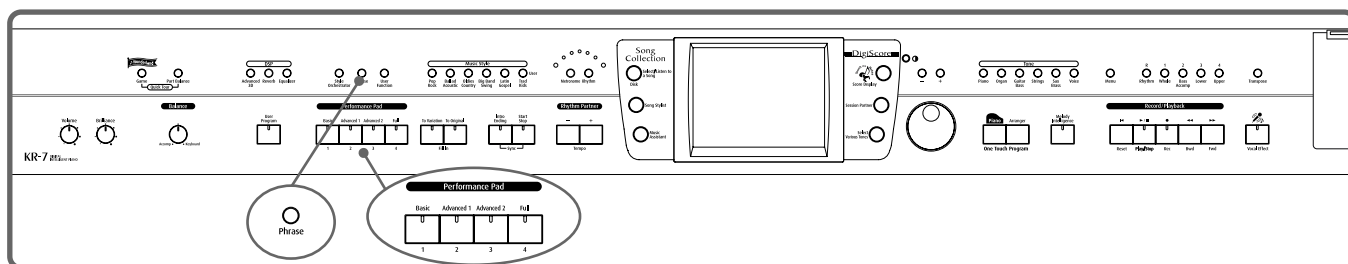

2. Touch <Exit>.  
You are returned to the previous screen.
3. Press the [1] or [2] button to change the arrangement of the accompaniment.

## ■ Playing Phrases (Phrase) (KR-7)

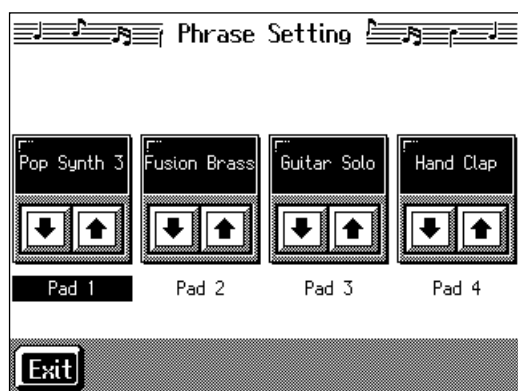

1. Press the [Phrase] button and watch the indicator light up.  
The instrument is set so that phrases play with the Performance Pads.  
A screen like the one shown below appears.



2. Touch   to choose the type of phrase.
3. Press one of the Pads.  
The selected phrase plays.  
When the phrase continues playing, press the Pad once more to stop it.  
With certain phrases, the accompaniment stops while the phrase is playing.  
When you touch <Exit>, you're returned to the previous screen, while the same function remains assigned to the Pads.

### MEMO

When you switch Music Styles, the phrases assigned to the Performance Pads are switched. If you do not want to have the phrase settings change when you change Music Styles, refer to “Changing Music Styles Without Changing the Tone or Tempo (One Touch Setting)” (p. 146).

## Adding Harmony to the Right-Hand Part (Melody Intelligence)

You can add harmony to the notes you play on the keyboard.

While an Automatic Accompaniment is playing, the matching harmony is automatically added to the notes you are playing with the right hand. This function is called “Melody Intelligence.”

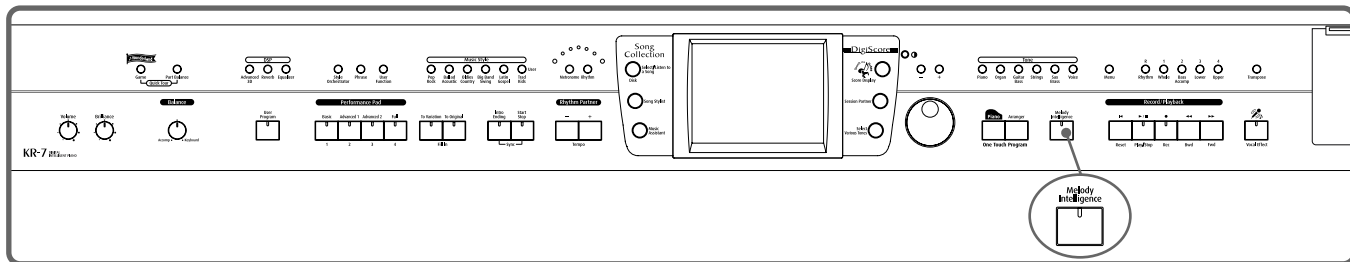

### 1. Press the [Melody Intelligence] button and watch the indicator light up.

When you play something on the right-hand section of the keyboard, harmony is added.

The following “Melody Intelligence screen” appears.

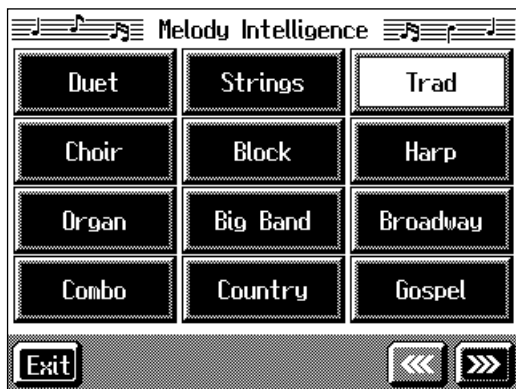

### 2. Select and touch a harmony type.

Then when you play a melody on the keyboard, a harmony style is automatically added.

When you touch <Exit>, you're returned to the previous screen, while the Melody Intelligence function remains selected.

### 3. Press the [Melody Intelligence] button once more and the indicator light goes out.

The Melody Intelligence function is cancelled.



With some harmonies, Tones may change automatically. Also, when you play several keys at the same time, in some cases harmony may be added to one note.



## Playing Sounds in the Left Hand During a Performance (Lower Tone)

Normally, when using Automatic Accompaniment in a performance, sounds are not produced by playing the left-hand part of the keyboard. When you touch the <Lower> icon, you can have Tones from the left side of the keyboard play simultaneously with the Automatic Accompaniment.

### 1. Press the One Touch Program [Arranger] button.

This sets the Automatic Accompaniment.

### 2. On the Basic screen, touch <Lower>.

Now when you play a chord in the left-hand keyboard area, the notes you play will sound, and the accompaniment chord changes.

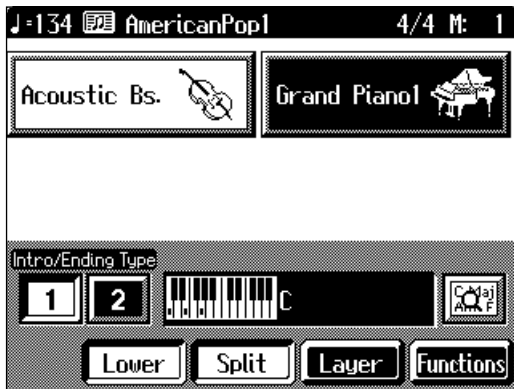

### Stopping the sound in the left-hand

### 3. Touch <Lower>.

The <Lower> icon reverts to black, and the left-hand Tones stop playing.

# Playing the Piano with Accompaniment Added (Piano Style Arranger)

Usually with Automatic Accompaniment, you play chords on the left-hand side of the keyboard and the melody on the right-hand side. Chords can also be recognized over the entire keyboard, allowing you to perform using Automatic Accompaniment without splitting the keyboard. This function is called “Piano Style Arranger.”

This makes it possible to add an accompaniment automatically as you play a song by playing chords in the ordinary way, without giving any thought to the location of a keyboard split.

1. Press the One Touch Program [Arranger] button.
2. Touch <Split> to turn the Split function off.

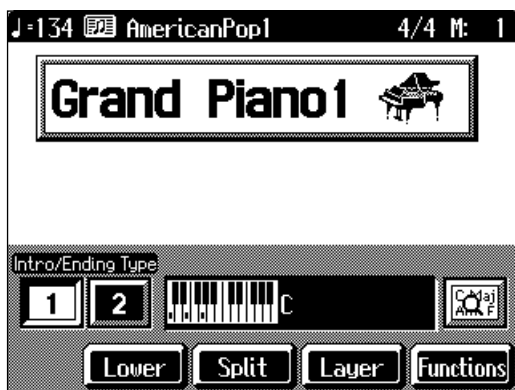

3. Select a Music Style (p. 54).
4. Play the keyboard.

The accompaniment starts when you play a chord anywhere on the keyboard.

## Adjusting the Volume Balance for Each Part (Balance)

You can adjust the volume balance between the accompaniment and the keyboard, and the volume balance for each of the parts in a Music Style.

### ■ Changing the Volume Balance between the Accompaniment and the Keyboard (Balance Knob)

You can change the volume balance between a song and accompaniment and the notes you play on the keyboard.

#### 1. Adjust the volume balance with the Balance knob.

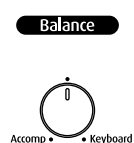

### ■ Adjusting the Volume Balance for Each Performance Part (Part Balance)

You can adjust the volume of each performance part in a Music Style, and the balance between parts when playing multiple Tones on the keyboard.

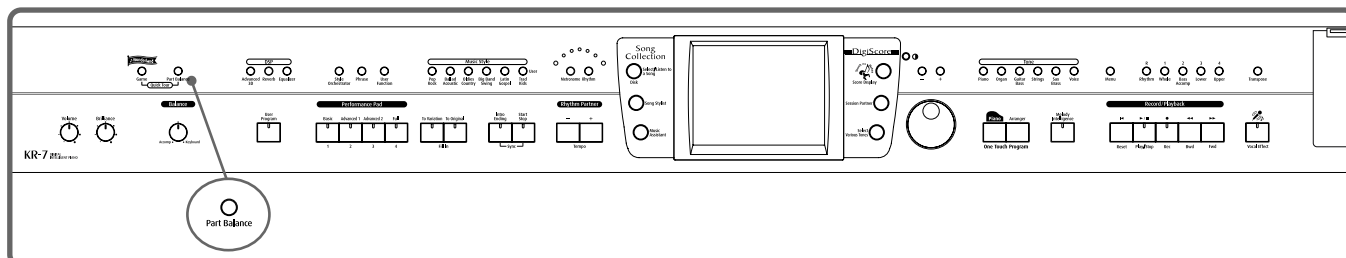

#### NOTE

When this knob is turned completely to the Accompaniment side, no sounds from the keyboard are audible, even when the keys are pressed. You can usually leave the knob at the center position.



#### 1. Press the [Part Balance] button and watch the indicator light up.

The following “Part Balance screen” appears.

Touch   to switch the two screens.

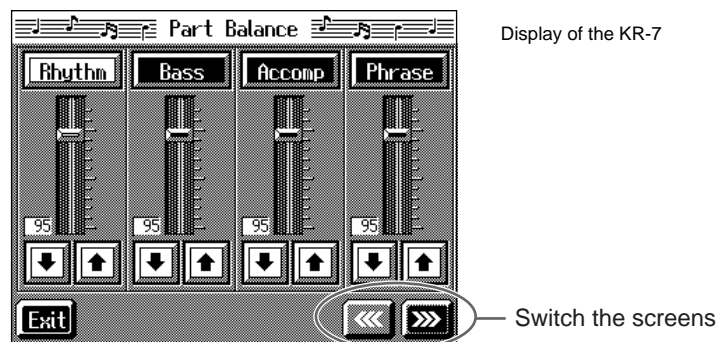

The volume balance between each of the performance parts in the Music Style is indicated.

Display	Performance part
Rhythm	Music Style Rhythm Part
Bass	Bass, Bass Tone (p. 59)
Accomp	Accompaniment 1, Accompaniment 2, Accompaniment 3, Chord Tone (p. 59)
Phrase (KR-7)	Short phrases sounded when the Performance Pads are pressed (p. 63).

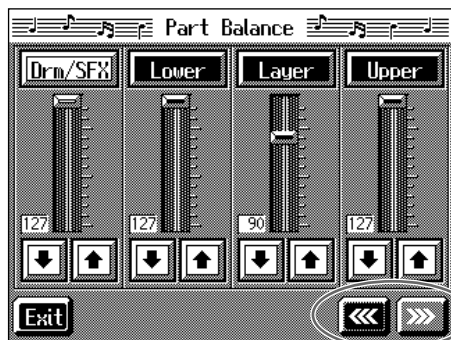

This shows the volume balance between each of the keyboard's Tones when layer performance (p. 28) or split performance (p. 29) are used, or the volume balance when using the keyboard to play percussion instruments or sound effects (p. 26).

Displayed	Tone Part
Drums	Percussion instruments or sound effects played with the keys
Lower	Left-hand Tone
Layer	Layer Tone
Upper	Right-hand Tone

## 2. Touch each slider to adjust the volume balance.

You can also make these adjustments by touching the adjustment sliders and then using the [-] [+] buttons or the dial.

Touch <Exit> to go back to the previous screen.

# Chapter 3 Song Playback and Practice Functions

## Playing a Song

Now, let's try practicing while playing back internal songs, commercial music files, and songs saved to floppy disks.

You can use rewind or fast-forward to go to any desired measure, and play back from that point.

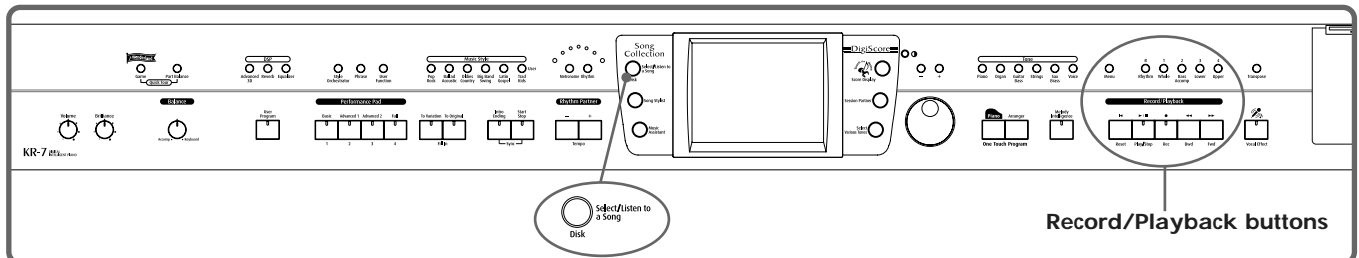

### Selecting the song

When playing back songs on floppy disks, first insert the floppy disk in the disk drive.

1. Press the [Select/Listen to a Song] button.

The following "Genre Selection screen" appears.

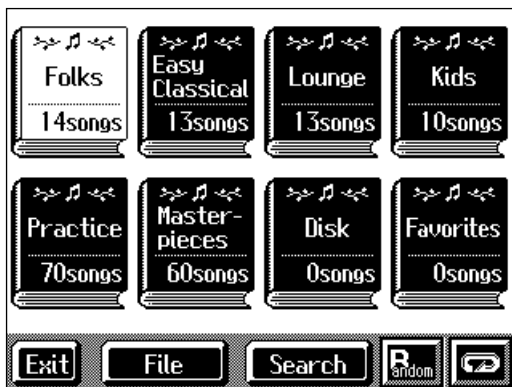

When you touch the genre for the song you want to play, the screen changes.

When selecting a song from a disk, touch, <Disk>.

The following "Song Selection screen" appears.







If the floppy disk is being used for the first time, refer to p. 6.

When you touch <  >, songs selected from all of the internal songs are played in random order.

When you touch <  >, all of the songs in the genre you have selected are played in order, starting from the selected song. When the last song is finished, playback resumes from the initial song.

<  >: Information for the selected song is displayed.

<  >: The selected song is played back. This changes to <  > while the song is played back; playback stops when you touch <  >.

<  > <  >: The song genre changes.

## 2. Touch the name of the song to be played back.

The selected song name appears at “0:.”

You use the [-] [+] buttons and the dial to select songs.

### Playing back

## 3. Press the [▶/■ (Play/Stop)] button.

The button indicator lights up, and playback of the song begins.

### Stopping the Song

## 4. Press the [▶/■ (Play/Stop)] button once again.

The button indicator light goes out, and the song stops.

When the song is finished, playback stops automatically.

Press the [◀ (Reset)] button to return to the beginning of the song.

### Record/Playback Buttons

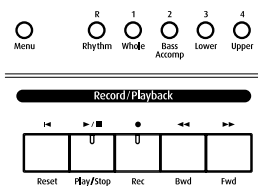

#### Track buttons:

Each performance part of the song being played back is assigned to a track button. Use these buttons to select the performance parts that are muted or played. For more detailed information, refer to p. 86.

[◀ (Reset)] button: Returns to the beginning of the song.

[▶/■ (Play/Stop)] button:

Plays back the song, or if the song is currently being played, it stops the song.

[● (Rec)] button: Records the performance. For more detailed information, refer to p. 95.

[◀◀ (Bwd)] button: Moves back the playback position of the song one measure each time the button is pressed. When held down, the song “rewinds” continuously.

[▶▶ (Fwd)] button: Advances the playback position of the song one measure each time the button is pressed. When held down, the song is forwarded continuously.

Holding down the [▶/■ (Play/Stop)] button and pressing the [▶▶ (Fwd)] button moves you to the end of the song.

### MEMO

If there is recorded song data, the “Delete song” screen appears.



If it's okay to delete the song, touch <OK>. If you do not want to delete the song, touch <Cancel>, and either save the song to a floppy disk (p. 106) or register the song to the Favorites (p. 72: KR-7).

### NOTE

When you start playback of songs, the measure number on the Basic screen appears in reverse video. The performance data is being loaded while the indication is highlighted; please wait a few moments for this to be completed.

### MEMO

#### Song Number <0:>

In the Song Selection screen, the title of the currently selected song appears at “0.” Song Number “0” is used by all genres. Recorded performances are also stored to “0.” The song in Song Number “0” is erased when the power is turned off.

### NOTE

When using markers to specify a section to be repeated (p. 89), you can rewind and fast forward only within the range between Marker A and Marker B.

## ■ Using Keywords to Search for Songs (Song Search)

You can search for songs that match the conditions you set regarding the song tempo or genre.

You can also search the songs using the first character of the song name.

**1. Press the [Select/Listen to a Song] button.**

**2. Touch <Search>.**

The following “Song Search screen” appears.

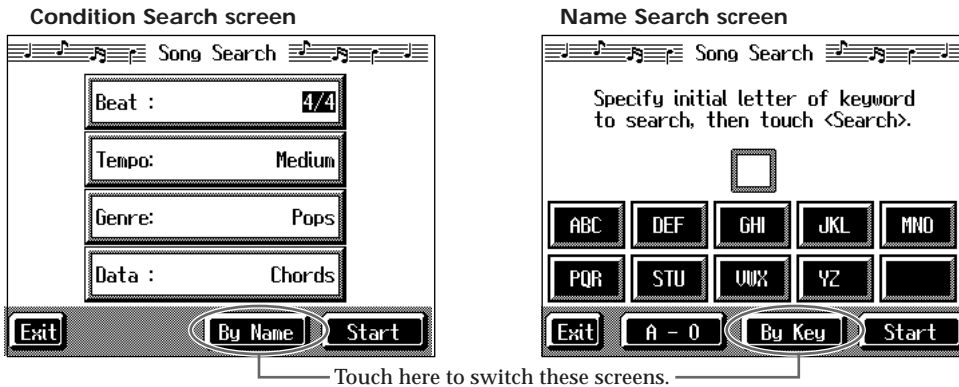

### ○ Searching by conditions

**3. Touch the parameter you want to set, then use the [-] [+] buttons and the dial to select the search conditions.**

With <Data>, songs are searched according to data included in the internal songs. You can use four different criteria in searches: “Chords,” “Lyrics,” “Fingering” (fingering numbers), and “Any.” By selecting a song containing any of this data, then displaying it in the KR-7/5’s score, you can display information about the selected data.

**4. Touch <Search>.**

The search results appear in the display.

Touch the song name to select the song.

Touch <Exit> to return to the Song Search screen.

### ○ Searching by song name

**3. Touch <By Name>.**

Touch <By Key> to return to the Condition Search screen.

**4. Decide which character you will use for the search.**

Enter the character you are searching for. For example, touching <ABC> in succession cycles you through the available choices in that character group (“A”→”B”→”C”...).

Touch <A-0> to toggle between alphabets and numerals.

The selected character appears in the middle of the screen.

**5. Touch <Search>.**

The search results appear in the display.

Touch the song name to select the song.

Touch <Exit> several times to return to the previous screen.



Only the KR-7/5’s internal songs are searchable.

# Registering the Songs You Like (Favorites)

You can register songs you are currently practicing or enjoy playing to “Favorites,” allowing you to select these songs easily.

### Selecting the Song

#### 1. Press the [Select/Listen to a Song] button.

The Genre Selection screen or the Song Selection screen appears (p. 69).

#### 2. Touch the song name to select the song to be registered.

### Registering to Favorites

#### 3. Touch <Add>.

A screen like the one shown below appears.

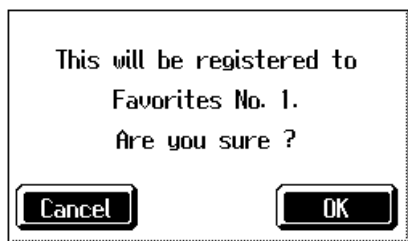

#### 4. Touch <OK>.

The selected song is registered to Favorites.

Now you can select the registered song by selecting Favorites for the genre in the Song Selection screen.

### MEMO

On the KR-7, you can also register songs on floppy disks to the Favorites. For details, refer to “Copying Songs on Disks to Favorites (KR-7)” (p. 110).

### NOTE

With the KR-5, you cannot register recorded songs or songs on disks to the Favorites. Only internal songs can be registered to the Favorites.

### MEMO

When you want to clear all of the content saved to the “Favorites” and restore the settings to the original factory condition on the KR-5, refer to “Clearing the “Favorites” (KR-5)” (p. 156).



## ■ Removing Songs from Favorites

This deletes registered songs for Favorites.

1. In the Song Selection screen, select Favorites for the genre.



2. Touch the name of the song to be deleted.
3. Touch <Del>.

A screen like the one shown below appears.



4. Touch <OK>.

The song is deleted.

## Displaying the Score

The KR-7/5 can display scores not only for the internal songs, but for music files and performances recorded with the KR-7/5. This is very convenient for performing while reading the music and for checking songs that have been recorded. When you play back a music file with lyrics, the lyrics appear on screen.

### Selecting the song

When playing back songs on floppy disks, first insert the floppy disk in the disk drive.

#### 1. Press the [Select/Listen to a Song] button to select a song.

For details refer to “Playing a Song” (p. 69).

#### 2. Press the [Score Display] button.

The “Score screen” appears.

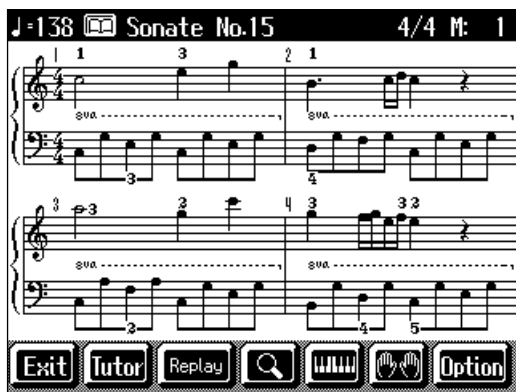

Display of the KR-7

### MEMO

In some internal songs, the fingering is displayed. The fingering numbers shown in the screen indicate one possible fingering.

Icon	Description
	Displays an enlarged score. You can also display the note names.
	The score and keyboard are displayed on the KR-7. The keyboard is displayed on the KR-5. This allows you to check the keys that are pressed for the sounds played back.
	Selects the part for which the score is displayed. * You can specify the track or part to be displayed with <Option> (p. 76).
<Option>	Makes detailed settings for the score display (p. 76).
<Tutor> (KR-7)	This allows you to practice the song repeatedly while reading the music (p. 78).
<Replay>	The left pedal functions as the “Replay.” When you press the pedal during the playback of the song, playback stops, and when you release the pedal, playback resumes starting at the beginning of that measure. When the pedal is pressed in rapid succession, playback is returned the same number of measures as the number of times the pedal is pressed. In situations such as when you want to hear a difficult phrase repeated a number of times, you can press the pedal to go to an earlier point in the song.

### MEMO

Chord names can be displayed in some of the internal songs and recorded performances using the KR-7/5’s Chord Sequencer (p. 124).

**3. Press the [▶/■ (Play/Stop)] button.**

Playback of the song begins, and the score advances along with the progression of the performance.

**Notes Regarding the Score Display**

- When playback of a song begins,  appears in the Score screen. While this symbol is displayed, performance data is being loaded from floppy disk or internal memory. It may take thirty seconds to a minute or more to read the data. Please wait.
- The displayed scores are based on music files. Priority is placed on the readability of the displayed music, not on the accurate rendition of difficult, high-level performances. Thus, there may be discrepancies seen when compared with commercially available printed music. The display is not intended for viewing advanced songs requiring precisely detailed scores, or complex songs.
- On the score display screen, lyrics and notes may extend beyond the range displayed on the screen and may not be visible.
- Playback may start over from the beginning if you display the score or change the displayed part during playback of the song.

**NOTE**

No notes are shown in the score if the selected part contains no data. To change the part being displayed, refer to “Making Detailed Settings for the Score Display” (p. 76).

**■ Touching Notes to Confirm the Sounds**

**(Touch the Notes)**



In the Score screen, you can have notes played by touching the notes on the screen.

When you touch  to show the keyboard on the screen, the touched note is indicated by the corresponding note on the keyboard. This allows you confirm notes by sight, sound, and touch.

In addition, when you trace part of the score with your finger, the traced segment is played back. This allows you to easily play back phrases you like.

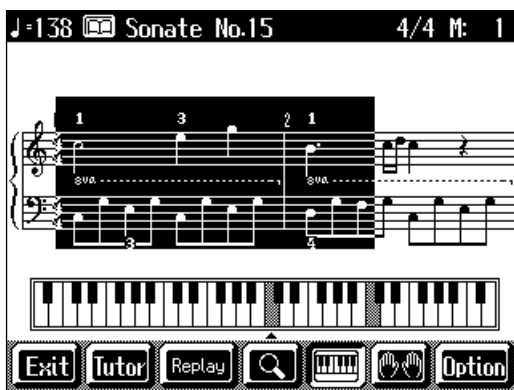

Display of the KR-7

## ■ Making Detailed Settings for the Score Display

You can change the part appearing on the score display and change the manner in which the score is displayed.

1. Press the [Score Display] button to display the Score screen.
2. Touch <Option>.

A screen like the one shown below appears.

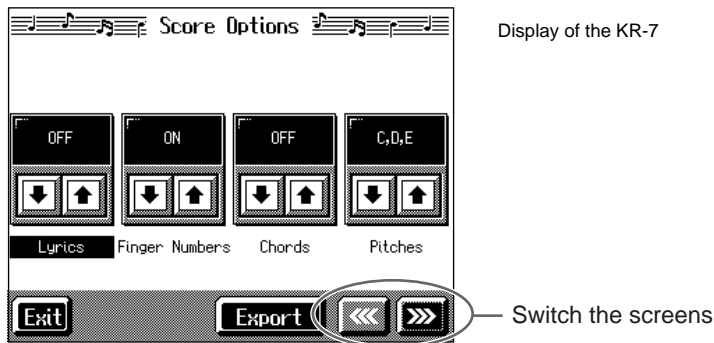

3. Touch for the parameter being set to select the value.

Touch <Exit> to return to the Score screen.

Item	Setting	
<b>Lyrics</b> Sets whether or not the lyrics appear in the music.	ON	The lyrics are displayed.
	OFF	Not displayed.
<b>Finger Numbers</b> Whether or not the fingering appears in the music.	ON	The fingering is displayed.
	OFF	Not displayed.
<b>Chords</b> Whether or not chord names appear in the music.	ON	The chord names are displayed.
	OFF	Not displayed.
<b>Pitches</b> Sets whether or not the note names appear in the music when the score is expanded.	OFF	Not displayed.
	C, D, E	The pitch names (C, D, E) are displayed.
	Do, Re, Mi (Fixed)	The pitch names (fixed Do) are displayed.
	Do, Re, Mi (Movable)	The syllable names (movable Do) are displayed.
<b>Clef L</b> Determines whether a treble or bass clef is shown in the score for the left-hand part.	Auto	Display is switched automatically.
	G Clef	G (treble) clef is displayed in the score.
	F Clef	F (bass) clef is displayed in the score.
<b>Clef R</b> Determines whether treble or bass clef is shown in the score for the right-hand part.	Auto	Display is switched automatically.
	G Clef	G (treble) clef is displayed in the score.
	F Clef	F (bass) clef is displayed in the score.
<b>Key</b> Score is displayed in the specified key.	Auto	Key is switched automatically.
	b x 5-0- # x 6	Score is displayed in the specified key.

### MEMO

In some internal songs, the fingering is displayed. The fingering numbers shown in the screen indicate one possible fingering.

### MEMO

Chord names can be displayed in some of the internal songs and recorded performances using the KR-7/5's Chord Sequencer (p. 124).

Item	Setting
<b>User Part</b> Selects the part to display when “User” is selected as the part to be displayed.	User Track, Parts 1–16
<b>Lower Part</b> Selects the part to display when “Lower” is selected as the part to be displayed.	Lower Track, Parts 1–16
<b>Upper Part</b> Selects the part to display when “Upper” is selected as the part to be displayed.	Upper Track, Part 1–16

### ■ Saving Scores as Image Data (KR-7)

You can take scores that are displayed on the KR-7 and save them to floppy disks. You can also use saved image data to your computer.

- 1. Insert the floppy disk onto which you want to save the image data in the KR-7’s disk drive.**

Use a floppy disk formatted on the KR-7.

For more on formatting disks, refer to p. 104.

- 2. Press the [Select/Listen to a Song] button to select a song.**

- 3. Press the [Score Display] button.**

The Score screen appears.

- 4. Touch <Option>.**

- 5. Touch <Export>.**

A screen like the one shown below appears.

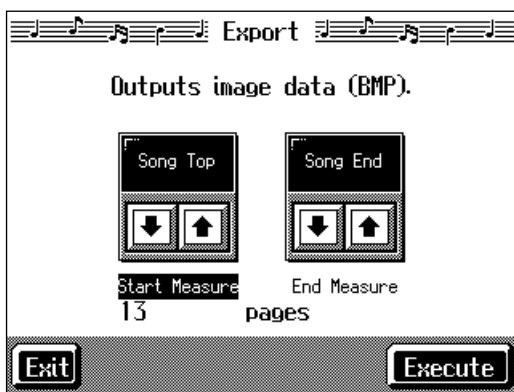

- 6. Touch   for each parameter to set the range of the image data.**

- 7. Touch <Execute>.**

The score is saved to the floppy disk as image data in BMP (bitmap) format.

**NOTE**

Other than for your own personal enjoyment, use of the scores that are output without the permission of the copyright holder is prohibited by law.

**NOTE**

Do not remove the floppy disk while “save” is in progress.

# Practicing Songs with the Practice Function (KR-7)



Try using the KR-7's practice function to practice a song you like.

This feature makes it simple to specify the segment you want for repeated practice, check your own performance against the score, and practice at a slower tempo.

## 1 Displaying the Score Screen

### Selecting the song

1. Press the [Select/Listen to a Song] button to select the song you want to practice.

For more on how to select songs, refer to p. 69.

### Displaying the Score screen

2. Press the [Score Display] button.

The Score screen appears.

3. Touch <Tutor>.

The following "Tutor screen" appears.



### NOTE

When you select this function after turning on the power, a message screen like the one shown in the figure at left appears only once.

## 2 Practicing

### Listening to a reference of the Performance

First, listen to the song you are going to practice.

Once you're familiar with the song, practice it a number of times along with the example.

1. Touch <Reference>.

When the Message screen appears, touch <Close>.

2. Touch <▶> on the screen.

The example performance is played back.

Touch <◀◀> or <▶▶> to rewind or fast forward within the practice range.

Touch <◀> to return to the beginning of the practice range.



## Touch the Notes



When you touch a note on the Practice screen, the KR-7 plays that note.

When you trace along the displayed score with your finger, the KR-7 plays the traced segment.

## One Note

When you touch , the KR-7 plays the note currently indicated by the bouncing ball. When you touch  or , you can return or advance one note at a time to check the notes.

## Recording Your Performance

Once you are able to play the song, try recording your own performance.

### 3. Touch <Rec>.

When the Message screen appears, touch <Close>.

### 4. Touch on the screen.

You'll hear a count, and recording begins.

Play along with the accompaniment.

## Checking Your Performance

Compare your recorded performance with the example.

### 5. Touch <Check>.

When the Message screen appears, touch <Close>.

### 6. Touch on the screen.

The Check screen display compares the example performance with your own performance.

Analyze and practice any trouble spots.

## 3 Changing the practice settings

Immediately after turning on the power, all measures are set for practice at the original tempo.

In the beginning, you'll probably want to select specific phrases, and practice that material repeatedly at a slower tempo.

### 1. Touch <Options>.

A screen like the one shown below appears.

## MEMO

When the Transpose function (p. 90) is set to ON, the original tone is sounded when you touch notes or <One Note> on the screen.

## MEMO

### Changing the Performance Played Back in the Check Screen

You can switch the performance that is played back by touching the score for "User" or "Reference" in the Check screen.

When the keyboard is displayed in the Check screen, touch <User> or <Reference> to switch the performance to be played back.

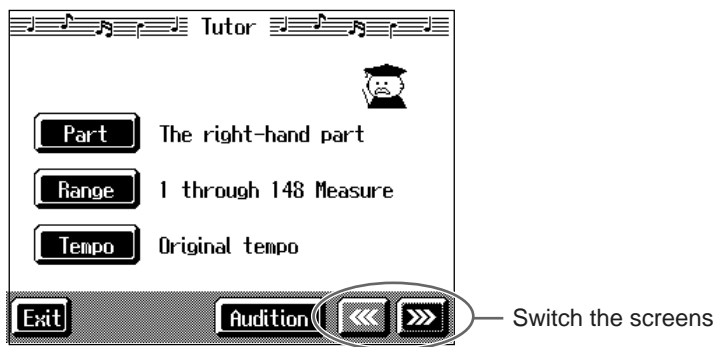

Parameter Set	Value	Description
Part	Left Hand, Right Hand, Both Hands	Selects the part or parts to be practiced.
Range	1-	Specifies measures for practice. Most of the KR-7's internal songs have markers set in order to make repeated practice easier. You can specify the markers' range by touching <Prev> or <Next>.
Tempo	Original Tempo, A Little Slower, Slower, Much Slower	Selects the practice tempo.
Accomp	On, Quiet, Off	When "On" is selected, song accompaniment parts are also played back. When "Quiet" is selected, song accompaniment parts are played back at a lower volume. When "Off" is selected, song accompaniment parts are muted.
Tone	Do Re Mi, Original	Selects the tone played when the notes are touched. When "Original" is selected, a original tone for the song is selected. When "Do Re Mi Voice" is selected, the notes are "sung" as "Do-Re-Mi."
Check	Score, Keyboard	Selects whether the score display or the keyboard display is used in demonstrating the example performance and your own recorded performance in the Check screen.

### MEMO

When the Transpose function (p. 90) is set to ON, the original tone plays even if "Tone" is set to "Do Re Mi."

## 2. Touch the icon for the parameter you want to set.

The selections appear.

## 3. Touch the setting icon.

Repeat Steps 2 and 3 to set each of the parameters.

Set the tempo, practice range and other variables to the values you prefer.

## 4. Touch <Audition>.

The practice range is played back using the selected settings.

## 5. Touch <Exit>.

You're returned to the Practice screen.



## Adjusting the Tempo

This changes the song and Music Style tempos.

If songs seem difficult to play at their original speed, you may find it helpful to first practice with the tempo slowed down. Then, after becoming more familiar with the song, you can practice it at a gradually faster tempo.

Changing the tempo has no effect on the pitch of the notes. And you can change the tempo even when the song is in progress.

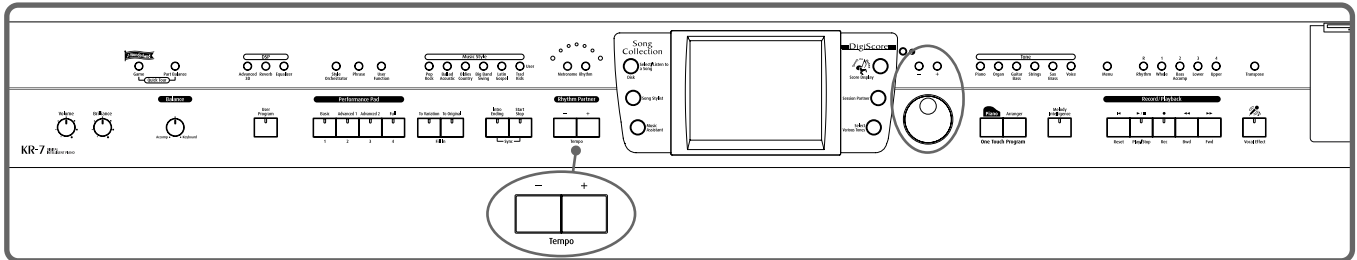

### Adjusting the tempo with the Tempo [-] [+] buttons

Pressing the [+] button once increases the tempo by one unit. Holding down the button makes the tempo increase continuously.

Pressing the [-] button once decreases the tempo by one unit. Holding down the button makes the tempo decrease continuously.

Pressing the [-] [+] buttons simultaneously returns the selected Music Style or song to the basic tempo.

### Adjusting the tempo with the dial

When the tempo is displayed at the upper-left area of the screen (except at the Rhythm screen (p. 48)), you can use the dial to adjust the tempo.

Turn the dial clockwise to speed up the tempo.

Turn the dial counterclockwise to slow the tempo.

## ■ Setting the Tempo by Pressing the Button in Time (Tap Tempo)

You can also set the tempo by pressing the Performance Pad. This feature is called “Tap Tempo.” By using the Tap Tempo function, you can quickly set the tempo you are thinking of, without specifying the tempo in numerical terms.

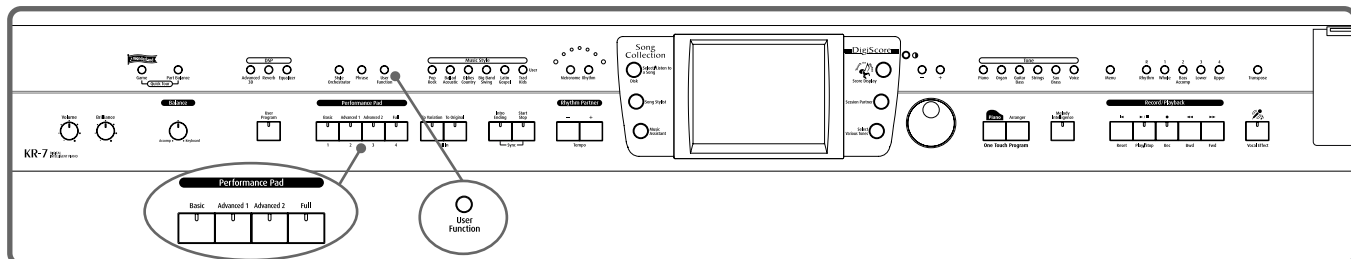



### ○ <KR-7>

#### Assigning functions to the Performance Pads

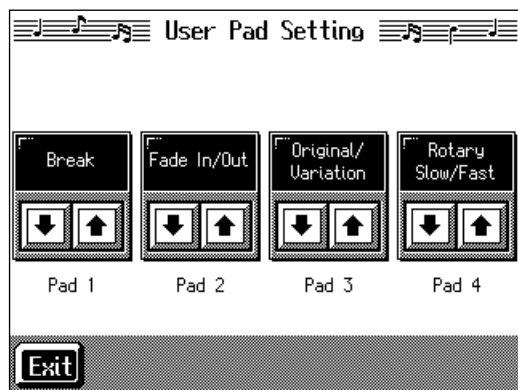
1. Press the [User Function] button and watch the indicator light up.



2. Touch   for the Performance Pad to which the function is assigned, then select “Tap Tempo.”
3. Touch <Exit>; the tempo is indicated in the upper left of the screen.

#### Specifying the Tempo

4. Press the Pad to which “Tap Tempo” is assigned at least twice.

The tempo is set to the rhythm you used when tapping the button.

#### MEMO

You can also assign the Tap Tempo function to the pedal, and use the pedal to specify the tempo. For details, refer to “Assigning Functions to Pedals and Performance Pads (Pedal Setting/User Functions)” (p. 147).



## ○ &lt;KR-5&gt;

## Assigning functions to the Performance Pads

1. Press the [Style Orchestrator/User Function] button and the indicator light goes out.

A screen like the one shown below appears.



2. Touch   for Performance Pad [1] or [2] to assign “Tap Tempo.”
3. Touch <Exit>; the tempo is indicated in the upper left of the screen.

## Specifying the Tempo

4. Press the Pad to which “Tap Tempo” is assigned at least twice.

The tempo is set to the rhythm you used when tapping the Pad.

## MEMO

You can also assign the Tap Tempo function to the pedal, and use the pedal to specify the tempo. For details, refer to “Assigning Functions to Pedals and Performance Pads (Pedal Setting/User Functions)” (p. 147).

## ■ Use Your Voice to Select the Tempo (Vocal Tap Tempo) (KR-7)

Just as in “Tap Tempo Function” (p. 82), you can set tempos using your voice. This feature is called “Vocal Tap Tempo.”

1. Connect a microphone (p. 21).
2. Press the [Metronome] button.
3. Touch <Vocal Tap>.



4. Count to four (“One, two, three, four”) into the mic.

The tempo is set to the beat you used speaking into the microphone. The new tempo setting is indicated in the screen.

After setting the tempo, touch <Exit> and you’re returned to the Metronome screen.

## ■ Playing Back at a Fixed Tempo (Tempo Mute)

If a song has tempo changes, it helps to practice the song first at a steady tempo. Overriding tempo changes is called “Tempo Muting.”

1. Hold down the [▶/■ (Play/Stop)] button and press one of the Tempo [-] [+] buttons.

When tempo muting is in effect, the tempo display appears in reverse video.



When you play back the song, it will play at a constant tempo.

### Cancel the tempo mute setting

1. Hold down the [▶/■ (Play/Stop)] button and press one of the Tempo [-] [+] buttons.

Tempo muting is canceled.

Tempo Mute will also be cancelled when you select a different song.



Vocal Tap Tempo does not function well when the mic volume is too low. Adjust the volume level with the Mic [Volume] knob.



You can start the song by giving the count through the microphone. For more detailed information, refer to “Enabling the start of songs and automatic accompaniment with the sound of your voice (Vocal Count-In)” (p. 41).

## Match the Tempo Before You Begin Playing (Count In)

When you're playing along with a song, you can listen to the tempo before you start playing by adding a count-in.

This audible count before the song playback is called a "Count-In."

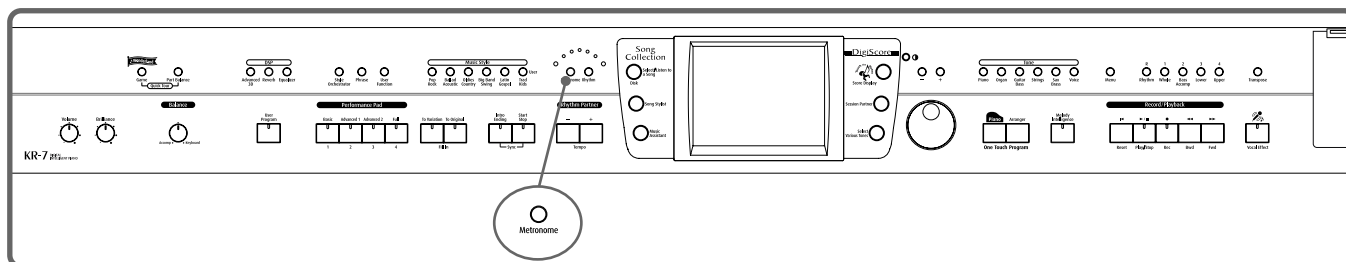

### 1. Press the [Metronome] button and watch the indicator light up.

The Metronome screen (p. 44) appears.

If you are not using the metronome, press the [Metronome] button so its indicator goes out.

### 2. Touch <Count In>.

The following "Count In settings screen" appears.

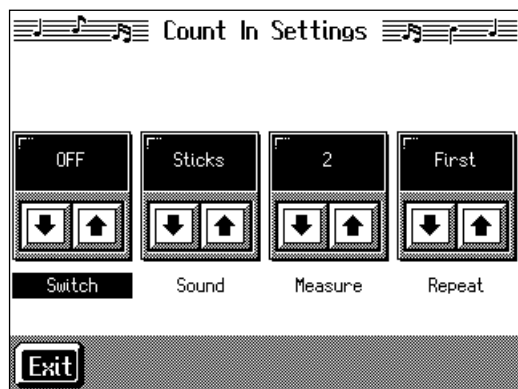

### 3. Touch <Switch> [Down Arrow] [Up Arrow] to set this to "ON."

With this setting, two measures count down before the song playback starts.

#### Canceling the Count In

### 1. In the Metronome screen, touch <Count In>.

### 2. Touch <Switch> [Down Arrow] [Up Arrow] to set this to "OFF."

This sets the KR-7/5 so that the count sound is not played.

#### MEMO

You can have a count sound be played before the song starts playing back by holding down the [Reset] button while you press the [Play/Stop] button. The status of the <Count In> settings won't be affected by your use of this procedure. .

#### MEMO

For more about other settings on the Count-In settings screen, refer to "Settings for the Count-In" (p. 151).

## Muting Some Parts Before Playing (Track Buttons)

With commercially available music files for piano lessons, the part for each hand can be played back independently. This makes it easy to practice hands separately. For example, you can follow along with your right hand while you listen to that same right-hand part be played, or you can practice the left-hand part while the right-hand part plays.

A music file for piano lessons may be assigned to the five Track buttons as shown below.



For more on music files, refer to “Music Files That the KR-7/5 Can Use” (p. 189).

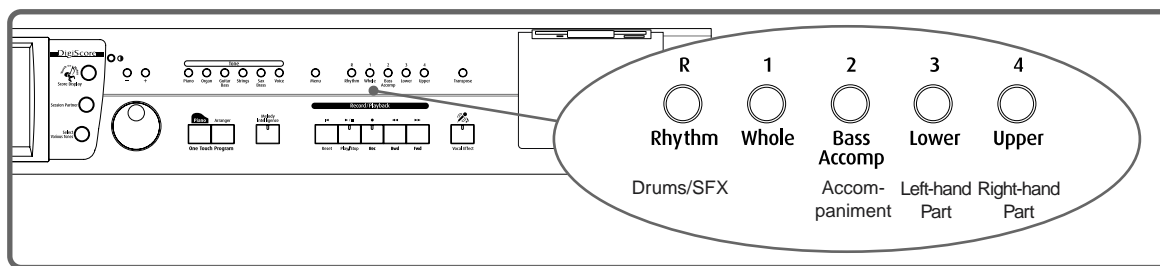

By using these Track buttons, you can eliminate the sound of specific parts. This is referred to as “muting.”

By recording your own performances to the Track Buttons in this fashion, you can mute parts the same way. For details, refer to “Recording While Selecting the Track Buttons (Redoing Recordings)” (p. 101).

### 1. Select the song that you wish to play back (p. 69).

#### Selecting the part that you’ll be playing

### 2. Press any one of the Track buttons to make the button’s indicator light go dark.

The sound for the selected part no longer plays.

For example, when practicing the right hand, press the [4/Upper] button.

When you play back the song, the right-hand performance will not sound. Practice your right-hand performance along with the left-hand playback.

#### Playing back a song

### 3. Press the [▶/■ (Play/Stop)] button.

The song will begin playing back.

The part you selected in step 2 will not sound.

Once again press the button you selected in step 2. The button’s indicator will light up, and the part will be heard once again.

Even while the song is playing, you can press the track buttons to mute or un-mute the sound.

#### Stopping the song

### 4. Press the [▶/■ (Play/Stop)] button.

The song will stop.



If a single Track button includes more than one instrument and you want to mute just one of those instruments, take a look at “Modifying the Settings of Each Part” (p. 118).



When a single Part is not played, it is called “Minus One.” Using Minus One, you can mute out a particular instrument and play the part yourself.



When playing back SMF files for Roland Piano Digital series instruments, and the [3/Lower] button and [4/Upper] button do not correctly control the left/right-hand performances, please change the “Track Assign” settings. Please refer to “Changing the Parts Assigned to the Track Buttons During SMF Playback (Track Assign)” (p. 94).



You can adjust the balance between the keyboard and song volume levels. Check out “Adjusting the Volume Balance for Each Part (Balance)” (p. 67).

## Setting Markers for Repeated Practice (Marker)

By setting markers at points in a song that you want to practice repeatedly, you can then easily go to and repeat play back of the selected measures.

### ■ Placing a Marker within a Song

You can place two separate markers (Marker A and Marker B) in one song. These markers are placed at the beginning of a measure to make the beginning and end of a section of music. Placing markers is a handy way to start playback at the same place as many times as you like. You can add markers or move to a marker even while playback is in progress.

#### Access the Marker screen

First, select the song in which you'll set the markers (p. 69).

#### 1. Press the [Menu] button.

Touch   to switch the screens.

#### 2. Touch <Marker>.

The Marker screen appears.

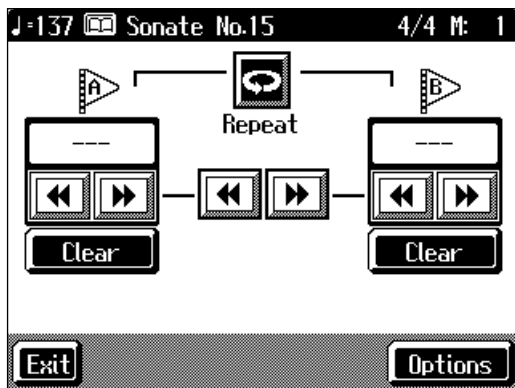

#### Placing Markers

#### 3. Go to the measure where you want to set a marker using the [ ◀◀ (Bwd)] and [ ▶▶ (Fwd)] buttons.

#### 4. Touch <—> for Marker A.

Marker A is placed at the beginning of the measure you selected.

“—” on the screen will change to the number of the measure where you placed the marker.

#### 5. In the same way, touch the Marker B <—> to set Marker B.

It is not possible to assign marker B to the same location or a measure before marker A.



Markers can also be assigned in units of beats rather than measures. Refer to “Placing a Marker in the Middle of a Measure” (p. 150).

### ■ Playback from a Marker location

1. At the marker screen, touch the measure number of the marker you want to go to.

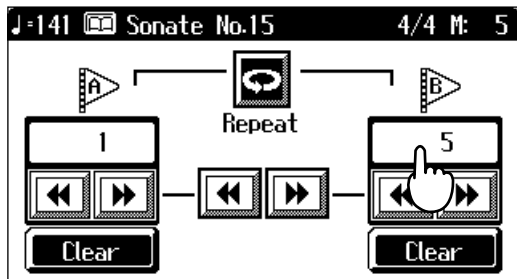

Playback will start from wherever Marker A or Marker B are set.

With the song playing back, playback will continue if you touch Marker A or Marker B on the Marker screen.

### ■ Erasing a Marker

1. Touch <Clear> for the marker you want to erase.

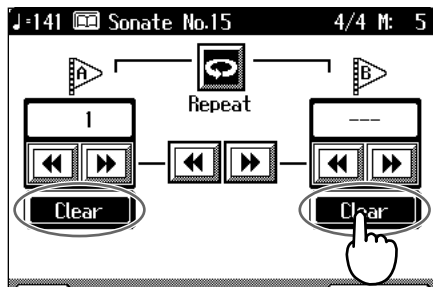



The marker disappears and the on-screen display changes to <—>.

### ■ Moving a Marker

You can move a marker that has been placed in a song. You can also move the section of music defined by Markers A and B forward or back, without changing the number of measures of marked.

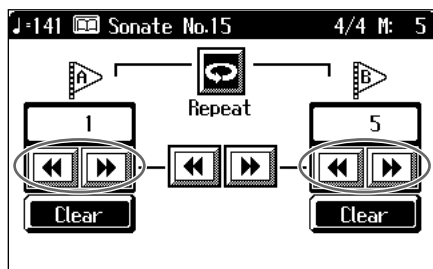
1. On the Marker screen, touch  or  for the marker to be moved.



When you touch , the marker is moved to a previous part of the song.

When you touch , the marker is moved to a later part of the song.



**Moving Markers A and B without changing the interval between them**

**1.** On the Marker screen, touch  or  in the middle of the screen.

For example, if you have Marker A set at the beginning of the fifth measure, and

Marker B set at the beginning of the ninth measure, when you touch , Marker A is moved to the beginning of the first measure, and Marker B is moved to the beginning of the fifth measure.

Touch  to shift Marker A to the beginning of the ninth measure and Marker B to the beginning of the thirteenth measure.

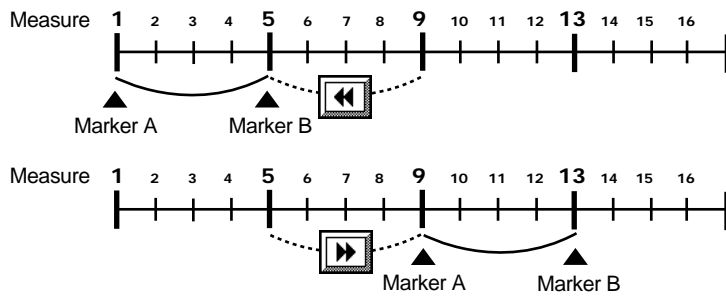

**■ Playing Back the Same Passage Over and Over**

You can play back a particular passage over and over. This is convenient when you want to focus on a passage.

**1.** First, set Marker A and Marker B to define the measures you want to repeat.

For instance, suppose you want to play back the passage from the fifth through eighth measures over and over. You should place Marker A at the beginning of the fifth bar and Marker B at the beginning of the ninth bar.

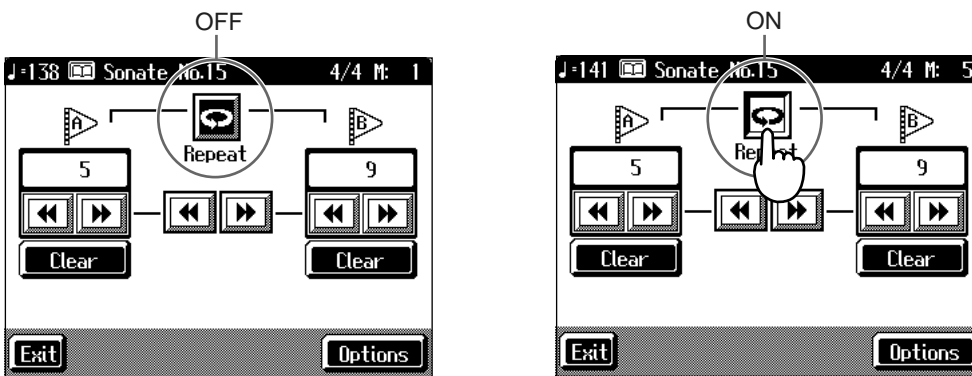

**2.** Touch <Repeat> in the Marker screen.

The setting is made for repeated playback of the passage from marker A to marker B. When you play the song, the marked section of music plays back repeatedly.

**Cancelling repeat playback**

**3.** Touch <Repeat> in the Marker screen, so it's highlighted in black.

Repeat playback is cancelled.



**When <Repeat> is On**

- If neither Marker A nor Marker B is set, the song is played back from the beginning to the end.
- If you only place marker A, playback repeats from marker A to the end of the song.
- If you only place marker B, playback repeats from the beginning of the song to marker B.

# Transposing Keyboard Sounds and Songs Played Back (Transpose)

By using the “Transpose function,” you can transpose your performance without changing the notes you play. For example, even if the song is in a difficult key with many sharps (♯) or flats (♭), you can transpose it to a key that is easier for you to read and play.

You can also use this function to play back a song in a different key.

When accompanying a vocalist, you can easily transpose the pitch to a range that is comfortable for the singer, while still playing the notes as written (i.e., with the same fingering positions).

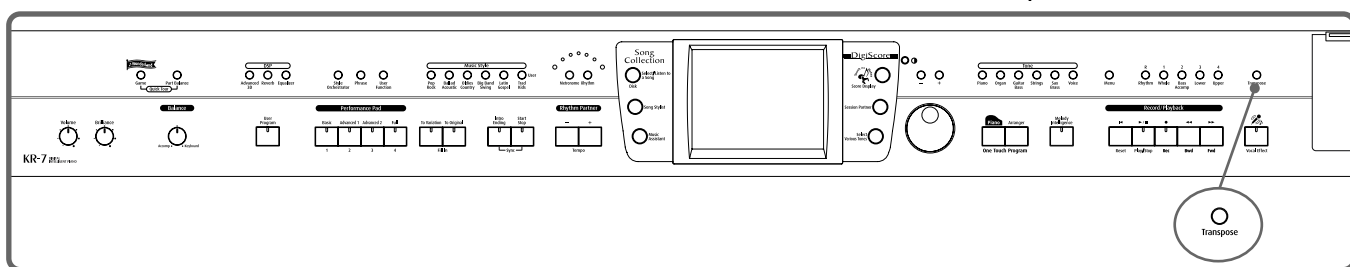



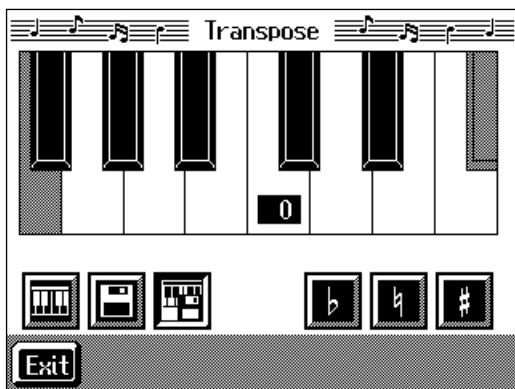

## 1. Press the [Transpose] button.



A “Transpose screen” like the one below appears.



## 2. Touch the Transpose icon.

Icon	Target	Settings Value
	Keyboard sound	-6-0-+5
	Song to be played back	-24-0-+24
	Keyboard sounds, songs being played back	-6-0-+5

- 3.** Touch the screen keyboard or  ,  to select the transposition value.

Each time you press  or  , it transposes the key by a semitone.

When you touch  , a value of “0” is set.

You can also use the [-] [+] buttons or the dial to change the transposition value.

When you transpose a song or the keyboard, the [Transpose] button’s indicator lights up. As you play the keyboard or play back the song, the notes are transposed.

When you touch <Exit>, the transposition remains in effect, and you’re returned to the previous screen.

**Cancelling Transposition**

- 4.** Press the [Transpose] button and the indicator light goes out.

Transposition is cancelled.

The next time you press the [Transpose] button, illuminating the indicator, the music is transposed by the value set here.



The transposition value reverts to “0” when you turn off the power or select another song.

**Example: Playing a song in E major while playing the keys for C major**

In this example, C is the root note in the key of C major. E, the root of E major, is the

third in C major. It is up four keys, including the black keys, so touch  , then enter “4” for the setting.

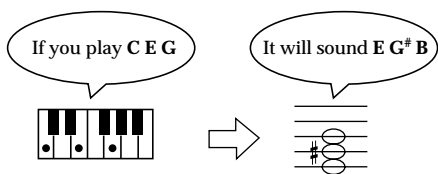

## Detailed Song Playback Settings

### ■ Changing the Tone Settings When Playing Back Songs (Play Mode)

With the normal setting, GS tones (sounds that are compatible with other GS instruments) will normally be used to play back song data. By changing this setting, you can play back song using KR-specific tones for certain portions of the data.

**1. Press the [Menu] button.**

The Menu screen appears.

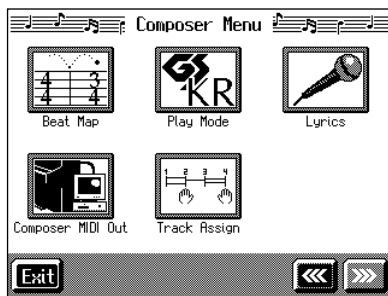

Touch   to switch the screens.

**2. Touch <Play Mode>.**

A screen like the one shown below appears.

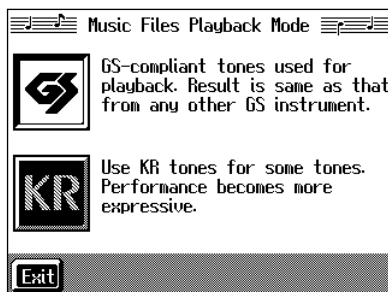

**3. Touch the icon to choose the setting.**

Icon	Description
GS	Playback uses GS-compatible tones for performances that sound like other GS instruments.
KR	Playback uses KR tones for greater expressiveness. However, differences may appear when playing back using devices other than the KR.

**4. Touch <Exit> to go back to the Menu screen.**

**5. After changing this setting, try selecting the song once again.**

For more detailed information about selecting a song, refer to “Playing a Song” (p. 69).



For detailed information about GS, refer to “About the KR-7/5 Sound Generator” (p. 189).

## ■ Hiding the Lyrics (Lyrics)

Some commercially available music files for use in karaoke, as well as some of the internal songs include lyrics data. When you play such music files, the lyrics automatically appear in the screen. If you do not want lyrics to appear automatically, set this to “OFF.”

### 1. Press the [Menu] button.

The Menu screen appears.

Touch   to switch the screens.

### 2. Touch <Lyrics>.

A screen like the one shown below appears.

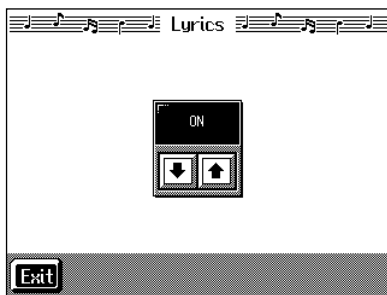

### 3. Touch to select the setting.

Display	Explanation
ON	Lyrics are displayed automatically (when performance data containing lyrics is played back).
OFF	Lyrics are not displayed, even if the song data being played back contains lyrics data.

### 4. Touch <Exit> to return to the Menu screen.

#### MEMO

Even when this is set to “OFF,” you can still have the lyrics be displayed by touching <lyrics> when it appears in the Piano or Basic screen (p. 23).

#### MEMO

The screen may be switched when you press the button while the Lyrics screen is displayed. To have the lyrics displayed again, touch <lyrics> on the Piano or Basic screen, or stop playback of the song, then press the [▶/■] (Play/Stop) button.

## ■ Changing the Parts Assigned to the Track Buttons During SMF Playback (Track Assign)

Normally, when playing back Roland Piano Digital-compatible SMFs (p. 189), the left-hand part is assigned to the [3/Lower] button, and the right-hand part is assigned to the [4/Upper] button. However, assignment of the right-hand and left-hand parts may differ with some SMF data.

If you cannot get the right-hand and left-hand parts to work well set on “Auto,” then change the setting to “2/1 Part” or “3/4 Part.”

### 1. Press the [Menu] button.

The Menu screen appears.

Touch   to switch the screens.

### 2. Touch <Track Assign>.

A screen like the one shown below appears.



### 3. Touch to select the setting.

Display	Explanation
Auto	The part assigned to each track will be determined automatically, depending on the song data.
2/1 Part	Part 1 will be assigned to the right-hand track, part 2 to the left-hand track, and part 3 to the user track.
3/4 Part	Part 4 will be assigned to the right-hand track, part 3 to the left-hand track, and part 1 to the user track.

### 4. Touch <Exit> to return to the Menu screen.

After changing this setting, try selecting the song once again.

For more detailed information about selecting a song, refer to “Playing a Song” (p. 69).



When you select this parameter, the message “OK to delete song?” may be displayed. Refer to “If the following screen appears” (p. 95).



This setting is effective with SMF format song data. This is not effective with the internal songs.

# Chapter 4 Recording and Saving the Performance

With the KR-7/5, you can easily record performances using the five track buttons. A recorded performance can be played back to listen to your own playing, or to add additional parts.

You can use the KR-7/5 to make the following kinds of recordings.

- Recording just your own keyboard performance (→ “Recording a New Song (New Song)” (p. 96))
- Recording performances using Automatic Accompaniment (→ “Recording With Accompaniment” (p. 98))
- Recording along with the internal songs and songs on disks (→ “Recording Along with a Song” (p. 100))
- Re-recording (→ “Recording While Selecting the Track Buttons (Redoing Recordings)” (p. 101))

## ○ If the following screen appears

If you've recorded a song or changed a song's settings (see p. 118), the following message appears on the screen when you try to choose another song.



If it's okay to delete the song, touch <OK>.

If you do not want to delete the song, touch <Cancel>, and either save the song to a floppy disk (p. 106) or register the song to the Favorites (KR-7) (p. 72).

### NOTE

Recorded performances are discarded when another song is selected, or when the power is turned off. Be sure to save important performances on a floppy disk. Take a look at “Saving Songs” (p. 106).

## Recording a New Song (New Song)

This records keyboard performances without the use of the internal songs or Automatic Accompaniment.

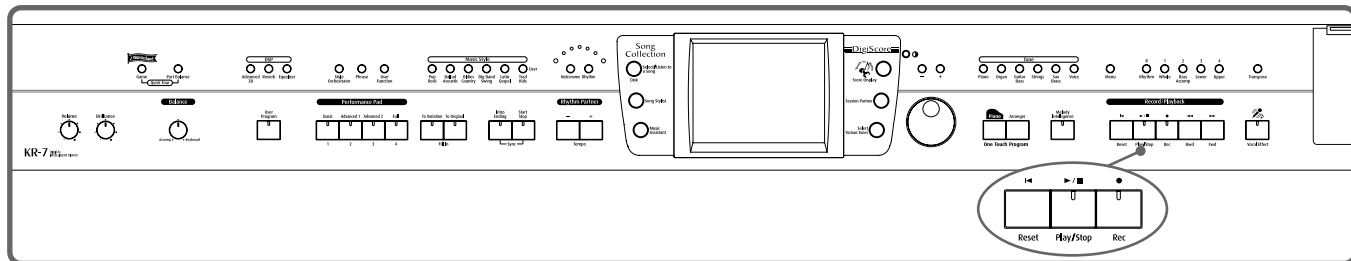

### Settings for recording performances

**1. Press One Touch Program [Piano] button.**

**2. Decide on the tone of the performance.**

Use the Tone buttons and the touch screen to select the tone.

When you have finished choosing the settings, touch <Exit> to display the Basic screen.

### Recording settings

**3. Press the [ ● (Rec) ] button.**

You press the [ ● (Rec) ] button and the following messages will appear, when a song has already been recorded.

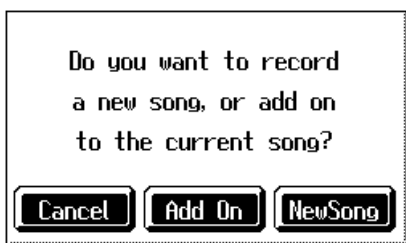

Touch <New Song>.

This switches the KR-7/5 to the settings required for recording a new song.

The KR-7/5 is put in recording standby.

To cancel recording, press the [ ● (Rec) ] button once more.

**4. Decide on the tempo and beat.**

If necessary, press the [Metronome] button to play the metronome.

When you have finished making the settings, touch <Exit> to display the Basic screen.

### Start recording

**5. Press the [ ▶/■ (Play/Stop) ] button.**

A two-bar count-in plays, then recording starts.

Even without pressing the [ ▶/■ (Play/Stop) ] button, recording starts when you play the keyboard. There is no count-in played when you start by playing rather than pushing the [ ▶/■ (Play/Stop) ] button.



If you select <New Song> when a song has already been recorded, the “OK to delete song?” prompt appears in the screen. For more detailed information, refer to “If the following screen appears” (p. 95).



When recording starts, the [ ▶/■ (Play/Stop)] and [ ● (Rec)] buttons' indicators light up.

### Stop recording

#### 6. Press the [ ▶/■ (Play/Stop)] button.

Recording stops.

The performance is recorded to the [1/Whole] button.

### Listening to the Recorded Performance

#### 7. Press the [ ◀ (Reset)] button, then press the [ ▶/■ (Play/Stop)] button.

The recorded performance is played back.

When you press the [ ▶/■ (Play/Stop)] button, playback stops.

#### NOTE

Any performance that has been recorded is deleted when the power to the KR-7/5 is turned off. If you do not want a performance deleted, then save it to a floppy disk or to Favorites (KR-7). Refer to "Saving Songs" (p. 106).

### Track buttons assignments for recorded performances

When you record only a keyboard performance, the performance will be assigned to the track buttons as follows.

- **Normal performance (playing a single Tone from the entire keyboard)**  
The performance is recorded to the [1/Whole] button.
- **Layer performance**  
The performance is recorded to the [1/Whole] button.
- **Split performance**  
The left-hand part of the keyboard is recorded to the [3/Lower] button, and the right-hand part of the keyboard is recorded to the [4/Upper] button.
- **Layer performance and Split performance**  
The left-hand part of the keyboard is recorded to the [3/Lower] button, and layer performance in the right-hand part of the keyboard is recorded to the [4/Upper] button.
- **Drum set or sound effect performance**  
Recorded on the [R/Rhythm] button.

## Recording With Accompaniment

Try recording a performance along with the Automatic Accompaniment.

### Settings for recording performances

**1. Press the One Touch Program [Arranger] button.**

This chooses the setting for Automatic Accompaniment.

**2. Decide on the Music Style.**

When you have finished choosing the settings, touch <Exit> to display the Basic screen.

### Recording Settings

**3. Press the [ ● (Rec)] button.**

You press the [ ● (Rec)] button and the following messages will appear, when a song has already been recorded.



Touch <New Song>.

This switches the KR-7/5 to the settings required for recording a new song.

The KR-7/5 is put in recording standby.

To cancel recording, press the [ ● (Rec)] button once more.

**4. Decide on the tempo.**

### Start recording

**5. Play a chord on the left-hand part of the keyboard.**

An Automatic Accompaniment intro starts, and recording starts at the same time.

### Stop recording

**6. Press the [Intro/Ending] button.**

An ending plays, then the Automatic Accompaniment, and recording stop at the same time.

### Listening to the recorded performance

**7. Press the [ ⏪ (Reset)] button, then press the [ ▶/■ (Play/Stop)] button.**

The recorded performance plays back.

When you press the [ ▶/■ (Play/Stop)] button, playback stops.



If you select <New Song> when a song has already been recorded, the “OK to delete song?” prompt appears in the screen. For more detailed information, refer to “If the following screen appears” (p. 95).



You can change how recording is stopped when recording a performance with Automatic Accompaniment. To learn how, see “Changing How Recording Stops” (p. 102).

### **Track buttons assignments for recorded performances**

Performances that have been recorded using Automatic Accompaniment are assigned to the track buttons as shown below.

Track button	Performance Recorded
<b>[R/Rhythm]</b>	The rhythm part of an Automatic Accompaniment is recorded here. In addition, drum sets and effect sounds that are selected with the keys in a performance are recorded to this track.
<b>[1/Whole]</b>	When using Piano Style accompaniment (p. 66), the performance played on the keyboard is recorded here.
<b>[2/ Bass Accomp]</b>	The Automatic Accompaniment bass part and accompaniment part are recorded here.
<b>[3/Lower]</b>	When the KR-7/5 is set so that sounds from performances on the left-hand side of the keyboard are played while the Automatic Accompaniment sounds (p. 51), your own performance on the left-hand side of the keyboard is recorded here.
<b>[4/Upper]</b>	Your own performance on the right-hand side of the keyboard is recorded here.



Music Styles are composed of five parts. For details, refer to “Music Styles and Automatic Accompaniment” (p. 50).

# Recording Along with a Song

Try recording along with internal songs and songs on disks.

Here, record your right-hand performance along with the song accompaniment.

### Settings for recording performances

Select a song before you begin recording.

When you have selected the song, press the [Score Display] button to display the score.

For more on how to select songs, refer to p. 69; for instructions on displaying the score, refer to p. 74.

## 1. Decide on the tone and tempo of the performance.

After choosing the settings, touch <Exit> to display the Basic screen.

### Recording settings

## 2. Press the [ ● (Rec)] button.

A screen like the one shown below appears.



## 3. Touch <Add On>.

With this setting, you can record while listening to the selected song.

### Selecting the track to record

## 4. Press the track button for the track that you want to record (i.e., the track that you want to play yourself).

The indicator of the button you pressed will blink, and the KR-7/5 enters recording-standby mode.

Since in this example we will record the right-hand performance, press the [4/Upper] button to make the button's indicator light blink.

To cancel recording, press the [ ● (Rec)] button once more.

### Start recording

## 5. Press the [ ▶/■ (Play/Stop)] button.

A two-bar count-in plays, then recording starts.

Even without pressing the [ ▶/■ (Play/Stop)] button, recording starts when you play the keyboard. There is no count-in played when you start by playing the keyboard instead of pushing the [ ▶/■ (Play/Stop)] button.

When recording starts, the [ ▶/■ (Play/Stop)] and [ ● (Rec)] buttons' indicators light.

### Stop recording

## 6. Press the [ ▶/■ (Play/Stop)] button.

Recording stops.



The song tempo is stored within the song you selected.



Only drum sets or SFX set are recorded to the [R/Rhythm] button.

## Listening to the recorded performance

7. Press the [ ◀ (Reset)] button, then press the [ ▶/■ (Play/Stop)] button.

The recorded performance is played back.

When you press the [ ▶/■ (Play/Stop)] button, recording stops.



Recorded performances are recorded to <0: (Song Name)>.

## Recording While Selecting the Track Buttons (Redoing Recordings)

When you want to re-record, specify the Track button for the performance you want to re-record, and then record again.

When you select a previously recorded Track button and re-record, everything from the point at which you begin recording up to the point where you stop recording will be replaced by the newly re-recorded performance.

1. Use the [ ◀◀ (Bwd)] and [ ▶▶ (Fwd)] buttons to go to the measure where you want to begin recording.

2. Press the [ ● (Rec)] button.

A screen like the one shown below appears.

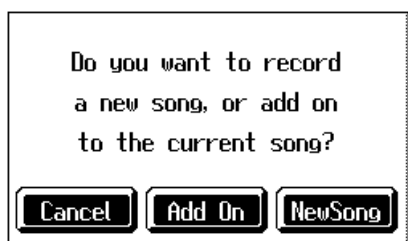

3. Touch <Add on>.
4. Press the Track button for the track you want to re-record.

The indicator for the selected Track button starts blinking.

The [ ▶/■ (Play/Stop)] button's indicator flashes, and the KR-7/5 is put in recording standby.

To cancel recording, press the [ ● (Rec)] button once more.

5. Press the [ ▶/■ (Play/Stop)] button to begin recording.

### Rerecording the accompaniment part of automatic accompaniment

When rerecording an Automatic Accompaniment performance, set Sync Start (p. 58), then specify a chord or press the [Start/Stop] button.

6. Press the [ ▶/■ (Play/Stop)] button to stop recording.

If you also want to rerecord the ending of the Automatic Accompaniment, press the [Intro/Ending] button.



When you want to record over again after deleting all of the previous recording, refer to "Erasing Recorded Performances" (p. 102).



The song tempo is stored within the song you selected. If you want to change the tempo of the recorded song, refer to "Changing the Tempo of Recorded Songs" (p. 132) and "Changing the Tempo Within the Song" (p. 132).

## Erasing Recorded Performances

You can use the following method to delete a recorded performance.

1. Hold down the [Select/Listen to a Song] button and press the [● (Rec)] button.

A screen like the one shown below appears.



2. Touch <OK>.

This deletes the recorded song.

When you touch <Cancel>, the previous screen appears and the recorded song is not erased.

### Erasing the Performance on Specific Tracks

You can select and erase performances on specific tracks.

1. Hold down the Track button for the track containing the performance you want to erase, then press the [● (Rec)] button.

The Track button's light goes dark, and the recorded music is erased.

## Changing How Recording Stops

When recording an Automatic Accompaniment performance, you can change the accompaniment and the way recording mode stops.

1. Press the [Menu] button and watch the indicator light up.

The Menu screen appears.

2. Touch <Rec Mode>.

A screen like the one shown below appears.

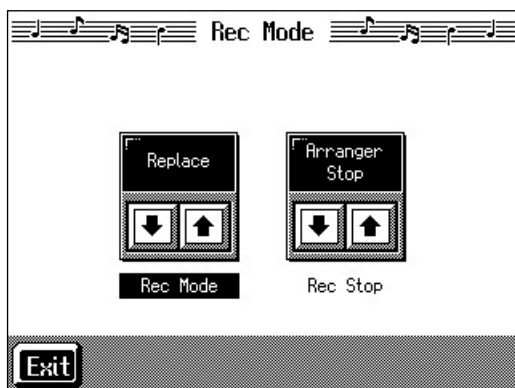

3. Touch <Rec Stop>   to switch between “Arranger Stop” and “Composer Stop.”

Display	Explanation
Arranger Stop	Recording stops at the same time the Automatic Accompaniment stops.
Composer Stop	Recording does not stop, even when the Automatic Accompaniment stops. When you press the [ ▶/■ (Play/Stop)] button, recording stops.

## Recording Songs Starting with Pickups

You can record songs that start with pickup beats (songs that start on a beat other than the measure’s first beat).

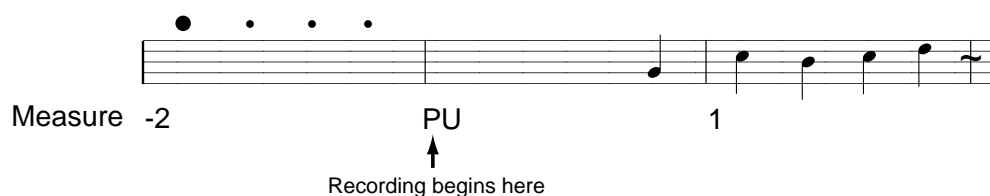

Carry out Steps 1–4 on p. 96 to prepare for recording.

If the [ ● (Rec)] button’s indicator is not lit, press the [ ● (Rec)] button so the indicator is lit.

The KR-7/5 is put in recording standby.

1. Press the [ ◀◀ (Bwd)] button one time.

The measure number in the upper right of the Basic screen changes to “PU,” and the KR-7/5 is set to record a song starting with a pickup.



Start recording. After a one-measure count, recording begins.

## Using Floppy Disks

You can use the KR-7/5's disk drive to save songs to floppy disks and listen to commercial music files.

### ■ Inserting and Ejecting a Floppy Disk

#### Inserting a floppy disk

1. With the front of the floppy disk facing up, insert the disk in the disk drive slot until there is an audible click.

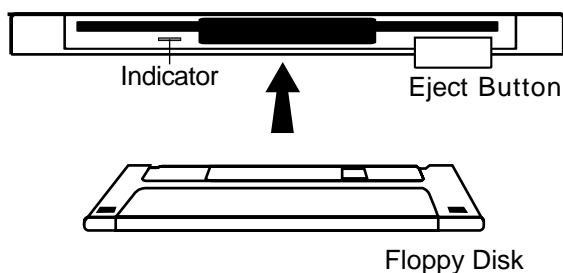

#### Removing a floppy disk

2. Press the Eject button.

The end of the floppy disk comes out of the slot. Grasp the edge of the floppy disk and gently pull it out.

### ■ Formatting Floppy Disks (Format)

A newly purchased floppy disk, or a floppy disk that has been used by another device cannot be used as is. Such floppy disks must be “formatted” (initialized) for use with the KR-7/5.

If a floppy disk is in a format that doesn't match the format of this unit, you won't be able to use that floppy disk.

#### MEMO

If you're using the disk drive for the first time, be sure to read the important notes on p. 6.

#### NOTE

Never remove the disk while it is being read or written. Doing so will scratch the magnetic surface of the disk, making it unusable. (The disk drive indicator will light brightly while data is being read or written. Normally, it will be lit dimly or will be dark.)

#### NOTE

When a floppy disk is initialized, all of the data saved on the disk is erased. If you're formatting a used floppy disk for reuse, be sure to check first to make sure the disk doesn't contain any data you don't want to lose.

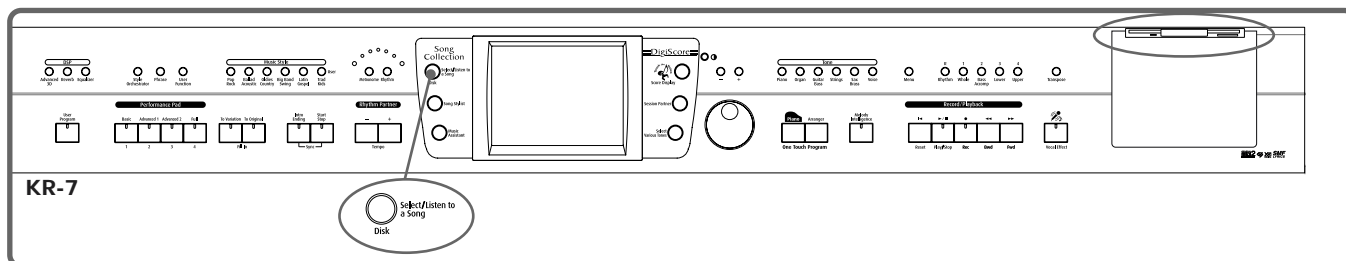

First make sure that the protect tab of the floppy disk is in the “Write (write enable)” position.

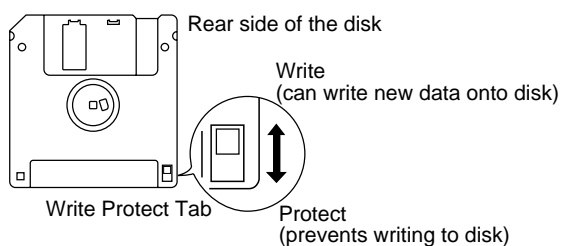



1. Insert the floppy disk into the disk drive.
2. Press the [Disk] button.
3. Touch <File>.

A “Song File screen” like the one below appears.

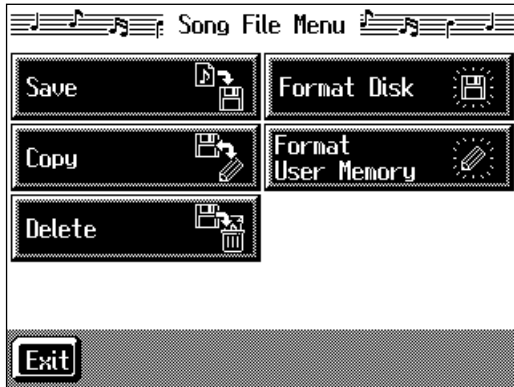

Display of the KR-7

4. Touch <Format Disk>.

The following screen appears.



5. Touch <OK>.

Initialization of the disk begins.

Touch <Cancel> to go back to the previous screen.

When initialization is completed, you're returned to the previous screen.

**NOTE**

Don't try to take the floppy disk out of the disk drive until the formatting process is finished.

**NOTE**

If “Error” appears on screen, take a look at “Error Messages” (p. 169).

## Saving Songs

A recorded performance is discarded when you switch off the power or choose another song. Storing recorded performances and other data to floppy disks or the Favorites (KR-7) is called “saving.” Be sure to save important songs to floppy disks or Favorites (KR-7).

### What are “Favorites?”

You can register songs you are currently practicing or particularly like to “Favorites,” allowing you to select these songs easily (p. 72).

On the KR-7, when you register a song on a floppy disk to Favorites, you can then play back the song without inserting the floppy disk in the disk drive.

If a recorded performance is saved to Favorites, the performance won’t be erased when the power is turned off.

### Preparations for Saving Data

When saving to floppy disks, first check to make sure that the floppy disk’s protect tab is set to the “Write” position (p. 104), then insert the floppy disk in the disk drive.

1. Press the [Disk] button.
2. Touch <File>.
3. Touch <Save>.

The following “Save Song screen” appears.

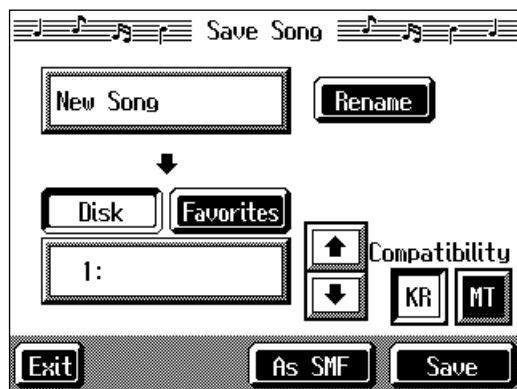

Display of the KR-7

#### MEMO

When using a new floppy disk, first initialize (format) the disk on the KR-7/5. Take a look at “Formatting Floppy Disks (Format)” (p. 104).

#### NOTE

Some commercially available music files cannot be saved because they are copy protected.

#### MEMO

If not handled with care, a floppy disk can be damaged, or the data on it become corrupted, making playback impossible. We recommend saving your songs on two different floppy disks.

#### MEMO



When you want to clear all of the content saved to the “Favorites” and restore the settings to the original factory condition on the KR-7, refer to “Formatting the User Memory (KR-7)” (p. 156).

**Determining the name of the song to be saved**

**4. Touch <Rename>.**

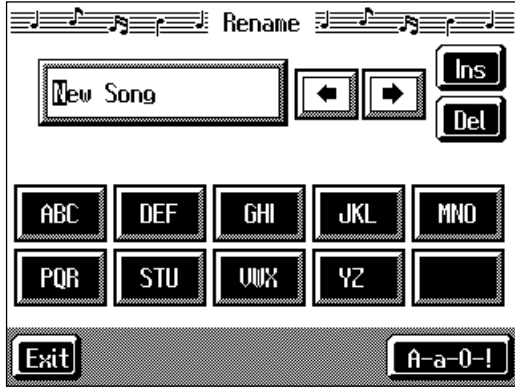
The following “Rename screen” appears.



When you touch  , the cursor moves.

When you touch the icon for the letter or character to be input, the character appears at the cursor location. For example touching <ABC> in succession cycles you through the available choices in that character group (“A”→”B”→”C”...).

Each touch of <A-a-0-!> cycles the type of characters through “English (upper case),” “English (lower case),” “numerals,” “symbols,” then back to “English (upper case).”

When you touch <Del>, the character at the cursor position is deleted.

When you touch <Ins>, a space is inserted at the cursor position.

**5. When you have finished with the name, touch <Exit>.**

**Determining the Save Destination**

**6. Touch <Disk> or <Favorites>. (KR-7)**

Touch <Disk> if you are saving to a floppy disk; touch <Favorites> if you are saving to Favorites.

**7. Touch   to select the save-destination song number.**

If a song name is displayed with a number a song is already saved to that number. If you select a number with a previously saved song and then proceed to save a new song, the previously saved song will be erased. If you do not want to lose a saved song, select a number with no song name indicated in the save-destination column.

## Selecting the tone compatibility format (when saving to disks)

### 8. Touch <KR> or <MT>.

Some Tones are unique to the KR-7/5. Data that is recorded using these tones may not play back correctly on other Roland Digital Pianos or Music Players. When you want to save data so that it can be played back on another devices, save the data with “MT” set as the Tone compatibility format.

Display	Explanation
KR	The song is saved as data capable of reproducing performances with richness of expression using the KR-7/5’s special Tones.
MT	Data is saved in a form that can also be played on the Roland Digital Pianos or Music Players other than the KR-7/5. You can listen to songs saved in this format on the Roland HP-G/R series and KR series keyboards as well as on Roland MT series devices.

#### <Note>

When data saved with “MT” as the Tone compatibility format is played back on this instrument, some of the nuances that were part of the performance at the time the data was recorded may be altered.

Even with data saved with “MT” as the Tone compatibility format, an exact reproduction of the original performance may be unobtainable when using GS devices other than Roland Pianos and Music Players.

## Save

### 9. Touch <Save> or <As SMF> to start saving.

The resulting file format will be different depending on whether <Save> or <As SMF> is chosen, as described below.

Display	Explanation
Save	Saves the song in KR-7/5 format. You can listen to songs saved in this format on the Roland HP-G/R series and KR series keyboards as well as on Roland MT series devices. This format is called “i-format”.
Save As SMF	Saves the song as an SMF (Standard MIDI Files). Songs saved in this SMF format can be listened to on many instruments that can play SMF music files (p. 189). A song recorded using commercial music files can’t be saved in “Save As SMF” format for reasons of copyright protection.

The time required for saving ranges from several seconds to half a minute or more. Don’t take the floppy disk out of the disk drive until the saving process is finished. Touch <Exit> to return to the Song File screen.

#### NOTE

You can only save songs in one format on a single floppy disk.

#### NOTE

**Never turn off the power while the saving operation is in progress. Doing so will damage the KR-7/5’s internal memory, making it unusable.**

#### MEMO

It’s a good idea to get into the habit of moving the write-protect tab on the floppy disk to the “Protect” position when you’ve finished saving your data. Keeping the tab at “Protect” prevents operations that could erase your songs by mistake.

#### NOTE

Depending on the playback instrument, some notes may drop out or sound different.

## Deleting Saved Songs

This deletes songs that have been saved on floppy disks, or to Favorites (KR-7).

To delete a song on a floppy disk, first insert the floppy disk in the disk drive.

**1. Press the [Disk] button.**

**2. Touch <File>.**

The “Song File screen” appears.

**3. Touch <Delete>.**

A “Delete Song screen” appears.



Display of the KR-7

**4. Touch <Disk> or <Favorites> (KR-7).**

Touch <Disk> if you are deleting a song from a floppy disk; touch <Favorites> if you are deleting a song from Favorites.

**5. Touch   to select the song to be deleted.**

**6. Touch <Delete>.**

A screen like the one shown below appears.



**7. Touch <OK>.**

The selected song is deleted.

Do not eject the floppy disk from the disk drive until the operation is finished.

Touching <Cancel> cancels the operation.

Touch <Exit> to return to the Song File screen.

**NOTE**

Never turn off the power while the operation is in progress. Doing so will damage the KR-7/5's internal memory, making it unusable.

## Copying Songs on Disks to Favorites (KR-7)

You can take songs saved on floppy disks and copy them to Favorites.

You can also copy songs in Favorites to floppy disks.

1. Insert the disk with the song to be copied in the disk drive.
2. Press the [Disk] button.
3. Touch <File>.
4. Touch <Copy>.

The following “Copy Song screen” appears.

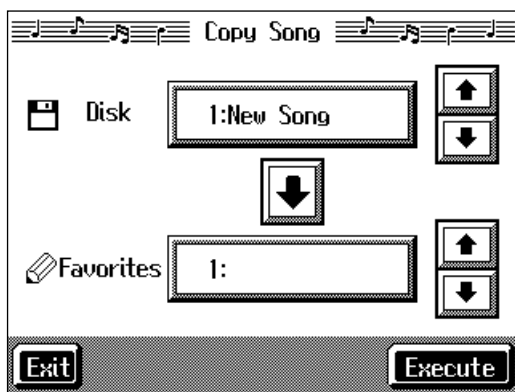

### Specifying the Copy Source

5. Touch the <Disk>   to select the song you want to copy.

When “Copy All” is selected, all of the songs on the disk are copied to Favorites.

### Specifying the Copy Destination

6. Touch <Favorites>   to select the copy destination for the song.

If a song name is displayed with a number, a song is already saved to that number.

If you select a number with previously saved song data and proceed to copy to that location, the previously saved song will be erased. If you don't want to erase a previously saved song, choose a number with no song name appears in the destination column.

7. Touch <Execute>.

Do not eject the floppy disk from the disk drive until the copy is finished.

The song from the disk is copied to Favorites.

#### NOTE

Never turn off the power while the operation is in progress. Doing so will damage the KR-7's internal memory, making it unusable.

## ■ Copying Songs Saved in Favorites to Disks (KR-7)

Songs that've been saved to Favorites can be copied onto floppy disks.

In this case, in the "Copy Song screen" in Step 4 above, touch the large arrow icon in the center to point the arrow upwards. This sets the KR-7 to copy the song in Favorites to the floppy disk.

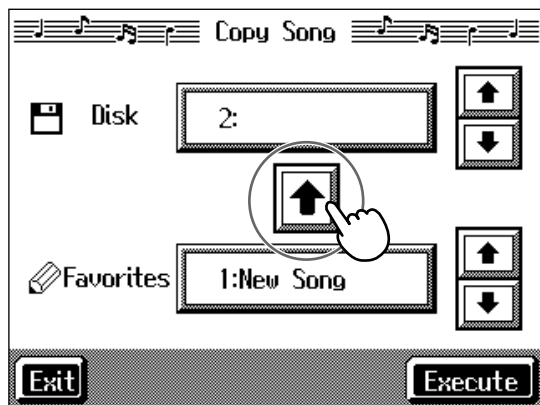

The rest of the procedure is identical to that used for copying songs from floppy disks to Favorites.

### MEMO

Some song data cannot copy because they are copy protected.

# Chapter 5 User Program Registration

## Saving Performance Settings (User Program)

Any collection of settings, including those describing the current status of your data selections or settings Automatic Accompaniment, can be saved to the [User Program] button. You can then call up the stored settings by pressing the [User Program] button. Saving your preferred combinations of Music Styles and Tones, as well as other frequently used settings, makes it more convenient.

You can register up to 36 User Programs to the KR-7/5.

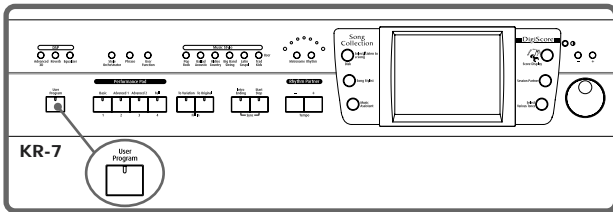

→ For more on what can be registered to a User Program, refer to “Parameters Stored in the User Program” (p. 188).

1. Set the Music Style, Tone, and other data until the settings are the way you want them.
2. Press the [User Program] button.

A “User Program screen” like the one shown below appears.



3. Touch <Write>.

A “Write User Program screen” like the following appears.



### Determining the name of the User Programs

4. Touch <Rename>.

A “Rename screen” like the following appears.

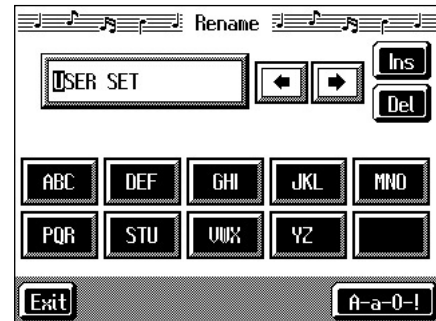

When you touch  , the cursor moves.

When you touch the icon for the character to be input, the character appears of the cursor position.

For example, touching the <ABC> icon in succession cycles you through the available choices in that character group (A→B→C→A...).

Each touch of <A-a-0-!> cycles the type of characters through “English (upper case),” “English (lower case),” “numerals,” “symbols,” then back to “English (upper case).”

When you touch <Del>, the character at the cursor position is deleted.

When you touch <Ins>, a space is inserted at the cursor position.

5. When you have finished with the name, touch <Exit>.

You're returned to the Write User Program screen.

### Determining the write destination

6. Touch   to select the write-destination number.

7. Touch <Write>.

The confirmation message appears.

8. Touch <OK>.

The current performance settings are saved to the [User Program] button.

\* Never turn off the power while the display indicates <Executing...>. Doing so will damage the KR-7/5's internal memory, making it unusable.

→ You can restore the content registered to the [User Program] button to the original factory settings. Refer to “Restoring the Factory Settings (Factory Reset)” (p. 155).



## Calling Up Saved User Programs

You can easily call up settings saved to the [User Program] button.

**1. Press the [User Program] button.**

The “User Program screen” appears.

**2. Touch the name of the User Program you want to call up.**

When you touch the name of the User Program, the buttons or other performance settings instantly change to the previously saved settings.

### ■ Changing the Way User Programs Are Called Up

When calling up User Programs, you can prevent the settings for Automatic Accompaniment from switching by not touching the touch screen for a few moments.

**1. Press the [User Program] button.**

**2. Touch <Option> in the lower part of the screen.**

A settings screen like the following appears.

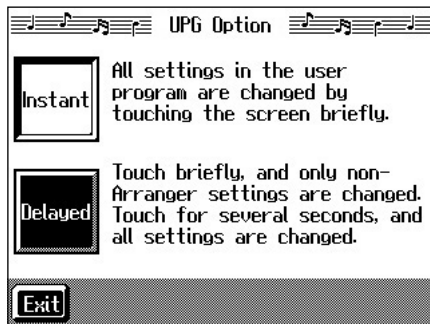

**3. Touch <Instant> or <Delayed> to select the setting.**

Display	Explanation
Instant	Immediately after a User Program name is touched, the Automatic Accompaniment settings also switch.
Delayed	The Automatic Accompaniment settings switch after you touch and read the User Program name for a few moments.

Touch <Exit> to return to the User Program screen.

## Saving the User Program Sets

You can take the 36 User Programs saved to the [User Program] button and save them as a set to a floppy disk, or to user memory (KR-7).

When saving to a floppy disk, first insert a floppy disk in the disk drive.

→ For more on working with the disk drive, refer to “Using Floppy Disks” (p. 104).

**1. Press the [User Program] button.**

**2. Touch <File>.**

**3. Touch <Save>.**

A “Save User Program screen” like the following appears.

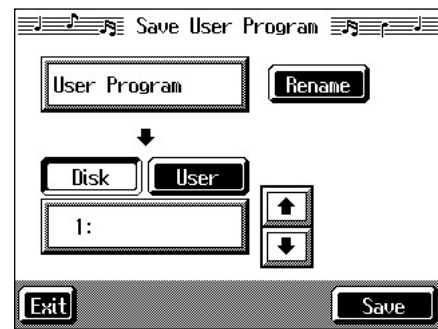

Display of the KR-7

### Giving a name to a set of User Programs

**4. Touch <Rename>.**

The Rename screen appears.

When you touch  , the cursor moves.

When you touch the icon for the character to be input, the character appears at the cursor position. For example touching the <ABC> icon in succession cycles you through the available choices in that character group (A→B→C→A...).

Each touch of <A-a-0!> cycles the type of characters through “English (upper case),” “English (lower case),” “numerals,” “symbols,” then back to “English (upper case).”

When you touch <Del>, the character at the cursor position is deleted.

When you touch <Ins>, a space is inserted at the cursor position.

**5. When you have finished with the name, touch <Exit>.**

### Determining the save destination

#### 6. Touch <Disk> or <User>. (KR-7)

Touch <Disk> if you are saving to a floppy disk; touch <User> if you are saving to user memory.

#### 7. Touch to select the save-destination User Program number.

If a User Program set name is displayed, a User Program set saved to that saved to that number is already.

If you select a number with previously saved User Program set data, then save a new set of data to that same number, the older User Program set will be deleted. If you don't want to lose any previously saved User Programs, select a number in the save-destination column that does not yet have a name.

### Save

#### 8. Touch <Save> to begin the save.

Touch <Exit> to return to the User Program File screen.

\* *Never turn off the power or eject the floppy disk from the disk drive while the operation is in progress. Doing so will damage the KR-7/5's internal memory, making it unusable.*

→ *When clearing the set of saved User Programs, refer to "Deleting Saved User Program Sets" (p. 115).*

## ■ Loading Saved User Program Sets

User Programs that have been saved on floppy disks or in user memory (KR-7) can be called up, on an individual set basis, to the [User Program] button.

\* *Note that calling up these User Programs results in the deletion of all User Programs currently recorded to the [User Program] button.*

When loading a set of User Programs from a floppy disk, first insert the floppy disk in the disk drive.

→ *For more on working with the disk drive, refer to "Using Floppy Disks" (p. 104).*

#### 1. Press the [User Program] button.

#### 2. Touch <File>.

#### 3. Touch <Load>.

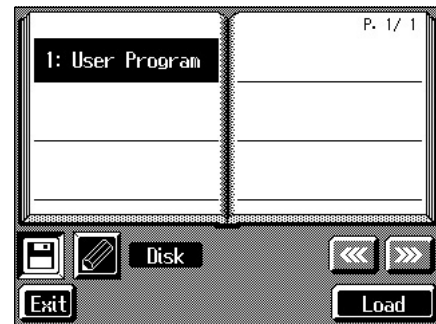

A "Load User Program screen" like the following appears.



Display of the KR-7

### Specifying the set of User Programs to be loaded

#### 4. Touch (Disk)> or (User)>. (KR-7)

Touch  > if you are loading User Programs from a floppy disk; touch  > if you are loading User Programs from the user memory.

#### 5. Touch the name of User Program to load.

#### 6. Touch <Load>.

The confirmation message appears.

#### 7. Touch <OK>.

The selected User Programs are loaded to the [User Program] button.

\* *Never turn off the power or eject the floppy disk from the disk drive while the operation is in progress. Doing so will damage the KR-7/5's internal memory, making it unusable.*

## Deleting Saved User Program Sets

You can delete individual User Program sets saved to floppy disks or in user memory.

When deleting a set of User Programs on a floppy disk, first insert the floppy disk in the disk drive.

→ For more on the use of the disk drive, refer to “Using Floppy Disks” (p. 104).

1. Press the [User Program] button.
2. Touch <File>.
3. Touch <Delete>.



A “Delete User Program screen” like the following appears.



Display of the KR-7

4. Touch <Disk> or <User>. (KR-7)

Touch <Disk> if you are deleting User Programs from a floppy disk; touch <User> if you are deleting User Programs from the user memory.

5. Touch   to select the set of User Programs to be deleted.
6. Touch <Delete>.

A screen like the one shown below appears.



7. Touch <OK>.

The selected User Programs are deleted. Touching <Cancel> cancels deleting the file.

\* Never turn off the power or eject the floppy disk from the disk drive while the operation is in progress. Doing so will damage the KR-7/5's internal memory, making it unusable.

## Copying Sets of User Programs on Disks to the User Memory (KR-7)

You can copy sets of User Programs saved on floppy disks and to user memory.



You can also copy sets of User Programs saved in user memory and to floppy disks.

1. Insert the disk with the settings to be copied in the disk drive.
2. Touch the [User Program] button.
3. Touch <File>.
4. Touch <Copy>.

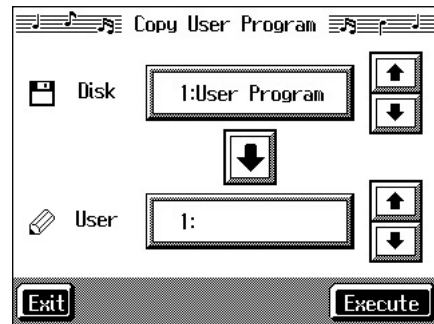
A “Copy User Programs screen” like the following appears.



### Specifying the copy source

5. Touch <Disk>   to select the set of User Programs you want to copy.

When “All” is selected, all of the sets of User Programs on the disk are copied to user memory.

### Specifying the copy destination

6. Touch <User>   to select the copy destination for the set of User Programs.

If a User Program name is displayed, already a User Program saved to that number is already. If you select a number with User Programs data, and then copy data to that number, the previously saved User Programs are deleted. If you do not want to delete the saved User Programs, select a number in the save-destination column for which no name is displayed.

7. Touch <Execute>.

The set of User Programs on the disk is saved to user memory.

\* Never turn off the power or eject the floppy disk from the disk drive while the operation is in progress. Doing so will damage the KR-7's internal memory, making it unusable.

### ■ Coping Sets of User Programs Stored in the User Memory to Disks (KR-7)



You can take User Program sets saved in user memory and copy them to floppy disks.

In this case, in the Copy User Programs screen in Step 4 above, touch the large arrow icon in the center to get the arrow to point up. This sets the KR-7 to copy the User Program set in the user memory to the floppy disk.

The rest of the procedure is identical to that used for copying sets of User Program set from disks to user memory.

### Using the Pedal to Switch User Programs

You can use the Pedal as a dedicated switch for selecting User Programs in order.

1. Press the [User Program] button.
2. Touch <Option> in the lower part of the screen.
3. Touch   to display screen like the following.

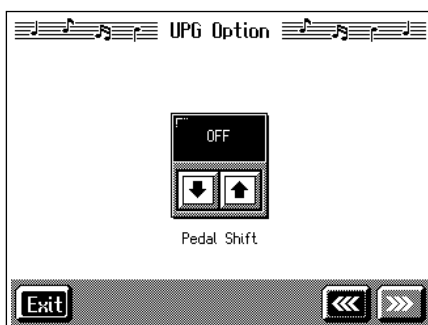

4. Touch   to select the setting.

Display	Explanation
Off	You can use a function assigned to the pedal.
Left Pedal	The left pedal is dedicated to switching User Programs. The function assigned to the left pedal cannot be used.
Center Pedal	The center pedal is dedicated to switching User Programs. The function assigned to the center pedal cannot be used.

Touch <Exit> to return to the User Program screen.

### Simultaneously Switching User Program and Transmitting PC Numbers

You can have PC (Program Change) numbers be transmitted to an external MIDI device when you switch the User Program on the KR.

You can register PC number settings to each of the User Programs, just as you can with button settings and other settings preferences.

#### Calling Up the Performance Settings to Be Set



1. Press the [User Program] button, then touch the name of the performance setting you want to set.

#### Setting the Transmission of the PC

2. Touch <PC Set> in the User Program screen.

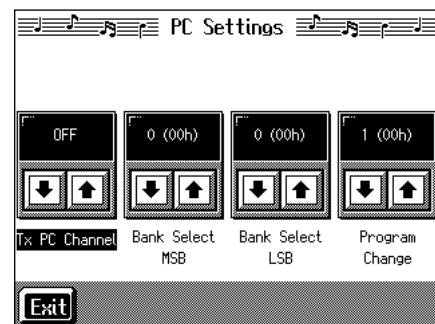
The following type of screen appears.



3. Touch   for the parameter and make the settings.

Display	Description
Tx PC Channel	This prevents the PC number from being transmitted (Off), or sets the transmission channel (Channel 1–16).
Bank Select LSB	Sets the Bank Select LSB.
Bank Select MSB	Sets the Bank Select MSB.
Program Change	Sets the Program Change messages (Program Numbers).

4. Touch <Exit>.

The User Program screen returns to the display.

Touch <Write> to save the setting to the User Program. For more detailed information, refer to “Saving Performance Settings (User Program)” (p. 112).

# Chapter 6 Creating and Editing Songs

## Multitrack Recording with 16 Parts (16-Track Sequencer)

Multitrack recording always you to listen to previously recorded material while continuing to add performances of other parts.

The KR-7/5 is capable of multitrack recording of up to sixteen parts. Since each part's performance is recorded using one tone, you can layer performances, using up to sixteen tones for the data in one song. The function used to layer these sixteen parts, one at a time, is called the "16-Track Sequencer."

### 16-Track Sequencer

You can record their performances for up to 16 parts, overlaying them part by part, to create a single song.

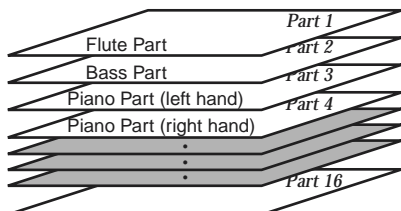

### 16-Track Sequencer and Track Buttons

In addition to the "16-Track Sequencer" function, the "Track Buttons" (p. 86) are another of the unit's playing/recording functions.

These five "Track buttons" are used for organizing the 16-Track Sequencer's sixteen parts. This allows you to use the 16-Track Sequencer to add more sounds to performances recorded with the Track buttons, and make even more detailed edits of the songs.

You can easily play back the original song data with the 16-Track Sequencer, mute parts by pressing the Track buttons, and more.

The Track buttons correspond to 16-track sequencer parts as shown below.

Track button	Part
[R/Rhythm]	D (10), S (11)
[1/Whole]	1
[2/Bass Accomp]	2, 5-9, 12-16
[3/Lower]	3
[4/Upper]	4

Since the 16-Track Sequencer records one tone to one part, you cannot use Layer performance (p. 28), Split performance (p. 29), or other such functions to record two or more tones simultaneously. Also, you can't record the performance with Automatic Accompaniment.

When you want to record with Automatic Accompaniment, then you should use the Track buttons for recording. (Refer to "Recording With Accompaniment" (p. 98))

### Commercially Available Music Files

Commercially available song file recorded in Roland's SMF format is also composed of sixteen parts.

By loading the song file from the floppy disk and using the 16-Track Sequencer, you can then also edit the song file.

→ *Although with commercially available Roland SMF music data, Part 11 is included in the [2/Bass Accomp] track button, other tracks match to the corresponding Track buttons.*

\* *With some commercially available music files, you cannot edit the data.*

## ■ The 16-Track Sequencer Screen

When recording with 16-track Sequencer, display the 16-track Sequencer screen.

### 1. Press the [Menu] button.

The Menu screen appears.

### 2. Touch <16trk Sequencer>.

A "16-track Sequencer screen" like the one shown below appears.

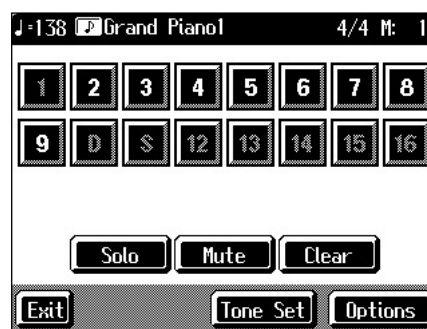

Icon	Description
<1> <16>	Touch to select the part to be recorded, or the part whose settings are to be changed. The Part you choose appears is highlighted.
2	This Part to be played back
-	The Part not to be played back (Muted Part)
2	Parts that do not have performance data recorded to them.
Solo	Only the selected Part is played back.
Mute	This allows you to prevent the sound for the selected part from playing.
Clear	The performance data for the selected part is deleted.
Options	This displays the Part Settings screen, in which you can make detailed settings for each part. For details refer to p. 118.

Icon	Description
	The Tone Set screen appears. For details refer to p. 119.

## ■ Modifying the Settings of Each Part

You can change the Tones and volume, as well as mute the playback, for each individual part in songs recorded with the 16-track Sequencer and the internal songs.

→ Because commercially available Roland SMF music files are also made up of 16 Parts, you can change the settings for the individual Parts and play them back in the same way.

First, select the song for which the settings are to be made (p. 69).

1. Display the 16-track Sequencer screen (p. 117).
2. Touch the screen to choose the Part for which you want to make settings.

Change the settings for the selected Part.

Display	Function
<b>Solo</b>	Only the selected Part is played back.
<b>Mute</b>	Toggles playback of the selected Part to on or off.
<b>Clear</b>	The performance data for the selected part is deleted.

\* When you touch <Clear>, a message asking you to confirm the deletion appears. To erase the recorded sound, touch <OK>. If you don't want to erase the recorded sound, touch <Cancel>. Once a performance has been erased, it can't be restored.

3. Touch <Options> to make more detailed settings for the selected part.

A screen like the one shown below appears.

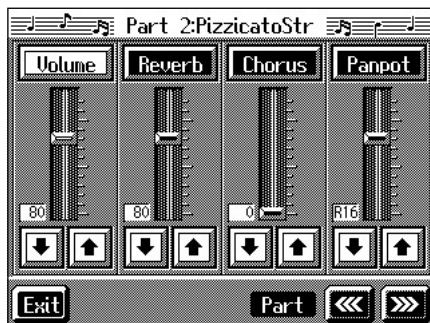

You can change the Tone for the selected Part by pressing a Tone button while this screen is displayed. When selecting Part 10 or 11, you can touch <Drum Set> to select the drum set or effect sound. The Part name and tone name are displayed at the top of the screen.

4. Touch for the corresponding item to change the setting.

You can also change the values by touching each parameter slider and then using the [-] [+] buttons and the dial.

Display	Description
<b>Volume</b>	Changes the volume level.
<b>Reverb</b>	Changes the amount of reverb effect applied to the sound.
<b>Chorus</b>	Changes the amount of chorus applied.
<b>Panpot</b>	Shifts the direction from which the sound is heard between left and right. Touch  to shift the sound to the right, or touch  to shift it to the left.

### What's Panpot?

Panpot is the control that determines the placement of the sound in the stereo sound field between left and right speakers. By altering the Panpot setting, you can change the perceived location of the sound between the left and right speakers.

When you press the [▶/■ (Play/Stop)] button, you hear what the song sounds like as you change the settings. When you press the [▶/■ (Play/Stop)] button, playback of the song stops.

5. Touch to make settings for other parts.  
The Part name appears at the upper part of the screen. Change the settings for other parts as needed.
6. Hold down the [● (Rec)] button and press the [⏪ (Reset)] button.

This operation set the changes in the settings.

The song can then be saved to a floppy disk or to user memory (KR-7).

If you do not want to delete a song after changing the settings for the individual parts, save the song to a floppy disk or to user memory (p. 106).

\* You cannot save the settings that determine whether sounds for each individual part are played or not (solo and mute).

**If the following message appears**

If you try to display another screen after you've changed the song's settings for each Part, a message like the one below may appear.



Touch <OK> to change the song's settings.

Touch <Cancel> to discard the changes you're made.

**Getting the Most Suitable Part Tones for the Musical Genre (Tone Set)**

"Tone Set" is a function that automatically assigns the most suitable tones for the selected musical style.

When you're creating a song, you can assign Tone sets, then change the Tones to suit the ideas you have for your song.

1. Display the 16-track Sequencer screen (p. 117).
2. Touch <Tone Set> in the lower part of the screen.

A screen like the one shown below appears.

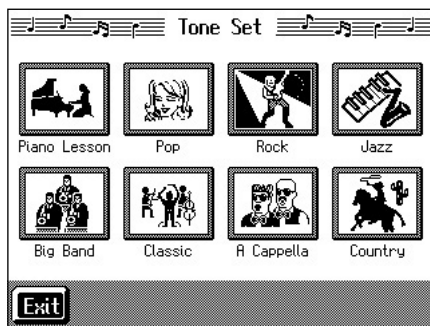

3. Touch the screen to select a musical genre.
4. Touch <Exit>.

The 16-track Sequencer screen appears.

Tones for each part are assigned automatically.

\* In some genres, some parts may have no tone assigned.

**Recording a Performance**

**Step 1 Prepare for Recording**

**Selecting the song to record**

1. Press the [Select/Listen to a Song] button.
2. Touch the genre of the song you're recording.  
When recording a new song, try recording to "Favorites."
3. Select the song number to which you want to record.

If recording a new song, touch <0: (Song Name)> to select <0: New Song>.



→ If a song has already been recorded, or if the song's settings have been changed, the "OK to delete Song?" confirmation prompt appears when you touch <0: (Song Name)>. For more information, take a look at "If the following screen appears" (p. 95).

**Determining the song's beat and tempo**

4. Press the [Metronome] button to select the beat (p. 44).  
→ You can't change a song's beat once it's been recorded. If you want to compose a song whose beat changes partway through the song, take a look at "Changing the Beat in the Middle of a Song (Beat Map)" (p. 131).
5. Press the Tempo [-] and [+] buttons to set the basic tempo of the song.

If you do not need the metronome sound, press the [Metronome] button once more.

→ When using song data that has already been recorded, the recording is made using the source song's basic tempo. To change the basic tempo of a song, please refer to "Changing the Tempo of Recorded Songs" (p. 132).

### ○ Step 2 Start Recording

If necessary, choose a recording method.

For more on how to record, refer to p. 120.

If you record for the first time, there's no need to select the recording method.

### Selecting the Part to Record

#### 1. Display the 16-track Sequencer screen (p. 117).

#### 2. Touch the number for the Part you want to record.

The Part you touch appears in reverse video.

You can only record drum sounds or effect sounds on Part D (10) or Part S (11). You can select drum sets or effect sounds by selecting Part D (10) or Part S (11) and touching <Drum Set>.

### Selecting the sound to play

#### 3. Use the Tone buttons to choose a Tone to play.

After selecting a Tone, touch <Exit> to call up the "16-Track Sequencer screen."

### Recording the performance

#### 4. Press the [ ◀ (Reset)] button.

Recording will start at the beginning of the song.

If you want to record from a point other than the beginning, use the [ ◀◀ (Bwd)] and [ ▶▶ (Fwd)] buttons to select another measure to begin.

#### 5. Press the [ ● (Rec)] button and watch the indicator is light up.

The KR-7/5 is put in recording standby.

#### 6. Press the [ ▶/■ (Play/Stop)] button.

A two-bar count-in sounds, then recording starts.

\* You cannot use the performance pads when recording with the 16-track sequencer.

#### 7. Press the [ ▶/■ (Play/Stop)] button.

Recording stops.

When one part is recorded, continue by selecting and recording another part. Continue layering parts to finish recording the song.

→ You only need to follow the procedure described in "Step 1 – Prepare for Recording" when you're recording the first Part. For the second Part and after, you can skip step 1 and proceed from "Step 2 Start Recording."

\* Any performance that has been recorded is deleted when the power to the KR-7/5 is turned off. It is a good idea to save song data to a floppy disk or user memory. For more information, refer to "Saving Songs" (p. 106).

## Changing the Recording Method (Rec Mode)

You can use any of the four methods below to record with the KR-7/5.

Although you will normally be using "Replace Recording," where previously recorded material is erased when new sounds are recorded, you'll find that you can record songs easily by using this method in combination with other recording methods.

### Replace Recording (p. 121)

This is the normal method for recording. New material is recorded as previously recorded material is erased.

### Mix Recording (p. 121)

New notes are recorded on top of notes previously recorded.

This convenient feature makes it easy for you to record melodies over prerecorded accompaniment.

### Loop Recording (p. 122)

Specified measures are recorded repeatedly, while new notes are combined with existing music. A convenient feature for creating rhythm parts. Loop Recording allows you to record over and over within a selected segment, adding a different percussion sound with each pass.

### Punch-in Recording (p. 123)

You can re-record only a specified passage as you listen to a recorded performance.

→ Immediately after the power is turned on, Replace Recording is selected.



### Changing the Recording Method

1. Press the [Menu] button.

The Menu screen appears.

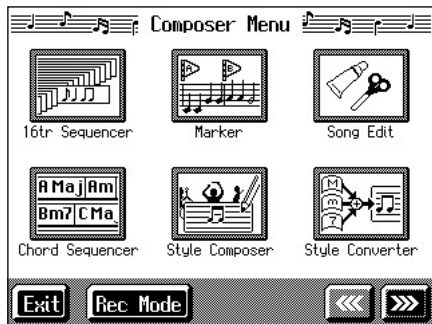



Display of the KR-7

2. Touch <Rec Mode>.

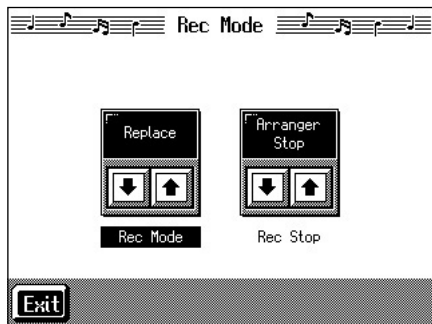
A "Rec Mode screen" like the following appears.



3. Touch <Rec Mode>   to select the recording mode.

Display	Recording Method
Replace	Replace Recording
Mix	Mix Recording
Loop	Loop Recording
Auto Punch-In/Out	Punch-in recording of the interval between set markers
Manual Punch-In/Out	Punch-in recording starting from the point at which the pedal, the Performance Pad or the [ ● (Rec) ] button is pressed For more about Punch In Recording, refer to p. 123.
Tempo	You can add tempo changes to a recorded composition. See p. 132.

4. Touch <Exit>.

Returns to the Menu screen.

### Recording While Erasing the Previous Recording (Replace Recording)

The recording process where previous material is erased as new material is recorded is called "replace recording." This setting is in effect when you turn on the power.

1. In the "Rec Mode screen" (p. 121), select <Replace>.

Touch <Exit> to return to the Menu screen.

The KR-7/5 is set to the replace recording mode.

Record the performance using the procedures described in Chapter 4 (p. 95), "Multitrack Recording with 16 Parts (16-Track Sequencer)" (p. 117).

### Layering a Recording Over Previously Recorded Sounds (Mix Recording)

You can record a performance layered over a previously recorded performance. This method is called "Mix Recording."

1. In the "Rec Mode screen" (p. 121), select <Mix>.

Touch <Exit> to return to the Menu screen.

Record the performance using the procedures described in "Recording While Selecting the Track Buttons (Redoing Recordings)" (p. 101), "Multitrack Recording with 16 Parts (16-Track Sequencer)" (p. 117), or other methods.

\* After you have finished with mix recording, return to the usual replace recording mode.

### ■ Repeated Recording at the Same Location (Loop Recording)

You can record a specified passage over and over, layering sounds with each pass. This method is called “Loop Recording.” This is handy when recording a Rhythm Part.

For example, use this method to make a Loop Recording of a four-measure segment. First record the bass drum, the snare drum next, then the hi-hat and so on, layering a different instrument onto the same four measures. After you have finished recording the four-measure rhythm pattern, you can then use the procedure in “Copying Measures (Copy)” (p. 126) to create as many copies of the four measures as you need to complete your Rhythm part.

#### 1. Place A and B markers at the beginning and end of the passage you want to record.

Take a look at “Setting Markers for Repeated Practice (Marker)” (p. 87).

If you haven’t recorded anything yet, then use “Blank Recording” to create the necessary number of measures before placing the markers.

#### What is Blank Recording?

Blank Recording is recording a number of silent measures with no content.

1. Set the basic tempo and beat of the song.
2. Hold down the [ ● (Rec)] button and press the [ ▶/■ (Play/Stop)] button.

The indicators for the [ ● (Rec)] and [ ▶/■ (Play/Stop)] buttons both light up, and recording starts.

3. Without performing anything, record only the required number of measures, then press the [ ▶/■ (Play/Stop)] button.

The indicators for the [ ● (Rec)] and [ ▶/■ (Play/Stop)] buttons both go out, and recording stops.

#### 2. In the Rec Mode screen (p. 121), select <Loop>.

Touch <Exit> to return to the menu screen.

The recording method changes to loop recording.

#### 3. Press the [ ● (Rec)] button.

#### 4. Press the Track button for the track to be recorded.

The KR-7/5 is put in recording standby.

#### 5. Press the [ ▶/■ (Play/Stop)] button to begin recording.

Recording starts from Marker A.

When the song reaches Marker B, it then returns to Marker A, where recording continues.

Each time the recording is looped, the newest sounds are layered over previously recorded sounds.

#### 6. When you press the [ ▶/■ (Play/Stop)] button, recording stops.

\* After you have finished with loop recording, return to the usual replace recording mode (p. 121).

#### Loop Recording Shortcut

You can also use the method described below to set Loop Recording.

#### 1. Place A and B markers at the beginning and end of the passage you want to record.

Take a look at “Setting Markers for Repeated Practice (Marker)” (p. 87).

If you haven’t recorded anything yet, then perform “Blank Recording” for the necessary number of measures before placing the markers.

#### 2. Touch the <Repeat> icon in the Marker screen (p. 87).

This sets the loop recording mode.

Start a recording.

\* After you have finished with loop recording, touch the <Repeat> icon in the “Marker screen” once more to return to the usual replace recording mode.

## ■ Re-Recording Part of Your Performance (Punch-in Recording)

You can re-record part of a passage as you listen to a recorded performance. This recording method is called “Punch-in Recording.” This convenient function lets you record over a specified points in a part as you listen to a prerecorded performance in another section.

User Punch-In Recording by the following two methods:

### Recording the Region Defined by Markers A and B (Auto Punch-In/Out)

Before you start recording, place markers A and B to define the passage you want to re-record. Make the setting for punch-in recording, and re-record just the passage between markers A and B.

### Recording From the Point at Which the Pedal or Buttons Are Pressed (Manual Punch-In/Out)

You can play back a performance and depress the pedal at the desired place to start re-recording. Depressing the pedal a second time cancels recording and returns you to playback.

When you use the Performance Pads or [ ● (Rec)] button, recording begins when you press the Pad or button upon reaching a specified point in the song.

When you press the Pad or [ ● (Rec)] button once more, the KR-7/5 exits recording mode and returns to normal playback.

### ○ Recording a Passage Specified by Markers

#### 1. Before you start re-recording, place markers A and B to define the passage.

Following the procedures described in “Setting Markers for Repeated Practice (Marker)” (p. 87), use Markers A and B to specify the passage.

#### 2. In the Rec Mode screen (p. 121), select <Auto Punch-In/Out>.

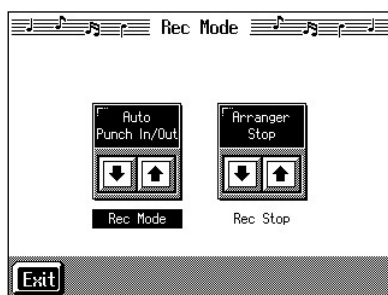

This changes the recording mode to “Punch-In Recording.”

Touch <Exit> to return to the Menu screen.

#### 3. Begin recording.

Begin recording using the procedures described in “Recording While Selecting the Track Buttons (Redoing Recordings)” (p. 101) or “Multitrack Recording with 16 Parts (16-Track Sequencer)” (p. 117).

Up until the specified passage, the previously recorded performance plays back.

When you reach the specified passage, sounds are erased as recording starts; begin playing now.

When you reach the end of the specified passage, recording stops, and the KR-7/5 returns to playback of the previously recorded performance.

#### 4. When you press the [ ▶/■ (Play/Stop)] button, the song stops.

### ○ Starting Recording from the Measure Specified by Buttons and Pedals

If using the Performance Pads or pedals, you must first change the function of the pedals and Pads. Follow the procedures in “Assigning Functions to Pedals and Performance Pads (Pedal Setting/User Functions)” (p. 147), and assign <Auto Punch-In/Out> to the buttons or pedal.

#### 1. In the Rec Mode screen (p. 121), select <Manual Punch-In/Out>.

This changes the recording mode to “Punch-In Recording.”

Touch <Exit> to return to the Menu screen.

#### 2. Begin recording.

Begin recording using the procedures described in “Recording While Selecting the Track Buttons (Redoing Recordings)” (p. 101) or “Multitrack Recording with 16 Parts (16-Track Sequencer)” (p. 117).

The previously recorded performance will be played back.

Recording begins when you press the pedal, the Performance Pad, or the [ ● (Rec)] button; start re-recording at this time.

Recording stops when you press the pedal, the Performance Pad, or the [ ● (Rec)] button again, and the previously recorded performance is played back.

#### 3. When you press the [ ▶/■ (Play/Stop)] button, the performance stops.

\* When you're finished with Punch-In Recording, return to the ordinary Replace Recording mode. Take a look at “Changing the Recording Method” (p. 121).

## Composing an Accompaniment By Entering Chords (Chord Sequencer)

You can enter a chord progression and choose the places where the accompaniment pattern will change to create an accompaniment for a song. This feature is called “Chord Sequencer.”

Thanks to the chord sequencer, you can create an accompaniment ahead of time and play along with your right hand.

**1. Press the [Menu] button and watch the indicator light up.**

The Menu screen appears.

**2. Touch <Chord Sequencer>.**

The screen like the one shown below is called “Chord Sequencer screen.”

This is the “cursor.” The cursor shows where the chord change or other information is input.

This is the end of the song. When continuing to add input, insert measures by touching <Ins>.

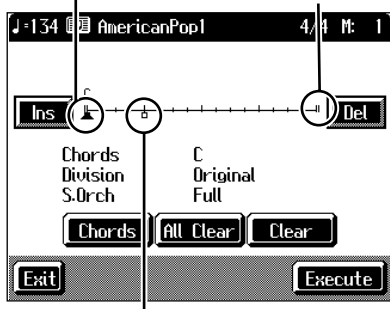

This indicates the position where the accompaniment pattern (Division) or the Style Orchestrator changes.

**4. Touch <Exit>.**

You are returned to the Chord Sequencer screen.

**5. Enter the chord progression and the accompaniment pattern.**

Refer to “Inputting Chords with the Chord Sequencer.”

**6. When you have finished inputting all the data, touch <Execute>.**

The accompaniment you’ve composed is registered at “0: New Song.”

When storage of the data is complete, return to the Menu screen.

Now, press the [▶/■] (Play/Stop) button, and try playing the melody along with the accompaniment you created.

\* *Songs you’ve created are discarded as soon as you turn off the power. If you do not want to delete the song, save it to a floppy disk or to user memory. Refer to “Saving Songs” (p. 106).*

### Inputting Chords with the Chord Sequencer

Change the accompaniment arrangements

Move the cursor

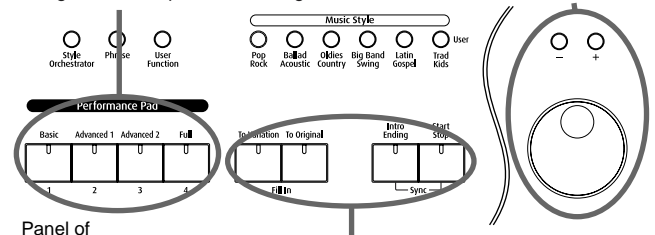

Panel of the KR-7

Select the accompaniment pattern (Division)

**1. Use the [+ ] [- ] buttons or the dial to move the cursor to the input position.**

Use the [◀◀] (Bwd) and [▶▶] (Fwd) buttons to move the cursor one measure at a time.

**2. Enter the chord progression and the changes in the accompaniment pattern and arrangement.**

Just as when performing with Automatic Accompaniment, press the keys to specify a chord, and press a button to select the accompaniment pattern (p. 61). You can change the Style Orchestrator with the Performance Pads (p. 62).

**3. Touch <Ins> once to insert one measure before the measure where the cursor is currently positioned.**

If you touch <Del>, the measure where the cursor is currently positioned is deleted, while the measures that follow are moved forward.

To remove what you have input, move the cursor to the position with input you want to delete, then touch <Clear>. This deletes the entered setting.

Display	Description
Ins	One measure is inserted before the measure where the cursor is positioned.
Del	The measure in which the cursor is positioned is deleted.
Chords	Allows input of chords without playing the keyboard. Refer to “Inputting Chords without Playing the Keyboard” (p. 125).
All Clear	Deletes all of the data that’s been input.
Clear	Deletes the data at the cursor position.
Execute	Records the input chord progression. Touch this icon when you have finished inputting all of the chords.

**3. Press a Music Style button or the touch screen to select a Music Style (p. 54).**

→ You can only insert an intro at the beginning of a song. When you add an intro, the number of bars corresponding to the length of the intro is inserted automatically.

### Functions That Can Be Assigned to the Pedals and the Performance Pads

→ For instructions on assigning functions, refer to “Assigning Functions to Pedals and Performance Pads (Pedal Setting/ User Functions)” (p. 147).

- Inputting a short Intro and Ending  
Assign “Intro 2/Ending 2” to a pedal or pad.
- Inputting a “Variation” or “Original” without a Fill-In  
Assign “Original/Variation” to a pedal or pad.
- Using the keyboard to input slash chords (such as Fm/C)  
Assign “Leading Bass” to a pedal or pad.
- Inputting a break somewhere within the song  
Assign “Break” to a pedal or pad.

### Check the accompaniment you inserted

Here’s how to play back as much of the accompaniment as you have input.

1. Press the [ ◀ (Reset)] button to return to the beginning of the song.
2. When you press the [ ▶/■ (Play/Stop)] button, the performance is played back.
3. Playback stops when you press the [ ▶/■ (Play/Stop)] button once more.



## Inputting Chords without Playing the Keyboard

You can use <Chords> at the bottom right of the Chord Sequencer screen to specify chords on the screen.

1. At the Chord Sequencer screen, touch <Chords>.

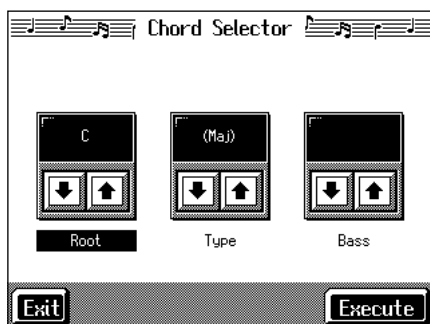
A screen like the one shown below appears.



2. Touch   in each to specify the chords.
3. Touch <Execute> to enter the chord.

You are returned to the Chord Sequencer screen.

## Editing Songs

There are many ways you can edit performances recorded using the KR-7/5 Track button or 16-track sequencer.

### Basic Operation of the Editing Functions

- \* While songs are being loaded, the measure number in the upper right of the screen is highlighted (text and background are inverted). Start editing the song only after the measure number is no longer highlighted.

#### Selecting the editing function

1. Press the [Menu] button and watch the indicator light up. The Menu screen appears.
  2. Touch <Song Edit>.
- A “Song Edit screen” like the following appears.



3. Touch an editing function to select that function.

For more detailed information, refer to the corresponding page for each function.

Function	Description	Page
Undo	Undoes editing operations that have been performed.	p. 126
Copy	Copies measures and internal rhythm patterns.	p. 126, p. 127
Quantize	Evens out sounds in recorded performances.	p. 127
Delete	Deletes measures.	p. 128
Insert	Inserts a blank measure.	p. 128
Transpose	Transposes parts individually.	p. 129
Erase	Erases data in measures, creating blank measures.	p. 129
Part Exchange	Exchanges the sounds in parts.	p. 130
Note Edit	Allows corrections to be made note by note.	p. 130
PC Edit	Allows editing of the Tones changes that occur during a song.	p. 131

## Chapter 6 Creating and Editing Songs

→ "PC" stands for "Program Change," which is a command that tells an instrument to change the sound it's using. With songs that rely on the use of a variety of sounds, a "PC" needs to be located at every point within the song where the Tone is to be changed

\* Some edits can't be undone, not even by choosing "Undo." We recommend saving songs to floppy disks or to user memory before editing. For more on how to save songs, refer to "Saving Songs" (p. 106).

### Editing

#### 4. Touch the item to be edited.

The value for the item being edited is highlighted.

#### 5. Set the value with the [-] [+] buttons or the dial.

To cancel the operation once it is underway, touch <Exit>.

#### 6. When you're done making all the settings, touch

<Execute>.

When you are finished editing the setting, return to the "Song Edit screen."

Touch <Exit> to return to the Menu screen.

## Undoing Edits (Undo)

You can cancel an editing operation that you've just carried out. This is handy when you want to undo an edit and restore data to the way it was before.

\* There are some edits that can't be restored.

At Step 3 of "Selecting the editing function" (p. 125), select <Undo>.

Editing functions that can be undone appear on screen.

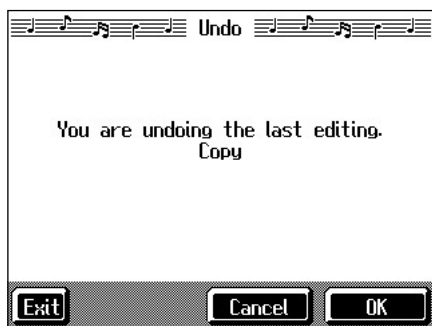

If you touch <Cancel>, the undo is cancelled, and you're returned to the Song Edit screen.

If you touch <OK>, the confirmation message appears on screen. Touch <OK> to undone the most recent edit.

## Copying Measures (Copy)

You can copy a portion of a performance to a different bar in the same Part or to a measure in another Part. This is handy when you're composing a song that repeats a similar phrase.

Ex. To copy measures 5-7 to measure 8.

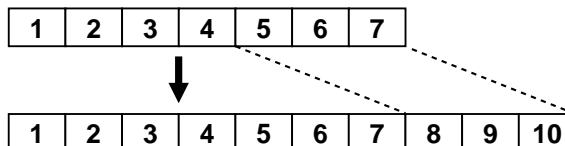

At Step 3 of "Selecting the editing function" (p. 125), select <Copy>.

A screen like the one shown below appears.

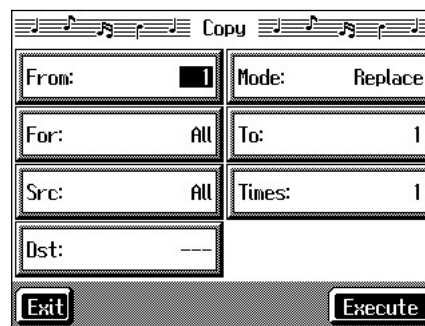

Item	Content
From	Measure number of the first measure of the segment to be copied
For	Number of measures to be copied
Src	Copy-source Track button or part number Choosing "All" copies all Parts. "—" appears in the <Dst> column. Choosing "R.Pattern" copies the KR-7/5's built-in Rhythm Patterns. For more information, take a look at "Copying Rhythm Patterns to Create Rhythm Parts" (p. 127). If you choose a Track button, you can only copy to the selected Track button. You cannot copy to the other Track buttons.
To	Copy-destination measure number When "End" is selected, the data is copied to the end of the song.
Times	Number of times the data is to be copied
Dst	Copy-destination part number

Item	Content
Mode	Data can be copied in the following three ways:
	<b>Replace</b> If there is a performance recorded at the copy destination, this previous recording is erased, and the copied data is written in its place.
	<b>Mix</b> If there is a performance recorded at the copy destination, the copied data is layered over the previous recording. If the Tones used for the copy source and copy destination are different, the copy-destination Tone is used.
	<b>Insert</b> If there is a performance recorded at the copy destination, the copied portion is inserted without erasing the previous recording. The song is lengthened by the number of inserted measures.

## ■ Copying Rhythm Patterns to Create Rhythm Parts

The KR-7/5 features numerous internal rhythm patterns. You can copy these rhythm patterns to create a rhythm part.

→ For more information about the name of Rhythm Patterns, please refer to “Rhythm Pattern List” (p. 187).

At Step 3 of “Selecting the editing function” (p. 125), select <Copy>.

For more about ordinary copying, please refer to “Copying Measures (Copy)” (p. 126).

Select “Rhythm Pattern” as the <Src>.

This makes the setting for copying a built-in Rhythm Pattern.

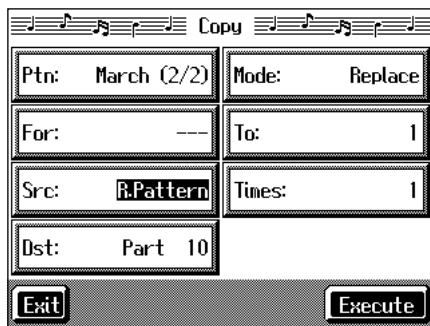

- The rhythm pattern’s name and measure count are indicated in the <From> column.
- The <Dst> is fixed at “Part 10.”
- When the <Src> is switched to something other than “Rhythm Pattern,” the KR-7/5 is set to carry out normal copying.

Press the [ ▶/■ (Play/Stop)] button to play back and confirm the rhythm pattern. The rhythm pattern stops when you press the [ ▶/■ (Play/Stop)] button once more.

## ■ Correcting Timing Discrepancies (Quantize)

You can correct for timing discrepancies in a recorded performance by automatically aligning the music with the timing you specify. This is called “Quantizing.”

As an example, let’s say that the timing of some quarter-notes in a performance is a little off. In this case, you can quantize the performance with quarter-note timing, thus making the timing accurate.

Example: Quarter-note resolution



Example: Sixteenth-note resolution

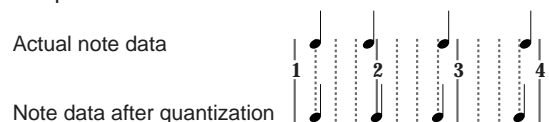

At Step 3 of “Selecting the editing function” (p. 125), select <Quantize>.

A screen like the one shown below appears.

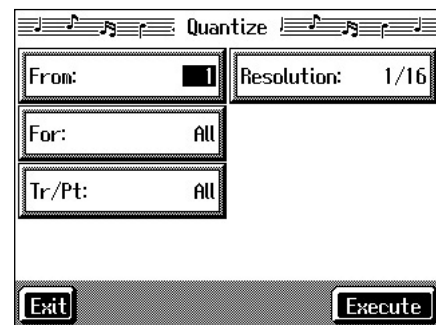

Item	Content
From	Measure number of the first measure of the segment to be quantized
For	Number of measures to be quantized
Tr/Pt	Track button or part number to be quantized Choosing “All” quantizes the same passage in all Parts.
Resolution	Quantization timing Select one of the following values 1/2 (half note), 1/4 (quarter note), 1/6 (quarter-note triplet), 1/8 (eighth note), 1/12 (eighth-note triplet), 1/16 (sixteenth note), 1/24 (sixteenth-note triplet), 1/32 (thirty-second note)

When finished with the Quantize settings, return to the Song Edit screen.

## ■ Deleting Measures (Delete)

You can delete a part of a performance measure by measure. When a portion of a performance is deleted, the rest of the performance is shifted up to fill the gap. Erasing measures in a specified passage is called “deleting.”

Ex. To delete measures (bars) 5-8

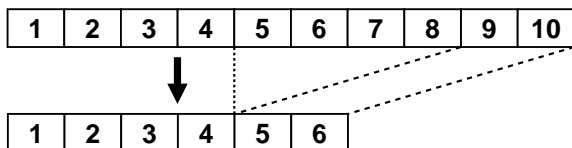

At Step 3 of “Selecting the editing function” (p. 125), select <Delete>.

A screen like the one shown below appears.

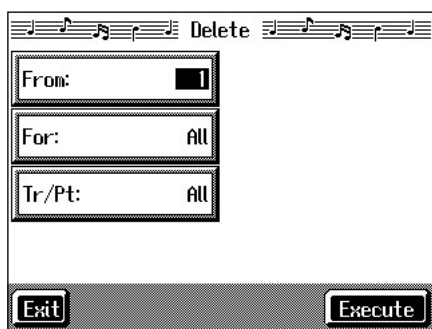

Item	Content
<b>From</b>	Measure number of the first measure of the segment to be deleted
<b>For</b>	Number of measures to be deleted
<b>Tr/Pt</b>	Track button or part number to be deleted When “All” is selected, the same portion of all parts is deleted.

## ■ Inserting Blank Measures (Insert)

You can add a blank measure at a location you specify. This addition of a blank measure is called “insertion.”

Ex. To insert measures (bars) 5-7

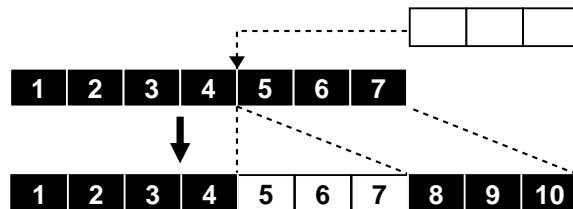

At Step 3 of “Selecting the editing function” (p. 125), select <Insert>.

A screen like the one shown below appears.



Item	Content
<b>From</b>	Measure number of the first measure of the segment to be inserted
<b>For</b>	Number of measures to be inserted
<b>Tr/Pt</b>	Track button or part number where data will be inserted When “All” is selected, blank measures are inserted at the same place in all parts.



## ■ Transposing Individual Parts (Transpose)

You can transpose specified parts and tracks individually.

At Step 3 of “Selecting the editing function” (p. 125), select <Transpose>.

A screen like the one shown below appears.

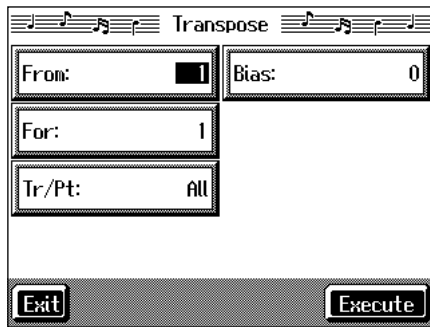

Item	Content
<b>From</b>	Measure number of the first measure of the segment to be transposed
<b>For</b>	Number of measures to be transposed
<b>Tr/Pt</b>	Track button or part number to be transposed When “All” is selected, the same portion of all parts is transposed.
<b>Bias</b>	The range of transposition You can select the range to transpose the data, from -24 (two octaves down) to +24 (two octaves up), adjustable in semitones.

\* You cannot transpose performances of the drum sets and sound effect sets (such as the Rhythm Track).

## ■ Making Measures Blank (Erase)

You can delete the performance data in a specified block of measures, turning them into blank measures without reducing the length of the song. This process is called “erasing.”

Ex. To erase measures (bars) 5-8

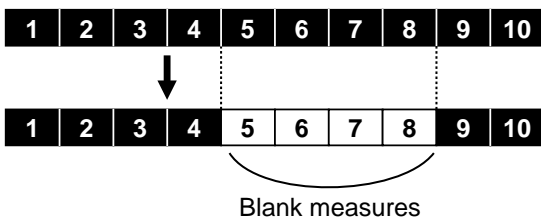

Follow the steps in “Selecting the editing function” (p. 125) to choose <Erase>.

A screen like the one shown below appears.

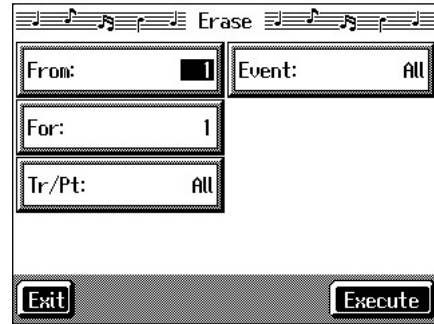

Item	Content
<b>From</b>	Measure number of the first measure of the segment to be erased
<b>For</b>	Number of measures to be erased
<b>Tr/Pt</b>	Track button or part number to be erased When “All” is selected, the same portion of all parts is erased.
<b>Event</b>	Select from the following types of performance data to erase:
	<b>All</b> All performance data, including notes, tempos, Tones switches, volume changes, etc., are erased.
	<b>Tempo</b> Tempo data is erased. Erasing the tempo data for all measures results in a single, constant tempo.
	<b>Prog.Change</b> Erases the data for switching Tones (p. 126).
	<b>Note</b> Erases only notes.
	<b>Except Notes</b> Erases all of the performance data except for the notes.
<b>Expression</b> Erases Expression (volume change) information.	



## ■ Exchanging Parts (Part Exchange)

You can exchange the notes recorded for a particular part with the notes recorded for another part. This process of exchanging parts is called “part exchange.”

At Step 3 of “Selecting the editing function” (p. 125), select <Part Exchange>.

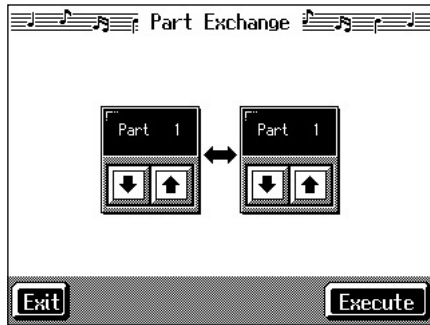
A screen like the one shown below appears.



Touch each   to choose Parts you want to exchange.

## ■ Correcting Notes One by One (Note Edit)

You can make corrections in a recorded performance one note at a time. This process of making changes in individual notes is called “note editing.”

You can make these corrections by using note editing:



- Deleting misplayed notes
- Changing the scale of a single note
- Changing the force used in playing a single key (velocity)

At Step 3 of “Selecting the editing function” (p. 125), select <Note Edit>.

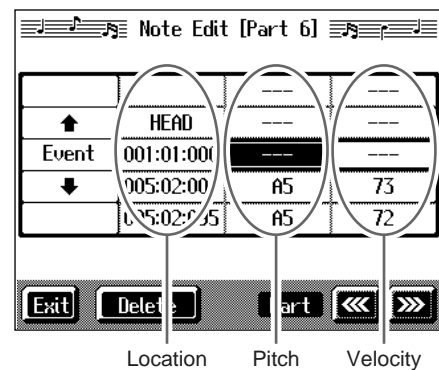
A screen like the one shown below appears.



The note-location display uses “Measure: Beat: Tick” as the format. A tick is a unit of time that’s shorter than a beat.

Touch   to select the part with the note to be corrected. The Part number appears at the top of the screen.

Use the [ <<< (Bwd)] button and the [ >>> (Fwd)] button or use <↑> <↓> in the upper part of the screen to find the note to be corrected.

When you’ve found the note you want to correct, touch “Pitch” or “Velocity” for the note.

Use the [-] [+] buttons and the dial to correct the pitch or velocity. If you want to delete the note, touch <Delete>.

When you’re done making all the settings, touch <Exit>. Return to the Song Edit screen.

## ■ Modifying the Tone Changes in a Song (PC Edit)

In some songs, the instrument sound changes during the course of the song (that is, the Tone changes in the middle of a Part). In such songs, an instruction to switch the Tone is inserted at the place where you want the sound to change. This instruction is called a “Program Change” (PC), and actions such as deleting program changes, or changing the selected Tone by them are called “PC editing.”

\* *It is not possible to insert a program change into a measure or beat that does not contain a program change.*

At Step 3 of “Selecting the editing function” (p. 125), select <PC Edit>.

A screen like the one shown below appears.

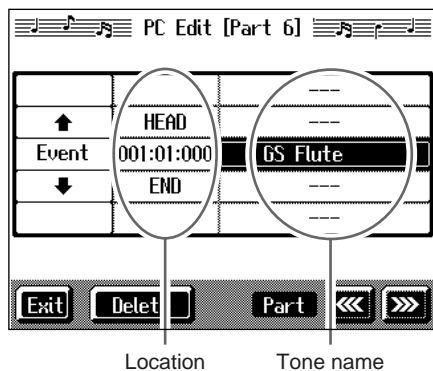

The PC-location display uses “Measure: Beat: Tick” as the format. A tick is a unit of time that’s shorter than a beat.

Touch to select the part with the program change to be edited.

The Part number appears at the top of the screen.

Use the [ (Bwd)] button and the [ (Fwd)] button or use < > < > in the upper part of the screen to find the program change to be edited.

When you’ve found the Program Change you want to modify, touch “Tone Name” on the screen.

Press a Tone button to select a Tone group, then select a Tone with the [-] [+] buttons and the dial. When selecting Part 10 or 11, select the drum set or effect sound.

If you want to delete the Program Change, touch <Delete>.

When you’re done making all the settings, touch <Exit>.

## Changing the Beat in the Middle of a Song (Beat Map)

You can create songs that have beat changes during the course of the song.

\* *You can’t change a song’s beat once it’s been recorded. Before recording the performance, determine the beat to be used.*

1. Press the [Menu] button.

The Menu screen appears.

2. Touch <Beat Map>.

A screen like the one shown below appears.

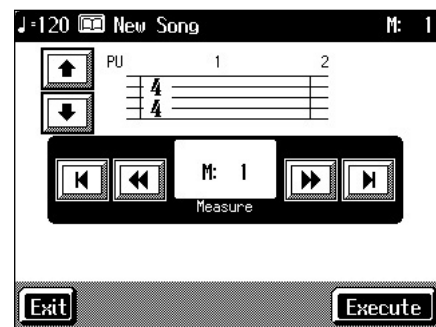

3. Use < > < > < > < > in the screen or the [ (Bwd)] and [ (Fwd)] buttons to move to the measure whose beat you want to change.

The measure number appears in the top-right area of the screen.

Touch < > to move to the beginning of the song.

Touch < > to move to the end of the song.

4. Touch in each to set the beat.

5. Touch <Execute>.

The beat change starts with the measure you selected.

Repeat Steps 3–5 to make beat settings in other measures as needed.

### Recording the performance

6. Touch <Exit> twice.

The screen displayed before you pressed the [Menu] button appears.

7. Press the [ (Reset)] button to return the measure number to “1.”

8. Start a recording.

Record the performance using the procedures described in “Chapter 4 Recording and Saving the Performance” (p. 95). Specify the measure, then change the beat.

## Changing the Tempo of Recorded Songs

You can change the basic tempo of a composition. The basic tempo was initially set when the song was recorded.

1. Press the Tempo [-] and [+] buttons to choose a tempo.
2. Hold down the [ ● (Rec)] button and press the [ ⏪ (Reset)] button.

The song's basic tempo changes.

The change in basic tempo is discarded when you turn off the power or choose a different song. Save important song data to floppy disks or to user memory (p. 106).

\* If the song you're working on has tempo changes, press the [ ⏪ (Reset)] button to go back to the beginning of the song before you carry out this operation.

## Changing the Tempo Within the Song

You can add tempo changes to a recorded composition.

The KR-7/5 stores song tempo information and performance data separately. Therefore, when making changes to the tempo in a song, you must record the changes in the tempo information independently of the performance data.

This recording of the tempo is called "Tempo Recording."

### ■ Adjusting the Tempo While Listening to a Song

You can add ritardando and other such gradual tempo changes.

#### Setting the Rec Mode to "Tempo"

1. Press the [Menu] button.

The Menu screen appears.

2. Touch <Rec Mode>.

A screen like the one shown below appears.

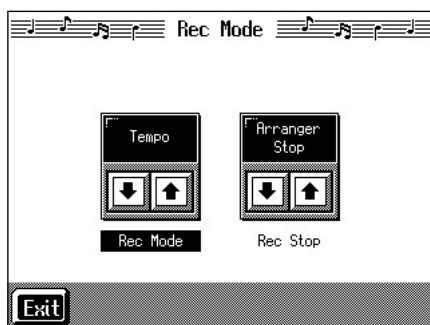

3. Touch the <Rec Mode>   to select <Tempo>.

This makes the setting for tempo recording.

Touch <Exit> a number of times to switch to the screen where the measure number is indicated in the upper right of the screen.

When the KR-7/5 goes into Tempo Recording, the tempo indication is highlighted in white.

#### Recording the Tempo

4. Use the [ ◀◀ (Bwd)] and [ ▶▶ (Fwd)] buttons to move slightly before the measure where you want to change the tempo.
5. Press the [ ● (Rec)] button and watch the indicator is flashing.  
The KR-7/5 is put in recording standby.
6. When you press the [ ▶/■ (Play/Stop)] button, recording begins.
7. When you get to the place where you want to change the tempo, use the Tempo [-] and [+] buttons or the dial to vary the tempo as desired.
8. When you press the [ ▶/■ (Play/Stop)] button, recording stops.

The song's tempo changes.

\* You cannot record performances while in Tempo Recording mode. When you're finished tempo recording, go back to the ordinary Replace Recording. Take a look at "Changing the Recording Method (Rec Mode)" (p. 120).

## ■ Adjusting the Tempo at a Particular Measure

You can create a tempo change at the beginning of a selected measure. This is handy when you want to make a sudden change in tempo.

First, carry out Steps 1–3 of “Changing the Tempo Within the Song” (p. 132) to make the “Tempo Recording” settings.

1. Use the [ ◀◀ (Bwd)] and [ ▶▶ (Fwd)] buttons to move to the measure where you want to change the tempo.

The measure number appears in the top-right area of the Basic screen.

2. Press the [ ● (Rec)] button and watch the indicator is flashing.

The KR-7/5 is put in recording standby.

3. Use the [-] [+] buttons or the dial to change the tempo.

4. Press the [ ▶/■ (Play/Stop)] button.

The song's tempo changes starts with the measure you selected.

→ *While tempo recording is being used to write tempo, the tempo display in the screen will be highlighted.*

5. When you press the [ ▶/■ (Play/Stop)] button, the change in tempo stops.

\* *You cannot record performances while in Tempo Recording mode. When you're finished tempo recording, go back to the ordinary Replace Recording. Take a look at “Changing the Recording Method (Rec Mode)” (p. 120).*

→ *If you want to restore the previous tempo, delete the tempo data at the place where the tempo was recorded. For an explanation of how to delete the information of tempo settings, refer to “Making Measures Blank (Erase)” (p. 129).*

### Tempo Recording Shortcut

Hold down the [ ● (Rec)] button and press one of the Tempo [-] [+] buttons to switch to the Tempo Recording settings. Record tempo information. In this case, tempo recording is canceled when recording ends.

# Chapter 7 Creating Music Styles

## Creating Original Styles (User Styles)

Although the KR-7/5 features a variety of internal Music Styles, you can also create your own. These original Styles are called “User Styles.”

You can use either of the two methods described below to create a User Style.

### Style Composer (KR-7)

With this method, you combine internal Music Styles to create new Styles. You can create a new Style by selecting from among the Rhythm, Bass, Accompaniment 1, Accompaniment 2, and Accompaniment 3 parts in different styles.

### Style Converter (p. 136)

Create a new Style by extracting the portions you need from songs composed with the 16-track sequencer.

When you’re composing a song, there’s no need to specify all the chords. You can specify just some of the chords, and the KR-7/5 automatically chooses the other chords and arranges the Style.

Style Converter features an “Auto mode” that allows you to easily create Styles from songs with a single chord, and a “Manual mode,” in which you create Styles from songs with three kinds of chords—major, minor, and seventh chords.

## ■ Creating New Styles by Combining Internal Music Styles (Style Composer) (KR-7)

You can create a new style by selecting from among the Rhythm, Bass, Accompaniment 1, Accompaniment 2, and Accompaniment 3 parts in different Styles. This function is called the “Style Composer.”

\* You can only combine the KR-7’s built-in Styles.

### Displaying the Style Composer Screen

#### 1. Press the [Menu] button.

The Menu screen appears.

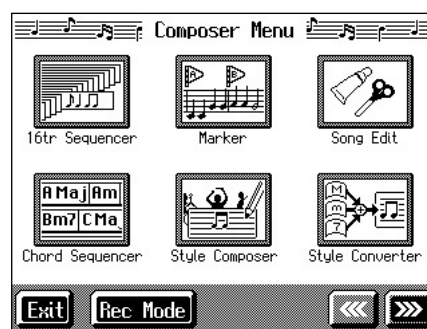

Display of the KR-7

#### 2. Touch <Style Composer>.

\* If a User Style has already been recorded, a message like the one shown below appears.



Touch <Cancel> to return to the Menu screen. Save User Styles to floppy disks, or to user memory (p. 139).

When you touch <OK>, the previously recorded User Style is deleted, and a new User Style is created.

A “Style Composer screen” like the one shown below appears.



Display	Part
R	Rhythm
B	Bass
A1	Accompaniment 1
A2	Accompaniment 2
A3	Accompaniment 3

Icon	Function
All Clear	Deletes all of the settings.
Mute	You can mute the sound of particular Parts in specific Divisions. For more information, take a look at “Muting Parts for a particular division” (p. 135).
Clear	Deletes the Styles in selected parts.
Options	The Part Settings screen is displayed, allowing you to make detailed settings to each part. For more information, take a look at “Editing the volume and effect settings for each Part” (p. 136).
Execute	Records the created Style to the Music Style [User] button. Touch this when you have finished creating the Style.

### Selecting the Styles assigned to each part

#### 3. Touch the part to be set.

The Part you touched appears in reverse video.

#### 4. Press an Music Style button, then select a Style with the touch screen or the [-]/[+] buttons and the dial.

When you have decided on a Style, touch <Exit> to display the Style Composer screen.

#### 5. Repeat steps 3 and 4 to determine the Styles for each Part.

### Deciding on a Style

#### 6. Touch <Execute>.

You have created a new Style.

The User Style is recorded to the Music Style [User] button. Try playing with the new Style.

- \* If you turn off the power or record a new User Style, any User Style you’ve previously recorded is lost. If you do not want to delete the Style, save it to a floppy disk or to user memory. Take a look at “Saving a User Style” (p. 139).

#### ○ Muting Parts for a particular division

You can mute the sound of particular Parts in specific Divisions.

For example, have all of the parts play in the “Variation” accompaniment pattern, while muting “Accompaniment 2” and “Accompaniment 3” in the “Original” accompaniment pattern. With this arrangement, when the accompaniment pattern changes from the original to the variation, it creates a more elaborate effect in the accompaniment.

- For more on Divisions, refer to the “Style Arrangements” (p. 136).

1. Touch the screen to choose the Part you want to mute out.
2. Press the Fill In [To Variation] or [To Original] button to switch to the division that you want to mute.
3. Touch <Mute> on the screen.

The Part you chose is only muted out in the Division you selected.

If you want to hear the muted-out Part, touch <Mute> again.

- \* To mute out a Division that changes after a few seconds (intro, ending, or fill-in), touch <Mute> immediately after switching to the Division.

- Editing the volume and effect settings for each Part

### Displaying the Part settings screen

1. At the Style Composer screen, touch <Options>.

A screen like the one shown below appears.

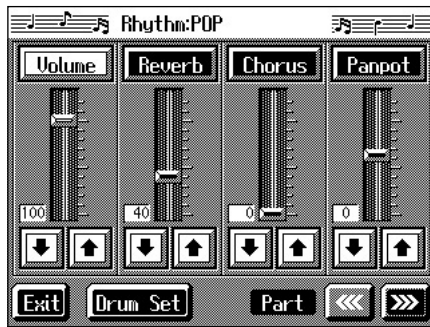

### Modifying the settings of each part

2. Touch the to select the part with the settings to be changed.  
The part name and Tone name are indicated in the upper part of the screen.
3. Touch for each parameter to change the value.  
You can also change the values by touching each parameter name and then using the [-] [+] buttons and the dial. Pressing the [-] [+] buttons simultaneously returns the parameter to its original value.

Display	Explanation
Volume	Adjusts the volume.
Reverb	Adjusts the amount of reverb effect applied to the sound.
Chorus	Adjusts the amount of chorus effect applied to the sound.
Panpot	Changes the left-right direction from which the sound appears to come. When you touch , the sound moves to the right; touch  to move the sound to the left.

You can change the Tone for the selected Part by pressing a Tone button to change the Tone while this screen is displayed. When selecting Rhythm Part, you can touch <Drum Set> to select the drum set or effect sound.

### Finishing the settings

4. Touch <Exit>.  
The Style Composer screen appears.

## ■ Creating a Style from a Song You Composed Yourself (Style Converter)

You can take a song you've composed yourself and extract the portions you need to create your own original Style. When you're composing a song, there's no need to specify all the chords. You can specify some of the chords, and the KR-7/5 automatically chooses the other chords and arranges the style. This function is called the "Style Converter."

Style Converter features an "Auto mode" that allows you to easily create Styles from songs with a single chord, and a "Manual mode," in which you create Styles from songs with three kinds of chords—major, minor, and seventh chords.

When creating a song in order to create an music style, it's good practice to consider the arrangement of the music style.

### Style Arrangements

A Music Style is made up of five performance parts: "Rhythm," "Bass," "Accompaniment 1," "Accompaniment 2" and "Accompaniment 3."

A song progresses in predictable a sequence, such as intro, melody A, melody B, bridge and ending.

With the KR-7/5, such changes in songs are allocated to the following six performance states. We call these six parts of a song "Divisions."

Division	Performance division
Intro	The intro is played at the start of a song.
Ending	This is played at the end of a song.
Original	This is a basic accompaniment pattern.
Variation	This is a developmental accompaniment pattern. It is a variation on an Original.
Fill-In To Variation	This is a one-measure phrase inserted at a juncture where the mood changes. It is used to make a song more lively.
Fill-In To Original	This is a one-measure phrase inserted at a juncture where the mood changes. It is used to make a song more sedate.

You can make a song more lively or more restrained by increasing or reducing played parts by Divisions. You can also modify a song by changing the Tone of the parts in the Divisions.



○ Creating Styles in Auto Mode

Points to note when creating songs

- Use one of the major, minor, or diminished seventh chords to create the song. We recommend using diminished seventh chords to compose the song.
- It is convenient to record the sounds shown below for the Parts of the 16-track sequencer.

Rhythm	Bass	Accomp 1	Accomp 2	Accomp 3
D (10)	2	7	8	9

→ When using parts other than Part 2, 7, 8, 9, and D, refer to “Changing an Extracted Part” (p. 138).

Creating songs

1. Use the 16-track sequencer to record the song.

Record the song after referring to “Multitrack Recording with 16 Parts (16-Track Sequencer)” (p. 117) and other related sections.

When using music data, first select a song (p. 69).

Displaying the Style Converter screen

2. Press the [Menu] button.

The Menu screen appears.

3. Touch <Style Converter>.

- \* If no song for use in creating a new Style is selected, the message “Please select a song” appears. Use the [Select/Listen to a Song] button to select a song (p. 69), then start the procedure again.
- \* If a User Style has already been recorded, a message like the one shown below appears.



Touch <Cancel> to return to the Menu screen. Please save the User Style on a floppy disk or in the internal memory (KR-7) (p. 139).

When you touch <OK>, the previously recorded User Style is deleted, and a new User Style is created.

A “Style Converter screen” like the one shown appears.

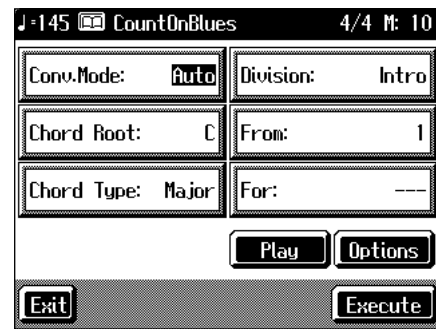

Parameter Name	Settings Content
Conv.Mode	Switches the mode (Auto/Manual)
Chord Root	Chord root for the segment to be extracted
Chord Type	Chord type for the segment to be extracted (major/minor/seventh)
Division	Division
From	Measure number of the first measure of the segment to be extracted
For	Number of measures extracted

Making the settings

4. Touch <Conv.Mode>, then use the [-] [+] buttons or the dial to switch the mode to “Auto.”  
This makes the setting for the Auto mode.
5. Touch <Chord Root> and <Chord Type>, then use the [-] [+] buttons or the dial to input the chord root and type for the segment to be extracted.
6. Touch <Division>, then use the [-] [+] buttons or the dial to select the Division.

Display	Performance division
Intro	Intro
Original	Original accompaniment pattern
Fill To Vari	From the fill-in to the variation
Variation	Variation accompaniment pattern
Fill To Ori	From the fill-in to the original
Ending	Ending

- \* Only one measure can be extracted when “Fill To Vari” or “Fill To Ori” is selected for the Division. The number of measures may also be limited in other Divisions.

7. Touch <From> and <For>, then use the [-] [+] buttons or the dial to select the measures to be extracted.

Touching <Play> at the bottom of the screen, you can listen to performance of the portion which you chose.

8. Repeat Steps 5–7 to create Styles for all of the Divisions.

\* If no setting is made for a Division, it uses a simple drum pattern.

### Deciding on a Style

9. When you're done making all the Division settings, touch <Execute>.

The User Style is recorded to the [User] button.

\* If you turn off the power or record a new User Style, any User Style you've previously recorded is lost. If you do not want to delete the Style, save it to a floppy disk or to user memory (KR-7). Take a look at "Saving a User Style" (p. 139).

\* The following data is saved to the User Style. If a song includes data other than this, the results you get might not be what was intended.

- Keyboard performance data
- Amount of Reverb effect applied
- Amount of Chorus effect applied

### ○ Creating a Style in Manual Mode

When you create a Music Style in the Manual mode, you can clearly point up the differences in accompaniment for each individual chord.

#### Points to note when creating songs

- Record your performance with the three chord types of diminished seventh, major, and minor.
- It is convenient to record the sounds shown below for the Parts of the 16-track sequencer.

Chords	Rhythm	Bass	Accomp 1	Accomp 2	Accomp 3
Major	D (10)	3	4	5	6
Seventh	-	2	7	8	9
Minor	-	12	13	14	15

→ The chords all share the same Rhythm Part.

→ If you want to use the performance of other part, check out "Changing an Extracted Part" (p. 138)

### Creating songs

1. Use the 16-track sequencer to record the song.

Record the song after referring to "Multitrack Recording with 16 Parts (16-Track Sequencer)" (p. 117) and other related sections.

When using music data, first select a song (p. 69).

### Displaying the Style Converter screen

2. Press the [Menu] button.

3. Touch <Style Converter>.

The "Style Converter screen" appears.

4. Touch <Conv.Mode>, then use the [-] [+] buttons or the dial to switch the mode to "Manual."

This makes the setting for the Manual mode.

After that, the steps are the same as for "Creating Styles in Auto Mode" (p. 137).

When you touch <Play> in the lower part of the screen, you can listen to the performance of the part selected with <Options>.

### ○ Changing an Extracted Part

You can extract and change part of a song created with 16-track sequencer.

1. At the Style Converter screen, touch <Options>.

A screen like the one shown below appears.

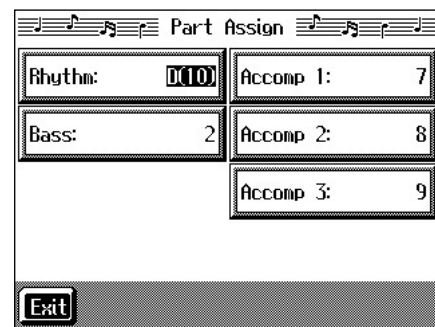

2. Touch the performance Part with settings you want to change.
3. Use the [-] [+] buttons and the dial to specify which 16-track Sequencer performance part you want to extract.

→ In the Manual mode, the type of chords appear at the bottom of the screen. Set the Parts for all chords.

4. Touch <Exit> to return to the Style Converter screen.

## Saving a User Style

You can save the User Styles you create to floppy disks.

With the KR-7, you can save Styles to the user memory. When saved to the user memory, User Styles are not deleted when the power is turned off. You can also select Styles saved to the user memory by pressing the Music Style [User] button.

You can save up to 99 User Styles in user memory.

### What is the User Memory? (KR-7)

The user memory is the area within the instrument where User Styles created with the KR-7, sets of User Programs, and other such data are stored.

You can also copy User Styles and sets of User Programs saved on floppy disks.

Data saved to the user memory is not deleted, even when the KR's power is turned off.

- When you want to clear all of the content saved to the user memory and restore the settings to the factory settings on the KR-7, refer to "Formatting the User Memory (KR-7)" (p. 156).

### Preparations for saving data

When saving to a floppy disk, first insert a floppy disk in the disk drive.

#### 1. Press the Music Style [User] button.

A "User Style screen" like the following appears.

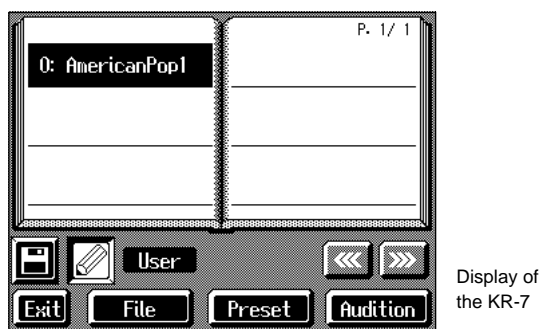

Display of the KR-7

If the User Style screen is not displayed, touch <User/ Disk> in the lower part of the screen.

#### 2. Touch <File>.

#### 3. Touch <Save>.

A "Save Style screen" like the following appears.

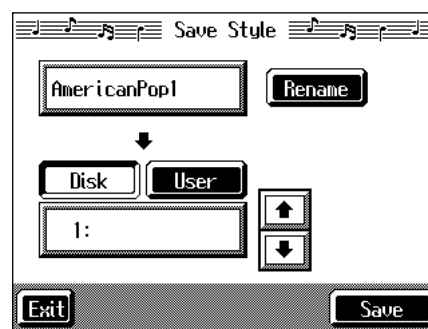

Display of the KR-7

### Determining the name of the Style to be saved

#### 4. Touch <Rename>.

A "Rename screen" like the following appears.

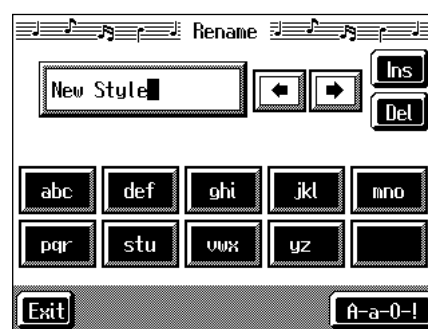

When you touch  , the cursor moves.

When you touch the icon for the character to be input, the character appears at the cursor position.

For example, touching the <ABC> icon in succession cycles you through the available choices in that character group (A→B→C→A...).

Each touch of <A-a-0-!> cycles the type of characters through "English (upper case)," "English (lower case)," "numerals," "symbols," then back to "English (upper case)."

When you touch <Del>, the character at the cursor position is deleted.

When you touch <Ins>, a space is inserted at the cursor position.

#### 5. When you have finished with the name, touch <Exit>.

### Determining the save destination

#### 6. Touch <Disk> or <User>. (KR-7)

Touch <Disk> if you are saving to a floppy disk; touch <User> if you are saving to user memory.

7. Touch   to select the save-destination number.

If a Style name is displayed, a style is already saved to that number.

If you select a number with a previously saved User Style and then save to that number, the previously saved User Style is deleted. If you do not want to delete the User Style being saved, select a number in the save-destination column that does not yet have a name.

8. Touch <Save>.

The saving process starts.

\* *Never turn off the power while the operation is in progress. Doing so will damage the KR-7/5's internal memory, making it unusable.*

### ■ Deleting Saved User Styles

This deletes User Styles that have been saved to floppy disks or in user memory (KR-7).

When deleting a User Style on a floppy disk, first insert the floppy disk in the disk drive.

1. Press the Music Style [User] button.

A "User Style screen" appears.

If the User Style screen is not displayed, touch <User/ Disk> in the lower part of the screen.

2. Touch <File>.

3. Touch <Delete>.

A "Delete Style screen" like the following appears.



Display of the KR-7

4. Touch <Disk> or <User> (KR-7).

Touch <User> if you are deleting a file from user memory; touch <Disk> if you are deleting a file from a floppy disk.

5. Touch  or  to select the Style to be deleted.

6. Touch <Delete>.

A screen like the one shown below appears.



7. Touch <OK>.

The selected Style is deleted.

If you touch <Cancel>, the Style won't be deleted.

\* *Never turn off the power while the operation is in progress. Doing so will damage the KR-7/5's internal memory, making it unusable.*

## Copying Styles on Disks to the User Memory (KR-7)

You can take User Styles saved on floppy disks and copy them to user memory.

You can also take User Styles saved in user memory and copy them to floppy disks.

1. Insert the disk with the Style to be copied in the disk drive.
2. Press the [User] button.

A “User Style screen” like the following appears.

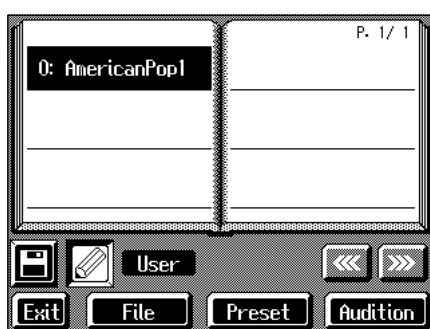



If the User Style screen is not displayed, touch <User/ Disk> in the lower part of the screen.

3. Touch <File>.
4. Touch <Copy>.

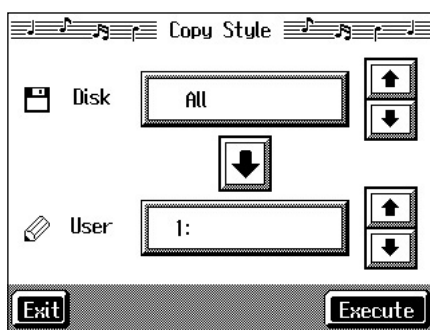
A “Copy Style screen” like the following appears.



### Specifying the copy source

5. Touch <Disk>   to select the Style you want to copy.

When “All” is selected, all of the Styles on the disk are copied to user memory.

### Specifying the Copy Destination

6. Touch <User>   to select the copy destination for the Style.

If a Style name is displayed, a style is already saved to that number.

If you select a number with a previously saved Style and then copy to that number, the previously saved Style is deleted. If you do not want to lose the Style being saved, select a number in the save-destination column that does not yet have a name.

7. Touch <Execute>.

Do not eject the floppy disk from the disk drive before the copy is finished.

The Style on the disk is copied to user memory.

\* *Never turn off the power while the operation is in progress. Doing so will damage the KR-7's internal memory, making it unusable.*

## Copying Styles Saved in the User Memory to Disks (KR-7)

You can take Styles saved in user memory and copy them to floppy disks.

In this case, touch the large arrow icon in the center of the “Copy Style screen” in Step 4 above so that the arrow points upwards. Turn the KR will copy user memory Styles to the floppy disk.

The rest of the procedure is identical to that used for copying Styles from disks to user memory.

# Chapter 8 Various Settings

## Changing the Settings for One-Touch Piano

You can make detailed settings, such as those for the keyboard touch and tunings, allowing you to set up the KR just the way you want for your piano performances.

### ■ Procedure

#### 1. Press the One Touch Program [Piano] button.

The Piano screen appears.

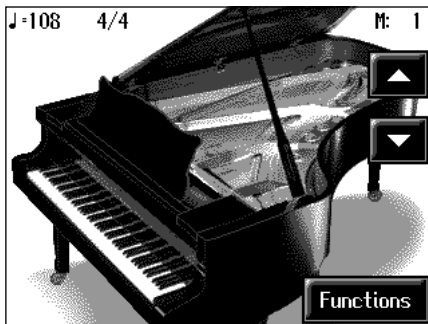

→ For more information about the Piano screen, refer to “Playing the Keyboard Like a Piano (One-Touch Piano)” (p. 24).

#### 2. Touch <Functions>.

Touch <Exit> to go back the Piano screen.

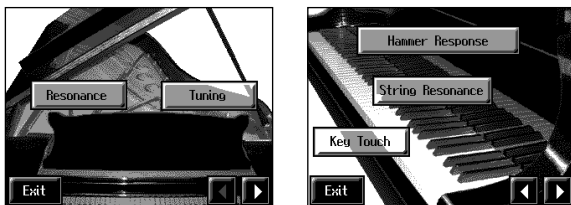

Display of the KR-7

Display	Page	Display	Page
Resonance	p. 142	Hammer Response (KR-7)	p. 144
Tuning	p. 143	String Resonance (KR-7)	p. 144
		Key Touch	p. 145

→ You can set the master tuning and make a variety of other settings to the instrument starting from the third page (second page for the KR-5) of <Functions>. For more detailed information, refer to “Other Settings” (p. 152).

#### 3. Touch the icon for the setting.

Refer to the corresponding page for each function.

#### 4. Touch <Exit> to return to the Piano screen.

## ■ Adjusting Resonance (Resonance)

You can adjust this resonance (Sympathetic Resonance) when the damper pedal is depressed.

At Step 3 in “Procedure” (p. 142), touch <Resonance>.



Display of the KR-7

Display	Explanation
Standard	This replicates the resonance inside a piano.
Advanced (KR-7)	The KR-7 physically reproduces the vibration of other free strings when keys are played, allowing you to experience the feeling of acoustic piano reverberation and resonance (Physical Damper Simulation).
Demo (KR-7)	In addition to the effects of Advanced, this also replicates the noise produced when you depress the pedal.

On the KR-7, touch the <Standard>, <Advanced>, or <Demo> icon to choose the type of resonant sound.

Touch <Level> to adjust the amount of effect applied.

Touch to deepen the effect. When you touch , the effect is lessened.

On the KR-5, touch the Level bar to make the adjustment.

→ On the KR-7, the Resonance settings may change when you use the Transformer (p. 39) and Harmonist (p. 40) vocal effects.

→ On the KR-7, when you’ve chosen <Demo>, touching <Exit> changes the setting for resonant notes to <Advanced>.

## ■ Changing the Tuning (Tuning)

### ○ Choosing the Tuning

You can play classical styles such as Baroque using historic temperaments (tuning methods).

Most modern songs are composed for and played in equal temperament, the most common tuning in use today. But at one time, there were a wide variety of other tuning systems in existence. By playing in the temperament that was in use when a composition was created, you can experience the sonorities of chords originally intended for that song.

At Step 3 in “Procedure” (p. 142), touch <Tuning>.



You can choose from among the eight tunings described below.

Tuning system	Characteristics
<b>Equal</b>	This temperament divides the octave into 12 equal parts. All intervals will be slightly out of tune by the same amount. This setting is in effect when you turn on the power.
<b>Just (Maj)</b>	This temperament makes the 5th and 3rd intervals pure. It is unsuited to playing melodies and cannot be transposed, but is capable of beautiful sonorities.
<b>Just (Min)</b>	Just intonation differs between major and minor keys. The same results as major can be obtained in a minor key.
<b>Arabic</b>	This tuning is suitable for the music of Arabia.
<b>Kirnberger</b>	This temperament is a modification of meantone temperament and just intonation, allowing more freedom of modulation. Performances are possible in all keys (III).
<b>Pythagorean</b>	This temperament is based on the theories of the Greek philosopher Pythagoras, and has pure fourths and fifths. Chords containing a third will sound impure, but melodies will sound good.

Tuning system	Characteristics
<b>Meantone</b>	This temperament is a partial compromise of just intonation in order to allow modulation.
<b>Werkmeister</b>	This temperament is a combination of meantone and Pythagorean temperaments. It allows you to play in all keys. (First method, number three.)

Touch any one of the icons to choose the tuning system.

When playing in a temperament other than equal temperament, you must specify the tonic (the note corresponding to C for a major key, or to A for a minor key) of the key in which you will play.

Touch <Key> to select the tonic.

If you have selected equal temperament, it is not necessary to select the tonic.

### ○ Setting the Tuning Curve (Stretch Tuning)

Pianos are generally tuned so that the low range is flatter and the high range is sharper than equal tempered pitches. This method of tuning is unique to the piano, and is known as “stretched tuning.”

A graph that shows the changes in pitch of actual tuning compared with the changes in equal temperament pitch is called a tuning curve. Changing the tuning curve produces subtle variations in the reverberations of the chords you play.

Touch the Stretch Tuning <ON> or <OFF> icon to select the tuning curve.

When set to “ON,” the tuning curve features extended low and high ranges (Stretch Tuning). It is suitable for piano solos. This setting is selected when the power is turned on.

When set to “OFF,” the standard tuning curve is used. It is suitable when playing in an ensemble with other instruments.

### ■ Changing How Rapidly Sounds Are Expressed According to the Force Used to Play the Keys (Hammer Response) (KR-7)

You can adjust the timing with which sounds are produced according to the force used to play the keys. This function is called “Hammer Resonance.”

When a key is pressed on an acoustic piano, it causes a hammer to move and strike the strings, producing sound. The hammers move more slowly when the keys are played gently, meaning that sounds are produced just slightly later than when you play the keyboard with greater force.

When the Hammer Response function is on, the interval between the time a key is pressed and the time sound is produced varies according to the force used to play the key. The more gently the key is pressed, the more delayed the timing of the sound.

At Step 3 in “Procedure” (p. 142), touch <Hammer Response>.



Touch <ON> to turn the Hammer Response function on.

Touch the screen slider to adjust the time it takes for a key to sound after it is pressed.

The more the slider is moved to “Slow,” the more delayed the sound is when the keys are played softly. Conversely, sounds are produced more quickly when the keys are played with greater force.

Touch <OFF> to cancel the effect.

### ■ Adjusting the Resonant Sounds (String Resonance) (KR-7)

When the keys are pressed on an acoustic piano, the strings for keys that are already pressed also vibrate sympathetically. The function used to reproduce this resonance is called “String Resonance.”

At Step 3 in “Procedure” (p. 142), touch <String Resonance>.



Touch <ON> to turn the String Resonance function on.

Touch the screen slider to adjust the amount of effect applied.

Moving the slider to “Max” increases the amount of resonance effect applied. Moving the slider to “Min” reduces the amount of effect applied.

Touch <OFF> to cancel the effect.



## ■ Adjusting the Keyboard Touch (Key Touch)

You can vary the touch of the keyboard when you play the keys.

At Step 3 in “Procedure” (p. 142), touch <Key Touch>.



Display	Explanation
<b>Fixed</b>	Notes sound at an unchanging volume level, regardless of how lightly or forcefully you play the keyboard.
<b>Light</b>	This sets the keyboard to a light touch. You can achieve fortissimo (ff) play with a less forceful touch than usual, so the keyboard feels lighter. This setting makes it easier for children, whose hands have less strength.
<b>Medium</b>	This sets the keyboard to the standard touch. You can play with the most natural touch. This setting is closest to the response of an acoustic piano.
<b>Heavy</b>	This sets the keyboard to a heavy touch. You have to play the keyboard more forcefully than usual in order to play fortissimo (ff), so the keyboard touch feels heavier. This setting allows you to add more expression when playing dynamically.

Touch any of the icons <Fixed>, <Light>, <Medium>, or <Heavy>, to set the key touch for the keyboard.

To make fine adjustments, touch the slider in the screen.

Move the slider to the right to add resistance, and to the right to make the key touch lighter.

## Changing the Settings for One-Touch Arranger

### ■ Procedure

1. Press the One Touch Program [Arranger] button to display the Basic screen.

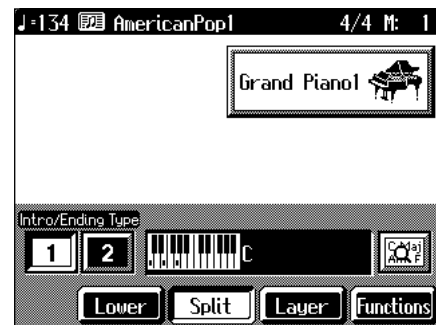

2. Touch <Functions>.

A screen like the one shown below appears.

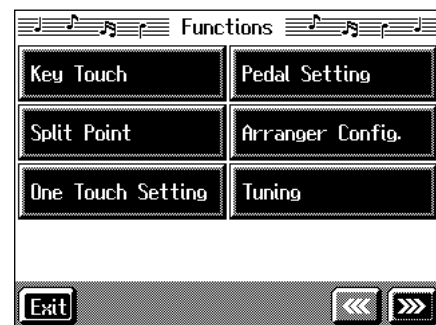

Parameter Name	Description
<b>Key Touch</b>	Refer to “Adjusting the Keyboard Touch (Key Touch)” (p. 145).
<b>Split Point</b>	Sets the key at which the keyboard is divided (the split point) (p. 146).
<b>One Touch Setting</b>	Selects the setting to be specified when the One Touch Program [Arranger] button is pressed (p. 146).
<b>Pedal Setting</b>	Assigns functions to the pedal (p. 147).
<b>Arranger Config</b>	Sets the way the Automatic Accompaniment plays sounds (p. 150).
<b>Tuning</b>	Refer to “Changing the Tuning (Tuning)” (p. 143).

3. Touch the name of the parameter to be set.

Refer to the corresponding page for each function.

4. Touch <Exit> to return to the Basic screen.

### ■ Changing the Keyboard's Split Point (Split Point)

This sets the point (the split point) where the keyboard is divided when specifying chords in the left hand while using the Automatic Accompaniment and when playing split performances (p. 29).

The setting is at "F#3" when the KR-7/5 is powered up.

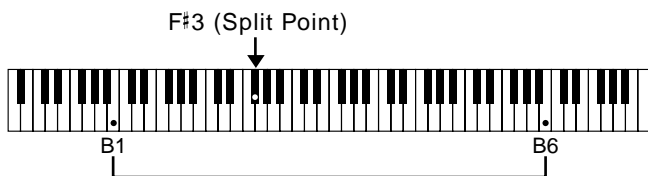

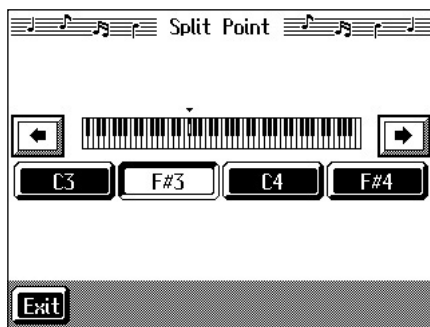

→ The key you chose for the split point belongs to the left-hand section of the keyboard.

At Step 3 in "Procedure" (p. 145), touch <Split Point>.



Touch either <C3>, <F#3>, <C4>, or <F#4> in the lower part of the screen.

The key you chose becomes the split point.

To set another key as the split point, touch   in the screen, then specify the key.

You can set the split point within a range of B1 to B6.

### ■ Changing Music Styles Without Changing the Tone or Tempo (One Touch Setting)

Normally, when you select a Music Style, the Tone and tempo settings suitable for that Music Style are selected automatically. However, you can also set it so the tempo and Tone settings don't change when you change Music Styles.

At Step 3 "Procedure" (p. 145), touch <One Touch Setting>.

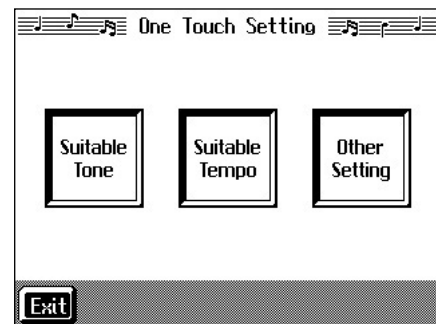

Display	Explanation
<b>Suitable Tone</b>	The suitable tone for a Music Style is selected automatically.
<b>Suitable Tempo</b>	The suitable tempo for a Music Style is selected automatically.
<b>Other Setting</b>	Other settings (Style Orchestrator, phrases (KR-7), etc.) are changed automatically.

Touch each icon to switch individual settings on and off. All items are set to ON when you turn on the power. Parameters switched to OFF (highlighted in black) do not change, even when the Music Style is changed.

## ■ Assigning Functions to Pedals and Performance Pads (Pedal Setting/User Functions)



You can assign a variety of functions to the left and center pedals and to the performance pads.

You can call up the assigned functions just by pressing the corresponding pedal or pad.

### ○ Assigning Functions to Pedals

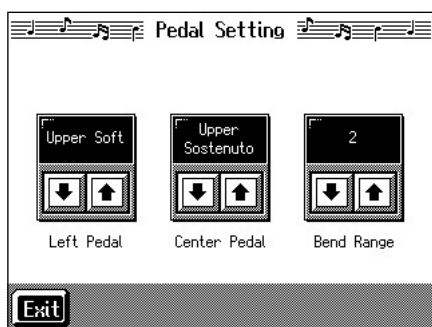
At Step 3 “Procedure” (p. 145), touch <Pedal Setting>.



Touch   to assign functions to each of the pedals.

\* Pressing the One Touch Program [Piano] button restores the piano performance functions to the pedals (p. 20).



### ○ Assigning Functions to Performance Pads

<KR-7>

1. Press the [User Function] button and watch the indicator light up.

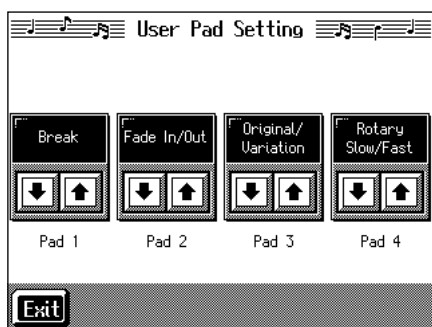
A screen like the one shown below appears.



2. Touch   to assign functions to each of the Performance Pads.

→ If you set the pedal as a dedicated switch for selecting User Programs, the function assigned to the pedal cannot be used. Refer to “Using the Pedal to Switch User Programs” (p. 116).

<KR-5>

1. Press the [Style Orchestrator/User Function] button and the indicator light goes out.

A screen like the one shown below appears.



2. Touch   to assign functions to each of the Performance Pads.

→ If you set the pedal as a dedicated switch for selecting User Programs, the function assigned to the pedal cannot be used. Refer to “Using the Pedal to Switch User Programs” (p. 116).

## Chapter 8 Various Settings

### ○ Functions that can be assigned (Pedals, Performance Pads)

Function	Explanation
<b>Leading Bass</b>	Toggles the Leading Bass function* on or off. The function stays on as long as the pedal to which this is assigned is pressed. When assigned to a Performance Pad, this is alternately switched on and off each time the pad is pressed.
<b>No Chord</b>	Only the accompaniment's rhythm part is played. The next time you specify a chord with the keyboard, the No Chord function is cancelled, and all of the accompaniment parts are played.
<b>Break</b>	During the performance of Automatic Accompaniment, the accompaniment stops for one measure only.
<b>Fill In To Variation</b>	Performs the same function as the Fill In [To Variation] button (p. 61).
<b>Fill In To Original</b>	Performs the same function as the Fill In [To Original] button (p. 61).
<b>Fill In</b>	A fill-in is inserted, but the accompaniment pattern after that doesn't change.
<b>Half Fill In Variation</b>	This plays a fill-in half a measure long, then switches to the Variation accompaniment pattern.
<b>Half Fill In Original</b>	This plays a fill-in half a measure long, then switches to the Original accompaniment pattern.
<b>Original/Variation</b>	This changes the accompaniment pattern without inserting a fill-in.
<b>Arranger Reset</b>	When this function is used during Automatic Accompaniment, the accompaniment returns to the beginning of the Division (p. 50).
<b>Intro 1/Ending 1</b>	Performs the same function as the [Intro/Ending] button (p. 58). Intro 1 and Ending 1 are played.
<b>Intro 2/Ending 2</b>	Performs the same function as the [Intro/Ending] button (p. 58). Intro 2 and Ending 2 are played.
<b>Arranger Start/Stop</b>	Performs the same function as the [Start/Stop] button (p. 58).
<b>Orchestrator Up</b>	This changes the accompaniment to a more elaborate arrangement (p. 62).
<b>Orchestrator Down</b>	Changes the accompaniment to a simpler arrangement (p. 62).
<b>Melody Intelligence</b>	Turns the Melody Intelligence function on and off (p. 64).

Function	Explanation
<b>Fade In/Out</b>	This starts Automatic Accompaniment with a fade-in (where the volume gets progressively louder), ends it with a fade-out (where the volume gets progressively softer), then stops.
<b>Rotary Slow/Fast</b>	This switches the speed of the rotary effect* when you perform with an organ Tone.
<b>Glide</b>	While the pedal or Performance Pad is held down, the pitch of the sound drops temporarily, returning to the original pitch when the pedal or Pad is released. This can be effective for simulating the performance of instruments like a Hawaiian guitar.
<b>Composer Start/Stop</b>	Performs the same function as the [▶/■ (Play/Stop)] button (p. 69).
<b>Page Fwd 1</b>	Press the pedal or the Pad turns the score appearing on the KR display to the next page while the performance of a song is stopped.
<b>Page Bwd 1</b>	Press the pedal or the Pad turns the score appearing on the KR display to the preceding page while the performance of a song is stopped.
<b>Page Fwd 2 (KR-7)</b>	Press the pedal or the Pad turns the score appearing on the external display to the next page while the performance of a song is stopped.
<b>Page Bwd 2 (KR-7)</b>	Press the pedal or the Pad turns the score appearing on the external display to the preceding page while the performance of a song is stopped.
<b>Punch In/Out</b>	During Punch-in Recording, this starts and stops recording (p. 123).
<b>Tap Tempo</b>	You can set the tempo according to the interval at which the pedal or pad is pressed (p. 84).

#### \* What is the leading bass function?

The function that sounds the lowest note of a fingered chord as the bass tone is called "Leading Bass." When this function is turned on, the Bass Tone changes when chord inversions are used. Usually the tonic of the chord you play sounds as the bass tone.

#### \* What is the rotary effect?

This adds a sort of spinning effect to the organ sound, similar to the sound when a rotary speaker is used.

Changing the speed increases or decreases the speed of this spinning effect.

○ Functions that can be assigned (Pedals Only)

Function	Explanation
<b>Replay</b>	Pressing the pedal during playback of a song stops the playback. When the pedal is released, playback resumes from the beginning of the measure that was playing when the pedal was pressed. When the pedal is pressed in rapid succession, the playback will resume backs up the same number of measures as the number of times the pedal is pressed.
<b>Upper Soft</b>	The pedal functions as a soft pedal (p. 20).
<b>Upper Sostenuto</b>	The pedal functions as a sostenuto pedal (p. 20).
<b>Lower Damper</b>	Applies a damper pedal effect to the sounds in the left-hand side of the keyboard.
<b>Bend Up</b>	This raises the pitch of notes you play on the keyboard.
<b>Bend Down</b>	This lowers the pitch of notes you play on the keyboard.
<b>Pedal EX1</b>	When the pedal is pressed during a layer performance, the Tone volume changes between two levels, depending on how firmly the pedal is pressed. Pressing the pedal with "Pedal EX1" selected increases the layer Tone volume. The layer Tone is played at a fixed volume, regardless of how forcefully the keys are played.
<b>Pedal EX2</b>	Pressing the pedal with "Pedal EX2" selected increases the layer Tone volume.
<b>Pedal EX3</b>	Pressing the pedal with "Pedal EX3" selected increases the layer Tone volume, while the volume of the left-hand Tone is decreased. The layer Tone is played at a fixed volume, regardless of how forcefully the keys are played.
<b>Pedal EX4</b>	Pressing the pedal with "Pedal EX4" selected increases the layer Tone volume, while the volume of the right-hand Tone is decreased.

\* The effect may not be applied correctly when you press a pedal if "Pedal EX1-4" is assigned to more than one pedal.

→ Using the "Bend Up" or "Bend Down" function during a split performance (p. 28) changes the pitch of sounds in the right-hand side of the keyboard. Additionally, the range in which the pitch can change when the Bender effect is used is called the "bend range"; refer to "Changing the Bend Range (Pedal Setting)" (p. 149).

■ Changing the Bend Range (Pedal Setting)

The effect of smoothly raising or lowering the pitch of a played note is called the "bender effect."

With the KR-7/5, you can assign the bender function to a pedal, then apply the bender effect by depressing and releasing the pedal.

You can also make a setting that determines how much the pitch of the note changes when you apply the bender. The maximum range of change in pitch is called the "bend range."

At Step 3 "Procedure" (p. 145), touch <Pedal Setting>.

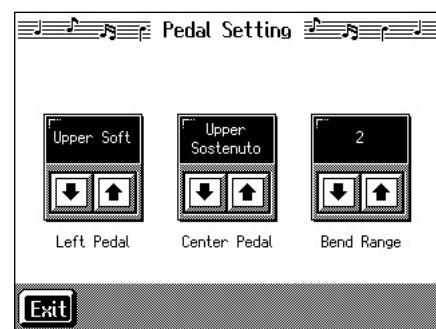

Touch <Bend Range>   to adjust the bend range setting.

You can set this to any value within a range of 1 to 12 (in half-tone steps, up to one octave).

## ■ Changing How Chords Are Played and Specified (Arranger Config)



This changes the settings determining how Music Styles are played, and how the keys are pressed to specify chords.

### What are the Chord Tone and Bass Tone?

When the Automatic Accompaniment is stopped, and Sync Start (p. 58) is turned off, chords are produced when you play in the left-hand side of the keyboard. This is called the “chord tone,” and the root of the chord that is played at the same time is called the “bass tone.”

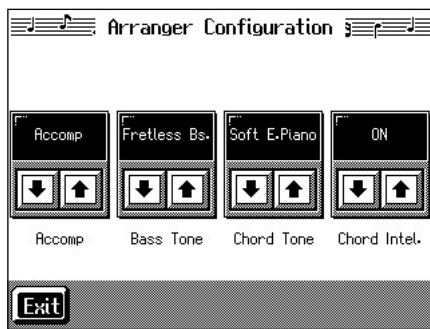
At Step 3 “Procedure” (p. 145), touch <Arranger Config>.



Touch   of each item to make settings.

Parameter Name	Value	Description
<b>Accomp</b>	Accomp	All Music Style parts are played.
	Chord&Bs	Only Music Style rhythm parts, chord Tones, and bass Tones are played.
<b>Bass Tone</b>	OFF, Acoustic Bs., A. Bass+Cymb, Fingered Bs., Picked Bs., Fretless Bs., Slap Bass, Organ Bass, Synth Bass 101, Thum Voice	Selects the bass Tone or chord Tone. When set to “Off,” no tone is played.
<b>Chord Tone</b>	OFF, E. Piano 1, E. Piano 2, Soft E. Piano, Hard E. Piano, Slow Strings, Strings, Choir, Doos Voice	

Parameter Name	Value	Description
<b>Chord Intelli</b>	ON, OFF	The function that allows the KR-7/5 to recognize accompaniment chords when you press only one or two keys during Automatic Accompaniment is called the “Chord Intelligence function” (p. 52). When set to “Off,” play all of the notes to specify chords.

## ■ Placing a Marker in the Middle of a Measure

A marker is normally placed at the start of the selected measure, but you can also set it so that a marker is placed at a position partway through a measure.

→ For detailed information about Marker, refer to “Setting Markers for Repeated Practice (Marker)” (p. 87).

### 1. Press the [Menu] button.

The Menu screen appears.

### 2. Touch <Marker>.

The Marker screen appears.

### 3. Touch <Option>.

A screen like the following appears.



### 4. Touch <Resolution> to choose the marker setting.

Indication	Description
<b>Measure</b>	This lets you place a marker at the beginning of the measure.
<b>Beat</b>	This lets you place a marker at the beginning of the beat.

### 5. Touch <Exit> to go back to the Marker screen.



## Changing the Settings for the Count-In and Countdown

1. Press the [Metronome] button.

The Metronome screen (p. 44) appears.

2. Touch <Count In> or <Countdown>.

The “Count In settings screen” or the “Countdown settings screen” appears.

3. Touch   of each item to make settings.

4. Touch <Exit> to return to the Metronome screen.

### ■ Settings for the Count-In

→ For detailed information about count-in, refer to “Match the Tempo Before You Begin Playing (Count In)” (p. 85).

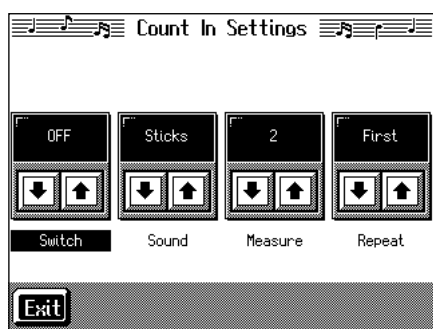

Parameter Name	Value	Description
Switch	ON, OFF	Count-in will be added (ON) or not (OFF).
Sound	Stick, Click, Electronic, Voice (JPN), Voice (ENG), Wood Block, Triangle Castanets, Hand Clap, Animal	Specify the count-in sound.
Measures	1, 2	Specify the length (number of measures) of the count-in.
Repeat	First, Every	When “Repeat” is turned ON on the Marker screen (p. 89) this specifies whether the count-in will sound each time the range between the markers is repeated, or only the first time.

### ■ Settings for the Countdown

→ For detailed information about count-in, refer to “Having a Count Sound Play at the End of the Intro (Countdown)” (p. 60).

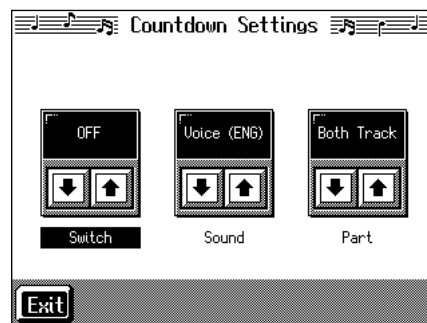

Parameter Name	Value	Description
Switch	ON, OFF	Countdown will be added (ON) or not (OFF).
Sound	Voice (JPN), Voice (ENG)	Specify the countdown sound.
Part	Both Track, Lower Track, Upper Track, Part 1–16	Specify the track or part that will determine the beginning of the performance when added a countdown.

## Other Settings

You can change the tuning, the language shown on the display, and other settings to make the KR-7/5 easier to use.

### ■ Procedure

1. Switch to the Basic screen, or press the One Touch Program [Piano] button.
2. Touch <Functions>.

When you touch <Functions> on the Basic screen, the first page displayed shows the parameters for the Automatic Accompaniment settings (p. 145).

When you touch <Functions> on the Piano screen, the parameters for the piano performance settings continue into the second page for the KR-7, with the KR-5 settings found all on the first page (p. 142).

A “Functions screen” like the following appears.



Display of the KR-7

Parameter	Description
<b>Master Tune</b>	Sets the KR-7/5's standard pitch (p. 152).
<b>Language</b>	Selects the language used in the display (p. 152).
<b>Opening Message</b>	Sets the message that appears when the power is turned on (p. 153).
<b>MIDI Ensemble</b>	Refer to p. 159.
<b>External Display (KR-7)</b>	Selects the content to be shown on the connected external display (p. 153).
<b>User Image Display (KR-7)</b>	Selects the image data and display used (p. 154).
<b>MIDI Settings</b>	Refer to p. 160.
<b>Program Change</b>	Refer to p. 160.
<b>Beat Indicator</b>	Remains the beat indicator off at all times (p. 155).
<b>Memory Backup</b>	Stores edited settings and other data to the KR-7/5 (p. 155).
<b>Factory Reset</b>	Restores the content stored with Memory Backup to the original factory settings (p. 155).
<b>Touch Screen</b>	Allows for calibration of the touch screen (p. 156).

3. Touch the name of the parameter you want to set.  
Refer to the corresponding page for each function.
4. Touch <Exit> to return to the Functions screen.

### ■ Changing Standard Pitch (Master Tune)

“Standard pitch” generally refers to the pitch that is heard when you play middle A. When performing in an ensemble with other instruments, adjust the standard pitch so that the instruments of the ensemble match. Tuning all the instruments to a standard pitch is called “master tuning.”

At Step 3 in “Procedure” (p. 152), touch <Master Tune>. A screen like the one shown below appears.



Touch to change the pitch.

Standard pitch can be set to any value from 415.3–466.2 Hz.

The setting is at “440.0 Hz” when the KR-7/5 is powered up.

### ■ Changing the Language (Language)

Five choices are available for the language used in displaying information on the screen.

At Step 3 in “Procedure” (p. 152), touch <Language>.

A screen like the one shown below appears.



Touch to select the language.

Available settings

English, Japanese, German, French, Spanish

\* German, Spanish, and French are displayed for some functions. Other screens will be displayed in English.





## ■ Changing the Screen Message When the Power Is Turned On (Opening Message)

You can modify this screen to show your favorite phrase when the power is turned on.

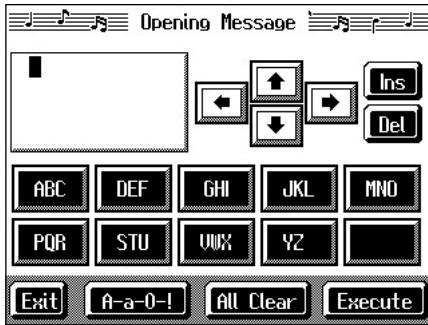
At Step 3 in “Procedure” (p. 152), touch <Opening Message>. A screen like the one shown below appears.



Use     to move the cursor.

When you touch the character icon, the character is input where at the position.

When you touch the icon for the character to be input, the character appears at the cursor position. For example, touching the <ABC> icon in succession cycles you through the available choices in that character group (A→B→C→A...).

Each touch of <A-a-0-!> cycles the type of characters through “English (upper case),” “English (lower case),” “numerals,” “symbols,” then back to “English (upper case).”

When you touch <Del>, the character at the cursor position is deleted.

When you touch <Ins>, a space is inserted at the cursor position.

When you have finished inputting the characters, touch <Execute>.

\* Never turn off the power while the display indicates <Executing...>. Doing so will damage the KR-7/5's internal memory, making it unusable.

→ If you touch <All Clear> at the bottom of the screen and then touch <Execute>, the display reverts to the screen that normally appears when you turn on the power to the instrument.

## ■ Changing the Settings for Showing Images with the External Display (External Display) (KR-7)

This selects the content shown on the external display connected to the KR-7.

At step 3 in “Procedure” (p. 152), touch <External Display>. A screen like the one shown below appears.

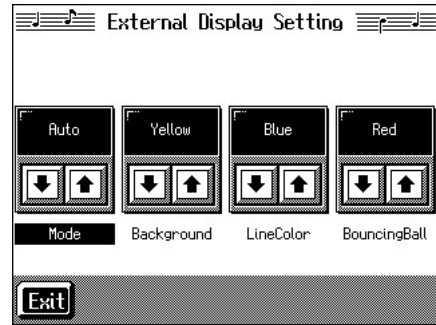

Touch the parameter   to make the settings.

Setting	Settings Value	Description
<b>Mode</b>	Auto	The display of scores, lyrics, score + keyboard, and image data are switched automatically.
	Score	The Score screen is normally displayed.
	Lyrics	The Lyrics screen is normally displayed. However, lyrics are displayed only when playing back music files that contains lyrics data.
	Score and Keyboard	The score and keyboard are displayed.
<b>Back-ground</b>	Bitmap, White, Black, Red, Yellow, Green, Blue, Cyan, Magenta	Selects the screen's back-ground color. "Bitmap" displays a image data set in "User Image Display" (p. 154).
<b>Line Color</b>	White, Black, Red, Yellow, Green, Blue, Cyan, Magenta	Selects the color used for lines and text in the display.
<b>Bounc-ing Ball</b>	White, Black, Red, Yellow, Green, Blue, Cyan, Magenta	Selects the color used for the bouncing ball on the score and lyrics displays.

## ■ Selecting Images To Be Shown on the KR-7 and External Displays (User Image Display) (KR-7)

You can have image data from computers and other devices shown on the onboard display, or on an external display you've connected. You can store two types of image data, "KR-display-use" data, and "external-display-use" data.

→ "KR-display-use" images appear on the KR-7's display when the instrument's power is turned on. Refer to the procedure in "Changing the Settings for Showing Images with the External Display (External Display) (KR-7)" (p. 153) to set the instrument so the "external-display-use" image is displayed on the external display.

At Step 3 in "Procedure" (p. 152), touch <User Image Display>.

A screen like the one shown below appears.



### Selecting the display to be set

#### 1. Touch <KR Display> or <Ext. Display>.

Select the setting either for "KR-display-use" or "external-display-use" images.

### Selecting the images to be displayed

First, take a floppy disk to which the image data stored in the KR-7 has been saved, and insert the disk in the disk drive.

#### 2. Touch <File>.

A screen like the one shown below appears.



#### 3. Touch the name of the stored image data.

When you touch <Preview>, you can then show the selected image data on the display selected in Step 1.

#### 4. Touch <Save>.

The selected image data is stored.

#### 5. Touch <Exit> to return to the previous screen.

To clear the stored image data, touch <Erase>.

### ○ Image data that KR-7 can display

<b>Size</b>	320 x 240 pixels (for KR display) 640 x 480 pixels (for external display)
<b>Color</b>	1/4/8 bit (2/16/256 colors)
<b>Format</b>	BMP format * The KR-7/5 cannot deal with compressed image data.
<b>Name</b>	1-8 characters in length (lowercase is ok). A filename extension of ".BMP" (uppercase characters) must be added after the name.  The following characters can be used to name an image. A B C D E F G H I J K L M N O P Q R S T U V W X Y Z a b c d e f g h i j k l m n o p q r s t u v w x y z 0 1 2 3 4 5 6 7 8 9 # \$ % & ' ( ) - @ ~ { } ^ _ !  * If you use a character that cannot be used in a name, it will be replaced by another character when displayed.



## ■ Turning Off the Beat Indicator (Beat Indicator)

The beat indicator normally flashes in time with the metronome, Music Style, or song tempo. However, if you wish, it can be set to remain off at all times.

At step 3 in “Procedure” (p. 152), touch <Beat Indicator>.

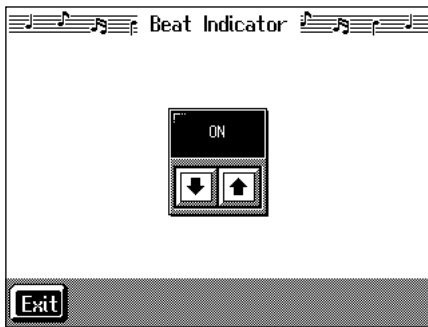
A screen like the one shown below appears.



Touch   to turn the setting ON, or OFF (so the beat indicator remains off).

## ■ Remembering the Settings Even When the Power is Turned Off (Memory Backup)

Normally, the various settings revert to their default values when the power is turned off. However, you can specify that the settings will be remembered even when the power is turned off. This function is called “Memory Backup.”

→ For more on the settings stored using Memory Backup, refer to “Parameters Stored in Memory Backup” (p. 188).

At step 3 in “Procedure” (p. 152), touch <Memory Backup>.

A screen like the one shown below appears.

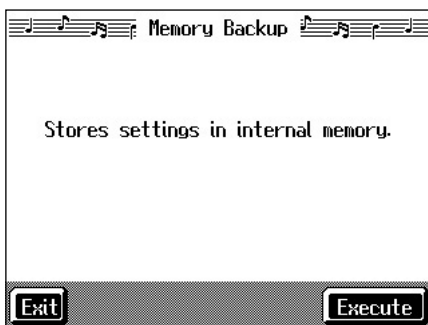

Touch <Execute>.

The confirmation message appears on screen.

Touch <OK> to store the setting.

When the setting has been stored in memory, the previous screen will reappear.

\* Never turn off the power while the display indicates <Executing...>. Doing so will damage the KR-7/5's internal memory, making it unusable.

## ■ Restoring the Factory Settings (Factory Reset)

You can return the content stored with “Memory Backup” (p. 155) and the User Programs (p. 112) to their original factory settings. This operation is referred to as “Factory Reset.”

\* When you perform a Factory Reset, all settings that have been stored in memory up to then are erased and reset to their factory defaults.

→ This operation does not return the touch screen calibration settings to the original factory condition. To return the touch screen calibration settings to the original factory settings, refer to “Returning the touch screen calibration settings to the original factory settings” (p. 156)

→ When you want to restore the content registered to the KR-7's User memory to the factory condition, refer to “Formatting the User Memory (KR-7)” (p. 156).

→ When you want to restore the content registered to the KR-5's Favorites to the factory condition, refer to “Clearing the Favorites” (KR-5)” (p. 156).

At step 3 in “Procedure” (p. 152), touch “Factory Reset.”

A screen like the one shown below appears.



Touch <Execute>.

The confirmation message appears on screen.

Touch <OK> to restore the original factory settings.

When the setting is changed, the previous screen returns.

When you touch <Cancel>, the settings are left untouched, and you're returned to the previous screen.

\* Never turn off the power while the display indicates <Executing...>. Doing so will damage the KR-7/5's internal memory, making it unusable.

### ■ Calibrating the Touch Screen (Touch Screen)

If you've been using the touch screen for some time, the pointer may be shifted, making the KR-7/5 react incorrectly. You should correct this displacement when necessary by performing calibration (repositioning).

At step 3 in "Procedure" (p. 152), touch "Touch Screen."

A screen like the one shown below appears.



Touch <Execute>.

Touch the points indicated.

- \* *Do this carefully, because touching a location that's different from the one indicated for the pointer may make the displacement even worse. Be sure to touch the pointer accurately.*

When the calibration is finished, touch <Write> to store the settings.

- \* *If you don't write them to memory, the calibration settings will be discarded as soon as the power is switched off.*

### Returning the touch screen calibration settings to the original factory settings

If you touch <Factory Reset> in the above screen, the touch screen calibration settings revert to the original factory settings.

### Clearing the "Favorites" (KR-5)

This restores the content registered to the KR-5's Favorites (p. 72) to the original factory settings.

1. Press the [Disk] button.

2. Touch <File>.

3. Touch <Clear Favorites>.

A screen like the one shown below appears.

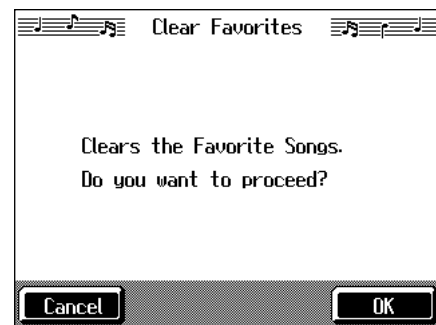

4. Touch <OK>.

All of the content in the Favorites is deleted.

If you touch <Cancel>, the deletion is cancelled, and you're returned to the previous screen.

- \* *Never turn off the power while the display indicates <Executing...>. Doing so will damage the KR-5's internal memory, making it unusable.*
- *Carrying out this operation does not initialize any settings other than the "Favorites." To restore settings other than those for the "Favorites" to the original factory settings, carry out Factory Reset (p. 155).*

### Formatting the User Memory (KR-7)

The KR-7 features an internal storage area where you can save recorded performances and User Styles. This space is called the "User Memory."

The following content is stored to the user memory.

- Content registered to the "Favorites" (p. 72)
- Sets of saved User Programs (p. 113)
- User Styles saved on user memory (p. 139)
- Image files set with the "User Image settings" (p. 154)

To delete all of the content held in the user memory and restore the original factory settings, carry out the following procedure.

**1. Press the [Disk] button.**

Even when you press the Music Style [User] button (User/Disk screen) or the [User Program] button, the rest of the procedure is the same.

**2. Touch <File>.****3. Touch <Format User Memory>.**

A screen like the one shown below appears.

**4. Touch <OK>.**

All of the content in the user memory is deleted.

If you touch <Cancel>, the deletion is cancelled, and you're returned to the previous screen.

\* *Never turn off the power while the display indicates <Executing...>. Doing so will damage the KR-7's internal memory, making it unusable.*

→ *Carrying out this operation does not initialize any settings other than the user memory settings. To restore settings other than those for the user memory to the original factory settings, carry out Factory Reset (p. 155).*

## Automatically Starting the Quick Tour

You can set the instrument so that the Quick Tour starts automatically with no operation required.

**1. Hold down the [Wonderland/Game] button and press the [Part Balance] button.**

The Quick Tour screen appears.

**2. Touch <Option>.****3. Touch <ON> or <OFF>.**

When set to "ON," the Quick Tour starts when you turn on the power. The demo stops as soon as you carry out any kind of operation. If no operation is performed for 5–10 minutes after that, the automatic demo starts again.

When set to "OFF," the Quick Tour does not start unless you touch the Quick Tour screen icon.

**4. Touch <Exit> to return to the Quick Tour screen.**

\* *For more information about Quick Tour, refer to the Quick Start.*

## Disabling Functions Other Than Piano Performance (Panel Lock)

The "Panel Lock" function locks the KR-7/5 in a state where only piano performance can be used, and all buttons will be disabled. This prevents the settings from being inadvertently modified even if children press the buttons accidentally.

\* *In the Panel Lock state, only the grand piano sound can be played.*

**1. Turn down the volume all the way.****2. Press the [Power] switch to turn off the power.****3. While holding down the [Wonderland/Game] button, press the [Power] switch and turn on the power.**

Then, continue to hold down the button for a few seconds.

All buttons except for piano play are disabled.

Adjust the volume. When you play the keyboard, the grand piano sound will be heard.

To undo the Panel Lock function, turn the volume down to the minimum, and turn on the power once again.

# Chapter 9 Connecting External Devices

You can connect the KR-7/5 to external devices such as audio equipment and MIDI instruments.

## ○ Connecting MIDI Devices (p. 158)

You can connect a MIDI sequencer and record performance data from the KR-7/5, or play performance data from the KR-7/5 on the sequencer. Also, when you connect a MIDI sound module, you can perform on the KR-7/5 and hear the sounds played through the MIDI sound module.

## ○ Connecting Audio Equipment (p. 162)

The KR-7/5 has high-quality built-in stereo speakers, but you can also hook it up a stereo system for an even more impressive sound.

You can also connect it to a tape recorder or other recording equipment and record your performances.

## ○ Connecting a Computer (p. 163)

You can use a sequencer program (such as Roland Visual-MT) to record performance data from the KR-7/5 and play performance data from the program on the KR-7/5.

## Connecting MIDI Devices

By connecting an external MIDI device and exchanging performance data, you can control one device from the other. For instance, you can output sound from the other instrument or switch Tones on the other instrument.

### What's MIDI?

MIDI, short for "Musical Instrument Digital Interface," was developed as a universal standard for the exchange of performance data between electronic instruments and computers.

The KR-7/5 is equipped with MIDI connectors and a Computer connector to let it exchange performance data with external devices. These connectors can be used to connect the KR-7/5 to an external device for even greater versatility.

- \* A separate publication titled "MIDI Implementation" is also available. It provides complete details concerning the way MIDI has been implemented on this unit. If you should require this publication (such as when you intend to carry out byte-level programming), please contact the nearest Roland Service Center or authorized Roland distributor.

## ■ Connectors

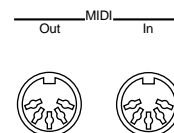

### MIDI Out Connector

Connect this to the MIDI In connector on an external MIDI device using a MIDI cable (sold separately).

Performance data when you play the keyboard or depress a pedal is sent from this connector to the external MIDI connector.

### MIDI In Connector

Connect this to the MIDI Out connector on an external MIDI device using a MIDI cable (sold separately).

This receives MIDI messages that are sent from external MIDI devices. The KR-7/5 receiving MIDI messages can output sounds, exchange tones and perform other operations.

- \* There are two MIDI In connectors, on the bottom panel and on the rear panel of the unit. You can't use both MIDI In connectors at the same time.
- \* External MIDI devices can't be used for remotely changing the Tones played by the KR-7/5's keyboard.

## Making the Connections

\* To prevent malfunction and/or damage to speakers or other devices, always turn down the volume, and turn off the power on all devices before making any connections.

1. Turn the volume all the way down on the KR-7/5 and on the device you're about to connect.
2. Switch off the power to the KR-7/5 and the device you're about to connect.
3. Set the Computer switch on the underside of the unit to "MIDI."
4. Use a MIDI cable (sold separately) to connect the MIDI connectors to each other.

Please refer to the connection examples below.

5. Switch on the power to the KR-7/5 and the connected device.
6. Adjust the volume level on the KR-7/5 and the connected device.

7. You should also set the MIDI settings as needed.

For details on the MIDI-related settings, refer to p. 160–p. 161.

### Connection Examples:

#### Setup with a MIDI Sequencer

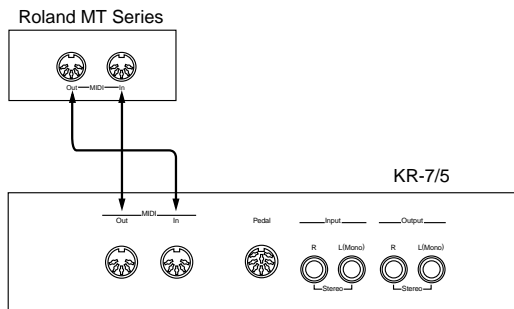

\* When the KR-7/5 is connected to a MIDI sequencer, set it to Local OFF. Refer to "Disconnecting the Keyboard from the Internal Sound Generator (Local On/Off)" (p. 160).

#### Connecting with a MIDI Sound Module

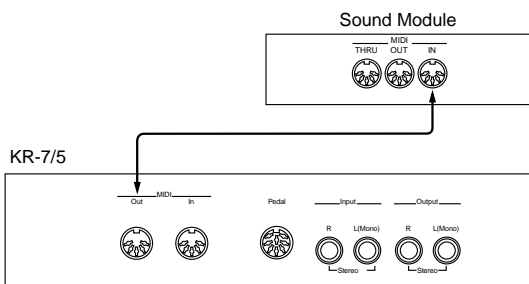

## Performing in Ensemble with MIDI Instruments (MIDI Ensemble)

You can connect an electronic percussion device or other MIDI instrument to the KR-7/5's MIDI In connector for ensemble playing. Making the MIDI settings for the instrument connected to the MIDI In connector is easy. The sounds from the connected MIDI instrument are played from the KR-7/5's speaker.

1. Switch to the Basic screen, or press the One Touch Program [Piano] button.
2. Touch <Functions>.
3. Touch <MIDI Ensemble>.

A screen like the following appears.

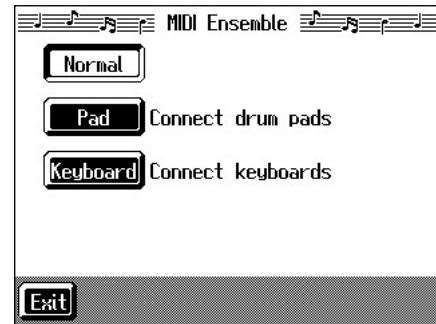

4. Select the method for using the MIDI In connector.

Displayed	Meaning
Normal	Normal setting. Make changes in Tone and other settings from the connected device.
Pad	Select this when you have percussion pads (such as Roland's SPD-20 Total Percussion Pad) connected to the KR-7/5's MIDI In connector. You do not need to make any MIDI settings on the KR-7/5. Select pad Tones and make other settings from the connected pads (for further details, refer to the Owner's Manual provided with the pads).
Keyboard	Select this when you have a keyboard (such as a Roland A-37 or AX-7 MIDI Keyboard Controller) connected to the KR-7/5's MIDI In connector. You can select tones for the connected keyboard from the KR-7/5. No MIDI settings need be made on the KR-7/5.

5. When "Keyboard" is selected in Step 4 above, use



to select the Tone.

The connected keyboard plays using the selected Tone.

## MIDI Settings

With the KR-7/5, you can make MIDI settings like those described below.

### “MIDI Setting Screen”

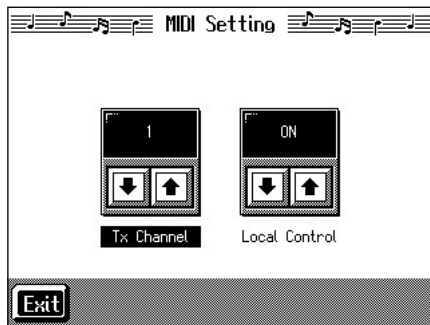

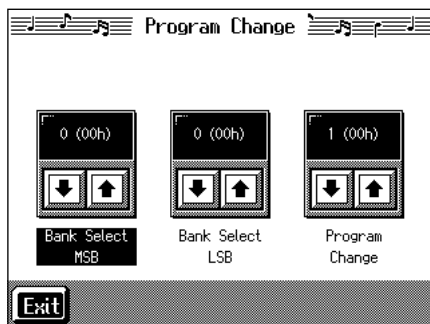

Display	Description
<b>Tx Channel</b>	Chooses the MIDI send channel (p. 160).
<b>Local Control</b>	Switches Local Control on or off (p. 160).

### “Program Change Screen”



Display	Description
<b>Bank Select MSB</b>	Sends Bank Select MSB messages. (p. 161)
<b>Bank Select LSB</b>	Sends Bank Select LSB messages. (p. 161)
<b>Program Change</b>	Sends Program Change messages (Program Numbers). (p. 161)

### Making the Settings

1. Switch to the Basic screen, or press the One Touch Program [Piano] button.
2. Touch <Functions>.
3. Touch <MIDI Setting> or <Program Change>.
4. Touch   to make the setting for each item.

Touch <Exit> to return to the Functions screen.

### Selecting the Transmit Channel (Tx Channel)

MIDI organizes things into “channels,” which are numbered from 1 through 16. Simply connecting a cable is not enough for communication to take place. The connected devices must be set to use the same MIDI channels. Otherwise, no sound will be produced, and no sounds can be selected.

Select the transmit channel (1–16) of the KR-7/5.

The channel setting is at “1” when the KR-7/5 is powered up.

If the keyboard has been split into right-hand and left-hand sections, messages from the left-hand section are fixed at “3.”

The KR-7/5 receives messages on all channels from 1 through 16.

### Disconnecting the Internal Sound Generator and Keyboard (Local Control)

When connecting a MIDI sequencer, set Local Control to “OFF.” The setting is at “Local Control ON” when the KR-7/5 is powered up.

As illustrated, information describing what has been played on the keyboard is passed to the sound module over two different routes, (1) and (2). As a result, you hear overlapping or intermittent sounds. To prevent this from happening, route (1) must be disabled, by setting the unit to what is known as “Local Off.”

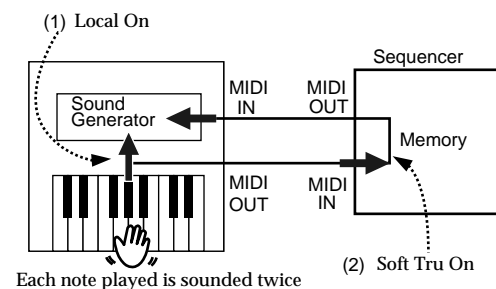



**Local On:** The keyboard and internal sound generator are connected.

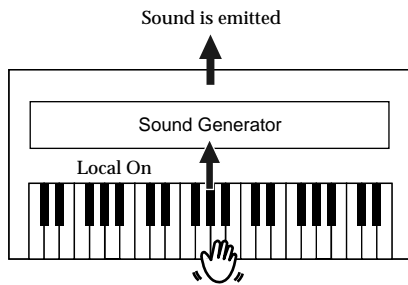

**Local Off:** The keyboard and internal sound generator are separated. No sound will be produced by the keyboard when it is played.

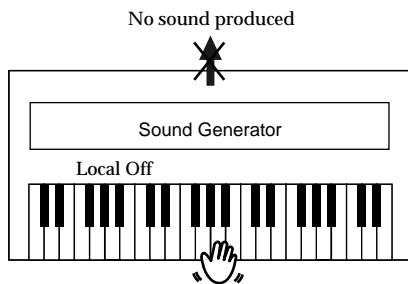

→ When connecting a unit in the Roland MT series, you don't need to switch off Local Control. MT units transmit Local Off messages when their power is switched on. If you first switch on the KR-7/5, then the MT-series device, Local Control is automatically switched off on the KR-7/5.

## ■ Sending Tone Change Messages (Program Change/Bank Select MSB/Bank Select LSB)

A Program Change is a message that means “change to the Tone of the specified number.” The device that receives this changes to the Tone of the corresponding number.

When you choose a Program Change message (Program Number), the Program Number will be transmitted to the MIDI device connected to the KR-7/5. The MIDI device that receives the Program Number changes the tone to the corresponding Program Number.

Normally, the Tone is selected from the 128 Tones available. Some MIDI devices, however, have more than 128 Tones. With such devices, the Tone is selected through a combination of Program Change messages and Bank Select messages. There are two parts of a Bank Select message: the MSB (Controller 0, with a value of 0–127) and the LSB (Controller 32, with a value of 0–127).

\* Some MIDI instruments can't handle Bank Select messages. Others can handle Bank Selects, but do not recognize the LSB part.



## ■ Sending Recorded Performance Data to a MIDI Device (Composer MIDI Out)

When Composer Out is active, you can send performance data recorded with the KR-7/5 to a connected MIDI device or computer.

When you turn on the power, this is set to “OFF” (data is not sent).

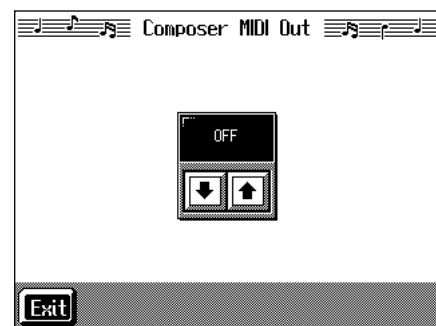
1. Press the [Menu] button.
2. Touch <Composer MIDI Out>.



3. Touch   to set ON or OFF.
4. Touch <Exit> to return to the Menu screen.

### Connecting to Audio Equipment

When you connect the KR-7/5 to audio equipment, you can play the sounds from the KR-7/5 through the speakers on the audio equipment or record your performances on a tape recorder or other recording device.

When connecting, please use audio cables (sold separately) with standard phone plugs.

#### Connectors

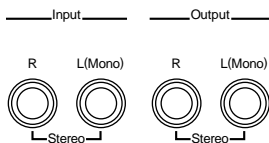

#### Output Jacks

You can connect audio equipment using audio cables (sold separately) and play the sounds from the KR-7/5 through the speakers on the connected equipment, or record your performances on a tape recorder or other recording device.

If the input of the connected device is monaural, you must use the L (Mono) jack.

#### Input Jacks

You can connect another sound source, such as audio equipment or an electronic instrument, using audio cables (sold separately). Play the sounds from the connected device through the speakers on the KR-7/5.

If the input of the connected device is monaural, you must use the L (Mono) jack.

#### Making the Connections

*\* To prevent malfunction and/or damage to speakers or other devices, always turn down the volume, and turn off the power on all devices before making any connections.*

**Playing Sounds from the KR-7/5 Through the Speakers on Audio Equipment or Recording Your Performances on a Recording Device**

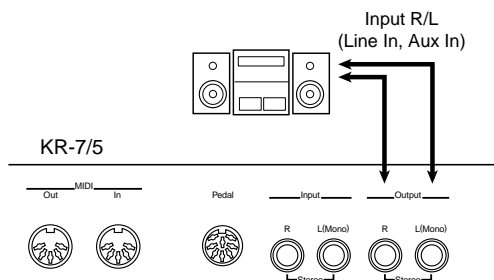

1. Turn the volume all the way down on the KR-7/5 and on the device you're about to connect.

2. Turn off the power to the KR-7/5 and other connected equipment.
3. Use audio cables (sold separately) to make the connection.
4. Switch on the KR-7/5.
5. Switch on the connected device.
6. Adjust the volume level on the KR-7/5 and the connected device.

Recording KR-7/5 Performances on a Recording Device

7. Start recording with the connected device.

8. Play the keyboard.

9. When the performance ends, stop recording on the connected equipment.

**Playing Audio Equipment Sounds Through the Speakers on the KR-7/5**

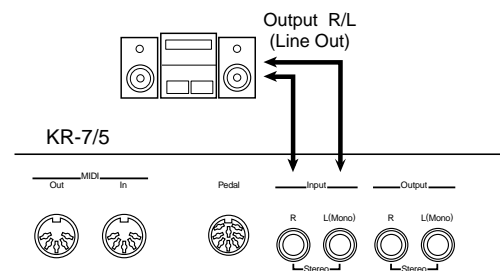

1. Turn the volume all the way down on the KR-7/5 and on the device you're about to connect.
2. Turn off the power to the KR-7/5 and other connected equipment.
3. Use audio cables (sold separately) to make the connection.
4. Turn on the connected equipment.
5. Turn on the KR-7/5.
6. Adjust the volume level on the KR-7/5 and the connected device.

After use, turn off the power using the following procedure.

1. Turn the volume all the way down on the KR-7/5 and on the device you're about to connect.
2. Turn off the KR-7/5.
3. Turn off the connected equipment.

## Connecting a Computer

### ■ Connect to the MIDI Connectors

You can use a USB MIDI interface cable (sold separately) to connect the KR-7/5 to your computer.

If the KR-7/5 is connected to a computer in which sequencer software such as Roland's "Visual MT" is installed, a song you've recorded on the KR-7/5 can be saved on your computer.

#### Connection examples

- \* *To prevent malfunction and/or damage to speakers or other devices, always turn down the volume, and turn off the power on all devices before making any connections.*
- \* *In order to make connections to your computer, you must install "MIDI driver" software on your computer. For details, refer to the owner's manual for your MIDI interface.*

Use a USB MIDI interface cable to connect the USB connector of your computer to the MIDI connectors of the KR-7/5.

Set the Computer switch on the KR's bottom panel to "MIDI," then turn on the power to the KR.

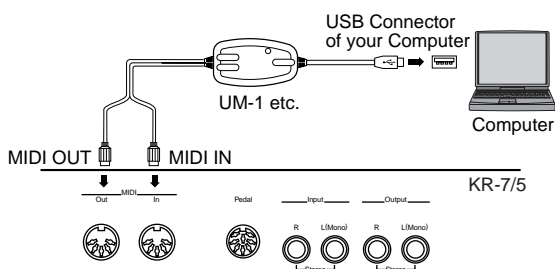

### ■ Connect to the Computer Connector

You can connect a computer on which a sequencing program such as Roland Visual MT is installed and save songs recorded on the KR-7/5 on the computer.

### ■ Connectors

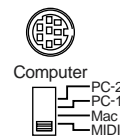

#### Computer Connector

You can connect a computer to this connector to exchange performance data.

Use a computer cable (sold separately) to make the connection.

The type of cable required will depend on your computer.

#### Computer Switch

The setting for this switch is made depending on the computer connected— Mac/PC-1/PC-2.

When this switch is set to MIDI, this connector cannot be used.

### ■ Making the Connections

- \* *To prevent malfunction and/or damage to speakers or other devices, always turn down the volume, and turn off the power on all devices before making any connections.*

1. Turn off the KR-7/5 and the computer.
2. Using a compatible computer cable (sold separately), connect the Computer connector on the underside of the KR-7/5 with the computer's serial port.
3. Set the computer switch on the underside of the KR-7/5 to match the type of computer connected.  
Please refer to the connection examples below.
- \* *Change the setting of the Computer switch only after the power to the unit is off.*
4. Turn on the KR-7/5.
5. Turn on the computer.
6. Make the settings for baud rate (transmission speed) for the computer and the software.

For more information on this procedure, please refer to the owner's manual for your computer.

7. You should also make the settings for the MIDI send channel and Local Control ON or OFF as needed (p. 160).

## Chapter 9 Connecting External Devices

---

### Connection Examples:

#### Connection with an Apple Macintosh computer

Use a computer cable (sold separately) to connect the Computer connector on the KR-7/5 to the modem port (or printer port) on the Apple Macintosh. Set the Computer switch to “Mac.”

When using the Macintosh “Patch Bay” utility, specify 1 MHz as the Interface Type (MIDI Interface Clock).

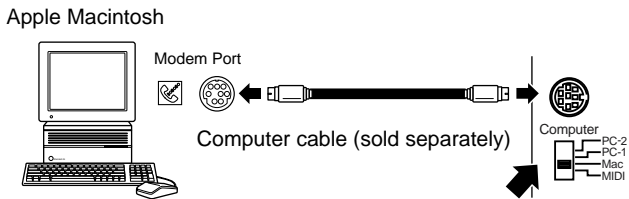

#### Connection with an IBM PC

Use a computer cable (sold separately) to connect the Computer connector on the KR-7/5 to the COM1 or COM2 serial port on the IBM PC. Set the Computer switch to “PC-2.”

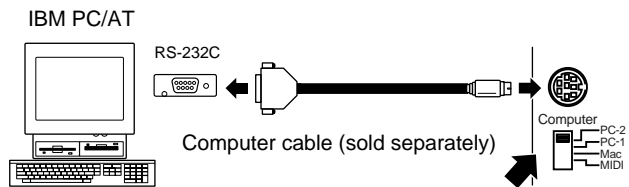

---

**MEMO**

---

# Troubleshooting

If you think there's a problem, read this first.

Case	Cause/Remedy
The power doesn't come on.	Is the power cord connected and plugged in correctly? (p. 18)
The button doesn't work.	Is the panel locked? (p. 157) Turn the power off, then back on.
Nothing appears on screen.	The KR-7/5 uses a liquid-crystal screen, so text may not be displayed when the ambient temperature is below freezing.
Vertical lines appear in the screen/ Color is "washed out" at the edges of the screen	These occur due to the nature of a liquid crystal display, and do not indicate a malfunction. They can be minimized by adjusting the brightness of the screen. (p. 22)
The touch screen doesn't respond correctly.	The positioning of the touch screen may become displaced if some time has passed since it was last used. Take a look at "Calibrating the Touch Screen (Touch Screen)" (p. 156) to correct the positioning.
The pedal rattles	Adjust the adjuster underneath the pedal so that the pedal presses firmly against the floor surface. (p. 20)
Depressing a pedal has no effect, or the pedal effect doesn't stop.	Is the pedal connected correctly? Make sure the pedal cord extending from the stand is securely connected to the pedal connector on the rear of the unit (p. 18).
	Has a different function been assigned to the pedal? See "Assigning Functions to Pedals and Performance Pads (Pedal Setting/User Functions)" (p. 147).
	Normal pedal operation is automatically enabled when the One Touch Program [Piano] button is pressed (p. 20).
The volume level of the instrument connected to Input jacks is too low.	Could you be using a connection cable that contains a resistor? Use a connection cable that does not contain a resistor.
Images not shown on external display when external display is connected	Is the external display properly connected (p. 21)?
	Is the external display's power turned on?
	Are you using a display that is compatible with the KR? Refer to "Displays That Can Be Connected to This Instrument" (p. 21).
	Are the KR's settings correct? Follow the instructions in "Selecting Images To Be Shown on the KR-7 and External Displays (User Image Display) (KR-7)" (p. 154) to set the "External Display" image. Also refer to "Changing the Settings for Showing Images with the External Display (External Display) (KR-7)" (p. 153).

Case	Cause/Remedy
<b>No sound is heard</b>	
No sound is heard.	Is the volume level of the KR-7/5 (p. 20) or connected device turned all the way down?
	Are headphones plugged in? (p. 20)
	Has the Balance knob been moved all the way to the right or left? Has the volume been set to "0" using the Part Balance? (p. 67)
	Are all sliders in the Equalizer screen at the minimum level? (p. 34)
	Has the footage been adjusted so that all frequency components aren't sounded? (p. 15 in the Quick Start)
No sound is heard (when a MIDI instrument is connected).	Have all devices been switched on?
	Are the MIDI cables connected correctly? (p. 159)
	Does the MIDI channel match the connected instrument? (p. 160)
You cannot use a connected MIDI device and computer simultaneously	Is the Computer switch on the bottom of the KR-7/5 set to "MIDI"? (p. 163)
	The MIDI connectors and the computer connector cannot be used at the same time. Confirm that the computer switch is set to "MIDI" when a MIDI device is connected to the MIDI connector, and to either "MAC," "PC-1," "PC-2," when a computer is connected to the Computer connector (p. 163).
No sound is heard when the keyboard is played.	Has Local Control been set to "Off"? When Local Control is set to Off, no sound is produced by playing the keyboard. Set Local Control to On. (p. 160)
Not all played notes are sounded.	The maximum number of notes that the KR-7 can play simultaneously is 128, and that the KR-5 can play is 64. Frequent use of the damper pedal during automatic accompaniment or when playing along with a song on floppy disk may result in performance data with too many notes, causing some notes to drop out.
<b>The sound is strange</b>	
Sounds are heard twice (doubled) when the keyboard is played.	Is the KR-7/5 in layer play? (p. 28)
	When the KR-7/5 is connected to an external sequencer, set it to the Local OFF mode (p. 160). Alternatively, the sequencer could be set so its Soft Thru feature is OFF.

Case	Cause/Remedy
The tuning or pitch of the keyboard or song is off.	Have you set transpose? (p. 90)
	Are the settings for the “Temperament” and “Stretch Tuning” correct? (p. 143)
	Is the setting for the “Master Tune” correct? (p. 152)
Effects cannot be applied to Tones.	It’s not possible to apply more than one effect at the same time, so when a performance has been recorded on multiple tracks or when playing along with a song as it’s played back, the desired effect may not be applied.
A note doesn’t stop playing	Have the Chord Tone and Bass Tone been changed? (p. 150) Some Chord Tone and Bass Tone notes may be sounded continuously.
The Tone has changed.	During automatic accompaniment, changing the Music Style automatically changes the Tones and tempo of the upper part of the keyboard to match the new Music Style. If you want to change only the Music Style without also altering the tempo and Tone, check out “Changing Music Styles Without Changing the Tone or Tempo (One Touch Setting)” (p. 146).
	When a performance made along with a Music Files tune has been recorded, recording the performance to button [1/Whole] may make the Tones for buttons [3/Lower] and [4/Upper] change as well.
Reverberation still audible even with Reverb turned off	Since the KR-7/5’s piano sounds faithfully reproduce the sense of spaciousness and reverberation of an actual acoustic piano’s sound, a certain amount of reverberation is still perceptible, even with the reverb effect deactivated.
In the upper range, the sound changes abruptly beyond a certain key	On an acoustic piano, notes in the upper one and a half octaves of the keyboard continue to sound until they decay naturally, regardless of the damper pedal. There is a difference in the timbre as well. Roland pianos faithfully simulate such characteristics of the acoustic piano. On the KR-7/5, the range that is unaffected by the damper pedal will change depending on the Key Transpose setting.

Case	Cause/Remedy
A High-pitched whine is produced	<b>When listening through headphones:</b> Some of the more flamboyant and effervescent piano tones feature an ample high-end component, which may make the sound appear to have metallic reverberation added. Since this reverberation becomes particularly audible when supplemented by heavy reverb, you may be able to diminish the problem by reducing the amount of reverb applied to the sound. <b>When listening through speakers:</b> Here, a different cause (such as resonance produced by the KR-7/5) would be suspect. Consult your Roland dealer or nearest Roland Service Center.
	<b>When listening through speakers:</b> Playing at loud volumes may cause instruments near the KR-7/5 to resonate. Resonance can also occur with fluorescent light tubes, glass doors, and other objects. In particular, this problem occurs more easily when the bass component is increased, and when the sound is played at higher volumes. Use the following measures to suppress such resonance. • Place speakers so they are 10–15 cm from walls and other surfaces. • Reduce the volume. • Move the speakers away from any resonating objects. <b>When listening through headphones:</b> Here, a different cause (such as resonance produced by the KR-7/5) would be suspect. Consult your Roland dealer or nearest Roland Service Center.
<b>The automatic accompaniment doesn’t play correctly</b>	
Can’t select a tone or Music Style	Touch <Exit> several times to return to the Basic screen (p. 23), and then select a tone or Music Style.
Automatic accompaniment is not heard.	Has the Balance knob been moved all the way to the right? (p. 67)
	Have you pressed the One Touch Program [Arranger] button? If the One Touch Program [Arranger] button has not been pressed, only the rhythm pattern is played (p. 57).
Chord Intelligence can’t be used.	Is the 16-track Sequencer screen displayed? (p. 117)
	Has Chord Intelligence been switched off? (p. 150) Is the setting for “Piano Style Arranger” active? (p. 66)

## Troubleshooting

Case	Cause/Remedy
Accompaniment tempo becomes unstable	In certain cases, such as when playing Music Styles on disks, the accompaniment may lag when excessive amounts of performance data are used.
Song doesn't play back correctly	
Song doesn't play back	Does the screen indicate message, like "OK to delete song?" (p. 95) The internal songs cannot be played back while recorded performance data remains in the KR-7/5's memory. Try playing back the song after deleting the performance data.
Only the sound of a particular instrument in a song does not play	Is the light for the Track button extinguished? (p. 86) If the button light is out, the music on that track is not heard. Press the track button so the light is illuminated.
	Have song settings been changed for each Part on the 16-Track sequencer screen (p. 118)?
Pressing the [I◀ (Reset)] button doesn't return to the beginning of the song.	Some music files may contain settings that stop play at a point partway through the song. Press the [I◀ (Reset)] button several times more to return to the beginning of the tune.
	Has a Marker placed in the song? (p. 87)
The [▶▶ (Fwd)] and [◀◀ (Bwd)] buttons don't work.	The fast-forward and reverse buttons are ignored while music files is being read in. Wait until processing finishes.
	If you attempt to play back performance data that contains more data than the entire capacity of the KR-7/5's memory, you may find that operations other than playback (such as rewind or fast forward) become unavailable.
There is a slight delay before playback of a song on floppy disk starts.	There are two types of SMF music files: format 0 and format 1. If the song uses SMF format 1 data, there will be a slight delay until playback starts. Refer to the booklet that came with the music files you're using to determine the format type.
Lyrics are not indicated properly in the display.	With some music files, the lyrics cannot be displayed correctly.
	If you press a button while the lyrics are being shown in the display, the lyrics will disappear. To recall them, touch <lyrics> in the Piano or Basic screen, or press the [▶/■ (Play/Stop)] button.
	In the score screen, some lyrics or notes could extend beyond the edges of the screen, and not be displayed.

Case	Cause/Remedy
Score is not indicated properly in the display.	If you select a part that does not contain performance data, notes will not be displayed in the score. Change the part that is displayed (p. 76).
	The score screen feature is particularly unsuitable for the display of difficult, complex musical works that demand accurate notation. Refer to "Notes Regarding the Score Display" (p. 75).
	In the score screen, some lyrics or notes could extend beyond the edges of the screen, and not be displayed.
Song becomes unstable	In certain cases, such as when playing songs on disks, the song may lag when excessive amounts of performance data are used.
Can't record	
Can't record	Has one of the track buttons for recording been selected? (p. 101)
	Has the setting for "Punch-in Recording" (p. 123) or "Tempo Recording" (p. 132) been made? Select the replace recording method (p. 121).
	It is not possible to record while the score is being generated. Once the unit has finished generating the score (i.e., when the measure number in the screen is no longer highlighted), try the operation once again.
Tempo of recorded song or metro-nome is off	If you select an internal song in which the tempo changes during the song, and then record, the tempo will change in the same way for the performances that are recorded on the other tracks. The tempo of the metro-nome will also change in the same way.
	If you record additional material without erasing the previously recorded song, the song will be recorded at the first-recorded tempo. Please erase the previously recorded song before you re-record. (p. 102)
The recorded performance has disappeared.	Any performance that has been recorded is deleted when the power to the KR-7/5 is turned off or a song is selected. A performance cannot be restored once it's been deleted. Be sure to save it on a floppy disk or User Memory before you turn off the power (p. 106).



# Error Messages

Indication	Meaning
Error 00:	To protect the copyright, this music file cannot be saved as an SMF. Also, the music file can not be saved. If you want to save it, please save on the same floppy disk.
Error 01:	You can only read the music file. It can not be saved on a floppy disk or user memory (KR-7).
Error 02:	The protect tab on the floppy disk is set to the Protect position (p. 6). Change it to the Write position. Repeat the procedure.
Error 03:	This floppy disk cannot store the format or save any data. Insert a different disk and repeat the procedure.
Error 04:	The data cannot be saved onto this floppy disk because the format is different. Use the floppy disk in the same format.
Error 05:	A new song cannot be written on this song. Select a different song number or use a different floppy disk, and repeat the procedure.
Error 10:	No floppy disk is connected to the disk drive. Insert the disk correctly, and repeat the procedure.
Error 11:	There is not sufficient space left on the floppy disk or User memory (KR-7) for the data to be saved. Insert a different floppy disk or delete files on user memory, and repeat the procedure.
Error 12:	The floppy disk inserted into the disk drive can't be read. Be sure you're using Roland SMF Music Files or other music files compatible with Roland digital pianos (p. 189). Also, if you want to save your work on floppy disk, you need to format the floppy disk first (p. 104).
Error 13:	The floppy disk was removed from the disk drive while reading or writing was in progress. Insert the floppy disk and repeat the procedure.
Error 14:	This floppy disk or user memory (KR-7) is damaged and cannot be used. Insert a different disk and repeat the procedure or format the user memory (p. 156).
Error 15:	This song or music style cannot be read. Please use a Roland SMF Music Files or Roland Digital Piano compatible music files (p. 189). Also, you can only use User Programs that have been saved with the KR-7/5 (p. 113).
Error 16:	The KR-7/5 cannot read the floppy disk or user memory (KR-7) quickly enough. Press the [▶/■ (Play/Stop)] button, then press the [◀ (Reset)] button and [▶/■ (Play/Stop)] button to play the song.

Indication	Meaning
Error 17:	The selected image data cannot be displayed. If it cannot be made to appear either on the KR-7's display or the external display, you will need to prepare image data that can be used with the KR-7 (p. 154).
Error 30:	The internal memory capacity of the KR-7/5 is full. Save the song data on a floppy disk (p. 106) and delete the song or the User style data stored on the KR-7/5 memory.
Error 40:	The KR-7/5 cannot deal with the excessive MIDI data sent from the external MIDI device. Reduce the amount of MIDI data sent to the KR-7/5.
Error 41:	A MIDI cable or computer cable has been disconnected. Connect it properly and securely.
Error 42:	An excessive amount of performance data has been sent to KR-7/5 in one time and therefore could not be recorded. Change the tempo more slowly to record the performance again.
Error 43	The Computer switch is set to a wrong position or the computer is set wrongly. Switch off the KR-7/5 then set the Computer switch to the correct position and set the computer correctly. After that, switch on the KR-7/5 again.
Error 51:	There may be a problem with the system. Repeat the procedure from the beginning. If it is not solved after you have tried several times, contact the Roland service center.

# Tone List (KR-7)

## [Piano]

Grand Piano1  
PianoStrings  
Piano Choir  
Tremolo Dyno  
Jazzy Vib+Gt  
Suitcase  
Vibraphone  
Harpsi.Doubl  
Marimba  
Steel Drums  
Honky-Tonk  
Stage Rhodes  
Ballad Piano  
Wurlly  
Dyno Rhodes  
Rock Piano  
Honky-tonk 2  
Clav.  
Harpsi.Singl  
Harpsichord  
UprightPiano  
Grand Piano2  
Bell Piano  
Piano Oohs  
Bright Piano  
E. Grand  
MIDI Piano1  
E.Piano 1  
St.FM EP  
FM+SA EP  
Hard FM EP  
Harpsi.o  
Coupled Hps.  
Soft Marimba  
EG+Rhodes 1  
EG+Rhodes 2  
Hard Rhodes  
Vibra Bells  
Celesta  
Glockenspiel  
Soft E.Piano  
60's E.Piano  
E.Piano 2  
Xylophone  
Music Box  
Balafon  
Detuned EP 1  
Detuned EP 2  
Hard E.Piano  
Hard Clav.  
Soft Clav.  
Reso Clav.  
Phase Clav.  
Pop Vibe.  
Pop Celesta  
Tubular-bell  
Santur  
Kalimba  
Air Grand  
Piano 1  
Piano 2  
Piano 3

## [Organ]

Jazz Organ  
Full Organ 1  
Lower Organ  
Theater Org.  
Diapason 8'  
Bandneon  
Perc. Organ  
Full Organ 2  
Lower Organ2  
Church Organ  
Rock Organ1  
Blues Harp  
Pop Organ  
L-Organ  
Trem.Flute  
Accordion  
Nason flt 8'  
Organ Flute  
Jazz Organ2  
Jazz Organ3  
Jazz Organ4  
CheeseOrgan  
Full Organ 3  
Full Organ 4  
Rotary Org.S  
Rotary Org.F  
Rock Organ2  
Pipe Org. Bs  
Organ Bass  
Metalic Org.  
VS Organ  
Organ 1  
Organ 2  
Digi Church

## [Guitar / Bass]

EX Ac.Guitar  
Flamenco Gtr  
Steel Guitar  
Jazz Guitar  
Requint Gtr  
12str Guitar  
Nylon+Steel  
Nylon Guitar  
Mandolin  
Gut Guitar  
Acoustic Bs.  
A.Bass+Cymbal  
JC E.Guitar  
DistortionGt  
Rock Rhythm  
Rock Rhythm2  
Overdrive Gt  
Power Guitar  
Power Gt.2  
Muted Dis.Gt  
Fingered Bs.  
Picked Bs.  
Fretless Bs.  
Slap Bass  
Steel Vox  
Muted Gt.  
Muted Gt.2  
Mellow Gt.  
5th Dist.  
Feedback Gt2  
Synth Bass 1  
Synth Bass 2

SynthBass101  
Jungle Bass  
Modular Bass  
WireStr Bass  
ResoSH Bass  
SH101 Bass  
Mute PickBs.  
Mr.Smooth  
Open Hard  
Dazed Guitar  
Acid Guitar  
Hawaiian Gt.  
Ukulele  
Banjo  
Koto  
Shamisen

## [Strings]

Velo Strings  
Dolce Strings  
SlowStrings2  
Tremolo Str  
Suspense Str  
EX Orchestra  
Choir Str  
Harp Strings  
Warm Strings  
Violin  
Slow Strings  
Cello  
St. Harp  
DecayStrings  
Legato Str  
Strings  
Oct Strings  
PizzicatoStr  
Mellow Pizz.  
Bell Strings  
Orchestra  
OrchestraHit  
Warm JP Str  
Slow Violin  
Contrabass  
Timpani  
Syn.Strings1  
Syn.Strings2  
Syn.Slow Str  
Strings 2  
JP Saw Str  
OB Strings  
Euro Hit  
6th Hit  
Bass Hit  
Philly Hit

## [Sax / Brass]

Super Tenor  
EX Tenor Sax  
Sax Section  
Romantic Tp  
TromboneSoft  
AltoSax + Tp  
Flute  
Soprano Sax  
Clarinet  
MutedTrumpet  
Oboe  
Flugel Horn

Power Brass  
St. Brass ff  
AltoSax Soft  
English Horn  
EX Tp&Shake  
BrassSection  
Bs Clarinet  
Tenor Sax f  
Brite Brass  
Brass ff  
OrchestraBrs  
Grow Sax  
Baritone Sax  
Alto Sax  
EX Trumpet  
Tp Shake  
Tenor Sax  
GS Bari Sax  
SuperF.Horns  
Fr.Horn Solo  
Jump Brass  
Soft Brass  
DeepSynBrass  
Trombone  
Trombone 2  
Tuba  
Piccolo  
Pan Flute  
GS Pan Flute  
Blow Pipe  
Bottle Blow  
BottleBlow2  
Bassoon  
Recorder  
Trumpet  
French Horn  
Synth Brass1  
Synth Brass2  
Shakuhachi  
Brass 1  
Brass 2  
Ocarina

## [Voice]

Boys Choir  
Kid's Choir  
Jazz Scat  
Rich Choir  
Holy Voices  
Jz Scat Vib  
Opera Voice  
Jz Scat Doet  
Humming  
Dreamy Choir  
Doos Voice  
Doot Accent  
Dat Accent  
Bop Accent  
Thum Voice  
HollowReleas  
Choir Oohs  
VoiceAah Fem  
Choir Aahs  
Warm SqrPad  
New Age Pad  
Sugar Key  
LM PureLead  
LM Square  
JP SuperSaw

Natural Lead  
2600 SubOsc  
SquareWave2  
Org Bells  
Oohs Chord  
Fantasia  
Crystal  
Harpvox  
CC Solo  
Vox Sweep  
Brightness  
Syn.Square  
JP8 Square  
FM Lead  
FM Lead 2  
Mg Lead  
Dual Sqr&Saw  
P5 Saw Lead  
Rhythmic Saw  
Waspy Synth  
JP8 Pulse  
Cheese Saw  
SynVox  
Clear Bells  
Soft Crystal  
Digi Bells  
Nylon Harp  
Nylon+Rhodes  
Fantasia 2  
Soft Pad  
P5 Poly  
Reso Saw  
RAVE Vox  
Fat & Perky  
Heaven II  
JP8 Sqr Pad  
Sweep Pad 2  
Big Panner  
Ai-yai-a  
Echo Pan 2  
Falling Down  
Poly King  
Octave Stack  
Warm Pad  
Rising Osc  
RandomEnding  
Piano 1  
Piano 1w  
Piano 1d  
Piano 2  
Piano 2w  
Piano 3  
Piano 3w  
GS Honkytonk  
Honky-tonk 2  
GS E.Piano1  
GS E.Piano2  
60's E.Piano  
E.Piano 1v  
E.Piano 2v  
Detuned EP 1  
Detuned EP 2  
GS Harpsi  
Coupled Hps.  
Harpsi.w  
Harpsi.o  
Soft Clav.  
Celesta  
Glockenspiel  
Music Box  
Vibraphone

Vibe.w	Choir	Taisho Koto	Marimba*	Ocarina*
GS Marimba	Pop Voice	Kalimba	Xylophone*	Square Wave*
Marimba	SynVox	Bagpipe	Tubularbell*	Saw Wave*
Xylophone	OrchestraHit	Fiddle	Santur*	Doctor Solo*
Tubular-bell	GS Trumpet	Shanai	Organ 1*	SynCalliope*
Church Bell	Trombone	Tinkle Bell	Organ 2*	ChifferLead*
Carillon	Trombone 2	Agogo	Pop Organ 1*	Charang*
Santur	Tuba	Steel Drums	Rock Organ2*	Solo Vox*
Organ 1	MutedTrumpet	Woodblock	ChurchOrg.1*	5th SawWave*
Organ 2	French Horn	Castanets	Reed Organ*	Bass & Lead*
Pop Organ	Fr.Horn 2	Taiko	AccordionFr*	Fantasia*
Detuned Or.1	Brass 1	Concert BD	Harmonica*	Warm Pad*
Detuned Or.2	Brass 2	Melo. Tom 1	Bandoneon*	Polysynth*
Church Org.1	Synth Brass1	Melo. Tom 2	Nylon-strGt*	Space Voice*
Church Org.2	Synth Brass2	Synth Drum	Steel-strGt*	Bowed Glass*
Church Org.3	Synth Brass3	808 Tom	Jazz Guitar*	Metal Pad*
Full Organ 4	Synth Brass4	Elec Perc.	Clean Gt.*	Halo Pad*
Jazz Organ	AnalogBrass1	Reverse Cym.	Muted Gt.*	Sweep Pad*
Rock Organ 2	AnalogBrass2	Gt.FretNoise	Funk Gt.*	Ice Rain*
Reed Organ	GS Sop.Sax	Gt.Cut Noise	OverdriveGt*	Soundtrack*
Accordion Fr	Alto Sax	String Slap	Dist.Guitar*	Crystal*
Accordion It	Tenor Sax	Breath Noise	Gt.Harmo*	Syn Mallet*
GS Harmonica	GS Bari Sax	Fl.Key Click	Acoustic Bs*	Atmosphere*
Bandoneon	GS Oboe	Seashore	Fingered Bs*	Brightness*
GS Nylon Gt.	English Horn	Rain	Picked Bs.*	Goblin*
Nylon Guitar	Bassoon	Thunder	Fretless Bs*	Echo Drops*
Nylon Gt.o	Clarinet	Wind	Slap Bass 1*	Star Theme*
Ukulele	Piccolo	Stream	Slap Bass 2*	Sitar*
Steel-str.Gt	GS Flute	Bubble	SynthBass 1*	Banjo*
12-str.Gt	Recorder	Bird	SynthBass 2*	Shamisen*
Mandolin	GS Pan Flute	Dog	Rubber Bass*	Koto*
Jazz Guitar	Bottle Blow	Horse-Gallop	Violin*	Kalimba*
Hawaiian	Shakuhachi	Bird 2	Viola*	Bagpipe*
Clean Gt.	Whistle	Telephone 1	Cello*	Fiddle*
Chorus Gt.	Ocarina	Telephone 2	Contrabass*	Shanai*
Muted Gt.	Square Wave	DoorCreaking	Tremolo Str*	Tinkle Bell*
Funk Gt.	Square	Door	Pizzicato*	Agogo*
Funk Gt.2	Sine Wave	Scratch	Harp*	Steel Drums*
Overdrive Gt	Saw Wave	Windchime	Timpani*	Woodblock*
DistortionGt	Saw	Helicopter	Strings*	Taiko*
Feedback Gt.	Doctor Solo	Car-Engine	SlowStrings*	Melo.Tom 1*
Gt.Harmonics	Syn.Calliope	Car-Stop	Syn.Str 1*	Synth Drum*
Gt.Feedback	Chiffer Lead	Car-Pass	Syn.Str 2*	ReverseCym.*
GS Ac.Bass	Charang	Car-Crash	Choir Aahs*	Fret Noise*
GS Fing.Bass	Solo Vox	Siren	Pop Voice*	BreathNoise*
Picked Bs	5th Saw Wave	Train	SynVox*	Seashore*
Fretless Bs.	Bass & Lead	Jetplane	Orche.Hit*	Bird*
Slap Bass	Fantasia	Starship	Trumpet*	Telephone 1*
Slap Bass 2	Warm Pad	Burst Noise	Trombone*	Helicopter*
SynthBass101	Polysynth	Applause	Tuba*	Applause*
Synth Bass 1	Space Voice	Laughing	M.Trumpet*	Gun Shot*
Synth Bass 2	Bowed Glass	Screaming	FrenchHorns*	
Synth Bass 3	Metal Pad	Punch	Brass 1*	
Synth Bass 4	Halo Pad	Heart Beat	SynthBrass1*	
Rubber Bass	Sweep Pad	Footsteps	SynthBrass2*	
Violin	Ice Rain	Gun Shot	A.Brass 1*	
Slow Violin	Soundtrack	Machine Gun	Soprano Sax*	
Viola	Crystal	Lasergun	Alto Sax*	
Cello	Syn Mallet	Explosion	Tenor Sax*	
Contrabass	Atmosphere	Piano 1*	BaritoneSax*	
Trem. Str	Brightness	Piano 2*	Oboe*	
PizzicatoStr	Goblin	Piano 3*	EnglishHorn*	
GS Harp	Echo Drops	Honky-tonk*	Bassoon*	
Timpani	Echo Bell	E.Piano 1*	Clarinet*	
GS Strings	Echo Pan	E.Piano 2*	Piccolo*	
Orchestra	Star Theme	Harpsichord*	Flute*	
GS Sl.Str	Sitar	Clav.*	Recorder*	
Syn.Strings1	Sitar 2	Celesta*	Pan Flute*	
Syn.Strings2	Banjo	Glocken*	Bottle Blow*	
Syn.Strings3	Shamisen	Music Box*	Shakuhachi*	
Choir Aahs	Koto	Vibraphone*	Whistle*	

\* Tone with a "\*" symbol appended to their name may not play back satisfactorily on other GS sound generating devices.

# Tone List (KR-5)

## [Piano]

Grand Piano1  
PianoStrings  
Piano Choir  
Dyno Rhodes  
Harpsichord  
Suitcase  
Vibraphone  
Harpsi.Doubl  
Marimba  
Steel Drums  
Honky-tonk 2  
Stage Rhodes  
Ballad Piano  
Tremolo Dyno  
Jazzy Vib+Gt  
Wurly  
Rock Piano  
Clav.  
Honky-Tonk  
Bright Piano  
Harpsi.Singl  
UprightPiano  
Grand Piano2  
Bell Piano  
Piano Oohs  
E. Grand  
MIDI Piano1  
E.Piano 1  
FM+SA EP  
St.FM EP  
Hard FM EP  
Soft Marimba  
EG+Rhodes 1  
EG+Rhodes 2  
Hard Rhodes  
Harpsi.o  
Coupled Hps.  
Vibra Bells  
Celesta  
Glockenspiel  
Soft E.Piano  
60's E.Piano  
E.Piano 2  
E.Piano 3  
Xylophone  
Music Box  
Balafon  
Detuned EP 1  
Detuned EP 2  
Hard E.Piano  
Hard Clav.  
Soft Clav.  
Reso Clav.  
Phase Clav.  
Pop Vibe.  
Pop Celesta  
Tubular-bell  
Santur  
Kalimba  
Air Grand  
Piano 1  
Piano 2  
Piano 3

## [Organ]

Jazz Organ  
Full Organ 1  
Lower Organ  
Theater Org.  
Nason flt 8'  
Bandneon  
Organ Flute  
Jazz Organ2  
Full Organ 2  
Full Organ 3  
Lower Organ2  
Church Organ  
Rock Organ1  
Harmonica  
Pop Organ  
Accordion  
Trem.Flute  
Jazz Organ3  
Jazz Organ4  
Full Organ 4  
Rotary Org.S  
Rotary Org.F  
Rock Organ2  
Pipe Org. Bs  
Organ Bass  
Metalic Org.  
VS Organ  
Organ 1  
Organ 2  
Digi Church

## [Guitar / Bass]

Steel Guitar  
Nylon Guitar  
Jazz Guitar  
Nylon+Steel  
12str Guitar  
Nylon Gt.o  
Hawaiian Gt.  
Banjo  
JC E.Guitar  
Muted Gt.  
Acoustic Bs.  
A.Bass+Cymbal  
DistortionGt  
Steel Vox  
Rock Rhythm  
Rock Rhythm2  
Overdrive Gt  
Power Guitar  
Power Gt.2  
Muted Dis.Gt  
Fingered Bs.  
Picked Bs.  
Fretless Bs.  
Slap Bass  
Muted Gt.2  
Mellow Gt.  
5th Dist.  
Feedback Gt2  
Synth Bass 1  
Synth Bass 2  
SynthBass101  
Jungle Bass  
Modular Bass  
WireStr Bass  
ResoSH Bass  
SH101 Bass

Mute PickBs.  
Mr.Smooth  
Open Hard  
Dazed Guitar  
Acid Guitar  
Ukulele  
Koto  
Shamisen

## [Strings]

Strings  
Slow Strings  
Choir Str  
Harp Strings  
Trem. Str  
Violin  
Cello  
Warm Strings  
DecayStrings  
Orchestra  
Oct Strings  
St. Harp  
Velo Strings  
Legato Str  
PizzicatoStr  
SlowStrings2  
Bell Strings  
OrchestraHit  
Warm JP Str  
Slow Violin  
Contrabass  
Timpani  
Syn.Strings1  
Syn.Strings2  
Strings 2  
OB Strings  
Euro Hit  
6th Hit  
Bass Hit

## [Sax / Brass]

EX Tenor Sax  
Soprano Sax  
Flute  
Trumpet  
MutedTrumpet  
AltoSax + Tp  
Oboe  
Clarinet  
TromboneSoft  
Soft Brass  
Baritone Sax  
Tuba  
Romantic Tp  
Power Brass  
St. Brass ff  
English Horn  
BrassSection  
Blow Sax  
Brite Brass  
Brass ff  
EX Trumpet  
Grow Sax  
Alto Sax  
Tenor Sax  
GS Bari Sax  
Flugel Horn  
Fr.Horn Solo

Synth Brass3  
Trombone2  
Piccolo  
Pan Flute  
GS Pan Flute  
Blow Pipe  
Bottle Blow  
Bassoon  
Recorder  
French Horn  
Synth Brass1  
Synth Brass2  
Oct SynBrass  
Shakuhachi  
Brass 1  
Brass 2  
Ocarina

## [Voice]

Jazz Scat  
Dreamy Choir  
Boys Choir  
Holy Voices  
HollowReleas  
Rich Choir  
Dat Accent  
Bop Accent  
Thum Voice  
Pop Voice  
Org Bells  
Humming  
Doos Voice  
Choir Oohs  
Choir Aahs  
Warm SqrPad  
New Age Pad  
LM PureLead  
LM Square  
Natural Lead  
2600 SubOsc  
SquareWave2  
Fantasia  
Crystal  
Harpvox  
CC Solo  
Brightness  
Syn.Square  
JP8 Square  
FM Lead  
FM Lead 2  
Mg Lead  
Dual Sqr&Saw  
P5 Saw Lead  
Rhythmic Saw  
Waspy Synth  
JP8 Pulse  
Cheese Saw  
SynVox  
Clear Bells  
Soft Crystal  
Digi Bells  
Nylon Harp  
Nylon+Rhodes  
Fantasia 2  
Soft Pad  
P5 Poly  
Reso Saw  
RAVE Vox  
Fat & Perky

Heaven II  
JP8 Sqr Pad  
Sweep Pad 2  
Big Panner  
Ai-yai-a  
Echo Pan 2  
Falling Down  
Poly King  
Warm Pad  
RandomEnding  
Piano 1  
Piano 1w  
Piano 1d  
Piano 2  
Piano 2w  
Piano 3  
Piano 3w  
GS Honkytonk  
Honky-tonk 2  
GS E.Piano1  
GS E.Piano2  
60's E.Piano  
E.Piano 1v  
E.Piano 2v  
Detuned EP 1  
Detuned EP 2  
GS Harpsi  
Coupled Hps.  
Harpsi.w  
Harpsi.o  
Soft Clav.  
Celesta  
Glockenspiel  
Music Box  
Vibraphone  
Vibe.w  
GS Marimba  
Marimba  
Xylophone  
Tubular-bell  
Church Bell  
Carillon  
Santur  
Organ 1  
Organ 2  
Pop Organ  
Detuned Or.1  
Detuned Or.2  
Church Org.1  
Church Org.2  
Church Org.3  
Full Organ 4  
Jazz Organ  
Rock Organ 2  
Reed Organ  
Accordion It  
Accordion It  
GS Harmonica  
Bandoneon  
GS Nylon Gt.  
Nylon Guitar  
Nylon Gt.o  
Ukulele  
Steel-str.Gt  
12-str.Gt  
Mandolin  
Jazz Guitar  
Hawaiian  
Clean Gt.  
Chorus Gt.  
Muted Gt.

Funk Gt.	Square	Door	Pizzicato*	Agogo*
Funk Gt.2	Sine Wave	Scratch	Harp*	Steel Drums*
Overdrive Gt	Saw Wave	Windchime	Timpani*	Woodblock*
DistortionGt	Saw	Helicopter	Strings*	Taiko*
Feedback Gt.	Doctor Solo	Car-Engine	SlowStrings*	Melo.Tom 1*
Gt.Harmonics	Syn.Calliope	Car-Stop	Syn.Str 1*	Synth Drum*
Gt.Feedback	Chiffer Lead	Car-Pass	Syn.Str 2*	ReverseCym.*
GS Ac.Bass	Charang	Car-Crash	Choir Aahs*	Fret Noise*
GS Fing.Bass	Solo Vox	Siren	Pop Voice*	BreathNoise*
Picked Bs	5th Saw Wave	Train	SynVox*	Seashore*
Fretless Bs.	Bass & Lead	Jetplane	Orche.Hit*	Bird*
Slap Bass	Fantasia	Starship	Trumpet*	Telephone 1*
Slap Bass 2	Warm Pad	Burst Noise	Trombone*	Helicopter*
SynthBass101	Polysynth	Applause	Tuba*	Applause*
Synth Bass 1	Space Voice	Laughing	M.Trumpet*	Gun Shot*
Synth Bass 2	Bowed Glass	Screaming	FrenchHorns*	
Synth Bass 3	Metal Pad	Punch	Brass 1*	
Synth Bass 4	Halo Pad	Heart Beat	SynthBrass1*	
Rubber Bass	Sweep Pad	Footsteps	SynthBrass2*	
Violin	Ice Rain	Gun Shot	A.Brass 1*	
Slow Violin	Soundtrack	Machine Gun	Soprano Sax*	
Viola	Crystal	Lasergun	Alto Sax*	
Cello	Syn Mallet	Explosion	Tenor Sax*	
Contrabass	Atmosphere	Piano 1*	BaritoneSax*	
Trem. Str	Brightness	Piano 2*	Oboe*	
PizzicatoStr	Goblin	Piano 3*	EnglishHorn*	
GS Harp	Echo Drops	Honky-tonk*	Bassoon*	
Timpani	Echo Bell	E.Piano 1*	Clarinet*	
GS Strings	Echo Pan	E.Piano 2*	Piccolo*	
Orchestra	Star Theme	Harpsichord*	Flute*	
GS Sl.Str	Sitar	Clav.*	Recorder*	
Syn.Strings1	Sitar 2	Celesta*	Pan Flute*	
Syn.Strings2	Banjo	Glocken*	Bottle Blow*	
Syn.Strings3	Shamisen	Music Box*	Shakuhachi*	
Choir Aahs	Koto	Vibraphone	Whistle*	
Choir	Taisho Koto	Marimba*	Ocarina*	
Pop Voice	Kalimba	Xylophone*	Square Wave*	
SynVox	Bagpipe	Tubularbell*	Saw Wave*	
OrchestraHit	Fiddle	Santur*	Doctor Solo*	
GS Trumpet	Shanai	Organ 1*	SynCalliope*	
Trombone	Tinkle Bell	Organ 2*	ChifferLead*	
Trombone 2	Agogo	Pop Organ 1*	Charang*	
Tuba	Steel Drums	Rock Organ2*	Solo Vox*	
MutedTrumpet	Woodblock	ChurchOrg.1*	5th SawWave*	
French Horn	Castanets	Reed Organ*	Bass & Lead*	
Fr.Horn 2	Taiko	AccordionFr*	Fantasia*	
Brass 1	Concert BD	Harmonica*	Warm Pad*	
Brass 2	Melo. Tom 1	Bandoneon*	Polysynth*	
Synth Brass1	Melo. Tom 2	Nylon-strGt*	Space Voice*	
Synth Brass2	Synth Drum	Steel-strGt*	Bowed Glass*	
Synth Brass3	808 Tom	Jazz Guitar*	Metal Pad*	
Synth Brass4	Elec Perc.	Clean Gt.*	Halo Pad*	
AnalogBrass1	Reverse Cym.	Muted Gt.*	Sweep Pad*	
AnalogBrass2	Gt.FretNoise	Funk Gt.*	Ice Rain*	
GS Sop.Sax	Gt.Cut Noise	OverdriveGt*	Soundtrack*	
Alto Sax	String Slap	Dist.Guitar*	Crystal*	
Tenor Sax	Breath Noise	Gt.Harmo*	Syn Mallet*	
GS Bari Sax	Fl.Key Click	Acoustic Bs*	Atmosphere*	
GS Oboe	Seashore	Fingered Bs*	Brightness*	
English Horn	Rain	Picked Bs.*	Goblin*	
Bassoon	Thunder	Fretless Bs*	Echo Drops*	
Clarinet	Wind	Slap Bass 1*	Star Theme*	
Piccolo	Stream	Slap Bass 2*	Sitar*	
GS Flute	Bubble	SynthBass 1*	Banjo*	
Recorder	Bird	SynthBass 2*	Shamisen*	
GS Pan Flute	Dog	Rubber Bass*	Koto*	
Bottle Blow	Horse-Gallop	Violin*	Kalimba*	
Shakuhachi	Bird 2	Viola*	Bagpipe*	
Whistle	Telephone 1	Cello*	Fiddle*	
Ocarina	Telephone 2	Contrabass*	Shanai*	
Square Wave	DoorCreaking	Tremolo Str*	Tinkle Bell*	

\* Tone with a "\*" symbol appended to their name may not play back satisfactorily on other GS sound generating devices.

# Drum Set List

\* -----: No sound.

\* [EXC]: will not sound simultaneously with other percussion instruments of the same number.

	POP Set	ROCK Set	JAZZ BRUSH Set	VOX DRUM Set (KR-7)
21	R&B Snare	R&B Snare	R&B Snare	R&B Snare
22	Rock Snare	Pop Snare m	Pop Snare m	Rock Snare
23	Rock Snare	Pop Snare m	Pop Snare m	Rock Snare
24	Pop Snare m	Pop Snare m	Pop Snare m	Pop Snare m
25	Pop Snare Ghost	Pop Snare Ghost	Pop Snare Ghost	Pop Snare Ghost
26	Pop Snare m	Pop Snare m	Pop Snare m	Pop Snare m
27	Finger Snap	Finger Snap	Finger Snap	Finger Snap
28	707 Claps	707 Claps	707 Claps	707 Claps
29	Hand Clap [EXC7]	Hand Clap [EXC7]	Hand Clap [EXC7]	Hand Clap [EXC7]
30	Hand Clap2 [EXC7]	Hand Clap2 [EXC7]	Hand Clap2 [EXC7]	Hand Clap2 [EXC7]
31	Hand Clap	Hand Clap	Hand Clap	Hand Clap
32	Pop Pedal HH [EXC1]	Pop Pedal HH [EXC1]	Pop Pedal HH [EXC1]	Pop Pedal HH
33	Gospel Hand Clap	Gospel Hand Clap	Gospel Hand Clap	Gospel Hand Clap
34	Snare Roll	Snare Roll	Snare Roll	Vox Dut
35	Pop Kick	Rock Kick	Pop Kick	Vox Dom
C2 36	Pop Kick	Rock Kick	Pop Kick	Vox Tuush
37	Pop Side Stick	Rock Side Stick	Jazz Snare Swing	Vox Hehho
38	Pop Sanre s	Rock Sanre s	Jazz Sanre	Vox Doyear
39	Pop Snare Ghost	Rock Snare Ghost	Pop Snare Swing	Vox Thu!
40	Pop Snare s	Rock Snare s	Jazz Sanre	Vox That
41	Pop Low Tom f	Rock Low Tom f	Jazz Low Tom f	Vox Aahhh
42	Pop CHH 1 [EXC1]	Rock CHH 1 [EXC1]	Pop CHH 1 [EXC1]	Vox Tu
43	Pop Low Tom	Rock Low Tom	Jazz Low Tom	Vox Dooh
44	Pop CHH 2 [EXC1]	Rock CHH 2 [EXC1]	Pop CHH 2 [EXC1]	Vox Ptu
45	Pop Mid Tom f	Rock Mid Tom f	Jazz Mid Tom f	Vox Down
46	Pop OHH [EXC1]	Rock OHH [EXC1]	Pop OHH [EXC1]	Vox Pa
47	Pop Mid Tom	Rock Mid Tom	Jazz Mid Tom	Vox Bom
C3 48	Pop High Tom f	Rock High Tom f	Jazz High Tom f	Vox Toear
49	Pop Crash Cymbal 1	Rock Crash Cymbal	Jazz Crash Cymbal 1	Vox Aahhu
50	Pop High Tom	Rock High Tom	Jazz High Tom	Vox Toya
51	Pop Ride Cymbal 1	Rock Ride Cymbal 1	Jazz Ride Cymbal 1	Vox Thu
52	Pop Chinees Cymbal	Pop Chinees Cymbal	Jazz Chinees Cymbal	Vox Cheey
53	Pop Ride Bell	Pop Ride Bell	Jazz Ride Cymbal 2	Vox Cymm
54	Tambourine 2	Tambourine 2	Tambourine 2	Vox Tub
55	Splash Cymbal	Splash Cymbal	Splash Cymbal	Vox Pruru
56	Cha Cha Cowbell	Cha Cha Cowbell	Cha Cha Cowbell	Vox Tut
57	Pop Crash Cymbal 2	Chinees Cymbal	Jazz Crash Cymbal 2	Vox Tyun
58	Vibra-slap 2	Vibra-slap 2	Vibra-slap 2	Vox Tdum
59	Pop Ride Cymbal 2	Pop Ride Cymbal 3	Pop Ride Cymbal 2	Vox Afahhhh
C4 60	High Bongo 2	High Bongo 2	High Bongo 2	High Bongo 2
61	Low Bongo 2	Low Bongo 2	Low Bongo 2	Low Bongo 2
62	Mute Conga	Mute Conga	Mute Conga	Mute Conga
63	High Conga 2	High Conga 2	High Conga 2	High Conga 2
64	Low Conga 2	Low Conga 2	Low Conga 2	Low Conga 2
65	High Timbale 2	High Timbale 2	High Timbale 2	High Timbale 2
66	Low Timbale 2	Low Timbale 2	Low Timbale 2	Low Timbale 2
67	High Agogo	High Agogo	High Agogo	High Agogo
68	Low Agogo	Low Agogo	Low Agogo	Low Agogo
69	Shaker 3	Shaker 3	Shaker 3	Shaker 3
70	Shaker 4	Shaker 4	Shaker 4	Shaker 4
71	Short Hi Whistle [EXC2]	Short Hi Whistle [EXC2]	Short Hi Whistle [EXC2]	Short Hi Whistle [EXC2]
C5 72	Long Low Whistle [EXC2]	Long Low Whistle [EXC2]	Long Low Whistle [EXC2]	Long Low Whistle [EXC2]
73	Short Guiro [EXC3]	Short Guiro [EXC3]	Short Guiro [EXC3]	Short Guiro [EXC3]
74	Long Guiro [EXC3]	Long Guiro [EXC3]	Long Guiro [EXC3]	Long Guiro [EXC3]
75	Claves	Claves	Claves	Claves
76	High Wood Block	High Wood Block	High Wood Block	High Wood Block
77	Low Wood Block	Low Wood Block	Low Wood Block	Low Wood Block
78	Mute Cuica [EXC4]	Mute Cuica [EXC4]	Mute Cuica [EXC4]	Mute Cuica [EXC4]
79	Open Cuica [EXC4]	Open Cuica [EXC4]	Open Cuica [EXC4]	Open Cuica [EXC4]
80	Mute Triangle [EXC5]	Mute Triangle [EXC5]	Mute Triangle [EXC5]	Mute Triangle [EXC5]
81	Open Triangle [EXC5]	Open Triangle [EXC5]	Open Triangle [EXC5]	Open Triangle [EXC5]
82	Shaker	Shaker	Shaker	Shaker
83	Jingle Bell	Jingle Bell	Jingle Bell	Jingle Bell
C6 84	Bell Tree	Bell Tree	Bell Tree	Bell Tree
85	Castanets	Castanets	Castanets	Castanets
86	Mute Surdo [EXC6]	Mute Surdo [EXC6]	Mute Surdo [EXC6]	Mute Surdo [EXC6]
87	Open Surdo [EXC6]	Open Surdo [EXC6]	Open Surdo [EXC6]	Open Surdo [EXC6]
88	Cana	Cana	Cana	Cana
89	Falamento Hi-Timbale	Falamento Hi-Timbale	Falamento Hi-Timbale	Falamento Hi-Timbale
90	Falamento Lo-Timbale	Falamento Lo-Timbale	Falamento Lo-Timbale	Falamento Lo-Timbale
91	Falamento Tmbl Flam	Falamento Tmbl Flam	Falamento Tmbl Flam	Falamento Tmbl Flam
92	Shekere 1	Shekere 1	Shekere 1	Shekere 1
93	Shekere 2	Shekere 2	Shekere 2	Shekere 2
94	Low Bongo Mute	Low Bongo Mute	Low Bongo Mute	Low Bongo Mute
95	High Bongo Mute	High Bongo Mute	High Bongo Mute	High Bongo Mute
C7 96	-----	-----	-----	-----
97	-----	-----	-----	-----
98	-----	-----	-----	-----
99	-----	-----	-----	-----
100	Falamento HC	Falamento HC	Falamento HC	Falamento HC
101	Falamento HC	Falamento HC	Falamento HC	Falamento HC
102	Bongo Cowbell	Bongo Cowbell	Bongo Cowbell	Bongo Cowbell
103	-----	-----	-----	-----
104	Bongo Cowbell	Bongo Cowbell	Bongo Cowbell	Bongo Cowbell
105	-----	-----	-----	-----

# Drum Set List

\* -----: No sound.

\* [EXC]: will not sound simultaneously with other percussion instruments of the same number.

	STANDARD Set	ROOM Set	POWER Set	ELECTORONIC Set
21	-----	-----	-----	-----
22	-----	-----	-----	-----
23	-----	-----	-----	-----
24	Bar Chime	Bar Chime	Bar Chime	Bar Chime
25	Snare Roll	Snare Roll	Snare Roll	Snare Roll
26	Finger Snap	Finger Snap	Finger Snap	Finger Snap
27	High Q	High Q	High Q	High Q
28	Slap	Slap	Slap	Slap
29	Scratch Push [EXC7]	Scratch Push [EXC7]	Scratch Push [EXC7]	Scratch Push [EXC7]
30	Scratch Pull [EXC7]	Scratch Pull [EXC7]	Scratch Pull [EXC7]	Scratch Pull [EXC7]
31	Sticks	Sticks	Sticks	Sticks
32	Square Click	Square Click	Square Click	Square Click
33	Metronome Click	Metronome Click	Metronome Click	Metronome Click
34	Metronome Bell	Metronome Bell	Metronome Bell	Metronome Bell
35	Std Kick 2'	Kick1	Std Kick 2	Std Kick 2
C2 36	Kick 1	Room Kick	MONDO Kick	Elec BD
37	Side Stick	Side Stick	Side Stick	Side Stick
38	Std Snr 1	Room Snr 1	Gated SD	Elec SD
39	Hand Clap	Hand Clap	Hand Clap	Hand Clap
40	Std Snr 2	Std Snr 1	Snare Drum 2	Gated SD
41	Low Tom 2	Room Low Tom 2'	Room Low Tom 2	Elec Low Tom 2
42	Closed Hi-hat 1' [EXC1]	Closed Hi-hat 1' [EXC1]	Closed Hi-hat 1 [EXC1]	Closed Hi-hat 1 [EXC1]
43	Low Tom 1	Room Low Tom 1'	Room Low Tom 1	Elec Low Tom 1
44	Pedal Hi-hat 1' [EXC1]	Pedal Hi-hat 1' [EXC1]	Pedal Hi-hat 1 [EXC1]	Pedal Hi-hat 1 [EXC1]
45	Mid Tom 2	Room Mid Tom 2'	Room Mid Tom 2	Elec Mid Tom 2
46	Open Hi-hat 1' [EXC1]	Open Hi-hat 1' [EXC1]	Open Hi-hat 1 [EXC1]	Open Hi-hat 1 [EXC1]
47	Mid Tom 1	Room Mid Tom 1'	Room Mid Tom 1	Elec Mid Tom 1
C3 48	High Tom 2	Room Hi Tom 2'	Room Hi Tom 2	Elec Hi Tom 2
49	Crash Cymbal 1	Crash Cymbal 1	Crash Cymbal 1	Crash Cymbal 1
50	High Tom 1	Room Hi Tom 1'	Room Hi Tom 1	Elec Hi Tom 1
51	Ride Cymbal 1	Ride Cymbal 1	Ride Cymbal 1	Ride Cymbal 1
52	Chinese Cymbal	Chinese Cymbal	Chinese Cymbal	Reverse Cymbal
53	Ride Bell	Ride Bell	Ride Bell	Ride Bell
54	Tambourine	Tambourine	Tambourine	Tambourine
55	Splash Cymbal	Splash Cymbal	Splash Cymbal	Splash Cymbal
56	Cowbell	Cowbell	Cowbell	Cowbell
57	Crash Cymbal 2	Crash Cymbal 2	Crash Cymbal 2	Crash Cymbal 2
58	Vibra-slap	Vibra-slap	Vibra-slap	Vibra-slap
59	Ride Cymbal 2	Ride Cymbal 2	Ride Cymbal 2	Ride Cymbal 2
C4 60	High Bongo	High Bongo	High Bongo	High Bongo
61	Low Bongo	Low Bongo	Low Bongo	Low Bongo
62	Mute High Conga	Mute High Conga	Mute High Conga	Mute High Conga
63	Open High Conga	Open High Conga	Open High Conga	Open High Conga
64	Low Conga	Low Conga	Low Conga	Low Conga
65	High Timbale	High Timbale	High Timbale	High Timbale
66	Low Timbale	Low Timbale	Low Timbale	Low Timbale
67	High Agogo	High Agogo	High Agogo	High Agogo
68	Low Agogo	Low Agogo	Low Agogo	Low Agogo
69	Cabasa	Cabasa	Cabasa	Cabasa
70	Maracas	Maracas	Maracas	Maracas
71	Short Hi Whistle [EXC2]	Short Hi Whistle [EXC2]	Short Hi Whistle [EXC2]	Short Hi Whistle [EXC2]
C5 72	Long Low Whistle [EXC2]	Long Low Whistle [EXC2]	Long Low Whistle [EXC2]	Long Low Whistle [EXC2]
73	Short Guiro [EXC3]	Short Guiro [EXC3]	Short Guiro [EXC3]	Short Guiro [EXC3]
74	Long Guiro [EXC3]	Long Guiro [EXC3]	Long Guiro [EXC3]	Long Guiro [EXC3]
75	Claves	Claves	Claves	Claves
76	High Wood Block	High Wood Block	High Wood Block	High Wood Block
77	Low Wood Block	Low Wood Block	Low Wood Block	Low Wood Block
78	Mute Cuica [EXC4]	Mute Cuica [EXC4]	Mute Cuica [EXC4]	Mute Cuica [EXC4]
79	Open Cuica [EXC4]	Open Cuica [EXC4]	Open Cuica [EXC4]	Open Cuica [EXC4]
80	Mute Triangle [EXC5]	Mute Triangle [EXC5]	Mute Triangle [EXC5]	Mute Triangle [EXC5]
81	Open Triangle [EXC5]	Open Triangle [EXC5]	Open Triangle [EXC5]	Open Triangle [EXC5]
82	Shaker	Shaker	Shaker	Shaker
83	Jingle Bell	Jingle Bell	Jingle Bell	Jingle Bell
C6 84	Bell Tree	Bell Tree	Bell Tree	Bell Tree
85	Castanets	Castanets	Castanets	Castanets
86	Mute Surdo [EXC6]	Mute Surdo [EXC6]	Mute Surdo [EXC6]	Mute Surdo [EXC6]
87	Open Surdo [EXC6]	Open Surdo [EXC6]	Open Surdo [EXC6]	Open Surdo [EXC6]
88	-----	-----	-----	-----

# Drum Set List

\* -----: No sound.

\* [EXC]: will not sound simultaneously with other percussion instruments of the same number.

	TR-808 Set	DANCE Set	JAZZ GS STANDARD Set	BRUSH Set
21	-----	-----	-----	-----
22	-----	-----	-----	-----
23	-----	-----	-----	-----
24	Bar Chime	Bar Chime	Bar Chime	Bar Chime
25	Snare Roll	Snare Roll	Snare Roll	Snare Roll
26	Finger Snap	Finger Snap	Finger Snap	Finger Snap
27	High Q	High Q	High Q	High Q
28	Slap	Slap	Slap	Slap
29	Scratch Push [EXC7]	Scratch Push [EXC7]	Scratch Push [EXC7]	Scratch Push [EXC7]
30	Scratch Pull [EXC7]	Scratch Pull [EXC7]	Scratch Pull [EXC7]	Scratch Pull [EXC7]
31	Sticks	Dance Snr 1	Sticks	Sticks
32	Square Click	Square Click	Square Click	Square Click
33	Metronome Click	Metronome Click	Metronome Click	Metronome Click
34	Metronome Bell	Metronome Bell	Metronome Bell	Metronome Bell
35	Std Kick 2	Kick 1	Std Kick 2	Kick 2
C2 36	808 Bass Drum 1	808 Bass Drum 2	Std Kick 1	Kick 1
37	808 Rim Shot	808 Rim Shot	Side Stick	Side Stick
38	808 Snare Drum	TR-909 Snr	Snare Drum 1	Brush Tap
39	Hand Clap	Hand Clap	Hand Clap	Brush Slap
40	Snare Drum 2	Dance Snr 2	Snare Drum 2	Brush Swirl
41	808 Low Tom 2	808 Low Tom 2	Low Tom 2	Brush Low Tom 2
42	808 CHH [EXC1]	808 CHH [EXC1]	Closed Hi-hat 1 [EXC1]	Closed Hi-hat 2 [EXC1]
43	808 Low Tom 1	808 Low Tom 1	Low Tom 1	Brush Low Tom 1
44	808 CHH [EXC1]	808 CHH [EXC1]	Pedal Hi-hat 1 [EXC1]	Pedal Hi-hat 2 [EXC1]
45	808 Mid Tom 2	808 Mid Tom 2	Mid Tom 2	Brush Mid Tom 2
46	808 OHH [EXC1]	808 OHH [EXC1]	Open Hi-hat 1 [EXC1]	Open Hi-hat 2 [EXC1]
47	808 Mid Tom 1	808 Mid Tom 1	Mid Tom 1	Brush Mid Tom 1
C3 48	808 Hi Tom 2	808 Hi Tom 2	High Tom 2	Brush Hi Tom 2
49	808 Cymbal	808 Cymbal	Crash Cymbal 1	Crash Cymbal 1
50	808 Hi Tom 1	808 Hi Tom 1	High Tom 1	Brush Hi Tom 1
51	Ride Cymbal 1	Ride Cymbal 1	Ride Cymbal 1	Ride Cymbal 1
52	Chinese Cymbal	Chinese Cymbal	Chinese Cymbal	Chinese Cymbal
53	Ride Bell	Ride Bell	Ride Bell	Ride Bell
54	Tambourine	Tambourine	Tambourine	Tambourine
55	Splash Cymbal	Splash Cymbal	Splash Cymbal	Splash Cymbal
56	808 Cowbell	808 Cowbell	Cowbell	Cowbell
57	Crash Cymbal 2	Crash Cymbal 2	Crash Cymbal 2	Crash Cymbal 2
58	Vibra-slap	Vibra-slap	Vibra-slap	Vibra-slap
59	Ride Cymbal 2	Ride Cymbal 2	Ride Cymbal 2	Ride Cymbal 2
C4 60	High Bongo	High Bongo	High Bongo	High Bongo
61	Low Bongo	Low Bongo	Low Bongo	Low Bongo
62	808 High Conga	808 High Conga	Mute High Conga	Mute High Conga
63	808 Mid Conga	808 Mid Conga	Open High Conga	Open High Conga
64	808 Low Conga	808 Low Conga	Low Conga	Low Conga
65	High Timbale	High Timbale	High Timbale	High Timbale
66	Low Timbale	Low Timbale	Low Timbale	Low Timbale
67	High Agogo	High Agogo	High Agogo	High Agogo
68	Low Agogo	Low Agogo	Low Agogo	Low Agogo
69	Cabasa	Cabasa	Cabasa	Cabasa
70	808 Maracas	808 Maracas	Maracas	Maracas
71	Short Hi Whistle [EXC2]	Short Hi Whistle [EXC2]	Short Hi Whistle [EXC2]	Short Hi Whistle [EXC2]
C5 72	Long Low Whistle [EXC2]	Long Low Whistle [EXC2]	Long Low Whistle [EXC2]	Long Low Whistle [EXC2]
73	Short Guiro [EXC3]	Short Guiro [EXC3]	Short Guiro [EXC3]	Short Guiro [EXC3]
74	Long Guiro [EXC3]	Long Guiro [EXC3]	Long Guiro [EXC3]	Long Guiro [EXC3]
75	808 Claves	808 Claves	Claves	Claves
76	High Wood Block	High Wood Block	High Wood Block	High Wood Block
77	Low Wood Block	Low Wood Block	Low Wood Block	Low Wood Block
78	Mute Cuica [EXC4]	Mute Cuica [EXC4]	Mute Cuica [EXC4]	Mute Cuica [EXC4]
79	Open Cuica [EXC4]	Open Cuica [EXC4]	Open Cuica [EXC4]	Open Cuica [EXC4]
80	Mute Triangle [EXC5]	Mute Triangle [EXC5]	Mute Triangle [EXC5]	Mute Triangle [EXC5]
81	Open Triangle [EXC5]	Open Triangle [EXC5]	Open Triangle [EXC5]	Open Triangle [EXC5]
82	Shaker	Shaker	Shaker	Shaker
83	Jingle Bell	Jingle Bell	Jingle Bell	Jingle Bell
C6 84	Bell Tree	Bell Tree	Bell Tree	Bell Tree
85	Castanets	Castanets	Castanets	Castanets
86	Mute Surdo [EXC6]	Mute Surdo [EXC6]	Mute Surdo [EXC6]	Mute Surdo [EXC6]
87	Open Surdo [EXC6]	Open Surdo [EXC6]	Open Surdo [EXC6]	Open Surdo [EXC6]
88	-----	-----	-----	-----



\* -----: No sound.

\* [EXC]: will not sound simultaneously with other percussion instruments of the same number.

	ORCHESTRA Set	GS ROOM Set	GS BRUSH Set
21	-----	-----	-----
22	-----	-----	-----
23	-----	-----	-----
24	Bar Chime	Bar Chime	Bar Chime
25	Snare Roll	Snare Roll	Snare Roll
26	Finger Snap	Finger Snap	Finger Snap
27	Close Hi-hat [EXC1]	High Q	High Q
28	Pedal Hi-hat [EXC1]	Slap	Slap
29	Open Hi-hat [EXC1]	Scratch Push [EXC7]	Scratch Push [EXC7]
30	Ride Cymbal	Scratch Pull [EXC7]	Scratch Pull [EXC7]
31	Sticks	Sticks	Sticks
32	Square Click	Square Click	Square Click
33	Metronome Click	Metronome Click	Metronome Click
34	Metronome Bell	Metronome Bell	Metronome Bell
35	Concert BD 2	Std Kick 2	Std Kick 2
C2 36	Concert BD 1	Std Kick 1	Std Kick 1
37	Side Stick	Side Stick	Side Stick
38	Concert SD	Snare Drum 1	Brush Tap
39	Castanets	Hand Clap	Brush Slap
40	Concert SD	Snare Drum 2	Brush Swirl
41	Timpani F	Room Low Tom 2	Low Tom 2
42	Timpani F#	Closed Hi-hat 1 [EXC1]	Closed Hi-hat 1 [EXC1]
43	Timpani G	Room Low Tom 1	Low Tom 1
44	Timpani G#	Pedal Hi-hat 1 [EXC1]	Pedal Hi-hat 1 [EXC1]
45	Timpani A	Room Mid Tom 2	Mid Tom 2
46	Timpani A#	Open Hi-hat 1 [EXC1]	Open Hi-hat 1 [EXC1]
47	Timpani B	Room Mid Tom 1	Mid Tom 1
C3 48	Timpani c	Room Hi Tom 2	High Tom 2
49	Timpani c#	Crash Cymbal 1	Crash Cymbal 1
50	Timpani d	Room Hi Tom 1	High Tom 1
51	Timpani d#	Ride Cymbal 1	Ride Cymbal 1
52	Timpani e	Chinese Cymbal	Chinese Cymbal
53	Timpani f	Ride Bell	Ride Bell
54	Tambourine	Tambourine	Tambourine
55	Splash Cymbal	Splash Cymbal	Splash Cymbal
56	Cowbell	Cowbell	Cowbell
57	Concert Cymbal 2	Crash Cymbal 2	Crash Cymbal 2
58	Vibra-slap	Vibra-slap	Vibra-slap
59	Concert Cymbal 1	Ride Cymbal 2	Ride Cymbal 2
C4 60	High Bongo	High Bongo	High Bongo
61	Low Bongo	Low Bongo	Low Bongo
62	Mute High Conga	Mute High Conga	Mute High Conga
63	Open High Conga	Open High Conga	Open High Conga
64	Low Conga	Low Conga	Low Conga
65	High Timbale	High Timbale	High Timbale
66	Low Timbale	Low Timbale	Low Timbale
67	High Agogo	High Agogo	High Agogo
68	Low Agogo	Low Agogo	Low Agogo
69	Cabasa	Cabasa	Cabasa
70	Maracas	Maracas	Maracas
71	Short Hi Whistle [EXC2]	Short Hi Whistle [EXC2]	Short Hi Whistle [EXC2]
C5 72	Long Low Whistle [EXC2]	Long Low Whistle [EXC2]	Long Low Whistle [EXC2]
73	Short Guiro [EXC3]	Short Guiro [EXC3]	Short Guiro [EXC3]
74	Long Guiro [EXC3]	Long Guiro [EXC3]	Long Guiro [EXC3]
75	Claves	Claves	Claves
76	High Wood Block	High Wood Block	High Wood Block
77	Low Wood Block	Low Wood Block	Low Wood Block
78	Mute Cuica [EXC4]	Mute Cuica [EXC4]	Mute Cuica [EXC4]
79	Open Cuica [EXC4]	Open Cuica [EXC4]	Open Cuica [EXC4]
80	Mute Triangle [EXC5]	Mute Triangle [EXC5]	Mute Triangle [EXC5]
81	Open Triangle [EXC5]	Open Triangle [EXC5]	Open Triangle [EXC5]
82	Shaker	Shaker	Shaker
83	Jingle Bell	Jingle Bell	Jingle Bell
C6 84	Bell Tree	Bell Tree	Bell Tree
85	Castanets	Castanets	Castanets
86	Mute Surdo [EXC6]	Mute Surdo [EXC6]	Mute Surdo [EXC6]
87	Open Surdo [EXC6]	Open Surdo [EXC6]	Open Surdo [EXC6]
88	Applause	-----	-----

# SFX Set List

\* -----: No sound.

\* [EXC]: will not sound simultaneously with other percussion instruments of the same number.

	SFX Set 1 (KR-7)	SFX Set 1 (KR-5)	SFX Vox Set (KR-7)
21	-----	-----	-----
22	-----	-----	Uno
23	-----	-----	Dos
24	-----	-----	Tres
25	-----	-----	Quatro
26	-----	-----	One
27	-----	-----	Two
28	-----	-----	Three
29	-----	-----	Four
30	-----	-----	Female Yodel
31	-----	-----	Female Yodel
32	-----	-----	Female Yodel
33	-----	-----	Female Yodel
34	-----	-----	Female Yodel
35	-----	-----	Female Yodel
C2 36	-----	-----	Female Yodel
37	-----	-----	Female Yodel
38	-----	-----	Female Yodel
39	High Q	High Q	Female Yodel
40	Slap	Slap	Female Yodel
41	Scratch Push [EXC7]	Scratch Push [EXC7]	Female Yodel
42	Scratch Pull [EXC7]	Scratch Pull [EXC7]	Male Yodel
43	Sticks	Sticks	Male Yodel
44	Square Click	Square Click	Male Yodel
45	Metronome Click	Metronome Click	Male Yodel
46	Metronome Bell	Metronome Bell	Male Yodel
47	Guitar sliding Finger	Guitar sliding Finger	Male Yodel
C3 48	Guitar cutting noise (up)	Guitar cutting noise (up)	Male Yodel
49	Guitar cutting noise (down)	Guitar cutting noise (down)	Male Yodel
50	String slap of double bass	String slap of double bass	Male Yodel
51	Fl.Key Click	Fl.Key Click	Male Yodel
52	Laughing	Laughing	Male Yodel
53	Screaming	Screaming	Male Yodel
54	Punch	Punch	Boys Amen
55	Heart Beat	Heart Beat	Boys Amen
56	Footsteps1	Footsteps1	Boys Amen
57	Footsteps2	Footsteps2	Boys Amen
58	Applause	Applause	Boys Amen
59	Door Creaking	Door Creaking	Boys Amen
C4 60	Door	Door	Boys Amen
61	Scratch	Scratch	Boys Amen
62	Wind Chimes	Wind Chimes	Boys Amen
63	Car-Engine	Car-Engine	Boys Amen
64	Car-Stop	Car-Stop	Boys Amen
65	Car-Pass	Car-Pass	Boys Amen
66	Car-Crash	Car-Crash	Ole!
67	Siren	Siren	Ole!
68	Train	Train	Ole!
69	Jetplane	Jetplane	Ole!
70	Helicopter	Helicopter	Ole!
71	Starship	Starship	Ole!
C5 72	Gun Shot	Gun Shot	Ole!
73	Machine Gun	Machine Gun	Ole!
74	Lasergun	Lasergun	Ole!
75	Explosion	Explosion	Ole!
76	Dog	Dog	Ole!
77	Horse-Gallop	Horse-Gallop	Ole!
78	Birds	Birds	Yeah!
79	Rain	Rain	Yeah!
80	Thunder	Thunder	Yeah!
81	Wind	Wind	Yeah!
82	Seashore	Seashore	Yeah!
83	Stream	Stream	Yeah!
C6 84	Bubble	Bubble	Yeah!
85	Cat	Cat	Yeah!
86	Bird	Bird	Yeah!
87	BabyLaughing	BabyLaughing	Yeah!
88	Boeeeen	Boeeeen	Yeah!
89	Glass & Glam	Glass & Glam	Yeah!
90	Ice Ring	Ice Ring	Woo!
91	Crack Bottle	Crack Bottle	Woo!
92	Pour Bottle	Pour Bottle	Woo!
93	Car Horn	Car Horn	Woo!
94	R.Crossing	R.Crossing	Woo!
95	SL 1	SL 1	Woo!
C7 96	SL 2	SL 2	Woo!
97	Seal	Seal	Woo!
98	Fancy Animal	Fancy Animal	Woo!
99	Elephant	-----	Woo!
100	Bike	-----	Woo!
101	Car Engine 2	-----	Woo!
102	Small Club	Small Club	Ichi
103	-----	-----	Ni
104	-----	-----	San
105	-----	-----	Shi

# Effects List

Display	Description
<b>GS Chorus 1</b>	Applies a light chorus effect with slow undulations
<b>GS Chorus 2</b>	Applies a light chorus effect with quick undulations
<b>GS Chorus 3</b>	Applies a deep chorus effect with slow undulations
<b>GS Chorus 4</b>	Applies a deep chorus effect with quick undulations
<b>GS Feedback Chorus</b>	A soft sound with a flanger effect
<b>GS Flanger</b>	An effect that sounds like a jet plane's ascent/descent
<b>GS Short Delay</b>	A short echo effect
<b>GS Short Delay (Feedback)</b>	A short echo with many repetitions
<b>Stereo Chorus</b>	A stereo chorus.
<b>Hexa Chorus</b>	A multilayer chorus.
<b>Tremolo Chorus</b>	A chorus with a tremolo effect.
<b>Space D</b>	A clear chorus.
<b>Rotary</b>	Adds a rotary-speaker effect.
<b>Stereo Delay</b>	Delays the sound with a stereo effect.
<b>Modulation Delay</b>	Adds a wavering effect to the delayed sound.
<b>Triple Tap Delay</b>	A three-way delay.
<b>Quadruple Tap Delay</b>	A four-way delay.
<b>Phaser</b>	Adds undulations to the sound.
<b>Stereo Flanger</b>	Adds metallic reverberations.
<b>Step Flanger</b>	A flanger that varies the pitch in a stepwise fashion.
<b>Enhancer</b>	Adds modulation to the sound.
<b>Overdrive</b>	Applies soft distortion to the sound.
<b>Distortion</b>	Applies hard distortion to the sound.
<b>Auto Wah</b>	Changes the tone in a cyclical manner.
<b>Compressor</b>	Suppresses fluctuations in volume.
<b>Gate Reverb</b>	Cuts off the reverberations before they fade away completely.
<b>2V Pitch Shifter</b>	Adds two pitch-shifted sounds to the original sound (two-voice pitch shifter).
<b>FB Pitch Shifter</b>	The pitch will change in steps (feedback pitch shifter).
<b>Enhancer -&gt; Chorus</b>	Applies both enhancer and chorus effects.
<b>Enhancer -&gt; Flanger</b>	Applies both enhancer and flanger effects.
<b>Enhancer -&gt; Delay</b>	Applies both enhancer and delay effects.
<b>Chorus -&gt; Delay</b>	Applies both chorus and delay effects.
<b>Flanger -&gt; Delay</b>	Applies both flanger and delay effects.

Display	Description
<b>Overdrive -&gt; Chorus</b>	Applies both overdrive and chorus effects.
<b>Overdrive -&gt; Flanger</b>	Applies both overdrive and flanger effects.
<b>Overdrive -&gt; Delay</b>	Applies both overdrive and delay effects.
<b>Distortion -&gt; Chorus</b>	Applies both distortion and chorus effects.
<b>Distortion -&gt; Flanger</b>	Applies both distortion and flanger effects.
<b>Distortion -&gt; Delay</b>	Applies both distortion and delay effects.
<b>Sympathetic Resonance</b>	Applies a resonance effect when the damper pedal is depressed.
<b>* Following types are selected on the KR-7</b>	
<b>Wave Chorus</b>	Produces a chorus with strong undulations.
<b>2 Band Chorus</b>	Applies different chorus effects in the treble and bass bands.
<b>Space Chorus</b>	A chorus with extremely small undulations.
<b>Chorus -&gt; Flanger</b>	Applies both chorus and flanger effects.
<b>Rhodes Multi</b>	The optimal effect for an electric piano.
<b>Clean Guitar Multi 1</b>	Applies an effect that combines compressor, chorus, and delay.
<b>Clean Guitar Multi 2</b>	Applies an effect that combines Auto Wah, Equalizer, chorus, and delay.
<b>Tremolo</b>	Produces cyclical changes in volume.
<b>Auto Pan</b>	Makes the sonic position of the sound move to the left or right.
<b>Chorus/Delay</b>	This effect connect a chorus and a delay in parallel.
<b>Chorus/Flanger</b>	This effect connect a chorus and a flanger in parallel.
<b>Rotary Multi</b>	Applies an effect that combines rotary, Equalizer, and overdrive.
<b>Keyboard Multi</b>	Applies an effect that combines Ring Modulator, Equalizer, Pitch Shifter, Phaser, and Delay.

# Music Style List (KR-7)

## [Pop/Rock]

AmericanPop1  
 AmericanPop2  
 Easy Listen  
 Shuffle Pop  
 ShuffleFusion  
 Contemporary  
 Funky Pop  
 '70s 1  
 '70s 2  
 Cool AI  
 Asian Pop  
 Swing Pop  
 Groovin  
 Medium Pop  
 Michael'sPop  
 OrchestraPop  
 Light Pop  
 '70s 8-Beat  
 British Pop  
 '60s R&B  
 Fusion  
 West Coast  
 Rollin'  
 Light Fusion  
 Shuffle Rock  
 Power Pop  
 Power Rock  
 Hard Rock  
 Heavy Metal  
 HipHop  
 Techno

## [Ballad/Acoustic]

Scat Ballad  
 Piano Pop  
 Guitar Trio  
 6/8 Ballad  
 Slow Pop  
 Symph.Ballad  
 Piano Night  
 Guitar Pop  
 Swing Ballad  
 Pop Ballad  
 Latin Guitar  
 Soulful Sax  
 8BeatBallad1  
 8BeatBallad2  
 Soft Ballad  
 12/8 Ballad  
 Chapel  
 Crystal  
 Piano Latin  
 Piano Waltz  
 ClasicPolka  
 PianoClasic1  
 PianoClasic2  
 Guitar Bossa  
 Gtr.Fast Pop  
 Guitar Waltz  
 Harp  
 Strings  
 P.Pop 1  
 P.Classic 1  
 P.Slow Waltz  
 P.Night  
 P.Bossa Nova  
 P.Pop 2  
 P.Stride  
 P.Concerto 1  
 P.Classic 2  
 P.Ballad 1  
 P.Ballad 2  
 P.Swing Pop  
 P.Waltz  
 P.Concerto 2  
 P.Concerto 3  
 P.Swing  
 P.Boogie  
 P.Slow Swing  
 P.'50s Rock  
 P.Latin

## [Oldies/Country]

Rock'n'Roll1  
 Oldies 1  
 Rock'n'Roll2  
 Country Gtr.  
 HonkyTonkin'  
 Slow Oldies  
 Slow Dance  
 Twist  
 Oldies 2  
 CountryBalad  
 OldtimeCntry  
 D Country  
 Rock'n'Roll3  
 Surf fun  
 JB Soul  
 Blues  
 '50s R&B  
 Summer Days  
 PianoRagtime  
 Charleston  
 Bluegrass  
 Country  
 CountryWaltz  
 Train Beat  
 Country Song  
 P.Country

## [Big Band/ Swing]

LooseBigBand  
 Scat Swing 2  
 Big Serenade  
 Fast Swing  
 Jazzy Choir  
 Organ Swing  
 Dixie  
 Jazz Waltz  
 Dixieland  
 Brush Swing  
 Jazz Quintet  
 Big Band Pop  
 Big Band  
 Hula  
 Hawaiian  
 Cool Swing  
 Scat Swing 1  
 A Cappella  
 Medium Swing  
 Slow Swing  
 Piano Jazz  
 Swing'in  
 Foxtrot 1  
 Foxtrot 2  
 Boogie  
 Piano Boogie  
 PianoShuffle  
 Stride Piano

## [Gospel/Latin]

Rhumba 1  
 Salsa  
 BossaNova 3  
 Gospel  
 Soft Gospel  
 Gospel Shout  
 Mambo 1  
 Latin Festa  
 ChaCha 2  
 Anthem  
 Gospel Pop  
 P.Gospel  
 Samba 1  
 Samba 2  
 BossaNova 1  
 BossaNova 2  
 Fast Bossa  
 Slow Bossa  
 LatinTrumpet  
 Mambo 2  
 Rhumba 2  
 ChaCha 1  
 Son  
 Calypso  
 Tango  
 Plena  
 Bomba  
 Merengue  
 Slow Beguine  
 Beguine  
 Latin Pop  
 Latin

## [Trad/Kids]

Raindrops  
 Music Hall  
 Slow Waltz  
 Kids Shuffle  
 Kids  
 Kids Dance  
 Broadway  
 Stage Waltz  
 Waltzing  
 Circus  
 Little Steps  
 Parade  
 MarchingBand  
 Polka  
 March  
 Irish  
 Tejano  
 Celtic  
 Party Waltz  
 Vienna Waltz  
 Musette  
 Scotland  
 Japan  
 Ireland  
 Festival  
 Cinema  
 WesternMovie  
 Balloon Trip  
 Black&White  
 SFX Movie  
 Western  
 Screen  
 Fanfare  
 SimpleMarch1  
 SimpleMarch2  
 Simple Waltz  
 Kids 4/4  
 Kids 6/8  
 Lullaby 4/4

# Music Style List (KR-5)

## [Pop/Rock]

AmericanPop1  
Funky Pop  
Easy Listen  
Asian Pop  
ShuffleFusion  
Contemporary  
'70s 1  
'70s 2  
Cool AI  
Groovin  
Swing Pop  
British Pop  
Shuffle Pop  
Medium Pop  
Michael'sPop  
OrchestraPop  
Light Pop  
'70s 8-Beat  
'60s R&B  
Fusion  
West Coast  
Rollin'  
Power Pop  
Power Rock  
Shuffle Rock  
Hard Rock  
Techno

## [Ballad/Acoustic]

Soulful Sax  
8BeatBallad1  
Pop Ballad  
Symph.Ballad  
6/8 Ballad  
Piano Night  
Guitar Trio  
12/8 Ballad  
Chapel  
Crystal  
Piano Latin  
Piano Waltz  
PianoClasic1  
PianoClasic2  
Gtr.Fast Pop  
Guitar Pop  
Guitar Waltz  
P.Pop 1  
P.Classic 1  
P.Slow Waltz  
P.Night  
P.Bossa Nova  
P.Pop 2  
P.Stride  
P.Concerto 1  
P.Classic 2  
P.Ballad 1  
P.Ballad 2  
P.Swing Pop  
P.Waltz  
P.Concerto 2  
P.Concerto 3  
P.Swing  
P.Boogie  
P.Slow Swing  
P.'50s Rock  
P.Latin

## [Oldies/Country]

Oldies 1  
Rock'n'Roll1  
Twist  
Country Gtr.  
CountryBalad  
CountryWaltz  
Surffun  
Rock'n'Roll2  
Slow Dance  
Bluegrass  
P.Country  
Train Beat  
Slow Oldies  
JB Soul  
Blues  
'50s R&B  
Summer Days  
PianoRagtime  
Charleston  
Country

## [Big Band/ Swing]

LooseBigBand  
Scat Swing 2  
Big Serenade  
Jazz Quintet  
A Cappella  
Organ Swing  
Big Band  
Hawaiian  
Scat Swing 1  
Cool Swing  
Brush Swing  
Jazz Waltz  
Fast Swing  
Medium Swing  
Slow Swing  
Dixieland  
Big Band Pop  
Foxtrot 1  
Piano Boogie  
PianoShuffle  
Stride Piano

## [Gospel/Latin]

Merengue  
Rhumba 1  
Slow Bossa  
Gospel  
Gospel Shout  
P.Gospel  
Son  
Rhumba 2  
Latin  
Anthem  
Gospel Pop  
Slow Beguine  
Mambo 1  
Mambo 2  
Samba 1  
BossaNova 1  
BossaNova 2  
Fast Bossa  
Latin Festa  
LatinTrumpet  
Latin Pop  
Salsa  
ChaCha 1  
Calypso  
Tango  
Bomba  
Beguine

## [Trad/Kids]

Raindrops  
Broadway  
Slow Waltz  
Kids Shuffle  
Kids  
Kids Dance  
Waltzing  
Balloon Trip  
Festival  
Circus  
Little Steps  
Lullaby 4/4  
MarchingBand  
March  
Vienna Waltz  
Tejano  
Celtic  
Scotland  
Cinema  
WesternMovie  
Black&White  
Ireland  
Kids 4/4  
Kids 6/8  
Western  
SFX Movie  
Screen  
Musette  
Japan  
Fanfare  
SimpleMarch1  
SimpleMarch2  
Simple Waltz

# Chord List

\* ● symbol : Indicates the constituent note of chords.

\* ★ symbol : Chord shown with an "★" can be played by pressing just the key marked with the "★" (p. 52).

C	C#	D	E $\flat$	E	F
Cmaj7	C#maj7	Dmaj7	E $\flat$ maj7	Emaj7	Fmaj7
C7	C#7	D7	E $\flat$ 7	E7	F7
Cm	C#m	Dm	E $\flat$ m	Em	Fm
Cm7	C#m7	Dm7	E $\flat$ m7	Em7	Fm7
Cdim	C#dim	Ddim	E $\flat$ dim	Edim	Fdim
Cm7 (b5)	C#m7 (b5)	Dm7 (b5)	E $\flat$ m7 (b5)	Em7 (b5)	Fm7 (b5)
Caug	C#aug	Daug	E $\flat$ aug	Eaug	Faug
Csus4	C#sus4	Dsus4	E $\flat$ sus4	Esus4	Fsus4
C7sus4	C#7sus4	D7sus4	E $\flat$ 7sus4	E7sus4	F7sus4
C6	C#6	D6	E $\flat$ 6	E6	F6
Cm6	C#m6	Dm6	E $\flat$ m6	Em6	Fm6

\* ● symbol : Indicates the constituent note of chords.

\* ★ symbol : Chord shown with an "★" can be played by pressing just the key marked with the "★" (p. 52).

F#	G	A $\flat$	A	B $\flat$	B
F#maj7	Gmaj7	A $\flat$ maj7	A maj7	B $\flat$ maj7	Bmaj7
F#7	G7	A $\flat$ 7	A7	B $\flat$ 7	B7
F#m	Gm	A $\flat$ m	Am	B $\flat$ m	Bm
F#m7	Gm7	A $\flat$ m7	Am7	B $\flat$ m7	Bm7
F#dim	Gdim	A $\flat$ dim	Adim	B $\flat$ dim	Bdim
F#m7 (b5)	Gm7 (b5)	A $\flat$ m7 (b5)	Am7 (b5)	B $\flat$ m7 (b5)	Bm7 (b5)
F#aug	Gaug	A $\flat$ aug	Aaug	B $\flat$ aug	Baug
F#sus4	Gsus4	A $\flat$ sus4	Asus4	B $\flat$ sus4	Bsus4
F#7sus4	G7sus4	A $\flat$ 7sus4	A7sus4	B $\flat$ 7sus4	B7sus4
F#6	G6	A $\flat$ 6	A6	B $\flat$ 6	B6
F#m6	Gm6	A $\flat$ m6	Am6	B $\flat$ m6	Bm6

# Internal Song List

Folks	
Annie Laurie	© 1993 Roland Corporation
Londonderry Air	© 1993 Roland Corporation
AmazingGrace	© 1993 Roland Corporation
Ave Maria	© 1993 Roland Corporation
Clock	© 1998 Roland Corporation
Entertainer	© 1994 Roland Corporation
Greensleeves	© 1993 Roland Corporation
Hallelujah!	© 1993 Roland Corporation
Jingle Bells	© 1998 Roland Corporation
Les patineurs, Valse	© 1998 Roland Corporation
Little Brown Jug	© 1998 Roland Corporation
Marchin' In	© 1992 Roland Corporation
Silent Night, Holy Night	© 1998 Roland Corporation
Stagecoach	© 1994 Roland Corporation

EZ Classical	
Air sul G	© 1993 Roland Corporation
Fantasia-impromptu op.66	© 2001 Roland Corporation
Grande valse brillante	© 1995 Roland Corporation
Gymnopedie 1	© 1997 Roland Corporation
Liebestraume 3	© 2001 Roland Corporation
Mondschein	© 1994 Roland Corporation
Nocturne 9-2	© 1996 Roland Corporation
Petit chien	© 2001 Roland Corporation
Prelude28-15	© 1996 Roland Corporation
Traumerei	© 1996 Roland Corporation
TurkishMarch	© 1996 Roland Corporation
Ungarische Tanze V	© 1996 Roland Corporation

Jazzy	
Secret Agent	© 1992 Roland Corporation
Late Night Chopin	© 2002 Roland Corporation
Fly Free	© 1998 Roland Corporation
Sun Daze	© 1992 Roland Corporation
Keepers Tale	© 1992 Roland Corporation
CountOnBlues	© 1992 Roland Corporation
OneDown&Easy	© 1994 Roland Corporation
A PreludeTo:	© 1996 Roland Corporation
BachsBoppin'	© 1996 Roland Corporation
HungarianRag	© 1996 Roland Corporation
KismetsSalsa	© 1996 Roland Corporation
Matthew	© 1998 Roland Corporation
RollOverLudwig	© 1996 Roland Corporation

Kids	
Frog Song	© 1999 Roland Corporation
HoneybeeMarch	© 1999 Roland Corporation
Jingle Bell	© 1999 Roland Corporation
Little Fox	© 1999 Roland Corporation
Little Row	© 2001 Roland Corporation
LondonBridge	© 1999 Roland Corporation
Mary Lamb	© 1999 Roland Corporation
OldMacDonald	© 1999 Roland Corporation
The Cuckoo	© 1999 Roland Corporation
Twinkle	© 1999 Roland Corporation



Practice	
Beyer 15	© 1996 Roland Corporation
Beyer 21	© 1996 Roland Corporation
Beyer 25	© 1996 Roland Corporation
Beyer 29	© 1996 Roland Corporation
Beyer 34	© 1996 Roland Corporation
Beyer 38	© 1996 Roland Corporation
Beyer 42	© 1996 Roland Corporation
Beyer 46	© 1996 Roland Corporation
Beyer 51	© 1996 Roland Corporation
Beyer 55	© 1996 Roland Corporation
Beyer 60	© 1996 Roland Corporation
Beyer 64	© 1996 Roland Corporation
Beyer 67	© 1996 Roland Corporation
Beyer 73	© 1996 Roland Corporation
Beyer 78	© 1996 Roland Corporation
Beyer 81	© 1996 Roland Corporation
Beyer 90	© 1996 Roland Corporation
Beyer 93	© 1996 Roland Corporation
Beyer 98	© 1996 Roland Corporation
Beyer 103	© 1996 Roland Corporation
Czerny100- 1	© 1995 Roland Corporation
Czerny100-10	© 1995 Roland Corporation
Czerny100-20	© 1995 Roland Corporation
Czerny100-30	© 1995 Roland Corporation
Czerny100-38	© 1995 Roland Corporation
Czerny100-43	© 1995 Roland Corporation
Czerny100-60	© 1995 Roland Corporation
Czerny100-75	© 1995 Roland Corporation
Czerny100-86	© 1995 Roland Corporation
Czerny100-96	© 1995 Roland Corporation
Openness	© 1999 Roland Corporation
Arabesque	© 1999 Roland Corporation
Pastoral	© 1999 Roland Corporation
SmallGathering	© 1999 Roland Corporation
Innocence	© 1999 Roland Corporation
Progress	© 1999 Roland Corporation
Clear Stream	© 1999 Roland Corporation
Gracefulness	© 1999 Roland Corporation

Practice	
The Hunt	© 1999 Roland Corporation
TenderFlower	© 1999 Roland Corporation
Shepherdess	© 1999 Roland Corporation
Farewell	© 1999 Roland Corporation
Consolation	© 1999 Roland Corporation
AustrianDance	© 1999 Roland Corporation
Ballad	© 1999 Roland Corporation
Sighing	© 1999 Roland Corporation
Chatterbox	© 1999 Roland Corporation
Restlessness	© 1999 Roland Corporation
Ave Maria	© 1999 Roland Corporation
Tarantella	© 1999 Roland Corporation
AngelHarmony	© 1999 Roland Corporation
Gondola Song	© 1999 Roland Corporation
The Return	© 1999 Roland Corporation
The Swallow	© 1999 Roland Corporation
KnightErrant	© 1999 Roland Corporation
Invention 1	© 2000 Roland Corporation
Invention 2	© 2000 Roland Corporation
Invention 3	© 2000 Roland Corporation
Invention 4	© 2000 Roland Corporation
Invention 5	© 2000 Roland Corporation
Invention 6	© 2000 Roland Corporation
Invention 7	© 2000 Roland Corporation
Invention 8	© 2000 Roland Corporation
Invention 9	© 2000 Roland Corporation
Invention 10	© 2000 Roland Corporation
Invention 11	© 2000 Roland Corporation
Invention 12	© 2000 Roland Corporation
Invention 13	© 2000 Roland Corporation
Invention 14	© 2000 Roland Corporation
Invention 15	© 2000 Roland Corporation

## Internal Song List

Masterpieces	
→ Song files of this genre corresponds to the included collection of printed music entitled "Roland 60 Classical Piano Masterpieces."	
Sonate No.15	© 1996 Roland Corporation
Liebestraume 3	© 2001 Roland Corporation
Etude op10-3	© 2001 Roland Corporation
Je te veux	© 1997 Roland Corporation
Valse op64-1	© 2001 Roland Corporation
Golliwog'sCakewalk	© 1995 Roland Corporation
FantaisieImpromptu	© 2001 Roland Corporation
Arabesque 1	© 1995 Roland Corporation
Blauen Donau	© 1996 Roland Corporation
Auf Flugeln des Gesanges	© 1996 Roland Corporation
Mazurka No.5	© 1995 Roland Corporation
Gymnopedie 1	© 1997 Roland Corporation
Etude op25-1	© 1995 Roland Corporation
ClairDeLune	© 1998 Roland Corporation
Etude op10-5	© 2001 Roland Corporation
Dr.GradusAdParnassum	© 1995 Roland Corporation
Grande Valse Brillante	© 1995 Roland Corporation
La priere d'une Vierge	© 1996 Roland Corporation
Course en Troika	© 1996 Roland Corporation
ToTheSpring	© 1996 Roland Corporation
Valse op64-2	© 1996 Roland Corporation
RadetzkyMarsch	© 1996 Roland Corporation
Traumerei	© 1996 Roland Corporation
MomentsMusicaux 3	© 1996 Roland Corporation
Prelude op28-15	© 1996 Roland Corporation
HarmoniousBlacksmith	© 1996 Roland Corporation
Ungarische Tanze 5	© 1996 Roland Corporation
Turkischer Marsch (Beethoven)	© 1996 Roland Corporation
NocturneNo.2	© 1996 Roland Corporation
Fruhlingslied	© 1996 Roland Corporation
Praludium	© 1996 Roland Corporation
Jagerlied	© 1996 Roland Corporation
MenuetAntique	© 1996 Roland Corporation
Fur Elise	© 1996 Roland Corporation
Turkischer Marsch (Mozart)	© 1996 Roland Corporation

Masterpieces	
Standchen	© 1996 Roland Corporation
Humoreske	© 1996 Roland Corporation
Blumenlied	© 1996 Roland Corporation
Alpenglockchen	© 1996 Roland Corporation
Menuett Gdur (Beethoven)	© 1996 Roland Corporation
Venezianisches Gondellied	© 1996 Roland Corporation
Alpenabendrote	© 1996 Roland Corporation
Farewell to the Piano	© 1996 Roland Corporation
Brautchor	© 1996 Roland Corporation
Waterloo	© 1996 Roland Corporation
WienerMarsch	© 1996 Roland Corporation
Le Coucou	© 1996 Roland Corporation
Menuett Gdur (Bach)	© 1992 Roland Corporation
Spinnerlied	© 1996 Roland Corporation
Gavotte	© 1996 Roland Corporation
Heidenroslein	© 1996 Roland Corporation
ZigeunerTanz	© 1996 Roland Corporation
Cinquantaine	© 1996 Roland Corporation
Csikos Post	© 1996 Roland Corporation
Dolly'sDreaming Awakening	© 1996 Roland Corporation
La Violette	© 1996 Roland Corporation
Frohlicher Landmann	© 1996 Roland Corporation
Sonatine36-1 (Clementi)	© 1996 Roland Corporation
Sonatine20-1 (Kuhlau)	© 1996 Roland Corporation
SonatineNo.5 (Beethoven)	© 1996 Roland Corporation

\* All rights reserved. Unauthorized use of this material for purposes other than private, personal enjoyment is a violation of applicable laws.

# Rhythm Pattern List

## Patterns That Can Be Selected with the [Rhythm] Button

→ "Playing Rhythm" (p. 48)

Beat	Pattern Name
2/2	March
	Swing
0/4	Stick
2/4	March
	Country
	Samba
3/4	Waltz 1
	Waltz 2
	Waltz 3
	Country Waltz
	Gospel
	Jazz Waltz
	3/4 Simple
	4/4
8-Beat 2	
8-Beat 3	
16-Beat 1	
16-Beat 2	
16-Beat 3	
Rock 1	
Rock 2	
Swing 1	
Swing 2	
Shuffle 1	
Shuffle 2	
Brush	
Triplet	
March 1	
March 2	
Tango 1	
Tango 2	
Mambo 1	
Mambo 2	
House 1	
House 2	
House 3	
Bossa Nova	
Samba 1	
Samba 2	
Rhumba	
Beguine	
8-Beat 4	
8-Beat 5	

Beat	Pattern Name
4/4	8-Beat 6
	16-Beat 4
	16-Beat 5
	Rock 3
	Rock 4
	4/4 Simple
5/4	5/4
6/4	6/4
7/4	7/4
3/8	3/8
6/8	Ballad
	March
	Swing
	6/8 Simple
9/8	9/8
12/8	12/8

## Patterns That Can Be Selected with the Edit Functions

→ "Copying Rhythm Patterns to Create Rhythm Parts" (p. 127)

Pattern Name (Beat)	Measures
March (2/2)	2
Swing (2/2)	8
Stick (0/4)	1
March (2/4)	2
Country(2/4)	8
Samba (2/4)	4
Waltz 1(3/4)	4
Waltz 2(3/4)	4
Waltz 3(3/4)	1
CntryWltz (3/4)	2
Gospel (3/4)	4
JazzWaltz (3/4)	4
3/4 Simple (3/4)	1
8-Beat1 (4/4)	2
8-Beat2(4/4)	2
8-Beat3(4/4)	4
16-Beat1(4/4)	2
16-Beat2(4/4)	2
16-Beat3(4/4)	4
Rock 1 (4/4)	2
Rock 2 (4/4)	2
Swing 1(4/4)	4
Swing 2(4/4)	1
Shuffle1(4/4)	2

Pattern Name (Beat)	Measures
Shuffle2(4/4)	1
Brush (4/4)	2
Triplet(4/4)	2
March 1(4/4)	1
March 2(4/4)	2
Tango 1(4/4)	2
Tango 2(4/4)	2
Mambo 1(4/4)	2
Mambo 2(4/4)	2
House 1(4/4)	2
House 2(4/4)	2
House 3(4/4)	1
BossaNova(4/4)	2
Samba 1(4/4)	1
Samba 2(4/4)	1
Rhumba (4/4)	2
Beguine(4/4)	1
8-Beat4(4/4)	1
8-Beat5(4/4)	2
8-Beat6(4/4)	1
16-Beat4(4/4)	1
16-Beat5(4/4)	2
Rock 3 (4/4)	2
Rock 4 (4/4)	2
4/4Simple(4/4)	1
5/4 (5/4)	2
6/4 (6/4)	2
7/4 (7/4)	2
3/8 (3/8)	4
Ballad (6/8)	4
March (6/8)	4
Swing (6/8)	4
6/8Simple(6/8)	2
9/8 (9/8)	2
12/8 (12/8)	2
CountIn1(4/4)	2
CountIn2(3/4)	2
C.InSwing(4/4)	1
Fill In1(4/4)	1
Fill In2(4/4)	1
Fill In3(4/4)	1
Ending 1(4/4)	1
Ending 2(4/4)	1
Ending 3(4/4)	1

# Parameters Stored to Internal Memory

## Parameters Stored in the User Program

→ "Saving Performance Settings (User Program)" (p. 112)

Parameters that switch immediately after the User Program name is touched when <Option> on the User Program screen is set to "Delayed"	
<b>Organ</b>	Rotary effect (Slow/Fast), Footage (Upper, Lower), Percussion
<b>Selected Right-hand Tone, Layer Tone, Left-hand Tone</b>	Tone, Octave Shift, Effect (Type, Depth, On/Off)
<b>Bass Tone, Chord Tone</b>	
<b>Part Balance</b>	Keyboard Parts
<b>Melody Intelligent</b>	On/Off, Type
<b>Keyboard Mode</b>	Split On/Off, Layer On/Off, Lower On/Off, Keyboard Transpose, Split Point
<b>Pedal Settings</b>	Functions assigning to the left pedal and center pedal
<b>Performance Pad Settings</b>	Style Orchestrator/User Function (KR-5), User Function, Phrase (KR-7), Style Orchestrator values assigning the Pads (KR-5)
<b>Keyboard settings</b> (One-Touch Piano/ One-Touch Arranger/Others)	
<b>Reverb</b>	On/Off, Type, Depth
<b>Vocal Effects (KR-7)</b>	On/Off, Echo (Type, Depth), Transformer Type, Harmonist Type, Transformer/Harmonist, Music Files Part
<b>Bend Range</b>	
<b>MIDI Settings for User Program</b>	PC Number, Bank Select LSB, Bank Select MSB, Program Change
<b>Equalizer (KR-7)</b>	On/Off, Each Sliders level, Master Level
Parameters that switch after the User Program name is touched for a few moments when <Option> on the User Program screen is set to "Delayed"	
<b>Music Style</b>	
<b>Tempo</b>	
<b>Part Balance</b>	Accompaniment Part
<b>Arranger Settings</b>	Accompaniment On/Off, Chord Intelligence On/Off, Leading Bass On/Off, Original/Variation, Sync Start On/Off, <Accomp> setting for Arranger Configuration, Style Orchestrator, Division

## Parameters Stored in Memory Backup

→ "Remembering the Settings Even When the Power is Turned Off (Memory Backup)" (p. 155)

<b>Tone Parameters</b>	Octave Shift Effects: On/Off, Type, Depth
<b>System Parameters</b>	One-Touch Piano Settings: Lid, Tuning (Tuning, Key, Stretch Tunings), Resonance (Type (KR-7), Depth), Key Touch, String Resonance (On/Off, Depth) (KR-7), Hamper Response (On/Off, Depth) (KR-7)
	Metronome: Sound
	Count-In: Measures, Sound
	Countdown: Sound
	Language
	Opening Message
	Touch Screen
	Track Assign
	Reverb: On/Off, Type, Depth

# Music Files That the KR-7/5 Can Use

## What Are Music Files?

Music Files contain information describing the details of a musical performance, such as “the C3 key on a keyboard was pressed for this amount of time, using this amount of force.” By inserting the floppy disk into the disk drive on the KR-7/5, the performance information is sent from the floppy disk to the piano, and played faithfully by the piano. This is different than a CD, since the music file does not contain a recording of the sound itself. This makes it possible to erase certain parts, or to change instruments, tempos and keys freely, allowing you to use it in many different ways.

## Regarding Copyright

Use of the song data supplied with the Data Disk attached to this product for any purpose other than private, personal enjoyment without the permission of the copyright holder is prohibited by law. Additionally, this data must not be copied, nor used in a secondary copyrighted work without the permission of the copyright holder.

## ■ The KR-7/5 allows you to use the following music files

- Floppy disks saved on a Roland MT Series, or Roland Piano Digital HP-G/R and KR Series instrument
  - Roland Digital Piano Compatible Music Files  
Roland’s original music file is made specifically for practicing the piano. Some follow an instructional curriculum, allowing for a complete range of lessons, such as “practicing each hand separately” or “listening to only the accompaniment.”
  - SMF Music Files (720KB/1.44MB format)  
SMFs (Standard MIDI Files) use a standard format for music file that was formulated so that files containing music file could be widely compatible, regardless of the manufacturer of the listening device. An enormous variety of music is available, whether it be for listening, for practicing musical instruments, for Karaoke, etc.
- \* If you wish to purchase SMF Music Files, please consult the retailer where you purchased your KR-7/5.

## SMF with Lyrics

“SMF with Lyrics” refers to SMF (Standard MIDI File) that contains the lyrics. When Music Files carrying the “SMF with Lyrics” logo are played back on a compatible device (one bearing the same logo), the lyrics will appear in its display.

## ■ About the KR-7/5 Sound Generator

The KR-7/5 come equipped with GM 2/GS sound generators.

### General MIDI

The General MIDI is a set of recommendations which seeks to provide a way to go beyond the limitations of proprietary designs, and standardize the MIDI capabilities of sound generating devices. Sound generating devices and music files that meets the General MIDI standard bears the General MIDI logo. Music files bearing the General MIDI logo can be played back using any General MIDI sound generating unit to produce essentially the same musical performance.

### General MIDI 2

The upwardly compatible General MIDI 2 recommendations pick up where the original General MIDI left off, offering enhanced expressive capabilities, and even greater compatibility. Issues that were not covered by the original General MIDI recommendations, such as how sounds are to be edited, and how effects should be handled, have now been precisely defined. Moreover, the available sounds have been expanded. General MIDI 2 compliant sound generators are capable of reliably playing back music files that carry either the General MIDI or General MIDI 2 logo.

In some cases, the conventional form of General MIDI, which does not include the new enhancements, is referred to as “General MIDI 1” as a way of distinguishing it from General MIDI 2.

### GS Format

The GS Format is Roland’s set of specifications for standardizing the performance of sound generating devices. In addition to including support for everything defined by the General MIDI, the highly compatible GS Format additionally offers an expanded number of sounds, provides for the editing of sounds, and spells out many details for a wide range of extra features, including effects such as reverb and chorus. Designed with the future in mind, the GS Format can readily include new sounds and support new hardware features when they arrive. Since it is upwardly compatible with the General MIDI, Roland’s GS Format is capable of reliably playing back GM Scores equally as well as it performs GS music files (music files that have been created with the GS Format in mind). This product supports both the General MIDI 2 and the GS Format, and can be used to play back music data carrying either of these logos.

### XG lite

XG is a tone generator format of YAMAHA Corporation, that defines the ways in which voices are expanded or edited and the structure and type of effects, in addition to the General MIDI 1 specification. XGlite is a simplified version of XG tone generation format. You can play back any XG music files using an XGlite tone generator. However, keep in mind that some music files may play back differently compared to the original files, due to the reduced set of control parameters and effects.

# MIDI Implementation Chart

Function...		Transmitted	Recognized	Remarks	
Basic Channel	Default Changed	1 1-16	1-16 1-16		
Mode	Default Messages Altered	Mode 3 x *****	Mode 3 Mode 3, 4 (M=1)	* 2	
Note Number :	True Voice	15-113 *****	0-127 0-127		
Velocity	Note ON Note OFF	O x 8n v=64	O x		
After Touch	Key's Ch's	x x	O O	*1 *1	
Pitch Bend		O	O		
Control Change	0, 32	O	O	*1	Bank select Modulation Portamento time Data entry Volume Panpot Expression Hold 1 Portamento Sostenuto Soft Portamento control Effect1 depth Effect3 depth NRPN LSB, MSB RPN LSB, MSB
	1	O	O	*1	
	5	O	O	*1	
	6, 38	O	O	*1	
	7	O	O	*1	
	10	O	O	*1	
	11	O	O	*1	
	64	O	O	*1	
	65	O	O	*1	
	66	O	O	*1	
	67	O	O	*1	
	84	O	O	*1	
	91	O	O (Reverb)	*1	
93	O	O (Chorus)	*1		
98, 99	O	O	*1		
100, 101	O	O	*1		
Prog Change	: True #	0-127 *****	O 0-127	Program number 1-128	
System Exclusive		O	O		
System Common	: Song Pos : Song Sel : Tune	x x x	x x x		
System Real Time	: Clock : Commands	O x	x x		
Aux Message	: All sound off : Reset all controllers : Local Control : All Notes OFF : Active Sense : Reset	x x x x O x	O (120, 126, 127) O O O (123-125) O x		
Notes	* 1 O x is selectable by SysEx. * 2 Recognized as M=1 even if M≠1.				

Mode 1 : OMNI ON, POLY

Mode 2 : OMNI ON, MONO

O : Yes

Mode 3 : OMNI OFF, POLY

Mode 4 : OMNI OFF, MONO

X : No

# Main Specifications

	KR-7	KR-5
<b>&lt;Keyboard&gt;</b>		
Keyboard	88 keys (Progressive hammer action keyboard with escapement)	88 keys (Progressive hammer action keyboard)
Touch Sensitivity	100 levels	
Keyboard Mode	Whole, Split (adjustable split point), Layer, Arranger, Piano Style Arranger, Manual Drums / SFX	
<b>&lt;Sound Source&gt; Conforms to GM2 / GS / XG Lite</b>		
Max. Polyphony	128 voices	64 voices
Tones (Tone Search by terms and by letters)	6 groups 683 variations (including 16 drum sets, 2 SFX sets)	6 groups 646 variations (including 15 drum sets, 1 SFX set)
Temperament	8 types, selectable tonic	
Stretched Tuning	2 types	
Master Tuning	415.3 Hz–466.2 Hz (adjustable in increments of 0.1 Hz)	
Transpose	Key Transpose (-6–+5 in units of semitone), Playback Transpose (-24–+24 in units of semitone)	
Effects	Reverb (16 types, 127 levels), Chorus (8 types, 127 levels), Sympathetic Resonance, Rotary and 45 other types, Advanced 3D, Physical Damper Simulation (Advanced Resonance)	Reverb (8 types, 127 levels), Chorus (8 types, 127 levels), Sympathetic Resonance, Rotary and 32 other types
Equalizer	5 bands, Master level	-
<b>&lt;Arranger&gt;</b>		
Music Styles (Style Search by terms and by letters)	6 groups 204 styles x 4 types (Style Orchestrator)	6 groups 165 styles x 4 types (Style Orchestrator)
Music Assistant (Search by terms and by letters)	Over 130 sets x 4 presets	Over 100 sets x 4 presets
Programmable Music Styles	Style Converter, Style Composer	Style Converter
Melody Intelligence	24 types	
Control	Start/Stop, Intro/Ending (2 types for each styles), Sync. Start, Fill In (Variation, Original), Arranger Reset, Countdown, Count-In, Melody Intelligence, Break, Leading Bass, No Chord, Fade in/out, Half Fill In (Variation, Original), Chord Intelligence, Style Orchestrator	
<b>&lt;User Programs&gt;</b>		
Internal	36	
Disk	Max. 99 sets	
<b>&lt;Rhythm Partner&gt; Metronome, Rhythm</b>		
Tempo	Quarter note = 20–250	
Beat	2/2, 0/4, 2/4, 3/4, 4/4, 5/4, 6/4, 7/4, 3/8, 6/8, 9/8, 12/8	
Volume	10 levels	
Metronome Pattern	11 patterns	
Metronome Sound	8 types	
Rhythm Pattern	59 patterns	
<b>&lt;Composer&gt;</b>		
Tracks	5 tracks / 16 tracks	
Song	1 song	
Note Storage	Approx. 30,000 notes	
Resolution	120 ticks per quarter note	
Recording Method	Realtime (Replace, Mix, Auto Punch In, Manual Punch In, Loop, Tempo), Step (Chord Sequencer), Beat Map	
Edit	Copy, Quantize, Delete, Insert, Erase, Transpose, Part Exchange, Note Edit, PC Edit	

## Main Specifications

	KR-7	KR-5
<b>Control</b>	Song Select, Reset, Play/Stop, Rec, Bwd, Fwd, All Song Play, Random Play, Track Select, Count-in, Countdown, Playback Balance, Marker Set, Repeat, Tempo Mute	
<b>Other Functions</b>	Touch the Notes, Replay, Select Various Tones, Song Stylist, Session Partner, Wonderland/Game, Quick Tour, Audition, Panel Lock	Touch the Notes, Replay, Select Various Tones, Wonderland/Game, Quick Tour, Audition, Panel Lock
<b>&lt;Disk Drive / Disk Storage&gt; 3.5 inch Micro Floppy Disk</b>		
<b>Disk Format</b>	720K bytes (2DD), 1.44M bytes (2HD)	
<b>Files</b>	Max. 99 songs, Max. 99 User Styles, Max. 99 User Program Sets	
<b>Note Storage</b>	Approx. 120,000 notes (2DD), Approx. 240,000 notes (2HD)	
<b>Playable Software</b>	Song: Standard MIDI Files (Format 0/1), Roland Original Format (i-Format) Music Style: MSA, MSD, MSE	
<b>Save</b>	Song: Standard MIDI Files (Format 0), Roland Original Format (i-Format), Music Style: MSE	
<b>&lt;Internal Memory&gt;</b>		
<b>Internal Songs (Song Search by terms and by letters)</b>	Over 170 songs	
<b>User Memory</b>	Max. 200 songs on Favorites, Max. 99 User Styles, Max. 99 User Program sets	Max. 200 songs on Favorites
<b>&lt;Others&gt;</b>		
<b>Rated Power Output</b>	40 W x 2	30 W x 2
<b>Speakers</b>	16 cm x 2,5 cm x 2	16 cm x 2
<b>Display</b>	Bouncing Beat Indicator, Graphical LCD 320 x 240 dot (backlit LCD)	
<b>Score</b>	Grand staff / G Clef staff / F Clef staff, with note name / lyrics / chords / fingering	
<b>Language</b>	English / Japanese / Germany / French / Spanish	
<b>Lyrics</b>	Yes (built-in, external display, MIDI output)	Yes (built-in, MIDI output)
<b>Control</b>	Volume, Brilliance, Volume Balance, Contrast, Mic Volume	Volume, Brilliance, Volume Balance, Contrast, Mic Volume, Mic Echo
<b>One Touch Program</b>	One Touch Piano, One Touch Arranger	
<b>Pedals</b>	Damper Pedal (half-pedal recognition), Soft Pedal (half-pedal recognition, 36 functions assignable), Sostenuto Pedal (36 functions assignable)	Damper Pedal (half-pedal recognition), Soft Pedal (half-pedal recognition, 34 functions assignable), Sostenuto Pedal (34 functions assignable)
<b>Vocal Effects</b>	Echo, Voice Transformer, Vocal Keyboard, Harmonist	-
<b>Connectors</b>	Output jacks (L/Mono, R), Input jacks (L/Mono, R), Mic Input jack, Headphones jack (Stereo) x 2, MIDI In connector x 2, MIDI Out connector, Computer connector, Pedal connector (8-pin DIN type), Speaker connector, Ext Display connector (15-pin D-Sub type)	Output jacks (L/Mono, R), Input jacks (L/Mono, R), Mic Input jack, Headphones jack (Stereo) x 2, MIDI In connector x 2, MIDI Out connector, Computer connector, Pedal connector (8-pin DIN type)
<b>Power Supply</b>	AC 117 V / AC 230 V / AC 240 V	
<b>Power Consumption</b>	105 W	80 W
<b>Dimensions (including the piano stand)</b>	1,445 (W) x 548 (D) x 902 (H) mm 56-15/16 (W) x 21-5/8 (D) x 35-9/16 (H) inches	1,445 (W) x 548 (D) x 902 (H) mm 56-15/16 (W) x 21-5/8 (D) x 35-9/16 (H) inches
<b>Including the music stand</b>	1,445 (W) x 548 (D) x 1,116 (H) mm 56-15/16 (W) x 21-5/8 (D) x 43-15/16 (H) inches	1,445 (W) x 548 (D) x 1,107 (H) mm 56-15/16 (W) x 21-5/8 (D) x 43-5/8 (H) inches
<b>Weights (including the piano stand)</b>	78 kg / 172 lbs	70 kg / 155 lbs
<b>Accessories</b>	Quick Start, Owner's Manual, Roland 60 Classical Piano Masterpieces, AC cord	

\* In the interest of product improvement, the specifications and/or appearance of this unit are subject to change without prior notice.



# Index

## Numerics

16-Track Sequencer ..... 117

## A

AC inlet ..... 18

Accompaniment

    Start and Stop ..... 58

    Sync Start ..... 58

Adjuster ..... 20

Advanced 3D ..... 32

[Advanced 3D] button ..... 32

Arranger Config ..... 150

As SMF ..... 108

Audio Equipment ..... 162

Auto Punch-In/Out ..... 123

Automatic Accompaniment ..... 50

## B

Balance ..... 67

Balance Knob ..... 67

Bank Select LSB ..... 161

Bank Select MSB ..... 161

Basic Screen ..... 23

Basic tempo ..... 132

Bass Tone ..... 59, 150

Beat

    Metronome ..... 45

    Rhythm ..... 48

Beat Indicator ..... 155

Beat Map ..... 131

Bend Range ..... 149

Blank Recording ..... 122

[Brilliance] knob ..... 20

[Bwd] button ..... 70

## C

Calibration ..... 156

Chord Finder ..... 53

Chord Intelligence ..... 52

Chord List ..... 182

Chord Sequencer ..... 124

Chord Tone ..... 59, 150

Chord type ..... 52

Chords ..... 52, 76

Clef L ..... 76

Clef R ..... 76

Compatibility ..... 108

Composer MIDI Out ..... 161

Computer ..... 163

Computer Connector ..... 163

Computer Switch ..... 163

Connecting

    Audio Equipment ..... 162

    Computer ..... 163

    MIDI device ..... 158

Contrast ..... 22

Contrast knob ..... 22

Copy (Song Edit) ..... 126

Copying

    Songs ..... 110

    User Program ..... 115

    User Styles ..... 141

Count In ..... 85

Countdown ..... 60

    Settings ..... 151

Count-In

    Settings ..... 151

## D

Damper pedal ..... 20

Delete (Song Edit) ..... 128

Deleting

    A song ..... 109

    User Style ..... 140

Disk Drive ..... 104

Divisions ..... 50

Drum Set List ..... 174

DRUMS ..... **QS 5**

Drums ..... **QS 14, 26**

## E

Echo ..... 21, 38

Editing ..... 125

Effects ..... 36

Effects List ..... 179

Eject button ..... 104

Ending ..... 50, 59

Equalizer ..... 34

[Equalizer] button ..... 34

Erase (Song Edit) ..... 129

Erasing

    Performance on specific tracks ..... 102

    Recorded performance ..... 102

Error Messages ..... 169

Export ..... 77

Ext Display connector ..... 21

External Display ..... 21, 153

# Index

---

<b>F</b>	
Factory Reset .....	155
Factory Setting	
Favorites .....	156
Touch Screen .....	156
User Memory .....	156
Favorites .....	72, 106
Clearing .....	156
Registering .....	72
Removing .....	73
Fill In .....	61
Fill In To Original .....	50
Fill In To Variation .....	50
Finger Numbers .....	76
Footage .....	<b>QS</b> 15
Floppy Disk .....	104
Format	
Floppy disk .....	104
Functions .....	142, 145
[Fwd] button .....	70
<b>G</b>	
GAME .....	<b>QS</b> 5
General MIDI .....	189
General MIDI 2 .....	189
GS .....	189
GS Format .....	189
<b>H</b>	
Hammer Response .....	144
Harmonist .....	40
Harmony .....	64
Headphones .....	20
<b>I</b>	
Icon .....	23
i-format .....	108
Input Jacks .....	162
Insert (Song Edit) .....	128
Internal Song List .....	184
Intro .....	50, 58
[Intro/Ending] button .....	58
Intro/Ending Type .....	58
<b>K</b>	
Karaoke .....	43
Key .....	76
Key Template .....	<b>QS</b> 3
Key Touch .....	145
<b>L</b>	
Language .....	155
Layer .....	28
Layer Set .....	<b>QS</b> 14
Layer tone .....	28
Leading bass .....	148
Lid .....	19
Local Control .....	160
Loop Recording .....	122
Lower Tone .....	65
Lyrics .....	76, 93
lyrics .....	23
<b>M</b>	
Manual Punch-In/Out .....	123
Marker .....	87, 150
Erasing .....	88
Moving .....	88
Placing .....	87
Repeat .....	89
Master Tuning .....	152
Melody Intelligence .....	64
[Melody Intelligence] button .....	64
Memory Backup .....	155
Metronome .....	44
Animation .....	47
Beat .....	45
Pattern .....	47
Sound .....	46
Volume .....	46
[Metronome] button .....	44
MIC .....	<b>QS</b> 5
[Mic Echo] knob .....	21
Mic In jack .....	21
[Mic Volume] knob .....	21
Microphone .....	21
MIDI .....	158
MIDI Connector .....	158
MIDI Devices .....	158
MIDI Ensemble .....	159
MIDI Settings .....	160
Minus One .....	86
Mix Recording .....	121
Multitrack Recording .....	117
[Music Assistant] button .....	<b>QS</b> 10
Music Files .....	42
Music Holder .....	19
Music Stand .....	18

- Music Style ..... 50
- On Disk ..... 55
  - Rhythm Pattern ..... 57
- Music Style Buttons ..... 54
- Music Style List ..... 180–181
- Mute ..... 86, 118
- N**
- New Song ..... 96
- N.C. (No Chord) ..... **QS** 13
- Note Edit (Song Edit) ..... 130
- O**
- Octave Shift ..... 30
- One Note ..... 79
- One Touch Program [Arranger] button ..... 51
- One Touch Program [Piano] button ..... 24
- One Touch Settings ..... 146
- One-Touch Arranger ..... 51
- Settings ..... 145
- One-Touch Piano ..... 24
- Settings ..... 142
- Opening Message ..... 153
- Organ ..... **QS** 14
- Original ..... 50
- [Original] button ..... 61
- Output Jacks ..... 162
- P**
- Panel Lock ..... 157
- Part Balance ..... 67
- [Part Balance] button ..... 67
- Part Exchange (Song Edit) ..... 130
- PC Edit (Song Edit) ..... 131
- Pedal ..... 20
- Pedal Cable ..... 18
- Pedal connector ..... 18
- Pedal EX ..... **QS** 14
- Pedal Settings ..... 147
- Percussion ..... 26
- Performance Pad ..... 62–63, 147
- Phones jack ..... 20
- Phrase ..... 63
- [Phrase] button ..... 63
- Piano ..... 24
- Piano Screen ..... 23
- Pickup ..... 103
- Pitches ..... 76
- Play Mode ..... 92
- [Play/Stop] button ..... 70
- Playing ..... 69
- All of the internal songs ..... 70
  - At a fixed tempo (Tempo Mute) ..... 84
  - In random ..... 70
  - Repeat ..... 89
  - Song on floppy disk ..... 69
- Power Cord ..... 18
- Power On and Off ..... 19
- [Power] switch ..... 19
- Practice Function ..... 78
- Preset ..... 54
- Program Change ..... 161
- Protect tab ..... 104
- PU (Pickup) ..... 103
- Punch-in Recording ..... 123
- Q**
- Quantize (Song Edit) ..... 127
- Quick Tour
- Automatically starting ..... 157
- R**
- Rec Mode ..... 102, 120
- Record/Playback Buttons ..... 70
- Recording ..... 95
- 16-Track Sequencer ..... 119
  - A new song ..... 96
  - Along with a Song ..... 100
  - Redoing recordings ..... 101
  - Track buttons ..... 101
  - With Accompaniment ..... 98
- Repeat ..... 89
- Replace Recording ..... 121
- Replay ..... 74
- [Reset] button ..... 70
- Resonance ..... 142
- Restoring the Factory Settings ..... 155
- Reverb ..... 31
- [Reverb] button ..... 31
- Rhythm ..... 48
- Beat ..... 48
  - Volume ..... 49
- [Rhythm] button ..... 48
- Rhythm Partner ..... 44
- Rhythm Pattern List ..... 187
- Right-hand tone ..... 28
- Root note ..... 52
- Rotary effect ..... 148

# Index

## S

Saving .....	106
Compatibility .....	108
User Style .....	139
Score .....	74
Saving as image data .....	77
Settings .....	76
[Score Display] button .....	<b>QS 8, 74</b>
Screens	
16-track Sequencer screen .....	117
Advanced 3D screen .....	32
Basic screen .....	23, 51
Chord Sequencer screen .....	124
Copy Song screen .....	110
Copy Style screen .....	141
Copy User Programs screen .....	115
Count In settings screen .....	85
Countdown settings screen .....	60
Delete Song screen .....	109
Delete Style screen .....	140
Delete User Program screen .....	115
Effect screen .....	36
Equalizer screen .....	34
Functions screen .....	152
Genre Selection screen .....	69
Load User Program screen .....	114
Marker screen .....	87
Melody Intelligence screen .....	64
Metronome screen .....	44
MIDI Setting Screen .....	160
Part Balance screen .....	67
Piano screen .....	23–24
Program Change Screen .....	160
Rec Mode screen .....	121
Rename screen .....	107, 112, 139
Reverb screen .....	31
Rhythm screen .....	48
Save Song screen .....	106
Save Style screen .....	139
Save User Program screen .....	113
Score screen .....	74
Song Edit screen .....	125
Song File screen .....	105
Song Search screen .....	71
Song Selection screen .....	69
Style Composer screen .....	135
Style Converter screen .....	137
Style Search screen .....	56
Style Selection screen .....	54
Tone search screen .....	27
Tone selection screen .....	25
Transpose screen .....	90
User Program screen .....	112
Vocal Effects screen .....	37
Write User Program screen .....	112
Search	
Music Style .....	56
Song .....	71
Tone .....	27
[Select Various Tones] button .....	<b>QS 14</b>
[Select/Listen to a Song] button .....	<b>QS 6, 69</b>
[Session Partner] button .....	<b>QS 18</b>
SFX .....	<b>QS 5, QS 14</b>
SFX Set List .....	178
SMF .....	189
SMF Music files .....	189
Soft pedal .....	20
Solo .....	118
Song Information .....	70
Song Number .....	70
SONGS .....	<b>QS 5</b>
Song Search .....	71
[Song Stylist] button .....	<b>QS 16</b>
Sostenuto pedal .....	20
Sound Effects .....	26
Sound Generator .....	189
Speaker Cable .....	18
Split .....	66
Split Point .....	146
Split Set .....	<b>QS 14</b>
[Start/Stop] button .....	58
Stretch Tuning .....	143
String Resonance .....	144
Style Composer .....	134
Style Converter .....	136
Style Orchestrator .....	62
[Style Orchestrator] button .....	62
[Style Orchestrator/User Function] button .....	62
Style Search .....	56
Sympathetic Resonance .....	20
Sync .....	58

<b>T</b>		<b>V</b>	
Tap Tempo .....	82	Variation .....	50
Temperament .....	143	[Variation] button .....	61
Tempo .....	45, 57, 81	Vocal Count-In .....	41
Tempo [-] [+] buttons .....	81	Vocal Effect .....	37
Tempo marks .....	45	[Vocal Effect] button .....	37
Tempo Mute .....	84	Vocal Keyboard .....	41
Tempo Recording .....	132	Vocal Tap Tempo .....	84
TONES .....	<b>QS 5</b>	Volume	
Tone Buttons .....	25	Metronome .....	46
Tone List .....	170, 172	Microphone .....	21
Tone Search .....	27	Overall .....	20
Tone Set .....	119	Rhythm .....	49
Touch EX .....	<b>QS 14</b>	[Volume] knob .....	20
Touch Screen .....	22, 156	<b>W</b>	
Touch the Notes .....	75, 79	Wonderland .....	<b>QS 5</b>
Track Assign .....	94	<b>X</b>	
Track Buttons .....	86, 97, 99	XG lite .....	189
Transformer .....	39		
Transpose .....	90		
Transpose (Song Edit) .....	129		
[Transpose] button .....	90		
Troubleshooting .....	166		
Tuning .....	143		
Tuning Curve .....	143		
Tutor .....	78		
Tutor screen .....	78		
Tx Channel .....	160		
<b>U</b>			
Undo (Song Edit) .....	126		
User Functions .....	147		
User Image Display .....	154		
User Memory .....	139		
Formatting .....	156		
User Program .....	112		
Calling up .....	113		
Copying .....	115		
Deleting .....	115		
Loading .....	114		
Registering .....	112		
Saving .....	113		
Transmitting PC Numbers .....	116		
User Style .....	55, 134		
Copying .....	141		
Deleting .....	140		
Saving .....	139		

# Information

When you need repair service, call your nearest Roland Service Center or authorized Roland distributor in your country as shown below.

## AFRICA

### EGYPT

**Al Fanny Trading Office**  
9, EBN Hagar A1 Askalany Street,  
ARD El Golf, Heliopolis,  
Cairo 11341, EGYPT  
TEL: 20-2-417-1828

### REUNION

**Maison FO - YAM Marcel**  
25 Rue Jules Hermann,  
Chaudron - BP79 97 491  
Ste Clotilde Cedex,  
REUNION ISLAND  
TEL: (0262) 218-429

### SOUTH AFRICA

**That Other Music Shop  
(PTY) Ltd.**  
11 Melle St., Braamfontein,  
Johannesbourg, SOUTH AFRICA

P.O.Box 32918, Braamfontein 2017  
Johannesbourg, SOUTH AFRICA  
TEL: (011) 403 4105

### Paul Bothner (PTY) Ltd.

17 Werdmuller Centre,  
Main Road, Claremont 7708  
SOUTH AFRICA

P.O.Box 23032, Claremont 7735,  
SOUTH AFRICA  
TEL: (021) 674 4030

## ASIA

### CHINA

**Roland Shanghai Electronics  
Co.,Ltd.**  
5F, No.1500 Pingliang Road  
Shanghai, CHINA  
TEL: (021) 5580-0800

### Roland Shanghai Electronics Co.,Ltd.

**(BEIJING OFFICE)**  
10F, No.18 Anhuaxili  
Chaoyang District, Beijing,  
CHINA  
TEL: (010) 6426-5050

### HONG KONG

**Tom Lee Music Co., Ltd.  
Service Division**  
22-32 Pun Shan Street, Tsuen  
Wan, New Territories,  
HONG KONG  
TEL: 2415 0911

### INDIA

**Rivera Digitec (India) Pvt. Ltd.**  
409, Nirman Kendra Mahalaxmi  
Flats Compound Off. Dr. Edwin  
Moses Road, Mumbai-400011,  
INDIA  
TEL: (022) 2493 9051

### INDONESIA

**PT Citra IntiRama**  
J1. Cideng Timur No. 15J-150  
Jakarta Pusat  
INDONESIA  
TEL: (021) 6324170

### KOREA

**Cosmos Corporation**  
1461-9, Seocho-Dong,  
Seocho Ku, Seoul, KOREA  
TEL: (02) 3486-8855

### MALAYSIA

**BENTLEY MUSIC SDN BHD**  
140 & 142, Jalan Bukit Bintang  
55100 Kuala Lumpur, MALAYSIA  
TEL: (03) 2144-3333

### PHILIPPINES

**G.A. Yupangco & Co. Inc.**  
339 Gil J. Puyat Avenue  
Makati, Metro Manila 1200,  
PHILIPPINES  
TEL: (02) 899 9801

### SINGAPORE

**Swee Lee Company**  
150 Sims Drive,  
SINGAPORE 387381  
TEL: 6846-3676

### CRISTOFORI MUSIC PTE LTD

Blk 3014, Bedok Industrial Park E,  
#02-2148, SINGAPORE 489980  
TEL: 6243-9555

### TAIWAN

**ROLAND TAIWAN  
ENTERPRISE CO., LTD.**  
Room 5, 9fl. No. 112 Chung Shan  
N.Road Sec.2, Taipei, TAIWAN,  
R.O.C.  
TEL: (02) 2561 3339

### THAILAND

**Theera Music Co., Ltd.**  
330 Verg NakornKasem, Soi 2,  
Bangkok 10100, THAILAND  
TEL: (02) 2248821

### VIETNAM

**Saigon Music**  
138 Tran Quang Khai St.,  
District 1  
Ho Chi Minh City  
VIETNAM  
TEL: (08) 844-4068

## AUSTRALIA/ NEW ZEALAND

### AUSTRALIA

**Roland Corporation  
Australia Pty., Ltd.**  
38 Campbell Avenue  
Dee Why West, NSW 2099  
AUSTRALIA  
TEL: (02) 9982 8266

### NEW ZEALAND

**Roland Corporation Ltd.**  
32 Shaddock Street, Mount Eden,  
Auckland, NEW ZEALAND  
TEL: (09) 3098 715

## CENTRAL/LATIN AMERICA

### ARGENTINA

**Instrumentos Musicales S.A.**  
Av.Santa Fe 2055  
(1123) Buenos Aires  
ARGENTINA  
TEL: (011) 4508-2700

### BRAZIL

**Roland Brasil Ltda**  
Rua San Jose, 780 Sala B  
Parque Industrial San Jose  
Cotia - Sao Paulo - SP, BRAZIL  
TEL: (011) 4615 5666

### COSTA RICA

**JUAN BANSBACH  
Instrumentos Musicales**  
Ave.1. Calle 11, Apartado 10237,  
San Jose, COSTA RICA  
TEL: 258-0211

### CHILE

**Comercial Fancy II S.A.**  
Rut.: 96.919.420-1  
Nataníel Cox #739, 4th Floor  
Santiago - Centro, CHILE  
TEL: (02) 688-9540

### EL SALVADOR

**OMNI MUSIC**  
75 Avenida Norte y Final  
Alameda Juan Pablo II,  
Edificio No.4010 San Salvador,  
EL SALVADOR  
TEL: 262-0788

### MEXICO

**Casa Veerkamp, s.a. de c.v.**  
Av. Toluca No. 323, Col. Olivar  
de los Padres 01780 Mexico D.F.  
MEXICO  
TEL: (55) 5668-6699

### PANAMA

**SUPRO MUNDIAL, S.A.**  
Boulevard Andrews, Albrook,  
Panama City, REP. DE PANAMA  
TEL: 315-0101

### PARAGUAY

**Distribuidora De  
Instrumentos Musicales**  
J.E. Olear y ESQ. Manduivira  
Asuncion PARAGUAY  
TEL: (021) 492-124

### URUGUAY

**Todo Musica S.A.**  
Francisco Acuna de Figueroa 1771  
C.P.: 11.800  
Montevideo, URUGUAY  
TEL: (02) 924-2335

### VENEZUELA

**Musicaland Digital C.A.**  
Av. Francisco de Miranda,  
Centro Parque de Cristal, Nivel  
C2 Local 20 Caracas  
VENEZUELA  
TEL: (212) 285-8586

## EUROPE

### AUSTRIA

**Roland Austria GES.M.B.H.**  
Siemensstrasse 4, P.O. Box 74,  
A-6063 RUM, AUSTRIA  
TEL: (0512) 26 44 260

### BELGIUM/HOLLAND/ LUXEMBOURG

**Roland Benelux N. V.**  
Houtstraat 3, B-2260, Oevel  
(Westerlo) BELGIUM  
TEL: (014) 575811

### DENMARK

**Roland Scandinavia A/S**  
Nordhavnsvej 7, Postbox 880,  
DK-2100 Copenhagen  
DENMARK  
TEL: 3916 6200

### FRANCE

**Roland France SA**  
4, Rue Paul Henri SPAAK,  
Parc de l'Esplanade, F 77 462 St.  
Thibault, Lagny Cedex FRANCE  
TEL: 01 600 73 500

### FINLAND

**Roland Scandinavia As,  
Filial Finland**  
Elannontie 5  
FIN-01510 Vantaa, FINLAND  
TEL: (09) 68 24 020

### GERMANY

**Roland Elektronische  
Musikinstrumente HmbH.**  
Oststrasse 96, 22844 Norderstedt,  
GERMANY  
TEL: (040) 52 60090

### GREECE

**STOLLAS S.A.  
Music Sound Light**  
155, New National Road  
Patras 26442, GREECE  
TEL: 2610 435400

### HUNGARY

**Roland East Europe Ltd.**  
Warehouse Area 'DEPO' Pf.83  
H-2046 Torokbalint, HUNGARY  
TEL: (23) 511011

### IRELAND

**Roland Ireland**  
Audio House, Belmont Court,  
Donnybrook, Dublin 4,  
Republic of IRELAND  
TEL: (01) 2603501

### ITALY

**Roland Italy S. p. a.**  
Viale delle Industrie 8,  
20020 Arese, Milano, ITALY  
TEL: (02) 937-78300

### NORWAY

**Roland Scandinavia Avd.  
Kontor Norge**  
Lilleakerveien 2 Postboks 95  
Lilleaker N-0216 Oslo  
NORWAY  
TEL: 2273 0074

### POLAND

**P. P. H. Brzostowicz**  
UL. Gibraltarska 4,  
PL-03664 Warszawa POLAND  
TEL: (022) 679 44 19

### PORTUGAL

**Tecnologias Musica e Audio,  
Roland Portugal, S.A.**  
Cais Das Pedras, 8/9-1 Dto  
4050-465 PORTO  
PORTUGAL  
TEL: (022) 608 00 60

### ROMANIA

**FBS LINES**  
Piata Libertatii 1,  
RO-4200 Gheorgheni  
TEL: (095) 169-5043

### RUSSIA

**MuTek**  
3-Bogatyrskaya Str. 1.k.1  
107 564 Moscow, RUSSIA  
TEL: (095) 169 5043

### SPAIN

**Roland Electronics  
de España, S. A.**  
Calle Bolivia 239, 08020  
Barcelona, SPAIN  
TEL: (93) 308 1000

### SWEDEN

**Roland Scandinavia A/S  
SWEDISH SALES OFFICE**  
Danvik Center 28, 2 tr.  
S-131 30 Nacka SWEDEN  
TEL: (08) 702 00 20

### SWITZERLAND

**Roland (Switzerland) AG**  
Landstrasse 5, Postfach,  
CH-4452 Itingen,  
SWITZERLAND  
TEL: (061) 927-8383

### UKRAINE

**TIC-TAC**  
Mira Str. 19/108  
P.O. Box 180  
295400 Munkachevo, UKRAINE  
TEL: (03131) 414-40

### UNITED KINGDOM

**Roland (U.K.) Ltd.**  
Atlantic Close, Swansea  
Enterprise Park, SWANSEA  
SA7 9FJ,  
UNITED KINGDOM  
TEL: (01792) 702701

## MIDDLE EAST

### BAHRAIN

**Moon Stores**  
No.16, Bab Al Bahrain Avenue,  
P.O.Box 247, Manama 304,  
State of BAHRAIN  
TEL: 211 005

### CYPRUS

**Radex Sound Equipment Ltd.**  
17, Diagorou Street, Nicosia,  
CYPRUS  
TEL: (022) 66-9426

### IRAN

**MOCO, INC.**  
No.41 Nike St., Dr.Shariyati Ave.,  
Toleroye Cerahe Mirdamad  
Tehran, IRAN  
TEL: (021) 285-4169

### ISRAEL

**Haliit P. Greenspoon &  
Sons Ltd.**  
8 Retzif Ha'aliya Hashnya St.  
Tel-Aviv-Yafo ISRAEL  
TEL: (03) 6823666

### JORDAN

**AMMAN Trading Agency**  
245 Prince Mohammad St.,  
Amman 1118, JORDAN  
TEL: (06) 464-1200

### KUWAIT

**Easa Husain Al Yousifi Est.**  
Abdullah Salem Street,  
Safat, KUWAIT  
TEL: 243-6399

### LEBANON

**Chahine S.A.L.**  
Gerge Zeidan St., Chahine Bldg.,  
Achrafieh, P.O.Box: 16-5857  
Beirut, LEBANON  
TEL: (01) 20-1441

### QATAR

**Al Emadi Co. (Badie Studio  
& Stores)**  
P.O. Box 62,  
Doha, QATAR  
TEL: 4423-554

### SAUDI ARABIA

**aDawlah Universal  
Electronics AP**  
Corniche Road, Aldossary Bldg.,  
1st Floor, Alkhobar,  
SAUDI ARABIA

P.O.Box 2154, Alkhobar 31952  
SAUDI ARABIA  
TEL: (03) 898 2081

### SYRIA

**Technical Light & Sound  
Center**  
Khaled Ebn Al Walid St.  
Bldg. No. 47, P.O.BOX 13520,  
Damascus, SYRIA  
TEL: (011) 223-5384

### TURKEY

**Barkat muzik aletleri ithalat  
ve ihracat Ltd Sti**  
Siraselvilir Caddesi Siraselvilir  
Pasaji No:74/20  
Taksim - Istanbul, TURKEY  
TEL: (0212) 2499324

### U.A.E.

**Zak Electronics & Musical  
Instruments Co. L.L.C.**  
Zabeel Road, Al Sherooq Bldg.,  
No. 14, Grand Floor, Dubai, U.A.E.  
TEL: (04) 3360715

## NORTH AMERICA

### CANADA

**Roland Canada Music Ltd.  
(Head Office)**  
5480 Parkwood Way Richmond  
B. C., V6V 2M4 CANADA  
TEL: (604) 270 6626

### Roland Canada Music Ltd.

**(Toronto Office)**  
170 Admiral Boulevard  
Mississauga On L5T 2N6  
CANADA  
TEL: (905) 362 9707

### U. S. A.

**Roland Corporation U.S.**  
5100 S. Eastern Avenue  
Los Angeles, CA 90040-2938,  
U. S. A.  
TEL: (323) 890 3700



This product complies with the requirements of European Directives EMC 89/336/EEC and LVD 73/23/EEC.

For EU Countries

## FEDERAL COMMUNICATIONS COMMISSION RADIO FREQUENCY INTERFERENCE STATEMENT

This equipment has been tested and found to comply with the limits for a Class B digital device, pursuant to Part 15 of the FCC Rules. These limits are designed to provide reasonable protection against harmful interference in a residential installation. This equipment generates, uses, and can radiate radio frequency energy and, if not installed and used in accordance with the instructions, may cause harmful interference to radio communications. However, there is no guarantee that interference will not occur in a particular installation. If this equipment does cause harmful interference to radio or television reception, which can be determined by turning the equipment off and on, the user is encouraged to try to correct the interference by one or more of the following measures:

- Reorient or relocate the receiving antenna.
- Increase the separation between the equipment and receiver.
- Connect the equipment into an outlet on a circuit different from that to which the receiver is connected.
- Consult the dealer or an experienced radio/TV technician for help.

This device complies with Part 15 of the FCC Rules. Operation is subject to the following two conditions:

- (1) This device may not cause harmful interference, and
- (2) This device must accept any interference received, including interference that may cause undesired operation.

Unauthorized changes or modification to this system can void the users authority to operate this equipment.  
This equipment requires shielded interface cables in order to meet FCC class B Limit.

For the USA

For Canada

### NOTICE

This Class B digital apparatus meets all requirements of the Canadian Interference-Causing Equipment Regulations.

### AVIS

Cet appareil numérique de la classe B respecte toutes les exigences du Règlement sur le matériel brouilleur du Canada.

Contents		
No.	Name	Qty.
1	Instrument	1
2	Manual Set	1
3	AC Cord Set	1
4	Collection of Printed Music	1

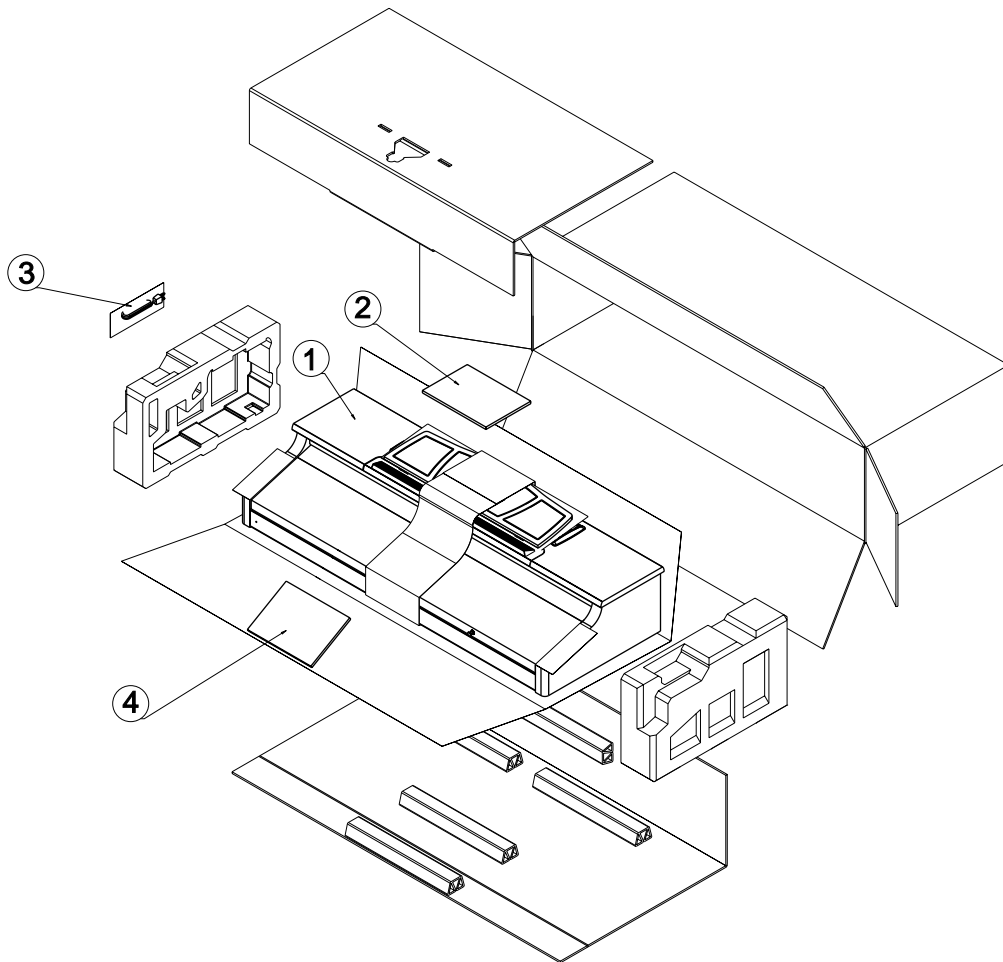

This owner's manual is printed on recycled paper.