

# Roland



DIGITAL INTELLIGENT PIANO

---

# KR-4500

Quick Start

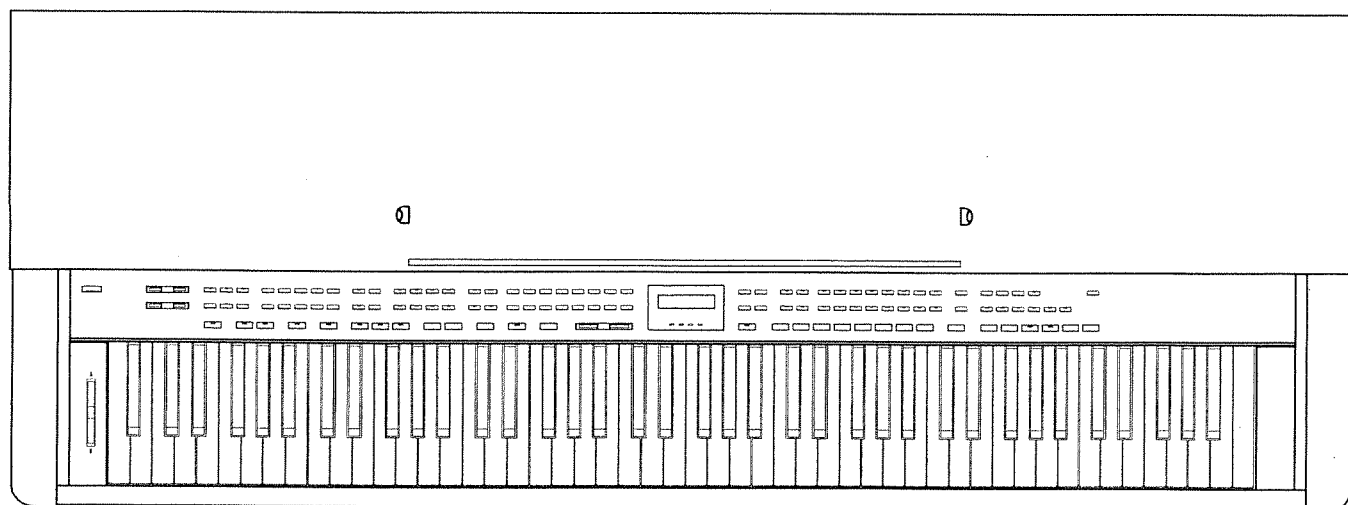



# Before You Begin

We'd like to take a moment to thank you for purchasing the Roland KR-4500 Intelligent Piano.

We've tried to keep this Quick Start Guide small (and describe all the basic features as concisely as possible) so you can spend less time reading and more time playing.

The instructions are step-by-step, so even if you're new to electronic musical instruments, don't worry! It's easy if you just follow the directions.

As you become acquainted with the KR-4500, we know that your first impressions will be positive ones. And as you explore further, be sure to read the entire Owner's Manual in addition to this Quick Start Guide.

# Table of Contents

1 . Turning the Power On .....	3
a. The Display - Master Screen and Function Screen .....	4
2 . Playing Some Sounds .....	5
a. Adjust the Master Volume - Volume Slider .....	5
b. Adjust the Tone Quality - Brilliance Slider .....	5
c. The Way You Play Your Keyboard Will Affect the Volume and Tone - Touch Sensing .....	6
d. Using the Pedals - Damper Pedal, Soft Pedal and Sostenuto Pedal .....	6
3 . Listen to the Demo Songs .....	7
a. Listening to all the Demo Songs .....	7
b. Listening to a Particular Demo Song .....	8
4 . Listen to Some of the Different Tones .....	9
a. Varying the Pitch of a Note - Pitch Bend Wheel .....	10
5 . Playing Percussion Sounds from the Keyboard - Manual Drums .....	11
6 . Special Effect Sounds from the Keyboard - Manual Sound Effects .....	12
7 . Playing Two Tones as One - Layer Mode .....	13
a. Selecting a New Tone for the Upper Part .....	13
b. Selecting a New Tone for the Lower Part .....	14
c. Adjusting the Balance Between the Two Parts .....	14
8 . Two Keyboards in One - Keyboard Split .....	15
a. Changing the Split Point .....	16
9 . Playing Along With Automatic Rhythm Accompaniment .....	17
10. Style Play .....	21
a. Auto Accompaniment with Chords on the Lower Keyboard - Split Arranger (One Touch Program) .....	21
b. Add Some Harmony to Your Melody - Melody Intelligence .....	22
c. Play the Chords with a One or Two-Finger Operation - Chord Intelligence .....	22
11. Advanced Style Play .....	23
a. Auto Accompaniment with Full-Keyboard Chords -Piano Style Arranger (One Touch Program) .....	23
b. Make the Lowest Note of an Inverted Chord the New Bass Note - Leading Bass .....	24
12. Recording Panel Settings - User Program .....	25
a. Calling up Settings .....	25
b. Storing Panel Settings .....	25
c. Returning to the Factory Presets .....	26
13. Recording a Style Performance and Playing it Back Later - Composer .....	27
a. Recording a Style Performance - Recording .....	27
b. Playback .....	28
c. A Title for the Song You Have Recorded - Song Name .....	30
14. Create Your Own Disks - Save/Load .....	32
a. Saving Performance Data to a Floppy Disk - Save (Initializing a Floppy Disk - Format) .....	32
b. Reading the Performance Data - Load .....	34
15. Turning Off the Power .....	35

Note :

The appropriate power supply for this instrument is shown on its name plate. Please make sure that the line voltage in your country meets the requirement

Note :

You must remove the disk before turning on the unit. This will prevent possible damage to data stored on the disk.

Note :

If this is the first time you've turned on the KR-4500 or you haven't played it in a while, you'll see the following display and the keyboard will be disabled. Don't worry, this is normal. Just press **WRITE** and proceed as usual.

NO MEMORY BACKUP  
PRESS WRITE

# 1. Turning the Power On

- ① Plug the power cord into a standard power outlet.

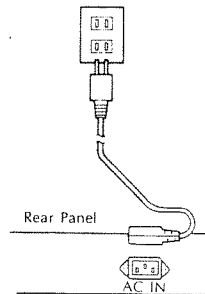

- ② Make sure that a disk is not inserted in the disk drive (on the right-hand side of the panel). If there is, press the Eject button and remove it.

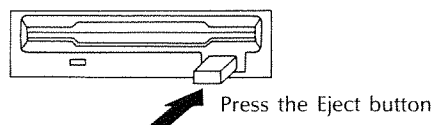

- ③ Locate the POWER switch on the left-hand side of the panel and turn it on.

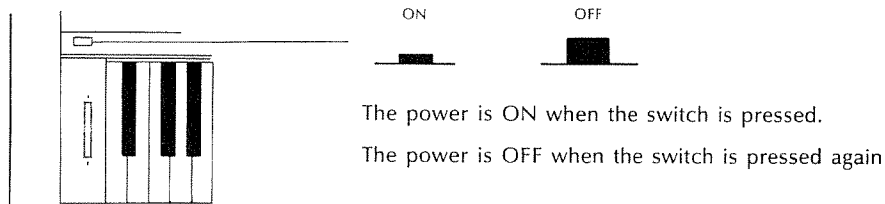

You should see this in the display screen :

Roland KR-4500  
Intelligent Piano

After a little while the display will change again to look like this :

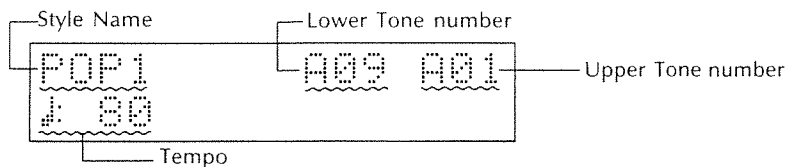

and the KR-4500 will be ready to play! This is called the Master Screen, and it displays four things you will probably want to know while playing the instrument : Style Name, Lower Tone Number, Upper Tone Number and Tempo (more on these later). We will usually start from this screen in the step-by-step explanations of the KR-4500's functions.

## a. The Display - Master Screen and Function Screen

The KR-4500's display will show the "Master Screen" most of the time, with the settings for Style Name, Upper Tone Number, Lower Tone Number and Tempo. However, when you start pressing buttons to access different Tones and special functions, it will change to a "Function Screen" to give you information about that particular operation (the Master Screen will return when you're finished).

### ▼ Master Screen



```
POP1      A09 A01
♩ 80
```

The Master Screen is also where User Program Numbers (see P.25) and Chord Names will be displayed.

### ▼ Function Screen

(This is just one of the several different Function Screens that can be called up.)

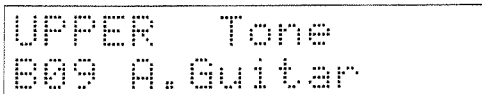

```
UPPER Tone
B09 A. Guitar
```

If you press a button to select a function but don't actually do anything for 4 or 5 seconds, the Function Screen that has been called up will revert back to the Master Screen, and you'll have to start over again.

In some cases, depending on the location of the instrument or the lighting conditions, the display screen may become difficult to read. In such a case it may be necessary to adjust the contrast of the display screen (See Owner's Manual Page 54).

## 2. Playing Some Sounds

OK, so the power is on. Let's play a little! When the KR-4500 first powers up, you should be able to hear a piano sound by playing the keyboard.

### a. Adjust the Master Volume - Volume Slider

All the way to the left is the minimum volume (MIN), and all the way to the right is maximum (MAX).

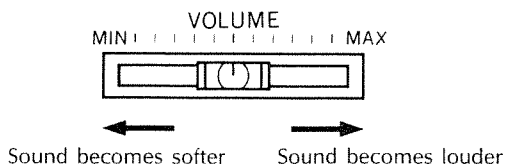

The headphone jack is located beneath the left-hand side of the keyboard. When you plug in the headphones, no sound will be heard from the speakers, this allows you to play for your own enjoyment without disturbing anyone.

The headphone volume is adjusted with the Volume slider.

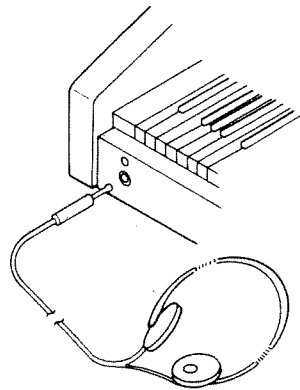

#### Warning:

To avoid damage to your ears, as well as to the headphones, never apply excessive volume to the headphones.

Use only stereo headphones (with an impedance of 8 to 150 ohms).

### b. Adjust the Tone Quality - Brilliance Slider

You can make the sound brighter and more sparkling, or warmer and more subdued, by moving the BRILLIANCE slider.

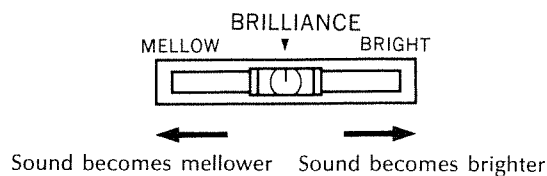

Slide the BRILLIANCE slider all the way to the right (BRIGHT) for maximum brightness, and all the way to the left (MELLOW) for a warmer, most subdued tone quality.

### c. The Way You Play Your Keyboard Will Affect the Volume and Tone - Touch Sensing

If you strike the keys hard, the sound will be loud and brilliant. If you play with a softer touch, the sound will be softer and warmer. This feature is referred to as Touch Sensing, and it makes the KR-4500 an instrument capable of expressing all the subtleties you put into your playing.



Play softly to get a soft and mellow sound

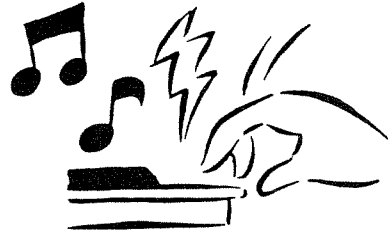

Play harder to get a loud and brilliant sound

### d. Using the Pedals - Damper Pedal, Soft Pedal and Sostenuto Pedal

The KR-4500's special stand comes equipped with three pedals that perform the same functions as those on an acoustic piano.

On the right is the damper pedal, in the middle is the sostenuto pedal and on the left is the soft pedal.

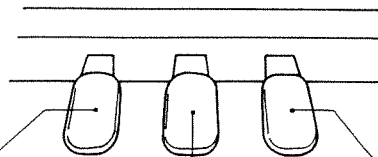

○ Soft Pedal (left)...

Softens the overall sound, like the soft pedal on an acoustic piano.

○ Sostenuto pedal(center)...

Like a selective Damper pedal, only the notes played when the Sostenuto pedal is pressed will be sustained. Notes played after the pedal is depressed will not be affected.

○ Damper Pedal (right)...

Adds sustain to the overall sound.



### 3. Listen to the Demo Songs

To give you an idea of what the KR-4500 can do, listen to the Demo Songs included in the instrument. These five pieces demonstrate the range of the KR-4500's capabilities, and are stored in memory so you can listen to them anytime.

The following five Demo Songs are provided :

1	Bop on the Rocks
2	Last Flower
3	Sailing
4	Etude No.5 Gbmaj
5	Mind Air No.08

#### a. Listening to all the Demo Songs

##### What To Do

From the Master Screen :

- ① Press **SONG/DEMO**.

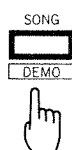

You'll see the following Function Screen displayed :

PLAY DEMO SONG  
SELECT NUMBER

- ② Press **PLAY** to start the songs.



To stop play before the song is over, press **STOP**.

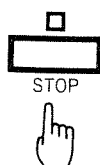

The Demo Songs continue to play, one after another, until you press **STOP**. Then the Master Screen will return to the display.

If you see a different screen than this, it is possible that the instrument didn't register two presses of

**SONG/DEMO**

Try pressing it one more time.

## b. Listening to a Particular Song

### What To Do

From the Master Screen :

- 1 Press **SONG/DEMO**.

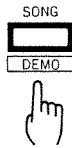

and you'll see the following Function Screen displayed :

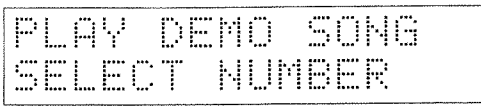

At this point, you'll see the LEDs flashing on **PLAY**, **RHYTHM**, and on buttons **1** - **5** in the TRACK section.

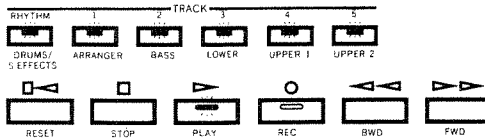

Remember, if you don't press any buttons within 4 or 5 seconds, the display will revert to the Master Screen.

- 2 Select a Demo Song.

Press any of the buttons **1** through **5** in the TRACK section to select the corresponding Demo Song, or press **RHYTHM** to select all the Demo Songs.

- 3 Press **PLAY** to start the song(s).



When only one Demo Song has been selected, the display will automatically return to the Master Screen when that song has finished playing.

To stop play before the song is over, press **STOP**.



If, however, you've pressed **RHYTHM** and want to hear all the Demo Songs, they will continue to play, one after another, until you press **STOP**. Then the Master Screen will return to the display.

If you see a different screen than this, it is possible that the instrument didn't register two presses of

**SONG/DEMO**.

Try pressing it one more time.

Demo Songs can also be selected by using **INC** and **DEC**.

Only the Brilliance control and Master Volume will function while a Demo Song is playing.

This operates with more than just Demo Songs. You can record, store and playback your own songs in this way using the Composer function (P.27).

# 4. Listen to Some of the Different Tones

The KR-4500 comes ready with a palette of 40 different "Tones" from which to choose. Try playing a song with one Tone first, then select a different Tone (by pressing the desired Tone button) and play the song again.

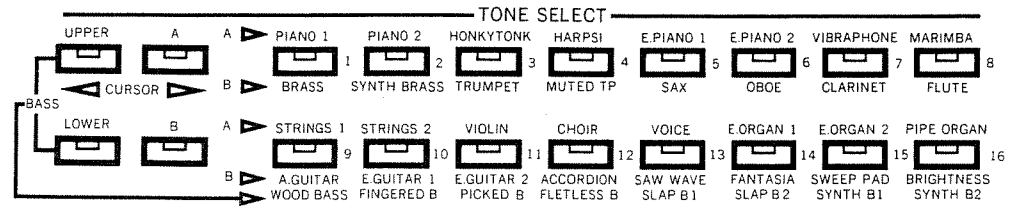

When the Tone Select A LED is on, the Tone indicated above the button will be selected by pressing that button. Press Tone Select B (the Tone Select B LED will be on) and the Tone indicated below the button will be selected by pressing that button.

Try selecting the Acoustic Guitar (A. GUITAR) Tone.

### What To Do

From the Master Screen :

- ① Press Tone Select (B) so that the (B) bank LED lights.
- ② Press (A.GUITAR).

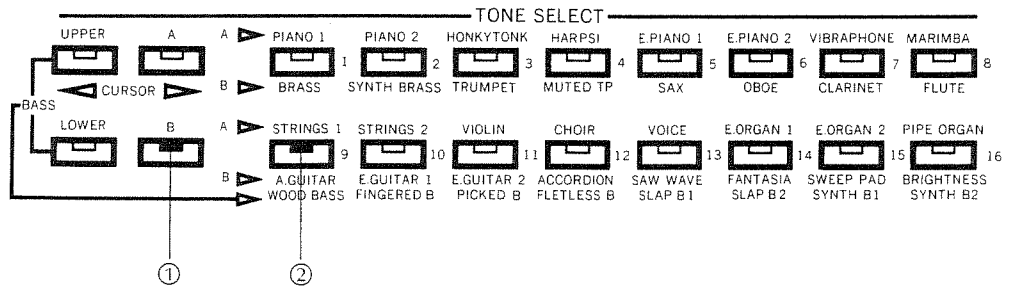

The selected Tone will appear in the Function Screen display...

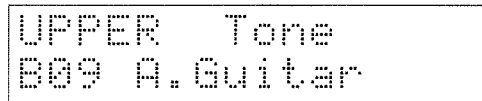

...and after 4 or 5 seconds the Master Screen will reappear.



Now you can play using the Acoustic Guitar Tone.

There is a way you can increase the number of Tones you have to play with, up to a maximum of 128. (For a detailed explanation, See Owner's Manual Page 65).

## a. Varying the Pitch of a Note - Pitch Bend Wheel

Just to the left of the keyboard is a control (as shown in the diagram) called the Pitch Bend Wheel. Moving this wheel lets you smoothly alter or "bend" the pitch of the note you have just played.

The default setting for maximum variation in pitch by the Pitch Bend Wheel is two semitones up or down, but this can easily be changed if you wish (see Owner's Manual P. 50).

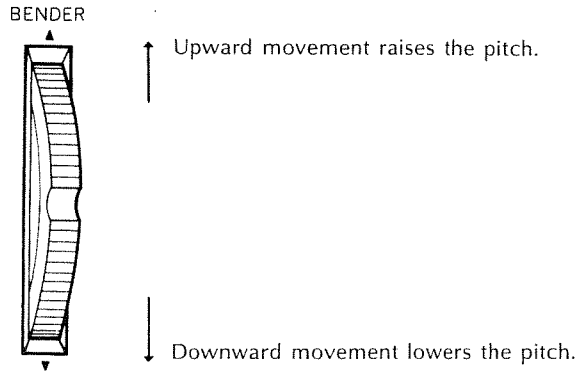

Relationship between pitch and wheel movement

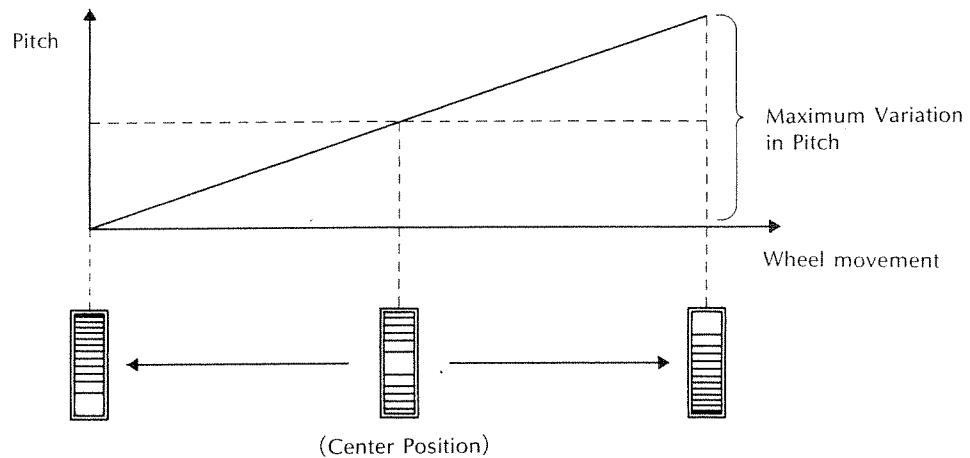

The Pitch Bend Wheel always returns to its center position (normal pitch) as soon as it is released.

There are 8 different Drum Sets to choose from.

If you press

**MANUAL DRUMS**

(the LED will come on), you can select Drum Sets by pressing **INC** or **DEC** before the display returns to the Master Screen. (During power up the Standard Drum set will automatically be selected). For a detailed explanation, see the Owner's Manual on page 157.

If you wish, you can place a keyboard sticker (P. 8) on the keyboard to show which key plays which percussion sound in the Manual Drums mode.

Use the Pitch Bend Wheel while in the Manual Drums mode, and play some wild solos unlike anything you could play with an ordinary rhythm machine! (The Pitch Bend Wheel can alter the pitch by a maximum of one octave up or down.)

## 5. Playing Percussion Sounds from the Keyboard - Manual Drums

Press **MANUAL DRUMS** and the LED will come on. Now you can play up to 61 percussion instrument sounds directly from the keyboard! Or, use the Manual Drums function when the selected Music Style is already playing (P.17).

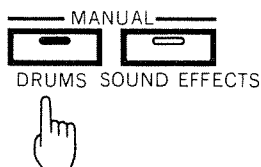

The percussion instrument assigned to each key is shown in the following diagram.

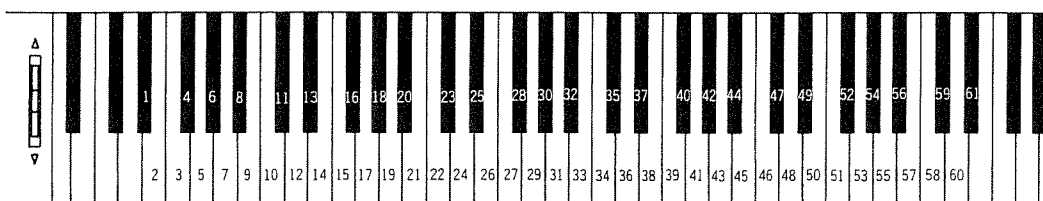

- |                    |                      |
|--------------------|----------------------|
| 1. High Q          | 32. Vibra-slap       |
| 2. Slap            | 33. Ride Cymbal 2    |
| 3. Scratch Push    | 34. High Bongo       |
| 4. Scratch Pull    | 35. Low Bongo        |
| 5. Sticks          | 36. Mute High Conga  |
| 6. Square Click    | 37. Open High Conga  |
| 7. Metronome Click | 38. Low Conga        |
| 8. Metronome Bell  | 39. High Timbale     |
| 9. Kick Drum 2     | 40. Low Timbale      |
| 10. Kick Drum 1    | 41. High Agogo       |
| 11. Side Stick     | 42. Low Agogo        |
| 12. Snare Drum 1   | 43. Cabasa           |
| 13. Hand Clap      | 44. Maracas          |
| 14. Snare Drum 2   | 45. Short Hi Whistle |
| 15. Low Tom 2      | 46. Long Hi Whistle  |
| 16. Closed Hi-hat  | 47. Short Guiro      |
| 17. Low Tom 1      | 48. Long Guiro       |
| 18. Pedal Hi-hat   | 49. Claves           |
| 19. Mid Tom 2      | 50. High Wood Block  |
| 20. Open Hi-hat    | 51. Low Wood Block   |
| 21. Mid Tom 1      | 52. Mute Cuica       |
| 22. High Tom 2     | 53. Open Cuica       |
| 23. Crash Cymbal 1 | 54. Mute Triangle    |
| 24. High Tom 1     | 55. Open Triangle    |
| 25. Ride Cymbal 1  | 56. Shaker           |
| 26. Chinese Cymbal | 57. Jingle Bell      |
| 27. Ride Bell      | 58. Belltree         |
| 28. Tambourine     | 59. Castanets        |
| 29. Splash Cymbal  | 60. Mute Surdo       |
| 30. Cowbell        | 61. Open Surdo       |
| 31. Crash Cymbal 2 |                      |

## 6. Special Effect Sounds from the Keyboard - Manual Sound Effects

Press **MANUAL SOUND EFFECTS** and the LED will light. Now you can play 46 different sound effects (sampled sounds and special effects) directly from the keyboard. You can also use the instrument's touch sensitive keyboard to alter the dynamics of the sound by how hard or soft you play.

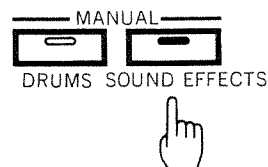

There are two kinds of sound effects; "looping" and "one-shot". These terms describe how the sound is generated inside the KR-4500.

**Looping sounds**, such as audience applause or wind sounds, continue for as long as you hold the key. These sounds build up gradually, so hold down the key for a while and give them time to fade in.

**One-shot sounds**, such as footsteps, gunshots, etc., are heard the instant you press the key. You can play them rhythmically, almost like percussion instruments, adding dynamics and maybe even a little Pitch Bend!

The Sound Effect assigned to each key is shown in the following diagram.

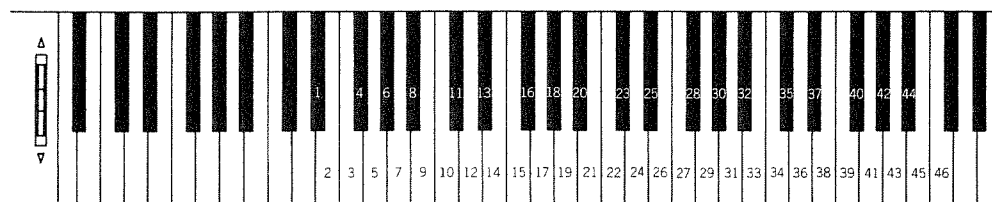

- |                                 |                  |
|---------------------------------|------------------|
| 1. High Q                       | 24. Windchime    |
| 2. Slap                         | 25. Car-engine   |
| 3. Scratch Push                 | 26. Car-stop     |
| 4. Scratch Pull                 | 27. Car-pass     |
| 5. Sticks                       | 28. Car-crash    |
| 6. Square Click                 | 29. Siren        |
| 7. Metronome Click              | 30. Train        |
| 8. Metronome Bell               | 31. Jetplane     |
| 9. Guitar Sliding Finger        | 32. Helicopter   |
| 10. Guitar Cutting Noise (Down) | 33. Starship     |
| 11. Guitar Cutting Noise (Up)   | 34. Gun Shot     |
| 12. String Slap of Double Bass  | 35. Machine Gun  |
| 13. Fl. Key Click               | 36. Laser Gun    |
| 14. Laughing                    | 37. Explosion    |
| 15. Screaming                   | 38. Dog          |
| 16. Punch                       | 39. Horse-gallop |
| 17. Heart Beat                  | 40. Birds        |
| 18. Foot Steps 1                | 41. Rain         |
| 19. Foot Steps 2                | 42. Thunder      |
| 20. Applause                    | 43. Wind         |
| 21. Door Creaking               | 44. Seashore     |
| 22. Door                        | 45. Stream       |
| 23. Scratch                     | 46. Bubble       |

# 7. Playing Two Tones as One

## - Layer Mode

By selecting the Keyboard Layer Mode, you can combine two Tones that will play in perfect sync, making a whole new Tone that will appear to be more than the sum of its parts.

Press **LAYER**, and both the **LAYER** and **LOWER** LEDs will light. You're now in Layer Mode, and can combine ("layer") Tones from the Upper and Lower parts to make new Tones that can be played over the entire keyboard range.

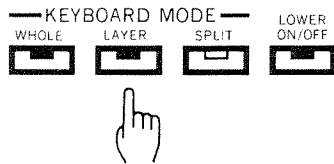

Turning the power on automatically sets the Upper Tone to "A01 PIANO 1" and the Lower Tone to "A09 STRINGS 1".

### a. Selecting a New Tone for the Upper Part

#### What To Do

From the Master Screen :

- ① Press **UPPER**. The LED will light.
- ② Press **A** or **B**.  
Pressing **A** selects Bank A (the Tone names are indicated above the Tone buttons).  
Pressing **B** selects Bank B (the Tone names are indicated below the Tone buttons).
- ③ Now press the particular Tone button for the desired Tone.

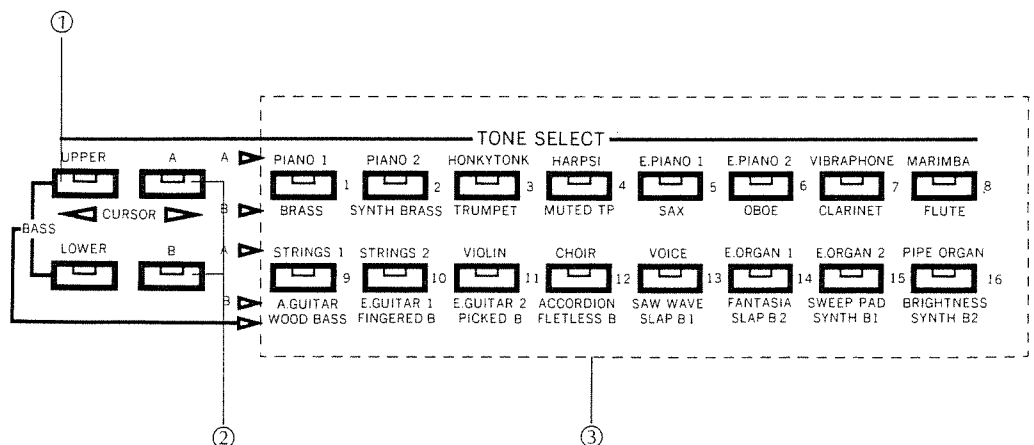

## b. Selecting a New Tone for the Lower Part

### What To Do

From the Master Screen :

- ① Press **LOWER**. The LED will light.
- ② Press **A** or **B**.  
Pressing **A** selects Bank A (the Tone names are indicated above the Tone buttons).  
Pressing **B** selects Bank B (the Tone names are indicated below the Tone buttons).
- ③ Now press the particular Tone button for the desired Tone.

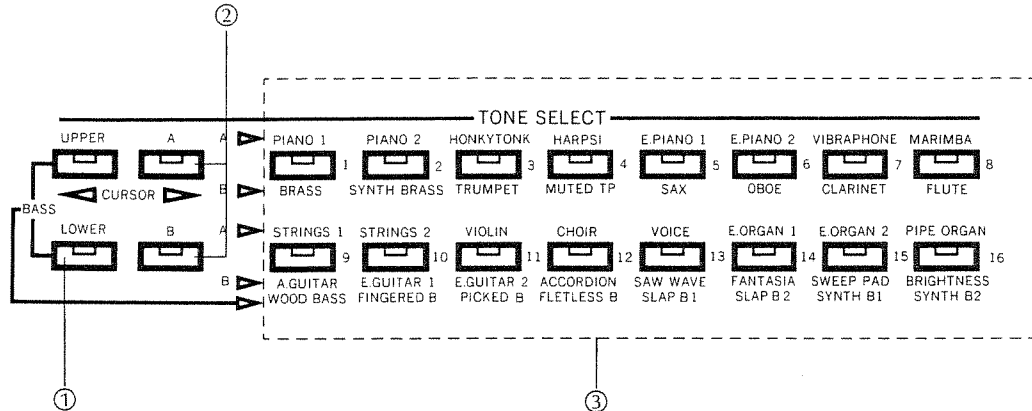

## c. Adjusting the Balance Between the Two Parts

### What To Do

From the Master Screen :

- ① In the BALANCE Section, press **△** or **▽** for either UPPER or LOWER to select which Part volume you wish to change. The Balance Function screen for the selected Part (Upper or Lower) will appear.

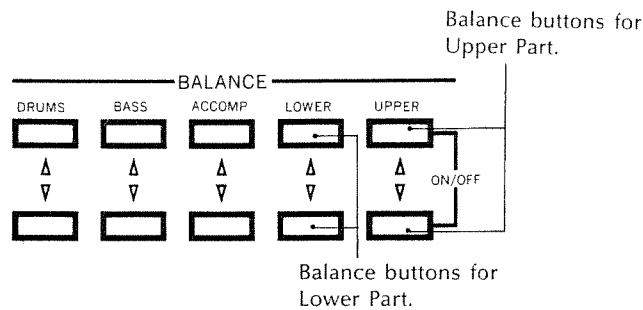

- ② Now press **△** to increase, or **▽** to decrease the volume.

Pressing the button once will change the volume by one unit. You can also change the volume continuously by holding the button down.



## 8. Two Keyboards in One - Keyboard Split

Imagine playing a piano sound with your right hand, and a string sound with your left! That's the Split Keyboard Mode, where you can have, in effect, two keyboards with completely different Tones.



To split the keyboard, first decide at which key you wish to place the Split Point. Keys to the left of it will be in the Lower Keyboard Section, and those to the right will be in the Upper Keyboard Section (the Split Point key itself belongs to the Lower Keyboard Section).

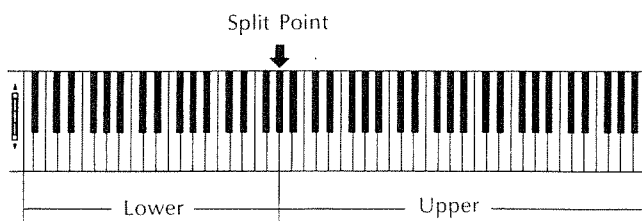

When you press **LOWER** to turn off the light when the **SPLIT** LED is lit, the **LOWER** LED will not be illuminated even if **SPLIT** is pressed again. If this happens, press **LOWER** again to turn on the light.

The pedal functions in the Split mode are set at the factory as follows :

Right Pedal ...Sustain is applied only to the Upper keyboard.

Center Pedal...Sostenuto effect is applied to both the Upper and Lower keyboard Sections.

Left Pedal .....Soft pedal effect is applied to both the Upper and Lower keyboard Sections.

## a. Changing the Split Point

When you turn on the KR-4500, the Split Point is set at A $\flat$ 3. You can change the Split Point by following the steps below.

### What To Do

From the Master Screen :

- ① While holding down **SPLIT**, press the key you wish to set as the new Split Point.

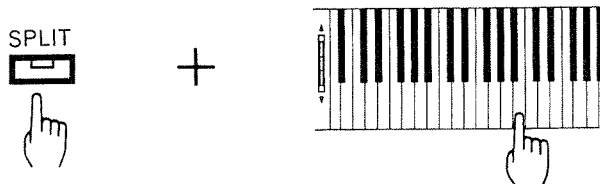

The display will show the Split Point you have set :

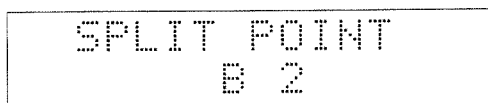

The Split Point will change back to A $\flat$ 3 every time the instrument is switched on.

# 9. Playing Along with Automatic Rhythm Accompaniment

The Arranger function lets you play along with an Auto Accompaniment Musical Style (or "Style Play" for short). If the Arranger is off, you can play a solo line along with just the rhythm using "Rhythm Only Play." Here's how.

## What To Do

From the Master Screen :

- ① Make sure the **ON/OFF** LED in the Arranger Section is turned off. If it is on, press **ON/OFF** to turn it off.



Make sure this LED is off.

- ② Select the Tone to be played.

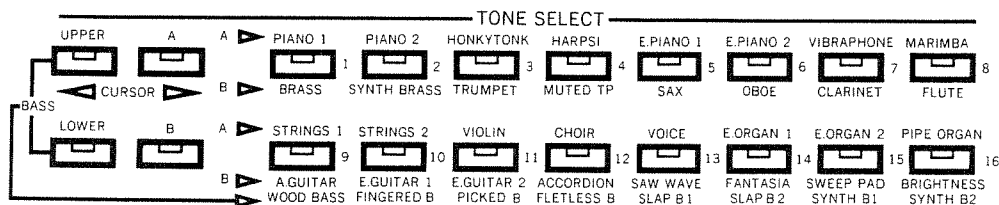

- ③ Select a Music Style.

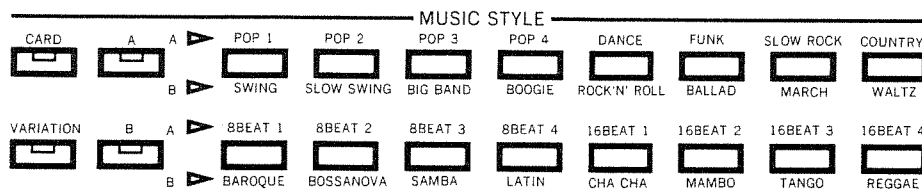

The tempo will automatically change to the tempo preset for the new style (unless you select a new style while a style is already playing, in which case the tempo will not change).

## Note

Some Music Styles do not contain Rhythm patterns. If you start one of these styles with the Arranger off, no sound will be heard.

If the tempo of a Music Style has been changed in any way, you can quickly return to the preset tempo by pressing the **INC** and **DEC** buttons simultaneously.

- ④ If you wish, adjust the tempo.

Tempo can be adjusted with the Tempo slider or **INC**/**DEC**. The tempo becomes faster by moving the slider to the right or pressing **INC**. The tempo becomes slower by moving the slider to the left or pressing **DEC**. In either case, the new tempo will be indicated in beats per minute on the lower left of the display (the range over which the tempo can adjusted is  $\downarrow$  : 30 - 240 bpm).

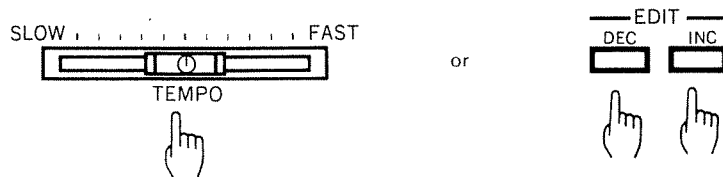

- ⑤ Now you're ready to start the Rhythm (Music Style). There are four ways to do this.

- Press **START/STOP**.

The Rhythm will start immediately.

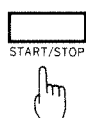

- Press **SYNC START**.

The Rhythm will start when you press any key on the keyboard, indicating that you're ready to start playing your solo and have the Rhythm follow. If the keyboard is in the Split mode, the Rhythm will start when you press any key on the Lower keyboard Section.

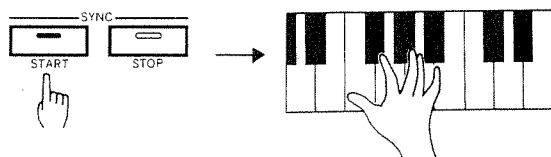

- Press **INTRO/ENDING**.

The Rhythm will start immediately with the Intro Pattern for the Music Style you have selected.

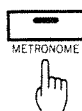

The actual Intro pattern and length will vary depending on the Music Style selected.

- Press **SYNC START**, and then **INTRO/ENDING** (the **SYNC START** LED will start to flash). This method is similar to pressing **SYNC START** alone, except that now when you press any key on the keyboard, the Intro Pattern will play first, then lead into the Rhythm. Again, if there is a Split Point set, the Intro Pattern for that Rhythm will start when you press any key on the Lower keyboard Section.

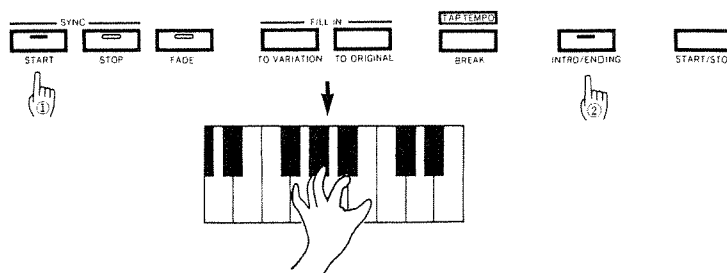

⑥ Adding a Fill-In Pattern.

A real drummer tends to play change-up patterns (fill-ins) at certain key moments for musical emphasis, or changes the rhythm pattern between verse and chorus for variety. Well, now you can do this too, by using one of two buttons on the KR-4500.



Fill-In To Variation

Plays a fill-in, then starts playing the Variation Pattern for that Music Style.

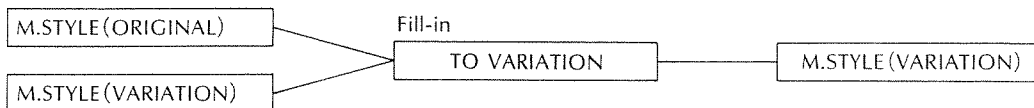

The **VARIATION** LED will be on, meaning that the Music Style will switch to the Variation Pattern and continue playing that pattern until you press the FILL IN TO ORIGINAL button described below. (If **VARIATION** was already on, the Variation Pattern will continue unchanged after the fill-in).

Fill-In To Original

Plays a fill-in, then starts playing the Original Pattern for that Music Style.

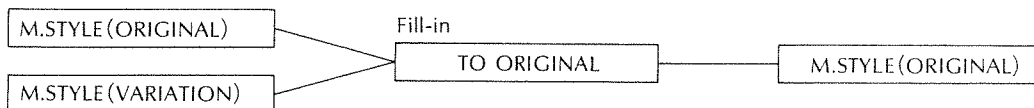

The **VARIATION** LED will go out, and the Music Style will switch to the Original Pattern after the fill-in. (If **VARIATION** was already off, the Original Pattern will continue unchanged after the fill-in).

For each Music Style there are two Rhythm patterns to play along with: the Original Pattern and the Variation Pattern. By switching between them with the Fill-In button, you can add variety to the songs you play.

The fill-in function plays a one measure fill. However, only a portion of the fill may play, depending on when within the Style pattern measure you press the FILL IN button.

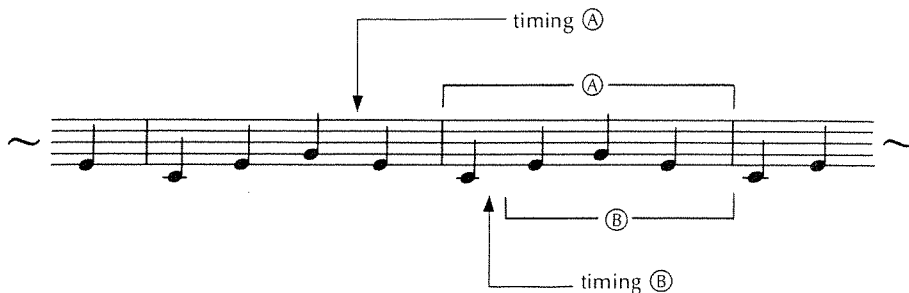

⑦ Stopping the Rhythm (Music Style)

There are two ways to stop the Rhythm during play :

- Press **START/STOP**.

The Rhythm will stop as soon as you press this button.



START/STOP



- Press **INTRO/ENDING**.

The Rhythm will stop after playing an ending appropriate to the Music Style selected.



INTRO/ENDING



The actual ending pattern will differ depending on the Music Style selected.

### Metronome

You may also keep time following the sound of a metronome instead of the Automatic Rhythm Accompaniment.

#### What To Do

- ① Press **Metronome** to start the metronome.

The button's LED will light.



METRONOME



- ② Use the Tempo slider or **INC** / **DEC** to adjust the tempo.

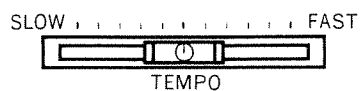

or

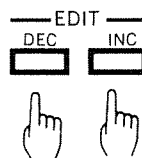

The beat count for the metronome is determined by the selected Music Style. If you desire a 3-beat count, simply select a Waltz Music Style beforehand.

# 10. Style Play

This section will explain about the basic kinds of Style Play (Auto Accompaniment by Music Styles).

## a. Auto Accompaniment with Chords on the Lower Keyboard - Split Arranger (One Touch Program)

The SPLIT ARRANGER button in the One Touch Program section offers the most convenient way to select the settings for Style Play. When using the Split Arranger, chords are played on the Lower keyboard section (to the left of the Split Point) and the melody is played on the Upper keyboard section. All appropriate Tones, Part Balances, etc. for the selected Music Style are set automatically.

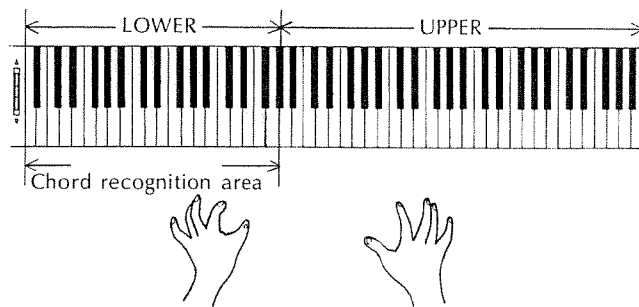

### What To Do

From the Master Screen :

- 1 Select a Music Style.

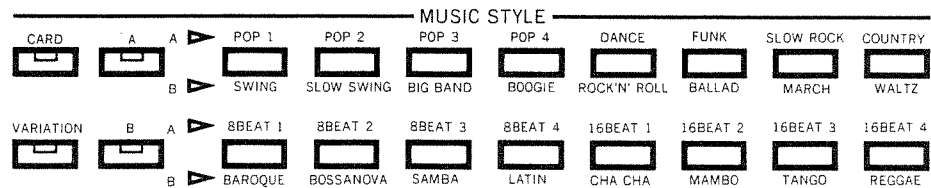

- 2 Press **SPLIT ARRANGER** in the One Touch Program section; the LED will light. That's all you have to do! The Split Point is automatically set, and everything you need for standard Style Play is ready.

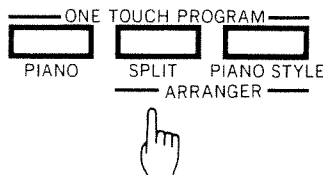

The settings depend on how long you press **SPLIT ARRANGER**.

**Just press and release it ...** The Split Point is automatically set and everything you needed for standard Style Play is ready. However, the setting of Tones, Effects and Part Balances are still the same as the current panel settings.

**Press and hold it for more than one second ...** All the settings for the Split Arranger, including Tones, Effects and Part Balances are now set for the Music Style automatically (note that these settings can not be edited or saved).

- ③ If you wish, you can change the settings of the Split Arranger.
- ④ Start Style Play by pressing any key in the Lower keyboard section.  
In the Split Arranger mode, the Music Style always starts with an Intro as soon as you press the key in the Lower keyboard section.
- ⑤ Adding Fill-In-Patterns.  
Refer to the explanation in "Playing Along with Automatic Rhythm" (⇨P.19).
- ⑥ Stop Style Play.  
Refer to the explanation in "Playing Along with Automatic Rhythm" (⇨P.20).

### b. Add Some Harmony to Your Melody- Melody Intelligence

Press **MELODY INTELLIGENCE** and the LED will light. This adds a tasteful harmony line to the melody you play with your right hand, when accompanied by Style Play. For details, see "Melody Intelligence" on page 41 of the Owner's Manual.

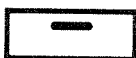

MELODY INTELLIGENCE



### c. Play the Chords with a One or Two-Finger Operation - Chord Intelligence

Press **CHORD INTELLIGENCE** and the LED will light. This enables you to play chords with just a finger or two! For details, see "Chord Intelligence" on page 38 of the Owner's Manual.





# 11. Advanced Style Play

## a. Auto Accompaniment with Full-Keyboard Chords - Piano Style Arranger (One Touch Program)

If you press **PIANO STYLE ARRANGER** in the One Touch Program section, the Piano Style Arranger settings for the Music Style you select will be made automatically.

In the Piano Style Arranger mode, there is no Split Point, so you can play chords over the entire keyboard; including full chords with the right hand. This gives you the freedom to do a little more advanced playing than with the Split Arranger.

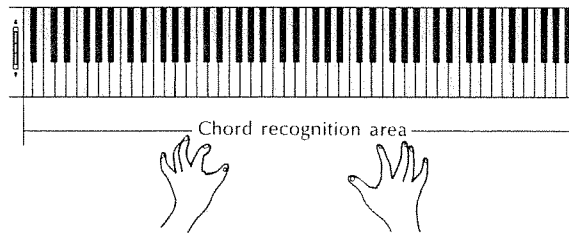

Chord Intelligence is disabled when in the Piano Style Arranger mode.

### What To Do

From the Master Screen :

- 1 Select a Music Style.

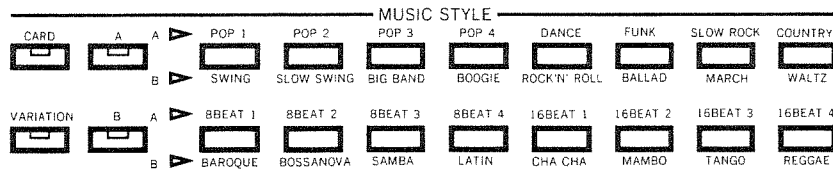

- 2 Press **PIANO STYLE ARRANGER**

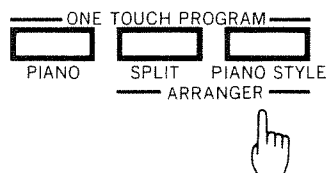

The settings depend on how long you press **PIANO STYLE ARRANGER**;

**Just press and release it ...** The settings for the Piano Style Arranger are automatically set, and everything you need for Music Style Play is ready. However, the setting of Tones, Effects and Part Balances are still the same as the current panel setting.

**Press and hold it for more than one second ...** All the settings for the Piano Style Arranger, including Tones, Effects and Part Balances are set for the Music Style automatically. (Note that these settings can not be edited or saved).

- ③ If you wish, you can change the settings of the Piano Style Arranger, such as the Upper Tone, Style Play Tempo, etc.
- ④ In the Piano Style Arranger mode, the Music Style always starts with an Intro as soon as you press any key.
- ⑤ Adding Fill-In Patterns.  
Refer to the explanation in "Playing Along with Automatic Rhythm" (P.19).
- ⑥ Stop Style Play.  
Refer to the explanation in "Playing Along with Automatic Rhythm" (P.20).

## b. Make the Lowest Note of an Inverted Chord the New Bass Note - Leading Bass

Press **LEADING BASS**. The LED will light, indicating that the Arranger will now use the lowest note of any inverted chords (Partial chords) you play as the bass note.



LEADING BASS



With the Piano Style Arranger, you can play chords using the entire keyboard. You would use this, for example, in combination with Leading Bass to play chords with the right hand and a bass line with the left.

In sheet music, an inverted chord is usually a partial chord with the lowest note clearly indicated, or a chord with the notation "on bass". The partial chord will be displayed in the KR - 4500's screen.

# 12. Recording Panel Settings

## - User Programs

The KR-4500 contains five factory User Programs. If you overwrite these with your own programs, you can always return to the factory User Programs if you follow the procedure explained below.

For more details about the five factory User Programs, see Owner's Manual page 159.

To cancel a User Program, press the same User Program button again. The User Program will now be cancelled and the panel settings before selecting a User Program will return.

### a. Calling up Settings

#### What To Do

From the Master Screen :

- 1 Just press the USER PROGRAM button corresponding to the program you wish (1) through (5).

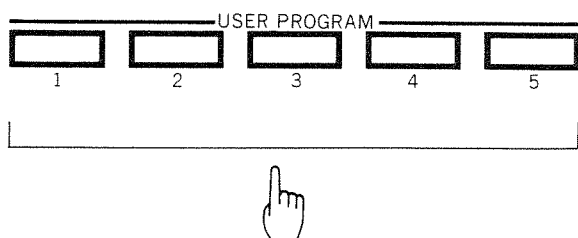

You'll see a screen like this :

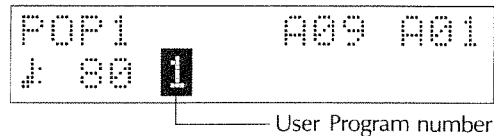

### b. Storing Panel Settings

#### What To Do

From the Master Screen :

- 1 Set up the panel as you wish it to be recorded.
- 2 Press and hold the WRITE button, then press the USER PROGRAM button corresponding to the location (1) through (5) where you wish to store this setting.

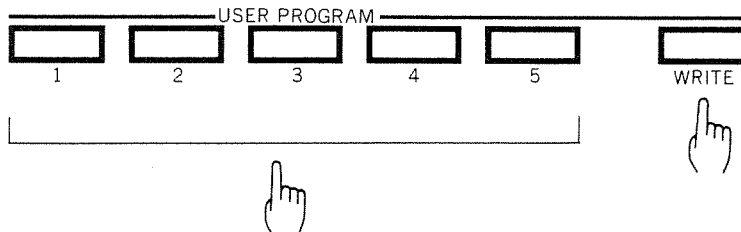

## c. Returning to the Factory Presets

### What To Do

From the Master Screen :

- ① While holding down the **LOAD** and **SAVE** buttons, press **WRITE**.

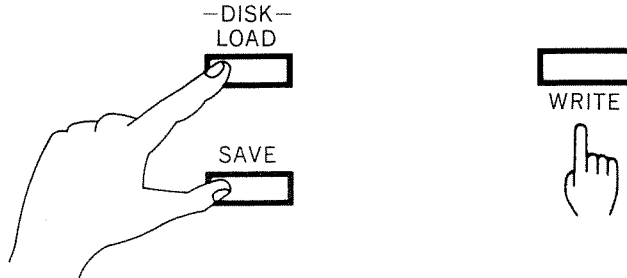

You'll see a screen like the one below, and the factory User Programs will be returned.

```
FACTORY SET UP  
LOADED
```

# 13. Recording a Style Performance and Playing it Back Later - Composer

The Composer allows you to record and play back your own Keyboard performances. In addition to the notes you play, the Composer will faithfully capture all aspects of your performance, including changes in Tone and Music Style, playing dynamics, etc.

## a. Recording a Style Performance - Recording

When you start to record, data previously stored in the selected Track will be overwritten. Data that you wish to keep must be saved onto a disk (see page 32 for more information).

### What To Do

From the Master Screen :

- ① Make all the settings for the Style you wish.
- ② Press **REC**. The **REC** LED will light and the **PLAY** LED will flash. You are now in the recording standby mode.

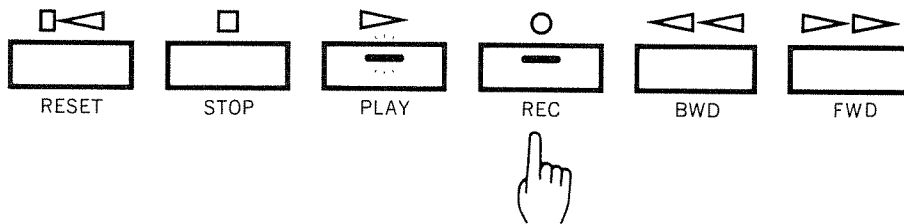

```
REPLACE REC
SI>KR-01
```

- ③ Select the Track you wish to record on.

That is, press **ARRANGER** and **UPPER 1** in the Track section so that they start flashing.

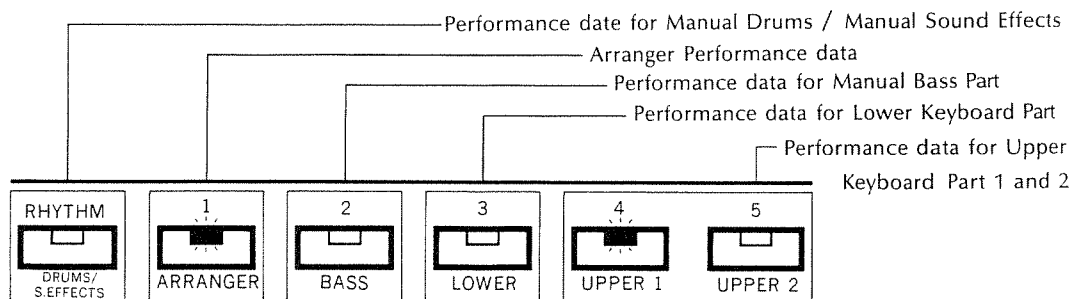

With settings as shown above, Auto Accompaniment performance data will be recorded in the Arranger Track, and Upper Keyboard performance data will be recorded in the Upper 1 Track.

The flashing LEDs indicate that this Track will be recorded. (An unlit Track button means that the Track will not be recorded.)

When recording a difficult piece, you may decrease the tempo while recording, and then increase it during playback (using the Tempo slider).

Press **PLAY**, and recording will start immediately following the two bar Intro.

Song data recorded using the Composer will be lost when the power is turned off. If you wish to store data for future use, save it onto a floppy disk (see page 32).

During Song playback, you can have the display screen indicate the Song Name, playback tempo and the current measure number, simply by pressing **PLAY**.

- ④ Set the tempo.

Adjust the tempo with the Tempo Slider or the **INC**/**DEC** buttons.

Pressing **METRONOME** at this point will allow you to hear it.

- ⑤ Start the recording. Normally, you would just press **PLAY**, and begin playing. If you are playing with the Arranger, the composer will start recording as soon as you start the Arranger. There is no need to press **PLAY**.

The recording can be started in five ways :

- Press **PLAY**.
- Press **START/STOP**.
- Press **INTRO**.
- Press **SYNC START**, and then a key in the chord recognition area of the keyboard.
- Press **INTRO** + **SYNC START**, and then a key in the chord recognition area of the keyboard.

- ⑥ When the performance is finished, press **STOP** or **RESET**.

When you have used 90% of the memory during recording, you'll see the following message in the screen :

INT.MEM.LIMIT!  
S1>KR-01

## b. Playback

### What To Do

From the Master Screen :

- ① Press **PLAY**.

Play starts immediately upon pressing the button.

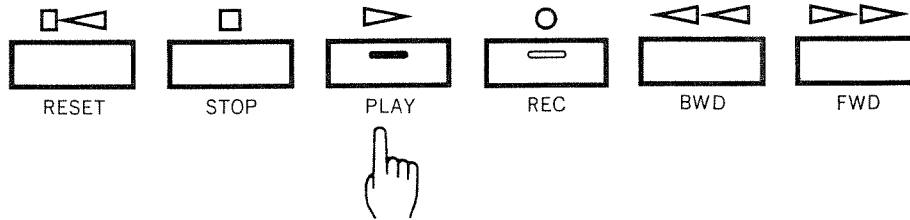

- ② When the Song playback is complete, play stops automatically. If you wish to stop during playback, press **STOP** or **RESET**.

Either **STOP** or **RESET** will stop playback, but they do it in slightly different ways :

**STOP**...Stops immediately at the measure (bar) position when the button was pressed.

**RESET**...Stops play and returns the Composer to the first measure (bar).

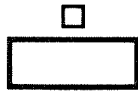

STOP



or

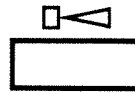

RESET



To rewind, press **BWD**. Each press of the button will rewind one measure (bar). Hold down the button for a continuous rewind.



BWD



Press **BWD** to return to the previous measures.

♩ 74 MEAS. 130  
S1>KR-01

If the Arranger Track has already been recorded, you can't move backward (forward) one bar with each press of **BWD** (**FWD**). For details, refer to the Owner's Manual on page 82.

If you press **PLAY** after rewinding, play will start from the bar number indicated in the display.

To fast forward, press **FWD**. Each press of **FWD** moves the Composer forward by one measure. Hold down the button for a continuous fast forward.

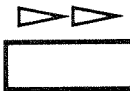

FWD



Press **FWD** to advance to the next measures.

♩ 74 MEAS. 130  
S1>KR-01

If you press **PLAY** after fast forwarding, play will start from the bar number indicated in the display.

You can change Tones and styles, or adjust tempo during playback.

## c. A Title for the Song You Have Recorded - Song Name

When recording on the KR-4500, a Song Name such as "KR-01" will automatically be assigned to each new Song you create. Should you decide that such names will be sufficient, and you do not wish to change them, you do not need to read this section.

### What To Do

From the Master Screen :

- Press **FUNCTION** in the COMPOSER Section.

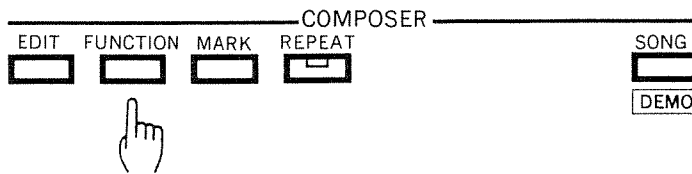

- Using **INC**/**DEC**, move onto the next screen.

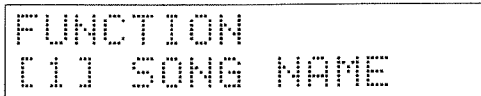

- Press **ENTER**, and the Song Name Input screen will appear.

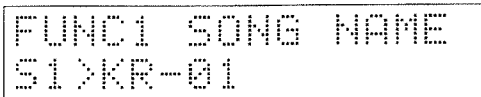
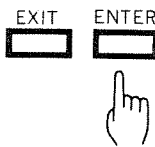

- Press the **UPPER/◀** and **A/▶** cursor buttons to move the cursor to the place you wish to enter characters.

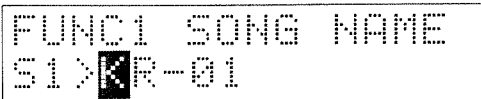

The flashing character (cursor) indicates the position where you can enter data.



Press this button to move the cursor to the left.



Press this button to move the cursor to the right.



If you wish to stop entering the name somewhere in the middle of this operation, press **EXIT** to return to the Master Screen.

- ⑤ Press **INC** or **DEC** to select the character you wish to input. The characters will be displayed in the following order :

...xyz0123456789 !" #%& ' ( ) \*+ , - . / : ; = ? ^ \_ ABCDEFGHIJKLMNOPQRSTUVWXYZabc-defghijklmnopqrstuvwxyz012...

Press **INC** to advance to the next character space, and **DEC** to return to the previous one.

- ⑥ Repeat steps ④ and ⑤ until you have completed the entire Song Name.

- ⑦ When the Song Name is complete, press **ENTER**.

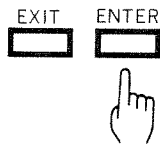

- ⑧ Press **EXIT** to return to the Master screen.

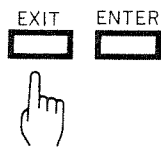

When you turn off the power, the recorded Song (and the name you just gave it) will be lost. To preserve this data, you must Save it to a floppy disk (☞P.32).

## How to delete an Unnecessary Song in the Internal Memory

This function allows the recorded Song in the Internal Memory to be deleted (If you wish to delete the performance data in the specified measures, refer to "Delete (☞ Owner's Manual P.105).")

### Operation

From the Master Screen :

- ① While holding down **REC** , press **SONG/DEMO** .

```
DELETE SONG
SURE?PRESS>ENTER
```

- ② Press **ENTER** to delete the Song. If you cancel the delete procedure at this point, press **EXIT** .

The Song will be deleted, when you press **ENTER** .

If you wish to delete another Song in the Internal Memory, see the Owner's Manual on page 120.

# 14. Create Your Own Disks

## - Save/Load

### Note :

If there is no existing data in the internal memory, disk format operation during save procedure will be disabled.

A newly purchased disk or a disk that has been used by another device cannot be used as it is. It must first be formatted before it can be used by the KR-5500. You may format the disk as a separate operation using the Disk Function. For details, see Owner's Manual page 115.

### a. Saving Performance Data to a Floppy Disk

#### - Save (Initializing a Floppy Disk - Format)

The performance data you have recorded will be erased when the power is turned off. Therefore, you must "save" it, that is, transfer it to a floppy disk before powering down. The disk you save data to should be either a 2HD (double-sided, high density) or 2DD (double-sided, double density), and be specially "formatted" ahead of time for use on the KR-4500. If you forget to format the disk, there is a way you can do so during the Save process.

At this point, let's try a Save operation with the unformatted disk (MF-2HD) that came with your KR-4500.

#### What To Do

From the Master Screen :

- ① Move the 'Write Protect' tab on the floppy disk to the "Write" or "Off" position. Insert the disk into the disk drive.

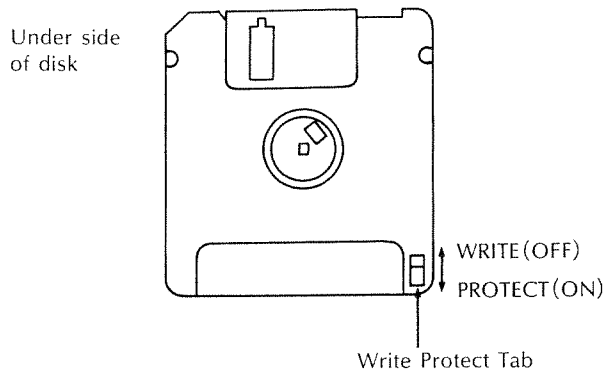

When the disk has been inserted correctly, it will click into place and the Eject button beneath the disk slot will pop out.

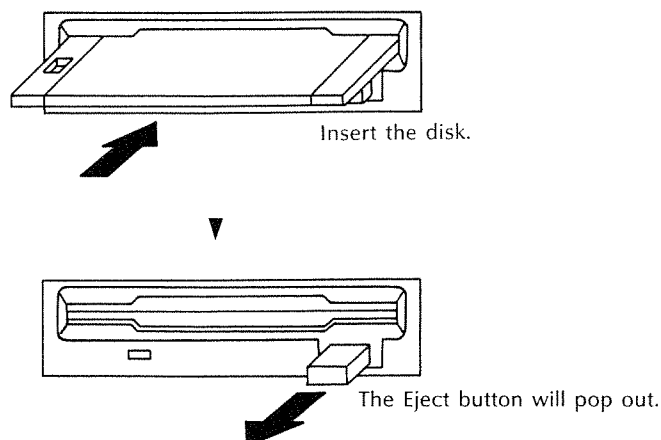

When you are using a disk that has already been formatted on the KR-4500, after you press **SAVE** in step ②, you can skip steps ③ and ④, and the screen in step ⑤ is displayed. Continue from step ⑥.

## Caution:

Never try to remove the disk from the drive while the disk drive indicator is brightly lit. (It means the drive is operating. When the indicator is dimly lit, the drive is not operating.)

- ② Press **SAVE**. The following screen will appear :

```
UNFORMATTED DISK
PRESS>EXIT
```

- ③ Press **EXIT**.

```
FORMAT DISK
PRESS>ENTER
```

- ④ Press **ENTER** to start the Format process.

```
FORMAT DISK
EXECUTING... ..
```

When formatting is complete, you'll see the following screen display for a moment before returning to the Master screen.

```
FORMAT DISK
COMPLETED
```

- ⑤ Press **SAVE** one more time.

```
SAVE SONG
S1>KR-01
```

- ⑥ Press **ENTER**. The Save process will begin as soon as you press this button.

```
SONG SAVING... ..
S1>KR-01
```

When the Save operation is complete, you'll see this screen for a moment before returning to the Master screen.

```
SAVE COMPLETED
S1>KR-01
```

- ⑦ Press the Eject button and remove the disk from the drive. Then slide the Write Protect tab to PROTECT (ON).

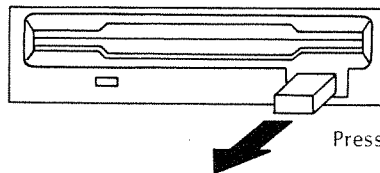

Press the Eject button.

## b. Reading the Performance Data - Load

Loading (Load) is simply the process of reading the performance data stored on a disk back into the Composer. After the process is complete, you can access and play all of the Song data.

### What To Do

From the Master Screen :

- ① Insert the floppy disk (containing the saved performance data) into the disk drive.
- ② Press **LOAD**, and a display screen will indicate the Song Numbers (which are used to identify the Song in memory) and the Song Names on the disk.

```
LOAD SONG      No 1  
S1>KR-01
```

- ③ Pressing **INC** or **DEC** scrolls across the screen, and you can select the Song you wish to Load.
- ④ When you have decided on a Song Name to Load, press **ENTER**, and the Load operation begins immediately.

```
SONG LOADING...  
S1>KR-01
```

If you pressed **ENTER**, you will see the following screen for a moment after the Load is complete. The Master Screen will then return.

```
LOAD COMPLETED  
S1>KR-01
```

- ⑤ Pressing **PLAY** will start the playback.

If there is data still in the internal memory of the KR-4500 when you proceed with step ④, you will see the following display :

```
OVERWRITE SONG  
SURE?PRESS>ENTER
```

If you are sure, press **ENTER** one more time to start the Load operation. This will delete the stored performance data (this is called "overwriting the Song memory"). However, if you wish to keep the Song which is in memory, press **EXIT** to return to the Master Screen and Save the Song data to disk. Then Load a new Song.

If you press **PLAY** instead of **ENTER** in step ④, playback will start automatically as soon as the Song has finished Loading.

# 15. Turning Off the Power

Follow this procedure when powering down :

## What To Do

- ① Check to make sure that you have indeed saved all the necessary data to disk (P.32), because when you turn off the KR-4500 you will lose all the data in the Composer.
- ② Make sure that a disk is not inserted in the disk drive. If there is, press the Eject button and remove it.
- ③ Turn the power off.

**Well done! Your KR-4500 is eagerly awaiting your next playing session!!**

If you did not use the Composer function, you don't have to check it.

# Index

Balance	14
Brillance	5
Chord Intelligence	22
Demo Songs	7
Disk Drive Indicator	33
Eject Button	3
Fast Forward	29
Fill-in	19
Format	32
Function Screen	4
Headphone	5
Layer Mode	13
Leading Bass	24
Load	34
Lower Tone(Tone for the Lower Part)	14
Manual Drums	11
Manual Sound Effects	12
Master Screen	4
Melody Intelligence	22
Metronome	20
Overwriting the Song in memory	34
Pedal	6
Piano Style Arranger(One Touch Program)	23
Pitch Bend Wheel	10
Playback	28
Recording	27
Rewind	29
Save	32
Song Name	30
Split	15
Split Arranger(One Touch Program)	21
Split Point	15,16
Style Play	17
Tone	9
Touch Sensing	6
Track	27
Upper Tone(Tone for the Upper Part)	13
User Programs	25
Volume	5
Write Protect Tab	32







# Roland





DIGITAL INTELLIGENT PIANO

---

# KR-4500

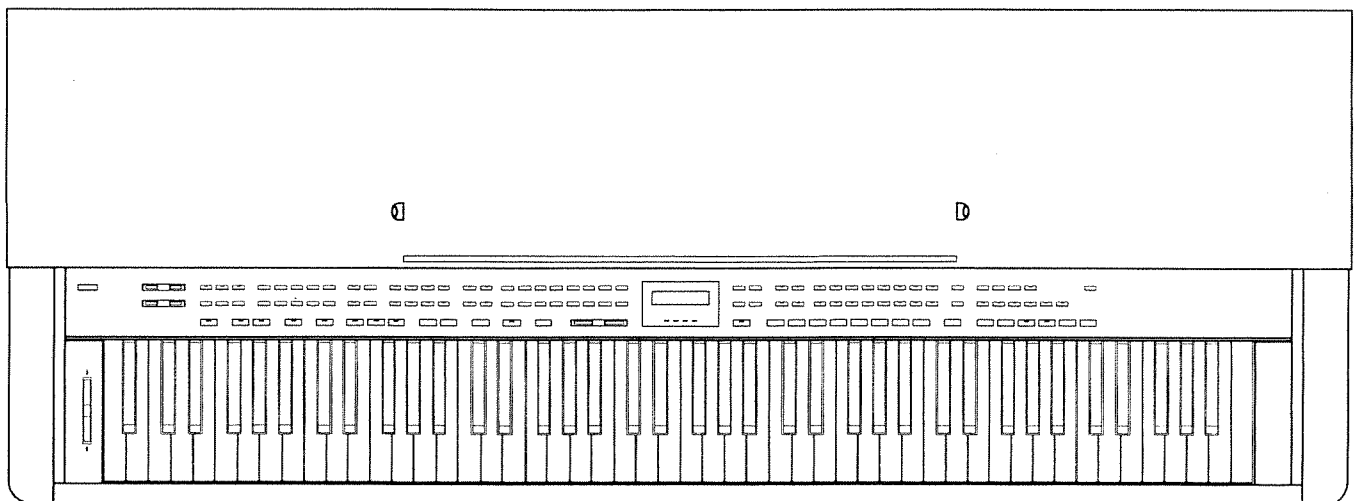
OWNER'S MANUAL



	<b>CAUTION</b> RISK OF ELECTRIC SHOCK DO NOT OPEN	
<b>ATTENTION</b> : RISQUE DE CHOC ELECTRIQUE NE PAS OUVRIR		
<p><b>CAUTION:</b> TO REDUCE THE RISK OF ELECTRIC SHOCK, DO NOT REMOVE COVER (OR BACK). NO USER-SERVICEABLE PARTS INSIDE. REFER SERVICING TO QUALIFIED SERVICE PERSONNEL.</p>		



The lightning flash with arrowhead symbol, within an equilateral triangle, is intended to alert the user to the presence of un-insulated "dangerous voltage" within the product's enclosure that may be of sufficient magnitude to constitute a risk of electric shock to persons.



The exclamation point within an equilateral triangle is intended to alert the user to the presence of important operating and maintenance (servicing) instructions in the literature accompanying the product.

INSTRUCTIONS PERTAINING TO A RISK OF FIRE, ELECTRIC SHOCK, OR INJURY TO PERSONS.

## IMPORTANT SAFETY INSTRUCTIONS

**WARNING** — When using electric products, basic precautions should always be followed, including the following:

1. Read all the instructions before using the product.
2. Do not use this product near water — for example, near a bathtub, washbowl, kitchen sink, in a wet basement, or near a swimming pool, or the like.
3. This product should be used only with a cart or stand that is recommended by the manufacturer.
4. This product, either alone or in combination with an amplifier and headphones or speakers, may be capable of producing sound levels that could cause permanent hearing loss. Do not operate for a long period of time at a high volume level or at a level that is uncomfortable. If you experience any hearing loss or ringing in the ears, you should consult an audiologist.
5. The product should be located so that its location or position does not interfere with its proper ventilation.
6. The product should be located away from heat sources such as radiators, heat registers, or other products that produce heat.
7. Avoid using the product where it may be affected by dust.
8. The product should be connected to a power supply only of the type described in the operating instructions or as marked on the product.
9. The power-supply cord of the product should be unplugged from the outlet when left unused for a long period of time.
10. Do not tread on the power-supply cord.
11. Do not pull the cord but hold the plug when unplugging.
12. When setting up with any other instruments, the procedure should be followed in accordance with instruction manual.
13. Care should be taken so that objects do not fall and liquids are not spilled into the enclosure through openings.
14. The product should be serviced by qualified service personnel when:
  - A. The power-supply cord or the plug has been damaged; or
  - B. Objects have fallen, or liquid has been spilled into the product; or
  - C. The product has been exposed to rain; or
  - D. The product does not appear to operate normally or exhibits a marked change in performance; or
  - E. The product has been dropped, or the enclosure damaged.
15. Do not attempt to service the product beyond that described in the user-maintenance instructions. All other servicing should be referred to qualified service personnel.

## SAVE THESE INSTRUCTIONS

**WARNING:** THIS APPARATUS MUST BE EARTHED

**IMPORTANT:** THE WIRES IN THIS MAINS LEAD ARE COLOURED IN ACCORDANCE WITH THE FOLLOWING CODE.  
GREEN-AND-YELLOW: EARTH, BLUE: NEUTRAL, BROWN: LIVE

As the colours of the wires in the mains lead of this apparatus may not correspond with the coloured markings identifying the terminals in your plug proceed as follows:

The wire which is coloured GREEN-AND-YELLOW must be connected to the terminal in the plug which is marked by the letter E or by the safety earth symbol  or coloured GREEN or GREEN-AND-YELLOW.

The wire which is coloured BLUE must be connected to the terminal which is marked with the letter N or coloured BLACK.

The wire which is coloured BROWN must be connected to the terminal which is marked with the letter L or coloured RED.

For the U.K.

The product which is equipped with a THREE WIRE GROUNDING TYPE AC PLUG must be grounded.

The following diagram indicates the names of things, and explains what they do.

**FRONT PANEL**

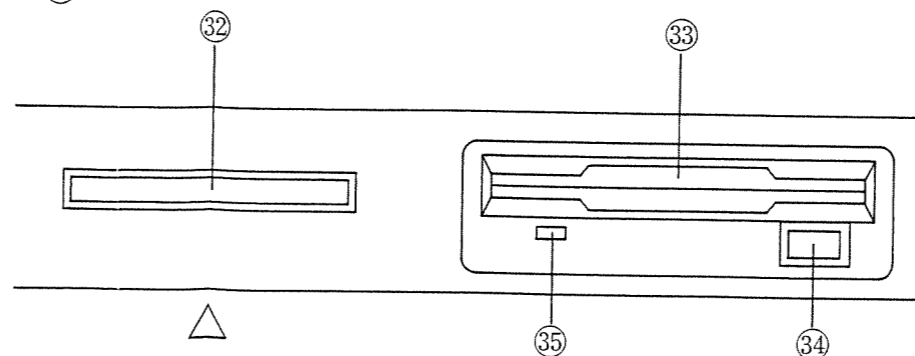
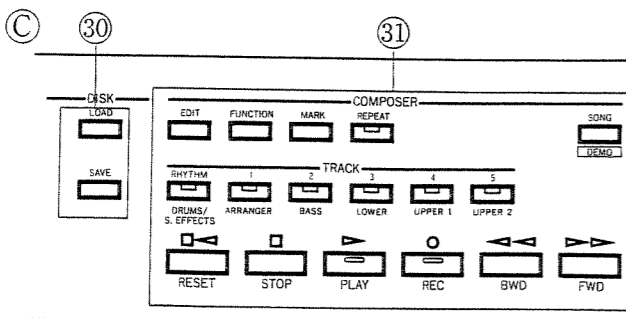
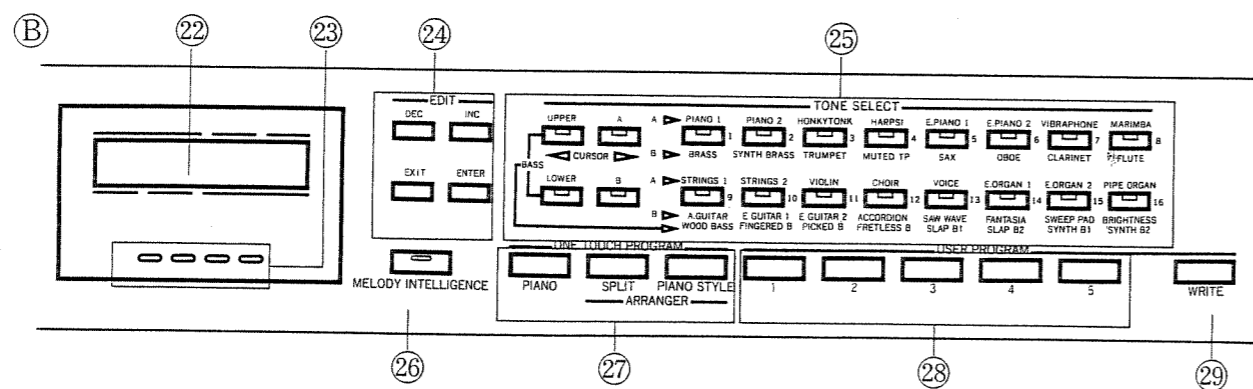
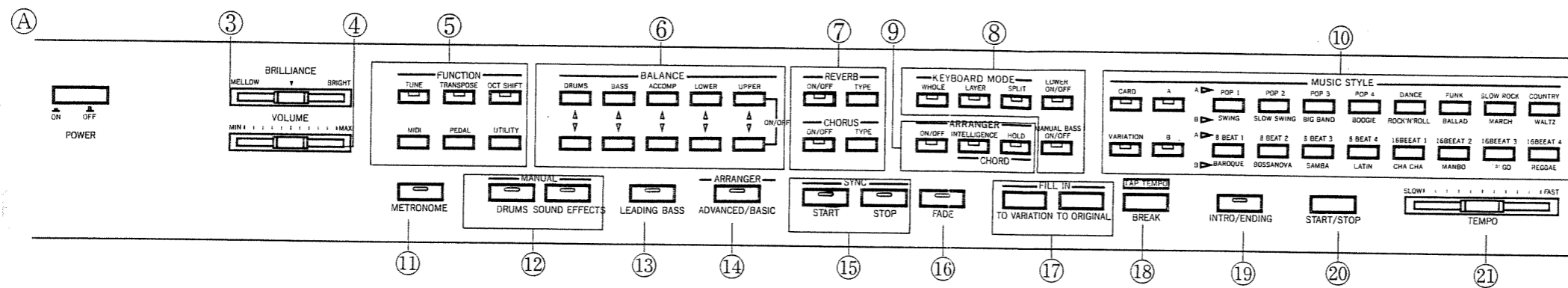
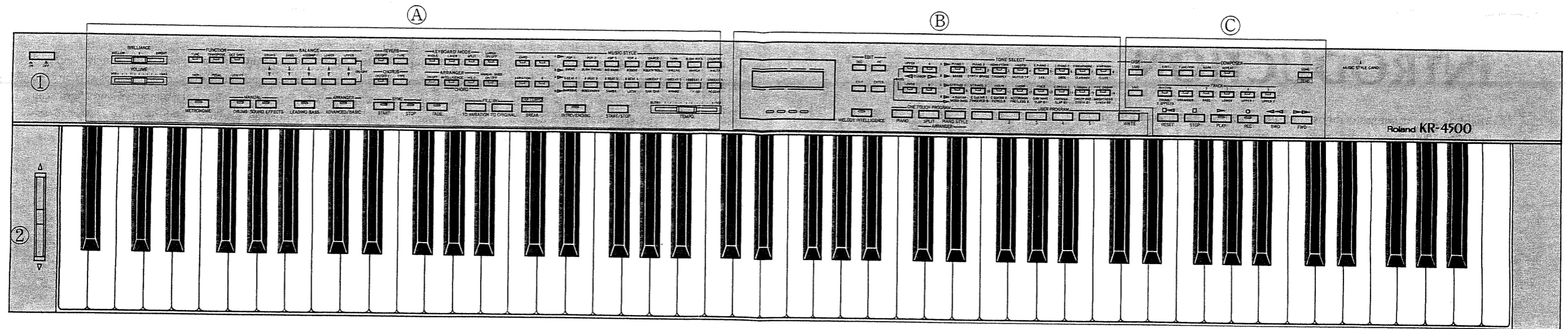

- 1. POWER Switch**  
 Turns the instrument On and Off.
- 2. PITCH BEND Wheel**  
 Allows notes to be shifted smoothly in pitch.
- 3. BRILLIANCE Slider**  
 Provides control over the instrument's tone.
- 4. VOLUME Slider**  
 Adjusts the instrument's overall volume.
- 5. FUNCTION Section (page 44)**  
 Offers a range of settings that enhance the convenience of performance.
- 6. BALANCE Section (page 57)**  
 Adjusts the volume of individual Parts.
- 7. REVERB/CHORUS Section (page 60)**  
 Provide access to effects that add presence and spaciousness to sounds played.
- 8. KEYBOARD MODE Section (page 12)**  
 Allows the keyboard to be set to a variety of modes useful for particular types of performances.
- 9. ARRANGER Section (page 34, 37, 38)**  
 Used to produce automatic accompaniment, as determined by the selected Music Style and the chord played with the left hand.
- 10. MUSIC STYLE Section (page 26)**  
 Provides selection of a Music Style.
- 11. METRONOME Button**  
 Pressed to turn on the metronome, which sounds in-time with the selected Music Style.
- 12. MANUAL CONTROL Section**  
 Allows a variety of percussive and special effect sounds to be played from the keyboard.



# INTRODUCTION

Thank you, and congratulations on your choice of the Roland KR-4500.

The KR-4500 is a keyboard instrument which is based on the same digital piano technology for which Roland has been renowned ever since it developed the world's first electronic piano. Moreover, thanks to its Arranger feature, which can create positively amazing automatic accompaniment, it represents a truly new concept in electronic keyboard instruments.

The keyboard is excellent in terms of comfort and responsiveness, features which are especially valuable during long sessions. It truly represents the successful culmination of efforts toward duplicating the feel of an acoustic piano. The keyboard is also ready for any type of solo performance, responding to a wide variety of nuances and dynamics.

In addition, the Arranger feature will allow you to become a one-person-band, thanks to automatic accompaniment employing a collection of Music Styles, which represent music from all over the world. Also included is a Composer section, which not only provides six tracks for recording and playback of the music you play, but also offers full-featured editing to allow for even greater creative possibilities. The KR-4500 thus combines a full range of advanced features with an operational ease that was designed from a piano player's point of view. It is sure to please everyone, from those starting their first lessons, to seasoned professionals.

In order to enjoy reliable performance for many years to come, please take the time to read this manual in its entirety.

©1992 by Roland Corporation

All rights reserved. No part of this publication may be reproduced in any form without the permission of Roland Corporation.

## FEATURES

### ● Provides Realistic Instrument Sounds

With 40 different types of high quality, authentic sounds, the instrument can fit in readily with any genre of music. Additionally, using the Tone Expansion Mode, the number of sounds put at your fingertips can be increased to 128. Moreover, a selection of sounds other than instrument sounds can also be played from the keyboard, including 61 percussive sounds, and 46 special effects sounds (laughing voices, applause, sirens, etc.).

The ordering and the settings for all of the instrument sounds can, of course, be set to conform to the GS Format.

### ● Music Styles : Music from Around the World

The instrument provides a collection of 32 Music Styles, containing the essential elements of a wide range of musical styles from around the world, including ethnic music as well as the hottest new popular styles. (To ensure that these styles are authentic, they were produced in the country or region where the style originates, whenever feasible.) Moreover, by employing the Music Style Expansion Mode, you can select from 64 Music Styles. (Of these, there are 8 which are beautifully simple, and work very well as backing for piano pieces.)

Additionally, simply by inserting optionally available Music Style Cards or Music Style Super Cards, you can further your potential for playing almost any type of music imaginable.

### ● Equipped with an "Arranger" for the Best in Automatic Accompaniment

The Arranger feature automatically produces the appropriate musical accompaniment based on the selected Music Style and specified chord progression. Alternate patterns for an accompaniment can be easily obtained by pressing the Intro, Ending, Fill-In, or Break pattern buttons. Moreover, the result obtained will change depending on the chord progression that has been played, so with a little imagination, a single Music Style can provide a great deal of variety.

● The Arranger Accommodates Traditional Piano Playing Styles

The automatic accompaniment that has been provided by other keyboards divided the keyboard into a melody (upper) section, and an accompaniment (lower) section. All chords could only be played in the accompaniment section. The Arranger on the KR-4500, however, no longer requires that the keyboard be divided in such a manner, and chords can be selected from anywhere on the keyboard. It thus allows for performances which conform more closely to the traditional playing style of the piano.

● Leading Bass Feature Accommodates Inverted Chords

Using the Leading Bass Feature, the lowest note of an inverted chord can be recognized as the bass note by the Arranger when playing chords for automatic accompaniment.

● "User Programs" Provide One-touch Recall of Panel Settings

Once you store a collection of settings for sounds, Music Styles, or how the Arranger is to be used, they can be instantly recalled simply by pressing a button. Up to five such User Programs can be stored.

● The Composer Provides for Recording, Editing and Playback

The onboard Composer is a full-featured, 6 track music sequencer, equipped with a 3.5 inch floppy disk drive for storage.

In addition to the basic features of recording and playback of music you play, it also allows you to use the Arranger to first record an accompaniment part, and then have that played back while you play the melody. The results you can obtain are much like what is obtained when using a multi-track recorder.

Moreover, since quantization, copying, and other editing features are included, you can lay down some interesting multi-track data, consisting of a rhythm, bass, and sub-melody sections, without even using the Arranger.

Additionally, the floppy disk drive provides for the convenient storage of the performance data, as well as the contents of the User Programs.

● The KR-4500 is Supported by a Wealth of Music Software

Since the KR-4500's Composer is compatible with Standard MIDI Files (playback only) and Ism Music Data a great volume of software is available for the hobbyist, student, or music lover.

Concerning the KR-4500's sound sources

---



The sound source within the KR-4500 can be set to conform to the GS Format.



The GS Format conforms to General MIDI System -Level 1 specifications.

Concerning the KR-4500's sequencer (Composer)

---



The KR-4500 is capable of playing "ISM Music Data" (3.5 inch floppy disks).



The KR-4500 is capable of playing Standard MIDI Files, such as "SMF Music Data" (720KB/1440KB format 3.5 inch floppy disks).

### 13. LEADING BASS Button (page 39)

Allows the lowest note of the chord currently played to be used as the bass note.

### 14. ARRANGER Button (page 35)

Provides selection between a relatively simple performance (BASIC) and one more complicated (ADVANCED).

### 15. SYNC START / STOP Section (page 29)

Allows Music Styles to be started or stopped from the keyboard.

### 16. FADE Button (page 30)

Used to produce fade-ins and fade-outs.

### 17. FILL IN Section (page 36)

Allows exciting fill-ins to be added to a performance.

### 18. BREAK Button (page 37)

Allows a break to be inserted into a performance.

### 19. INTRO / ENDING Button (page 29)

Allows intros and endings to be inserted into a performance.

### 20. START / STOP Button (page 29)

Used to start or stop a performance.

### 21. TEMPO Slider (page 32)

Provides adjustment of the tempo of playback or recording.

### 22. Display

Provides display of a range of useful information.

### 23. Beat Indicator (page 34)

The four indicators show which beat of the measure is being played at the moment.

### 24. EDIT

Employed to make settings for a wide range of features.

### 25. TONE SELECT Section (page 16)

Provides for selection of the Tones for the Upper, Lower, and Manual Bass Parts.

### 26. MELODY INTELLIGENCE Button (page 41)

Allows a harmony part to be added to the melody played.

### 27. ONE TOUCH PROGRAM (page 21)

Allows for instantaneous selection of a desired setup, regardless of what mode you are in.

### 28. USER PROGRAM (page 68)

Provides for storage of 5 separate collections of panel settings.

### 29. WRITE Button

Used to save/load User Programs.

### 30. DISK Section (page 83)

Used to store performance data (or the contents of User Programs) onto floppy disks. Also used to load data stored on floppy disks back into memory.

### 31. COMPOSER Section (page 72)

Provides for the recording, editing, and playback of performance data.

### 32. Music Style Card Slot (page 28)

Accepts a Music Style Card (optional TN-SC Series) or Super Music Style Card (optional MSL-15). Once inserted, you gain access to a greater number of Music Styles.

### 33. Disk Drive (page 76)

Provides for the storage/playback of performance data. The drive accepts both 2HD and 2DD format 3.5 inch floppy disks.

### 34. EJECT Button (page 76)

Pressed when you want to eject the floppy disk.

### 35. Disk Drive Indicator (page 76)

Lights when the disk drive is operating.

## CAUTION!

Never remove the disk from the drive, or turn the power off, while the drive indicator is lit. To do so could result in damage to the disk (and data) or the drive.

## REAR PANEL

### ○ OUTPUT Jacks (page 122)

If connected with a keyboard amp or stereo system, the instrument's sound can be enjoyed at an even greater volume. These jacks can also be used to connect with a tape recorder should you wish to record your music.

### ○ INPUT Jacks (page 124)

Other devices you are using, such as a synthesizer or rhythm machine, can be connected here when you wish to hear them played through the KR-4500's speakers.

### ○ Expression Pedal Jack (page 124)

Accepts connection of an optional foot pedal (EV-5; available separately). Once connected, you gain pedal control over the instrument's overall volume.

### ○ MIDI Connectors (IN/OUT/THRU) (page 125)

Provide for the exchange of performance information with an external MIDI device (or computer).

## PEDALS

### ○ Left Pedal Acts as a soft pedal.

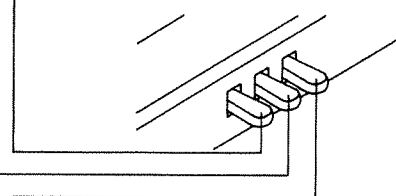

### ○ Right Pedal Acts as a damper pedal.

### ○ Center Pedal Acts as a sostenuto pedal.

\*The Center Pedal and Left Pedal can also be used for other types of control, if set to do so (Pedal page 48).

## Important Notes

In addition to the items listed under Safety Precautions inside the front cover, please read and adhere to the following :

### Power Supply

- When making any connections with other devices, always turn off the power to all equipment first; this will help prevent damage or malfunction.  
Do not use this unit on the same power circuit with any device that will generate line noise, such as a motor or variable lighting system.
- Avoid damaging the power cord; do not step on it, place heavy objects on it etc.

### Placement

- Make sure the instrument rests on a flat surface. Setting it on a tilted or uneven surface may result in the keys not functioning properly or the cover not opening or closing smoothly. It may also adversely affect the operation of the disk drive.
- This unit may interfere with radio and television reception. Do not use this unit in the vicinity of such receivers.
- Observe the following when using the unit's disk drive. For further details, refer to "Before Using Disks".
  - Do not place the unit near devices that produce a strong magnetic field (eg. loudspeakers).
  - Install the unit on a solid, level surface.
  - Do not move the unit or subject it to vibration while it is operating.

### Maintenance

- For everyday cleaning wipe the unit with a soft, dry cloth (or one that has been slightly dampened with water). To remove stubborn dirt, use a mild neutral detergent. Afterwards, be sure to wipe the unit thoroughly with a soft, dry cloth.
- Never use benzene, thinners, alcohol or solvents of any kind, to avoid the risk of discoloration and/or deformation.

### Additional Precautions

- Protect the unit from strong impact.
- Do not allow objects or liquids of any kind to penetrate the unit. In the event of such an occurrence, discontinue use immediately. Contact qualified service personnel as soon as possible.
- Before using the unit in a foreign country, consult with qualified service personnel.
- Should a malfunction occur (or if you suspect there is a problem) discontinue use immediately. Contact qualified service personnel as soon as possible.

### Before Using Disks

- Avoid using the drive in areas of high humidity (eg. condensation). High levels of moisture can adversely affect the operation of the drive and/or damage disks. When the unit has been transported, allow it to warm to room temperature before operating.
- To insert a disk, push it firmly into the drive. To remove a disk, press the eject button firmly. Do not use excessive force to remove a disk which is lodged in the drive.
- Never remove a disk from the drive while it is operating; damage could result to both the disk and the drive.
- Before powering up or powering down, remove any disk from the drive.
- Disks contain a plastic disk coated with magnetic particles. Observe the following when handling disks :
  - Never touch the magnetic surface of the disk.
  - Do not subject disks to temperature extremes (eg. direct sunlight in an enclosed vehicle). Recommended temperature range : 10 to 50°C.
  - Do not expose disks to strong magnetic fields such as those generated by loudspeakers.
- Floppy disks contain a 'write protect' switch which can protect a disk from accidental erasure. It is recommended that the switch be kept in the 'protect' position and moved only when you wish to write new data onto the disk.

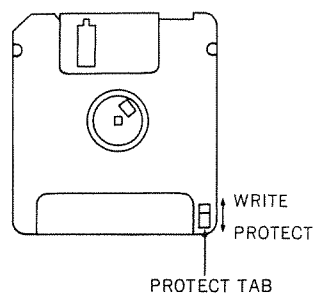

- All important data should be copied onto backup disks. This provides a complete duplicate of the data should the original disk be lost or damaged.
- Identification labels should be firmly fixed to the disks. Should a label come loose while the disk is in the drive, it may be difficult to remove the disk.

### Memory Backup

- Please be aware that the contents of memory may at times be lost when the unit is sent for repairs or when by some chance a malfunction has occurred. Important data should be stored on a floppy disk. During repairs, due care is taken to avoid the loss of data. However, in certain cases (such as when circuitry related to memory itself is out of order), we regret that it may be impossible to restore the data.



## Check the parts

Ⓢ Before you begin assembly, check that you have all the following parts.

- (A) Side board (left) ..... 1
- (B) Side board (right) ..... 1
- (C) Pedal board ..... 1
- (D) Rear board ..... 1
- ① Short screws (M4 × 25 mm) ..... 2
- ② Medium-length screws (M6 × 35 mm) ..... 6
- ③ Long screws (M6 × 70 mm) ..... 4
- ④ Joint nuts ..... 6
- ⑤ Knob bolts ..... 4
- ⑥ Phillips screwdriver ..... 1

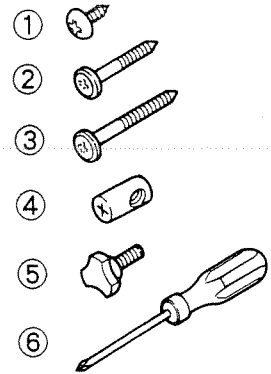
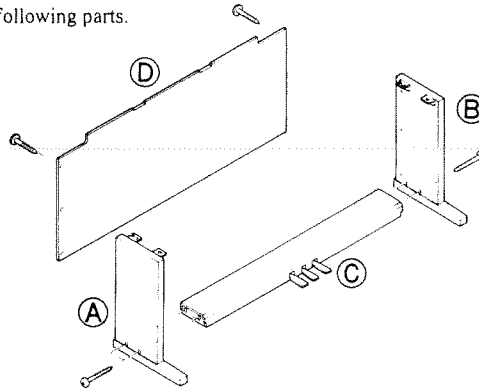

## Assembly procedure

### 1 Attach the side boards (left and right) to the pedal board

Note 1: Be sure that the side boards are oriented correctly; the metal fittings are on the inside.

Note 2: When attaching the side boards, be careful not to pinch the pedal cable.

- ① Use the long screws (M6 × 70 mm) to fasten the side boards (left and right) to the pedal board.

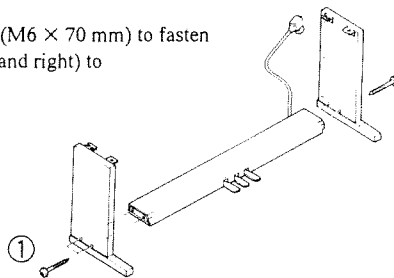

### 2 Attach the joint nuts and fasten the pedal cable

- ② Insert the six joint nuts into the side boards (three joint nuts for each side), making sure that the longer groove (arrow groove) of the joint nut's "+" groove is set horizontally. (Use a screwdriver for adjustment.)
- ③ Put the pedal cable in the groove on the back of the side board (right).

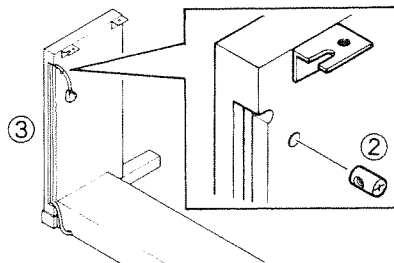

### 3 Attach the rear board

Note 3: When attaching the rear board, be careful not to pinch the pedal cable.

- ④ Use the six medium-length screws (M6 × 35 mm) to fasten the rear board to the backs of the side boards.
- ⑤ Then use the two short screws (M4 × 25 mm) to fasten the rear board to the pedal board.

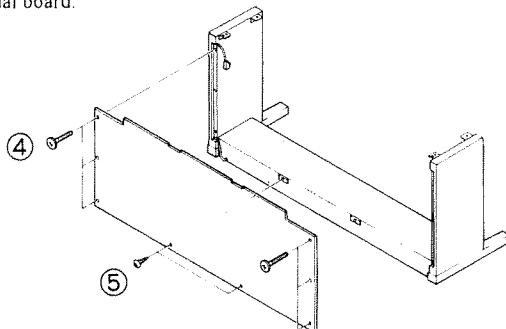

### 4 Attach the piano to the stand and plug in the pedal cable

Note 4: When placing the piano on the stand, be careful not to pinch your fingers. (Avoid holding the ends of the piano.)

- ⑥ Align the screws (one on each side) located on the bottom of the piano with the slots in the metal fittings on the side boards. Slide the piano so the screws slide into the slots.
- ⑦ After securing the piano to the metal fittings of the side boards, use the knob bolts to fasten the piano to the stand (use two knob bolts for each side).
- ⑧ Plug the pedal cable into the receptacle on the right side of the bottom of the piano. (Be careful with the orientation of the receptacle.)

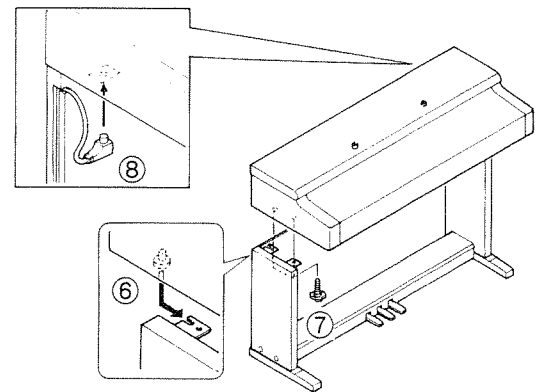

### 5 Plug in the power cable and adjust the adjuster

Note 5: When placing the piano in its location, be sure not to pinch the power cable underneath the piano.

Note 6: If the piano is placed on carpeting, rotate the adjuster so that it extends to secure the stand.

- ⑨ Plug the power cable into the receptacle on the left side of the back of the piano.
- ⑩ Attach the music rest to piano.
- ⑪ When you finish placing the piano, rotate the adjuster until it completely touches the floor. (Rotate it to the right to extend it, and to the left to retract it.)

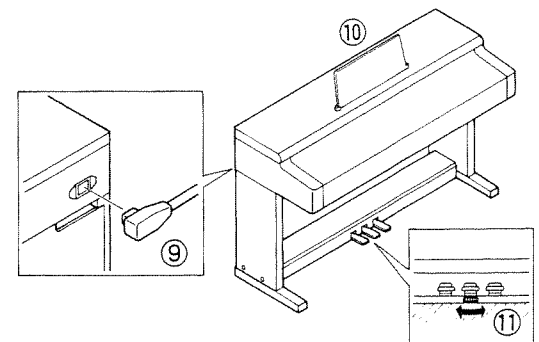

# SETUP

Be sure that you have the instrument fixed securely to the stand. Place the instrument on a solid, level surface.

## Music Rest

A music rest is included in the cardboard box your instrument came in. It should be attached as shown in the illustration.

- 1 While holding the music rest horizontally, slide it into the holder.

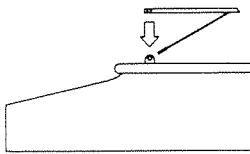

- 2 Raise the music rest.

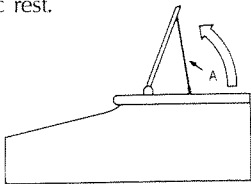

- ⚠ When tilting the rest to the rear, make sure you firmly grasp A and the rest as shown in the illustration.

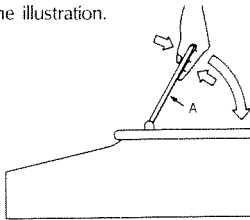

## Concerning the Cover

To open the cover, hold it with both hands and slide it to the rear.

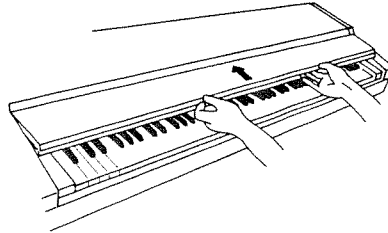

- ⚠ Be careful not to get your fingers caught when opening or closing the cover. To close the cover, slowly pull it forward until it stops. Raise it briefly, and then gently lower it into place. Adult supervision may be necessary whenever small children are using the instrument.
- ⚠ Never close the cover while you have sheet music or anything else lying on the keyboard.

## Transporting the Instrument

First, remove the music stand and disconnect the power cord. Then retract the stand adjuster. Two people can then carefully move the instrument.

## Connecting the Power Cord

- 1 Check to make sure that the POWER switch on the panel's left side is OFF.
- 2 Connect the supplied power cord to a household power outlet.

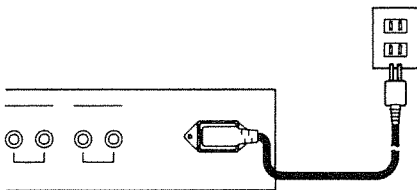

- ⚠ Use only the power cord that is supplied with the unit. Whenever the instrument is not going to be played for an extended period of time, disconnect the power cord from the outlet.

## Affixing the Labels to the Keyboard

Find the set of keyboard labels which are taped to the inside of the unit's cardboard container. Remove the protective backing from the labels and affix them to the keyboard as shown below.

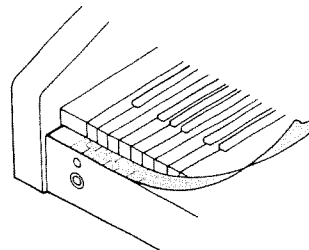

- ⚠ Affix the sticker so it is aligned with the Keyboard's left edge. Be sure to attach the sticker securely.

■ INTRODUCTION .....	1
■ FEATURES .....	1
■ PANEL DESCRIPTIONS .....	3
FRONT PANEL .....	3
REAR PANEL .....	5
PEDALS .....	5
■ IMPORTANT NOTES .....	6
■ How to assemble the Roland KRS-4500 piano stand .....	7
■ SETUP .....	8
Music Rest .....	8
Concerning the Cover .....	8
Transporting the Instrument .....	8
Connecting the Power Cord .....	8
Affixing the Labels to the Keyboard .....	8

### 1. Playing Ensembles

1. Changing the Keyboard Mode .....	12
a. Whole .....	12
b. Layer .....	12
c. Split .....	13
d. Split + Layer .....	15
2. Selecting Tones .....	16
a. Upper Tone .....	16
b. Lower Tone .....	17
c. Manual Bass Tone .....	17
3. Concerning Chords .....	19
a. The Root and Other Constituent Notes .....	19
b. Reading Note Names .....	20
c. Chord Inversions .....	21
4. One-Touch Program .....	21
a. Piano Mode .....	22
b. Split Arranger Mode .....	22
c. Piano Style Arranger Mode .....	22

### 2. Having Fun with Various Styles of Music

1. What are Music Styles? .....	24
2. What is the Arranger? .....	25
3. What is Style Play? .....	25
4. Selecting a Music Style .....	26
a. Selecting Music Styles from the Main Unit .....	26
b. Selecting Music Styles from a Music Style Card .....	28
5. Starting and Stopping the Music Styles .....	29
a. Starting .....	29
b. Stopping .....	30
6. Fade-in/Fade-out of Music Styles .....	30
a. Fade-In .....	30
b. Fade-Out .....	32
7. Adjusting the Tempo .....	32
a. Tempo Slider .....	32
b. INC/DEC .....	33
c. Tapping Tempo .....	33
d. Beat Indicator .....	34
8. Arranger ON/OFF .....	34

9. Types of Arrangements .....	35
a. Arranger Button (Basic & Advanced) .....	35
b. Variation Button (Original & Variation) .....	35
10. Fill-Ins .....	36
a. Fill-In to Variation .....	36
b. Fill-In to Original .....	36
11. Breaks .....	37
12. Chord Hold .....	37
13. Chord Intelligence .....	38
14. Leading Bass .....	39
15. Melody Intelligence .....	41

### 3. Enhancing Your Playing Technique

1. Function Settings .....	44
a. Master Tune .....	44
b. Transpose .....	45
c. Octave Shift .....	46
d. MIDI .....	48
e. Pedal .....	48
f. Pitch Bend Range .....	50
g. Repeat Note (Arpeggio) .....	52
h. Keyboard Sensitivity .....	53
i. Contrast .....	54
j. Metronome Level .....	55
k. GS Mode .....	56
2. Adjusting the Level of Each Part .....	57
a. Upper Part .....	58
b. Lower Part .....	58
c. Accompaniment Part .....	59
d. Bass Part .....	59
e. Drum Part .....	60
3. Adding Spaciousness to Sounds .....	60
a. Applying Reverberation .....	60
b. Adding a Feeling of Spaciousness to Sound ~ Chorus .....	63
4. Tone Expansion Mode .....	
~ Increasing the Number of Tones You Can Use. ...	65
5. Music Style Expansion Mode .....	
~ Increasing the Music Styles You Can Use .....	67
6. Storing a Group of Panel Settings .....	68
a. What is a User Program? .....	68
b. Calling up User Programs .....	69
c. Storing Panel Settings .....	69
d. Factory Setup .....	70

### 4. Composer

1. Overview .....	72
a. What is the Composer? .....	72
b. Internal Memory and Floppy Disks .....	72
c. Disk Drive .....	73
d. Tracks .....	73
e. Song .....	74
f. Multi-Track Recording .....	
~ The Composer versus Multi-Track Tape Recorders	75

2. Floppy Disks .....	76
a. Formatting Disks (Initialization) .....	76
b. Formatted Disk Capacity .....	77
c. Disk Write Protect Tab .....	77
3. Recording .....	78
a. Recording Your Style Play .....	78
4. Playback .....	81
a. Playing Back Song Data .....	81
b. Rewind (BWD) .....	81
c. Fast-Forward (FWD) .....	82
d. Changing the Playback Tempo with the Tempo Slider .....	82
e. Muting Tracks During Playback ~ Track Mute .....	82
f. Repeat-Playback .....	83
5. Save/Load .....	83
a. Giving the Song a Name ~ Song Name .....	83
b. Storing the Data on a Floppy Disk ~ Save (Initializing the Floppy Disk ~ Format) .....	85
c. Reading the Performance Data ~ Load .....	86
6. Working with the Internal Memory .....	87
a. Song and Song Number .....	87
b. Selecting a Song Number and Recording .....	88
c. Selecting a Song Number and Saving .....	89
d. Selecting a Song Number and Loading .....	91
7. Advanced Recording Techniques .....	93
a. Replace Recording .....	94
b. Mix Recording .....	95
c. Pedal Punch-In Recording .....	96
d. Auto Punch-In Recording .....	97
8. Editing a Song .....	98
a. Quantize .....	98
b. Erase .....	100
c. Insert Measure .....	102
d. Copy .....	103
e. Delete .....	105
9. Moving to Selected Points in a Song .....	106
a. Mark Point .....	106
b. Specifying Measures Using Mark Points .....	107
c. Song Position ~ FWD (Fast-Forward) and BWD (Rewind) .....	108
d. Song Position Jump .....	109
e. Checking the Tempo/Song Position/Song Number/Song Name .....	109
10. Functions .....	110
a. Giving a Song a Name ~ Song Name .....	110
b. Setting the Standard Tempo for a Song ~ Basic Tempo .....	111
c. Turning Count-In On/Off .....	112
d. Setting a Repeat Play Range ~ Block Repeat .....	113
e. Setting the Auto Punch-In Range ~ Punch-In Point .....	114
11. Disk Functions .....	115
a. Initializing a Floppy Disk ~ Format .....	115
b. Delete Song Files ~ Delete File .....	116
c. Delete User Program Files ~ Delete File .....	117

12. User Program .....	118
a. Saving Your User Programs to Disk .....	118
b. Loading the Setting for a User Program .....	119
A Few Extra Tips Useful for Using the Composer .....	119

## 5. Connecting with Other Equipment

1. Using Connectors .....	122
a. OUTPUT Jacks .....	122
b. INPUT Jacks .....	124
c. Expression Pedal Jack .....	124
2. Using MIDI .....	125
a. What is MIDI? .....	125
b. Devices that can be Connected Using MIDI .....	125
c. MIDI Connectors and Cables .....	125
d. Making the Connections .....	126
e. MIDI Channels .....	127
f. Types of Data Handled Over MIDI .....	128
g. Concerning MIDI Implementation Charts .....	129
3. Settings for MIDI Functions .....	130
a. MIDI Settings for the KR-4500 .....	130
b. MIDI Channel .....	130
c. MIDI Sync Mode .....	133
d. MIDI Rx Start/Stop .....	134
e. MIDI Local Control .....	135
f. Arranger MIDI Out Switch .....	135
g. Composer MIDI Out Switch .....	136

## 6. Appendix

■ About General MIDI and GS Compatibility .....	138
a. What are "General MIDI System" and "GS Format" ? .....	138
b. Main Features when the GS Mode is On .....	139
c. How the Panel Functions when the GS Mode is On .....	139
■ Playback of Standard MIDI Files .....	140
a. What are Standard MIDI Files? .....	140
b. About Roland's "SMF Music Data" Collection .....	140
c. Playback of Roland SMF Music Data .....	141
d. SMF Channel Mute .....	142
e. SMF Channel Volume .....	143
f. Changing MIDI Channels .....	143
g. SMF Data Created on Other Devices .....	144
■ Troubleshooting .....	146
a. Before you Consider the Machine to be Malfunctioning .....	146
b. Error Message List .....	148
■ Expansion Tone List .....	152
■ GS Tone List .....	153
■ Drum Set List .....	156
■ Music Style List (Expansion Mode) .....	158
■ User Program List .....	159
■ MIDI Implementation Charts .....	162
■ Specifications .....	166
■ Index .....	167

**1**



**Playing  
Ensembles**

# 1. Changing the Keyboard Mode

Even though the KR-4500 has only one keyboard, it is capable of providing a number of Parts which play separately. The Keyboard Mode is a function which allows you to determine which Tones are to be assigned to particular Parts, and how they are to be played from the keyboard.

The Keyboard Mode is selected using the 5 buttons in the Keyboard Mode Section. With each press of a button it is either turned on or off, and its indicator lights or goes out accordingly.

Concerning the method used for changing Tones, refer to "2. Selecting Tones" (page 16).

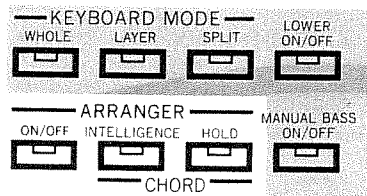

## a. Whole

After pressing **WHOLE** and confirming that its indicator is lit, you will be able to use the whole keyboard to play the sound (Upper Tone) that has been specified for the Upper Part. The Whole mode is the mode that is normally available after the power has been turned on.

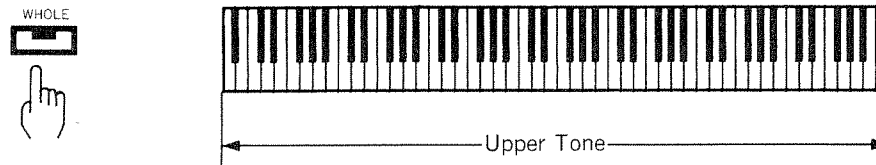

## b. Layer

When you press **LAYER** (its indicator will light), the indicator for **LOWER** will also automatically light. Thereafter, the keyboard will layer that which has been specified for the Upper Part (Upper Tone) along with that which has been specified for the Lower Part (Lower Tone) and both will be sounded.

When the indicator on **WHOLE** is lit.

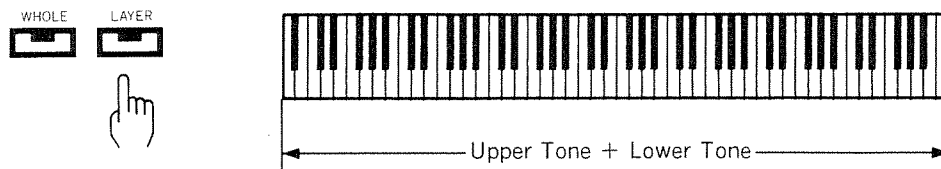

When the indicator on **(SPLIT)** is lit.

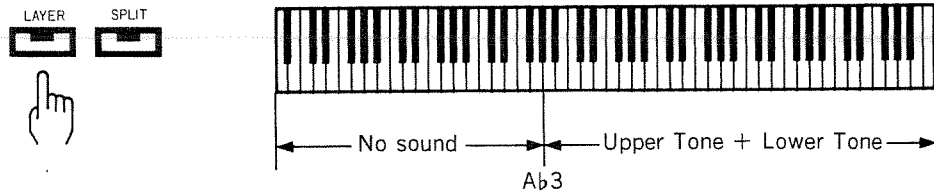

## c. Split

When you press **(SPLIT)** (its indicator will light), the indicator for **(LOWER)** will also automatically light. Thereafter, you will be able to play separate sounds in the keyboard's Upper and Lower ranges.

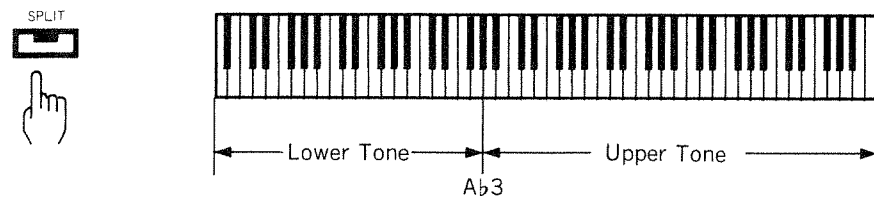

"Lower" refers to the keyboard's lower range zone, whereas "Upper" refers to the higher zone. The particular key which is at the boundary between these two zones is referred to as the "Split Point." (The key acting as the Split Point sounds as part of the Lower zone.)

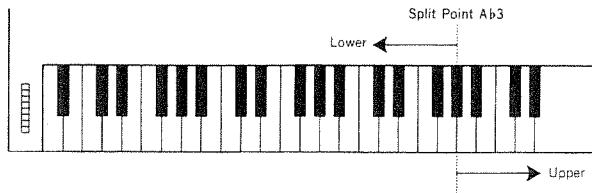

The Upper section will sound using the Upper Tone. The Lower section will sound using the Lower Tone, Manual Bass Tone, or both.

The following four choices as to what the Lower section will play are available :

- Sound the Lower Tone**

With the indicator on **(SPLIT)** already on, press **(LOWER)** and confirm that its indicator is lit.

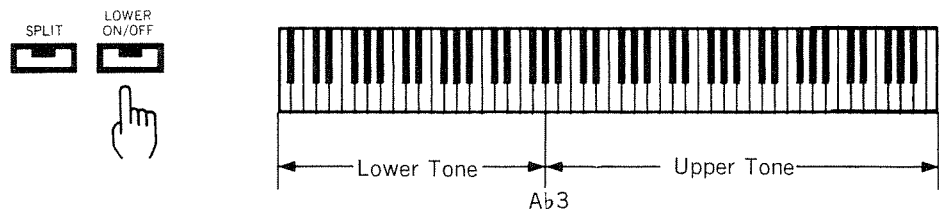

When you press **(LOWER)** to turn off the light when the **(SPLIT)** indicator is lit, the **(LOWER)** indicator will not be illuminated ever if **(SPLIT)** is pressed again. If this happens, press **(LOWER)** again to turn on the light.

While in this state, if you turn the Arranger ON, and start a Music Style, the Lower Tone will sound except during the Intro and Ending.

While in this state, if you turn the Arranger ON, and start a Music Style, the indicator on **MANUAL BASS** goes out automatically, and the Manual Bass Tone will not sound while the Style is playing. (It can be played again once the Style has finished, however.)

The Manual Bass Tone can only be sounded when the Arranger is OFF. Once you start an Arranger rhythm, the indicator on **MANUAL BASS** goes out automatically, and the Manual Bass Tone no longer sounds (see page 17).

### ○ Sound the Manual Bass Tone

With the indicator on **SPLIT** already on, press **MANUAL BASS** and confirm that its indicator is lit.

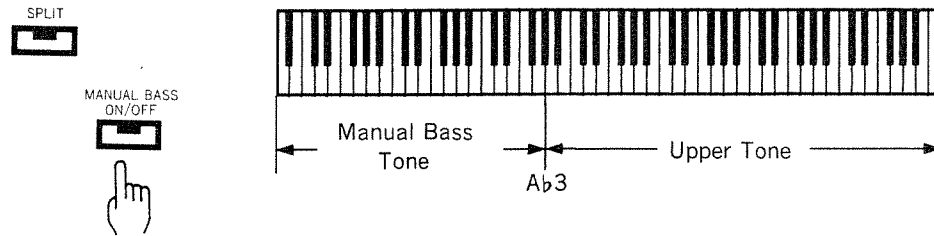

### ○ Sound both the Lower Tone and the Manual Bass Tone

With the indicator on **SPLIT** already on, press both **LOWER** and **MANUAL BASS** and confirm that their indicators are lit.

Thereafter, all chords played in the Lower section will sound using the Lower Tone, with the root of such chords using the Manual Bass Tone.

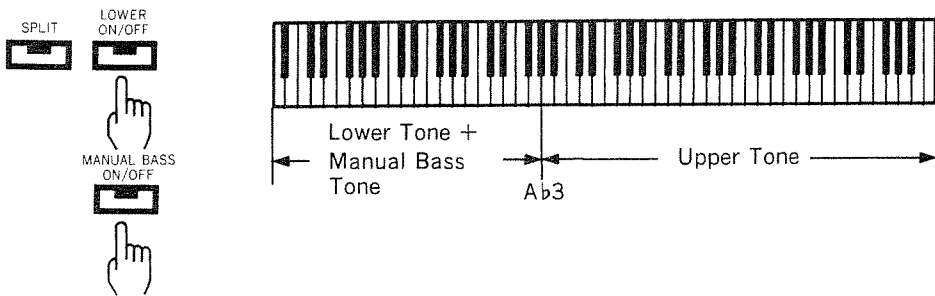

If you wish, you can press **LEADING BASS**, (the indicator will light). The lowest note of chords played in the Lower section will now sound using the Manual Bass Tone. (see P. 39)

If the indicators on both **LOWER** and **MANUAL BASS** are dark while in the Split mode, no sound will be produced when you play in the Lower section.

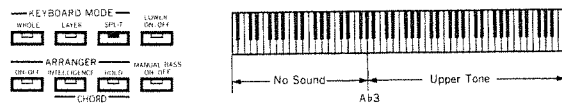



## d. Split + Layer

You will be able to perform impressive ensembles that use 3 sounds at once, if you press these four buttons : **LAYER**, **SPLIT**, **LOWER**, and **MANUAL BASS**. (Note : All four indicators must be lit.)

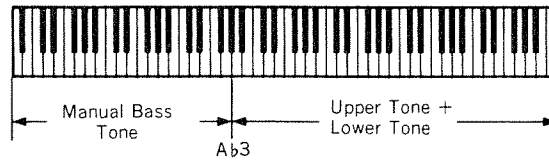
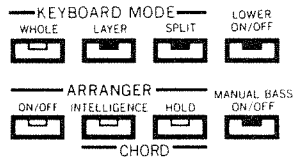

When you play in the Upper section, both Upper and Lower Tones are layered and will sound together. What you play in the Lower section will be sounded using the Manual Bass Tone.

## 2. Selecting Tones

The Tones for Upper / Lower / Manual Bass are selected using the buttons in the Tone Select Section.

Tone changes can also be made while a Style is playing, or while Manual Drums or Manual Sound Effects are played.

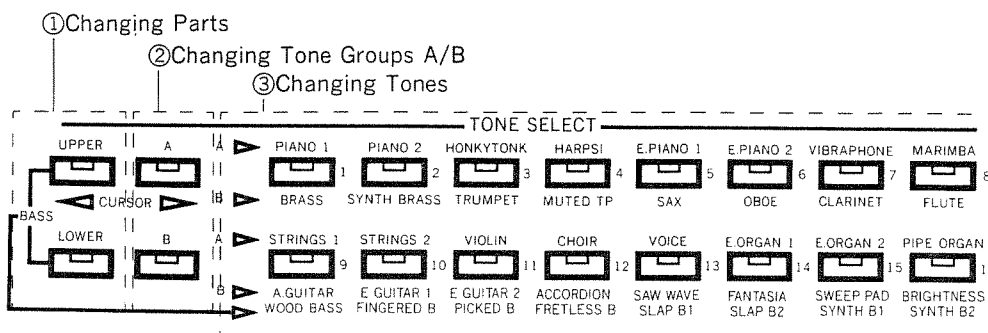

### a. Upper Tone

Any sound from among the 32 different sounds available for the Upper Tone (16 buttons x 2 groups) can be selected.

#### Operation

From the Master Screen :

- ① Press **UPPER** and confirm that its indicator is lit.
- ② Select the Tone Group.  
With **A** pressed, and its indicator lit, you can select from the A Group Tones; those printed above the Tone Select Buttons. With **B** pressed, and its indicator lit, you can select from the B Group Tones; those printed below the Tone Select Buttons.

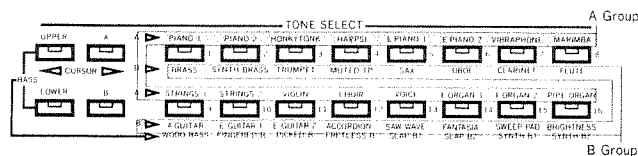

- ③ Press the Tone Select Button corresponding to the Tone you wish to use. The indicator on the button you have pressed will light, and the name of the selected Tone will appear in the display.

```
UPPER Tone
A05 E.Piano 1
```

- ▲ The Tone Select Button that is fourth from the right on the upper row has been pressed, and E. Piano 1 has thus been selected for the Upper Tone.

## b. Lower Tone

Any sound from among the 32 different sounds available for the Lower Tone (16 buttons x 2 groups) can be selected.

### Operation

From the Master Screen :

- Press **LOWER** and confirm that its indicator is lit.
- Select the Tone Group.  
With **A** pressed, and its indicator lit, you can select from the A Group Tones; those printed above the Tone Select Buttons. With **B** pressed, and its indicator lit, you can select from the B Group Tones; those printed below the Tone Select Buttons.

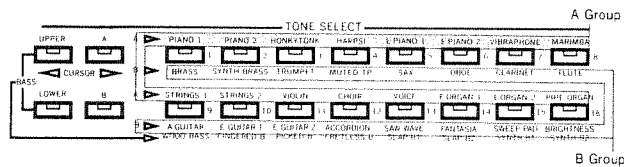

- Press the Tone Select Button corresponding to the Tone you wish to use. The indicator on the button you have pressed will light, and the name of the selected Tone will appear in the display.

LOWER Tone  
A14 E.Organ 1

- The Tone Select Button that is third from the right on the lower row has been pressed, and E. Organ 1 has thus been selected for the Lower Tone.

## c. Manual Bass Tone

Any sound from among the 8 different sounds available for the Manual Bass Tone can be selected.

### Operation

From the Master Screen :

- Press **UPPER** and **LOWER** simultaneously, and confirm that their indicators are lit.
- Press the Tone Select Button corresponding to the Tone you wish to use. The indicator on the button you have pressed will light, and the name of the selected Tone will appear in the display.

M.BASS Tone  
B13 Slap Bass 1

- The Tone Select Button that is fourth from the right on the lower row has been pressed, and Slap Bass 1 has thus been selected for the Manual Bass Tone.

Although the Tone Select Buttons consist of two rows, each having 8 buttons, only the buttons in the lower row are available for making the selection of the Manual Bass Tone. The names of the Bass Tones (Bass Group) appear below the names for the B Group.

When the power is turned on, the following default selections for Tones will be in effect :

- Upper...A01 Piano 1
- Lower...A09 Strings 1
- Manual Bass...B09 Wood Bass

## Tone List

### <A Group>

A01 Piano 1  
A02 Piano 2  
A03 Honky-tonk piano  
A04 Harpsichord  
A05 E.Piano 1  
A06 E.Piano 2  
A07 Vibraphone  
A08 Marimba  
A09 Strings 1  
A10 Strings 2  
A11 Violin  
A12 Choir  
A13 Voice  
A14 E.Organ 1  
A15 E.Organ 2  
A16 Pipe Organ

### <B Group>

B01 Brass  
B02 Synth Brass  
B03 Trumpet  
B04 Muted TP.  
B05 Sax  
B06 Oboe  
B07 Clarinet  
B08 Flute  
B09 A.Guitar  
B10 E.Guitar 1  
B11 E.Guitar 2  
B12 Accordion  
B13 Saw Wave  
B14 Fantasia  
B15 Sweep Pad  
B16 Brightness

### <Bass Group>

B09 Wood Bass  
B10 Fingered Bass  
B11 Picked Bass  
B12 Fretless Bass  
B13 Slap Bass 1  
B14 Slap Bass 2  
B15 Synth Bass 1  
B16 Synth Bass 2

# 3. Concerning Chords

The Arranger on the KR-4500 uses the chords you play to create accompaniment which is suitable for the Music Style selected at the time. The following explains some of the fundamentals concerning use of chords.

## a. The Root and Other Constituent Notes

After turning the **ARRANGER** ON, if you play "Do", "Mi", "Sol" in the Lower section of the keyboard, the display will show the information shown below. (Turning **ARRANGER** On/Off, see page 34)

C Major

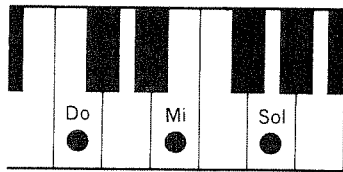

This tells you that the "Do", "Mi", "Sol" keys that were played formed a C Major chord.

Next, try playing "La", "Do", "Mi". The display should then show the following :

A Minor

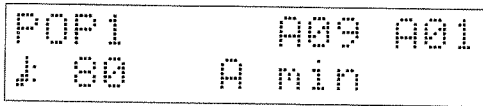
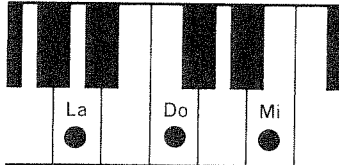

You thus know that you played an A minor chord.

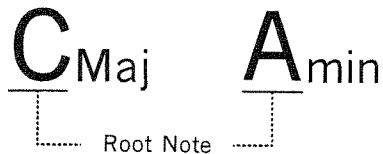

○ Root Note...The root is the note which is the main tone (tonic) of the chord, and is the note which gives the chord its name; a capital letter from C-B (some have a # or b).

For example, in a C Major chord, the root is the note C (Do); and in an A minor chord, it is the note A (La).

○ Constituent Notes...These are the notes of which the chord is composed. In a C Major chord, they are the notes "Do", "Mi", and "Sol"; and in an A minor chord, they are the notes "La", "Do", and "Mi".

With the Arranger ON, the name of whatever chord has been played in the Lower section will be shown in the display. Chords can thus be confirmed by both sight and sound.

## b. Reading Note Names

There are 12 root notes (including white and black keys) for chords, which range from "Do" to "Si". All of these are represented with a letter, sometimes having a # or b. The root notes are as follows :

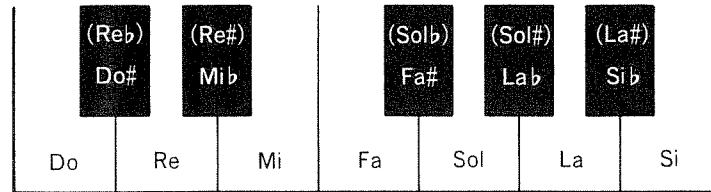
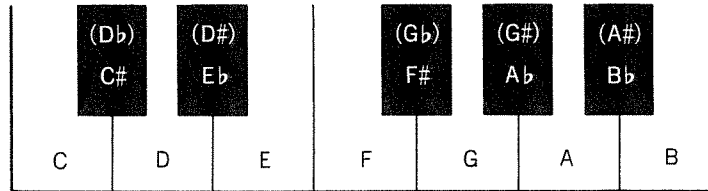

Some of the more common chords that the KR-4500 recognizes are listed below. (It of course is capable of recognizing many more than this)

Chord Name (When C is the root)	indicated on KR-4500
C Major	C Maj
C minor	C min
C seventh	C 7
C Major seventh	C Maj7
C minor seventh	C min7
C minor seventh flat five	C m7b5
C suspended four	C sus4
C suspended seventh (C seventh sus four)	C 7sus
C Augmented	C Aug
C diminished	C dim
C Augmented seventh	C Aug7
C sixth	C 6

## c. Chord Inversions

The notes of a chord can also be positioned (voiced) in a different manner. A chord that is played with its root note on the bottom is said to be in "root position". When any constituent note other than the root is placed at the bottom, the chord is then called an "inversion."

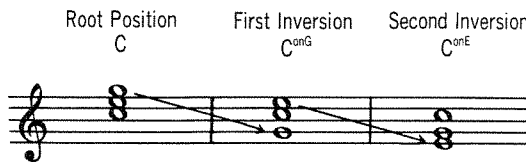
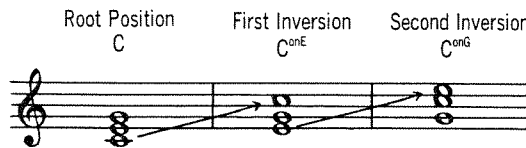

Chord inversions are indicated as follows :

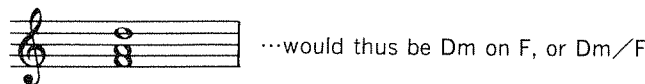

By changing a chord's voicing, you obtain a different sound. Depending on where a chord is located within a piece, you may want to selectively employ inversions in order to create more interesting music.

Employing the Leading Bass feature (☞ P. 39), the bottom note of an inversion can be taken as the bass note.

## 4. One-Touch Program

Simply by pressing a One-Touch Program button, you can immediately switch the instrument's panel settings to the corresponding playing mode, regardless of the status the instrument was in at that time. The following three playing modes are available as presets.

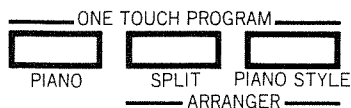

If you make changes in a One-touch Program setting, the functions assigned to the pedals will also change. (Pedal Switch ☞ page 48)

Whenever you feel that the flashing of the Beat indicator is distracting, such as when performing solo, you can turn it off simply by sliding the TEMPO slider to its left extreme. (Beat Indicator  page 34)

The metronome feature (See Quick Start  P.20) comes in handy for lessons and practice.

## a. Piano Mode

Press **PIANO** when you wish to play the instrument as an 88-key acoustic piano. You can also change the acoustic piano sound to something else and still play using all the keys. Note, however, that the Arranger cannot be used while in the Piano Mode.

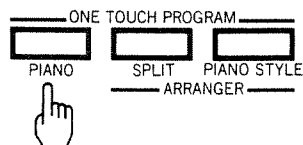

Continue pressing **PIANO** for more than 1 second, and you will be able to play the entire keyboard with the acoustic piano sound and call up a group of settings (such as Upper part balance, effect settings etc.) that is best suited for the acoustic piano performance.

## b. Split Arranger Mode

To prepare the instrument for automatic accompaniment (performance of Styles), simply press **SPLIT ARRANGER**. When playing Styles in the Split Arranger Mode, the keyboard is divided into two zones. The chords are then played in the Lower section, while the melody is played in the Upper section.

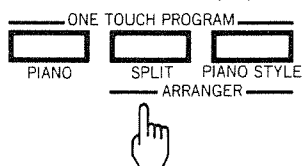

Continue pressing **SPLIT ARRANGER** for more than 1 second, and you will be able to call up a group of settings that is best suited to the selected Music Style. Such settings include not only those concerned with the play of Styles, splitting of the keyboard, and selection of chords in the Lower zone, but also those determining the sound that will be played with the right hand, the balance between the Parts, and settings for Effects. However, in the Music Style Expansion mode ( P.67), these settings won't be selected.

## c. Piano Style Arranger Mode

To prepare the instrument for performance of Styles which allow chords to be played anywhere on the keyboard, press **PIANO STYLE ARRANGER**. When in the Piano Style Arranger Mode, chords can be detected no matter which keys on the keyboard are pressed. As a result, you can obtain an accompaniment pattern that matches what is played, even while playing in a traditional piano style.

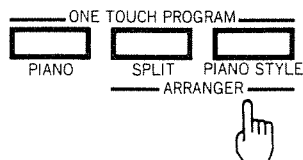

Continue pressing **PIANO STYLE ARRANGER** for more than 1 second, and you will be able to call up a group of settings that is best suited for the selected Music Style. Such settings include not only those concerned with the performance of Styles while allowing selection of chords from any position on the keyboard, but also those determining the balance between the Parts, and settings for Effects. However, in the Music Style Expansion mode ( P.67), these settings won't be selected.



# 2

**Having Fun with  
Various Styles  
of Music**

# 1. What are Music Styles?

Music can be played in different styles. While attending a concert or listening to a record, you may have thought to yourself, "That sound has a bossanova-like quality", or, "That sound has a reggae-like quality".

You think like this because the rhythm, the tempo, the instruments played, the melody and the phrases all come together to create the quality you recognize.

A Music Style is what is obtained when the elements that are typically associated with a certain genre of music are broken down and put back together. The KR-4500 features 32 different styles of music (or 64 in the expanded mode).

## Music Style

### Rhythm

Tempo that fits the rhythm

Selection of instruments that fit the rhythm

Arrangement that fits the rhythm

A Music Style consists of four playing patterns : Original, Variation, Intro and Ending. For each style, there is a choice between Basic (simple arrangement) and Advanced (more sophisticated arrangement). This means that a total of 8 accompaniment patterns are available for each musical style. In addition, a major, minor, seventh, or any other chord selected, will change the arrangement for the accompaniment pattern, resulting in subtler variations in expression to match the flow of the music. And when the two types of fill-ins used in between measures in the accompaniment pattern, breaks, and other special accompaniments are brought into play, the number of ways in which the accompaniment patterns produced from each musical style can be combined is enormous.

Select an accompaniment pattern for a Music Style using the corresponding button on the panel during the performance.

## A Point of Advice

The Original, Variation, Intro and Ending of each musical style can perhaps be better understood using the analogy of story-telling with its four phases : its beginning, development, turns and its conclusion. The simplest composition is produced when music is played in the sequence below. (Although the composition of real music is more complex, this unit with its 4 x 2 accompaniment pattern combinations can handle virtually any type of music.) When a specific kind of music is to be played in its own style, it will sound best if the player considers its inherent flow extending from its introduction to its conclusion.

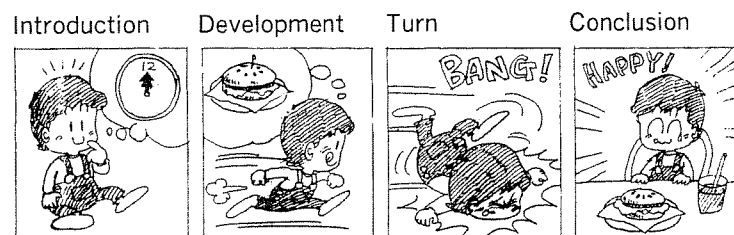

INTRO → ORIGINAL → (FILL IN) → VARIATION → ENDING

The number of musical styles available can be increased using the Music Style Card (TN - SC Series : optional) or the Music Style Super Card (MSL - 15 : optional).

## 2. What is the Arranger?

To use the KR-4500 to have fun playing a particular style of music, turn on the Arranger function to select the Music Style.

The Arranger instantly turns the music being played into an accompaniment which sounds like the kind of music intended. It does this by adding drums, bass, backing (and other elements to the basic information on the accompaniment pattern of the selected Music Style) and the chords played on the keyboard, and by arranging all these elements together. Changing the accompaniment pattern or chord produces a change in the performance in real-time. It is also possible to change the arrangement totally by selecting a different Music Style.

### Melody Intelligence function

When the Melody Intelligence function is turned ON, the Arranger automatically adds the harmony to suit the chord played. (P. 41)

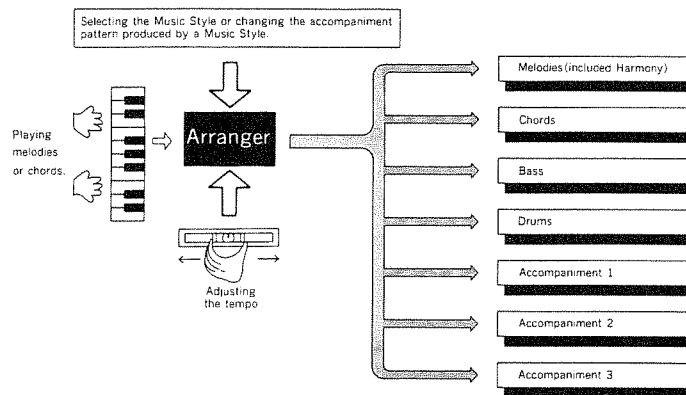

## 3. What is Style Play?

Style play refers to the automatic accompaniment produced by the Arranger function. The accompaniment will also change depending on the Music Style selected or the chord played. This means that you can have fun with various kinds of variations.

There are two types of style play. These are dependent upon the range of the keyboard in which the Arranger can detect chords.

### ○ Chord detection in the Lower zone (Split Arranger mode)

This can be used by turning the Arranger ON (P. 34) and setting either "Split" or "Split + Layer" as the keyboard mode (P. 12).

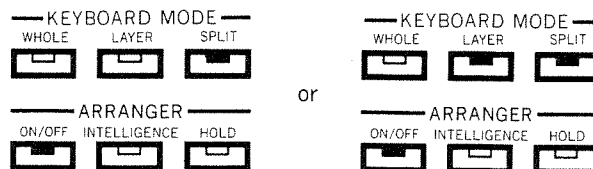

The keyboard is split into the Upper and the Lower zones. Chords are recognized when they are played in the Lower zone of the keyboard.

The Split Arranger mode is activated by pressing the **SPLIT ARRANGER** Programming button. (P. 22)

○ **Detection of chords anywhere on the keyboard (Piano Style Arranger mode)**

You can employ this method by turning the Arranger ON and selecting either "Whole" or "Layer" as the keyboard mode (P. 12).

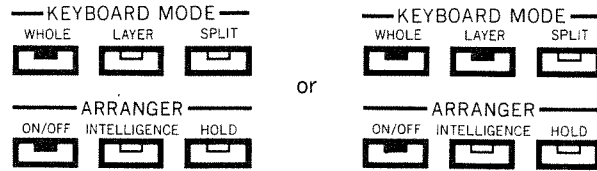

Chords are recognized no matter where on the keyboard they are played.

The Piano Style Arranger status is established instantly by pressing the **PIANO STYLE ARRANGER** Programming button. (P. 22)

In either case, the Arranger shows the name of the chord on the display.

## 4. Selecting a Music Style

Aside from the 32 Music Styles featured by the main unit, the Music Styles on optional Music Style Cards (read-only memory cards) can be added to a performance.

### a. Selecting Music Styles from the Main Unit

When Music Style indicator "A" is lit, the Music Styles marked above the Music Style selector buttons can be selected. Press **B** (the indicator lights) to select the Music Styles marked below the buttons.

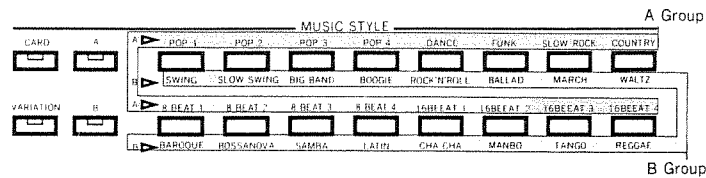

MUSIC STYLE LIST

GROUP A	GROUP B
A01 POP 1	B01 SWING2
A02 POP 2	B02 SLSWING1 (Slow Swing 1)
A03 POP 3	B03 BIG BAND
A04 POP 4	B04 BOOGIE
A05 DANCE	B05 ROCK'N' ROLL
A06 FUNK2	B06 BALLAD2
A07 SL ROCK2 (Slow Rock 2)	B07 MARCH
A08 COUNTRY	B08 WALTZ
A09 8BEAT1	B09 BAROQUE
A10 8BEAT2	B10 BOSSA (Bossanova)
A11 8BEAT3	B11 SAMBA
A12 8BEAT4	B12 LATIN
A13 16BEAT1	B13 CHACHA
A14 16BEAT2	B14 MAMBO
A15 16BEAT3	B15 TANGO
A16 16BEAT4	B16 REGGAE

Example) Selecting the "Samba" style.

**Operation**

From the Master Screen :

- ① If indicator "A" is lit, press (B) (the indicator will flash).
- ② Press (SAMBA) (which is the third Music Style selector button from the left on the bottom row).

```
SAMBA      A09 A01
J:110
```

## b. Selecting Music Styles from a Music Style Card

Music can be played in one of the styles contained on the card by following the same procedure used to select a Music Style from the main unit.

### Operation

- ① Insert the Music Style Card into the card slot.

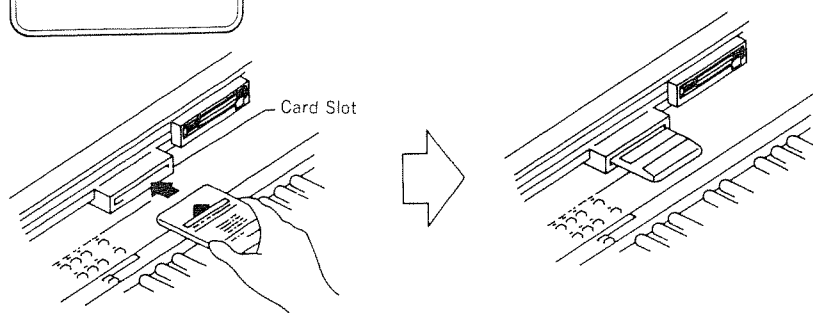
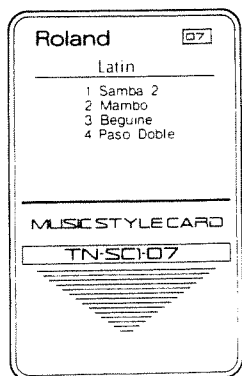

Make sure the card is faced properly, and insert it into the correct direction.

- ② Press **CARD**.

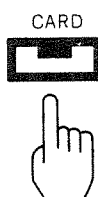

- ③ Select one of the Music Styles stored on the card.

When one of the buttons is pressed, the name of the corresponding Music Style (and its preset tempo) will appear on the screen.

If Music Style button **1** is pressed, the first Music Style is selected. Similarly, if Music Style button **2** is pressed, the second Music Style is selected, and if button **3** is pressed, the third Music Style is selected.

To switch to the Music Styles provided by the main unit with the Music Style Card still inserted in the slot, first press Music Style select button **A** or **B**, and then press the button of the Music Style desired.

# 5. Starting and Stopping the Music Styles

Once the Arranger has been turned ON, you can enjoy the automatic accompaniment (in the style) produced by the Arranger. With the Arranger turned OFF, the rhythm alone can be produced, allowing you to use the unit as a rhythm machine. (Refer to page 34 for further details on the Arranger.)

## a. Starting

Music Styles can be started in one of four ways. Select the method which fits the music being played.

- Press **START/STOP**.

The selected Music Style starts as soon as this button is pressed.

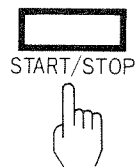

- Press **SYNC START**.

In the Split mode, the style starts as soon as one of the keys in the Lower range is pressed. When Split is not being used, it starts as soon as any key is pressed.

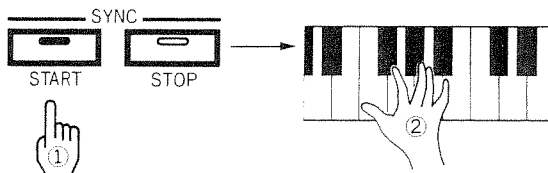

- Press **INTRO/ENDING**.

The selected Music Style starts with an introduction which suits the style.

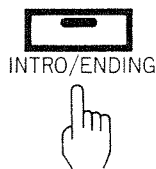

- Press **SYNC START** and then **INTRO/ENDING**. (The **SYNC START** indicator will now be flashing.)

In the Split status, the selected style starts when one of the keys in the Lower range is pressed. When the Split status is OFF, it starts as soon as any key is pressed.

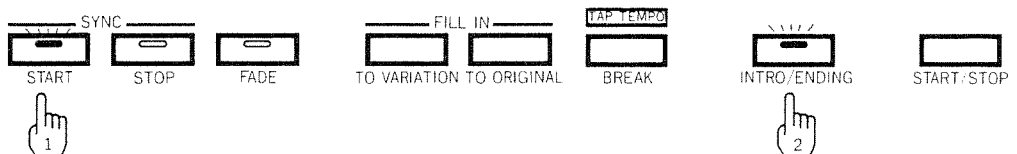

Some Music Styles do not contain rhythm patterns. If you select one of these styles and start it, no rhythm sounds will be heard.

The length of the Intro differs depending on the Music Style selected. (P. 158)

The length of the Ending will vary depending on the Music Style (see P. 158).

## b. Stopping

There are three ways to stop a Music Style that is playing.

- Press **START/STOP**.

The Music Style stops as soon as this button is pressed.

- Press **INTRO/ENDING**.

When this button is pressed, an Ending phrase suited to the Music Style is played first, and then the style stops.

- Press **SYNC STOP**.

The Music Style will stop when you release the keys on the keyboard.

# 6. Fade-In / Fade-Out of Music Styles

Fade-in refers to a feature whereby the volume will gradually increase from "0" to a preset level.

Conversely, Fade-out is a feature that gradually reduces the volume from the set level to "0".

During a Fade-in, the indicator on **FADE** will be lit. It goes out when the Fade-in is completed. Similarly, during a Fade-out, the indicator on **FADE** will be lit, and will be flashing when the Fade-out is completed.

## a. Fade-In

A Fade-in can be applied to a Music Style in any of the following four ways.

- Press **FADE** and then **START/STOP**.

Once you press **FADE** the indicator on **FADE** will begin flashing, and when you press **START/STOP** it will light continuously.

At the moment you press **START/STOP**, the Music Style will begin fading-in.

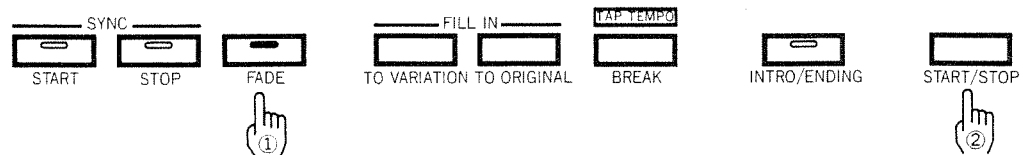



○ Press **SYNC START** and then **FADE**.

Once you press **FADE** the indicator on **FADE** will begin flashing, and when you press a key on the keyboard, it will light continuously.

When in the Split mode, the Music Style will begin fading-in the moment you press a key in the Lower zone. If in the Whole mode, this occurs the moment you press a key anywhere on the keyboard.

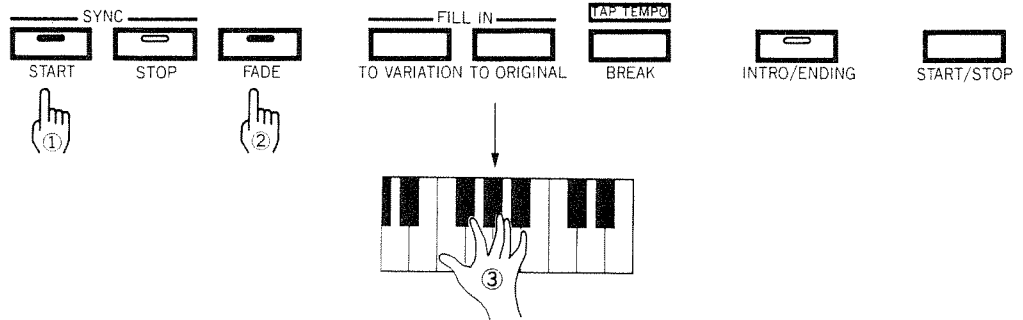

○ Press **FADE** and then **INTRO/ENDING**.

(Once you press **FADE** its indicator will begin flashing, and when you press **INTRO/ENDING** it will light continuously.)

At the moment you press **INTRO/ENDING**, an Intro suitable for the selected Music Style will begin fading-in.

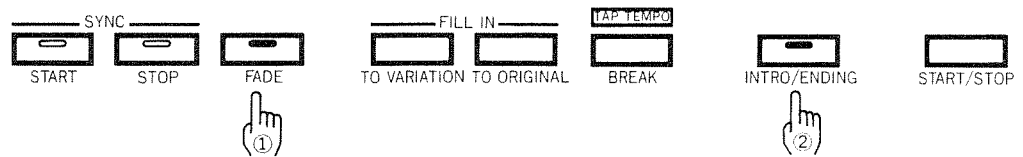

○ Press **SYNC START**, then **INTRO/ENDING**, and then **FADE**.

(Once you press **FADE** its indicator will begin flashing, and when you press a key on the keyboard, it will light continuously.)

When in the Split mode, an Intro suitable for the selected Music Style will begin fading-in the moment you press a key in the Lower zone. If in the Whole mode, this occurs the moment you press a key anywhere on the keyboard.

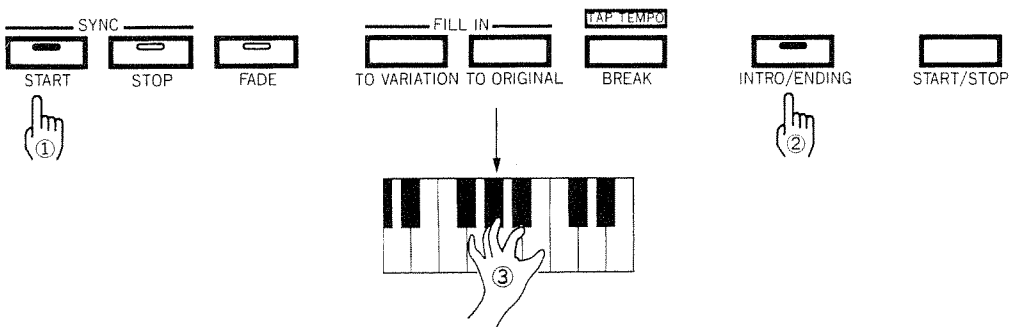

## b. Fade-Out

Just as a Music Style can begin with a fade-in, it can also end with a fade-out.

### Operation

- 1 Press **FADE**.

The moment you press the button, the sound will begin fading out. When the indicator on **FADE** starts flashing, press **START/STOP**.



After a Fade-out has been completed, and the volume is "0," the Music Style will actually still be playing as long as the indicator on **FADE** is still flashing. You need to stop it by pressing **START/STOP**.

## 7. Adjusting the Tempo

The tempo is indicated at the bottom left of the display as the number of beats per minute (example:  $\text{♩} : 120$ ). The number shown indicates the number of quarter notes played per minute. Any tempo can be selected across a range of  $\text{♩} : 30$  to 240 beats per minute. If the piece to be played has a specific tempo, the tempo can be set on the display prior to play. You'll find this to be a very convenient feature.

In the KR-4500, each Music Style has been given a tempo setting that is considered to be the most suitable. (This is referred to as the "preset tempo.") However, if you need to, you can adjust the tempo of the Music Style. There are three ways to do this.

### a. Tempo slider

Slide the Tempo slider to the right to increase the tempo.

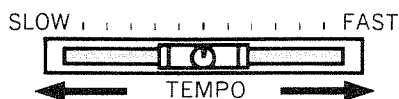

## b. INC / DEC

Each time **INC** is pressed, the tempo is increased by one step (one beat per minute); conversely, each time **DEC** is pressed, it is reduced by one step. If either button is kept depressed, the tempo will change continuously.



If both **INC** and **DEC** are pressed at the same time, the tempo returns to the preset value.

## c. Tapping Tempo

If the **TAP TEMPO** button is tapped at the desired tempo after the Music Style has stopped, the beat indicator will flash at the same speed as the key was tapped. The tempo display will automatically change to the setting made by the tap tempo.

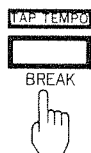

The tap tempo can be set only when the Music Style is stopped. If **TAP TEMPO** is pressed while a Music Style is being played, it functions as the Break button, serving to temporarily discontinue play in the Music Style. (P. 37)

Even when the Music Style is changed during play, play can still be continued in the original tempo. This function enables interesting arrangements to be created as the sound is suddenly switched from rock to baroque, for instance.

## d. Beat Indicator

Once a Music Style has started, the Beat indicator will run from left to right at the set tempo.

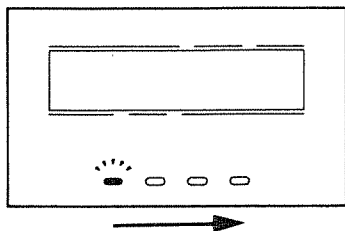

When the Music Style is stopped, only the red indicator will flash at the speed of the set tempo.

In the case of 4/4 (quadruple time measure), the red indicator will flash on the first beat (downbeat) and the green indicators will flash on the second, third and fourth beats (upbeat). This pattern is repeated until the rhythm is stopped. With 3/4 (triple time), no indicator will flash on the fourth beat. The player can thus determine where each measure begins simply by monitoring the flashing of the red indicator: this makes it easy to gauge the timing for a fill-in, for example. (Refer to page 36 for further details on fill-ins.)

## 8. Arranger ON/OFF

The Arranger must be ON for music to be played in different styles. When a Music Style is started with the Arranger turned ON, automatic accompaniment is provided in real-time on the basis of the selected Music Style and the chords played.

### Operation

- ① Select a Music Style. (☞P. 26)
- ② Set the keyboard mode (☞P. 12) and Tone to be used. (☞P. 16)
- ③ Press **ON/OFF** on the Arranger (the indicator will light).

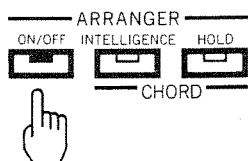

- ④ Start the Music Style.  
Refer to page 29 for the ways to start a Music Style.
- ⑤ Play chords in the appropriate range of the keyboard.
- ⑥ Stop the Music Style.  
Refer to page 30 for the ways to stop a Music Style.

If a Music Style is started with the Arranger turned OFF, only the rhythm will be played.

# 9. Types of Arrangements

The type of arrangement to be produced by the Arranger is selected by operating the Arranger button (**ADVANCED/BASIC**) and Variation button (**VARIATION**). These two buttons yield four possible combinations.

- When both the **ADVANCED/BASIC** and **VARIATION** button indicators are OFF :  
Basic (simple), Original
- When the **ADVANCED/BASIC** indicator is OFF and the **VARIATION** indicator is ON :  
Basic (simple), Variation
- When the **ADVANCED/BASIC** indicator is ON and the **VARIATION** indicator is OFF :  
Advanced (somewhat sophisticated), Original
- When both the **ADVANCED/BASIC** and **VARIATION** indicators are ON :  
Advanced (somewhat sophisticated), Variation

## a. Arranger Button (Basic & Advanced)

This button selects the arrangement type between Basic and Advanced.

Basic (OFF) ..... Simple arrangement  
Advanced (ON) ..... Sophisticated arrangement

When the **ADVANCED/BASIC** indicator is ON, the Advanced arrangement is selected; when it is OFF, the Basic arrangement is selected. Each time this button is pressed, Advanced and Basic are selected alternately.

## b. Variation Button (Original & Variation)

Original and Variation choices are available for each Music Style.

One example where Variations can be used effectively is in the bridge sections of a piece (where the music builds up).

Original (OFF) ..... Basic pattern  
Variation (ON) ..... Variation pattern

When the **VARIATION** indicator is ON, Variation is selected; conversely, when it is OFF, Original is selected. Each time the button is pressed, Variation and Original are selected alternately.

Each time a button, whether Arranger or Variation, is pressed, its indicator turns ON or OFF.

When the power is switched ON, Advanced is automatically selected.

Selection between Original and Variation can also be made using the fill-ins described in the next paragraph.

# 10. Fill-Ins

A Fill-in refers to an irregular phrase, such as the "rat-a-tat" or "parum-pum-pum" of drums, that might be inserted between measures.

The **TO VARIATION** and **TO ORIGINAL** buttons are provided for Fill-ins, and the composition moves to either the Variation or Original pattern, depending on which button was pressed.

If one of the Fill-in buttons is pressed between the first and third beats (between the first and Second beats in 3/4) the Fill-in will occur in the remaining section of the measure. If it is pressed on the fourth beat (third beat with 3/4), the Fill-in will start from the first beat of the next measure.

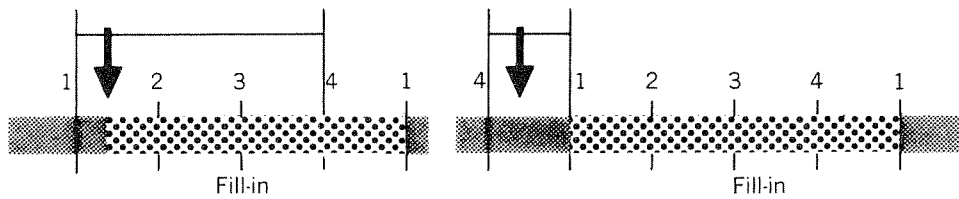

## a. Fill-In to Variation

If the **TO VARIATION** Fill-in button is pressed, the performance continues with the Variation in Basic or Advanced arrangement after the Fill-in has been played.

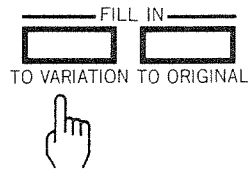

## b. Fill-In to Original

If the **TO ORIGINAL** Fill-in button is pressed, the performance continues with Original in the Basic or Advanced arrangement after the Fill-in has been played.

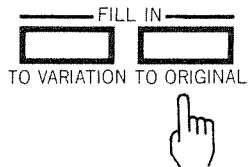

At this point, the **VARIATION** indicator lights and the Variation mode is set ON. If it was ON from the start, the performance continues with Variation after the Fill-in.

At this point, the **VARIATION** indicator goes OFF and the Variation mode is set OFF. If it was OFF from the start, the performance continues with Original after the Fill-in.

# 11. Breaks

Pressing **BREAK** while playing in a particular musical style results in a 1-measure break (the performance has stopped).

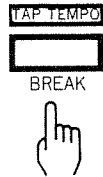

While the Music Style has stopped, **BREAK** functions as the Tap Tempo button (P. 33).

If the Break button is pressed between the first and third beats (between the first and second beats in 3/4), the break will occur in the remaining section of the measure. If it is pressed on the fourth beat (third beat with 3/4), the break will start from the first beat of the next measure.

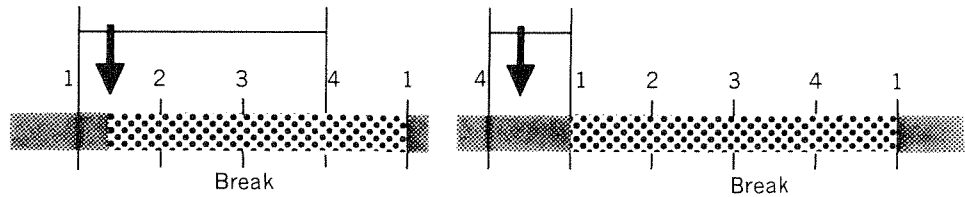

# 12. Chord Hold

If Chord Hold is set to ON while a Music Style is playing, the last chord played will be held until the next notes are played. This function comes in handy, for instance, when switching a Music Style midway during play.

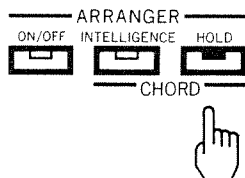

If the keys are released with the Chord Hold function OFF while a Music Style is being played, only the rhythm will be heard.

With play of the Style stopped, split the keyboard, and turn Chord Hold ON. Thereafter, whatever you play in the Lower zone will be sustained until something new is played. Note that if the Manual Bass Tone has been sounded at the same time, it will be sustained as well. (However, the Manual Bass Tone cannot be sustained by itself.)

# 13. Chord Intelligence

Different chords can be played with only a few fingers when using the Chord Intelligence function.

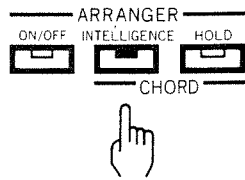

Major (□ Maj).....Press the key of the chord root.

Example) C Maj



Chord Intelligence:ON

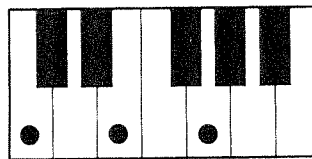

Chord Intelligence:OFF

Minor (□ min).....Press the keys of the root and flat third.

Example) A min

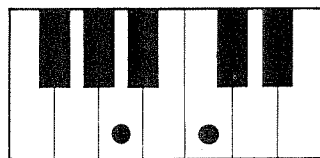

Chord Intelligence:ON

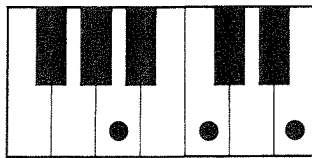

Chord Intelligence:OFF

Seventh (□ 7).....Press the keys of the root and the note which is two half steps lower.

Example) C 7

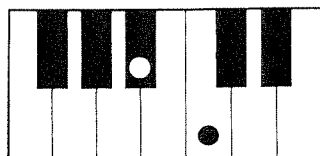

Chord Intelligence:ON

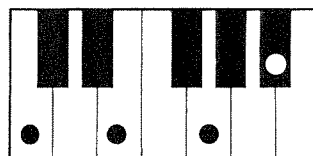

Chord Intelligence:OFF

Major Seventh (□ Maj7).....Press the keys of the root and the note which is a half step lower.

Example) C Maj7

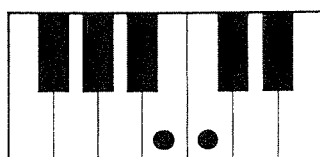

Chord Intelligence:ON

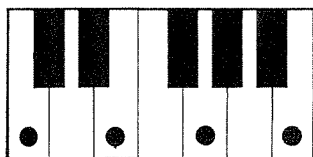

Chord Intelligence:OFF



- Minor Seventh (□ min7) ..... Press the keys of the root, flat third and the note which is two half steps below the root.

Example) A min7

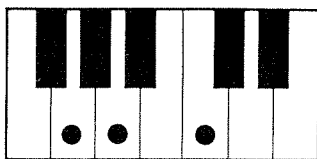

Chord Intelligence:ON

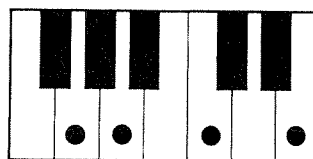

Chord Intelligence:OFF

- Diminished (□ dim) ... Press the keys of the root and the note which is six half steps above it (flat the fifth above the root).

Example) C dim

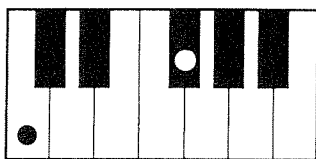

Chord Intelligence:ON

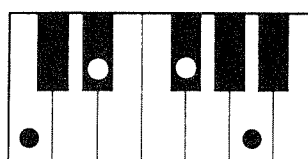

Chord Intelligence:OFF

The Chord Intelligence function cannot be set to ON either while the **WHOLE** indicator of the Keyboard Mode is ON or while the Piano Style Arranger Mode is ON.

## 14. Leading Bass

When **LEADING BASS** is pressed (and its indicator is turned ON), the lowest note of an inverted chord (played while a Music Style is being played) is recognized by the Arranger as the bass tone. (In other words, the lowest note in the chord actually played is played as the bass tone, regardless of the root of that chord.)



LEADING BASS



To turn the Leading Bass function OFF, press **LEADING BASS** again.

The Leading Bass function is valid for the Manual Bass even when the Arranger is OFF.

**Inverted chords :**

The upper-case letter preceding the chord name is called the "root" and it indicates the lowest tone in the chord. (Example : In A minor, "A" is the root.)

A chord which has this root as the lowest tone (and the other component tones above it) is called a "root position chord," and a chord which has a tone other than its root as the lowest tone is called an "inverted chord." (Example : In A minor, "A/C/E" (La/Do/Mi) is a root position chord while "C/E/A" (Do/Mi/La) and "E/A/C" (Mi/La/Do) are inverted chords.)

If during chord play, you use a chord that is an inverted version of the chord being played, the sound of that chord will change, and the way in which the chords are linked will sometimes sound more beautiful.

If its Leading Bass function is used, the KR-4500 is capable of using the lowest tone in the inverted chord as the bass tone. This means that the sound can be varied even with the same chord.

Amin A<sup>b</sup> Aug CMaj/G F<sup>#</sup>min7<sup>b</sup>5

When Leading Bass is OFF :

When Leading Bass is ON :

While the Leading Bass function is on, the bass pattern will vary when the root position chord is selected. When the inverted version of the same chord is then selected, however, only the lowest tone (and the tones that are one or more octaves higher or lower) are played using the same note distribution. This is done to prevent a bass tone that the player does not intend to play from being sounded.

A chord can be played anywhere on the keyboard when using the Piano Style Arranger. Using this function, and combining it with the Leading Bass function, you can play the chords with your right hand and move the bass line with the left, thereby achieving a greater degree of sophistication in what you are playing.

Music Style:POP1

C Maj G Maj C CMaj FMaj7 FMaj G<sup>7</sup> C Maj G Maj C CMaj FMaj7

# 15. Melody Intelligence

When the Melody Intelligence function is used, you can use your right hand to add the harmony best suited to the melody played.

## Operation

- ① Press **MELODY INTELLIGENCE**, and confirm that its indicator is lit.



MELODY INTELLIGENCE



To turn the Melody Intelligence function OFF, press **MELODY INTELLIGENCE** again.



# 3



**Enhancing Your  
Playing Technique**

# 1. Function Settings

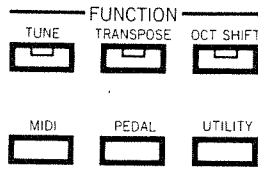

Some functions can be set beforehand to make playing easier. These functions are listed below.

Press **EXIT** to return to the Master Screen after having set the function. Even if **EXIT** is not pressed, operation will automatically return to this screen in a short while (4 or 5 seconds). If the display has returned to the Master Screen during operations, perform the procedure again from the start.

- Master Tune : For adjusting the overall pitch of the instrument.
- Transpose : For transposing (shifting) keys to accommodate different players or singers.
- Octave Shift : For shifting the Upper, Lower or Manual Bass Tone interval by one or two octaves.
- MIDI : For having more fun in new musical directions using other electronic instruments connected by MIDI. This need not be set when only this unit is used to create music.
- Pedal switches : For using your feet to control any of the 14 functions assignable to the pedals.
- Utility : For setting any of the 6 functions listed below :
  - Pitch Bend Range : For setting the maximum amount of pitch change for each Part.
  - Repeat Note : For adding a rhythmic pattern to Tones played in a Style Play.
  - Keyboard Sensitivity : For setting the depth at which the keys on the keyboard respond.
  - LCD Contrast : For adjusting the display contrast.
  - Metronome Level : For adjusting the metronome volume.
  - GS Mode : For arranging the KR-4500 sound source so it conforms to the GS format.

## a. Master Tune

This allows the overall pitch of the instrument to be changed. You can therefore tune your KR-4500 to match the pitch of virtually any other instrument. The setting range of this function extends from 415.3 Hz to 466.2 Hz, and changes can be made in 0.1 Hz increments.

### Operation

From the Master Screen :

- ① Press **TUNE** to display the Master Tune operation screen.

The screenshot shows a rectangular display area with the text 'MASTER TUNE' at the top and '440.0 Hz' below it.

At the factory, the pitch of A4 (La) is set to 440.0 Hz.

When **INC** and **DEC** are pressed together with the Master Tune operation screen displayed, the pitch will instantly return to the factory default setting of 440.0 Hz.

- ② Adjust the pitch. To raise the pitch, press **INC**; to lower it, press **DEC**.



- ③ After the pitch has been adjusted, press **EXIT** to return to the Master Screen.

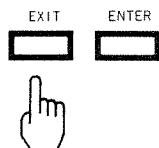

The **TUNE** indicator lights when the Master Tune setting is not 440.0 Hz.

The Master Tune setting is retained in this unit's memory even after the power has been turned off.

## b. Transpose

This function can be used when providing accompaniment to transpose the music from the key actually played to match the range of the singer.

Using this function, music can be played using a familiar fingering on the keyboard, but sounding with different pitches.

For instance, when the function is set to G ...



When this is played...

This will actually sound...

### Operation

From the Master Screen :

- ① Press **TRANPOSE** to display the Transpose operation screen.



- ② Decide on the key to which the music is to be transposed. Each time **INC** is pressed, the key is raised by a half step; each time **DEC** is pressed, it is lowered by a half step, and a maximum of one octave is possible.



When a particular key on the keyboard is pressed down while **TRANSDPOSE** is depressed, the key can be transposed instantly to the pressed key.

- ③ After the key has been adjusted, press **EXIT** to return to the Master Screen.

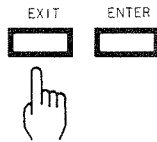

The **TRANSDPOSE** indicator lights when Transpose is set to a key other than C.

When the power is turned on, C (Do) will automatically be selected.

When **INC** and **DEC** are pressed together with the Transpose operation screen displayed, the key will return to the factory default setting of C (Do).

## c. Octave Shift

"Octave shifting" refers to raising or lowering the notes being played by one or two octaves. It is used to set the Upper, Lower or Manual Bass Tone interval to a level in keeping with the Part.

When notes are raised by 1 octave :



When key I is played, the result is a sound produced at the pitch of II.

When notes are lowered by 1 octave :



When key III is played, the result is a sound produced at the pitch of IV.



The cursor that is blinking on the screen can be moved by pressing the cursor buttons. Move the cursor to the left input position by pressing **Upper/◀** and to the right input position by pressing **A/▶**, and set the new data by selecting the value indicated by the cursor on the KR-4500.

### Operation

From the Master Screen :

- 1 Press **OCT SHIFT** to display the Octave Shift operation screen.



- 2 Use the **Upper/◀** and **A/▶** cursor buttons to move the cursor to the Part (Manual Bass, Lower or Upper) whose Octave Shift value is to be changed.



- 3 Set the amount of Octave Shift. Each time **INC** is pressed, the notes are raised by one octave; each time **DEC** is pressed, they are lowered by one octave. Notes can be raised or lowered by a maximum of two octaves.



Repeat steps 2 and 3 to set the shift for the other Parts as well.

- 4 After the Octave Shift has been adjusted, press **EXIT** to return to the Master Screen.

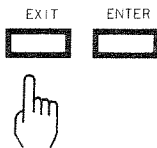

The Octave Shift setting for a particular Part can also be changed by pressing the Balance **▲** or **▼** button for that Part in the Octave Shift operation screen. When the **▲** and **▼** buttons are pressed together, the setting for the Part instantly returns to the factory default setting.

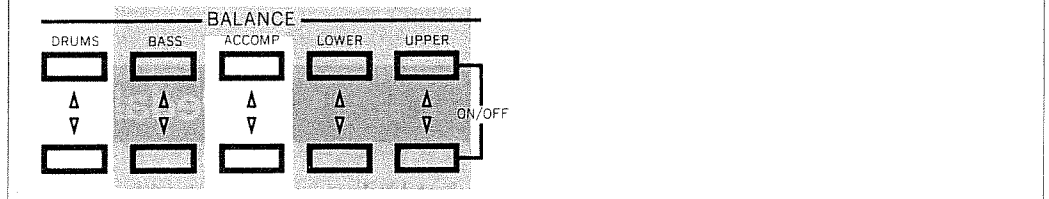

Octave Shift can be set independently for each of the Upper, Lower and Manual Bass Tones. Depending on the Tone concerned, however, Octave Shift may result in extending the sound far beyond the upper limit of the recommended range. This may result in duplicating an octave, producing no sound or duplicating an interval. (The recommended range for each Tone is slightly greater than the actual range which can be played by the corresponding acoustic instrument.)

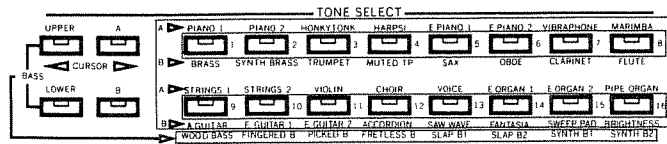

Since this sound can be set for either Upper or Lower Parts, settings for octave shifting can be worked for each of the Parts.

Since this sound can only be set for the Manual Bass Part, a setting for octave shifting can be worked for only the Manual Bass Part.

When the **LAYER** keyboard mode indicator is lit, the sound of the Lower Part Tone is produced in accord with any octave setting that has been made for the Upper Part. If, for instance, the Upper Part is raised by 2 octaves, the Lower Part Tone will be produced at a pitch that is two octaves higher, regardless of the Octave Shift setting for the Lower Part.

The **OCT SHIFT** indicator lights when Octave Shift has been set (to a value other than 0) for any Parts which can be played.

However, it does not light when Octave Shift for the Lower Part has been set to a value other than 0, but the **LAYER** indicator is lit and Octave Shift for the Upper Part has been set to 0.

This happens because Octave Shift for the Lower Part is automatically set to the Upper Part's Octave Shift setting of 0, due to the fact that the **LAYER** function is ON.

The Octave Shift setting for each Tone is retained in the unit's memory even after the power has been turned off.

## d. MIDI

There is no need to make any MIDI settings when you are using only this unit to create music. Refer to page 125 for further details about MIDI.

## e. Pedal

One of the 14 functions listed below can be assigned to the center pedal. The right pedal always functions as the damper. The pedal setting function may change when you switch the GS mode On and Off (Page 56). Please be aware of this when you playback Standard MIDI file data or data written on something other than a KR-series instrument.

The effect of these nine functions (excluding Sostenuto, Softening, Damper of Lower Tone, Repeat Note ON and Punch In/Out), which can be produced by the two pedals, is the same as when the button in parentheses has been pressed.

### Center pedal

- Sostenuto
- Repeat Note  
When this function is set, the Repeat Note (P. 52) is activated when the pedal is depressed.
- Leading bass (LEADING BASS)  
When this function is set, it is activated when you depress the pedal.
- Punch In/Out  
Each tap on the pedal can then be used to switch the Composer between recording and playback.
- Arranger start/stop (START/STOP)
- Composer start/stop (PLAY), (STOP)
- Intro/Ending (INTRO/ENDING)
- Fade-in/Fade-out (FADE)
- Fill-in to Variation (TO VARIATION)
- Fill-in to Original (TO ORIGINAL)
- Split ON/OFF (SPLIT)
- Basic/Advanced Arrangement selection (BASIC/ADVANCED)
- Damper of Lower Tone  
When this function is set, the Lower Tone can be sustained.

### Left pedal

- Soft
- One of 12 functions (that is, all the functions (except Sostenuto) can be assigned to the center pedal)

When the Layer mode has been selected as the keyboard mode, the right pedal damper affects both the Upper and Lower Tones, regardless of the functions assigned to the other pedals.

Sostenuto control is factory-set to the center pedal, whereas Soft control is set to the left pedal. Default settings will be in effect whenever the power is turned ON.

### Operation

From the Master Screen :

- ① Press (PEDAL) to select the setting screen for the desired pedal.

Each time (PEDAL) is pressed, the center pedal operation screen and left pedal operation screen appear alternately in the display.

```
CENTER PEDAL to:
SOSTENUTO
```

```
LEFT PEDAL to:
SOFT
```

The same function cannot be set to two pedals.

When **INC** and **DEC** are pressed at the same time while in the center pedal or left pedal operation screen, the pedal function is restored instantly to the factory default setting. The Sostenuto function is restored if the center pedal operation screen is displayed; the Soft function is restored if the left pedal operation screen is displayed.

The range is set to 12 (1 octave) for the Manual Drum and Manual Sound Effects and cannot be changed.

- ② Select the function to be set using **INC** and **DEC**.



- ③ Repeat steps ① and ② to set a function for each pedal in turn.

- ④ Press **EXIT** to return to the Master Screen.

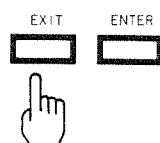

When the playing mode is changed in the One Touch Program mode, (P.21) the pedal functions will also be changed at the same time to settings which are in keeping with the type of music being played.

**When PIANO is selected :**

Center pedal : Sostenuto

Left pedal : Soft

**When SPLIT ARRANGER or PIANO STYLE ARRANGER is selected :**

Center pedal : Function currently assigned

Left pedal : Function currently assigned

Damper provided by the right pedal affects only the Upper Part when the keyboard mode is set to Split; at all other times, they affect all the keys. (See page 12 for the keyboard modes.) And in the Split mode, the soft or sostenuto control affects both the Lower and Manual Bass parts.

## f. Pitch Bend Range

The maximum amount of change in the pitch bend effect (Pitch Bend Range) can be set for the Upper, Lower and Manual Bass Parts.

### Operation

From the Master Screen :

- ① Press **UTILITY** several times until the Pitch Bend Range operation screen appears.

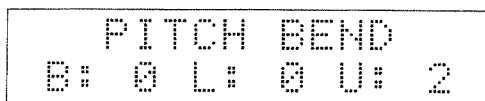

- ② Use the **Upper/◀** and **A/▶** cursor buttons to move the cursor to the Part (Manual Bass, Lower or Upper) whose Pitch Bend setting is to be changed.

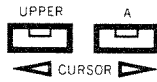

- ③ Adjust the amount of change. The range increases by a half step (semi tone) each time **INC** is pressed and decreases a half step each time **DEC** is pressed.



The amount of change corresponds to the following settings :

- 0 = No change
- 1 = Minor second (One Half step)
- 2 = Major second (Two Half steps)
- 3 = Minor third (Three Half steps)
- 4 = Major third (Four Half steps)
- 5 = Perfect fourth (Five Half steps)
- 6 = Augmented fourth (Six Half steps)
- 7 = Perfect fifth (Seven Half steps)
- 8 = Augmented fifth (Eight Half steps)
- 9 = Major sixth (Nine Half steps)
- 10 = Minor seventh (Ten Half steps)
- 11 = Major seventh (Eleven Half steps)
- 12 = One octave (Twelve Half steps)

Repeat steps ② and ③ to set the range for each of the Parts.

- ④ Upon completion of the adjustments, press **EXIT** to return to the Master Screen.

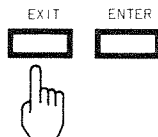

The Pitch Bend Range of a particular Part can also be set by pressing the **△** and **▽** Balance buttons for that Part on the Pitch Bend Range operation screen. When the **△** and **▽** buttons are pressed at the same time (or when the **INC** and **DEC** buttons are pressed at the same time), the Pitch Bend Range of the Part returns instantly to the factory default setting.

A broad Pitch Bend Range can also be set to achieve a dynamic effect, but control is easier for normal play if the range is set to a value between 1 and 3.

The factory-set range is 2 half steps (major second) for the Upper Part, and 0 for the Lower and Manual Bass Parts. The range returns to the factory default setting each time the power is switched ON.

The Repeat Note can provide play of a chord's notes (one after another) only while a pedal with the Repeat Note function assigned to it is depressed. (See page 48 for further details on the pedal.)

By having two sounds played, you can obtain an effect similar to that produced by twin mallets, or a mandolin. Chords can be played to create arpeggio patterns. You may find that such patterns can be successfully used to create stunning ad-lib pieces, especially if you keep the rate set at a minimal setting. Also, with Manual Drums selected, you can produce drum rolls by pressing a number of keys.

\*An arpeggio is a performance technique whereby the notes of a chord are repeated in sequence, rather than having them played simultaneously. (Also sometimes called a "broken" chord.)

## g. Repeat Note (Arpeggio)

The Repeat Note function can be used to create arpeggios\* or play single sounds in rapid succession, depending on the settings.

The arpeggio function works with the Upper Part, and the Repeat Note function works for Manual Drums and the Manual Sound Effects Part.

### RATE

This sets the repeat rate and rhythm. There is a choice of 9 settings :  $1/8$ ,  $1/8$  TRIPLET,  $1/8$  SWING,  $1/16$ ,  $1/16$  TRIPLET,  $1/16$  SWING,  $1/32$ ,  $1/32$  TRIPLET and  $1/32$  SWING. When, for instance,  $1/8$  is set, 8 sounds are produced in the space of a single bar in the sequence set by MODE.

The factory-set mode is  $1/32$ . The rate returns to the factory default setting each time the power is turned ON.

```
REPEAT NOTE
RATE: 1/32
```

### MODE

This sets the sequence in which the notes of the chord are to be played. There are three possibilities : UP, DOWN and UP DOWN.

The factory-set default is UP. The mode returns to the factory default setting each time the power is turned ON.

```
REPEAT NOTE
MODE: UP
```

Example)

The following arpeggio effects are produced when a "C" chord (containing Do, Mi and So) is played :

UP : Chord played in sequence of Do → Mi → So → Do → Mi → So.

DOWN : Chord played in sequence of So → Mi → Do → So → Mi → Do.

UP DOWN : Chord played in sequence of Do → Mi → So → Mi → Do → Mi → So.

When **INC** and **DEC** are pressed at the same time in the Repeat Note operation screen, the displayed setting returns instantly to the factory default setting.

### Operation

From the Master Screen :

- 1 Press **UTILITY** until the Repeat Note operation screen appears.

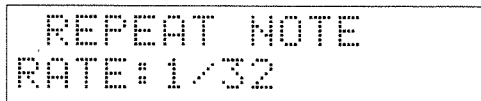

- 2 Use the **Upper/◀** and **A/▶** cursor buttons to move the cursor to the RATE or MODE setting.



- 3 Change the setting using **INC** and **DEC**.



Repeat steps ② and ③ to change the setting to that matching the style of music.

- 4 Press **EXIT** to return to the Master Screen.

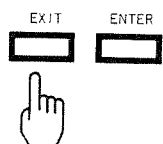

## h. Keyboard Sensitivity

The change in the volume and timbre obtained by playing dynamics is selected as one of three levels.

- 1 (Light) : With this setting, a fortissimo effect is produced with a touch lighter than usual.
- 2 (Standard) : This is the usual setting and most closely duplicates the response of an acoustic piano.
- 3 (Heavy) : With this setting, a fortissimo effect requires a touch heavier than usual.

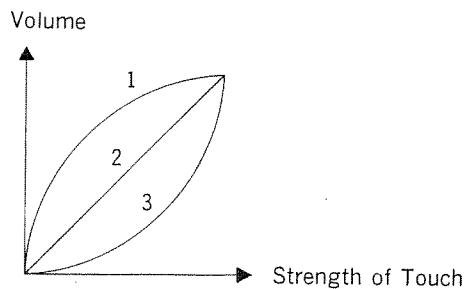

When **INC** and **DEC** are pressed at the same time in the Keyboard Sensitivity operation screen, the level returns instantly to the factory default setting of "2."

### Operation

From the Master Screen :

- 1 Press **UTILITY** until the Keyboard Sensitivity operation screen appears.



- 2 Change the setting using **INC** and **DEC**.



- 3 After the changes have been made, press **EXIT** to return to the Master Screen.

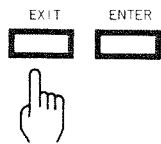

"2" is the factory default setting. The level returns to the factory default setting each time the power is turned ON.

## i. Contrast

This enables the display contrast to be adjusted over 10 levels. The display becomes darker as the setting is increased.

### Operation

From the Master Screen :

- 1 Press **UTILITY** until the Contrast operation screen appears.

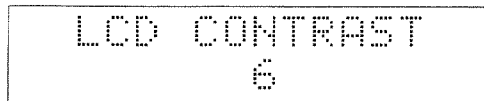

- 2 While monitoring the display, set the Contrast using **INC** and **DEC**.



- 3 Press **EXIT** to return to the Master Screen.

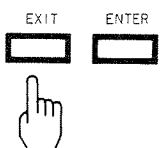

The Contrast setting will remain stored in the unit's memory even while power is turned off.

When **INC** and **DEC** are pressed at the same time in the Contrast operation screen, the level returns instantly to the factory default setting of "6."



## j. Metronome Level

This enables the metronome volume to be adjusted from 0 to 100. The volume increases as the number increases.

### Operation

From the Master Screen :

- 1 Press **METRONOME** to start the metronome.

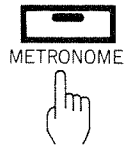

- 2 Press **UTILITY** until the Metronome Level operation screen appears.



- 3 While monitoring the sound, set the volume to the appropriate level pressing **INC** or **DEC**.



- 4 Press **EXIT** to return to the Master Screen.

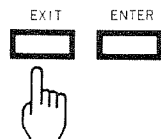

When **INC** and **DEC** are pressed at the same time on the Metronome Level operation screen, the volume level returns instantly to the factory default setting of "50."

The Metronome Level setting will remain stored in the unit's memory even while power is turned off.

## k. GS Mode

When the GS Mode is set to ON, the sound generator inside the KR-4500 can be made to operate in conformity with the GS Format. Besides setting this parameter value to ON using the panel controls, the GS Mode can also be set to ON using reception of the "GS Reset" Exclusive Message (P.128).

All song data (SMF Music Data, etc. P. 140) stored on floppy disks carrying the GS mark have the "GS Reset" Exclusive Message at the beginning of every song. Therefore, when a song is reproduced by the Composer, the GS Mode is automatically set to ON. This means that there is no need to set this parameter to ON prior to playback.

If the GS Mode is returned to OFF, the unit will return to the same playing mode as before the GS mode is set to ON.

Setting the GS mode to ON changes the settings of the parameters below.

Parameter	GS Mode setting
Master Tune	440.0 Hz
Transpose	C
Octave Shift	All 0
Pitch Bend Range	All +2
Part Balance	All 80
Reverberation Type	5 (Hall 2)
Reverberation Part	All ON
Chorus Type	3 (Chorus 3)
Chorus Part	All OFF

### Operation

From the Master Screen :

- Press **UTILITY** until the GS Mode operation screen appears.

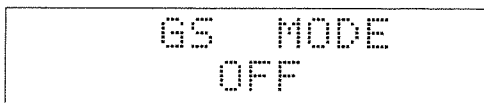

- Set the mode to ON or OFF using **INC** and **DEC**. When the mode is set to ON, the GS basic setting (or, in other words, the GS mode) is established; when it is set to OFF, the regular playing mode is in effect.



GS Mode setting can not be changed during Composer playback.

The mode is set to OFF instantly when **INC** and **DEC** are pressed at the same time.



When the ON mode is selected in step ②, the Master Screen changes as follows.

```
GS MODE  a11 a11
└ 60
```

③ Press **EXIT** to return to the Master Screen.

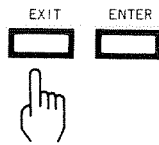

Style play is disabled during playback of SMF Music Data. If you try to play a style during a playback, you'll see the following message.

```
ARRANGERinactive
during playback
```

In this case, press **STOP** or **RESET**, and after Composer playback stops you can start up again with the Style Play. Setting up Style Play while the Composer playback is stopped automatically turns off GS Mode, and automatically enables Style Play.

## 2. Adjusting the Level of Each Part

Using the Balance buttons (**▲** and **▼**) in the Balance section, the volume of individual Parts can be adjusted. Volume settings in the range of 0-100 are acceptable.

Additionally, by simultaneously pressing both **▲** and **▼** for a particular Part, that Part will be muted (no sound at all will be output).

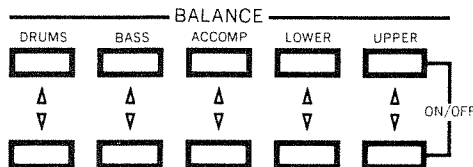

These two settings (Volume Balance and Muting) for each Part return to the factory default settings each time the power is turned ON.



The buttons allow you to make single step changes with each press; or if you hold them down, a continual increase (or decrease) is obtained.

## a. Upper Part

### Operation

From the Master Screen :

- ① Press the appropriate Upper button ( $\triangle$  or  $\nabla$ ) in the Balance section to obtain the screen used to set the Upper Balance.

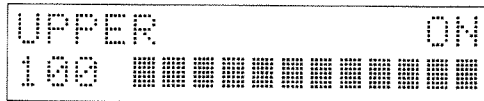

- ② To raise the volume, press  $\triangle$ . To lower it, press  $\nabla$ .

### ○ Muting the Upper Part

### Operation

From the Master Screen :

- ① Press the Upper buttons  $\triangle$  and  $\nabla$  simultaneously. This instantly mutes the Upper Part without affecting the Balance setting.



- ② Press both  $\triangle$  and  $\nabla$  simultaneously, and the Upper Part is no longer muted.

## b. Lower Part

### Operation

From the Master Screen :

- ① Press the appropriate Lower button ( $\triangle$  or  $\nabla$ ) in the Balance section to obtain the screen used to set the Lower Balance.



Using the Lower buttons ( $\triangle$  and  $\nabla$ ), Balance and Mute can be set in the same manner as for the Upper Part.

With the indicator on **LOWER** lit, the Lower Part will sound only when the Keyboard is in the Split or Layer condition. However, during the Style Play of Intro / Ending the Lower Part will not sound.

## c. Accompaniment Part

### Operation

From the Master Screen :

- ① Press the appropriate Accompaniment button ( $\triangle$  or  $\nabla$ ) in the Balance section to obtain the screen used to set the Accompaniment Balance.

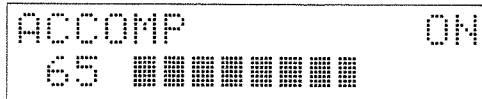

Using the Accompaniment buttons ( $\triangle$  and  $\nabla$ ), Balance and Mute can be set in the same manner as for the Upper Part.

The Accompaniment Part will produce sound only while a Style Play is playing.

## d. Bass Part

The Bass button can be used to make settings independently for both the Accompaniment Bass and Manual Bass.

### Operation

From the Master Screen :

- ① Select the Bass Part for which the setting is to be changed. With the indicator on **MANUAL BASS** off, the balance for the Accompaniment Bass Part can be adjusted. With the indicator on **MANUAL BASS** lit, the balance for the Manual Bass Part can be adjusted.
- ② Press the appropriate Bass button ( $\triangle$  or  $\nabla$ ) in the Balance section to obtain the screen used to set the Bass Balance.

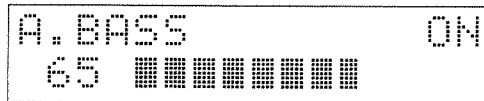

- ③ Using the Bass buttons ( $\triangle$  and  $\nabla$ ), Balance and Mute can be set in the same manner as for the Upper Part.

## e. Drum Part

The Drum buttons can be used to set the balance independently for both the Accompaniment Drums and Manual Drums / Manual Sound Effects Parts.

### Operation

From the Master Screen :

- ① Select the Drum Part for which the setting is to be changed.  
With the indicators on both **MANUAL DRUMS** and **MANUAL SOUND EFFECTS** off, the balance for the Accompaniment Drums Part can be adjusted. With any one of the indicators lit, whether it be **MANUAL DRUMS** or **MANUAL SOUND EFFECTS**, the balance for the Manual Drums / Manual Sound Effects Part can be adjusted.
- ② Press the appropriate Drum button (**△** or **▽**) in the Balance section to obtain the screen used to set the Drum Balance.

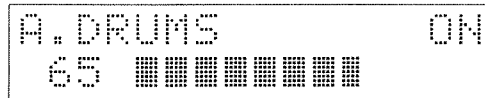

- ③ Using the Drum buttons (**△** and **▽**), Balance and Mute can be set in the same manner as for the Upper Part.

## 3. Adding Spaciousness to Sounds

Devices that add depth or modulation to a sound are called "effect units". The KR-4500 contains two digital effect units; Reverb and Chorus.

### a. Applying Reverberation

To add reverberation to sounds, turn on the Reverb effect. The effect will be applied to all Parts.



The Reverb setting returns to the factory default setting each time the power is turned ON.

Reverberation occurs as a combination of numerous reflected sounds that tend to linger on after the original sound. The KR-4500 provides a selection of Reverb Types so you can obtain just the ambience that you need for your music.



## ○ Turning Reverb On/Off

### Operation

- ① By pressing **ON/OFF** in the Reverb section, you can turn Reverb on and off.

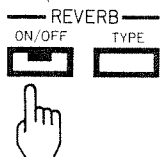

When the indicator is lit, the effect is on.

## ○ Selecting the Reverb Type

A selection of 8 Reverb Types is provided, allowing you to obtain exactly the ambience you wish.

- 1 = Room 1 : Provides the reverberation of a small room.
- 2 = Room 2 : Provides the reverberation of a small club.
- 3 = Room 3 : Provides the reverberation of a very large room.
- 4 = Hall 1 : Provides the reverberation of a small concert hall.
- 5 = Hall 2 : Provides the reverberation of a large concert hall.
- 6 = Plate : Provides a bright, metallic reverberation.
- 7 = Delay : Provides an echo-type sound.
- 8 = Pan Delay : A panned delay effect. Notes you play will repeatedly move between the left and right speakers.

### Operation

From the Master Screen :

- ① Press **TYPE** in the REVERB section to obtain the screen used to select the Reverb Type.

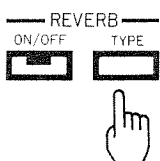

```
REVERB type
5 = Hall 2
```

- ② Use **INC** and **DEC** to select the desired Reverb Type.



- ③ Press **EXIT** to return to the Master Screen.

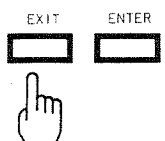

Hall 2 is the factory default preset.

To quickly revert to the factory default setting of Hall 2, press both **INC** and **DEC** from the screen used to select the Reverb Type.

## ○ Adjusting the Reverb Level for Individual Parts

Follow the procedure below to alter the extent to which Reverb is applied to individual Parts. For example, you could set it so a deep reverberation is applied to the Upper Part, and a shallow reverb is applied to the Lower Part.

### Operation

From the Master Screen :

- 1 Press **TYPE** in the Reverb section.

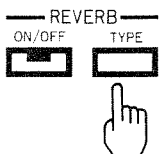

- 2 Press the Balance button (**△** or **▽**) for the Part for which you wish to make the change, and obtain the screen used to set the Reverb Level.

The Drum button can be used to set the Reverb Level independently for both the Accompaniment Drums and Manual Drums / Manual Sound Effects Parts.

With the indicators on both **MANUAL DRUMS** and **MANUAL SOUND EFFECTS** off, the Reverb Level for the Accompaniment Drum Part can be adjusted. With any one of the indicators lit, whether it be **MANUAL DRUMS** or **MANUAL SOUND EFFECTS**, the Reverb Level for the Manual Drums / Manual Sound Effects Part can be adjusted.

The Bass button can be used to set the Reverb Level independently for both the Accompaniment Bass and Manual Bass Parts.

With the indicator on **MANUAL BASS** off, the Reverb Level for the Accompaniment Bass Part can be adjusted. With the indicator on **MANUAL BASS** lit, the Reverb Level for the Manual Bass Part can be adjusted.

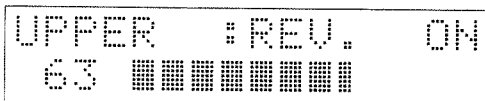
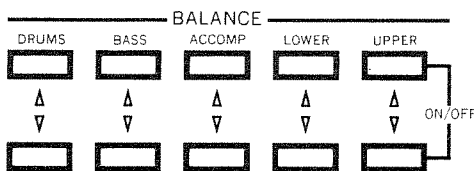

The Part which corresponds to the Balance button you have pressed will be shown in the display.

The buttons allow you to make single step changes with each press; or if you hold them down, a continuous increase (or decrease) is obtained.

If Reverb is OFF for all of the Parts, the indicator on **ON / OFF** will not light even if pressed, and reverberation will not be obtained. Note also that even if Reverb is ON for some Part, if the indicator on **ON / OFF** is dark, reverberation will not be obtained for that Part.

③ Press to select a deep reverb, and to select a shallow reverb.

Also, when you wish to have no effect at all, press and simultaneously. The following will appear in the display, and Reverb will no longer be applied to that Part.

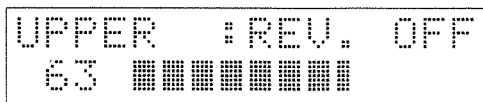

Once again, press and simultaneously, and Reverb will be applied at the level that appears in the display.

④ Press to return to the Master Screen.

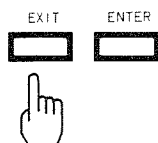

The Reverb that is applied to all Parts will be of the same type. (Reverb Type page 61)

## b. Adding a Feeling of Spaciousness to Sound~ Chorus

The Chorus effect results in sounds that are perceived as being more spacious and “fat”. This effect can be applied to these three Parts : Upper / Lower / Manual Bass.

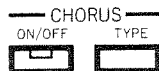

The Chorus setting returns to the factory default setting each time the power is turned ON.

### ○ Chorus On/Off

The Chorus effect can be controlled independently for each Part (Upper / Lower / Manual Bass).

#### Operation

① Using and in the Tone Select Section, select the Tone for the Part to which you wish to apply Chorus.

Upper Part : Press , and confirm that its indicator is lit.

Lower Part : Press , and confirm that its indicator is lit.

Manual Bass Part : Press and simultaneously, and confirm that their indicators are lit.

② Press in the Chorus section to turn chorus On/Off.

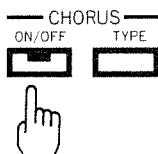

When the indicator is lit, the effect is ON.

The selection of Tones should be made in the same manner as explained in “Tone Select” ( P. 16).

Example) Applying Chorus to the Upper Tone.

### Operation

- 1 Press **UPPER** in the Tone Select Section, and confirm that its indicator is lit.

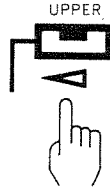

- 2 Press **ON / OFF** in the Chorus Section, and confirm that its indicator is lit.

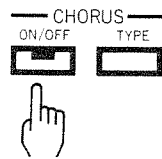

### Selecting the Chorus Type

The following four types of Chorus are available :

- 1 = Chorus 1 : slowly fluctuating, shallow Chorus.
- 2 = Chorus 2 : slowly fluctuating, deep Chorus.
- 3 = Chorus 3 : rapidly fluctuating, shallow Chorus.
- 4 = Chorus 4 : rapidly fluctuating, deep Chorus.

### Operation

From the Master Screen :

- 1 Press **TYPE** in the Chorus Section to obtain the screen used to set the Chorus Type.

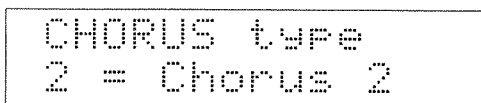

- 2 Using **INC** and **DEC** select the Chorus Type you wish.



- 3 Press **EXIT** to return to the Master Screen.

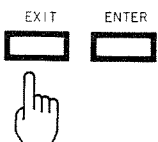

Chorus setting "2" is the factory default.

From the Chorus Type setting screen, pressing **INC** and **DEC** simultaneously will Select the factory default Chorus Type; Chorus 2.

The same chorus effect can be obtained for all parts (Tones) whose Chorus settings are on.

# 4. Tone Expansion Mode

## ~ Increasing the Number of Tones You Can Use

Ordinarily, the selection of Tones you have available totals 40 (including Bass sounds). However, once you select the Tone Expansion Mode, 128 different sounds become available.

The 128 Extension Tones are organized into 2 Groups; 8 Banks, and 8 Numbers.

Example) a15 E.Piano 1

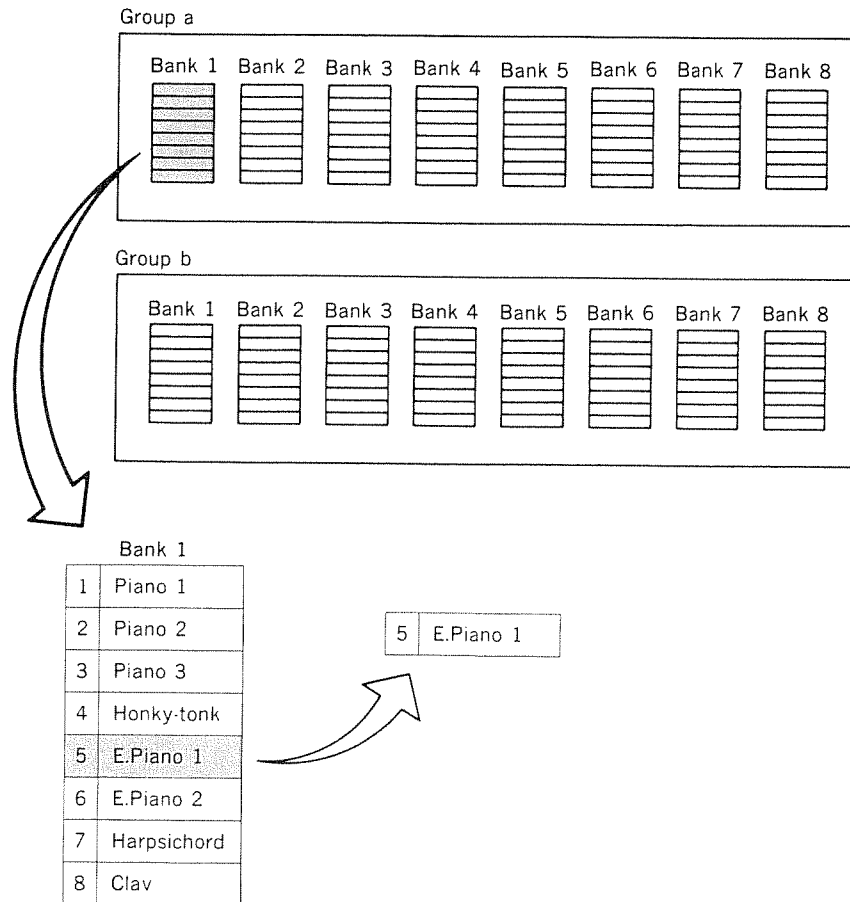

In the Tone Expansion Mode, the group buttons are used to select Group a and b, the upper row of Tone buttons is used to select from BANKS 1-8, and the lower row is used to select from NUMBERS 1-8.

The Tone number is chosen by using the Bank buttons for the first digit, and the Number buttons for the second digit.

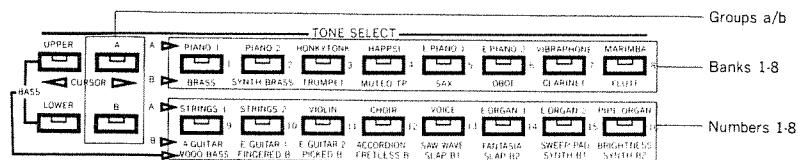

The "Expansion Tone List" (See P. 152) should be referred to when selecting Tones while in the Tone Expansion Mode.

Should the Tone you intend to select be located within the same Group and Bank that the currently selected one is, all you need do is press the appropriate Number button to achieve the change. For example, to switch from "a44 Clean Gt." to "a45 Mute Gt," simply press Number button (5).

Whenever you shift between Tone modes, that is when changing from the standard mode to the Tone Expansion Mode, or conversely, when switching back to the standard mode after being in the Tone Expansion Mode, the instrument will continue to produce the sound that was selected while in the former mode, until you specifically change it by making a new selection.

Example) Selecting "b44 Space Voice" for the Upper Tone.

#### Operation

From the Master Screen :

- ① In the Tone Select section, press (A) and (B) simultaneously to select the Tone Expansion Mode.

After these buttons are pressed, the display shown below will appear momentarily, and then you are returned to the Master Screen.

```
TONE SELECT MODE
Expansion
```

- ② Press (UPPER), and confirm that its indicator is lit.
- ③ Press (B), and confirm that its indicator is lit.
- ④ Press Bank button (4).
- ⑤ Press Number button (4).

The following will appear in the display.

```
UPPER Tone
b44 Space Voice
```

If you again press (A) and (B) simultaneously, the display shown below will appear momentarily. The unit will exit the Tone Expansion Mode and return to the standard mode.

```
TONE SELECT MODE
Normal
```

# 5. Music Style Expansion Mode

## ~Increasing the Music Styles You Can Use

In the standard mode, you have a choice of 32 Music Styles. However, if you set the unit to the Music Style Expansion Mode, you can add another 32, for a total of 64 Music Styles.

The 64 Music Styles are organized into 8 Banks and 8 Numbers.

Bank 1		Bank 2		Bank 3		Bank 4	
1	ROCK 1	1	8 BEAT 1	1	BOOGIE	1	SLSWING 1
2	ROCK 2	2	8 BEAT 2	2	ROCK'N	2	SLSWING 2
3	RAP	3	8 BEAT 3	3	TWIST	3	SWING
4	HOUSE	4	8 BEAT 4	4	CHARLEST	4	FOXTROT
5	DANCE	5	16 BEAT 1	5	SL ROCK 1	5	BIG BAND
6	FUNK 1	6	16 BEAT 2	6	SL ROCK 2	6	SHUFFLE
7	FUNK 2	7	16 BEAT 3	7	BALLAD 1	7	SW WALTZ
8	FUSION	8	16 BEAT 4	8	BALLAD 2	8	DIXIE

Bank 5		Bank 6		Bank 7		Bank 8	
1	BOSSA	1	SL WALTZ	1	PDOBLE	1	POP 1
2	SAMBA	2	WALTZ	2	KARS	2	POP 2
3	LATIN	3	MARCH	3	ANADOLU	3	POP 3
4	SALSA	4	POLKA	4	ARAB	4	POP 4
5	CHACHA	5	BAROQUE	5	MALFOUF	5	POP 5
6	RHUMBA	6	COUNTRY	6	KERONCNG	6	POP 6
7	MAMBO	7	BEGUINE	7	TROT	7	ROCK'N' ROLL
8	TANGO	8	REGGAE	8	ENKA	8	SWING 2

In the Music Style Expansion Mode, the upper row of Style Select buttons is used to select from BANKS 1-8, and the lower row is used to select from NUMBERS 1-8.

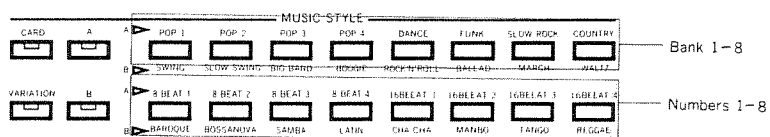

### Operation

- ① In the Music Style section, press **(A)** and **(B)** simultaneously (both indicators will flash). The Music Style Expansion Mode has now been selected.
- ② Specify the Bank by pressing a Style Select button in the upper row.
- ③ Specify the Number by pressing a Style Select button in the lower row.

To return to the standard mode, press **(A)** and **(B)** simultaneously.

## 6. Storing a Group of Panel Settings

### a. What is a User Program?

A group of panel settings (which you have determined as being most suitable for your purposes) can be stored together as a "User Program", and recalled whenever needed. Up to five such User Programs can be stored in the instrument's memory.

Settings for all the functions listed below can be stored within a User Program.

- Tone Select (for Upper, Lower, and Manual Bass Parts)
- Balance (volume of Upper, Lower, Accompaniment, Bass, Drums, and Mute setting)
- Music Style
- Tempo
- Variation (On/Off)
- Arranger (On/Off)
- Arranger Select (BASIC / ADVANCED)
- Keyboard Mode
- Lower (On/Off)
- Manual Bass (On/Off)
- Split Point
- Chord Hold (On/Off)
- Chord Intelligence (On/Off)
- Melody Intelligence (On/Off)
- Reverb (overall On/Off, Type, Level for each Part, On/Off for each Part)
- Chorus (On/Off for each Part, Type)
- Octave Shift (Upper, Lower, Manual Bass)
- Transpose
- Pedal Switches (Settings for Center and Left Pedals)
- Manual Drums (On/Off, Set)
- Manual Sound Effects (On/Off)
- Sync Start (On/Off)
- Sync Stop (On/Off)
- Leading Bass (On/Off)
- Intro (On/Off)
- Pitch Bend Range (Upper, Lower, Manual Bass Parts)
- Repeat Note (Mode, Rate)
- Keyboard Sensitivity

For the factory default settings of the five User Programs, refer to User Program (P. 159).

The unit's User Programs can also be stored separately on floppy disk (P. 118).

Any data that you have placed in the unit's memory will remain stored for about a month (if the unit's power has been left off.) For this reason, you will need to either periodically turn the unit on, or store a backup of such data on floppy disk beforehand, if you wish to make sure that it is not lost. (Floppy disk page 76)



## b. Calling up User Programs

You simply need to press one of the User Program buttons ((1) through (5)) to call up the corresponding Program.



### Operation

From the Master Screen :

- 1 Press the desired User Program button ((1) through (5)).

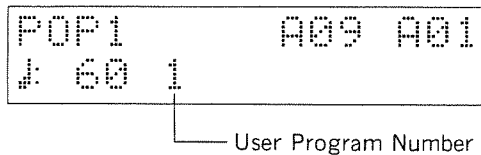
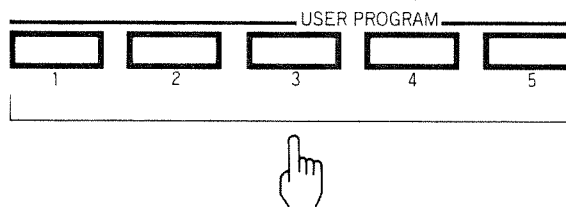

To cancel a User Program, press the same User Program button again. The User Program will now be cancelled and the previous panel settings will return.

## c. Storing Panel Settings

Five User Programs are available for storage of panel settings.

### Operation

From the Master Screen :

- 1 Make all the relevant panel settings.
- 2 Hold down **WRITE**.  
The following will appear in the display.

A rectangular display area showing two lines of text: "WRITE PANEL IN" on the first line and "USER PROGRAM ?" on the second line.

Be aware that any time you store a different set of panel settings to a User Program number, anything previously contained there will be erased. Note also that User Programs that have been altered or written over can be restored to their original factory default settings using the "Factory Setup" procedure explained in the following section. Whenever you have User Programs that you may wish to retain, you should always make a backup of them on floppy disk (→ P. 118) before storing anything new, or reverting to the factory defaults.

Should you mistakenly leave a floppy disk inserted in the drive while restoring the Factory Setup, you risk damaging whatever data was on the disk.

- ③ While continuing to hold (WRITE), press the target User Program button. Once pressed, the display shown below will appear briefly.

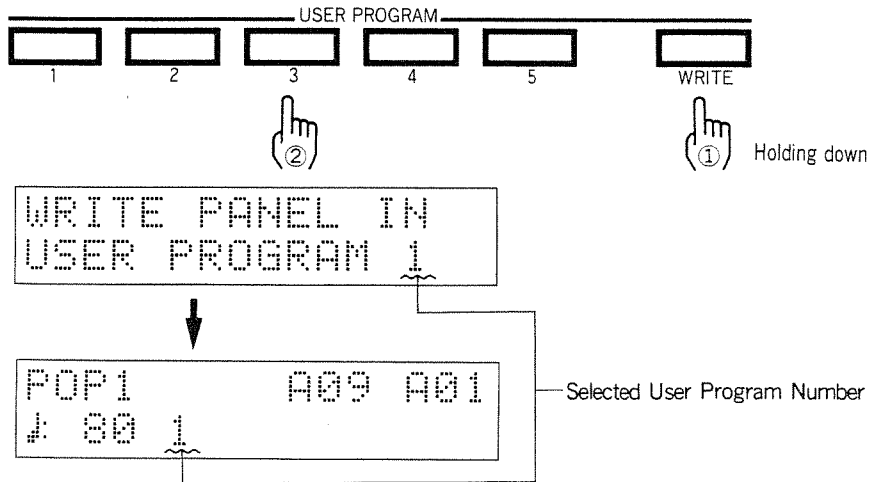

Storage of the User Program will have been completed when the Master Screen appears. The selected User Program number will be shown in the display.

## d. Factory Setup

The KR-4500 is equipped with a feature which allows you to restore all of the settings that were originally made at the factory.

### Operation

From the Master Screen :

- ① Check to make sure there is no floppy disk inserted in the drive.
- ② While holding down both (LOAD) and (SAVE), press (WRITE).

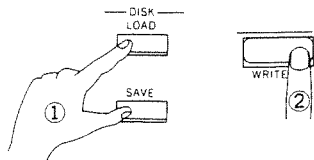

The following will appear in the display :

```
FACTORY SET UP
LOADED
```

During step ② above, the following will be shown momentarily in the display. This is normal and does not affect the Factory Setup procedure.

```
DISK NOT READY
PRESS>EXIT
```

**4**

**Composer**

# 1. Overview

## a. What is the Composer?

The Composer is in many ways similar to a tape recorder, since it allows you to record and then play back whatever has been performed on the KR-4500. Actually, it's more like a multi-track tape recorder, since you have a number of tracks available (page 75).

The Composer is also essentially a "sequencer," since it provides for the automatic play of the KR-4500's internal sound source in accord with recorded performance data ("sequences").

Note that as you play the KR-4500, it's not the sounds themselves that are recorded, but rather the data (in digital form) that describes what occurred during the performance. This data is used afterwards to recreate that performance, just the way it was played originally.

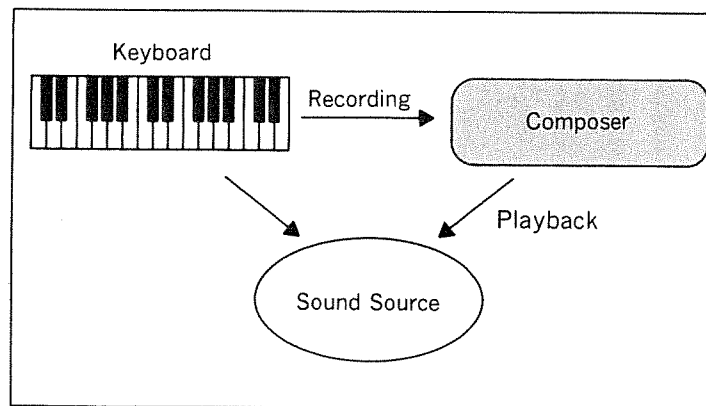

## b. Internal Memory and Floppy Disks

A tape recorder requires a reel of magnetic tape in order to record or playback a performance. With the Composer, however, the data that is recorded is stored in the KR-4500's internal memory, so recording/playback can be accomplished without the need for media such as tape. This might be sufficient as long as you do not turn off the power, since all data in internal memory will then be lost. However, if you wish to keep your recordings, you need to transfer them to something like the tape in a tape recorder, a "physical storage medium." The KR-4500 uses 3.5-inch micro-floppy disks for this purpose (hereafter referred to simply as "floppy disks"). Please refer to page 76 for important information concerning the handling of floppy disks.

The disk drive on the KR-4500 accepts either 2HD (double-sided high-density), or 2DD (double-sided double-density) 3.5-inch floppy disks. The KR-4500 automatically detects which kind of disk you have inserted, and proceeds accordingly.

## c. Disk Drive

The KR-4500 is equipped with a floppy disk drive, a device for transferring data from memory to disk (a "Save" procedure), and from disk to memory (a "Load" procedure).

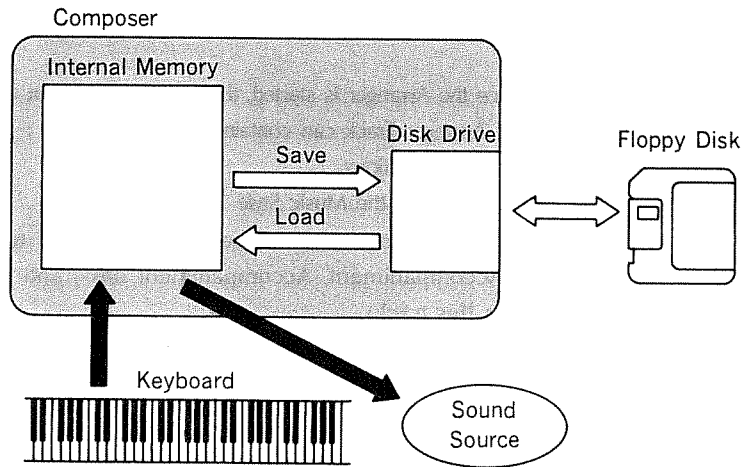

## d. Tracks

The Composer provides 5 tracks onto which performance data can be recorded, along with one other track for the Arranger. Remember that these tracks are for digitally recording the KR-4500's performance information, and do not record the sounds themselves.

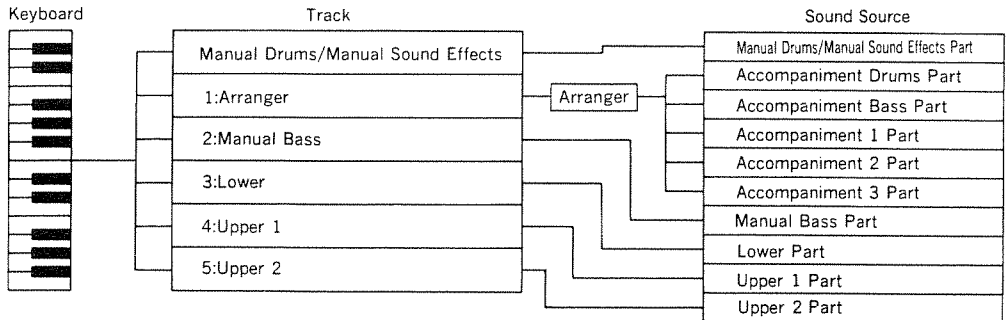

The rhythm data produced by selected Music Styles will also be recorded in the Arranger track.

- R : Manual Drums and Manual Sound Effects Track  
This track records the data you generate by playing any Manual Drums or Manual Sound Effects. And the tempo changes during recording will also be recorded.
  
- 1 : Arranger Track  
This track records data which describes whatever occurs while you operate the Arranger, such as its chord detection, as well as the timing of when you start/stop it.  
  
Once the Arranger is started, the following types of data will be recorded :  
The Arranger Track can contain the following data :
  - Chord selections
  - Changes of the Music Style
  - Changes made in the balance for a Part (data concerning changes in the balance of Accompaniment, Accompaniment bass, and Accompaniment drums Parts are recorded in this track).
  - Choices made for Music Styles, such as for Intro/Ending, Fade, Sync Start/Stop, Break, and Fill-in.
  
- 2 : Manual Bass Track  
This track records the data you generate by playing the Manual Bass Part (only while **MANUAL BASS** is ON).
  
- 3 : Lower Track  
This track records the data you generate by playing the Lower Part. (only while **LOWER** is ON).
  
- 4 : Upper 1 Track  
This track records the data generated while playing the Upper Part.
  
- 5 : Upper 2 Track  
This track also records the data generated while playing the Upper Part.

## e. Song

All the recorded data on these six tracks make up a "Song." The KR-4500 can store up to five songs (or about 40,000 notes) in its internal memory. However, if a song has a lot of notes in it, is particularly long, or you have extensively employed multi-track recording along with many of the other available features, there won't be room for five. Each song should have a Song Name assigned to it when it is saved to disk, and you can save a maximum of 99 (or 56) songs on one disk. (However, there might actually be fewer than 99 (or 56), for the same reasons mentioned above.)

One song can have a maximum of 999 bars in it.

A 2HD disk has about twice the recording capacity of a 2DD disk, so assuming your Songs all contain about the same amount of data, you could save quite a few more onto a 2HD disk (see P. 77, "Floppy Disk Capacity" for more about this).

## f. Multi-Track Recording

### ~The Composer versus Multi-Track Tape Recorders

In any multi-track recording, you are able to listen to whatever tracks have already been recorded, while playing and layering on yet other parts on different tracks.

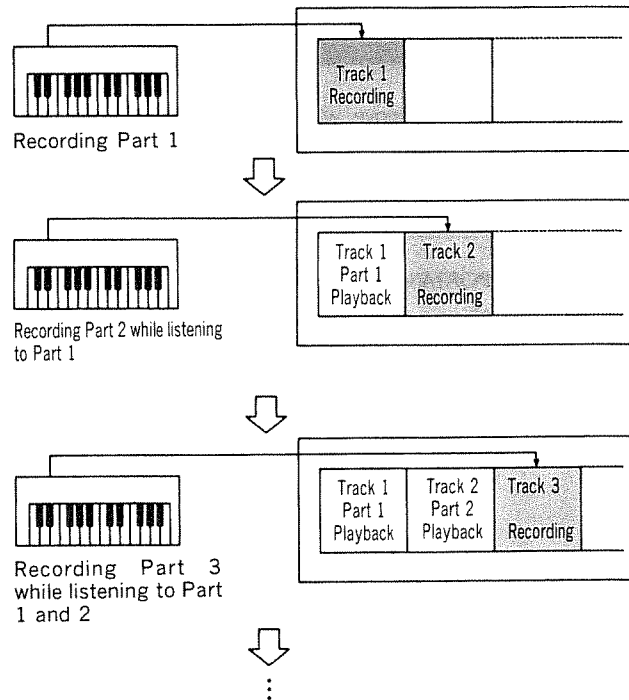

Although it will take a little more time, using the multi-track recording feature to record things one track at a time allows you to create songs that you could never have played all in one take. Those with experience using a multi-track recorder have already taken advantage of such capabilities using tape. The Composer however, also provides the following advantages :

○ **Since what you are recording is digital performance data :**

- No matter how many layers of recording you do, there won't be any loss of sound quality.
- No crosstalk occurs (where portions of what was recorded on one track can be heard on adjoining tracks).
- Finding the start of songs, and fast forward and rewind operations are almost instantaneous.
- The data can be stored conveniently on small floppy disks.

○ **Since it is not the sound itself, but rather performance data which has been recorded :**

- You can easily change the tempo of playback without changing the pitch.
- You can change Tones or Music Styles during playback whenever you want.
- You can "correct" the timing in your performances after recording (this is called "Quantizing").
- You can Copy or Delete part or all of the data.

The only limitation one could think of is that the instrument is designed for recording digital data only. So you can't just plug in a microphone and record acoustic instruments or vocals.

## 2. Floppy Disks

The KR-4500 can use 3.5-inch MF2-DD or MF2-HD disks (sold separately) for storing your songs or User Program settings.

### a. Formatting Disks (Initialization)

As mentioned above, when the power is turned off, all data stored in the KR-4500's internal memory is lost. This is where floppy disks come in. But before you can use brand new floppy disks, or ones that were previously used on a different machine, you have to first "Format" them in the KR-4500.

#### IMPORTANT!

- All new disks must be formatted before they can be used.
- Any data previously contained on a disk is erased when you format the disk.
- A disk used with some other device must also be formatted before it can be used with the KR-4500.

If the disk drive indicator is brightly lit, it means the disk drive is still operating, and you should wait until it's done before removing the disk.

The KR-4500 is able to carry out the formatting operation as part of the process of saving data (it is not necessary for floppy disks to be formatted before saving data!). For details, refer to the explanation for the "Storing the Data on a Floppy Disk" (P. 85)

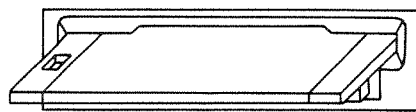
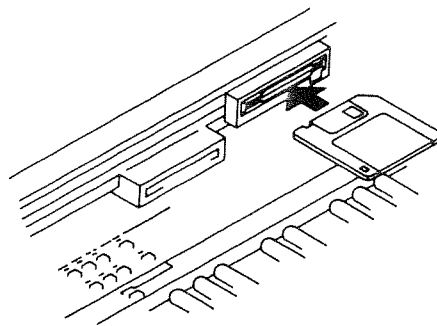

Insert the disk

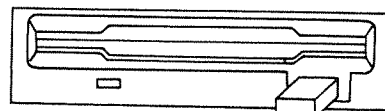

The Eject button will pop out

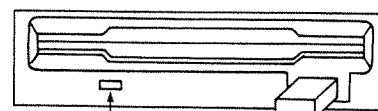

Disk Drive Indicator

Press the Eject button



The KR-4500 automatically distinguishes whether an inserted disk is of the 2DD or 2HD type, and formats it accordingly.

## b. Formatted Disk Capacity

As we have mentioned, the KR-4500 can use two types of disks, 2HD and 2DD. The KR-4500 can tell which kind you have put into the disk drive and automatically format it correctly. The 2HDs will be able to store about twice as much data as the 2DDs. In terms of kilobytes (KB), this is :

2DD...720 KB  
 2HD...1440 KB

The amount of data which can be stored on each of these disks is shown below.

Disk Type	Songs	Note Storage
2DD	56	approx. 80,000 notes
2HD	99	approx. 160,000 notes

## c. Disk Write Protect Tab

There is a "Write Protect Tab" on every disk that, when set to PROTECT (ON), will not let you perform a Save or Format, operation. This is to protect data stored on the disk. You should leave the tab in this position most of the time, and only slide it over to the WRITE (OFF) position just before inserting the disk into the disk drive for a Save or Format procedure. After you're done, slide it back to PROTECT (ON).

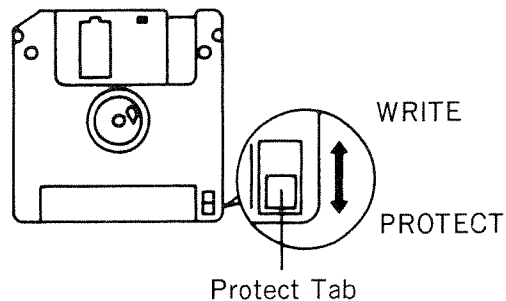

# 3. Recording

You should now be ready to try recording something. When you use the Composer, the performance data is stored directly into the KR-4500's internal memory, so you don't need to insert a floppy disk just to do a little recording and playback. However, everything in memory is lost when you turn off the power, so you will need to save it to disk eventually, if you want to keep the end result (P. 85).

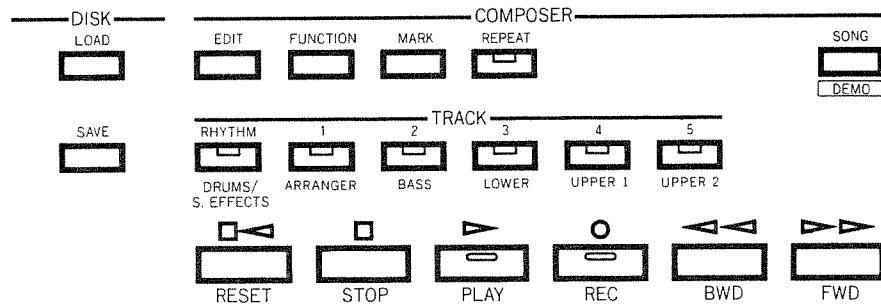

## a. Recording Your Style Play

The time signature used will be the same as that of the Music Style you select. (If this were a recording where you did not play a Style, you would first need to set the time signature using the Composer's "Function" feature.)

### Operation

From the Master Screen :

- ① Make all the settings necessary to play a Music Style.
- ② Press **REC**.

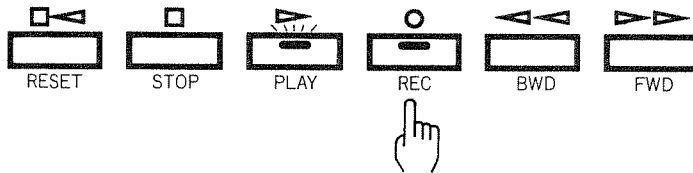

Performance data that is unrelated to what the selected tracks (Parts) are specialized for will not be recorded.

For example, when only the

**4/UPPER 1**

indicator is flashing, only that which is played on the Upper Part will be recorded. Even if the Arranger is ON and you have played along with it, the auto-accompaniment will not be recorded; only the Upper Part will be recorded.

- ③ In the Track section, press Track Select buttons (the row from **RHYTHM/DRUMS,S.EFFECTS** – **5/UPPER 2**) corresponding to the track you want to record on.

The Composer provides a selection of six tracks, each with its own Part (see page 73). Select tracks for the Part you want to record.

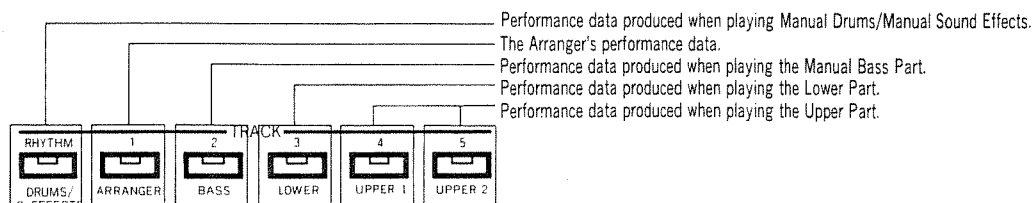

Immediately after pressing **REC**, any track can be made the target for the recording by pressing the relevant Track Select button (one that is not already lit), and getting its indicator to start flashing.

Pressing the same button a second time turns its indicator off, which means that recording will not take place on that track.

With each press of the button, the indicator is either turned off, or will begin flashing.

If immediately after pressing **REC** there are Track Select buttons that are lit, this means that there is data already contained in those tracks. Pressing any such buttons will cause the indicator to start flashing, indicating that you can go ahead and re-record onto that track (using "Replace" or "Mix" recording). If you press it one more time, the indicator goes out, meaning that the track will thereafter be muted (will not sound) during multi-track recording.

With each press of the button, the indicator changes to one of three possible states in this order :

- Flashing : Track is targeted for the recording.
- Off : Track onto which nothing will be recorded.
- Lit : Track has already been recorded.

If you wish to record while changing the tempo during play, be sure that you press the "R: Manual Drums/Manual Sound Effects track button" so that the indicator on it is flashing.

If the Upper 2 part has been selected for recording, every operation which has been made for "Upper" will only affect to the Upper 2 (no change will occur on the Upper 1).

If both Upper 1 and Upper 2 have been selected for recording, the Upper 1 part can be played and recorded using the Keyboard of this unit and the Upper 2 part can be played and recorded using the connected MIDI device (P.125). In this condition, the changes in panel settings will not affect to the Upper 2 part.

- ④ There are four ways to start Music Style play (P. 29) and Recording simultaneously.

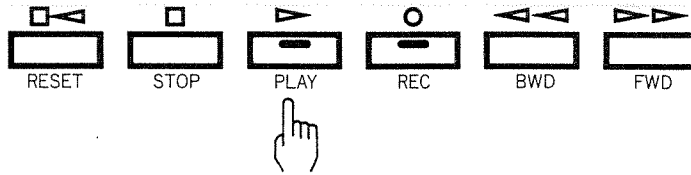

When you start recording following steps ③ and ④ above, the recording will be in the time signature of the Music Style you have selected. If you're recording without playing a Music Style, you'll need to first use the Function button in the Composer section to set the time signature.

If you change the Tones or Music Style, the display will return to the Master Screen. In this case, press (PLAY) when you once again want to check the current tempo, song number and song name. (P.109)

Recording cannot be started if a Music Style has been started first. Also, once you press (STOP) during a recording in which you have a Style playing, the Music Style will automatically stop at the same moment.

Every new song you record is initially given a temporary name (like a "KR-01"), which you can alter later (P. 110).

While recording, if you try to choose a Music Style with a different Time Signature than the Music Style selected in step ①, the following message is displayed and the Music Style does not change.

BEAT MISMATCH  
PRESS>EXIT

This message is also shown if, while recording, you select a Music Style with a Time Signature different from the one set using the (FUNCTION) button on the Composer section.

- ⑤ When you're done playing, press (STOP) or (RESET) to stop recording.

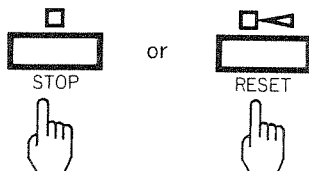

To stop recording you can press either (STOP) or (RESET). However, there is a difference between these two methods :

- (STOP) leaves you at the very bar where you pressed the button.
- (RESET) takes you back to Bar 1.

When you're done recording, the Track Select buttons for each track you just recorded will be lit.

The Basic Tempo will automatically be set whenever recording is to occur in a Song for the first time.

Consequently, if you select the same Song and try to rerecord it, the tempo will automatically return to the Basic Tempo value when playback. In this case, you can obtain the desired tempo by changing the setting of Basic Tempo (P.111).

Once you record something, the Basic Tempo and Time Signature are automatically set, even if you use Replace Recording after that. When you want to rerecord a song from the beginning, you'll have to first delete the performance data on all tracks with the Delete function.

## 4. Playback

You cannot use a Music Style with a time signature that is different from that of the recorded piece that is currently playing. If you attempt to do so, the message shown below will appear in the display.

You should always select a Music Style that matches the recorded time signature.

BEAT MISMATCH  
PRESS>EXIT

Now try playing back the data you just recorded. If you're not too impressed with your playing the first time around, you can always go back later and re-record the track. You can listen back to what you have played on the KR-4500 using any of the various playback methods explained below.

### a. Playing Back Song Data

While playing back song data from the Arranger track, you can freely change Music Styles or adjust the tempo.

#### Operation

From the Master screen :

- 1 Press **PLAY**.  
Play starts as soon as you press the button.

By holding down **STOP** while you press **PLAY**, two bars of Count-In phrase will be sounded at the beginning of the song.

- 2 Play stops automatically when the song is over. If you want to stop in the middle, press **STOP** or **RESET**. Play stops no matter which you press, the only difference being that **STOP** leaves you at the very bar where you pressed the button, and **RESET** takes you back to Bar 1.

If you change the Tones or Music Style, the display will return to the Master Screen. In this case, press **PLAY** when you once again want to check the current tempo, song number and song name (≡P.109)

### b. Rewind (BWD)

The **BWD** button operates like the Rewind button on a tape recorder. Here, however, the following screen will appear when the button is pressed. You'll move backward one bar for every press of **BWD** or you can rewind continuously by holding the button down.

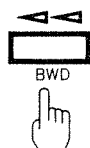

♩: 60 MEAS. 130  
S1> Song Name1

Press **BWD** to move to the previous measure(s).

After rewinding, press **PLAY**, and playback will start from the Measure Number displayed on the screen.

## c. Fast-Forward (FWD)

The **FWD** button operates like the Fast-Forward button on a tape recorder. Here, however, the following screen will appear when the button is pressed. You'll move forward one bar for every press of **FWD**, or you can fast-forward continuously by holding the button down.

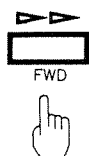

♩ 60 MEAS. 130  
51 > Song Name1

Press **FWD** to move to the next measure(S).

After fast-forwarding, press **PLAY**, and playback will start from the Measure Number displayed on the screen.

## d. Changing the Playback Tempo with the Tempo Slider

You can change the playback tempo of the music simply by moving the Tempo slider.

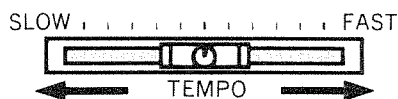

The Basic Tempo will automatically be set whenever recording is to occur in a Song for the first time.

Consequently, if you select the same Song and try to rerecord it, the tempo will automatically return to the Basic Tempo value when playback. In this case, you can obtain the desired tempo by changing the setting of Basic Tempo (see P.111).

Tempo changes can be really handy when you're recording a difficult piece -- you can slow it down so it's playable while recording, then speed it up again with the slider during playback.

You can also change the tempo before playback using the Tap Tempo button; see page 33 for more information.

## e. Muting Tracks During Playback ~ Track Mute

A lit track button means that track has something recorded on it. You can "mute" that track (keep it from sounding) either during playback (or before pressing **PLAY**) by pressing the Track Select button (**RHYTHM/DRUMS,S.EFFECTS**) - (**5/UPPER 2**) so that the indicator goes out.

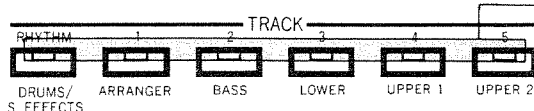

Performance data is stored in tracks where the corresponding indicator is lit.

Press it one more time (to light the track button again) and enable play.

Pressing **RESET** turns Repeat off. However, you can't switch Repeat on and off by pressing **REPEAT** during playback.

The KR-4500 automatically assigns a Song Name like a "KR-01" to a recorded Song. You can change this name whenever you like.

## f. Repeat - Playback

Using the Block Repeat function you can have a particular section of a piece play over and over. Before pressing **PLAY**, press the **REPEAT** button so that the indicator comes on (for more information on Block Repeat, see page 113).

Now when you press the **PLAY** button, the KR-4500 will start playback from the first measure indicated in the Block Repeat range. When the last measure is reached, playback starts over again from the first measure, and so on.

# 5. Save / Load

Storing the data for a Song onto a disk is called a "Save." You should always name the Song before you save it onto disk.

## a. Giving the Song a Name ~ Song Name

A disk can hold a lot of songs, so you'll want to give them some kind of name to help identify them. A Song Name can be composed of up to 12 numbers and letters.

### Operation

From the Master Screen :

- 1 Press the **FUNCTION** button in the Composer section.

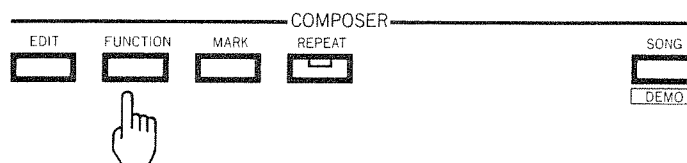

- 2 Press **INC** or **DEC** to select this screen :

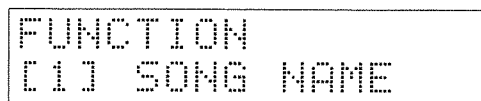

- 3 Press **ENTER** to go to the screen for entering the Song Name.

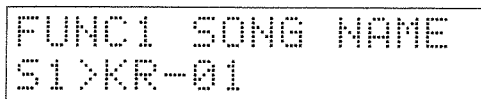
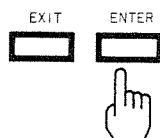

- ④ Press the **UPPER** and **A** buttons to move the cursor to the position where you want to enter the characters.

```

FUNC1 SONG NAME
S1>KR-01
  
```

**UPPER**  
 Press this button to move the cursor to the left.

**A**  
 Press this button to move the cursor to the right.

- ⑤ Press the **INC** or **DEC** buttons to select the characters. The characters available will appear in the following order :

...xyz0123456789 !" # % & ' ( ) \* + , - . / : ; = ? ^ \_ ABCDEFGHIJKLMNOPQRSTUVWXYZ  
 Yzabcdefghijklmnopqrstuvwxyz012...

**INC** steps you through the characters in the order shown, **DEC** in the reverse order.

- ⑥ Repeat steps ④ and ⑤ until the Song Name is complete.  
 ⑦ Press **ENTER** to register the name.

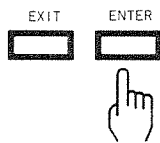

- ⑧ Press **EXIT** to return to the Master screen.

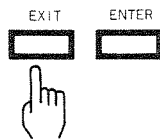

Should you wish to cancel the Song Name process, press the **EXIT** button to return to the Function Menu Screen.



## b. Storing the Data on a Floppy Disk ~ Save

As we have mentioned, the performance data stored in the KR-4500 is lost when the power is turned off; so if you want to store data for the long-term, you should save it to a floppy disk beforehand.

The disks that you store data on can be either the 2HD or 2DD type.

You may format disks in a separate operation with the Format function (P.115).

In there is no song data which can be saved when you press **(SAVE)**, the following screen will appear :

```
SAVE USR PROGRAM  
PRESS>WRITE
```

Even after entering the Save procedure, brand new disks, or disks that were previously formatted for other devices, can be formatted.

### Operation

From the Master Screen :

- ① Move the Write Protect Tab to the WRITE (OFF) position and insert the disk into the disk drive.

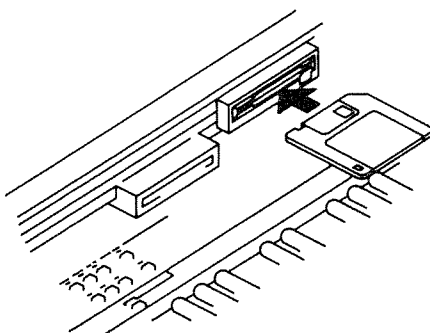

- ② Press the **(SAVE)** button.

If this is a disk that has already been formatted for use on the KR-4500, a Song Name appears in the display.

```
SAVE SONG  
S1>KR-01
```

If you have inserted a brand new disk, or one that has been used by a different machine, you'll see the following screen after pressing the **(SAVE)** button :

▼Brand new disk

```
UNFORMAT DISK  
PRESS>EXIT
```

▼Disk used by a different machine

```
IMPROPER DISK  
PRESS>EXIT
```

Press **(EXIT)**.

```
FORMAT DISK  
PRESS>ENTER
```



If you press **PLAY** instead of **ENTER** in step ④, the Song will automatically start playback as soon as all the data has been loaded.

④ Press **ENTER**, and the data will be loaded from disk.

```
SONG LOADING...
S1> Song Name 1
```

When the Load procedure is finished, you'll see the following display for a moment before being returned to the Master Screen.

```
LOAD COMPLETED
S1> Song Name 1
```

If there's already some data in the KR-4500's memory when you try to start the Load procedure in step ④, you'll see the following screen

```
OVERWRITE SONG
SURE?PRESS>ENTER
```

Press **ENTER** if you're sure you want to go ahead and load the new data, and delete the data that's already there (this is called "overwriting" the old data). If instead you decide that you actually did want to keep the material you already had in memory, press **EXIT** at this point to return to the Master Screen. Save the Song data in memory to disk. Then perform the Load procedure again.

## 6. Working with the Internal Memory

The following provides some details on the workings of the KR-4500's internal memory, and how to best use it when working with Songs.

### a. Song and Song Number

You can have up to five Songs at any one time recorded in the Composer's internal memory. More precisely, the limit is about 40,000 recorded notes (in total). This means, of course, that if you create a Song that has some 40,000 notes in it, you can only fit that one Song into memory. The Composer is designed so it partitions the unit's internal memory in a manner which allows for storage of five different Songs, with each storage location given a number from 1 through 5. These numbers are used during recording and loading of Song data from a disk to identify data storage locations.

Up to maximum of 40,000 notes (total)

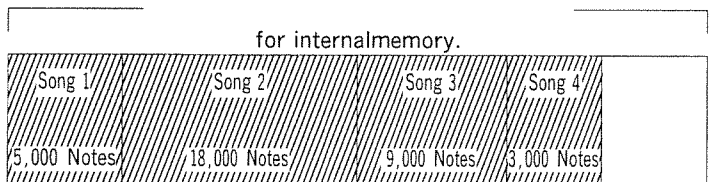

This means that up to 5,000 notes of performance data can be stored in Song number 5.

## b. Selecting a Song Number and Recording

Up to five Songs can be stored in internal memory (in the data storage locations 1-5.)

If there is already data stored in internal memory at the Song Number you have selected for the recording of a new Song, the previous Song data will be deleted when you record the new data. For this reason, make sure you select a blank Song Number (or one which contains unwanted data) before recording is started.

**Operation**

From the Master Screen :

- ① Make all the settings you need to start recording.
- ② Pressing the **SONG/DEMO** button now lights up the track buttons (**1/ARRANGER** – **5/UPPER 2**) corresponding to the Song Numbers which contain some song data. The Song Select screen will appear.

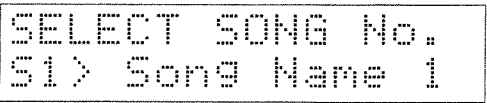

If some other screen is being displayed, press **SONG/DEMO** again.

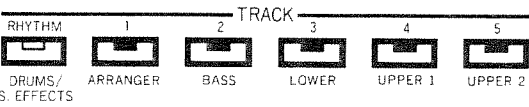

- 1/ARRANGER** .....S1 : Song Number 1
- 2/BASS** .....S2 : Song Number 2
- 3/LOWER** .....S3 : Song Number 3
- 4/UPPER 1** .....S4 : Song Number 4
- 5/UPPER 2** .....S5 : Song Number 5

- ③ When recording something new, pressing **INC** and **DEC** lets you select among the Song Numbers which don't already contain Song data. Or, if you want to combine (merge) something which is already recorded in internal memory, select the appropriate Song Number.
- ④ Press **ENTER** and decide which Song Number you will be recording to.
- ⑤ Press **REC**.

If you've directly selected the appropriate Song Number and Song Name in step ②, there's no need to do steps ③ and ④.

If no target track is lit, i.e. there's no place to record to, then nothing will be recorded.

When the Arranger Track is the recording target track, you can start a recording with Sync Start, Intro, or Sync Start with Intro.

- ⑥ Press the button for the track you want to record on (the target track) from among the six Track Select buttons; **RHYTHM/DRUMS,S.EFFECTS** — **5/UPPER 2**.

When you press a Track Select button, the indicator on the button will change as follows :

Flashing : This track has become a target track for recording. When recording begins, the performance data will be recorded on this track.

Lit : You can play back all data recorded up to that point on the track.

Dark : No playback or recording takes place.

- ⑦ Press the **PLAY** button to get two bars of Count-In before the start of recording.

- ⑧ Press **STOP** to stop recording.

You can have up to five Songs in internal memory with a total of no more than 40,000 notes. When you get within 10% of this limit at any time during recording, you'll see the following message :

```
INT.MEM.LIMIT!  
S1> Song Name 1
```

If you continue recording, you'll eventually run out of room and won't be able to enter any more data; at which time the following message will appear in the screen :

```
INT.MEM.FULL!!  
S1> Song Name 1
```

## c. Selecting a Song Number and Saving

### Operation

From the Master Screen :

- ① Move the Write Protect tab on a formatted disk over to the WRITE (OFF) position and insert it into the disk drive.
- ② Press the **SAVE** button.

```
SAVE SONG  
S1> Song Name 1
```



After step ③, you can also directly select the Song Number/Song Name simply by pressing the appropriate button (1/ARRANGER) through (5/UPPER 2). In this case, there is no need to do steps ④ and ⑤.

If there is no Song data contained at the selected Song number when you press (SAVE), the following screen will appear.

```
SAVE USER PROGRAM
PRESS >WRITE
```

In such cases, simply select another Song number, then repeat the Save procedure.

When the disk gets full, you won't be able to save any more Songs on it and you'll get a "DISK MEM. LIMIT" message (capacity will be exceeded) on the display. This means you'll have to insert a new disk in the drive and save the data onto that disk. It doesn't matter whether the disk has already been formatted for the KR-4500 or not, because you can do this as part of the Save procedure (P. 85). If you don't have a new disk at hand, you could delete Songs you don't want anymore to make room to save new ones; see page 116 for more on how to do that.

③ Pressing the (SONG/DEMO) button now lights up the track buttons (1/ARRANGER) – (5/UPPER 2) corresponding to the Song Numbers which contain song data. The Song Number Select screen will appear.

If some other screen is being displayed, press (SONG/DEMO) again.

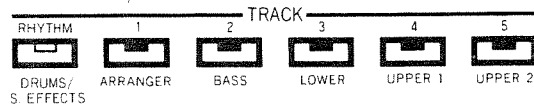

- (1/ARRANGER) .....S1 : Song Number 1
- (2/BASS) .....S2 : Song Number 2
- (3/LOWER) .....S3 : Song Number 3
- (4/UPPER 1) .....S4 : Song Number 4
- (5/UPPER 2) .....S5 : Song Number 5

```
SELECT SONG No.
S1> Song Name 1
```

- ④ Using (INC) and (DEC), select the Song Number corresponding to the Song data you're going to save. The Song Number and Song Name will be shown in the display.
- ⑤ Press (ENTER) to confirm selection of the Song Number.
- ⑥ Press (ENTER), and the data will be saved. When it's done, you'll see the following screen for a moment before returning to the Master Screen.

```
SAVE COMPLETED
S1> Song Name 1
```

After step ⑤, you can change a Song Name. Refer to the Composer Function [1] SONG NAME (P. 110) for more information about creating the Song Name.

If in step ⑥, you try to save a file using a Song Name that is already used, you'll see the following screen :

```
OVERWRITE FILE
SURE?PRESS>ENTER
```

If you press (ENTER) again at this point, it indicates that you do indeed want to overwrite, and the song data that was already on the disk up to that point will be erased. If you decide you don't want to overwrite the existing song data, press the (EXIT) button, modify the Song Name, and repeat the Save procedure.

- ⑦ Remove the disk and slide the Write Protect tab over to the PROTECT (ON) position.





## d. Selecting a Song Number and Loading

You can load Song data (for up to five Songs) into internal memory at the Song Number locations you specify.

### Operation

From the Master Screen :

① Insert the floppy disk (containing the saved Song data) into the disk drive.

② Press the **LOAD** button.

```
LOAD SONG   No 1
S1> Song Name 1
```

③ Pressing the **SONG/DEMO** button now lights up the indicators on the buttons **(1/ARRANGER)** – **(5/UPPER 2)** corresponding to Song Numbers which contain song data. The Song Number Select screen will appear.

In some other screen is being displayed, press **SONG/DEMO** again.



**1/ARRANGER** .....S1 : Song Number 1

**2/BASS** .....S2 : Song Number 2

**3/LOWER** .....S3 : Song Number 3

**4/UPPER 1** .....S4 : Song Number 4

**5/UPPER 2** .....S5 : Song Number 5

```
SELECT SONG No.
S1> Song Name 1
```

④ Using **INC** and **DEC**, select the Song Number you want to load to.

⑤ Press **ENTER**.

⑥ The Song Number in internal memory (into which the Song will be loaded), and the name of the Song on disk will be displayed.

```
LOAD SONG   No 1
S1> Song Name 1
```

If there are no Song files contained on the floppy disk you have attempted to Load, the following screen will appear :

```
LOAD USER PROGRAM
PRESS>WRITE
```

or

```
NO SONG FILE
PRESS>EXIT
```

Here, you should replace the disk with one that contains Song data, and repeat the Load procedure.

After step ③, you can also directly select the Song Number/Song Name simply by pressing the appropriate button **(1/ARRANGER)** through **(5/UPPER 2)**. In this case, there is no need to do steps ④ and ⑤.

- ⑦ Use **INC** and **DEC** to scroll through the Song Names and select the one you want to load.
- ⑧ Once you have the name of the Song you want to load displayed, press **ENTER**, and the Song will be loaded.

You can read in up to five Songs by selecting a different Song Number for each load operation. If you try to load a Song into internal memory that would exceed the 40,000 note limit, you'll see the following message :

```
INT.MEM.LIMIT!
S1> Song Name 1
```

Once the Load procedure is complete, you'll see the following screen for a moment before you are returned to the Master Screen :

```
LOAD COMPLETED
S1> Song Name 1
```

When there already is a Song contained in internal memory at the same location as that selected for loading in a new Song, the old Song data will be overwritten with the new data. However, if the Song in the unit has just been recorded or edited, when you select the Song Number in step ④ and you then try to do step ⑧, you will see the following screen :

However, you only see this screen with respect to recently recorded or edited Songs.

In other cases, you overwrite the previous Song when you carry out step ⑧.

```
OVERWRITE FILE
SURE?PRESS>ENTER
```

Once you press **ENTER** again, and give the go-ahead for overwriting the Song, the Song data stored there will be erased. If you decide that's not what you want to do, press **EXIT** to return to the Master screen, change the Song Number, and start the Load procedure over again from the beginning.

#### Selecting a Song Number and Playback

You can playback Song data at the Song Number location you specify.

##### Operation

From the Master Screen :

- ① Press **SONG/DEMO** to select this screen (If some other screen is being displayed, press **SONG/DEMO** again).

```
SELECT SONG NO.
S1> Song Name 1
```

- ② Using **INC** and **DEC**, Select the Song (Song Number) you want listen to.
- ③ Press **ENTER**.
- ④ Press **PLAY** and the playback of the Song starts as soon as you press the button.

# 7. Advanced Recording Techniques

The KR-4500 provides four different kinds of recording techniques which enable you to create some pretty sophisticated Song data.

## ○ Replace Recording

With this technique you can record (and re-record) a track you don't like the "first take" of your song data, simply re-record until you achieve the desired results.

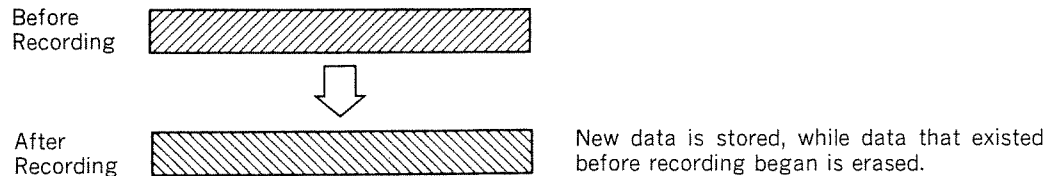

## ○ Mix Recording

This technique layers a new recording on top of any Song data that may already be on the track.

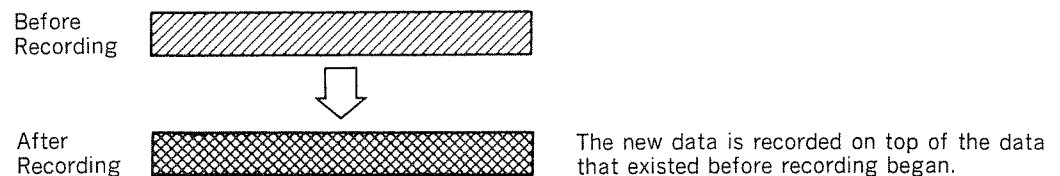

## ○ Pedal Punch-In Recording

This is technique used when there's just a certain section in the music that you want to record over. After the pedal has been assigned the function of Punch-In/Punch-Out Recording, you can depress it once to go from playback to recording (Punch-In), then depress it again to go from recording to playback (Punch-Out).

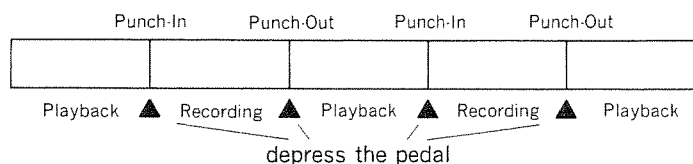

## ○ Auto Punch-In Recording

With this technique, you can set two points between which all the performance data will be deleted and new Song data recorded. You start by playing back the Song, and when you get to the part in the playback that needs fixing, you switch from playback to recording (that's called "Punch-In"), and when you're done with recording, you switch back to playback (that's "Punch-Out").

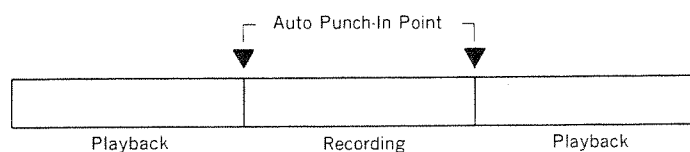

## a. Replace Recording

All the previously recorded data is erased, and new data is recorded in its place.

### Operation

From the Master Screen :

- ① Press **REC**.
- ② Select the target track for recording by pressing one of the Track Select buttons, **RHYTHM/DRUMS,S.EFFECTS** – **5/UPPER**, so that it starts flashing.

Each press of a Track Select button changes its status as follows :

Flashing : This track has been targeted for recording. When recording begins, the performance data will be recorded on this track.

Off : No playback or recording.

Lit : You can play back all previously recorded data on the track.

- ③ Using **INC** and **DEC**, select the following screen :

```
REPLACE REC
51> Song Name 1
```

- ④ Then, press **PLAY**, and recording will begin.
- ⑤ Press **STOP** to stop Replace Recording.

Replace recording will automatically be selected whenever recording is to occur in a Song number for the first time.

If no target track is selected, that is, if after step ② there are no Track Select buttons flashing, then you won't be able to start the recording.

## b. Mix Recording

Here you can layer a new recording on top of previously recorded performance data (this lets you do multiple recordings on the same track).

### Operation

From the Master Screen :

- ① Press the **REC** button.
- ② Select the target track for recording by pressing one of the Track Select buttons, **RHYTHM/DRUMS,S.EFFECTS** – **5/UPPER**, so that it starts flashing.

Each press of a Track Select button changes its status as follows :

Flashing : This track has been targeted for recording. When recording begins, the performance data will be recorded on this track.

Off : No playback or recording.

Lit : You can play back all previously recorded data on the track.

- ③ Using **INC** and **DEC**, select the following screen :

```
MIX REC
S1> Song Name 1
```

- ④ Recording starts as soon as you press the **PLAY** button.
- ⑤ Press **STOP** to stop Mix Recording.

If no target track is selected, that is, if after step ② there are no Track Select buttons flashing, then you won't be able to start the recording.

## c. Pedal Punch-In Recording

When there's just a certain section in the music that you want to record over, you can control where recording starts after assigning Punch-In/Punch-Out recording to a pedal. Playback will proceed normally until you depress the pedal, at which point Replace Recording will begin. Depress the pedal again, and you return to play back of the previously recorded Song data. In this way you can alternate between recording and playback with taps on the pedal, and this makes it incredibly easy to re-record a number of different places in your music.

This only works when a pedal has been set up in advance to control Pedal Punch-In/Punch-Out. See page 48 for more information on how to do this.

### Operation

From the Master Screen :

- ① Press **REC**.
- ② Press one of the Track Select buttons from **RHYTHM/DRUMS,S.EFFECTS** – **5/UPPER**, and confirm that its indicator has started flashing; this selects a target track for recording.

Each time you press a Track Select button, it will change as follows :

Flashing : This track has been targeted for recording. When recording begins, the performance data will be recorded on this track.

Off : No playback or recording.

Lit : You can play back all previously recorded data on the track.

- ③ Using **INC** and **DEC**, select the following screen :

```
P.PUNCH IN REC
S1> Song Name 1
```

- ④ Play back starts as soon as you press the **PLAY** button, and the Track Select button for the target track will light continuously.
- ⑤ When you get to the place you want to record over, depress the pedal. The target track will switch from playback to recording (Replace Recording), and its Track Select button will begin to flash.
- ⑥ When you've come to the end of the section you wanted to record over, press the pedal again. The target track will go from recording to playback again, and the Track Select button will light continually.
- ⑦ Press **STOP** to end Pedal Punch-In recording.

If no target track has been selected, that is, if after step ② none of the Track Select buttons are flashing, you won't be able to start recording.

To re-record over a number of different places in the same track, just keep repeating steps ⑤ and ⑥.

## d. Auto Punch-In Recording

If no target track is indicated, that is, if after step ② there are no Track Select buttons flashing, then you won't be able to start the recording.

You can set the Punch-In and Punch-Out Points ahead of time for re-recording. Replace Recording then automatically takes place only within the region defined by these points. Recording is disabled for data lying outside this region, although you will hear it playback.

### Operation

From the Master Screen :

- ① Press **REC**.
- ② Press one of the Track Select buttons from **RHYTHM/DRUMS.S.EFFECTS** — **5/UPPER 2** so that it starts to flash, thus selecting a target track for the recording.

Each time you press the Track Select button, it will change as follows :

Flashing : This track has been targeted for recording. When recording begins, the performance data will be recorded on this track.

Off : No playback or recording.

Lit : You can play back all previously recorded data on the track.

- ③ Using **INC** and **DEC**, select the following screen :

```
A. PUNCH IN REC
S1> Song Name 1
```

- ④ Recording starts as soon as you press the **PLAY** button.

When you get to the first bar specified as the Auto Punch In point, the target track will automatically go from playback to recording (Replace Recording), and its Track Select button will begin flashing.

- ⑤ When you've come to the end of the section you wanted to record over (you reach the Auto Punch-Out point), the target track will automatically go from recording to playback again, and the Track Select button will light continually. At the appropriate place, you can press the **STOP** button to quit Auto Punch-In Recording.

# 8. Editing a Songs

The KR-4500 has a number of editing functions which you can use to really polish up the songs that you record.

- Quantize .....corrects the timing of recorded notes.
- Erase .....deletes all performance data in a specified range of bars, and replaces these with blank measures.
- Insert .....inserts blank measures.
- Copy .....duplicates the performance data in a specified range of measures and moves them to a different location
- Delete .....deletes all performance data in a specified range of measures but does not replace them with blank measures.

These editing features are not available if no performance data has been recorded.

## a. Quantize

Corrects any inconsistencies in the timing of notes that have been recorded.

**Example : Quarter-note resolution**

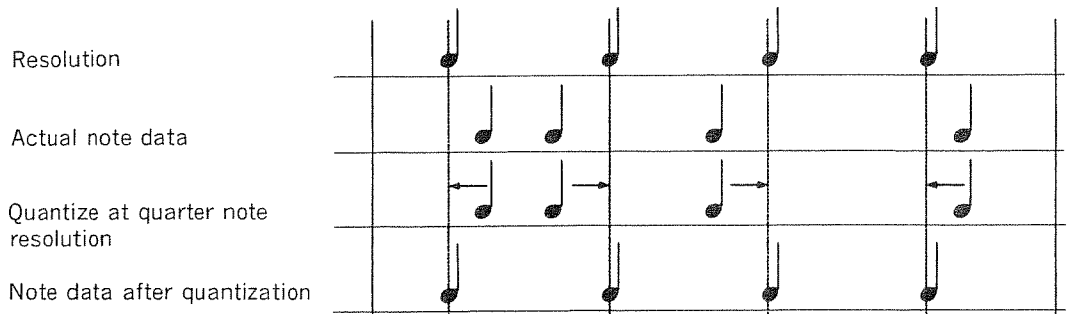

Once you Quantize the performance data, you won't be able to revert back to the original. It's a good idea to save a copy of the data to disk first in case you don't like the results.

**Operation**

From the Master Screen :

- ① Press the **EDIT** button to display the Edit Menu, and use **INC** and **DEC** to select **[1] QUANTIZE**.

```
EDIT
[1] QUANTIZE
```

- ② Press **ENTER** to go to the Quantize screen.

```
EDIT1 QUANTIZE
TRACK = ALL
```

You can cancel any of these editing functions during execution by pressing the **EXIT** button.

You can use this function to correct the timing of recorded notes. Quantize on the KR-4500 only affects note data (Note messages). It cannot alter the timing information for other kinds of data, such as Pitch Bend and Program Change messages. Therefore, you should use it on tracks that contain only keyboard performance data. Following the quantization, you can then simply add on the other kinds of data, if needed, using Mix Recording.

Note that as result of applying quantization to the Arranger track, the timing of the data specifying chords may shift somewhat from the original timing captured during recording. For this reason, after quantizing, you may notice that the feeling of a certain piece has been altered, if compared with what was originally recorded.



You can also select the tracks you want by pressing the appropriate Track Select buttons.

The entry "FOR" is not the last measure in the region to be quantized, but rather, "for how many" bars from the first bar are to be quantized. So, for example, the notation "FROM 2 FOR 4" would mean that Quantize will work on the second measure through the fifth measure.

If you set the Resolution too high, you will get a mechanical sounding performance, and if you set it too low, you will hardly notice any difference at all as a result of the quantization. Ordinarily, you'll want to set the Resolution to be the same as the shortest note duration played in that passage.

- ③ Using **[INC]** and **[DEC]**, indicate which track you want Quantized. Each time you press the button, the next target Track Name is displayed.

Select "ALL" to make all the tracks target tracks.

- ④ Press the **[A/▶]** button to move the cursor over to the next entry point (the screen changes).

```
EDIT1 QUANTIZE
FROM      1 FOR ALL
```









- ⑤ Using **[INC]** and **[DEC]** indicate the first measure from which you wish quantization to be applied. Then, use the **[A/▶]** button to move the cursor to the next entry point ("FOR"), where you will again use **[INC]** and **[DEC]** to specify the number of measures to be affected.

- ⑥ Press the **[A/▶]** button to move the cursor to the next entry point (the screen changes).

```
EDIT1 QUANTIZE
RESOLUTION 1/32
```

- ⑦ Set the Quantize Resolution (minimum note duration) with **[INC]** and **[DEC]**.

There are eight different Resolutions available.

[1/2]...		half note	[1/16]...		sixteenth note
[1/4]...		quarter note	[1/24]...		sixteenth notes triplet
[1/6]...		quarter note triplet	[1/32]...		thirty second note
[1/8]...		eighth note			
[1/12]...		eighth note triplet			

- ⑧ After setting the Resolution, press the **[A/▶]** cursor button and you will see the following screen :

```
EDIT1 QUANTIZE
SURE?PRESS>ENTER
```

- ⑨ If everything is set the way you want it, press **[ENTER]**. If you decide you want to cancel quantization at this point, press **[EXIT]**.

You can change any of the settings made in steps ④ through ⑧ by stepping back to the entry points with the **[UPPER/◀]** cursor button. This can be conveniently used to check all your settings.

## b. Erase

The following items will not be erased even when they are located within the range specified for erasure: Mark Points, Block Repeat selections, and Auto Punch-In points.

You can also select the track for erasure by pressing the appropriate Track Select buttons.

No blank measures will be left if you perform an Erase operation that applies to all Measures.

This erases all the performance data in the specified range of measures, and replaces them with blank measures. It's just like a real eraser, actually, in the way it erases all the notes and rests from a sheet of music and just leaves a blank staff.

**Example : When bars 5-8 have been erased.**

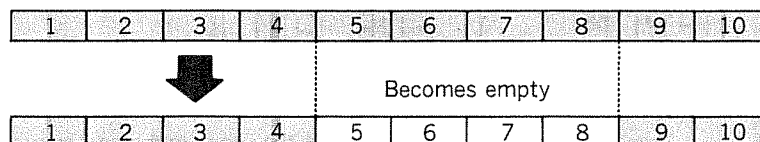

Once you erase the performance data, you won't be able to restore it later, so just in case you change your mind about what you erased, it may be a good idea to save a copy of the data to disk first.

### Operation

From the Master Screen,

- ① Press the **EDIT** button to display the Edit Menu, and use **INC** and **DEC** to select **[2] ERASE**.

```
EDIT
[2] ERASE
```

- ② Press **ENTER** to go to the Erase screen.

```
EDIT2 ERASE
TRACK = ALL
```

- ③ Using **INC** and **DEC**, indicate which track you want erased. Each time you press the button, the next target Track Name is displayed.

Select "ALL" to make all the tracks target tracks.

- ④ Press the **A/▶** button to move the cursor to the next entry point (the screen changes).

```
EDIT2 ERASE
FROM 1 FOR ALL
```

- ⑤ Using **INC** and **DEC**, indicate the starting measure from which you wish erasure to be applied. Then use the **A/▶** button to move the cursor to the next entry point ("FOR"), where you will again use **INC** and **DEC** to specify the number of measures to be affected.

The entry "FOR" is not the last measure of the region to be erased, but rather how many bars from the first selection are to be erased. So, for example, the notation "FROM 2 FOR 4" would mean that you want to erase from the second measure through the fifth measure.

- ⑥ Move the cursor to the next entry point using the **A/▶** button (the screen changes).

```
EDIT2 ERASE  
EVENT = ALL
```

- ⑦ Using **INC** and **DEC**, select the kind of data (events) you want to erase. The following four selections are provided :

ALL : All types of events.

EXC.NOTE : Events other than note messages.

DAMPER : Damper pedal messages; events recorded whenever you operate the Damper pedal.

BENDER : Pitch Bend messages, events recorded whenever you operate the Pitch Bend Wheel.

- ⑧ Once the types of events has been specified, press the **A/▶** button to move to the next screen.

```
EDIT2 ERASE  
SURE?PRESS>ENTER
```

- ⑨ If everything is set the way you want it, press **ENTER**. If you decide you want to cancel the erasure at this point, press **EXIT**.

You can change any of the settings made in steps ④ through ⑧ by stepping back to the entry points with the **UPPER/◀** cursor button. This method can also be conveniently used to check all your settings.

## c. Insert Measure

This feature allows you to insert blank measures after the measure you specify.

**Example : When 3 empty bars have been inserted at the fifth bar.**

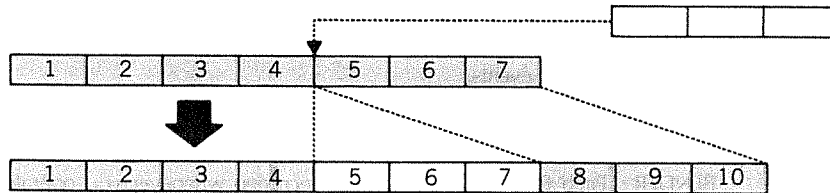

The Insert function puts a blank measure into any track you wish. The only exception is the Arranger Track, where the Style data just before an inserted measure is continued through the insert measure range; that way, play of a Music Style is not interrupted.

The reason for the above is that the data actually recorded in the Arranger Track is not the sound of the Music Style itself, as it would be played by the Arranger, but is essentially the information on chords, and settings that have been made for how the Arranger is to perform. As a result, after you put in blank measures, play needs to be continued in accord with what came before until the Arranger receives new data concerning chord changes.

You can also select the tracks you want by pressing the appropriate Track Select buttons.

The entry "FOR" is not the last measure of the Insert range, but rather how many bars from the first bar are to be inserted. So, for example, the notation "FROM 2 FOR 4" would mean that you want to insert four blank measures starting from the second measure.

If Style data is interrupted in the middle of a song, the way to fix it is to insert a Break (☞P. 37) with Mix Recording.

### Operation

From the Master Screen;

- 1 Press the **EDIT** button to display the Edit Menu, and use **INC** and **DEC** to select [3] INSERT.

```
EDIT
[3] INSERT
```

- 2 Press **ENTER** to go to the Insert Measure screen.

```
EDIT3 INSERT
TRACK = ALL
```

- 3 Using **INC** and **DEC**, indicate in which track you want blank measures inserted. Each time you press the button, the next target Track Name is displayed.

Select "ALL" to make all the tracks target tracks.

- 4 Press the **A/▶** button to move the cursor to the next entry point (the screen changes).

```
EDIT3 INSERT
FROM 1 FOR 1
```

On the KR-4500, one Song can have up to 999 measures, so you won't be able to insert measures into a Song if that would take you over 999.

If you perform an Insert Measure operation that applies to all tracks, all Mark Point settings will be inactive.

The following items will not be copied even when they are located within the range specified to be copied: Mark Points, Block Repeat selections, and Auto Punch-In points.

⑤ Indicate the starting measure for Insert with **INC** and **DEC**. Then, use the **A/▶** button to move the cursor to the next entry point ("FOR"), where you will again use **INC** and **DEC** to specify the number of measures.

⑥ Once the number of measures has been specified, press the **A/▶** button to move to the next screen.

```
EDIT3 INSERT
SURE?PRESS>ENTER
```

⑦ If everything is set the way you want it, press **ENTER**. If you decide you want to cancel the measure insertion at this point, press **EXIT**.

While making the settings in steps ④ through ⑥, you can step back to previous entry points with the **UPPER/◀** cursor button. This method can be conveniently used to check all your settings.

## d. Copy

This function lets you duplicate the performance data in a specified range of measures and move it to a different location in the same track.

**Example : Bars 5-7 are copied once, starting from bar 8.**

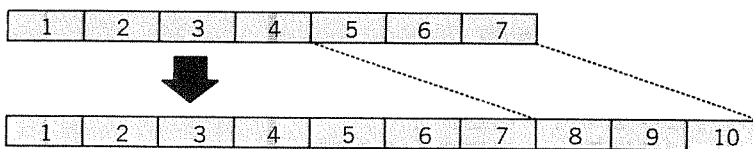

### Operation

From the Master Screen;

① Press the **EDIT** button to display the Edit Menu, and use **INC** and **DEC** to select **[4] COPY**.

```
EDIT
[4] COPY
```

② Press **ENTER** to go to the Copy screen.

```
EDIT4 COPY
TRACK = ALL
```

You can also select the tracks you want by pressing the appropriate Track Select buttons.

The entry "FOR" is not the last measure of the Copy range, but rather how many bars from the bar indicated first are to be copied. So, for example, the notation "FROM 2 FOR 4" would mean that you want to copy blank measures from the second through the fifth measures.

On the KR-4500, one Song can have up to 999 measures, so you won't be able to copy measures into a Song if that would take you over 999.

- ③ Using  INC and  DEC, indicate to which track you want something copied.

You can select "ALL" to make all the tracks target tracks.

- ④ Press the  A/▶ button to move the cursor to the next entry point (the screen changes).

```
EDIT4 COPY
FROM 1 FOR ALL
```

- ⑤ Using  INC and  DEC, indicate the measure that is to be the source, and is where the copy is to begin. Then, use the  A/▶ button to move the cursor to the next entry point ("FOR"), where you will again use  INC and  DEC to specify the number of measures.

- ⑥ Press the  A/▶ button to move the cursor to the next entry point (the screen changes).

```
EDIT4 COPY
TO END TIME 1
```

- ⑦ Indicate the measure to be the destination of the copy with  INC and  DEC. Then, use the  A/▶ button to move the cursor to the next entry point ("TIME"), where you will use  INC and  DEC to specify the number of times to copy the measure(s).

So, for example, when you want to insert the copied bar(s) three times starting at Measure 12, you would make this "TO 12 TIME 3."

- ⑧ Press the  A/▶ button to move the cursor to the next entry point (the screen changes).

```
EDIT4 COPY
MODE REPLACE
```

- ⑨ Use  INC and  DEC to select the Copy Mode from among the following three options :

- REPLACE...the copied bars will overwrite and erase the data that was there previously.

Since you will be unable to "undo" the copy and restore the data originally at the target of the Replace Copy, we recommend that you make a backup of the Song on a floppy disk beforehand.

- MERGE...the copied bars are layered on top of, or "merged," with the data that was already there.

Once you merge this data together you can't separate it again, so just in case you decide you want to "undo" this later, it would be a good idea to save the unedited Song to a floppy disk.

- INSERT...Copies everything starting with the measure specified in step ⑦.

If you select the "Insert" mode and perform a Copy operation that applies to all tracks, all Mark Point settings will be inactive.

- ⑩ Once the Copy Mode has been selected, press the  A/▶ button to move the cursor to the next screen.

```
EDIT4 COPY
SURE?PRESS>ENTER
```

- ⑪ If everything is set the way you want it, press **ENTER**. If you decide you want to cancel the copy at this point, press **EXIT**.

You can change any of the settings made in steps ④ through ⑩ by stepping back to the entry points with the **UPPER/◀** cursor button. This method can also be conveniently used to check all your settings.

## e. Delete

This function allows measures in the specified range to be deleted.

If you perform a Delete operation that applies to all tracks, all Mark Point settings will be inactive.

**Example : Bars 5-8 are deleted.**

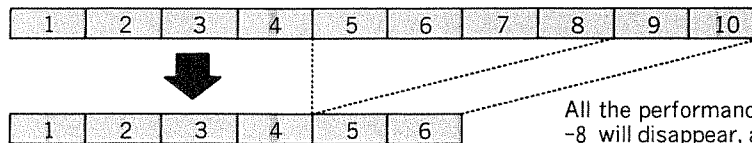

All the performance data that was in bars 5-8 will disappear, and as a result bars 9 and 10 will be Shifted forward.

Once you delete data you can't get it back, so it would be a good idea to save the unedited version of the Song onto a floppy disk.

### Operation

From the Master Screen;

- ① Press the **EDIT** button to display the Edit Menu, and use **INC** and **DEC** to select **[5] DELETE**.

```
EDIT
[5] DELETE
```

- ② Press **ENTER** to go to the Delete screen.

```
EDIT5 DELETE
TRACK = ALL
```

- ③ Using **INC** and **DEC**, indicate which track you want deleted. Each time you press the button, the next target Track Number is displayed.

Select "ALL" to delete all performance information from all tracks.

- ④ Press the **A/▶** button to move the cursor to the next entry point (the screen changes).

```
EDIT5 DELETE
FROM 1 FOR ALL
```

The following items will ALL be deleted when they are located within the range specified for deletion : Mark Points, Block Repeat selections, and Auto Punch-In points.

You can also select the tracks you wish to delete by pressing the appropriate Track Select buttons.

The entry "FOR" is not the last measure of the region to be deleted, but rather how many bars from the first bar are to be deleted. So, for example, the notation "FROM 2 FOR 4" would mean that you want to delete from the second measure through the fifth measure.

⑤ Set the starting measure for the Delete with **INC** and **DEC**. Then, use the **A/▶** button to move the cursor to the next entry point ("FOR"), where you will again use **INC** and **DEC** to specify the number of measures.

⑥ Press the **A/▶** button to move the cursor to the next screen.

⑦ Once the number of measures has been specified, press the **A/▶** button to move to the next screen.

```
EDITS DELETE
SURE?PRESS>ENTER
```

⑧ If everything is set the way you want it, press **ENTER**. If you decide you want to cancel the deletion at this point, press **EXIT**.

You can change any of the settings made in steps ④ through ⑧ by stepping back to the entry points with the **UPPER/◀** cursor button. This method can also be conveniently used to check all your settings.

Once performance data has been deleted, it cannot be restored. For this reason, we recommend that you make a backup copy (on floppy disk) before performing any deletions.

## 9. Moving to Selected Points in a Song

There are several different ways you can move around quickly in a Song, all of which are invaluable during recording, playback or editing. This section explains how to make efficient use of these features.

### a. Mark Point

Mark Point lets you put "marks" at a certain places in a Song which can later be used to locate a certain measure, or for specifying passages you wish to have repeated a number of times. In total, six Mark Points are available, and each is assigned a number from 0 to 5. Of these, Mark 0 and Mark 5 are automatically set during recording (at the first and last measure of the Song), and can't be changed.

Mark 0 .....Always assigned at the beginning of the first measure of the Song

Mark 5 .....Always assigned to the end of the last measure of the Song

Marks 1 through 4 .....These can be placed at the beginning of any measure you like

**Example :** When Mark Points 1-4 have been placed at the beginning of bars 3,4,6 and 9.

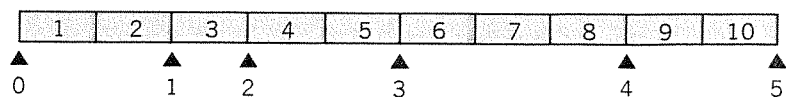

Mark Points need to be set during song playback.



When you set a Mark Point with a Track Select button, that button will light up.

**Operation**

From the Master Screen;

- ① Select the song into which you wish to place Mark Points, and press **PLAY** to start playback.
- ② Press the **MARK** button.

```
SET MARK POINT
PRESS> TRACK 1-4
```

At this time, the indicators corresponding to Mark Points that have already been assigned will light up.

- ③ When you get to the point in the song where you want to set a Mark Point, press the Track Select button (**1/ARRANGER** - **4/UPPER 1**) corresponding to the number of the Mark Point you want to set.

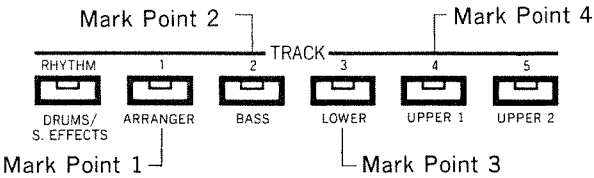

If you press a lit button again, the Mark Point is reset to that new location and the previous Mark Point is deleted (the indicator on the button will stay on). Once an indicator is on, you can't turn it off.

**b. Specifying Measures Using Mark Points**

When you have Mark Points set in a recorded Song, you can use them to specify a range of measures during editing (see "Mark Points," page 106).

Example) Quantize

**Operation**

From the Master Screen;

```
EDIT1 QUANTIZE
FROM 1 FOR ALL
```

- ① Press the **MARK** button.  
You'll see a screen like this one (this is where you set the Mark Point range).

```
EDIT1 QUANTIZE
FROM M0 TO M5
```

When you press the Track Select button, the appropriate Mark Point Number M0 through M5 will be displayed on the screen.

- ② With the Track Select button, specify the starting measure you want Quantized. Next, cursor over to the "TO" entry on the next screen with the **(A/▶)** button, and indicate the last measure for the Quantize with the Track Select button.

The Mark Point is always set at the beginning of a bar, so Quantize takes effect up to the end of the bar just before the one indicated as the "TO" measure.

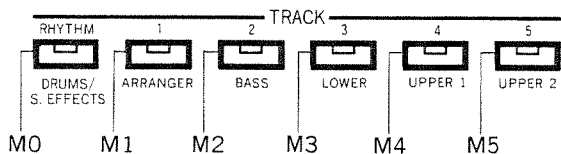

Specifying a measure (or a range of measures) using Mark Points is done the same way for the other editing functions.

### c. Song Position ~ FWD (Fast-Forward) and BWD (Rewind)

By Song Position, we mean a display of how many measures there are between the current location and the start of the Song.

If you want to listen to a Song from somewhere in the middle, you press the **(BWD)** or **(FWD)** buttons (with playback/recording stopped) and find the place (Song Position) you want.

When you press the button, the current Tempo, Measure, Song Number and Song Name are displayed.

```

♩:120 MEAS. 120
S1> Song Name 1
  
```

- (BWD)** moves the recording/playback start point backward from the current measure.
- (FWD)** moves the recording/playback start point forward from the current measure.

## d. Song Position Jump

When you have a Mark Point set in recorded data, you can indicate Song Position using that Mark Point.

With Recording/Playback stopped, from the Master Screen :

- ① Press the **MARK** button to get to the screen where you'll set the Jump Point.

```
JUMP MARK POINT  
PRESS> TRACK 0-5
```

- ② Now press one of the lit Track Select buttons (**RHYTHM/DRUMS,S.EFFECTS**) – (**5/UPPER 2**) to set the Jump to the measure you set. If no Mark Points are currently active, none of the lights will be lit on these buttons.

If no Mark Points are currently active, none of the indicators on **1/ARRANGER** – **4/UPPER 1** will be lit.

```
JUMP MARK POINT  
MARK 1 MEAS. 100
```

The screen will show the Mark Point Number and Measure Number. When you press **PLAY**, play/recording will start from this measure.

## e. Checking the Tempo/Song Position/Song Number/Song Name

When you press the **PLAY** button during playback or recording, you will see the current Song Tempo, Song Position, Song Number, and Song Name.

```
♩:120 MEAS. 120  
S1> Song Name 1
```

# 10. Functions

The **FUNCTION** key in the Composer section will switch you in and out of the Function mode, where you can make five different kinds of settings which we'll talk about here. These Function settings are recorded along with Song and are handled as if they were part of the Song data itself, i.e., saved and stored the same way.

You can cancel an operation at any time by pressing the **EXIT** button.

## a. Giving a Song a Name~ Song Name

The following procedure is used to assign a name to Songs you have recorded.

### Operation

From the Master Screen :

- ① Press the **FUNCTION** button in the Composer section.
- ② Using **INC** and **DEC**, select the Song Name screen.

```
FUNCTION
[1] SONG NAME
```

- ③ Press **ENTER**.

```
FUNC1 SONG NAME
S1>KR-01
```

- ④ Use the cursor buttons (**UPPER/◀** and **A/▶**) to move to the position where you wish to enter a character, then use **INC** and **DEC** to select the characters.

Press **UPPER/◀** to move the cursor to the LEFT.

Press **A/▶** to move the cursor to the RIGHT.

The characters available will appear in the following sequence :

...xyz0123456789 !" #%&' ( ) \*+, - . / : ; =? ^ \_ ABCDEFGHIJKLMNOPQRSTUVWXYZ  
Zabcdefghijklmnopqrstuvwxyz012...

(**INC** steps through the order shown, and **DEC** in the reverse order.)

Normally you can't save two Songs with the exactly the same name on the same disk (if you try to do this, you'll wind up overwriting the previous Song with the new one that you're Saving). You can, however, use the same name for two Songs if one of the names is written in all upper case characters.

Your Song Name can be up to 12 characters long.

You can use the Track Select buttons (1/ARRANGER — 5/UPPER 2) together with the (INC) and (DEC) buttons to speed up the character input process as follows :

- (1/ARRANGER) ... pressing this button jumps from wherever you are on the screen to the "0"
- (2/BASS) ... pressing this button jumps from wherever you are on the screen to the "A"
- (3/LOWER) ... pressing this button jumps from wherever you are on the screen to the "M"
- (4/UPPER 1) ... pressing this button jumps from wherever you are on the screen to the "a"
- (5/UPPER 2) ... pressing this button jumps from wherever you are on the screen to the "m"

④ Press (ENTER) when the name is complete.

Once the Song Name has been successfully stored, you'll be returned to the Function screen. From there, if you don't do anything else for a moment or two, you'll be returned to the Master screen.

## b. Setting the Standard Tempo for a Song ~ Basic Tempo

Here's where you set the Basic Tempo and Time Signature for a Song. The basic Tempo is shown in the display immediately after loading the Song data.

The Tempo and Time Signature you set here will be the ones used initially for playback and recording — although, of course, you can always change. The Tempo can be changed (whenever you want) by moving the Tempo slider.

You can only modify the Time Signature on Songs that have no performance data recorded in them. Consequently, once you have set and recorded a Time Signature, there's no going back and changing it later. So before recording, be sure to check what Time Signature is selected.

### Operation

From the Master Screen :

- ① Press the (FUNCTION) button in the Composer section.
- ② Select the Basic Tempo screen using the (INC) and (DEC) buttons.

```
FUNCTION
[2] BASIC TEMPO
```

③ Press (ENTER).

The display will show the Time Signature and Tempo of the selected Music Style.

```
FUNC2 BAS TEMPO
♩120      4 / 4
```

④ Move the cursor with the (UPPER/◀) and (A/▶) cursor buttons to the entry points for Tempo/Time Signature.

Press (UPPER/◀) to move the cursor to the LEFT.

Press (A/▶) to move the cursor to the RIGHT.

The Basic Tempo value will be displayed by pressing (RESET).

Although the Tempo can be changed freely during playback, such changes are only temporary. Whenever you want to return to the Basic Tempo originally assigned to the song, just press (INC) and (DEC) simultaneously.

The Time (meter) is indicated by two numbers; one above the other (eg. 4/4). The lower number indicates the chosen unit of measurement (eg. half note, quarter note etc.), while the upper number indicates the number of such units in each measure.

The most common Time Signatures are; 2/4, 3/4 and 4/4.

Count-In ON is the default setting (selected when the unit is turned on.)

- ⑤ Set the parameters for Tempo/Time Signature with the **INC** and **DEC**.

The Tempo can be set between 30 and 240 beats per minute.

The Time Signatures possible on the KR-4500 are follows :

1/2, 2/2, 3/2

1/4, 2/4, 3/4, 4/4 ~ 7/4

1/8, 2/8, 3/8 ~ 15/8

1/16, 2/16, 3/16 ~ 31/16

(Note : 2/4, 3/4 and 4/4 are by far the most common Time Signatures.)

- ⑥ Press **ENTER** to enter your selections.

Once the settings have been stored successfully, you'll be returned to the Function screen. If you have nothing more to do in the Function screen, you'll be returned to the Master screen after a few seconds.

Once you record a Song, you can't change it's Time Signature.

## c. Turning Count-In On/Off

You can use this function to set whether or not to have two bars of Count-In before the start of playback or recording.

If Count-In is set to OFF, play or recording would start the instant you press the **PLAY** button.

If Count-In is turned on, it will start playback or recording would start after two bars of Count-in.

### Operation

From the Master Screen :

- ① Press the **FUNCTION** button in the Composer section.
- ② Select the Function Menu screen using the **INC** and **DEC** buttons.

```
FUNCTION
[3] COUNT IN
```

- ③ Press **ENTER**.
- ④ Use the **INC** and **DEC** buttons to switch between Count-In ON and OFF.

ON...Starts playback and recording after two bars of Count-In

OFF...Starts playback and recording as soon as you press **PLAY**

- ⑤ Press **ENTER** to register the settings.

When this is done, you'll be returned to the Function screen. From there, you'll be returned to the Master screen if you don't do anything further.

## d. Setting a Repeat Play Range ~ Block Repeat

Block Repeat is a set range over which you can repeatedly play (or record) as many times as you like. (Repeat-Playback ⇨ P.83)

When you record performance data, the repeat range is automatically set as the duration of the entire song. You can, of course, set the repeat range as you wish. You can also save a reset repeat range for each song.

This screen is where you set the repeat range.

As long as there is no performance data stored in the Arranger track, the bar from which Block Repeat starts, and the number of bars which are to be repeated, can be set to anything you like. However, once performance data has been stored in the Arranger track, the unit will automatically be set so that the bar from which Block Repeat starts is "1", and the number of bars is "ALL". These settings cannot be changed.

### Operation

From the Master Screen :

- ① Press the **FUNCTION** button in the Composer section.
- ② With the **INC** and **DEC** buttons, select the Block Repeat screen.

```
FUNCTION  
[4] BLOCK REPEAT
```

- ③ Press **ENTER**.

```
FUNC4 BL REPEAT  
FROM 1 FOR ALL
```

- ④ In this screen, set the starting measure for Repeat Play with the **INC** and **DEC** buttons. Then, use the **A/▶** button to cursor over to the next entry point ("FOR") where you will again use the **INC** and **DEC** buttons to set the range.

```
FUNC4 BL REPEAT  
FROM 1 FOR ALL
```

- ⑤ When you are finished entering your settings, press the **ENTER** button to register them.

Once the settings are successfully stored, you'll be returned to the Function screen. The Master screen will reappear in a few second, if you do not continue with another operation.

Repeat play is particularly helpful when practicing your fingerings over a difficult section, because you can go through that (Block Repeat) section over and over again until you get it right.

The entry "FOR" is not the last measure of the Repeat range, but rather how many bars from the first bar are in this range. So, for example, the notation "FROM 2 FOR 4" would mean that the range is four bars beginning from Measure 2.

If no performance data has been recorded, you will not be able to make settings for a Block Repeat.

## e. Setting the Auto Punch-In Range ~ Punch-In Point

If no performance data has been recorded, you will not be able to set the Auto Punch-In Point.

The entry "FOR" is not the last measure of the Recording range, but rather, how many bars from the first bar are in this range. So, for example, the notation "FROM 2 FOR 4" would mean that the Recording starts from the second measure and runs through the fifth measure.

This is where you can set the range for Auto Punch-In Recording (P. 97).

### Operation

Starting from the Master Screen :

- ① Press the **FUNCTION** button in the Composer section.
- ② With the **INC** and **DEC** buttons, select this screen :

```
FUNCTION  
[5] A.PUNCH IN
```

- ③ Press **ENTER**. This next screen is where you'll set the start point.

```
FUNC5 A.PUNCH IN  
FROM 1 FOR ALL
```

- ④ Set the start measure for Auto Punch-In with the **INC** and **DEC** buttons. Then, use the **A/▶** button to cursor over to the next entry point ("FOR") where you will again use the **INC** and **DEC** buttons to set the range.
- ⑤ When the settings are complete, press the **ENTER** button.

Once the settings are successfully stored, you'll be returned to the Function screen. The Master screen will reappear in a few seconds if you do not continue with another operation.

### Using Mark Points to Set Measure Numbers

When you have Mark Points set in a recorded Song, you can use them the same way as with the editing functions to specify a particular place in the Song from which you want Block Repeat or Auto Repeat to start. See page 106 "Mark Points" for more information about this.



# 11. Disk Functions

If you press the **FUNCTION** key in the Composer section after pressing either **LOAD** or **SAVE**, you will be switched into the Disk Function Mode. There you can do all sorts of disk-related things, like Formatting or deleting files.

You can cancel an operation at any point by pressing the **EXIT** button.

## a. Initializing a Floppy Disk ~ Format

You will need to "initialize" a floppy disk for use with the KR-4500. The KR-4500 can automatically detect whether a disk is a 2HD or a 2DD type and Format it accordingly (2HD: 1440KB, 2DD: 720KB).

### Operation

From the Master Screen :

- ① Insert the floppy disk to be Formatted into the disk drive.
- ② Press the **LOAD** or **SAVE** button, then the **FUNCTION** button in the Composer section.
- ③ Select the Disk Function screen using the **INC** or **DEC** button.

```
DISK FUNCTION
[1] FORMAT DISK
```

- ④ Press **ENTER**.

```
FORMAT DISK
SURE?PRESS>ENTER
```

- ⑤ The Format starts when you press **ENTER**.

Once the disk has been formatted successfully, you'll be returned to the Disk Function display. If you don't do anything from that screen for a few seconds, you'll be returned to the Master screen.

Refer to page 76 for some tips on removing disks from the disk drive.

## b. Delete Song Files ~ Delete File

As you Save new files onto a floppy disk, you may find other files which you'll want to delete. However, take some care with what files you delete, because once they're gone you can't retrieve them.

### Operation

From the Master Screen :

- ① Insert the floppy disk into the disk drive.
- ② Press **LOAD** or **SAVE**, then press the **FUNCTION** button in the Composer section.
- ③ Select the Delete Song File screen with the **INC** or **DEC** button.

```
DISK FUNCTION
[2] DELETE FILE
```

- ④ Press **ENTER**.

```
DELETE SONG No 1
S1> Song Name 1
```

From this screen, select the Song File to delete with the **INC** and **DEC** buttons.

- ⑤ Press **ENTER**. The Delete operation starts immediately.

Once the song deletion is complete, you'll be returned to the Master screen.

## c. Delete User Program Files ~ Delete File

You can delete unnecessary User Program files saved on a floppy disk with this operation. Remember, however, that deleted files can't be retrieved.

### Operation

From the Master Screen :

- ① Insert the floppy disk (containing the User Program files to be deleted) into the disk drive.
- ② Press **LOAD** or **SAVE**, then press the **FUNCTION** button in the Composer section.
- ③ Select the Delete File screen with the **INC** or **DEC** button.

```
DISK FUNCTION
[2] DELETE FILE
```

- ④ Press **ENTER**, and then the **WRITE** button.

```
DELETE USRP FILE
U > Pgm.Name 1
```

- ⑤ Select the User Program file to be deleted with the **INC** and **DEC** buttons.
- ⑥ Press **ENTER** to start the User Program file Delete operation.

Once the deletion has been completed, you'll be returned to the Disk Function screen. From here, if you don't do anything else for a moment or two, you'll be returned to the Master screen.

# 12. User Programs

In addition to Song data, you can also store your User Programs settings onto floppy disk.

You can cancel any procedure by pressing **EXIT**.

## a. Saving Your User Programs to Disk

### Operation

From the Master Screen :

- ① Insert a formatted disk into the disk drive and press the **SAVE** button.
- ② Press **WRITE** and you'll see the User Program Name entry screen.

```
SAVE USR PROGRAM
U >KR-01
```

- ③ Enter the User Program Name. Using the **UPPER/◀** and **A/▶** buttons, position the cursor at the point where you want to enter a character. Use the **INC** or **DEC** buttons to select the character you wish to enter. Repeat the process until the User Program Name is entered to your satisfaction.
- ④ Press **ENTER** and the file is saved to disk.

When you do step ④, you'll see the following screen :

```
OVERWRITE FILE
SURE?PRESS>ENTER
```

This means that there is already a User Program on the floppy disk with the same file name as the one you want to save. If it's OK to overwrite the file, press **ENTER**; if it's not, press the **EXIT** button to return to the Master screen. Modify the User Program Name so you can save it under a different file name.

If the disk has not been formatted for use by the KR-4500, you will need to do so.

The name can contain up to 12 characters.

## b. Loading the Settings for a User Program

### Operation

From the Master Screen :

- ① Insert the floppy disk containing the recorded User Program settings into the disk drive and press **LOAD**.
- ② Press **WRITE**, and you'll see the screen where you select the name of the User Program you want to load.

```
LOAD USR PROGRAM
U > Psn.Name 1
```

- ③ Select the one you want with **INC** and **DEC**.
- ④ Then press **ENTER**. The Load procedure starts immediately.

When you load a User Program, the User Program settings previously contained until in the instrument's memory will be erased.

## A Few Extra Tips Useful for Using the Composer

### ● How to make changes in the "Setup Data"

Information that describes the particular sounds used, the volume, the settings for effects, and a variety of other information is always stored at the very beginning of each Song. This group of information is known as the "Setup Data". Should you need to make changes in this Setup Data, follow these steps:

### Operation

From the Master Screen :

- ① Check to make sure you have the Composer stopped then make all the settings you wish to have for the volume, sounds, and effects (Make sure to set all of them).
- ② While holding down **REC**, press **RESET**.

```
OVERWRITE SETUP
SURE?PRESS>ENTER
```

- ③ Now, press **ENTER** and a new group of Setup Data will be written. This also resets the Composer. To cancel press **EXIT** instead.

\* In addition to Reverb ON/OFF and the Reverb Type, the following settings can also be written on an individual track:

Target Track	Part on/off	Part Balance	Reverb Level	Tone	Octave Shift	Chorus on/off	Pitch Bend Range
UPPER1	Yes	Yes	Yes	Yes	Yes	Yes	Yes
UPPER2	Yes	Yes	Yes	Yes	Yes	Yes	Yes
LOWER	Yes	Yes	Yes	Yes	Yes	Yes	Yes
BASS	Yes	Yes	Yes	Yes	Yes	Yes	Yes
ARRANGER	Yes	Yes	Yes	No	No	No	No
RHYTHM	Yes	Yes	Yes	Yes	No	No	No

Since the values for all of the above parameters will be written to reflect whatever settings you have in force at that moment on the panel, you should carefully check all of these settings before you go ahead and rewrite the Setup Data.

## ● How to Delete an Unnecessary Song in the Internal Memory

This function allows specified Song in the Internal Memory to be deleted (If you wish to delete the performance data in the specified measures, refer to "Delete" (P.105)).

### Operation

From the Master Screen:

- Press **SONG/DEMO** (In some other screen is being displayed, press **SONG/DEMO** again).

```
SELECT SONG No.
51> Song Name 1
```

Pressing **SONG/DEMO** lights up the indicators on the buttons (**1/ARRANGER** - **5/UPPER 2**) corresponding to Song Numbers which contain Song data. The Song Number Select screen will appear.

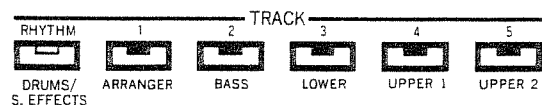

- Select the Song Number/Song Name by pressing one of the Track buttons (**1/ARRANGER** - **5/UPPER 2**).
- While holding down **REC**, press **DEMO**.

```
DELETE SONG
SURE?PRESS>ENTER
```

- Press **ENTER** to delete the Song which you selected in step ②. If you cancel the delete procedure at this point, press **EXIT**.

# 5

## Connecting with Other Equipment

# 1. Using the Connectors

Although the KR-4500 allows you to enjoy realistic ensemble-like performances by itself, even greater impact can be obtained if you connect the instrument to an external stereo or PA system. Also, whenever you wish to record onto a cassette tape recorder (or the like), you will need to make the appropriate connections, as explained in the following.

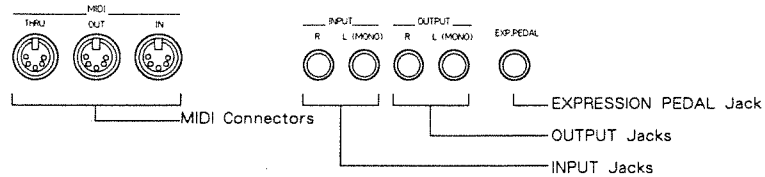

\*In order to make the connections between the instrument's jacks and external audio equipment, you will need to have suitable audio cables (sold separately). Make sure you select the appropriate kind.

Roland's PJ-1M (optionally available) is a cable which can be used for two different types of connection; both 1/4" phone ⇔ 1/4" phone, as well as phono ⇔ 1/4" phone. The adaptor that is included can also be used alone for phono ⇔ 1/4" phone plug conversions.

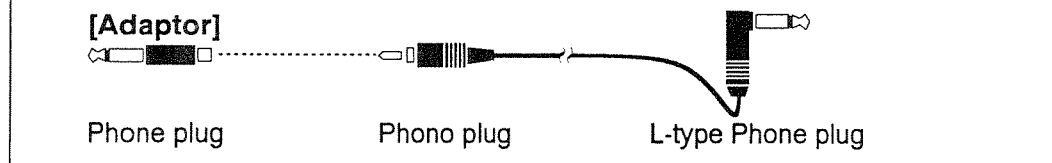

## a. OUTPUT JACKS

The VOLUME Slider controls the output of the OUTPUT jacks.

\*Always make sure you turn down the volume on the instrument (and any other equipment) before making any connections.

\*If the external unit you are using only accepts a monaural input, plug the cable into the L (MONO) jack on this instrument.

### ○ Connecting with a Stereo

**Required**: Two phono ⇔ 1/4" phone cables (The PJ-1M is convenient; simply remove the adaptor plug.)

Connect the cable's phono plugs to the external unit's LINE IN, AUX IN (or equivalent) jacks.

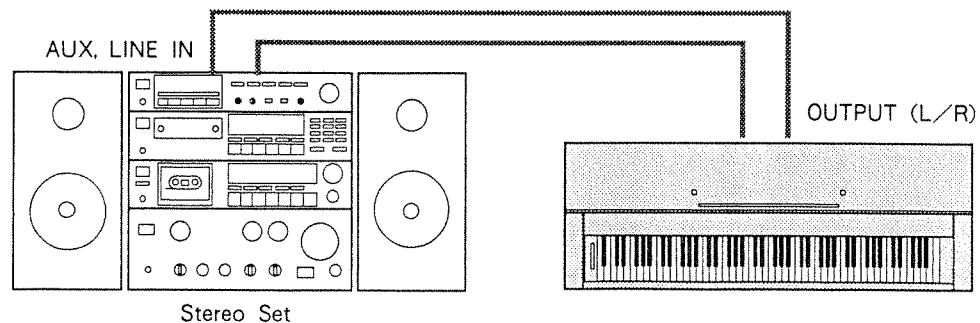



Audio cables which have phono jacks at both ends can also be used if you attach phono ⇔ 1/4" phone adaptors to the ends going to this instrument.



phono ⇔ 1/4" phone adaptors + Audio cable

## ○ Connecting with Keyboard Amplifiers

In order to get the most out of this instrument, the use of a stereo output is recommended.

**Required** : Two phone cables (PJ-1M)

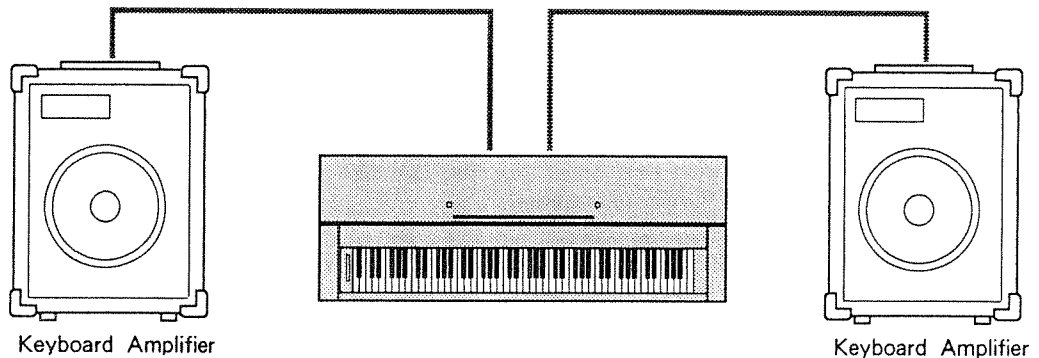

- \*If you are using only one amp, connect it to the L (MONO) jack on this instrument.
- \*When connecting to a guitar or bass amp, connect KR-4500 to the "LO" input jack (of a HI, LO pair).

## ○ Connecting with a PA Mixer

Connect to the jacks of unused channels.

**Required** : Two phone cables

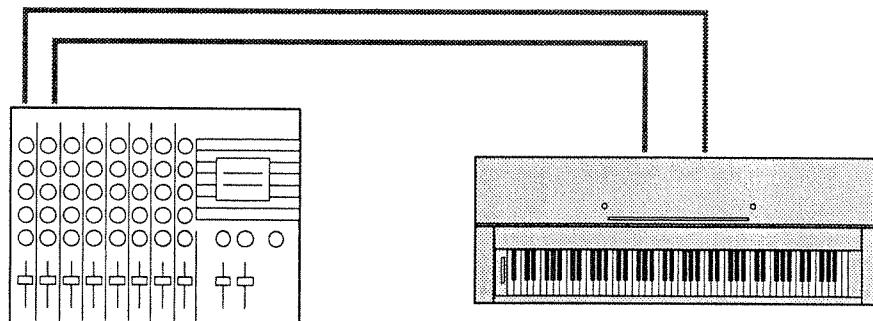

- \*The stereo sound field created by the KR-4500 can be fully appreciated by adjusting the panpot settings on the mixer.
- \*Set the volume on the instrument at maximum, and then adjust the actual output volume using the mixer's controls.

## ○ Recording onto a Stereo System or Cassette Recorder

Connect the cable's phono plugs to the external equipment's LINE IN, AUX IN (or equivalent) jacks.

**Required** : Two phono ⇔ 1/4" phone cables (The PJ-1M is convenient; simply remove the adaptor .)

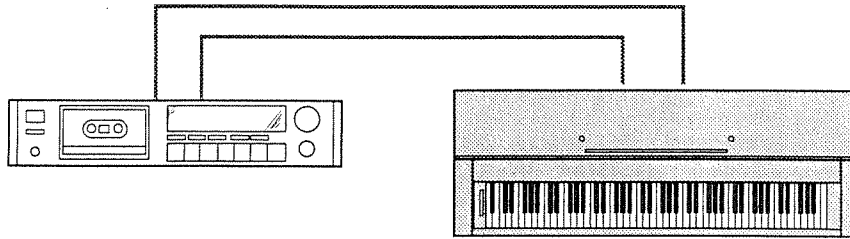

## b. INPUT Jacks

Using these jacks, you can have sound from a synthesizer (or other equipment) played through the KR-4500's speakers.

**Required** : phone cable (PJ-1M)

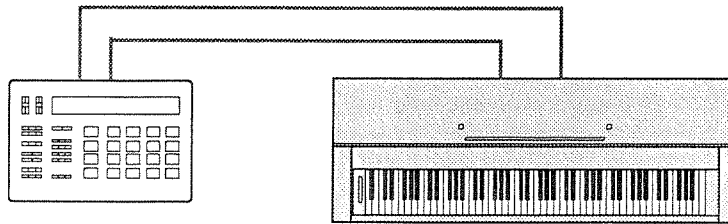

- \* Adjust the volume on the unit you have connected to get the appropriate volume.
- \* If the external unit provides only monaural output, make sure to plug the cable into the L (MONO) input jack on the KR-4500.

## c. Expression Pedal Jack

Once an expression pedal (EV-5; available separately) is connected to this jack, you gain pedal control over the instrument's overall volume.

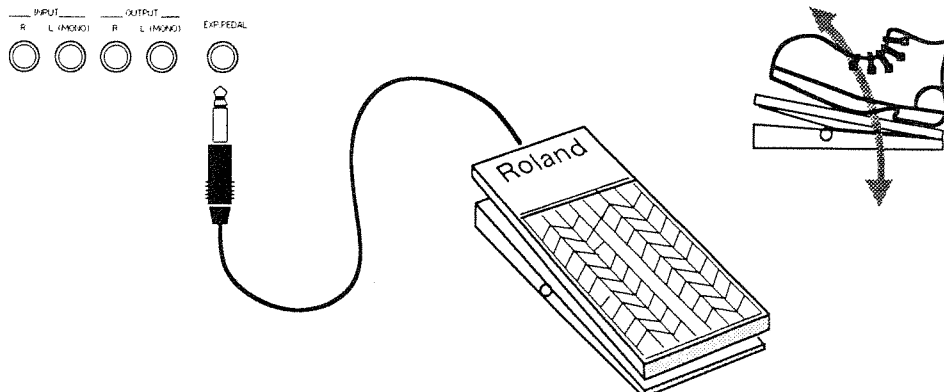

## 2. Using MIDI

### a. What MIDI Is ?

MIDI (Musical Instrument Digital Interface) is a standard that was formulated in order to provide for the transfer of performance, and other information, among electronic musical instruments and computers. Using MIDI to connect your KR-4500 to other electronic musical instruments, you can then use it to remotely control such units. Conversely, other instruments and devices can then be used to control your KR-4500.

### b. Devices That Can Be Connected Using MIDI

Some common examples of the types of devices that could be connected to KR-4500 using MIDI are as follows:

- Another keyboard or synthesizer
- MIDI pedal controller or keyboard controller

Once a keyboard-equipped external unit or pedal set (PK-5:sold separately) is connected, it can then be used to play some of the KR-4500's Parts. If the Upper Part is played using a keyboard controller, and the Manual Bass Part is played on a pedal controller, you will be able to enjoy the traditional playing style of an electronic organ.

- MIDI Sequencer

A sequencer is a device which provides for the recording/playback of performance information. The Composer section on this unit is a simple sequencer. However, you may find that a full-featured sequencer (such as the MC-50), which allows you to record each of the accompaniment parts individually, as produced by the Arranger, is more convenient. With such a sequencer, a multiple number of songs can be played consecutively without the need for the loading procedure. Additionally, by having access to a greater range of editing features which can be applied to recorded data, you can pursue a more creative, individual style.

\*The Composer's Song data can be transferred over MIDI to an external sequencer.

### c. MIDI Connectors and Cables

As shown below, there are three MIDI connectors on the rear panel of the KR-4500. These connectors are used by the unit when communicating with external equipment.

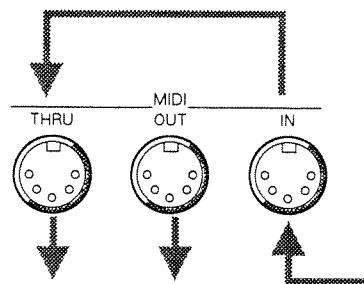

- MIDI THRU : Sends out an exact copy of whatever performance data has been received at MIDI IN.
- MIDI OUT : Sends out data describing everything performed on this unit.
- MIDI IN : Receives performance data sent by another MIDI device.

\*The KR-4500 has these connectors arranged in the following order, from the left : MIDI THRU, MIDI OUT, MIDI IN. Carefully check other devices you connect with, since you cannot automatically assume they use the same order. (In some cases the order is completely reversed.)

The connections between MIDI devices should be made using the appropriate MIDI cables (MSC-07/15/25/50/100; available for separately).

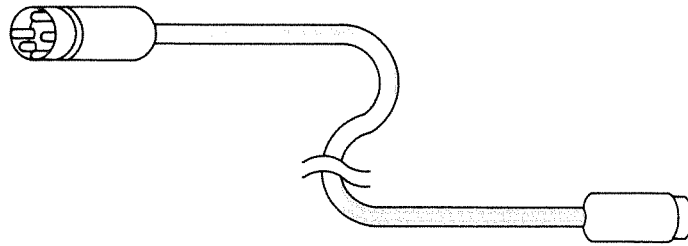

### d. Making the Connections

#### ○ Playing the KR-4500 and a Sound Module Simultaneously

Connect the units together as shown below. Then, whenever you play the KR-4500, the sound generating module will receive that performance information and simultaneously play the same notes.

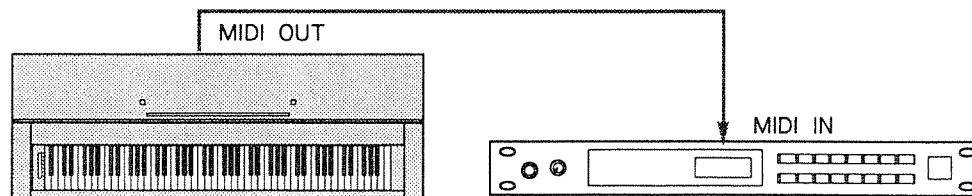

The unit that transmits the performance information is called the “master,” whereas the unit receiving the information is known as the “slave.”

#### ○ Simultaneously Controlling Two Sound Modules

As illustrated below, connect a cable between the MIDI OUT on the KR-4500, which becomes the master, and the MIDI IN on Slave 1. Then, run a cable between the MIDI THRU on Slave 1 and the MIDI IN on Slave 2.

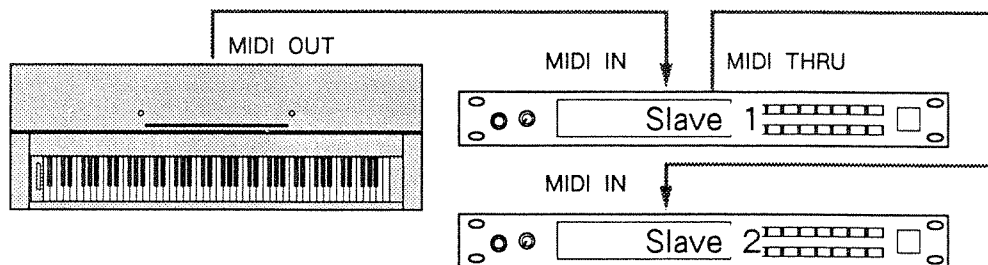

If you attempt to extend the above configuration by using MIDI THRU to connect onward to a third slave, the signal quality could likely deteriorate, and cause errors to occur.

### ○ Controlling a Large Number of Slaves

Should you need to control three or more slave devices, you should employ a MIDI THRU Box.

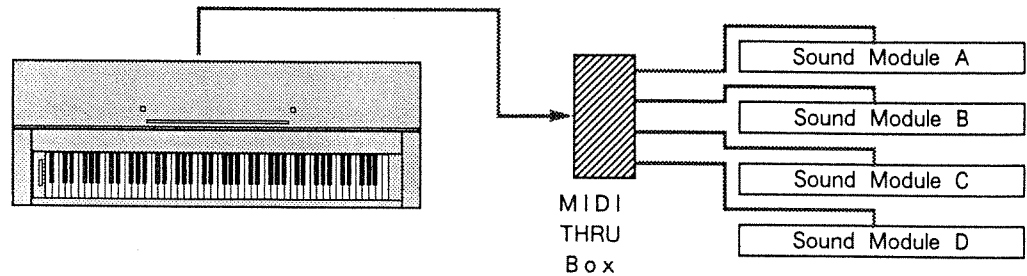

## e. MIDI Channels

With MIDI, a single cable can be used to convey a wide variety of performance information, for a number of MIDI devices. This is possible thanks to the concept of MIDI channels. MIDI channels are in some ways similar to the channels on a television set. On a television set, a variety of programs broadcast from different stations can be viewed by switching channels. This is because the information on any particular channel is conveyed only when the receiver is set to the same channel that is being used for transmission. Similarly, when a receiving device is set so its MIDI channel matches the channel used by the transmitting device, the performance data on that channel is conveyed. There are a total of 16 MIDI channels available for use.

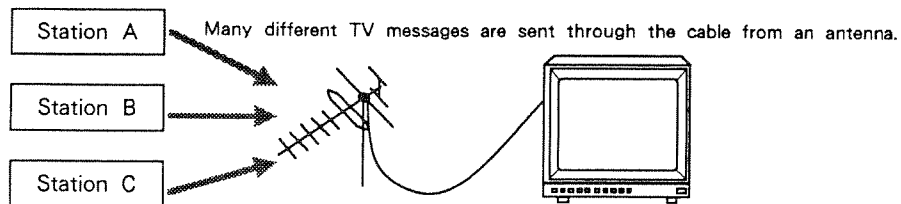

However, in one important aspect, the KR-4500 is quite different from television. One can usually only view one channel at a time on a television; whereas on the KR-4500, the performance information received on 10 channels can be independently played at the same time. This is because the KR-4500 has 10 Parts, each of which is a separate sound generator. All of these can sound at the same time, using a total of 10 channels of information. Instruments which are designed in this manner are referred to as being "multi-timbral."

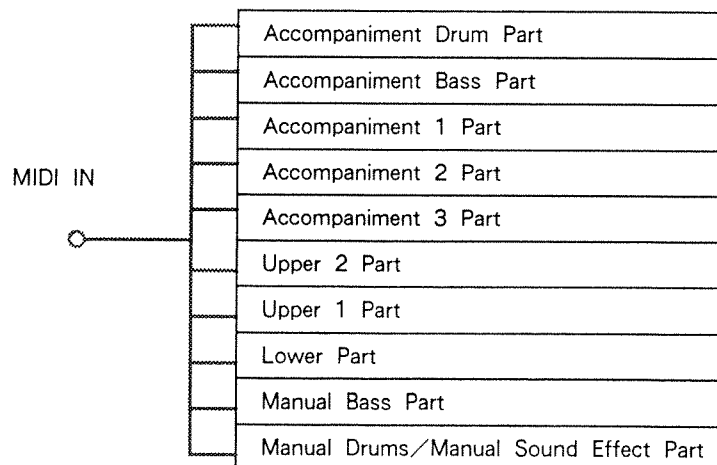

## f. Types of Data Handled Over MIDI

The performance information which MIDI handles is made up of numerous separate pieces of data (MIDI messages). All the various MIDI messages can be divided into two main types:

- Channel messages : Messages handled on each channel
- System messages : Messages handled overall, independent of individual channels

### Channel Messages

Messages of this type make up the great majority of MIDI data.

#### Note Messages

These messages are sent out whenever anything is played on the keyboard. Note messages include the following types:

Note Number: Number representing the position of the key pressed.

Velocity: Strength with which the key was pressed.

Note On: Sent out each time a key is pressed.

Note Off: Sent out each time a key is released.

\*When employing Drum or Rhythm Parts, Note Numbers are used to selectively play the percussive sounds.

#### Pitch Bend Messages

These Messages are sent out whenever the Pitch Bend Wheel (or Pitch Bend Lever) is operated.

#### Aftertouch Messages

These messages convey the amount of pressure that is further put on a key after it has initially been pressed. There are two types of Aftertouch; Channel and Polyphonic. Channel Aftertouch (or Channel Pressure) provides control on an individual MIDI channel basis, whereas Polyphonic Aftertouch (or Polyphonic Key Pressure) manages the information on an individual key basis. Note, however, that if a particular keyboard is not designed for a certain type of Aftertouch, it cannot transmit such Aftertouch messages.

\*The keyboard on the KR-4500 is not capable of transmitting Aftertouch messages.

#### Program Change Messages

These messages relay instructions about changes in the sounds that are to be used. Thus, the Tone used by a certain Part will be changed to comply with a Program Change Message received on the channel to which that particular Part is assigned. Similarly, when a Program Change Message is received on a channel assigned to a "Chord Recognition Part," the content of a Music Style will be changed.

#### Control Change Messages

These messages are used to enhance the expressiveness of a performance, and include Damper, Volume, and Pan related messages. Note that not all of the messages of this type will be recognized across the complete range of MIDI devices available. (Each device will be somewhat different.)

### System Messages

System Messages include Exclusive messages, data employed for carrying out synchronized play, as well as diagnostic-use data.

#### Exclusive Messages

Although MIDI is an internationally recognized standard used by most manufacturers, Exclusive Messages form one part of the standard where each manufacturer can devise their own types of data, as required. In other words, these types of messages are unlike the universally recognized messages in the major part of the MIDI standard, and can in a sense be considered as a "dialect" of the MIDI language as a whole. They can

be used to provide for certain unique features that a particular device may have. On the KR-4500, the GS Mode is under the control of Exclusive Messages. If an external unit sends a "GS Reset" as an Exclusive Message, the KR-4500's sound source will be automatically set to comply with the GS system of organization.

○ **Common / Real-Time Messages**

These messages are used to assure that any connected devices, such as a sequencer or rhythm machine, will be synchronized, and thus use the same tempo when playing, or will start or stop at the same moment. They allow for the KR-4500's Composer or Arranger to be played in sync with an external MIDI device, such as a sequencer. Common/Real Time Messages are given priority at all times, so they are processed first.

○ **Active Sensing Messages**

These messages serve to monitor the integrity of the MIDI connections. The system will "shut down" if cables become damaged or disconnected.

When the KR-4500 receives MIDI messages from the external MIDI device, Variation Tones specified in Roland GS format can be selected by receiving the Control Change messages and Program Change messages. Also, Control Change (NRPN) and Exclusive Messages can be employed to edit Tones and settings for effects. However, such procedures cannot be done using only the KR-4500, but rather need to be carried out using a connected sequencer or computer. Without software which supports such editing, however, a person would need to have considerable experience with MIDI and computing. For those wishing to explore such advanced MIDI applications, or for those who are programmers, a separate "KR-4500 MIDI Implementation Document" is available at any Roland Service Station.

**g. Concerning MIDI Implementation Charts**

MIDI makes it possible for communication between devices to take place readily, but there are still many differences between devices. Not all types of MIDI messages will be understood by every device on the market. In order to quickly check the compatibility between a master (transmitting) and slave (receiving) unit, every owner's manual includes a "MIDI Implementation Chart." This chart can be used at to determine the types of MIDI messages that can be received or transmitted by the device. The names of the various types of MIDI messages appear on the left side of the chart, in the Function column. In the Transmitted and Recognized columns there will be either a "O" or an "X," indicating whether or not that type of data can be transmitted or received. When a "O" appears in the row for a particular type of message in both the Transmit column for the master device, and in the Recognized column for the slave device, the units will be capable of communicating that type of data with each other. Since all MIDI Implementation Charts are laid out the same way, and are the same size, the charts for two different devices can be overlapped as shown below, allowing you to compare them more easily.

Device A Chart Table

Function	Transmitted	Recognized	Remarks

Device B Chart Table

# 3. Settings for MIDI Functions

The KR-4500 provides a full range of features which are controllable using MIDI. These features are explained in the following.

## a. MIDI Settings for the KR-4500

The following range of settings allow you to determine the manner in which the KR-4500 will send out its performance information when it is being used to play another instrument; or conversely, the manner in which the KR-4500 is to respond when it is being played by another unit.

- MIDI Channel :** These settings determine the MIDI Channel for each Part, and will be the channel on which both transmission and reception will take place.
- MIDI Sync Mode :** This setting determines the mode of the clock control of the KR-4500 (Internal/Remote/Auto Slave).
- MIDI Rx Start/Stop :** When this setting is set to ON, the Composer or Arranger will start/stop by receiving start/stop messages from an external MIDI device.
- MIDI Local Control :** This setting determines whether the keyboard control section (includes Pitch Bend Wheel) and the sound source (Upper, Lower, Manual Drums/Manual Sound Effects and Manual Bass Parts) are connected or not.
- Arranger MIDI Out Switch :** When this switch is set to On, the style performance data will be output from MIDI OUT.
- Composer MIDI Out Switch :** When this switch is set to ON, the playback data of the Composer will be output from MIDI OUT.

## b. MIDI Channel

Ordinarily, when playing with Styles, the keyboard is used to play the instrument's Tones; most often those assigned to Upper and Lower Parts. Once MIDI is brought into play, however, other Parts can be placed under the control of an external MIDI keyboard or sequencer. The various Parts are configured as shown in the next diagram ("Flow of the MIDI Messages"). By assigning a different MIDI channel to each of the Parts, they can then be controlled individually, making it easy to manage an ensemble-like performance.



# «Flow of the MIDI Messages»

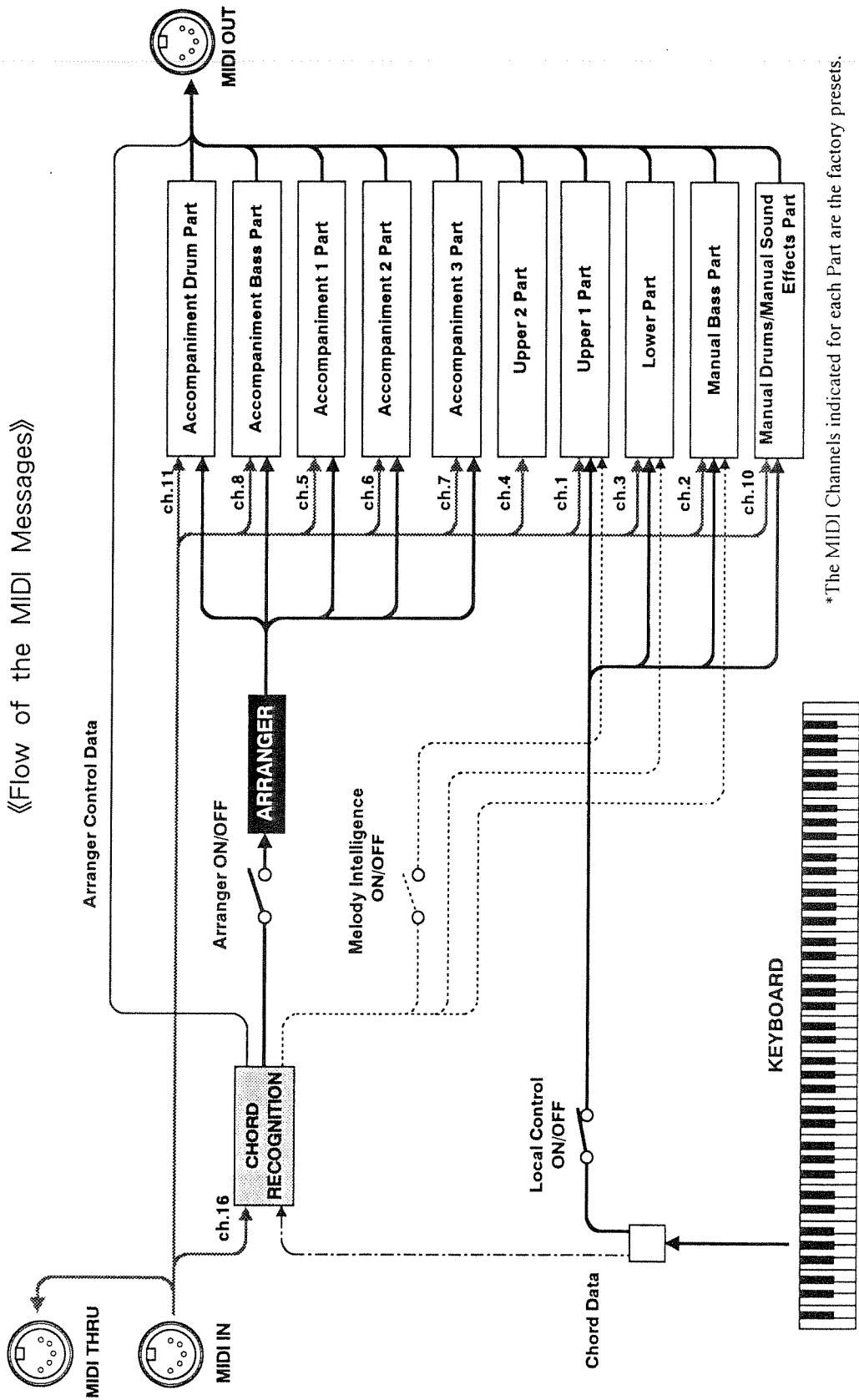

\*The MIDI Channels indicated for each Part are the factory presets.

When shipped from the factory, the following settings for MIDI channels and relevant switches were made.

Part	Channel	Switch
UPPER 1	1	ON
UPPER 2	4	ON
LOWER	3	ON
M. BASS (Manual Bass)	2	ON
M. DS; EFX (Manual Drums/Manual Sound Effects)	10	ON
ACCOMPANIMENT BASS	8	ON
ACCOMPANIMENT DRUMS	11	ON
ACCOMPANIMENT 1	5	ON
ACCOMPANIMENT 2	6	ON
ACCOMPANIMENT 3	7	ON
CHORD RC (Chord Recognition)	16	ON

#### Upper 2 Part

if the Composer's Upper 2 Track has been selected while recording, the performance data created on the UPPER keyboard will be transmitted on the MIDI channel used by the Upper 2 Part.

#### Chord Recognition Part

This Part provides control related to the Arranger. Unlike other Parts, however, it does not respond to Note messages or produce sound in the same manner.

Additionally, if Program Change messages are received on the MIDI channel used by the Chord Recognition Part, they will cause a change in the content of the Music Style.

#### [External MIDI Control]

When wishing to obtain control over the Style performance using an external controller, first make sure that the items below are set as indicated.

- GS Mode ON/OFF : OFF (☞ P.56)
- Arranger ON/OFF : ON (☞ P.34)
- MIDI Sync Mode : Auto Slave or Remote (☞ P.133)
- MIDI Rx Start/Stop : Arranger (☞ P.134)

In this condition, you may send the Start message (Common Realtime Message) to start the Style Play automatically. When an external controlling device sends chord data on the MIDI channel which has been assigned to the Chord Recognition Part, an automatic accompaniment pattern using 5 Parts will be created if the Arranger is ON. The Accompaniment 1/2/3, Bass, and Drums Parts will each sound independently. (Note that the Arranger cannot be turned on/off by an external device; it must be turned ON using the KR-4500 panel beforehand.) Should chord data be received while the Arranger is OFF, none of the above Parts will sound.

Any of the above settings for the MIDI Channel and Switch can be altered as desired in order to match with other equipment you are using.

### Operation

From the Master Screen:

- ① Press **MIDI** until you obtain the MIDI Channel operation screen for the Part you wish to alter.

```
MIDI: Channel
UPPER1 : 1* ON*
```

- ② Using **UPPER / ◀** or **A / ▶**, select the item you wish to change; either Channel or Switch.

\*In the display, the setting which can be changed will be flashing. Press either **UPPER / ◀ 1** or **A / ▶** to get the item you wish to change to begin flashing.

- ③ Change the setting using **INC** and **DEC**.

If it is the channel you are setting, the possible setting range is from 1-16. If it is the Switch that is being set, the possible settings are ON or OFF.

\* If the Switch is "OFF", no performance data will sent or received.

- ④ Press **EXIT** to return to the Master Screen.

\*When a Tone is selected, a corresponding Program Change message will be sent out on the MIDI channel that is currently set for that Part. See "Expansion Tone List" at the end of this manual for information on the Program Number that each Tone has been assigned.

After step ①, if **INC** and **DEC** are pressed together, the settings for the current Part can be returned to the factory default settings.

\* These settings revert to the factory defaults each time the power is turned ON.

## c. MIDI Sync Mode

When devices such as rhythm machines have been connected to this instrument via MIDI, performance information related to the rhythm, and Start/Stop/Tempo data for the Composer can be transmitted and received. Within the MIDI Sync Mode there are 3 selections provided which allow you to choose the manner in which the KR-4500 will play (or record).

- Internal :** All Start/Stop/Tempo data arriving from an external unit will be ignored. Therefore, synchronized play cannot take place. Start/Stop can be accomplished only by using the panel buttons on this instrument, and only the Tempo slider controls the tempo.
- Remote :** Start/Stop takes place only when messages directing the unit to do so are received from an external unit. (Start/Stop cannot be accomplished using the panel buttons on this instrument.) However, only this unit's Tempo slider provides control over the tempo.
- Auto Slave :** Whichever unit (either the KR-4500 or the external unit) initiates the event first will be the one that takes priority, and the other will Start/Stop in compliance with it. Likewise, with the tempo as well, whichever unit starts first will establish the tempo to which both will be synchronized.

\* Auto Slave is the factory default setting.

### Operation

From the Master Screen:

- ① Press **MIDI** until you obtain the MIDI Sync Mode operation screen.

```
MIDI: Sync.Mode
      Auto Slave
```

- ② Using **INC** and **DEC**, select the mode appropriate for the performance situation.
- ③ Press **EXIT** to return to the Master Screen.

After step ①, if **INC** and **DEC** are pressed together, the setting can be instantly returned to the factory default setting.

\* This setting reverts to the factory default each time the power is turned ON.

## d. MIDI Rx Start/Stop

This setting allows you to choose whether you want the Rhythm or Composer to start when Start/Stop messages are received from an external device.

Composer : When Start/Stop messages are received, recording will Start/Stop if the Composer has been in the recording condition; otherwise, playback will Start/Stop.

Arranger : When Start/Stop messages are received, the Arranger's Style Play will Start/Stop.

\* If the MIDI Sync Mode is set to "Internal," the above functions will not work.

### Operation

From the Master Screen:

- ① Press **MIDI** until you obtain the MIDI Rx Start/Stop operation screen.

```
MIDI: Rx [ST/SP]
      Composer
```

- ② Using **INC** and **DEC**, select the setting appropriate for the performance situation.
- ③ Press **EXIT** to return to the Master Screen.

\*Composer is the factory defaults setting. This setting reverts to the factory default each time the power is turned ON.

## e. MIDI Local Control

When MIDI Local Control is set to OFF, the keyboard will no longer be connected with many of the sound producing Parts (Upper, Lower, Manual Drum/Manual Sound Effects, and Manual Bass Parts ; for details, see «Flow of the MIDI Messages» on page 131).

Although no sound will be produced by this unit when playing the keyboard, the performance data will be sent out over MIDI. Note, however, that if the Arranger is ON, and keys within the chord detection zone are played, the performance information will be sent to the Chord Recognition Part. As a result, the automatic accompaniment produced by the Arranger will be sounded by this unit.

\* To play the instrument normally, this setting must be at ON.

\*When Local Control is set to OFF, and you have a MIDI sound generator connected, the keyboard will sound using the external sound source. Should the maximum polyphony become insufficient during play of a Style, try setting the MIDI channel for the Upper Part and for the external sound module to the same channel. Then, the melody will sound using the external sound module, while leaving all the KR-4500's voices for the Arranger to make use of.

### Operation

From the Master Screen:

① Press **MIDI** until you obtain the MIDI Local Control operation screen.

```
MIDI: Local CTRL
      ON
```

② Using **INC** and **DEC**, select either ON or OFF.

③ Press **EXIT** to return to the Master Screen.

\*ON is the factory default setting, the unit is set to ON. This setting reverts to the factory default each time the power is turned ON.

## f. Arranger MIDI Out Switch

When the Arranger MIDI Out Switch is set to ON, performance data produced while an automatic accompaniment is played will be output from MIDI OUT. When set to OFF, these data will not be output.

\*The Arranger can be used to play a GS Sound Source if connected to this unit. Additionally, performance data which arrives on the Chord Recognition Part can be passed through the Arranger (which creates data for an ensemble using 5 Parts), before being sent to an external sequencer for storage.

## Operation

From the Master Screen:

- ① Press **MIDI** until you obtain the Arranger MIDI Out Switch operation screen.

```
MIDI: Tx Arr'nger  
OFF
```

- ② Using **INC** and **DEC**, select either ON or OFF.
- ③ Once the setting has been made, press **EXIT** to return to the Master Screen.

\*OFF is the factory default setting. This setting reverts to the factory default each time the power is turned ON.

## g. Composer MIDI Out Switch

When the Composer MIDI Out Switch is set to ON, performance data produced by the Composer will be output from MIDI OUT. When set to OFF, this data will not be output.

## Operation

From the Master Screen:

- ① Press **MIDI** until you obtain the Composer MIDI Out Switch operation screen.

```
MIDI: Tx Com'poser  
OFF
```

- ② Using **INC** and **DEC**, select either ON or OFF.
- ③ Once the setting has been made, press **EXIT** to return to the Master Screen.

\*OFF is the factory default setting. This setting reverts to the factory default each time the power is turned ON.

If you wish, you can also have the data that is output by the Composer be routed through the Arranger, where it will be enhanced by having an accompaniment applied to it before being output from MIDI OUT. To do this, simply set the MIDI Out Switches for both Composer and Arranger to ON. Note, however, that by requesting the KR-4500 to handle the much larger volume of data that it will be outputting from MIDI OUT, its performance (processing speed) may be reduced somewhat.

**6**

**Appendix**

# ■ About General MIDI and GS Compatibility

## a. What are "General MIDI System" and "GS Format" ?

With conventional MIDI sound generating devices, there have been numerous differences between one unit and the next. Such differences include those in the numerical correspondence for the variety of sounds, the manner in which they will sound, as well as the response they will provide when various controllers are used. Even when considering products produced by the same manufacturer, one might observe that model changes that have been unfettered by a strive for compatibility have on occasion unavoidably resulted in the obsolescence of earlier units.

After taking the above problems into consideration, a higher level of standardization (such as the General MIDI System or the GS Format) for MIDI sound generation units was created. You can now feel assured that any sound generating module that supports the General MIDI or the GS Format, will prove a faithful quality of expression when performing using an identical set of MIDI data.

### General MIDI System

The General MIDI System is a universal group, of specifications for sound generating devices which has been agreed upon by both the Japan MIDI Standards Committee and the American MMA (MIDI Manufacturers Association). These specifications seek to make it easier to create music data which will be equipment by a particular manufacturer or to specific models. As a result, any GM sound source (a device that is equipped with sound source which support the General MIDI System) will be able to reproduce General MIDI Scores ( music data created specifically for devices supporting the General MIDI System), regardless of the manufacturer or model. Such General MIDI sound sources and General MIDI Score will have the "GS" logo on the front panel, or other prominent location, making them easy to recognize from others.

### GS Format

The GS Format proposed by Roland, incorporates all of the recommendations outlined for General MIDI (General MIDI System-Level 1), and in addition provides the selection of a much larger number of sounds and defines many of the finer details for other expressive features that can be applied during performance. Thanks to this format, any device that is equipped with GS sound source will faithfully reproduce music data that was created under the GS Format, regardless of the particular model used.

Any product which conforms to the GS Format will carry both the "GS" and "GM" logos, which means that it allows for the use of both GS music data and General MIDI Scores.

Note that song data that you create using the KR-4500's Composer may not always be reproduced as expected if played on some other GS or GM sound source. This is because the KR-4500 provides a number of advanced features that have not been included as part of the features defined by the GS Format and the General MIDI System (however, both GS music data and General MIDI Scores can be reproduced by the KR-4500).

\*Certain sounds are formed by combining 2 voices. Be aware, therefore, that when using such sounds, the number of voices that will be produced simultaneously will be reduced. See page 153 for details on the number of voices used by each sound.





## **b. Main Features when the GS Mode is On**

The KR-4500 is equipped with sound sources that comply with the GS Format.

In each of the situations listed below, the GS Mode for the KR-4500's sound sources will be switched to ON.

- When the UTILITY function has been used to turn ON the GS mode.
- When song data which has the "GS Reset" message (Exclusive message) recorded within it is played back.
- When a "GS Reset" message has been received from an external MIDI device.

Once the GS mode is ON, all settings related to the KR-4500's sound sources, including panel settings, will be altered so that they comply with the GS Format.:

Number of Parts : 16

Maximum polyphony : 28 (voices)

Tone selection : The number of sounds which can be selected by an external controller is increased significantly, since Control Change messages (Bank Select) can be employed along with ordinary Program Change messages.

Drum Sets : Selection of Drum Sets can be performed using Program Change data.

Effects : Reverberation and Chorus are provided internally, and the degree to which they are applied can be set independently for each Part.

**By performing either of the actions below, all the settings related to the KR-4500's sound sources will be altered so that they comply to GM.**

- Whenever song data which has the "GM System On" message (Exclusive messages) recorded within it is played back using this unit's Composer.
- Whenever a "GM System On" message is sent to the KR-4500 by an external MIDI device.

In actuality, when the sound sources receive the "GM System On" message, the unit will behave the same way as it would when receiving a "GS Reset" message; it turns ON the GS Mode, and thereafter functions as a GS Sound Source device.

To get the unit to behave as it would after reception of a "GM System On" message, you can also use the UTILITY function to turn ON the GS mode.

## **c. How the Panel Functions when the GS Mode is On**

Whenever GS mode is ON, the keyboard will be fixed at WHOLE, and only the Upper Part can be sounded when the keyboard is played. However, you will still be able to play Manual Drums/Manual Sound Effects on the keyboard, and the metronome will be available for use.

Also, the Part Balance buttons can be used to control the volume of any of the sounds assigned to MIDI channels.

When the GS Mode is ON, changes can be made in the settings listed below.  
No changes can be made for any others.

- |  |  |
|--|--|
| <input type="radio"/> Tone Select        | <input type="radio"/> Pitch Bend Range     |
| <input type="radio"/> Master Tuning      | <input type="radio"/> Keyboard Sensitivity |
| <input type="radio"/> Transpose          | <input type="radio"/> LCD Contrast         |
| <input type="radio"/> MIDI Channel       | <input type="radio"/> Metronome Level      |
| Upper                                    | <input type="radio"/> GS Mode              |
| <input type="radio"/> MIDI Sync Mode     | <input type="radio"/> Reverb ON/OFF        |
| <input type="radio"/> MIDI Local Control | <input type="radio"/> Reverb Type          |
| <input type="radio"/> Composer MIDI OUT  | <input type="radio"/> Chorus ON/OFF        |
|  | <input type="radio"/> Chorus Type          |

\*Since Channel 10 is designed to be used mainly by the Drum Part, it ignores transposition settings.

## ■ Playback of Standard MIDI Files

### a. What Are Standard MIDI Files ?

Standard MIDI Files are files that have been created in the standard data format established for sequencer data. A sequencer, of course, is a device which allows for the recording, editing, and playback of performance information which originally may have been produced by an instrument, and often has been conveyed by MIDI. The Composer on this instrument is in itself one form of sequencer.

Until recently, the data format used by most sequencers was not compatible with most other sequencers. So, for example, if a disk created using sequencer "A" were to be inserted into sequencer "B," it would quite often not be able to read the disk, or provide playback of the data. The Standard MIDI File format was created in order to alleviate such inconveniences. If you only use sequencers and software that support Standard MIDI Files, you do not have to worry about compatibility problems, since communication can be carried out readily among such devices.

\*On the KR-4500, you will only be able to play back Standard MIDI File data. Recording / editing is not permitted.

### b. About Roland's "SMF Music Data" Collection

Roland has released a collection of song files (on floppy disk) which are compatible with the Standard MIDI File format. This collection is known as the "SMF Music Data" collection.

The Composer on the KR-4500 also supports use of Standard MIDI Files. By using such files, a number of creative possibilities can be enjoyed, since you are not limited to simply listening.

Any floppy disk which carries the SMF logo contains song data that is in the Standard MIDI File format. All such disks can be played on the KR-4500. Note that a " ::" will appear within the song name that is displayed on this unit's screen when the song is composed of data that is in the Standard MIDI File format.

\*The disks in the SMF music data collection are designed to be compatible with GS sound sources. For this reason, they contain a "GS Reset" message at the start of each song. Thus, the instrument will automatically be set to the GS Mode when playback begins.

# SMF

The Roland SMF Music Data collection includes the following:

Instrumental Series : Beyond just listening to these songs, you can interact with the music by selecting different instrument sounds for each part.

Vocal Series : These songs provide instrumental backing for those who like to sing!

\* Lyric sheets not included.

## c. Playback of Roland SMF Music Data

### Operation

From the Master Screen:

- ① Place the supplied template over the Composer section.
- ② Insert the disk containing the SMF Music Data into the disk drive.
- ③ Press **LOAD**.

```
LOAD SONG  No 1
ALL SMF PLAY
```

- ④ Select the Song you wish to playback by pressing **PREV** or **NEXT**.

\*If you see the symbol "\*" to the right of the Song Name, it means that the Song is stored in Standard MIDI File format.

\* Press **PREV** to select the previous Song or **NEXT** to select the next Song.

- ⑤ Press **PLAY**. The following screen will appear, and playback will start.

```
♩:80 SMF PLAYING
Song Name 1*
```

\* The GS Mode is automatically turned ON the moment playback starts.

\* To stop play while in progress, press **STOP**.

If at this time you press **PLAY** rather than **PREV** or **NEXT**, you will hear all the songs, one after another.

When you press **PLAY**, the first song is loaded, and playback begins. Thereafter, when each song ends, the next is loaded and played automatically until you press **STOP**.

Press **STOP** to stop the play while in progress and select the Song you wish to hear by pressing **PREV** or **NEXT**, then press **PLAY** again to restart the playback of all Songs from the beginning of selected Song. Should you wish to stop play partway through, press **LOAD**.

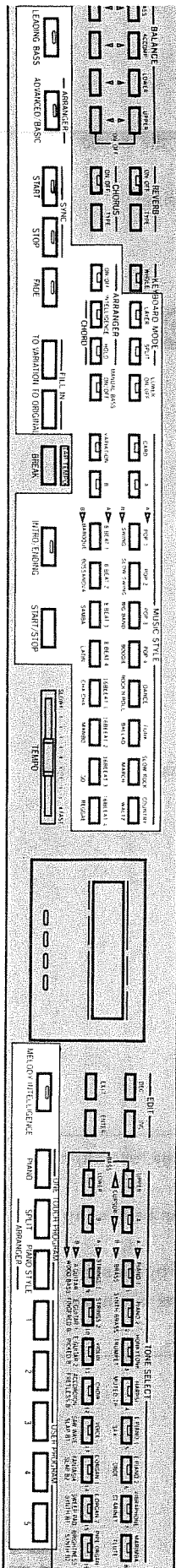

### A Point of Advice

When GS Mode is ON, you can play the internal sound source by the keyboard or via received MIDI messages. The Arranger is disabled, which means you can't use Style Play. However, GS mode is automatically set to OFF, and Style Play is once again enabled, by pressing any of the buttons not tinted gray in the drawing to the left. If you press one of these same buttons during playback of SMF Music Data, you'll see the following message, and Style Play will be disabled.

ARRANGER inactive  
during playback

If this happens, press **STOP** or **RESET** to stop playback, then once again to enable Style Play.

### d. SMF Channel Mute

To mute the data on any particular channel, press the corresponding Channel Mute button, and confirm that its indicator has gone out. This allows you to selectively listen to certain Parts within the song data.

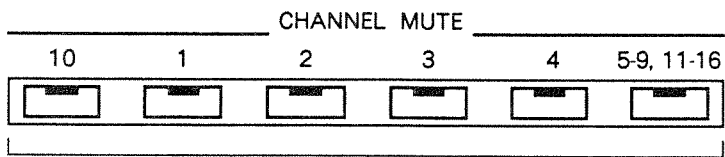

Press one of these buttons.

When playing songs in the Vocal series, you can mute the data on channel 4 to obtain a "karaoke" song, which you or your friends can then sing along with.

## e. SMF Channel Volume

During play of SMF Music Data, the volume of any of the sounds assigned to MIDI channels can be adjusted by using the Part Balance buttons.

The correspondence between Part Balance buttons and MIDI channels is as shown below.

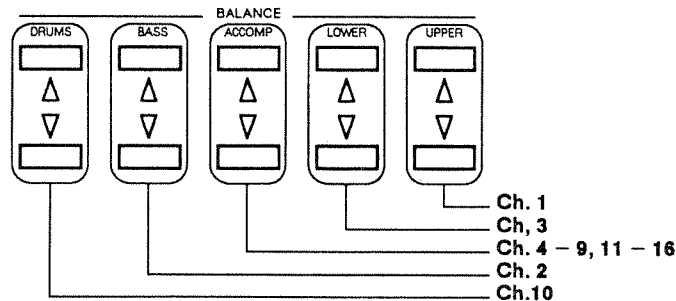

### Operation

Press to increase the volume, and to lower it.

## f. Changing MIDI Channels

On occasion, the notes you play on the keyboard while listening to a Standard MIDI file may sound using an unexpected Tone or pitch. Also, what is actually produced when a Standard MIDI file is played will be altered by whatever Tone selections, movement of the Pitch Bender, etc., that you make.

The reason for this is that the performance data stored on the floppy disk, and the data you generate by playing the keyboard, will be mixed and sent to the sound source together, if they use the same MIDI channel.

If necessary, perform the steps below to change the MIDI channel used by the Upper Part you are playing on the keyboard.

\*Although the keyboard can be used to play the Manual Drums/Manual Sound Effects Part, the MIDI channel used by this Part cannot be changed.

### Operation

From the Master Screen:

① Press until you obtain the MIDI Channel operation screen for the Upper Part.

```
MIDI: Channel
UPPER1 : 1* ON*
```

② Using the or cursor buttons, select the item you wish to change; either Channel or Switch.

\* In the display, the setting which can be changed will be flashing.

③ Change the setting using **INC** and **DEC**.

If it is the channel you are setting, the possible range is 1-16. If it is the Switch that is being set, the possible settings are ON or OFF.

④ Press **EXIT** to return to the Master screen.

\*To prevent performance data from being mixed, you could use the Channel Mute function to mute the performance data that is on channel 1 in the Standard MIDI File.

## g. SMF Data Created on Other Devices

The KR-4500 provides for the play of song data created by other devices, as long as it is in a Standard MIDI File format (SMF data). Standard MIDI Files can be in either of two types of formats, Format 0, or Format 1. The KR-4500 is capable of playing back both of these types.

Format 0 : Consists of a single track, and within it the data for multiple MIDI channels.

Format 1 : Allows for multiple tracks, within which the data for multiple MIDI channels is placed individually. Note, however, that the KR-4500's Composer imposes some restrictions on the number of tracks that can be used. Also, the amount of time required for loading will be longer compared with Format 0 files.

\*SMF data in Format 1 on your disks cannot be played consecutively. Only those songs that are in Format 0 can be played one after the other. (All disks in the Roland SMF Music Data library use Format 0.)

\*The KR-4500's Composer only supports data which is contained in tracks 1-16. When wishing to exchange data in Format 1, you will first need to take all the data that was in tracks 17 and above, and merge (a feature provided on most sequencers) them into lower-numbered tracks. All data in tracks 17 and higher will be ignored. Moreover, some large size data files may not play.

Although you can be assured that Standard MIDI File data will be transferred correctly using this unit, there can be no assurances regarding how the data will actually sound when played on another system. After being transferred, such data often may require some editing. (It is of course ultimately best to use the same sound generating equipment for playback.)

### 《Checking for Problems》

#### On the part of the sequencer

- Check to make sure the sequencer's time base is appropriate.

\* **The time base used by the Composer is 120 clocks/quarter note.**

#### On the part of the sound module

- Check for the correct correspondence between the way sounds are ordered and the Program Change numbers used by the data.
- Check the MIDI channels used by the Parts.
- Check the Note Numbers used by percussive sounds.
- Check the maximum polyphony of the sound module against the number of voices used by each Part.

\*However, if the data is a Standard MIDI File that was created specifically for use with a GS compatible sound source, you can be assured of identical playback on any other unit that supports the GS Format. All of the music provided in the SMF Music Data collection is meant to be played on a GS compatible sound source.

In addition to SMF Music Data, the KR-4500's Composer is also capable of playing the following types of data.

**SMF data created on an IBM, ATARI, NEC, or compatible computer**

First have ready a 2DD disk which has been formatted using the KR-4500. Then, when ready to save SMF data, insert the disk into the computer. Once created in this manner, the disk can be used and played by the KR-4500.

\*With certain IBM computers and compatibles, you can also use 2HD disks which have been formatted on the KR-4500.

**SMF data created on a Macintosh SE, II, or Plus**

You will first need to have an external disk drive which can read and write MS-DOS format disks. (A number of these are available from third-party suppliers.) First, take a 2DD or 2HD disk which has been formatted on the KR-4500 and insert it into the MS-DOS drive. Then using the "Apple File Exchange" or similar utility, save the SMF file as an MS-DOS file on the disk. Make sure that the name of the file being saved is given the extension ".MID".

**SMF data created on a Macintosh equipped with the Apple Super Drive (models newer than an SE, II, or Plus)**

First have ready a 2DD or 2HD disk which has been formatted on the KR-4500. Then using the "Apple File Exchange" or similar utility, save the SMF file as an MS-DOS file on the disk. Make sure that the name of the file being saved is supplied with the extension ".MID".

**Song data created with the Roland MC-50/500mkII/300/500**

By making use of the Roland MIDI File Converter (MRM-500; available separately), song data disks created on the above units can be converted to Standard MIDI Files, and then be used on the KR-4500.

**Song data created with the Roland MV-30**

Simply use the "Save MIDI File" command to directly create a Standard MIDI File on the disk.

**Song data created using the Roland Sound Brush**

Song data created on the Sound Brush is automatically saved in the Standard MIDI File format when saved on disk. Thus, such disks can be used as they are with the KR-4500. Data that was originally created with the Sound Canvas (GS compatible sound generator) in mind can be played on the KR-4500, and the same results will be obtained.

Macintosh is a registered trademark of Apple Computer, Inc.

## ■ Troubleshooting

### a. Before you consider the machine to be malfunctioning...

Because the KR-4500 has so many different types of functions, there may be times when you will find it difficult to make the settings work as you wish them to. The following is meant to assist you in troubleshooting when you have problems.

#### Q. There is no sound.

- A.  Is the volume setting at "0"?
- Are headphones plugged in?
- Is the BALANCE setting of Part Volume at "0" or OFF?
- Is Local Control set to OFF?
- When the power is turned On and then Off repeatedly, with only short intervals in between, the mechanism will sometimes malfunction. When this happens, turn the power off, wait a short time, and then turn it back on again.

#### Q. The following message is displayed immediately after the power is turned on.

```
NO MEMORY BACKUP  
PRESS >WRITE
```

- A. Memory data for panel and keyboard settings have been lost (this is not a malfunction). When this happens, press **WRITE** to return to the factory default settings. This will permit the sound to return.

**\*While the KR-4500 will retain data in memory for about one month (after the power has been turned off), all important data should always be saved to floppy disk.**

#### Q. The display returns to the Master Screen during operation.

- A. Immediately press one of the buttons on the panel. Even during operation, if none of the buttons on the panel have been operated for a period of time, the display will return to the Master Screen. Also, after making settings, it is best to return to the setting screen and check to ensure that the settings are as you desire them.

#### Q. Not all melody sounds are played.

- A. While the KR-4500 is able to play 28 sounds simultaneously, because a single unit is playing many parts during Auto Accompaniment, some sounds may be lost when several sounds are played at the same time. In order to avoid this when performing using a style which uses the Layer Mode or Melody Intelligence functions, pay close attention to ensure that the overall number of sounds played at the same time do not overload the capacity of the equipment.



**Q. The damper (sustain effect) stays on during play.**

- A.** Is the damper pedal properly connected? Refer to the assembly diagram in the keyboard stand box.

**Q. Sounds overlap, or sounds not selected are played.**

- A.**  Have you placed the KR-4500 in the layer mode (produces overlapping sounds)?  
In the layer mode, two overlapping sounds are played (refer to Layer Mode on page 12)
- Have you placed the KR-4500 in the Tone Expansion Mode ? (Selected sounds won't play.)  
In the Tone Expansion Mode, the Tone Selector button is enabled (refer to Tone Expansion Mode on page 65).
- Have you checked to make sure you haven't inadvertently entered the GS Mode? (Selected sounds won't play.)  
(refer to GS Mode on page 56)

Under any of the above conditions, just turn the power off for a moment, then turn it on again. When the power is turned on again, the KR-4500 will return to its original settings. When each of the above possible causes have been checked, but the actual problem cannot be found, or if there are any questions, please contact your nearest Roland service dealer.

## b. Error Message List

### Music Style Card

When the Music Style Card cannot be read normally, the following error messages will be displayed.

```
CARD NOT READY  
PRESS>EXIT
```

#### <Cause>

No Music Style Card has been inserted.

#### <Remedy>

Insert a Music Style Card, then start over.

```
NO STYLE DATA  
PRESS>EXIT
```

#### <Cause>

You are trying to call a Music Style from a memory card on which no Music Style has been recorded.

#### <Remedy>

Insert a Music Style Card and start over again.

### Recording

When performance data cannot be recorded, the following messages will be displayed.

```
SMF DATA PROTECT  
S > Song Name 1*
```

#### <Cause>

You are trying to record over standard MIDI file performance data.

#### <Remedy>

Standard MIDI files cannot be overwritten or edited. Press

**RESET**.

```
INT.MEM.FULL!!  
S1> Song Name 1
```

#### <Cause>

As internal memory capacity has been exceeded, no more data may be recorded.

#### <Remedy>

Delete from memory unnecessary performance data, then attempt to record again.

**\*Before this screen display appears on your monitor, you will see the following screen.**

```
INT.MEM.LIMIT!  
S1> Song Name 1
```

### Edit, Function

If performance data cannot be edited normally, the following error messages will be displayed.

```
NO SONG DATA  
PRESS>LOAD
```

#### < Cause >

At the selected song number there is no song data to be edited.

#### < Remedy >

Make the selection again, this time selecting a song number that contains data or loading a new Song, thus allowing editing to be carried out.

### Playback

If performance data cannot be played back normally, the following error messages will be displayed.

```
NO SONG DATA  
PRESS>LOAD
```

#### <Cause>

The Song Number of performance data played is not contained in memory.

#### <Remedy>

Make the selection again, this time selecting a song number that contains data or loading a new Song, thus allowing playing back to be carried out.

```
BEAT MISMATCH  
PRESS>EXIT
```

#### <Cause>

You are trying to select a musical style different than the pitch and time signature set during the recording session.

#### <Remedy>

Select a Music Style during recording that corresponds to the set pitch and time signature.

## Save

If performance data has not been saved to disk normally, the following error messages will appear.

```
DISK NOT READY  
PRESS>EXIT
```

### <Cause>

The floppy disk is not properly inserted into the drive.

### <Remedy>

Re-insert the floppy disk into the drive, and try to save again.

```
DISK PROTECTED  
PRESS>EXIT
```

### <Cause>

The write protect feature on the floppy disk has been enabled, preventing the file from being written to the disk.

### <Remedy>

- ① Press **EXIT**, then remove the disk from the drive.
- ② Move the protect tab on the floppy disk to "WRITE."
- ③ Insert the floppy disk back into the drive, then try to save again.

```
IMPROPER DISK  
PRESS>EXIT
```

or

```
UNFORMATTED DISK  
PRESS>EXIT
```

### <Cause>

The floppy disk has not been formatted by the KR-4500.

### <Remedy>

Press **EXIT**.

```
FORMAT DISK  
SURE?PRESS>ENTER
```

Either press **ENTER** to format the disk, or press **EXIT** to replace the disk with one formatted by the KR-4500. Start again.

## Caution:

When a disk is formatted, all the data saved on it is lost.

```
SAVE USR PROGRAM  
PRESS>WRITE
```

### <Cause>

The saved performance data was not saved under the selected Song Number.

### <Remedy>

Press **EXIT**, select the Song Number under which the data was saved, then save the data.

```
OVERWRITE FILE  
SURE?PRESS>ENTER
```

### <Cause>

You are trying to save your file under a name already being used by another file on the disk.

### <Remedy>

In order to overwrite the file on the disk, press **ENTER**. If you do not wish to overwrite the file, change the file name, then save again.

```
WRITE PROTECTED  
PRESS>EXIT
```

### <Cause>

- ① You are trying to save a file to the master disk (a disk onto which no file may be saved).
- ② The Song Data you are trying to save is copy protected and cannot be saved.

### <Remedy>

Only in the case of ① (above) can the data be saved. This may be accomplished by saving the data onto another floppy disk to which a file may be saved.

```
DISK.MEM.LIMIT!  
S1> Song Name 1
```

### <Cause>

The floppy disk is full and no more data may be saved to it.

### <Remedy>

Replace the disk with another one, or remove sufficient data from the current disk so that the new file may be saved. Try the Save operation again.

```
DISK.MEM.LIMIT!  
U > Pgm.Name 1
```

**<Cause>**

The floppy disk is full and no more data may be saved to it.

**<Remedy>**

Replace the disk with another one, or remove sufficient data from the current disk so that the new file may be saved. Try the Save operation again.

---

**Loading**

When the loading of performance data from disk cannot be accomplished normally, the following error messages will be displayed.

```
DISK NOT READY  
PRESS>EXIT
```

**<Cause>**

No floppy disk has been inserted into the disk drive.

**<Remedy>**

Insert a disk into the drive, then start again.

```
IMPROPER DISK  
PRESS>EXIT
```

or

```
UNFORMATTED DISK  
PRESS>EXIT
```

**<Cause>**

The floppy disk has not been formatted by the KR-4500.

**<Remedy>**

Press **EXIT**.

```
FORMAT DISK  
PRESS>ENTER
```

Either press **ENTER** to format the disk, or press **EXIT** to replace the disk with one formatted by the KR-4500. Start again.

**Caution:**

When a disk is formatted, all the data saved on it is lost.

```
NO SONG FILE  
PRESS>EXIT
```

or

```
LOAD USR PROGRAM  
PRESS>WRITE
```

**<Cause>**

There are no song files on the disk that may be loaded.

**<Remedy>**

Press **EXIT**, replace the disk with one with song files saved to it, then try to Load once again.

```
NO USR PROG FILE  
PRESS>EXIT
```

**<Cause>**

There are no User Program files on the disk that may be loaded.

**<Remedy>**

Press **EXIT**, replace the disk with one with User Program files saved to it, then try to Load once again.

```
INT.MEM.LIMIT!  
S1> Song Name 1
```

**<Cause>**

Internal memory is full and no more data may be loaded into it.

**<Remedy>**

Remove unnecessary data from memory, then try to Load once again.

```
OVERWRITE SONG  
SURE?PRESS>ENTER
```

**<Cause>**

The Song Number you are trying to Load contains newly added performance data, or performance data that has been edited.

**<Remedy>**

In order to overwrite the song, press **ENTER**. If you do not wish to overwrite the song, either change the Song Number of the song you are trying to Load, or save the performance data in memory to a floppy disk, and try to Load once again.

---

### Deleting a file

When a file cannot be normally deleted from a floppy disk, the following error messages will be displayed.

```
NO SONG FILE  
PRESS>EXIT
```

#### <Cause>

There are no Song Files on the floppy disk.

#### <Remedy>

Press **EXIT**, replace the disk with the one containing a file to be deleted, then try to delete once again.

```
NO USR PROG FILE  
PRESS>EXIT
```

#### <Cause>

There are no User Program Files on the floppy disk.

#### <Remedy>

Press **EXIT**, replace the disk with the one containing a User Program file to be deleted, then try to delete once again.

### Others

```
ARRANGERinactive  
during playback
```

#### <Cause>

You are trying to use Style Play during playback of SMF Music Data. Style Play is disabled while SMF Music Data is playing.

#### <Remedy>

Press **STOP** or **RESET** to stop playback, then once again to enable Style Play.

# Expansion Tone List

	PC#	Tone name		PC#	Tone name		PC#	Tone name		PC#	Tone name
a11	1	Piano 1	a51	33	Acoustic Bs.	b11	65	Soprano Sax	b51	97	Ice Rain
a12	2	Piano 2	a52	34	Fingered Bs.	b12	66	Alto Sax	b52	98	Soundtrack
a13	3	Piano 3	a53	35	Picked Bs.	b13	67	Tenor Sax	b53	99	Crystal
a14	4	Honky-tonk	a54	36	Fretless Bs.	b14	68	Baritone Sax	b54	100	Atmosphere
a15	5	E.Piano 1	a55	37	Slap Bass 1	b15	69	Oboe	b55	101	Brightness
a16	6	E.Piano 2	a56	38	Slap Bass 2	b16	70	English Horn	b56	102	Goblin
a17	7	Harpsichord	a57	39	Synth Bass 1	b17	71	Bassoon	b57	103	Echo Drops
a18	8	Clav.	a58	40	Synth Bass 2	b18	72	Clarinet	b58	104	Star Theme
a21	9	Celesta	a61	41	Violin	b21	73	Piccolo	b61	105	Sitar
a22	10	Glockenspiel	a62	42	Viola	b22	74	Flute	b62	106	Banjo
a23	11	Music Box	a63	43	Cello	b23	75	Recorder	b63	107	Shamisen
a24	12	Vibraphone	a64	44	Contrabass	b24	76	Pan Flute	b64	108	Koto
a25	13	Marimba	a65	45	Tremolo Str	b25	77	Bottle Blow	b65	109	Kalimba
a26	14	Xylophone	a66	46	PizzicatoStr	b26	78	Shakuhachi	b66	110	Bag Pipe
a27	15	Tubular-bell	a67	47	Harp	b27	79	Whistle	b67	111	Fiddle
a28	16	Santur	a68	48	Timpani	b28	80	Ocarina	b68	112	Shanai
a31	17	Organ 1	a71	49	Strings	b31	81	Square Wave	b71	113	Tinkle Bell
a32	18	Organ 2	a72	50	Slow Strings	b32	82	Saw Wave	b72	114	Agogo
a33	19	Organ 3	a73	51	Syn.Strings1	b33	83	Syn.Calliope	b73	115	Steel Drums
a34	20	Church Org.1	a74	52	Syn.Strings2	b34	84	Chiffer Lead	b74	116	Woodblock
a35	21	Reed Organ	a75	53	Choir Aahs	b35	85	Charang	b75	117	Taiko
a36	22	Accordion Fr	a76	54	Voice Oohs	b36	86	Solo Vox	b76	118	Melo. Tom 1
a37	23	Harmonica	a77	55	SynVox	b37	87	5th Saw Wave	b77	119	Synth Drum
a38	24	Bandneon	a78	56	OrchestraHit	b38	88	Bass & Lead	b78	120	Reverse Cym.
a41	25	Nylon-str.Gt	a81	57	Trumpet	b41	89	Fantasia	b81	121	Gt.FretNoise
a42	26	Steel-str.Gt	a82	58	Trombone	b42	90	Warm Pad	b82	122	Breath Noise
a43	27	Jazz Gt.	a83	59	Tuba	b43	91	Polysynth	b83	123	Seashore
a44	28	Clean Gt.	a84	60	MutedTrumpet	b44	92	Space Voice	b84	124	Bird
a45	29	Muted Gt.	a85	61	French Horn	b45	93	Bowed Glass	b85	125	Telephone 1
a46	30	Overdrive Gt	a86	62	Brass 1	b46	94	Metal Pad	b86	128	Helicopter
a47	31	DistortionGt	a87	63	Synth Brass1	b47	95	Halo Pad	b87	127	Applause
a48	32	Gt.Harmonics	a88	64	Synth Brass2	b48	96	Sweep Pad	b88	128	Gun Shot

PC # : Program Number

\* All the GS Bank Select numbers will be "0" (Capital Tones).

# GS TONE LIST

	PC #	CC0 #	Tone name	V	Recommended sound range	
Piano	1	0	Piano 1	1	A0 (21) — C8 (108)	
		8	Piano 1w	○ 2		
	2	0	Piano 2	1		
		8	Piano 2w	○ 2		
	3	0	Piano 3	1		
	4	0	Honky-tonk	2		
		8	Honky-tonk w	○ 2		
	5	0	E. Piano 1	1		E1 (28) — G7 (103)
		8	Detuned EP 1	2		
		16	E. Piano 1w	○ 2		
	6	0	E. Piano 2	1		E1 (28) — G7 (103)
		8	Detuned EP 2	2		
		16	E. Piano 2w	○ 1		
	7	0	Harpsichord	1		F2 (41) — F6 (89)
		8	Coupled Hps.	2		
		16	Harpsi. w	○ 1		
8	0	Clav.	1	C2 (36) — C7 (96)		
Chromatic Percussion	9	0	Celesta	1	C4 (60) — C8 (108)	
	10	0	Glockenspiel	1	C5 (72) — C8 (108)	
	11	0	Music Box	1	C4 (60) — C6 (84)	
	12	0	Vibraphone	1	F3 (53) — F6 (89)	
		8	Vib. w	○ 1		
	13	0	Marimba	1	C3 (48) — C6 (84)	
		8	Marimba w	○ 1		
	14	0	Xylophone	1	F4 (65) — C7 (96)	
	15	0	Tubular-bell	1	C4 (60) — F5 (77)	
		8	Church Bell	1		
16	0	Santur	1	C4 (60) — C6 (84)		
Organ	17	0	Organ 1	○ 1	C2 (36) — C7 (96)	
		8	Detuned Or. 1	2		
	18	0	Organ 2	○ 1		
		8	Detuned Or. 2	2		
	19	0	Organ 3	2		
	20	0	Church Org. 1	○ 1		A0 (21) — C8 (108)
		8	Church Org. 2	2		
	21	0	Reed Organ	1		C2 (36) — C7 (96)
	22	0	Accordion Fr	○ 2		F3 (53) — F6 (89)
		8	Accordion It	2		
23	0	Harmonica	1	C4 (60) — C6 (84)		
24	0	Bandneon	2	F3 (53) — F6 (89)		

	PC #	CC0 #	Tone name	V	Recommended sound range
Guitar	25	0	Nylon-str. Gt.	○ 1	E2 (40) — C6 (84)
		8	Ukulele	1	A3 (57) — B5 (83)
26	0	Steel-str. Gt.	1	E2 (40) — C6 (84)	
	8	12-str. Gt.	2		
	16	Mandolin	1		
27	0	Jazz Gt.	○ 1	E2 (40) — D6 (86)	
	8	Hawaiian Gt.	1		
28	0	Clean Gt.	1		
	8	Chorus Gt.	2		
29	0	Muted Gt.	1		
	8	Funk Gt.	1		
30	0	Overdrive Gt.	○ 1		
31	0	Distortion Gt.	1		
	8	Feedback Gt.	2		
32	0	Gt. Harmonics	1		
	8	Gt. Feedback	1		
Bass	33	0	Acoustic Bs.	○ 1	E1 (28) — G3 (55)
	34	0	Fingered Bs.	○ 1	
	35	0	Picked Bs.	○ 1	
	36	0	Fretless Bs.	○ 1	
	37	0	Slap Bass 1	○ 1	
	38	0	Slap Bass 2	○ 1	
	39	0	Synth Bass 1	○ 1	
		8	Synth Bass 3	1	
	40	0	Synth Bass 2	○ 2	
		8	Synth Bass 4	2	

PC # : Program number  
 CC0 # : Value of control number 0  
 (GS bank select number)  
 V : Number of voices

Recommended sound range : The recommended sound range does not indicate the limit of sound production. The actual playable range extends beyond the recommended sound range.

○ : Indicates Tones which can be selected using the panel buttons when Tone Selection is in the standard mode.

With Tone Selection set to the Tone Expansion Mode, the panel buttons can be used to select from a total of 128 Tones, with CC # 0 being 0 (Capital).

	PC #	CC0 #	Tone name	V	Recommended sound range
Strings/orchestral	41	0	Violin	1	G3 (55) — C7 (96)
		8	Slow Violin ○	1	E1 (28) — C7 (96)
	42	0	Viola	1	G3 (48) — C6 (84)
	43	0	Cello	1	C2 (36) — C5 (72)
	44	0	Contrabass	1	E1 (28) — G3 (55)
	45	0	Tremolo Str	1	E1 (28) — C7 (96)
	46	0	PizzicatoStr	1	
	47	0	Harp	1	B0 (23) — G7 (103)
	48	0	Timpani	1	C2 (36) — A3 (57)
Ensemble	49	0	Strings ○	1	E1 (28) — C7 (96)
		8	Orchestra	2	C1 (24) — C7 (96)
	50	0	Slow Strings ○	1	E1 (28) — C7 (96)
	51	0	Syn. Strings1	1	C2 (36) — C7 (96)
		8	Syn. Strings3	2	C1 (24) — C7 (96)
	52	0	Syn. Strings2	2	C2 (36) — C7 (96)
	53	0	Choir Aahs ○	1	C3 (48) — G5 (79)
	54	0	Voice Oohs ○	1	
	55	0	SynVox	1	C3 (48) — C6 (84)
56	0	OrchestraHit	2	C3 (48) — C5 (72)	
Brass	57	0	Trumpet ○	1	A # 3 (58) — A # 6 (94)
	58	0	Trombone	1	A # 1 (34) — D # 5 (75)
	59	0	Tuba	1	F1 (29) — G3 (55)
	60	0	MutedTrumpet ○	1	A # 3 (58) — A # 5 (82)
	61	0	French Horn	2	F2 (41) — F5 (77)
	62	0	Brass 1 ○	1	C2 (36) — C7 (96)
		8	Brass 2	2	
	63	0	Synth Brass1 ○	2	
		8	Synth Brass3	2	
64	0	Synth Brass2	2		
	8	Synth Brass4	1		

	PC #	CC0 #	Tone name	V	Recommended sound range	
Lead	65	0	Soprano Sax	1	F # 3 (54) — D # 6 (87)	
	66	0	Alto Sax ○	1	C # 3 (49) — G # 5 (80)	
	67	0	Tenor Sax	1	F # 2 (42) — D # 5 (75)	
	68	0	Baritone Sax	1	C # 2 (37) — G # 4 (68)	
	69	0	Oboe ○	1	A # 3 (58) — G6 (91)	
	70	0	English Horn	1	E3 (52) — A5 (81)	
	71	0	Bassoon	1	A # 1 (34) — C5 (72)	
	72	0	Clarinet ○	1	D3 (50) — G6 (91)	
	73	0	Piccolo	1	D5 (74) — C8 (108)	
	Pipe	74	0	Flute ○	1	C4 (60) — C7 (96)
		75	0	Recorder	1	
		76	0	Pan Flute	1	
77		0	Bottle Blow	2		
78		0	Shakuhachi	2		
79		0	Whistle	1		
80		0	Ocarina	1		
Synth lead		81	0	Square Wave	2	
	8		Sine Wave	1		
	82	0	Saw Wave ○	2		
	83	0	Syn. Calliope	2		
	84	0	Chiffer Lead	2		
	85	0	Charang	2		
	86	0	Solo Vox	2		
	87	0	5th Saw Wave	2		
Synth pad etc.	88	0	Bass & Lead	2		
	89	0	Fantasia ○	2		
	90	0	Warm Pad	1		
	91	0	Polysynth	2		
	92	0	Space Voice	1		
	93	0	Bowed Glass	2		
	94	0	Metal Pad	2		
	95	0	Halo Pad	2		
	96	0	Sweep Pad ○	1		

- PC # : Program number  
 CC0 # : Value of control number 0 (GS bank select number)  
 V : Number of voices  
 Recommended sound range : The recommended sound range does not indicate the limit of sound production. The actual playable range extends beyond the recommended sound range.  
 ○ : Indicates Tones which can be selected using the panel buttons when Tone Selection is in the standard mode.

With Tone Selection set to the Tone Expansion mode, the panel buttons can be used to select from a total of 128 Tones, with CC # 0 being 0 (Capital).



	PC #	CC0 #	Tone name	V
Synth SFX	97	0	Ice Rain	2
	98	0	Soundtrack	2
	99	0	Crystal	2
	100	0	Atmosphere	2
	101	0	Brightness	○ 2
	102	0	Goblin	2
	103	0	Echo Drops	1
	104	0	Star Theme	2
Ethnic	105	0	Sitar	1
	106	0	Banjo	1
	107	0	Shamisen	1
	108	0	Koto	1
		8	Taisho Koto	2
	109	0	Kalimba	1
	110	0	Bag Pipe	1
	111	0	Fiddle	1
112	0	Shanai	1	
Percussive	113	0	Tinkle Bell	1
	114	0	Agogo	1
	115	0	Steel Drums	1
	116	0	Woodblock	* 1
		8	Castanets	* 1
	117	0	Taiko	* 1
		8	Concert BD	* 1
	118	0	Melo Tom 1	* 1
		8	Melo Tom 2	* 1
	119	0	Synth Drum	* 1
8		808 Tom	* 1	
120	0	Reverse Cym.	* 2	

- PC # : Program number  
 CC0 # : Value of control number 0  
 (GS bank select number)  
 V : Number of voices  
 ○ : Indicates Tones which can be selected using  
 the panel buttons when Tone Selection is in  
 the standard mode.  
 \* : All Tones marked by an \* have an unreliable  
 pitch. Please use a key around C4 (Key # 60).  
 The unmarked Tones use temperament and  
 pitch of A4 (Key # 59) is 440Hz.

With Tone Selection set to the Tone Expansion mode,  
 the panel buttons can be used to select from a total of  
 128 Tones, with CC # 0 being 0 (Capital).

	PC #	CC0 #	Tone name	V
SFX	121	0	Gt. FretNoise	* 1
		1	Gt. Cut Noise	* 1
		2	String Slap	* 1
	122	0	Breath Noise	2
		1	Fl. Key Click	* 1
	123	0	Seashore	* 1
		1	Rain	* 2
		2	Thunder	* 1
		3	Wind	* 1
		4	Stream	* 2
	124	5	Bubble	* 2
		0	Bird	* 2
125	1	Dog	* 1	
	2	Horse-Gallop	* 1	
	0	Telephone 1	* 1	
	1	Telephone 2	* 1	
	2	Door Creaking	* 1	
126	3	Door	* 1	
	4	Scratch	* 1	
	5	Windchime	* 2	
	0	Helicopter	* 1	
	1	Car-Engine	* 1	
	2	Car-Stop	* 1	
	3	Car-Pass	* 1	
	4	Car-Crash	* 2	
	5	Siren	* 1	
6	Train	* 1		
127	7	Jetplane	* 2	
	8	Starship	* 2	
	9	Burst Noise	* 2	
	0	Applause	* 2	
	1	Laughing	* 1	
	2	Screaming	* 1	
	3	Punch	* 1	
	4	Heart Beat	* 1	
5	Footsteps	* 1		
128	0	Gun Shot	* 1	
	1	Machine Gun	* 1	
	2	Lasergun	* 1	
		3	Explosion	* 2

# DRUM SET LIST

Note number	PC#1:STANDARD Set PC#33:JAZZ Set	PC#9:ROOM Set	PC#17:POWER Set	PC#25: ELECTRONIC Set	PC#26:TR-808 Set	PC#41: BRUSH Set	PC#49:ORCHESTRA Set
27	High Q						Closed Hi-Hat [EXC1]
28	Slap						Pedal Hi-Hat [EXC1]
29	Scratch Push						Open Hi-Hat [EXC1]
30	Scratch Pull						Ride Cymbal
31	Sticks						
32	Square Click						
33	Metronome Click						
34	Metronome Bell						
35	Kick Drum 2						Concert BD 2
36	Kick Drum 1		MONDO Kick	Elec BD	808 Bass Drum		Concert BD 1
37	Side Stick				808 Rim Shot		
38	Snare Drum 1		Gated SD	Elec SD	808 Snare Drum	Brush Tap	Concert SD
39	Hand Clap					Brush Slap	Castanets
40	Snare Drum 2			Gated SD		Brush Swirl	Concert SD
41	Low Tom 2	Room Low Tom 2	Room Low Tom 2	Elec Low Tom 2	808 Low Tom 2		Timpani F
42	Closed Hi - hat [EXC1]				808 CHH [EXC1]		Timpani F#
43	Low Tom 1	Room Low Tom 1	Room Low Tom 1	Elec Low Tom 1	808 Low Tom 1		Timpani G
44	Pedal Hi - hat [EXC1]				808 CHH [EXC1]		Timpani G#
45	Mid Tom 2	Room Mid Tom 2	Room Mid Tom 2	Elec Mid Tom 2	808 Mid Tom 2		Timpani A
46	Open Hi - hat [EXC1]				808 OHH [EXC1]		Timpani A#
47	Mid Tom 1	Room Mid Tom 1	Room Mid Tom 1	Elec Mid Tom 1	808 Mid Tom 1		Timpani B
48	High Tom 2	Room Hi Tom 2	Room Hi Tom 2	Elec Hi Tom 2	808 Hi Tom 2		Timpani c
49	Crash Cymbal 1				808 Cymbal		Timpani c#
50	High Tom 1	Room Hi Tom 1	Room Hi Tom 1	Elec Hi Tom 1	808 Hi Tom 1		Timpani d
51	Ride Cymbal 1						Timpani d#
52	Chinese Cymbal			Reverse Cymbal ★			Timpani e
53	Ride Bell						Timpani f
54	Tambourine						
55	Splash Cymbal						
56	Cowbell				808 Cowbell		
57	Crash Cymbal 2						Concert Cymbal 2
58	Vibra -- slap						
59	Ride Cymbal 2						Concert Cymbal 1
60	High Bongo						
61	Low Bongo						
62	Mute High Conga				808 High Conga		
63	Open High Conga				808 Mid Conga		
64	Low Conga				808 Low Conga		
65	High Timbale						
66	Low Timbale						
67	High Agogo						
68	Low Agogo						
69	Cabasa						
70	Maracas				808 Maracas		
71	Short Hi Whistle [EXC2]						
72	Long Low Whistle [EXC2]						
73	Short Guiro [EXC3]						
74	Long Guiro [EXC3]						
75	Claves				808 Claves		
76	High Wood Block						
77	Low Wood Block						
78	Mute Cuica [EXC4]						
79	Open Cuica [EXC4]						
80	Mute Triangle [EXC5]						
81	Open Triangle [EXC5]						
82	Shaker						
83	Jingle Bell						
84	Belltree						
85	Castanets						
86	Mute Surdo [EXC6]						
87	Open Surdo [EXC6]						
88	-----						Applause ★

PC # : Program number

★ : Tones which are created by using two voices.  
(All other Tones are created by one voice.)

Blank : Same as the percussion sound of "STANDARD"

----- : No sound

[EXC] : Percussion sound of the same number will not be heard at the same time.

## Changing the Manual Drum Set

The KR-4500 provides a selection of 8 different Drum Sets which can be played from the keyboard. The available sets are shown at left (see page \*\*).

### Operation

From the Master Screen:

- ① Press **MANUAL DRUMS** and confirm that its indicator is lit. The screen in which operations related to the Manual Drum Set can be made will appear in the display.

```

MANUAL DRUM SET
Standard set
    
```

- ② From this screen, press **INC** or **DEC** to select the desired Drum Set.

#### Note :

You should try to make the selection in ② quickly enough so as not to be automatically returned to the Master Screen. However, if you should be returned to the Master Screen, simply start over again by pressing **MANUAL DRUMS** (twice) and getting its indicator to light again.

\*This completes the steps necessary for selection of a different Drum Set. You can now try out the percussive sounds of the new Drum Set by playing the keys while the indicator on **MANUAL DRUMS** is lit.

Each time power is turned on, the Standard Drum Set will automatically be selected.

## SFX set (Program number 57)

Note number	PC#57:SFX Set
39	High Q
40	Slap
	Scratch Push
41	Scratch Pull
42	Sticks
43	Square Click
44	Metronome Click
45	Metronome Bell
46	Guitar sliding finger
47	Guitar cutting noise (down)
48	Guitar cutting noise (up)
49	String slap of double bass
50	Fl. Key Click
51	Laughing
52	Screaming
53	Punch
54	Heart Beat
55	Footsteps1
56	Footsteps2
57	Applause ★
58	Door Creaking
59	Door
60	Scratch
61	Windchime ★
62	Car-Engine
63	Car-Stop
64	Car-Pass
65	Car-Crash ★
66	Siren
67	Train
68	Jetplane ★
69	Helicopter
70	Starship ★
71	Gun Shot
72	Machine Gun
73	Lasergun
74	Explosion ★
75	Dog
76	Horse-Gallop
77	Birds ★
78	Rain ★
79	Thunder
80	Wind
81	Seashore
82	Stream ★
83	Bubble ★
84	

★ : Tones which are created by using two voices.  
(All other Tones are created by one voice.)

# MUSIC STYLE LIST (EXPANSION MODE)

No.	Music Style	Beat	Preset Tempo	I	E	No.	Music Style	Beat	Preset Tempo	I	E
11	ROCK1	4/4	120	4	3	51	BOESA NOVA	4/4	120	4	5
12	ROCK2	4/4	118	2	3	52	SAMBA	4/4	110	4	4
13	RAP	4/4	110	4	2	53	LATIN	4/4	90	4	3
14	HOUSE	4/4	120	4	3	54	SALSA	4/4	120	2	3
15	DANCE	4/4	120	4	4	55	CHACHA	4/4	135	3	4
16	FUNK1	4/4	115	4	1	56	RHUMBA	4/4	120	2	4
17	FUNK2	4/4	96	4	3	57	MAMBO	4/4	110	4	3
18	FUSION	4/4	127	3	2	58	TANGO	4/4	120	2	2
21	8BEAT1	4/4	64	1	2	61	SLOW WALTZ	3/4	75	4	6
22	8BEAT2	4/4	60	1	4	62	WALTZ	3/4	180	2	4
23	8BEAT3	4/4	80	2	4	63	MARCH	4/4	115	4	2
24	8BEAT4	4/4	68	3	4	64	POLKA	4/4	120	2	2
25	16BEAT1	4/4	80	4	2	65	BAROQUE	4/4	140	2	3
26	16BEAT2	4/4	74	1	4	66	COUNTRY	4/4	130	2	2
27	16BEAT3	4/4	100	4	6	67	BEGUINE	4/4	104	1	6
28	16BEAT4	4/4	80	1	3	68	REGGAE	4/4	132	1	3
31	BOOGIE	4/4	162	2	2	71	PASODOBLE	4/4	132	3	2
32	ROCK'N'ROLL	4/4	170	2	5	72	KARS	4+5/8	120	4	2
33	TWIST	4/4	164	1	4	73	ANADOLU	4/4	108	2	3
34	CHARLESTON	4/4	212	4	4	74	ARAB	4/4	120	2	2
35	SLOW ROCK1	4/4	60	1	2	75	MALFOUF	4/4	120	2	1
36	SLOW ROCK2	4/4	64	2	2	76	KERONCONG	4/4	111	8	7
37	BALLAD1	4/4	120	1	3	77	TROT	4/4	120	4	2
38	BALLAD2	4/4	120	1	2	78	ENKA	4/4	72	4	5
41	SLOW SWING1	4/4	60	2	3	81	POP1	4/4	80	1	1
42	SLOW SWING2	4/4	108	1	6	82	POP2	4/4	120	4	5
43	SWING	4/4	135	4	2	83	POP3	4/4	80	4	4
44	FOXTROT	3/4	180	2	2	84	POP4	4/4	64	2	2
45	BIG BAND	4/4	140	2	3	85	POP5	4/4	64	1	2
46	SHUFFLE	4/4	160	4	3	86	POP6	4/4	120	4	2
47	SWING WALTZ	4/4	100	4	5	87	ROCK'N'ROLL2	4/4	160	4	2
48	DIXIELAND	4/4	162	4	4	88	SWING2	4/4	176	8	3

I : INTRO

E : ENDING

\* In the Normal Mode, any of the Music Styles tinted gray in this list can be selected.

POP 1—POP 6 are beautifully simple, and work very well as backing for piano pieces.

# User Program List

## User Program 1

<input type="radio"/> Upper Tone	A05 E.Piano 1
<input type="radio"/> Lower Tone	A13 Voice
<input type="radio"/> Manual Bass Tone	B12 Fretless Bas
<input type="radio"/> Upper Part Balance	100
<input type="radio"/> Lower Part Balance	70
<input type="radio"/> Accompaniment Part Balance	65
<input type="radio"/> Accompaniment Bass Part Balance	65
<input type="radio"/> Accompaniment Drums Part Balance	65
<input type="radio"/> Manual Bass Part Balance	65
<input type="radio"/> Manual Drums Part Balance	65
<input type="radio"/> Music Style	A10 8BEAT 2
<input type="radio"/> Tempo	64
<input type="radio"/> Variation	Off
<input type="radio"/> Arranger	(On/Off,Select) On,ADVANCED
<input type="radio"/> Keyboard Mode	SPLIT
<input type="radio"/> Lower	On
<input type="radio"/> Manual Bass	Off
<input type="radio"/> Split Point	<b>A b3</b>
<input type="radio"/> Chord Hold	On
<input type="radio"/> Chord Intelligence	Off
<input type="radio"/> Melody Intelligence	Off
<input type="radio"/> Reverb	(overall On/Off,Type) On,Hall 2
◇ Level for each Part	
Upper	63
Lower	63
Accompaniment	47
Accompaniment Bass	32
Accompaniment Drums	47
Manual Bass	32
Manual Drums	47
<input type="radio"/> Chorus(Type)	Chorus 2
◇ On/Off for each Part	
Upper	On
Lower	Off
Manual Bass	Off
<input type="radio"/> Octave Shift	
Upper	0
Lower	1
Manual Bass	0
<input type="radio"/> Transpose	C
<input type="radio"/> Center Pedal	DAMPER OF LOWER
<input type="radio"/> Left Pedal	LEADING BASS
<input type="radio"/> Manual Drums	(On/Off,Set) Off,Standard set
<input type="radio"/> Manual Sound Effects	Off
<input type="radio"/> Sync Start	On
<input type="radio"/> Sync Stop	Off
<input type="radio"/> Leading Bass	Off
<input type="radio"/> Intro	On
<input type="radio"/> Pitch Bend Range	
Upper	2
Lower	0
Manual Bass	0
<input type="radio"/> Repeat Note	
Rate	1/32
Mode	UP
<input type="radio"/> Keyboard Sensitivity	2

## User Program 2

<input type="radio"/> Upper Tone	B03 Trumpet
<input type="radio"/> Lower Tone	A01 Piano 1
<input type="radio"/> Manual Bass Tone	B09 Wood Bass
<input type="radio"/> Upper Part Balance	100
<input type="radio"/> Lower Part Balance	72
<input type="radio"/> Accompaniment Part Balance	65
<input type="radio"/> Accompaniment Bass Part Balance	65
<input type="radio"/> Accompaniment Drums Part Balance	65
<input type="radio"/> Manual Bass Part Balance	65
<input type="radio"/> Manual Drums Part Balance	65
<input type="radio"/> Music Style	B03 BIG BAND
<input type="radio"/> Tempo	150
<input type="radio"/> Variation	Off
<input type="radio"/> Arranger	(On/Off,Select) On,ADVANCED
<input type="radio"/> Keyboard Mode	SPLIT
<input type="radio"/> Lower	Off
<input type="radio"/> Manual Bass	Off
<input type="radio"/> Split Point	<b>A b3</b>
<input type="radio"/> Chord Hold	On
<input type="radio"/> Chord Intelligence	Off
<input type="radio"/> Melody Intelligence	Off
<input type="radio"/> Reverb	(overall On/Off,Type) On,Hall 2
◇ Level for each Part	
Upper	63
Lower	63
Accompaniment	47
Accompaniment Bass	32
Accompaniment Drums	47
Manual Bass	32
Manual Drums	47
<input type="radio"/> Chorus(Type)	Chorus 2
◇ On/Off for each Part	
Upper	Off
Lower	Off
Manual Bass	Off
<input type="radio"/> Octave Shift	
Upper	0
Lower	1
Manual Bass	0
<input type="radio"/> Transpose	C
<input type="radio"/> Center Pedal	SOSTENUTO
<input type="radio"/> Left Pedal	LEADING BASS
<input type="radio"/> Manual Drums	(On/Off,Set) Off,Standard set
<input type="radio"/> Manual Sound Effects	Off
<input type="radio"/> Sync Start	On
<input type="radio"/> Sync Stop	Off
<input type="radio"/> Leading Bass	Off
<input type="radio"/> Intro	On
<input type="radio"/> Pitch Bend Range	
Upper	2
Lower	0
Manual Bass	0
<input type="radio"/> Repeat Note	
Rate	1/32
Mode	UP
<input type="radio"/> Keyboard Sensitivity	2

## User Program 3

<input type="radio"/> Upper Tone	B10 E.Guitar 1
<input type="radio"/> Lower Tone	A12 Choir
<input type="radio"/> Manual Bass Tone	B09 Wood Bass
<input type="radio"/> Upper Part Balance	100
<input type="radio"/> Lower Part Balance	55
<input type="radio"/> Accompaniment Part Balance	65
<input type="radio"/> Accompaniment Bass Part Balance	65
<input type="radio"/> Accompaniment Drums Part Balance	65
<input type="radio"/> Manual Bass Part Balance	65
<input type="radio"/> Manual Drums Part Balance	65
<input type="radio"/> Music Style	B10 BOSSANOVA
<input type="radio"/> Tempo	120
<input type="radio"/> Variation	Off
<input type="radio"/> Arranger	
(On/Off,Select)	On,ADVANCED
<input type="radio"/> Keyboard Mode	SPLIT
<input type="radio"/> Lower	Off
<input type="radio"/> Manual Bass	Off
<input type="radio"/> Split Point	<b>A b3</b>
<input type="radio"/> Chord Hold	On
<input type="radio"/> Chord Intelligence	Off
<input type="radio"/> Melody Intelligence	Off
<input type="radio"/> Reverb	
(overall On/Off,Type)	On,Hall 2
◇ Level for each Part	
Upper	63
Lower	63
Accompaniment	47
Accompaniment Bass	32
Accompaniment Drums	47
Manual Bass	32
Manual Drums	47
<input type="radio"/> Chorus(Type)	Chorus 2
◇ On/Off for each Part	
Upper	Off
Lower	Off
Manual Bass	Off
<input type="radio"/> Octave Shift	
Upper	0
Lower	1
Manual Bass	0
<input type="radio"/> Transpose	C
<input type="radio"/> Center Pedal	DAMPER OF LOWER
<input type="radio"/> Left Pedal	LEADING BASS
<input type="radio"/> Manual Drums	
(On/Off,Set)	Off,Standard set
<input type="radio"/> Manual Sound Effects	Off
<input type="radio"/> Sync Start	On
<input type="radio"/> Sync Stop	Off
<input type="radio"/> Leading Bass	Off
<input type="radio"/> Intro	On
<input type="radio"/> Pitch Bend Range	
Upper	2
Lower	0
Manual Bass	0
<input type="radio"/> Repeat Note	
Rate	1/32
Mode	UP
<input type="radio"/> Keyboard Sensitivity	2

## User Program 4

<input type="radio"/> Upper Tone	B05 Sax
<input type="radio"/> Lower Tone	B14 Fantasia
<input type="radio"/> Manual Bass Tone	B12 Fretless Bas
<input type="radio"/> Upper Part Balance	100
<input type="radio"/> Lower Part Balance	72
<input type="radio"/> Accompaniment Part Balance	65
<input type="radio"/> Accompaniment Bass Part Balance	65
<input type="radio"/> Accompaniment Drums Part Balance	65
<input type="radio"/> Manual Bass Part Balance	65
<input type="radio"/> Manual Drums Part Balance	65
<input type="radio"/> Music Style	A05 DANCE
<input type="radio"/> Tempo	120
<input type="radio"/> Variation	On
<input type="radio"/> Arranger	
(On/Off,Select)	On,ADVANCED
<input type="radio"/> Keyboard Mode	SPLIT
<input type="radio"/> Lower	Off
<input type="radio"/> Manual Bass	Off
<input type="radio"/> Split Point	<b>A b3</b>
<input type="radio"/> Chord Hold	On
<input type="radio"/> Chord Intelligence	Off
<input type="radio"/> Melody Intelligence	Off
<input type="radio"/> Reverb	
(overall On/Off,Type)	On,Hall 1
◇ Level for each Part	
Upper	63
Lower	63
Accompaniment	47
Accompaniment Bass	32
Accompaniment Drums	47
Manual Bass	32
Manual Drums	47
<input type="radio"/> Chorus(Type)	Chorus 2
◇ On/Off for each Part	
Upper	Off
Lower	Off
Manual Bass	Off
<input type="radio"/> Octave Shift	
Upper	0
Lower	1
Manual Bass	0
<input type="radio"/> Transpose	C
<input type="radio"/> Center Pedal	DAMPER OF LOWER
<input type="radio"/> Left Pedal	LEADING BASS
<input type="radio"/> Manual Drums	
(On/Off,Set)	Off,Standard set
<input type="radio"/> Manual Sound Effects	Off
<input type="radio"/> Sync Start	On
<input type="radio"/> Sync Stop	Off
<input type="radio"/> Leading Bass	Off
<input type="radio"/> Intro	On
<input type="radio"/> Pitch Bend Range	
Upper	2
Lower	0
Manual Bass	0
<input type="radio"/> Repeat Note	
Rate	1/32
Mode	UP
<input type="radio"/> Keyboard Sensitivity	2

## User Program 5

<input type="radio"/> Upper Tone	A08 Marimba
<input type="radio"/> Lower Tone	B16 Brightness
<input type="radio"/> Manual Bass Tone	B09 Wood Bass
<input type="radio"/> Upper Part Balance	90
<input type="radio"/> Lower Part Balance	60
<input type="radio"/> Accompaniment Part Balance	65
<input type="radio"/> Accompaniment Bass Part Balance	65
<input type="radio"/> Accompaniment Drums Part Balance	75
<input type="radio"/> Manual Bass Part Balance	65
<input type="radio"/> Manual Drums Part Balance	75
<input type="radio"/> Music Style	67 BEGUINE
(Music Style Expansion Mode)	
<input type="radio"/> Tempo	104
<input type="radio"/> Variation	On
<input type="radio"/> Arranger (On/Off,Select)	On,ADVANCED
<input type="radio"/> Keyboard Mode	SPLIT+LAYER
<input type="radio"/> Lower	On
<input type="radio"/> Manual Bass	Off
<input type="radio"/> Split Point	<b>A b3</b>
<input type="radio"/> Chord Hold	On
<input type="radio"/> Chord Intelligence	Off
<input type="radio"/> Melody Intelligence	Off
<input type="radio"/> Reverb (overall On/Off,Type)	On,Hall 2
◇ Level for each Part	
Upper	63
Lower	63
Accompaniment	47
Accompaniment Bass	32
Accompaniment Drums	47
Manual Bass	32
Manual Drums	47
<input type="radio"/> Chorus(Type)	Chorus 2
◇ On/Off for each Part	
Upper	Off
Lower	Off
Manual Bass	Off
<input type="radio"/> Octave Shift	
Upper	0
Lower	1
Manual Bass	0
<input type="radio"/> Transpose	C
<input type="radio"/> Center Pedal	REPEAT NOTE ON
<input type="radio"/> Left Pedal	LEADING BASS
<input type="radio"/> Manual Drums (On/Off,Set)	Off,Standard set
<input type="radio"/> Manual Sound Effects	Off
<input type="radio"/> Sync Start	On
<input type="radio"/> Sync Stop	Off
<input type="radio"/> Leading Bass	Off
<input type="radio"/> Intro	On
<input type="radio"/> Pitch Bend Range	
Upper	2
Lower	0
Manual Bass	0
<input type="radio"/> Repeat Note	
Rate	1/32
Mode	UP
<input type="radio"/> Keyboard Sensitivity	2

Function ***		Transmitted	Recognized	Remarks
Basic Channel	Default Changed	1, 2, 3, 10 1 - 16, OFF	1, 2, 3, 4, 10 1 - 16, OFF	1 = Upper, 2 = Manual Bass, 3 = Lower, 4 = Rx Only 10 = Manual Drums
Mode	Default Messages Altered	× × *****	Mode 3 Mode 3, 4 (M = 1)	* 2
Note Number	True Voice	15 - 113 *****	0 - 127 0 - 127	
Velocity	Note ON Note OFF	○ ×	○ ×	
After Touch	Key's Ch's	× ×	× ×	
Pitch Bender		○	○	
Control Change	0/32 1 5 6,38 7 10 11 64 65 66 67 91 93 98,99 100, 101 120 121	○ × × × ○* 1 × × ○ × ○ ○ ○ ○ ○ ○ × × × ×	○ ○ ○ ○ ○* 1 ○ ○ ○ ○ ○ ○ ○ (Reverb) ○ (Chorus) ○ ○ ○ ○	Bank select Modulation Portamento time Data entry Volume Panpot Expression Hold 1 Portamento Sostenuto Soft Effect1 depth Effect3 depth NRPN LSB, MSB RPN LSB, MSB All sounds off Reset all controllers
Prog Change	True #	0 - 127 *****	○ 0 - 127	
System Exclusive		×	×	
System Common	Song Pos Song Sel Tune	× × ×	× × ×	
System Real Time	Clock Commands	× ×	× ×	
Aux Messages	Local ON/OFF All Notes OFF Active Sense Reset	○ × ○ ×	○ ○ (123 - 125) ○ ×	
Notes	* 1 ○ × can be selectable. * 2 Recognize as M = 1 even if M ≠ 1.			

Mode 1 : OMNI ON, POLY  
Mode 3 : OMNI OFF, POLY

Mode 2 : OMNI ON, MONO  
Mode 4 : OMNI OFF, MONO

○ : Yes  
× : No



Function ...		Transmitted	Recognized	Remarks
Basic Channel	Default Changed	16, 5, 6, 7, 8, 11 1 - 16, OFF	16, 5, 6, 7, 8, 11 1 - 16, OFF	16 = Chord Recognition, 5 = Accomp. 1, 6 = Accomp. 2, 7 = Accomp. 3, 8 = Accomp. Bass 11 = Accomp. Drums
Mode	Default Messages Altered	× × *****	Mode 3 Mode 3, 4 (M = 1)	* 2
Note Number	True Voice	15 - 113 *****	0 - 127 0 - 127	
Velocity	Note ON Note OFF	○ ×	○ ×	
After Touch	Key's Ch's	× ×	× ×	
Pitch Bender		×	○	
Control Change	0/32	×	○	Bank select Modulation Portamento time Data entry Volume Panpot Expression Hold 1 Portamento Sostenuto Soft Effect1 depth Effect3 depth NRPN LSB, MSB RPN LSB, MSB All sounds off Reset all controllers
	1	×	○	
	5	×	○	
	6,38	×	○	
	7	○* 1	○* 1	
	10	×	○	
	11	×	○	
	64	×	○	
	65	×	○	
	66	×	○	
	67	×	○	
	91	○	○ (Reverb)	
	93	×	○ (Chorus)	
	98,99	×	○	
100, 101	×	○		
120	×	○		
121	×	○		
Prog Change	True #	0 - 127 *****	○ 0 - 127	
System Exclusive		×	×	
System Common	Song Pos	×	×	
	Song Sel	×	×	
	Tune	×	×	
System Real Time	Clock	○	○	
	Commands	○	○	
Aux Messages	Local ON/OFF	×	×	
	All Notes OFF	×	○ (123 - 125)	
	Active Sense	×	○	
	Reset	×	×	
Notes		* 1 ○ × can be selectable. * 2 Recognize as M = 1 even if M ≠ 1.  All Channel messages are transmitted when Arranger MIDI Out Switch is ON.		

Mode 1 : OMNI ON, POLY  
Mode 3 : OMNI OFF, POLY

Mode 2 : OMNI ON, MONO  
Mode 4 : OMNI OFF, MONO

○ : Yes  
× : No



Function ...		Transmitted	Recognized	Remarks
Basic Channel	Default	×	1 - 16	
	Changed	×	1 - 16	
Mode	Default	×	Mode 3	* 2
	Messages	×	Mode 3, 4 (M = 1)	
	Altered	*****		
Note Number	True Voice	×	0 - 127	
		*****	0 - 127	
Velocity	Note ON	×	○	
	Note OFF	×	×	
After Touch	Key's	×	* 1	
	Ch's	×	* 1	
Pitch Bender		×	* 1	
Control Change	0/32	×	* 3 (MSB only)	Bank select
	1	×	* 1	Modulation
	5	×	* 3	Portamento time
	6,38	×	* 3	Data entry
	7	×	* 1	Volume
	10	×	* 1	Panpot
	11	×	* 1	Expression
	64	×	* 1	Hold 1
	65	×	* 1	Portamento
	66	×	* 1	Sostenuto
	67	×	* 1	Soft
	91	×	* 3 (reverb)	Effect1 depth
	93	×	* 3 (chorus)	Effect3 depth
	98,99	×	* 1	NRPN LSB, MSB
100, 101	×	* 1	RPN LSB, MSB	
120	×	○	All sounds off	
121	×	○	Reset all controllers	
Prog Change	True #	×	* 1	
		*****	0 - 127	
System Exclusive		×	○	
System Common	Song Pos	×	×	
	Song Sel	×	×	
	Tune	×	×	
System Real Time	Clock	×	×	
	Commands	×	×	
Aux Messages	Local ON/OFF	×	×	
	All Notes OFF	×	○ (123 - 125)	
	Active Sense	○	○	
	Reset	×	×	
Notes		* 1 ○ × can be selectable. * 2 Recognize as M = 1 even if M ≠ 1. * 3 ○ × can be selectable, only using the receive switch of control change (all).		

Mode 1 : OMNI ON, POLY  
Mode 3 : OMNI OFF, POLY

Mode 2 : OMNI ON, MONO  
Mode 4 : OMNI OFF, MONO

○ : Yes  
× : No

## KR-4500 Intelligent Piano (GS Format sound source)

### ● Keyboard

88 keys (Rotary, Oil-Damped Mechanism)

### ● Parts

Upper 1/2, Lower, Accompaniment 1/2/3, Accompaniment Bass,  
Accompaniment Drums, Manual Bass, Manual Drums/Manual Sound  
Effects

### ● Maximum Polyphony

28 voices

### ● Tones

40 (Tone Expansion Mode:128)

### ● Effects

Reverb, Chorus

### ● User Programs

5

### ● Music Styles

32 (Music Style Expansion Mode:64)

Optional Music Style Cards can provide numerous more.

### ● Composer

Tracks :6  
Songs :5  
Note Storage :approx. 40,000 notes  
Tempo : ♩ =30 to 240  
Resolution :120 clock/quarter note  
Recording Method :Realtime

### \*Standard MIDI File

Format 0/1; playback only

### ● Storage Media: 3.5 inch Micro Floppy Disk

Disk Format :720Kbytes (2DD), 1.44Mbytes (2HD)  
Songs :56 (720Kbytes), 99 (1.44Kbytes)  
Note Storage : approx. 80,000 notes (720Kbytes)  
approx. 160,000 notes (1.44Mbytes)

### ● Disk Drive

3.5 inch Micro Floppy Disk Drive (2DD/2HD)

### ● Display

16 characters, 2 lines (backlit LCD)

### ● Connectors

Output Jacks (L( MONO) / R)  
Input Jacks (L( MONO) / R)  
Headphone Jack (Stereo)  
Expression Pedal Jack  
MIDI Connectors (In, Out, Thru)  
Pedal Connector (8 pin DIN type)

### ● Speakers

20cm × 2

5cm × 2

### ● Rated Power Output

30W × 2

### ● Power Supply

AC117V, AC230V or AC240V

### ● Power Consumption

90W(AC117V), 90W(AC230V), 90W(AC240V)

### ● Finish

Brazilian Rose Wood

### ● Dimensions

KR-4500	:1421(W) × 524(D) × 219(H)mm
	:56(W) × 20 - 5/8(D) × 8 - 5/8(H) inches (including MR Holder and Rubber Foot)
Piano Stand (KRS-4500)	:1421(W) × 454(D) × 638(H) mm
	:56(W) × 17 - 7/8(D) × 25 - 1/8(H) inches
Total	:1421(W) × 524(D) × 847(H) mm
	:56(W) × 20 - 5/8(D) × 33 - 5/16(H) inches

### ● Weight

KR-4500	:54.5kg / 120 lbs
Piano Stand (KRS-4500)	:17.2kg / 37 lbs 15 oz
Total	:71.7kg / 157 lbs 15 oz

### ● Accessories

Quick Start  
Owner's Manual  
Music Stand  
Power Cord  
MF-2HD  
Demo Song Disk  
Manual Drums Sticker  
SMF Template

### ● Options

Music Style Card :MSL-15, TN-SC Series

\*The specifications and/or appearance of this product  
are subject to change without prior notice.

<b>A</b>		<b>F</b>	
A Group(Tone Select) .....	18	Factory Setup .....	70
Advanced .....	35	Fade-In .....	30
Arrangement Level .....	35	Fade-Out .....	32
Arranger .....	25	Fast-Forward .....	82
Arranger Button .....	35	Fill-In .....	36
Arranger ON/OFF .....	34	Fill-In to Original .....	36
Arranger Track .....	74	Fill-In to Variation .....	36
As a Rhythm Machine .....	29	Format .....	76,115
Auto Punch-In Recording .....	97	Function .....	44
Automatic Accompaniment(in the Style) .....	29		
<b>B</b>		<b>G</b>	
B Group(Tone Select) .....	18	Group A(Music Style Select) .....	27
Balance Buttons .....	57	Group B(Music Style Select) .....	27
Balance Section .....	57	GS Mode .....	56
Basic .....	35	GS Reset .....	56,138
Basic Tempo .....	111		
Bass Group .....	18	<b>I</b>	
Beat Indicator .....	34	Insert(Copy Mode) .....	104
Block Repeat .....	113	Insert(Insert Measure) .....	102
Break Button .....	37	Internal Memory .....	72
		Intro .....	24
<b>C</b>		Inverted Chord .....	21,40
Card Slot .....	28		
Center Pedal .....	49	<b>J</b>	
Chord Detection .....	25	Jump .....	109
Chord Hold .....	37		
Chord Intelligence .....	38	<b>K</b>	
Chord Name .....	20	Keyboard Mode .....	12
Chords .....	19	Keyboard Mode Section .....	12
Chorus Effect .....	63	Keyboard Sensitivity .....	53
Chorus Section .....	63		
Chorus Type .....	64	<b>L</b>	
Composer .....	72	Layer(Layer Mode) .....	12
Composer Function Mode .....	110	LCD Contrast .....	54
Copy .....	103	Leading Bass .....	39
Copy Mode .....	104	Left Pedal .....	49
Count-In .....	112	Load .....	73,86,91
		Lower .....	13
<b>D</b>		Lower Tone .....	17
Damper of Lower Tone .....	49	Lower Track .....	74
Delete .....	105		
Delete File .....	116	<b>M</b>	
Disk Capacity .....	77	Manual Bass .....	14
Disk Function Mode .....	115	Manual Bass Tone .....	17
		Manual Bass Track .....	74
<b>E</b>		Manual Drums and Manual Sound Effects Track .....	74
Ending .....	24	Mark Point .....	106
Erase .....	100	Master Tune .....	44
Expansion Tones List .....	152	Melody Intelligence .....	41
		Merge(Copy Mode) .....	104
		Metronome Level .....	55
		MIDI .....	125
		Mix Recording .....	95

Mode(Repeat Note).....	52
Multi-Track Recording.....	75
Music Style Expansion Mode.....	67
Music Style List.....	27
Music Style Select Buttons.....	26
Music Styles.....	24
Music Styles Card.....	28
Muting.....	58

## O

Octave Shift.....	46
One-Touch Program.....	21
Original.....	24,35
Overwriting.....	87,90,92,118

## P

Pedal Punch-In Recording.....	96
Pedal Switches.....	48
Piano Mode.....	22
Piano Style Arranger Mode.....	22
Pitch Bend Range.....	50
Playback Tempo.....	82
Preset Tempo.....	32
Punch-In.....	93
Punch-Out.....	93

## Q

Quantize.....	98
Quantize Resolution.....	99

## R

Rate(Repeat Note).....	52
Repeat Note.....	52
Repeat Playback.....	83
Replace Recording.....	94
Replace(Copy Mode).....	104
Reverb Level.....	62
Reverb Section.....	61
Reverb Type.....	61
Reverbration.....	60
Rewind.....	81
Root.....	19
Root Position Chord.....	21,40

## S

Save.....	73,85,89
Song.....	74
Song File.....	116
Song Name.....	83,110
Song Number.....	87
Song Position.....	108,109
Split + Layer(Split + Layer Mode).....	15
Split Arranger Mode.....	22
Split Point.....	13
Split(Split Mode).....	13
Start.....	29
Stop.....	30
Style Play.....	25

## T

Tap Tempo Button.....	33
Tapping Tempo.....	33
Tempo Slider.....	32
Time Signature.....	111
Tone Expansion Mode.....	65
Tone Group.....	16,17
Tone List.....	18
Tone Select Buttons.....	16
Tone Select Section.....	16
Total Recorded Notes.....	80
Track Mute.....	82
Track Select Buttons.....	79
Tracks.....	73
Transpose.....	45
Tuning.....	44

## U

Upper.....	13
Upper 1 Track.....	74
Upper 2 Track.....	74
Upper Tone.....	16
User Program.....	68
User Program Buttons.....	69
User Program File.....	117
User Program Name.....	118
User Program Number.....	69
Utility.....	44

## V

Variation.....	24,35
Variation Button.....	35

## W

Whole(Whole Mode).....	12
Write Protect Tab.....	77
2HD/2DD.....	73

When you need repair service, call your local Roland Service Station or the authorized Roland distributor in your country as shown below.

#### U. S. A.

Roland Corporation US  
7200 Dominion Circle  
Los Angeles, CA.  
90040-3647, U. S. A.  
☎ (213)685 - 5141

#### CANADA

Roland Canada Music Ltd.  
(Head Office)  
5480 Parkwood  
Richmond B. C., V6V 2M4  
CANADA  
☎ (604)270 - 6626

Roland Canada Music Ltd.  
9425 Transcanadienne  
Service Rd. N., St Laurent,  
Quebec H4S 1V3,  
CANADA  
☎ (514)335 - 2009

Roland Canada Music Ltd.  
346 Watline Avenue,  
Mississauga, Ontario L4Z  
1X2, CANADA  
☎ (416)890 - 6488

#### AUSTRALIA

Roland Corporation  
(Australia) Pty. Ltd.  
(Head Office)  
38 Campbell Avenue  
Dee Why West. NSW 2099  
AUSTRALIA  
☎ (02)982 - 8266

Roland Corporation  
(Australia) Pty. Ltd.  
(Melbourne Office)  
50 Garden Street  
South Yarra, Victoria 3141  
AUSTRALIA  
☎ (03)241 - 1254

#### UNITED KINGDOM

Roland(U.K.) Ltd.  
Rye Close  
Ancells Business Park  
Fleet, Hampshire GU13  
8UY, UNITED KINGDOM  
☎ 0252 - 816181

Roland(U.K.) Ltd.,  
Swansea Office  
Atlantic Close, Swansea  
Enterprise Park, Swansea,  
West Glamorgan SA79FJ.  
UNITED KINGDOM  
☎ (0792)700 - 139

#### ITALY

Roland Italy S. p. A.  
Viale delle Industrie 8  
20020 ARESE MILANO  
ITALY  
☎ 02 - 93581311

#### SPAIN

Roland Electronics  
de España, S. A.  
Calle Bolivia 239  
08020 Barcelona, SPAIN  
☎ 93 - 308 - 1000

#### GERMANY

Roland Elektronische  
Musikinstrumente  
Handelsgesellschaft mbH.  
Oststrasse 96, 2000  
Norderstedt, GERMANY  
☎ 040/52 60 090

#### FRANCE

Musikengro  
102 Avenue Jean-Jaures  
69007 Lyon Cedex 07  
FRANCE  
☎ (7)858 - 54 60

Musikengro (Paris Office)  
Centre Region Parisienne  
41 rue Charles-Fourier,  
94400 Vitry s/Seine  
FRANCE  
☎ (1)4680 86 62

#### BELGIUM/ HOLLAND/ LUXEMBOURG

Roland Benelux N. V.  
Houtstraat 1  
B-2260 Oevel-Westerlo  
BELGIUM  
☎ (0032)14 - 575811

#### DENMARK

Roland Scandinavia A/S  
Langebrogade 6  
Box 1937  
DK-1023 Copenhagen K.  
DENMARK  
☎ 31 - 95 31 11

#### SWEDEN

Roland Scandinavia A/S  
DanvikCenter 28 A, 2 tr.  
S-131 30 Nacka  
SWEDEN  
☎ 08 - 702 00 20

#### NORWAY

Roland Scandinavia  
Avd. Norge  
Lilleakerveien 2  
Postboks 95 Lilleaker  
N-0216 Oslo 2  
NORWAY  
☎ 02 - 73 00 74

#### FINLAND

Fazer Musik Inc.  
Länsituulentie  
POB 169  
SF-02101 Espoo  
FINLAND  
☎ 0 - 43 50 11

#### NEW ZEALAND

Roland Corporation  
(NZ) Ltd.  
97 Mt. Eden Road, Mt.  
Eden, Auckland 3,  
NEW ZEALAND  
☎ (09)3098 - 715

#### SWITZERLAND

Musitronic AG  
Gerberstrasse 5, CH-4410  
Liestal, SWITZERLAND  
☎ 061/921 16 15

Roland CK (Switzerland)  
AG  
Postfach/Hauptstrasse 21  
CH-4456 Tenniken  
SWITZERLAND  
☎ 061/98 60 55  
Repair Service by  
Musitronic AG

#### AUSTRIA

E. Dematte & Co.  
Neu-Rum Siemens-  
Strasse 4  
A-6021 Innsbruck Box 591  
AUSTRIA  
☎ (0512)63 451

#### GREECE

V. Dimitriadis & Co. Ltd.  
2 Phidiou Str., GR 106 78  
Athens, GREECE  
☎ 1 - 3620130

#### PORTUGAL

Casa Caius Instrumentos  
Musicais Lda.  
Rua de Santa Catarina 131  
Porto, PORTUGAL  
☎ 02 - 38 44 56

#### HUNGARY

Intermusica Ltd.  
Warehouse Area 'DEPO'  
Torokbalint, Budapest  
HUNGARY  
☎ (1)1868905

#### ISRAEL

D.J.A. International Ltd.  
25 Pinsker St., Tel Aviv  
ISRAEL  
☎ 972 - 3 - 5283015

#### CYPRUS

Radex Sound Equipment  
Ltd.  
17 Panteli Katelari Str.  
P.O.Box 2046, Nicosia  
CYPRUS  
☎ 453426, 466423

#### TURKEY

Barkat Sanayi ve Ticaret  
Siraselviler Cad. 86/6  
Taksim Istanbul, TURKEY  
☎ 149 93 24

#### EGYPT

Al Fanny Trading Office  
9, Ebn Hagar Askalany  
Street, Ard El Golf,  
Heliopolis, Cairo, EGYPT  
☎ 2917803 - 665918

#### BRAZIL

Roland Brasil Ltda.  
R. Alvarenga 591  
CEP-05509 Sao Paulo  
BRAZIL  
☎ (011)813 - 7967  
Repair Service for Roland  
and Rhodes products

Oliver do Brasil S.A.  
Instrumentos Musicais  
Av. Ceci. No.578 Centro  
Empresarial Tambore  
Barueri SP CEP 06400  
BRAZIL  
☎ (011)709 - 1267  
Repair Service for BOSS  
products

#### MEXICO

Case Veerkamp, s.a. de c.v.  
Mesones No. 21  
Col. Centro  
C.P. 06080 Mexico, D.F.  
MEXICO  
☎ (5)709 - 3716

La Casa Wagner de  
Guadalajara s.a. de c.v.  
Av. Corona No. 202 S.J.  
C.P.44100  
Guadalajara, Jalisco  
MEXICO  
☎ (36)13 - 1414

#### ARGENTINA

Netto S.A.  
Venezuela 1433  
1095 Buenos Aires  
ARGENTINA  
☎ 37 - 1632

#### HONG KONG

Tom Lee Music Co., Ltd.  
Service Division  
22-32 Pun Shan Street,  
Tsuen Wan, New  
Territories, HONG KONG  
☎ 415 - 0911

#### KOREA

Cosmos Corporation  
Service Station  
261 2nd Floor Nak-Won  
arcade  
Jong-Ro ku, Seoul, KOREA  
☎ (02) 742 8844

#### SINGAPORE

Swee Lee Company  
Bras Basah Complex  
#03-23 Singapore 0178  
SINGAPORE  
☎ 3367886

#### THAILAND

Theera Music Co., Ltd.  
330 Verng Nakorn Kasem,  
Soi 2, Bangkok 10100,  
THAILAND  
☎ 2248821

#### MALAYSIA

Syarikat Bentley  
No.142, Jalan Bukit  
Bintang 55100 Kuala  
Lumpur, MALAYSIA  
☎ 2421288

#### INDONESIA

PT Galestra Inti  
Kompleks Perkantoran  
Duta Merlin Blok C/59  
Jl. Gajah mada No.3-5  
Jakarta 10130  
INDONESIA  
☎ (021) 354604, 354606

#### TAIWAN

Siruba Enterprise(Taiwan)  
Co., LTD.  
Room. 5, 9fl. No. 112  
Chung Shan N.Road Sec.2  
Taipei, TAIWAN, R.O.C.  
☎ (02)5364546

#### SOUTH AFRICA

That Other Music  
Shop(PTY) LTD.  
256 Bree Street,  
Johannesburg 2001  
Republic of South Africa  
☎ 337 - 6573

Paul Bothner(PTY) LTD.  
17 Werdmuller Centre  
Claremont 7700  
Republic of South Africa  
☎ 021 - 64 - 4030





# Some Notes on Editing the Arranger Track (P.98-109)

The Arranger Track is not like other tracks: instead of being a complete data record of a performance (as played by the Arranger), it contains only data about what chords were played and when to switch Music Styles. Because of this, things work a little differently when you go to edit the Arranger Track, so the following are a few things you should keep in mind when editing. And by all means, make a backup of your song before editing the Arranger Track: just in case things don't turn out the way you intended, you can easily start all over again with the original song.

## a. Indicating the Measure Number

Chord changes and Style changes are actually carried out just before the actual point in the performance where the chord or Music Style is supposed to change. This means that any changes taking place in the first beat of a bar were actually specified by data in the previous measure. Obviously this will be important when you go to indicate the range of measures to be edited, so remember: if you want to edit a chord or Style change in the first beat of a bar, include the measure just before that bar in the edit range.

The diagram shows two staves. The top staff, labeled 'Style Play (Actual music heard)', shows a sequence of chords: C, Amin, F, Gsus4, and G. The bottom staff, labeled 'Chord data in the Arranger Track', shows the corresponding chord data points. Vertical arrows point upwards from the bottom staff to the top staff, indicating the timing of the chord changes, which occur at the beginning of each measure.

## b. Copying

Example : Copying Measures 1-4 to Measures 5-8.

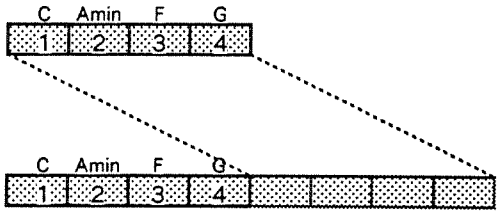

Indicated like this :

```
EDIT4 COPY
FROM 1 FOR 4
```

```
EDIT4 COPY
TO END TIME 1
```

The chord progression will now look like this :

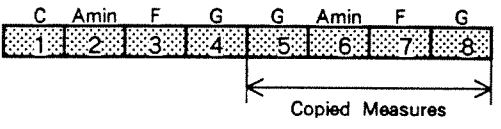

Notice that the "G" chord from Measure 4 continues to play throughout Measure 5, because the chord data for Measure 1 did not get copied (the chord change data itself occurred just before the start of Measure 1). So just before the start of Measure 5, use Mix Recording to input a "C" chord.

### c.Erase and Insert Measure

Performing an Erase or Insert Measure operation in the Arranger Track does not mean that there will be blank measures there, i.e., measures where Style Play is interrupted. Instead, Style Play will continue throughout the Erase or Insert Measure range, playing whatever Style it was told to play before the start of that range.

Example : When measures 5-7 have been erased.

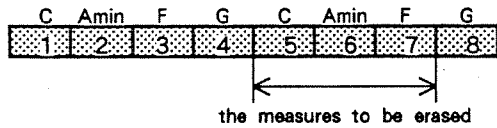

Indicate like this :

```
EDIT2 ERASE
FROM 4 FOR 3
```



specify the previous measure

```
EDIT2 ERASE
EVENT = ALL
```



specify "ALL"

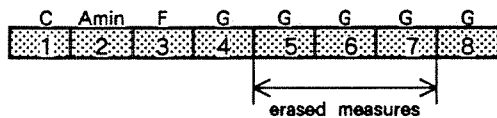

\*If you do want blank measures during Style Play, use Mix Recording to record a Break Mute on multiple tracks.

In specifying what to Erase, things work a little differently on the Arranger Track when compared to the other Tracks. Arranger Track Erase events include:

- ALL .....erase all events
- EXC.NOTE...erase events other than chord changes (i.e., changes of Music Styles)
- DAMPER ...same
- BENDER ...same

Example : When 3 empty measures have been inserted at the fifth measure.

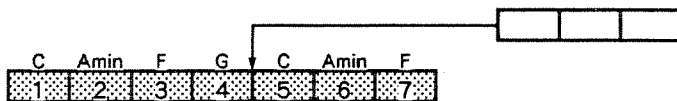

Indicate like this :

```
EDIT3 INSERT
FROM 4 FOR 3
```



specify the previous measure

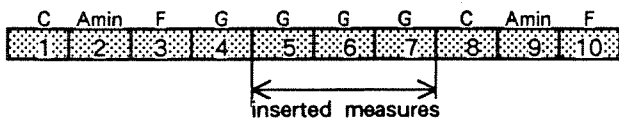

\*If you want blank measures during Style Play, use Mix Recording to record a Break Mute on multiple tracks.

# CORRECTIONS

The following correctinos should bring the OWNER'S MANUAL and QUICK START up-to-date.

## OWNER'S MANUAL P.51:

Add the following sentence in the lower left.

If you change the Pitch Bend Range value for the Lower part in the Layer, Split+Layer mode,the value will automatically return to the previous setting when changing the Keyboard into Whole/Split mode.

## OWNER'S MANUAL P.114:

Add the following sentence at the bottom.

### f. MIDI Update On/Off

The MIDI Update feature makes it simple to autmatically obtain at the time of playback the exact program changes, effects and all after settings that were recorded within the song. (It is ordinarily set at ON.)

With MIDI Update at "ON", you should be aware that a greater amount of time will be required to process the update if your song is somewhat longer than average. You may find it more convenient to turn OFF the updating feature if you are doing a lot of fast forwarding and reversing, such as when you are in the process of editing a piece, and would prefer to keep going without spending time waiting for the updates. (When OFF, the data will of course not be updated though.)

### Operation

From the Master Screen:

- ① Press the **FUNCTION** button in the Composer section.
- ② Select the Function Menu screen using the **INC** and **DEC** buttons.

```
FUNCTION
[6] MIDI UPDATE
```

- ③ Press **ENTER**.

```
FUNC6 MIDI UD
      OFF
```

- ④ Use the **INC** and **DEC** buttons to switch between MIDI Update ON and OFF.
- ⑤ Press **ENTER** to register the settings.

MIDI UPDATE ON is the default setting. (selected when the unit is turn on.)

When this is done, you'll be returned to the Function screen. From there, you'll be returned to the Master screen if you don't do anything further.

## OWNER'S MANUAL P.151:

Add following sentence at the bottom.

```
DISK ERROR!
PRESS>EXIT
```

### << Cause >>

The data on the floppy disk has somehow been corrupted or destroyed.

### << Remedy >>

Press **EXIT**, then format the disk or replace the proper disk.

## OWNER'S MANUAL P.115:

Lines 1 to 2 from the bottom.

### (error)

Once the disk has been formatted successfully, you'll be returned to the Disk Function display. If you don't do anything from that screen for a few seconds, you'll be returned to Master screen.

### (correct)

Once the disk has been formatted successfully, you'll be returned to the Master screen.

## OWNER'S MANUAL P.117:

Lines 1 to 2 from the bottom.

### (error)

Once the deletion has been completed, you'll be returned to the Disk Function screen. From here, if you don't do anything else for amoment or two, you'll to be returned to the Master screen.

### (correct)

Once the deletion has been completed, you'll be returned to the Master screen.

## OWNER'S MANUAL P.164:

MIDI Implementation Chart

### (error)

Function...	Transmitted
Song Pos	○
Common Song Sel	○
Tune	×

### (correct)

Function...	Transmitted
Song Pos	×
Common Song Sel	×
Tune	×



For Germany

## Bescheinigung des Herstellers/Importeurs

Hiermit wird bescheinigt, daß der/die/das

**Roland DIGITAL INTELIGENT PIANO KR-4500**

(Gerät. Typ. Bezeichnung)

in Übereinstimmung mit den Bestimmungen der

**Amtsbl. Vfg 1046/1984**

(Amtsblattverfügung)

funk-entstört ist.

Der Deutschen Bundespost wurde das Inverkehrbringen dieses Gerätes angezeigt und die Berechtigung zur Überprüfung der Serie auf Einhaltung der Bestimmungen eingeräumt.

**Roland Corporation Osaka/Japan**

Name des Herstellers/Importeurs

For the USA

## RADIO AND TELEVISION INTERFERENCE

**WARNING** — This equipment has been verified to comply with the limits for a Class B computing device, pursuant to Subpart J, of Part 15, of FCC rules. Operation with non-certified or non-verified equipment is likely to result in interference to radio and TV reception.

The equipment described in this manual generates and uses radio frequency energy. If it is not installed and used properly, that is, in strict accordance with our instructions, it may cause interference with radio and television reception. This equipment has been tested and found to comply with the limits for a Class B computing device in accordance with the specifications in Subpart J, of Part 15, of FCC Rules. These rules are designed to provide reasonable protection against such an interference in a residential installation. However, there is no guarantee that the interference will not occur in a particular installation. If this equipment does cause interference to radio or television reception, which can be determined by turning the equipment on and off, the user is encouraged to try to correct the interference by the following measure:

- Disconnect other devices and their input/output cables one at a time. If the interference stops, it is caused by either the other device or its I/O cable. These devices usually require Roland designated shielded I/O cables. For Roland devices, you can obtain the proper shielded cable from your dealer. For non Roland devices, contact the manufacturer or dealer for assistance.
- If your equipment does cause interference to radio or television reception, you can try to correct the interference by using one or more of the following measures.
  - Turn the TV or radio antenna until the interference stops.
  - Move the equipment to one side or the other of the TV or radio.
  - Move the equipment farther away from the TV or radio.
  - Plug the equipment into an outlet that is on a different circuit than the TV or radio. (That is, make certain the equipment and the radio or television set are on circuits controlled by different circuit breakers or fuses.)
  - Consider installing a rooftop television antenna with coaxial cable lead-in between the antenna and TV. If necessary, you should consult your dealer or an experienced radio/television technician for additional suggestions. You may find helpful the following booklet prepared by the Federal Communications Commission: "How to Identify and Resolve Radio — TV Interference Problems"

This booklet is available from the U.S. Government Printing Office, Washington, D.C., 20402, Stock No. 004-000-00345-4.

For Canada

### CLASS B

### NOTICE

This digital apparatus does not exceed the Class B limits for radio noise emissions set out in the Radio Interference Regulations of the Canadian Department of Communications.

### CLASSE B

### AVIS

Cet appareil numérique ne dépasse pas les limites de la classe B au niveau des émissions de bruits radioélectriques fixés dans le Règlement des signaux parasites par le ministère canadien des Communications.

