

Roland®



KR117/115

DIGITAL INTELLIGENT PIANO

Owner's Manual

Before using this unit, carefully read the sections entitled: "IMPORTANT SAFETY INSTRUCTIONS," "USING THE UNIT SAFELY" (p. 4, 5), and "IMPORTANT NOTES" (p. 6, 7). These sections provide important information concerning the proper operation of the unit. Additionally, in order to feel assured that you have gained a good grasp of every feature provided by your new unit, Owner's Manual should be read in its entirety. The manual should be saved and kept on hand as a convenient reference

WARNING: To reduce the risk of fire or electric shock, do not expose this apparatus to rain or moisture.

  
ATTENTION: RISQUE DE CHOC ELECTRIQUE NE PAS OUVRIR
CAUTION: TO REDUCE THE RISK OF ELECTRIC SHOCK, DO NOT REMOVE COVER (OR BACK). NO USER-SERVICEABLE PARTS INSIDE. REFER SERVICING TO QUALIFIED SERVICE PERSONNEL.



The lightning flash with arrowhead symbol, within an equilateral triangle, is intended to alert the user to the presence of uninsulated "dangerous voltage" within the product's enclosure that may be of sufficient magnitude to constitute a risk of electric shock to persons.



The exclamation point within an equilateral triangle is intended to alert the user to the presence of important operating and maintenance (servicing) instructions in the literature accompanying the product.

INSTRUCTIONS PERTAINING TO A RISK OF FIRE, ELECTRIC SHOCK, OR INJURY TO PERSONS.

IMPORTANT SAFETY INSTRUCTIONS SAVE THESE INSTRUCTIONS

WARNING - When using electric products, basic precautions should always be followed, including the following:

1. Read these instructions.
2. Keep these instructions.
3. Heed all warnings.
4. Follow all instructions.
5. Do not use this apparatus near water.
6. Clean only with a dry cloth.
7. Do not block any of the ventilation openings. Install in accordance with the manufacturers instructions.
8. Do not install near any heat sources such as radiators, heat registers, stoves, or other apparatus (including amplifiers) that produce heat.
9. Do not defeat the safety purpose of the polarized or grounding-type plug. A polarized plug has two blades with one wider than the other. A grounding type plug has two blades and a third grounding prong. The wide blade or the third prong are provided for your safety. If the provided plug does not fit into your outlet, consult an electrician for replacement of the obsolete outlet.
10. Protect the power cord from being walked on or pinched particularly at plugs, convenience receptacles, and the point where they exit from the apparatus.
11. Only use attachments/accessories specified by the manufacturer.
12. Unplug this apparatus during lightning storms or when unused for long periods of time.
13. Refer all servicing to qualified service personnel. Servicing is required when the apparatus has been damaged in any way, such as power-supply cord or plug is damaged, liquid has been spilled or objects have fallen into the apparatus, the apparatus has been exposed to rain or moisture, does not operate normally, or has been dropped.

For the U.K.

WARNING: THIS APPARATUS MUST BE EARTHED

IMPORTANT: THE WIRES IN THIS MAINS LEAD ARE COLOURED IN ACCORDANCE WITH THE FOLLOWING CODE.
GREEN-AND-YELLOW: EARTH, BLUE: NEUTRAL, BROWN: LIVE

As the colours of the wires in the mains lead of this apparatus may not correspond with the coloured markings identifying the terminals in your plug, proceed as follows:

The wire which is coloured GREEN-AND-YELLOW must be connected to the terminal in the plug which is marked by the letter E or by the safety earth symbol (⊕) or coloured GREEN or GREEN-AND-YELLOW.

The wire which is coloured BLUE must be connected to the terminal which is marked with the letter N or coloured BLACK.

The wire which is coloured BROWN must be connected to the terminal which is marked with the letter L or coloured RED.

Copyright © 2005 ROLAND CORPORATION

All rights reserved. No part of this publication may be reproduced in any form without the written permission of ROLAND CORPORATION.

USING THE UNIT SAFELY

INSTRUCTIONS FOR THE PREVENTION OF FIRE, ELECTRIC SHOCK, OR INJURY TO PERSONS

About ⚠ WARNING and ⚠ CAUTION Notices

⚠ WARNING	Used for instructions intended to alert the user to the risk of death or severe injury should the unit be used improperly.
⚠ CAUTION	Used for instructions intended to alert the user to the risk of injury or material damage should the unit be used improperly. * Material damage refers to damage or other adverse effects caused with respect to the home and all its furnishings, as well to domestic animals or pets.

About the Symbols

	The ⚠ symbol alerts the user to important instructions or warnings. The specific meaning of the symbol is determined by the design contained within the triangle. In the case of the symbol at left, it is used for general cautions, warnings, or alerts to danger.
	The ⓧ symbol alerts the user to items that must never be carried out (are forbidden). The specific thing that must not be done is indicated by the design contained within the circle. In the case of the symbol at left, it means that the unit must never be disassembled.
	The ⚡ symbol alerts the user to things that must be carried out. The specific thing that must be done is indicated by the design contained within the circle. In the case of the symbol at left, it means that the power-cord plug must be unplugged from the outlet.

ALWAYS OBSERVE THE FOLLOWING







⚠ WARNING

- Before using this unit, make sure to read the instructions below, and the Owner's Manual.
- Connect mains plug of this model to a mains socket outlet with a protective earthing connection.
- Do not open or perform any internal modifications on the unit.
- Do not attempt to repair the unit, or replace parts within it (except when this manual provides specific instructions directing you to do so). Refer all servicing to your retailer, the nearest Roland Service Center, or an authorized Roland distributor, as listed on the "Information" page.
- Never use or store the unit in places that are:
 - Subject to temperature extremes (e.g., direct sunlight in an enclosed vehicle, near a heating duct, on top of heat-generating equipment); or are
 - Damp (e.g., baths, washrooms, on wet floors); or are
 - Humid; or are
 - Exposed to rain; or are
 - Dusty; or are
 - Subject to high levels of vibration.
- Make sure you always have the unit placed so it is level and sure to remain stable. Never place it on stands that could wobble, or on inclined surfaces.
- The unit should be connected to a power supply only of the type described in the operating instructions, or as marked on the bottom of unit.







⚠ WARNING

- Use only the attached power-supply cord. Also, the supplied power cord must not be used with any other device.
- Do not excessively twist or bend the power cord, nor place heavy objects on it. Doing so can damage the cord, producing severed elements and short circuits. Damaged cords are fire and shock hazards!
- This unit, either alone or in combination with an amplifier and headphones or speakers, may be capable of producing sound levels that could cause permanent hearing loss. Do not operate for a long period of time at a high volume level, or at a level that is uncomfortable. If you experience any hearing loss or ringing in the ears, you should immediately stop using the unit, and consult an audiologist.
- Do not allow any objects (e.g., flammable material, coins, pins); or liquids of any kind (water, soft drinks, etc.) to penetrate the unit.
- Immediately turn the power off, remove the power cord from the outlet, and request servicing by your retailer, the nearest Roland Service Center, or an authorized Roland distributor, as listed on the "Information" page when:
 - The power-supply cord, or the plug has been damaged; or
 - If smoke or unusual odor occurs
 - Objects have fallen into, or liquid has been spilled onto the unit; or
 - The unit has been exposed to rain (or otherwise has become wet); or
 - The unit does not appear to operate normally or exhibits a marked change in performance.
- In households with small children, an adult should provide supervision until the child is capable of following all the rules essential for the safe operation of the unit.











⚠ WARNING

- Protect the unit from strong impact. (Do not drop it!) 
- Do not force the unit's power-supply cord to share an outlet with an unreasonable number of other devices. Be especially careful when using extension cords—the total power used by all devices you have connected to the extension cord's outlet must never exceed the power rating (watts/amperes) for the extension cord. Excessive loads can cause the insulation on the cord to heat up and eventually melt through. 
- Before using the unit in a foreign country, consult with your retailer, the nearest Roland Service Center, or an authorized Roland distributor, as listed on the "Information" page. 
- Batteries must never be recharged, heated, taken apart, or thrown into fire or water.  
- DO NOT play a CD-ROM disc on a conventional audio CD player. The resulting sound may be of a level that could cause permanent hearing loss. Damage to speakers or other system components may result. 
- Do not put anything that contains water (e.g., flower vases) on this unit. Also, avoid the use of insecticides, perfumes, alcohol, nail polish, spray cans, etc., near the unit. Swiftly wipe away any liquid that spills on the unit using a dry, soft cloth. 

⚠ CAUTION

- The unit should be located so that its location or position does not interfere with its proper ventilation. 
- Always grasp only the plug on the power-supply cord when plugging into, or unplugging from, an outlet or this unit. 
- At regular intervals, you should unplug the power plug and clean it by using a dry cloth to wipe all dust and other accumulations away from its prongs. Also, disconnect the power plug from the power outlet whenever the unit is to remain unused for an extended period of time. Any accumulation of dust between the power plug and the power outlet can result in poor insulation and lead to fire. 
- Try to prevent cords and cables from becoming entangled. Also, all cords and cables should be placed so they are out of the reach of children. 
- If the unit could become a hazard if it moves, all caster wheels should be locked or fixed in place once the unit has been placed at the place of installation, or has been loaded onto a vehicle. 
- Never climb on top of, nor place heavy objects on the unit. 

⚠ CAUTION

- Never handle the power cord or its plugs with wet hands when plugging into, or unplugging from, an outlet or this unit. 
- Before moving the unit, disconnect the power plug from the outlet, and pull out all cords from external devices. 
- Before cleaning the unit, turn off the power and unplug the power cord from the outlet (p. 21). 
- Whenever you suspect the possibility of lightning in your area, pull the plug on the power cord out of the outlet. 
- If used improperly, batteries may explode or leak and cause damage or injury. In the interest of safety, please read and observe the following precautions. 
 - Carefully follow the installation instructions for batteries, and make sure you observe the correct polarity. 
 - Avoid using new batteries together with used ones. In addition, avoid mixing different types of batteries. 
 - Remove the batteries whenever the unit is to remain unused for an extended period of time.
 - If a battery has leaked, use a soft piece of cloth or paper towel to wipe all remnants of the discharge from the battery compartment. Then install new batteries. To avoid inflammation of the skin, make sure that none of the battery discharge gets onto your hands or skin. Exercise the utmost caution so that none of the discharge gets near your eyes. Immediately rinse the affected area with running water if any of the discharge has entered the eyes.
 - Never keep batteries together with metallic objects such as ballpoint pens, necklaces, hairpins, etc.
- Used batteries must be disposed of in compliance with whatever regulations for their safe disposal that may be observed in the region in which you live. 
- Be careful when opening/closing the lid so you do not get your fingers pinched (p. 20). Adult supervision is recommended whenever small children use the unit. 
- Always keep the following parts including with the KR and small components that may be removed out of the reach of small children to avoid accidental ingestion of these parts. 

Included Parts

- Piano leg washers
- Bolts, washers, and springs used in attaching the pedals
- Cord clamps used for securing pedal cords, other cord clamps (using double-sided tape), and cord clamp attachment screws
- Pedal stay securing screws

Removable parts

- USB memory anti-theft lock (iron plate), Anti-theft lock securing screw

IMPORTANT NOTES

In addition to the items listed under “IMPORTANT SAFETY INSTRUCTIONS” and “USING THE UNIT SAFELY” on pages 3 and 4, please read and observe the following:

Power Supply

- Do not connect this unit to same electrical outlet that is being used by an electrical appliance that is controlled by an inverter (such as a refrigerator, washing machine, microwave oven, or air conditioner), or that contains a motor. Depending on the way in which the electrical appliance is used, power supply noise may cause this unit to malfunction or may produce audible noise. If it is not practical to use a separate electrical outlet, connect a power supply noise filter between this unit and the electrical outlet.
- Before connecting this unit to other devices, turn off the power to all units. This will help prevent malfunctions and/or damage to speakers or other devices.
- Although the LCD and LEDs are switched off when the POWER switch is switched off, this does not mean that the unit has been completely disconnected from the source of power. If you need to turn off the power completely, first turn off the POWER switch, then unplug the power cord from the power outlet. For this reason, the outlet into which you choose to connect the power cord's plug should be one that is within easy reach and readily accessible.
- Batteries are supplied with the unit. The life of these batteries may be limited, however, since their primary purpose was to enable testing.

Placement

- Using the unit near power amplifiers (or other equipment containing large power transformers) may induce hum. To alleviate the problem, change the orientation of this unit; or move it farther away from the source of interference.
- This device may interfere with radio and television reception. Do not use this device in the vicinity of such receivers.
- Noise may be produced if wireless communications devices, such as cell phones, are operated in the vicinity of this unit. Such noise could occur when receiving or initiating a call, or while conversing. Should you experience such problems, you should relocate such wireless devices so they are at a greater distance from this unit, or switch them off.
- Do not expose the unit to direct sunlight, place it near devices that radiate heat, leave it inside an enclosed vehicle, or otherwise subject it to temperature extremes. Also, do not allow lighting devices that normally are used while their light source is very close to the unit (such as a piano light), or powerful spotlights to shine upon the same area of the unit for extended periods of time. Excessive heat can deform or discolor the unit.
- When moved from one location to another where the temperature and/or humidity is very different, water droplets (condensation) may form inside the unit. Damage or malfunction may result if you attempt to use the unit in this condition. Therefore, before using the unit, you must allow it to stand for several hours, until the condensation has completely evaporated.
- Do not allow rubber, vinyl, or similar materials to remain on the unit for long periods of time. Such objects can discolor or otherwise harmfully affect the finish.
- Do not allow objects to remain on top of the keyboard. This can be the cause of malfunction, such as keys ceasing to produce sound.
- Do not paste stickers, decals, or the like to this instrument. Peeling such matter off the instrument may damage the exterior finish.

Maintenance

- Since your piano has a polished finish that is as delicate as that found on finely crafted wooden furniture, it needs careful, periodic care. A few important suggestions concerning the proper care of the unit follow.
 - For dusting, using a soft, clean cloth and/or piano-use feather duster. Be sure to wipe gently. Even the tiniest grains of sand or grit can leave scratches on the surface if too much force is applied while wiping.
 - Do not use any cleaners or detergents, since they might deteriorate the surface of the cabinet, and produce cracks.
 - If the cabinet's surface loses its luster, wipe it thoroughly with a soft cloth dampened with a little of the polishing liquid. Do not use any cleaners or detergents, since they might deteriorate the surface of the cabinet, and produce cracks. Do not use dusting cloths that contain chemicals.
- Never use benzine, thinners, alcohol or solvents of any kind, to avoid the possibility of discoloration and/or deformation.
- The pedals of this unit are made of brass. Brass eventually darkens as the result of the natural oxidization process. If the brass becomes tarnished, polish it using commercially available metal polisher.

Repairs and Data

- Please be aware that all data contained in the unit's memory may be lost when the unit is sent for repairs. Important data should always be backed up on an external memory, or written down on paper (when possible). During repairs, due care is taken to avoid the loss of data. However, in certain cases (such as when circuitry related to memory itself is out of order), we regret that it may not be possible to restore the data, and Roland assumes no liability concerning such loss of data.

Additional Precautions

- Please be aware that the contents of memory can be irretrievably lost as a result of a malfunction, or the improper operation of the unit. To protect yourself against the risk of losing important data, we recommend that you periodically save a backup copy of important data you have stored in the unit's memory on an external memory.
- Unfortunately, it may be impossible to restore the contents of data that was stored on an external memory once it has been lost. Roland Corporation assumes no liability concerning such loss of data.
- Use a reasonable amount of care when using the unit's buttons, sliders, or other controls; and when using its jacks and connectors. Rough handling can lead to malfunctions.
- Never strike or apply strong pressure to the display.
- When connecting / disconnecting all cables, grasp the connector itself—never pull on the cable. This way you will avoid causing shorts, or damage to the cable's internal elements.
- A small amount of heat will radiate from the unit during normal operation.

- To avoid disturbing your neighbors, try to keep the unit's volume at reasonable levels. You may prefer to use headphones, so you do not need to be concerned about those around you (especially when it is late at night).
- When you need to transport the unit, pack it in shock-absorbent material. Transporting the unit without doing so can cause it to become scratched or damaged, and could lead to malfunction.
- Do not apply undue force to the music rest while it is in use.
- Use only the specified expression pedal (EV-7/5; sold separately). By connecting any other expression pedals, you risk causing malfunction and/or damage to the unit.
- Use a cable from Roland to make the connection. If using some other make of connection cable, please note the following precautions.
 - Some connection cables contain resistors. Do not use cables that incorporate resistors for connecting to this unit. The use of such cables can cause the sound level to be extremely low, or impossible to hear. For information on cable specifications, contact the manufacturer of the cable.
- Before opening or closing the keyboard lid, always make sure that no pets or other small animals are located on top of the instrument (in particular, they should be kept away from the keyboard and its lid). Otherwise, due to the structural design of this instrument, small pets or other animals could end up getting trapped inside it. If such a situation is encountered, you must immediately switch off the power and disconnect the power cord from the outlet. You should then consult with the retailer from whom the instrument was purchased, or contact the nearest Roland Service Center.

Handling Floppy Disks (Using Optional Floppy Disk Drive)

- Floppy disks contain a plastic disk with a thin coating of magnetic storage medium. Microscopic precision is required to enable storage of large amounts of data on such a small surface area. To preserve their integrity, please observe the following when handling floppy disks:
 - Never touch the magnetic medium inside the disk.
 - Do not use or store floppy disks in dirty or dusty areas.
 - Do not subject floppy disks to temperature extremes (e.g., direct sunlight in an enclosed vehicle). Recommended temperature range: 10 to 50°C (50 to 122°F).
 - Do not expose floppy disks to strong magnetic fields, such as those generated by loudspeakers.
- Floppy disks have a "write protect" tab which can protect the disk from accidental erasure. It is recommended that the tab be kept in the PROTECT position, and moved to the WRITE position only when you wish to write new data onto the disk.

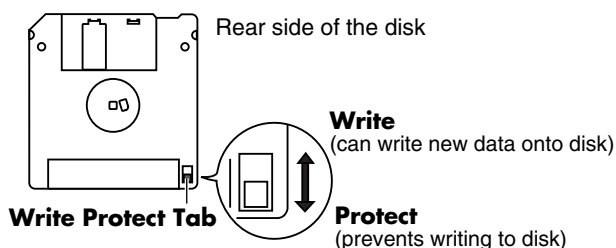

- The identification label should be firmly affixed to the disk. Should the label come loose while the disk is in the drive, it may be difficult to remove the disk.
- Store all disks in a safe place to avoid damaging them, and to protect them from dust, dirt, and other hazards. By using a dirty or dust-ridden disk, you risk damaging the disk, as well as causing the disk drive to malfunction.

- Disks containing performance data for this unit should always be locked (have their write protect tab slid to the "Protect" position) before you insert them into the drive on some other unit (except the PR-300, or a product in the HP-G, HPi, MT, KR, or Atelier families), or into a computer's drive. Otherwise (if the write protect tab remains in the "Write" position), when you perform any disk operations using the other device's disk drive (such as checking the contents of the disk, or loading data), you risk rendering the disk unreadable by this unit's disk drive.



Before Using External Memory

Using External Memory

- Never touch the terminals of the External memory. Also, avoid getting the terminals dirty.
- External memories are constructed using precision components; handle the cards carefully, paying particular note to the following.
 - To prevent damage to the cards from static electricity, be sure to discharge any static electricity from your own body before handling the external memories.
 - Do not touch or allow metal to come into contact with the contact portion of the external memories.
 - Do not bend, drop, or subject cards to strong shock or vibration.
 - Do not keep cards in direct sunlight, in closed vehicles, or other such locations (storage temperature: 0 to 50° C).
 - Do not allow cards to become wet.
 - Do not disassemble or modify the external memories.
- When connecting external memory, make sure to press it until it is fully inserted.
- Insert the external memory in the External Memory port evenly and without undue force. Forcing the external memory may damage the External Memory port.
- Do not insert any object other than the external memory (e.g., wires, coins, other types of disks, etc.) in the External Memory port. This may damage the External Memory port.
- Do not subject the External Memory port cover or connected External memory to excessive stress.
- Close the external memory cover when using the External memory for extended periods

Handling CD-ROMs

- Avoid touching or scratching the shiny underside (encoded surface) of the disc. Damaged or dirty CD-ROM discs may not be read properly. Keep your discs clean using a commercially available CD cleaner.

- * GS () is a registered trademark of Roland Corporation.
- * XG lite () is a registered trademark of Yamaha Corporation.
- * Mac OS is a trademark of Apple Computer, Inc.
- * Microsoft and Windows are registered trademarks of Microsoft Corporation.
- * This device in part makes use of Independent JPEG Group software.
- * All product names mentioned in this document are trademarks or registered trademarks of their respective owners.

Introduction

Thank you, and congratulations on your choice of the Roland KR Intelligent Piano.

While the KR Intelligent Piano certainly allows you to achieve authentic piano performances, it also features easy-to-use Automatic Accompaniment and numerous other useful functions. In order to enjoy reliable performance of your new keyboard for many years to come, please take the time to read through this manual in its entirety.

Main Features

○ Roland Digital Grand Brings Refinement to Interior Style

The KR's grand piano cabinet exhibits elegance in form with a beautiful black, mirror-like surface. With features just like those found on an acoustic grand, such as a top that opens and closes and folding retractable keyboard lid (KR117M), this instrument is a perfect match for lounge or living room. The KR117M lid also features hands-free closure for enhanced safety.

○ Lusciously Resounding, Richly Expressive Piano Sound

The KR reproduces the rich tones of a high-quality grand piano, from the sounds of the hammers as they strike the strings to the sounds made as the keys are released. 128-voice polyphony ensures full responsiveness, even with heavy use of the pedals.

What's more, The "Piano Designer" feature allows you to create your own favorite piano tones.

○ True Grand Piano Feel

The KR features Roland's Progressive Hammer Action keyboard, which reproduces the feel of a grand piano, with a firm, weighty touch in the lower registers and a lighter response in the upper registers. This keyboard also faithfully reproduces the distinctive "click" that's produced when a grand piano's keys are played (Escapement function).

In addition to the ability of adjusting the key weight, a "Hammer Response" function, which reproduces the subtle action of the hammers, is also incorporated, so there are two key-touch controls that come into play when determining the precise character of the keyboard. Additionally, the instrument's pedals are firm and responsive, lending your performances fuller and more detailed expressiveness.

○ Accomplish Tasks Easily with the Main Buttons

Almost all of the KR's common functions, including playing back songs, displaying notations, running the automatic accompaniment, selecting tones, and so on can be accomplished using the Main buttons to the left of the screen.

○ Full Complement of Player Piano Functions

You can also use the CD drive to play back a wide variety of music on the CD included with the instrument as well as songs on CD-ROMs containing saved SMF files, player piano CDs, and audio CDs. Moreover, you can add song data by copying songs saved on USB memory and CDs to the KR's "Favorites."

The KR117M and KR115M includes a "Moving Keys" function that plays the keys along with the song, providing exquisite performances that are played automatically.

Also included is a convenient remote control, which you can use for selecting songs, adjusting volume balances, switching the Moving Keys function on and off, and even for switching the images that appear in external displays--simply and easily. You can connect an external display or television set to the piano for enlarged displays of the Song Select screen, lyrics screen, slide shows, and notations.

○ Easy-To-Use “Music Assistant” Automatic Accompaniment Feature

You can select from an amazing 500 settings to get automatic accompaniment that perfectly matches the song you are playing.

Each song’s Music Assistant settings are shown in a manner that is easy to grasp, so playing along with the changes in the accompaniment is a snap.

For easy enjoyment of Music Assistant, the KR also includes songs that you can perform while reading the chord charts.

○ Utilizes External Memory—the New Media

You can save song data created on the KR to External memory (sold separately). Extremely portable, high-capacity external memory also connects easily to computers, allowing song data to be transferred easily. Taking further advantage of the high-capacity memory, you can also play back audio files with the KR.

○ Connect External Speakers to Produce Concert Hall Presence

You can connect an amp and speakers to the KR and play the sounds of the reverb and accompaniment through the external speakers to produce the effect of being enveloped by an orchestra.

The KR is equipped with XLR connectors, a very convenient feature when the instrument is used on stage.

How To Use This Manual

The KR Owner’s Manual consists of three volumes, **Quick Start**, **Owner’s Manual**, and the **USB Install Guide**.

Please start out by reading “Before You Start Playing” (p. 18) in the **Owner’s Manual** (this volume). This explains how to connect the KR’s power cord and how to turn on the instrument’s power.

After turning on the KR’s power, please continue by reading **Quick Start**.

By trying out the various procedures while reading the **Quick Start**, you can easily learn how to play the KR and make use of its major functions (especially procedures that involve use of the “main buttons”).

The **Owner’s Manual** describes procedures, from basic operation to procedures for special applications (for example, using the KR as an accompanist and creating songs), that will help you master the KR’s many performance functions.

When connecting a computer to the USB port, be sure to read the **USB Install Guide**. This describes the procedure for installing the driver needed to connect via USB.

- * For more on system requirements, refer to the “USB Installation Guide.” However, note that the KR is not compatible with Mac OS 9.

■ Conventions Used in This Manual

This manual uses the following conventions in the interest of simpler, more concise instructions.

- Button names are enclosed in square brackets “[]”, as in One Touch Program [Piano] button.
- For easier readability, some screens and colors used here may differ in part from actual screens and colors.
- On screen text is enclosed in angled brackets “< >”, as in <Exit>.
- The act of lightly contacting the Touch Screen with your finger is called “touching.”
- An asterisk (*) or a **NOTE** at the beginning of a paragraph indicates a note or precaution. These should not be ignored.
- (p. **) refers to pages within the manual.

Contents

USING THE UNIT SAFELY.....	4
IMPORTANT NOTES.....	6
Introduction	8
Main Features.....	8
How To Use This Manual	9
Conventions Used in This Manual.....	9
Panel Descriptions.....	14
Performance Pads	14
Record/Playback	15
Jack Panel (Left Side of Bottom Panel)	16
Right Side of Bottom Panel	17
Before You Start Playing	18
Opening and Closing the Top (KR117)	18
Opening and Closing the Top (KR115)	19
Raising the Music Rest.....	19
Using the Music Holders (KR115).....	20
Installing Batteries in the Remote Control.....	20
Opening and Closing the Lid	20
Connecting the Power Cord.....	21
Connect the Pedal Cable.....	21
Turning the Power On and Off	21
About the Pedals.....	22
Adjusting the Sound's Volume and Brilliance	22
Connecting Headphones.....	23
Connecting a Microphone.....	23
Connecting an External Display.....	24
Making the Connections.....	24
About the Touch Screen	25
Adjusting the Contrast of the Screen	25
Main Screens	25
Piano Screen.....	25
Basic Screen.....	25
Using the Main Icons.....	26
The [Option] Button and The [Exit] Button	26
The Scroll Bar and The Page Icon.....	26
Chapter 1 Performance.....	27
Playing the Keyboard Like a Piano (One-Touch Piano)	27
Performing with a Variety of Tones (Tone Buttons).....	28
Playing Percussion Instruments or Sound Effects	29
Using Keywords to Search for Tones (Tone Search)	30
Performing with Multiple Sounds Layered Together (Layer)	31
Playing Different Tones with the Left and Right Hands (Split).....	32
Shifting the Keyboard Pitch in Octave Steps (Octave Shift)	33
Adding Reverberation to the Sound (Reverb).....	34
Adding the Surround Sound Effect to the Accompaniment Using External Speakers (Surround)	36
Giving More Breadth to the Accompaniment Sound	36
Selecting the Part for the Effect.....	37
Selecting the Tone to Which the Effect is Applied.....	37
Changing the Amount of Surround Effect.....	38
Using the Internal Speakers to Add Three- Dimensional Spatiality to the Accompaniment Sounds (Advanced 3D).....	39
Selecting the Part for the Effect.....	40
Selecting the tone to which the effect is applied	41
Making Detailed Settings for Advanced 3D	42
Adding Liveliness to the Sound (Dynamic Emphasis).....	43
Adjusting the Sound to Achieve the Preferred Tone Quality (Equalizer)	44
Applying Effects to the Sound (Effects)	46
Adding Effects to Mic Vocals (Vocal Effect).....	47
Enjoying Karaoke Performances with Music Files	53
Using the Metronome	54
Using the Metronome.....	54
Changing the Metronome Settings.....	55
Chapter 2 Automatic Accompaniment	57
Music Styles and Automatic Accompaniment.....	57
Performing Using Automatic Accompaniment (One-Touch Arranger)	58
About Chords	59
Playing Chords with Simple Fingering (Chord Intelligence).....	59
Viewing Chord Fingerings (Chord Finder).....	60
Selecting Music Styles (Music Style Buttons)	61
Using Keywords to Search for Music Styles (Style Search)	62
Selecting Music Styles on External Memories.....	63
Playing Only Music Style Rhythm Patterns	64

Adjusting the Accompaniment Tempo64

Starting and Stopping the Accompaniment65

 Having the Accompaniment Start Simultaneously When You Play the Keyboard (Sync Start)65

 Stopping Automatic Accompaniment66

 Having a Count Sound Play at the End of the Intro (Countdown)67

Modifying an Accompaniment68

 Changing the Accompaniment Pattern (Fill In Buttons).....68

 Changing Accompaniment Patterns in the Screen.....69

 Changing the Instrumental Makeup of Music Styles (Style Orchestrator)69

Adding Harmony to the Right-Hand Part (Melody Intelligence)70

Playing Sounds in the Left Hand During a Performance (Lower Tone)71

Playing the Piano with Accompaniment Added (Piano Style Arranger)72

Adjusting the Volume Balance for Each Part (Balance).....73

 Changing the Volume Balance Between the Accompaniment and the Keyboard (Balance Knob)73

 Adjusting the Volume Balance for Each Performance Part (Part Balance).....73

Chapter 3 Song Playback75

 Playing a Song.....75

 Listening to Songs on CDs (Only for Instrument Equipped with CD Drive).....77

 Using Keywords to Search for Songs (Song Search)81

 Registering the Songs You Like (Favorites).....82

 Removing Songs From Favorites.....83

 Using the Remote Control.....84

 How to Use the Remote Control.....84

 About the Remote Control85

Chapter 4 Practice Functions.....87

 Displaying the Notation87

 Touching Notes to Confirm the Sounds (Touch the Notes).....88

 Scrolling the Notation Along with the Performances (AutoSync DigiScore).....88

 Making Detailed Settings for the Notation Display.....89

 Saving Notations as Image Data.....92

 Adjusting the Tempo94

 Setting the Tempo by Pressing the Button in Time (Tap Tempo)94

 Playing Back at a Fixed Tempo (Tempo Mute).....95

 Match the Tempo Before You Begin Playing (Count In).....96

 Muting Some Parts Before Playing (Track Buttons).....97

 Setting Markers for Repeated Practice (Marker)98

 Placing a Marker within a Song.....98

 Playback from a Marker Location99

 Erasing a Marker99

 Moving a Marker100

 Playing Back the Same Passage Over and Over.....101

 Transposing Keyboard Sounds and Songs Played Back (Transpose).....102

Chapter 5 Recording and Saving the Performance 104

 Recording a New Song (New Song)105

 Recording With Accompaniment.....107

 Recording Along with a Song.....109

 Recording While Selecting the Track Buttons (Redoing Recordings).....110

 Erasing Recorded Performances.....111

 Erasing the Performance on Specific Tracks.....111

 Changing How Recording Stops.....111

 Recording Songs Starting with Pickups112

 Using External Memories113

 Connecting and Ejecting an External Memory113

 Formatting Media (Format).....114

 Saving Songs.....116

 Deleting Saved Songs.....119

 Copying Songs on External Memories to Favorites.....120

 Copying Songs Saved in Favorites to External Memories121

Chapter 6 Creating Performance Data Including Moving Keys (A/V sync)..... 122

 Recording.....122

 Making the Connections122

 Making Advanced A/V Sync Output Settings126

 Playback (Aux Input)127

 Making the Connections127

Contents

Making Advanced A/V Sync Input Settings	128	Correcting Timing Discrepancies (Quantize).....	146
Chapter 7 User Program Registration	129	Deleting Measures (Delete)	147
Saving Performance Settings (User Program)	130	Inserting Blank Measures (Insert).....	147
Calling Up Saved User Programs	131	Transposing Individual Parts (Transpose).....	148
Changing the Way User Programs Are Called Up	131	Making Measures Blank (Erase)	148
Saving the User Program Sets.....	131	Exchanging Parts (Part Exchange).....	149
Loading Saved User Program Sets	132	Correcting Notes One by One (Note Edit)	149
Deleting Saved User Program Sets	133	Modifying the Tone Changes in a Song (PC Edit)	150
Copying Sets of User Programs on External Memories to the User Memory	133	Changing the Beat in the Middle of a Song (Beat Map).....	150
Coping Sets of User Programs Stored in the User Memory to External Memories	134	Changing the Tempo of Recorded Songs.....	151
Using the Pedal to Switch User Programs	134	Changing the Tempo Within the Song	151
Selecting the Pedal Used for Switching Settings (Pedal Shift)	134	Adjusting the Tempo While Listening to a Song.....	151
Sequential Loading of User Program Sets Stored (Load Next)	134	Adjusting the Tempo at a Particular Measure	152
Simultaneously Switching User Program and Transmitting PC Numbers	135	Chapter 9 Creating Music Styles 153	
Chapter 8 Creating and Editing Songs	136	Creating Original Styles (User Styles)	153
Multitrack Recording with 16 Parts (16-Track Sequencer)	136	Creating New Styles by Combining Internal Music Styles (Style Composer).....	153
The 16-Track Sequencer Screen	136	Creating a Style from a Song You Composed Yourself (Style Converter)	155
Modifying the Settings of Each Part.....	137	Saving a User Style	158
Getting the Most Suitable Part Tones for the Musical Genre (Tone Set)	138	Deleting Saved User Styles	159
Recording a Performance	139	Copying Styles on External Memories to the User Memory	160
Changing the Recording Method (Rec Mode).....	140	Copying Styles Saved in the User Memory to External Memories	160
Recording While Erasing the Previous Recording (Replace Recording)	140	Chapter 10 Various Settings	161
Layering a Recording Over Previously Recorded Sounds (Mix Recording)	141	Changing the Settings for One-Touch Arranger.....	161
Repeated Recording at the Same Location (Loop Recording)	141	Procedure	161
Re-Recording Part of Your Performance (Punch-in Recording)	142	Adjusting the Keyboard Touch (Key Touch).....	161
Composing an Accompaniment By Entering Chords (Chord Sequencer).....	143	Changing Music Styles Without Changing the Tone or Tempo (One Touch Setting).....	162
Inputting Chords without Playing the Keyboard	144	Changing the Keyboard's Split Point (Split Point)	162
Editing Songs	145	Changing How Chords Are Played and Specified (Arranger Config)	162
Basic Operation of the Editing Functions.....	145	Placing a Marker in the Middle of a Measure	164
Undoing Edits (Undo).....	145	Changing the Settings for the Count	164
Copying Measures (Copy).....	146	Other Settings.....	165
		Procedure	165
		Changing the Tuning (Tuning)	166
		Assigning Functions to Pedals and Performance Pads (Pedal Setting/	

User Functions)167	Connecting a Television.....186
Changing the Bend Range (Pedal Setting)169	Changing the Settings for Showing Images with the External Display and the Television (External Display)186
Changing Standard Pitch (Master Tune).....170	Explanation of Each Items187
Changing the Language (Language).....170	Connecting Video Equipment (V-LINK)187
Selecting Images To Be Shown on the KR and External Displays (User Image Display).....170	Using the V-LINK function187
Changing the Screen Message When the Power Is Turned On (Opening Message).....171	Connecting MIDI Devices188
Remembering the Settings Even When the Power is Turned Off (Memory Backup)171	Connectors188
Restoring the Factory Settings (Factory Reset).....172	Making the Connections188
Changing the Functions of the Remote Control’s Buttons172	Performing in Ensemble with MIDI Instruments (MIDI Ensemble).....189
Changing the Infrared Transmission Function Settings.....174	MIDI Settings.....189
Calibrating the Touch Screen (Touch Screen).....175	Selecting the Transmit Channel (Tx Channel)190
Changing the Part That Makes the Keys Move (Only for Instrument Equipped with Moving Key).....175	Disconnecting the Internal Sound Generator and Keyboard (Local Control)190
Changing the CD Settings (Only for Instrument Equipped with CD Drive)177	Sending Tone Change Messages (Program Change/Bank Select MSB/Bank Select LSB).....191
Setting the Type of CD To Be Played Back177	Sending Recorded Performance Data to a MIDI Device (Composer MIDI Out).....191
Showing a Series of Images on an External Display (Slide Show).....178	Connecting to Audio Equipment191
Running a Slide Show of Images Stored on External Memory178	Connectors191
Changing Slide Shows178	Making the Connections192
Setting the Image Display Duration.....179	Connecting External Speakers194
Selecting the Part to Which the Effect is Added (EffectsPart).....179	Changing the Aux Output Jacks Settings.....194
Formatting the User Memory180	Setup Examples With Surround Set to “Surround” or “Ensemble”194
Automatically Starting the Quick Tour.....180	Connecting a Computer.....195
Adjusting the Piano Designer Resonance181	Connect to the MIDI Connectors195
Disabling Functions Other Than Piano Performance (Panel Lock)181	Connect to the USB Connector.....195
Detailed Song Playback Settings182	Making the Settings for the USB Driver196
Changing the Tone Settings When Playing Back Songs (Play Mode).....182	
Viewing Song Information (Information)182	
Hiding the Lyrics (Lyrics).....182	
Changing the Parts Assigned to the Track Buttons During SMF Playback (Track Assign)183	
Chapter 11 Connecting External Devices.....185	Appendices197
Connecting an External Display or Television.....185	Troubleshooting.....197
Connecting an External Display185	Error Messages.....201
	Tone List.....202
	Drum Set List.....205
	Effects List.....209
	Music Style List (KR117).....210
	Music Style List (KR115).....211
	Chord List212
	Internal Song List.....214
	Parameters Stored to Internal Memory216
	Music Files That the KR Can Use217
	The KR allows you to use the following music files.....217
	About the KR Sound Generator.....217
	Main Specifications.....219
	Index221

Panel Descriptions

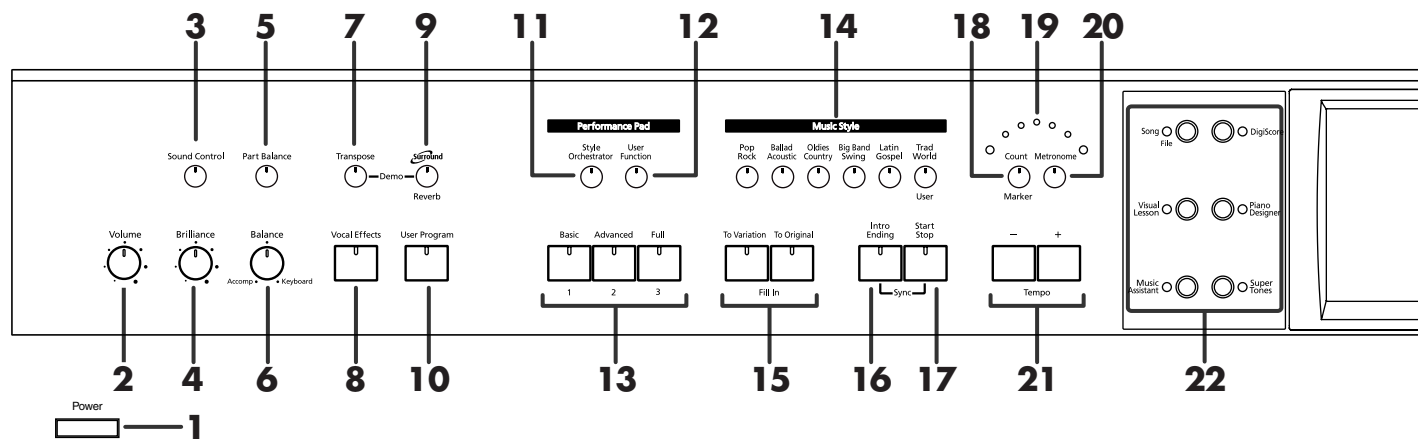

* The KR117 is the model that was used for producing all of the panel depictions that appear within this Owner's Manual.

1. [Power] switch

Pressed to switch the power on and off (p. 21).

* The KR115's [Power] switch is located at the left of the keyboard.

2. [Volume] knob

Adjusts the overall volume (p. 22).

3. [Sound Control] button

Add liveliness to the sound to give it superb clarity and distinctness (p. 43).

4. [Brilliance] knob

Adjusts the brightness of the sound (p. 22).

5. [Part Balance] button

This adjusts the relative volume levels of each of the performance parts (p. 73).

6. [Balance] knob

Changes the volume balance for sounds played with the keyboard and for songs and accompaniments (p. 73).

7. [Transpose] button

Transposes the pitch of the keyboard or the song being played (p. 102).

8. [Vocal Effects] Button

Applies a variety of effects to vocals from the microphone (p. 47).

9. [Surround/Reverb] button

Adds reverberation to the sound (p. 34).

Adds three-dimensional breadth to the sound (p. 36).

10.[User Program] button

Stores the selected functions and states of the buttons (p. 130).

Performance Pads

11.[Style Orchestrator] button

This is used to change the arrangement type for automatic accompaniment with the Performance Pads (p. 69).

12.[User Function] button

This is used to assign a variety of functions to the Performance Pads (p. 167).

13.[1]–[3] buttons

The operation of each is changed depending on the buttons numbered 11-12.

14.Music Style buttons

Selects a Music Style for automatic accompaniment (p. 61).

Pressing the [User] button selects a User Style that you've made yourself or a Music Style on external memory (p. 63).

15.Fill In buttons

Inserts a fill-in in an automatic accompaniment and changes the accompaniment pattern (p. 68).

[To Variation] button

[To Original] button

16.[Intro/Ending] button

Play an intro or ending during automatic accompaniment (p. 65).

17.[Start/Stop] button

Starts and stops automatic accompaniment (p. 65).

18.[Count/Marker] button

You can change the count settings (p. 67, p. 96).

These allow you to add and move markers in the notation as well as repeat playback of song segments simply and easily (p. 98).

19.Beat indicator

This lights up in correspondence with the beat of the selected song or accompaniment.

20.[Metronome] button

Activates the built-in metronome (p. 54).

21.Tempo [-] [+] buttons

Adjusts the tempo.

Press the [-] and [+] buttons at the same time to return to the original tempo.

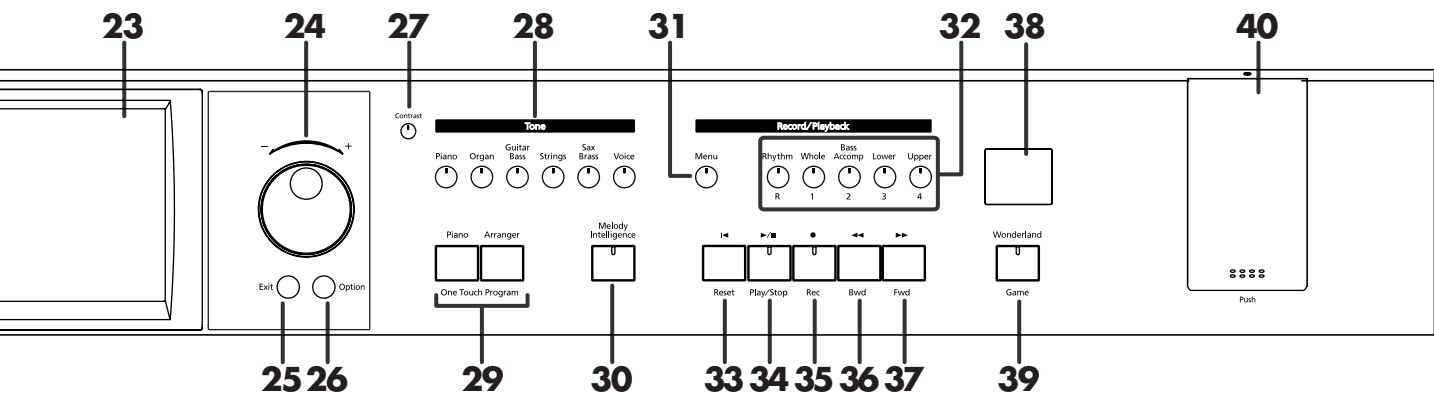

22. Main Buttons

→ See the Quick Start

[Song/File] button

Use this button to select internal songs or songs from external memories (p. 75).

[DigiScore] button

Displays notations (p. 87).

[Visual Lesson] button

You can use the practice function.

[Piano Designer] button (p. 181)

[Music Assistant] button

[Super Tones] button

23.Touch Screen

This lets you perform a variety of operations just by touching the screen (p. 25).

24.Dial

Use this to change on-screen values.

25.[Exit] button

Returns you to the previous screen.

26.[Option] button

Displays a screen for advance function settings.

27.Contrast knob

Adjusts the contrast of the screen (p. 25).

28.[Tone] buttons

They are used to choose the kinds of tones (tone groups) played by the keyboard (p. 28).

[Piano] button

[Organ] button

[Guitar/Bass] button

[Strings] button

[Sax/Brass] button

[Voice] button

29.One Touch Program button

[Piano] button

Makes the optimal settings for a piano performance (p. 27).

[Arranger] button

Makes the optimal settings for playing with automatic accompaniment (p. 58).

30.[Melody Intelligence] button

Adds harmony to the sounds played with the keyboard (p. 70).

Record/Playback

31.[Menu] button

You can select functions for playing back, recording or editing a song (p. 111,p. 136, p. 153, p. 182).

32.Track buttons

Used to play back or record each track of a song (p. 97, p. 110).

33.[◀ (Reset)] button

Resets the song playback-start location to the beginning of the song.

34.[▶/■ (Play/Stop)] button

Starts and stops playback or recording a song.

35.[● (Rec)] button

When pressed, this button places the instrument in recording standby (p. 105, p. 136).

36.[◀◀ (Bwd)] button

Rewinds the song.

37.[▶▶ (Fwd)] button

Fast-forwards the song.

38.Infrared Receiver

Point the remote control at this sensor when using the remote control to operate the KR (p. 85).

39.[Wonderland/Game] button

Here you can learn about instruments while having fun.
→ See the Quick Start

40.External Memory port

Connects an external memory to play (p. 75) and save songs (p. 113).

* Be sure to close the cover of the External Memory port after connecting external memory to the External Memory port.

Panel Descriptions

Jack Panel (Left Side of Bottom Panel)

Jack Panel (Front)

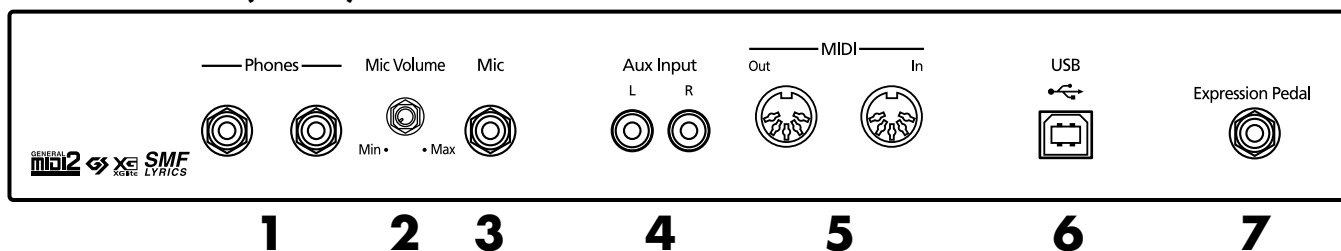

Jack Panel (Rear)

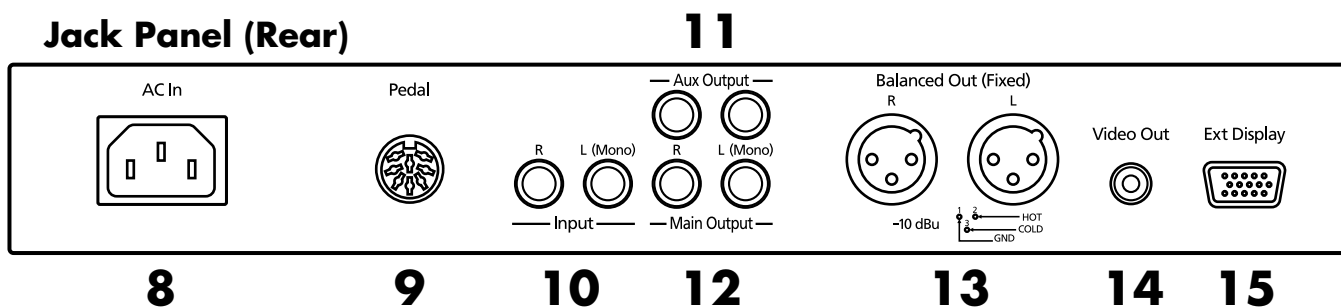

1. Phones jacks

A set of headphones can be connected here (p. 23).

2. Mic Volume knob

Adjusts the volume level for the microphone (p. 23).

3. Mic jack

Used for connecting microphones (p. 23).

4. Aux Input jacks

You can connect other sound generating devices or audio equipment here and have their sound be played through the KR's speakers (p. 193). This is also used for transmitting and receiving performance data included in player piano data. (p. 127).

5. MIDI Out/In connectors

Connect to external MIDI devices to exchange performance data (p. 188).

6. USB connector

You can connect a computer and exchange performance data between the instrument and the computer (p. 178, p. 195).

7. Expression Pedal jack

You can connect an expression pedal (optional EV-7) to use this as an expression pedal.

8. AC inlet

Connect the included power cord to this inlet (p. 21).

9. Pedal connector

Connect the pedal cord here (p. 21).

10. Input jacks

You can connect other sound generating devices or audio equipment here and have their sound be played through the KR's speakers (p. 191).

11. Aux Output jacks

You can connect amps and external speakers here and play accompaniment or surround sound (p. 194).

12. Main Output jacks

These jacks can be connected to your audio system to enjoy more powerful sound (p. 191).

13. Balanced Out (Fixed) jacks

This provides balanced audio signal output. Connect a mixer or other such device here (p. 122).

14. Video Out jack

Connect a television here. This allows you to display the Song Select screen, slide show, lyrics, and notations on the connected television set (p. 185).

This cannot be used simultaneously with the Ext Display connector.

15. Ext Display connector

Connect an external display here. You can display the Song Select screen, slide show, lyrics, and notations on the external display (p. 185).

This cannot be used simultaneously with the Video Out jack.

Right Side of Bottom Panel

CD Drive (Instrument with Moving Key)

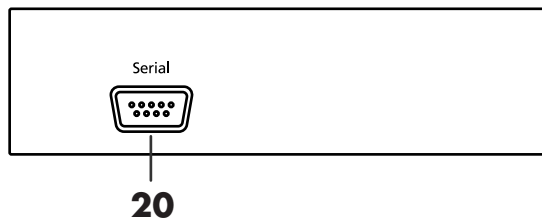
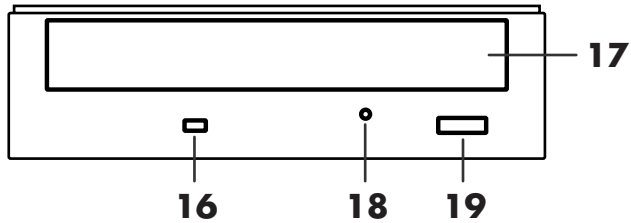

16.Access Indicator

This indicator will light when the inserted CD is being read.

17.Disc tray

Place the CD to be loaded on this tray.

18.Emergency eject hole

This hole allows the disc tray to be opened in case of an emergency.

19.Eject button

Press this button to eject the CD.

* You cannot eject the CD unless the power is on.

20.Serial connector

Connect a external equipment here.

Bottom Panel (Front Right)

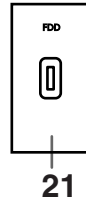

21.Floppy disk drive connector

Connects an optional floppy disk drive to play and save songs.

* Use floppy disk drive available from Roland.

* Attach the floppy disk drive to left of CD drive. For details of the attachment, refer to the owner's manual of the floppy disk drive.

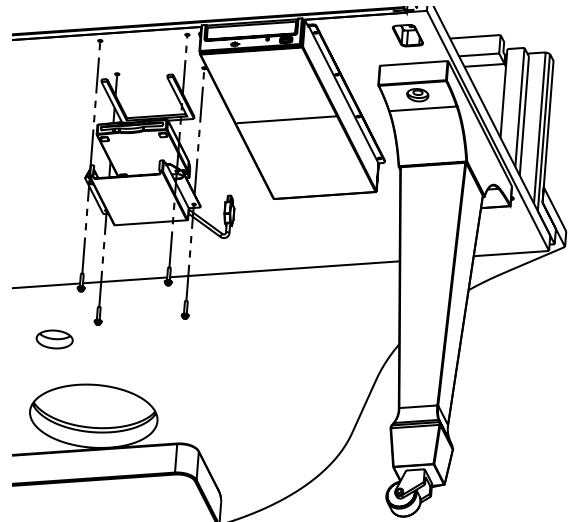

Before You Start Playing

Opening and Closing the Top (KR117)

Opening only the front top

⚠ WARNING

Children must not be permitted to open or close the top on their own—adult supervision is required. Because the top is very heavy, always use two or more people when opening and closing the top, and be sure to handle it carefully.

1. Lift the right front (the upper note side: A in the figure) of the board with both hands, fold it back, and then lay it down slowly on the top.

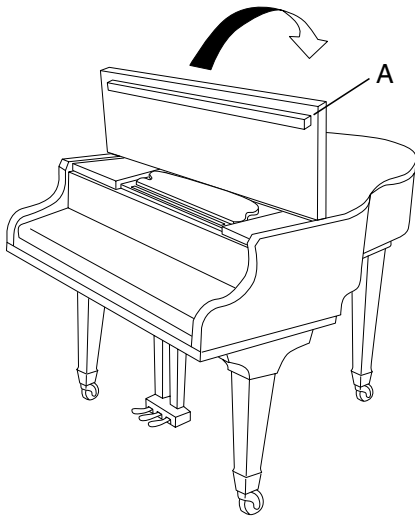

Opening both the front top and the top

2. Follow Step 1 to open the front top. Then lift the right front (the upper note side B in the figure) of the board with both hands.

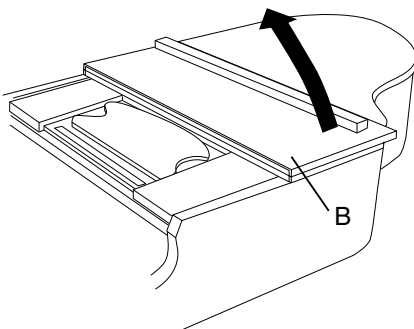

3. While holding up the top with one hand, lift up the top stick and insert its end into the appropriate top slip.

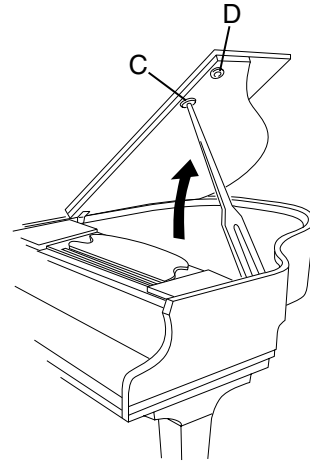

⚠ CAUTION

Do not move the piano with the top in the open position. The top stick may disengage from the socket, causing the top to fall.

⚠ WARNING

When opening the top, be careful not to open it too far. Opening the top at an angle in excess of 30 degrees may damage the unit, or cause the top to drop. Also, before opening the top, make sure that no one is in the path of the top as it is opened.

About the Topsticks and Topslip

The KR117 has two topsticks, each a different length.

You can use the different topsticks to change the amount the top is left open.

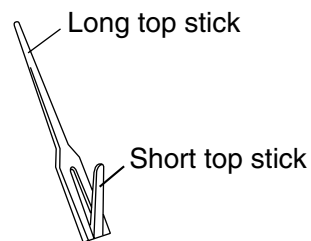

The topsticks and topslip work together as illustrated below.

The long top stick: for inner top slip (C)

The short top stick: for outer top slip (D)

⚠ CAUTION

If you use the wrong top slip, the top stick could slip out of the top slip, causing the top to fall. Make sure that the end of the top stick is inserted securely into the top slip.

To close the top, reverse the opening procedure.

Opening and Closing the Top (KR115)

Raising the Music Rest

1. Gently raise the music rest, then secure it in place.
2. To collapse the stand, fold in the metal fittings while supporting the stand with both hands and gently fold down the stand.

⚠ CAUTION

Always be sure to put the music rest in the upright position before opening and raising the piano top. Be sure to leave the music rest in the upright position before closing the piano top.

Open the Top board

⚠ WARNING

Children must not be permitted to open or close the top on their own—adult supervision is required.

3. Lift the right front (the upper note side: A in the figure) of the board with both hands, fold it up.

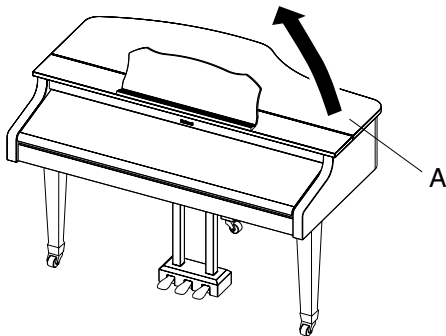

4. While holding up the top with one hand, lift up the top stick and insert its end into the appropriate top slip.

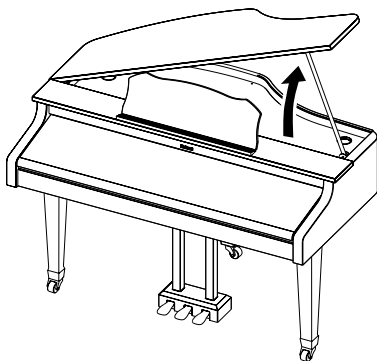

⚠ WARNING

When opening the top, be careful not to open it too far. Opening the top at an angle in excess of 20 degrees may damage the unit, or cause the top to drop. Also, before opening the top, make sure that no one is in the path of the top as it is opened.

⚠ CAUTION

Do not move the piano with the top in the open position. The top stick may disengage from the socket, causing the top to fall.

To close the top, reverse the opening procedure.

Raising the Music Rest

KR117

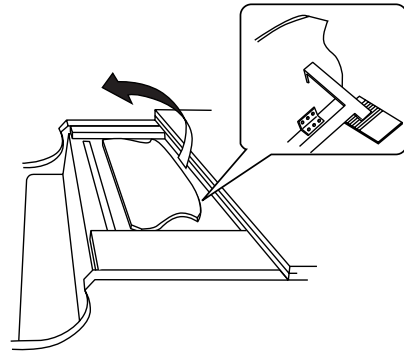

1. Open the front top.
2. Hold the music rest with both hands, then raise it forward.
3. Place the music rest prop, at the rear of the music rest, into a slot.

KR115

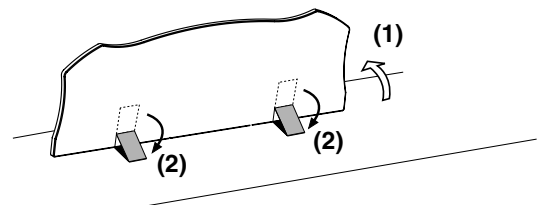

1. Gently raise the music rest, then secure it in place as shown in the figure.
2. To collapse the stand, fold in the metal fittings while supporting the stand with both hands and gently fold down the stand.

Before You Start Playing

■ Using the Music Holders (KR115)

You can use the holders to hold pages in place. When not using the holders, leave them folded down.

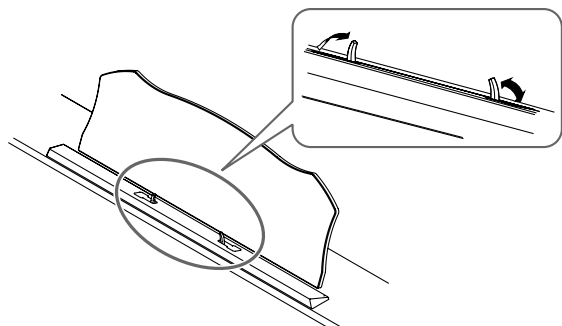

Installing Batteries in the Remote Control

Install the batteries provided in the remote control.

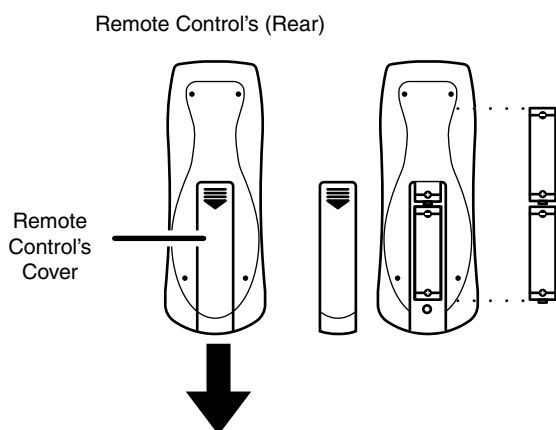

1. Open the battery cover on the back of the remote control.
2. Insert the supplied AA batteries, as shown in the figure of remote control.
3. Close the battery cover.

NOTE

Be careful to observe the correct polarity (+, - direction) when installing the batteries.

MEMO

For more information on the remote control button functions, refer to "Using the Remote Control" (p. 84).

Opening and Closing the Lid

1. When opening the lid, use both hands to gently lift the lid and slide it inward.
2. When closing the lid, be sure to use both hands to grasp the lid, slowly pulling it down towards you, and gently lower it until it stops (fully closed).

CAUTION

When opening and closing the lid, be careful not to let your fingers get caught. Small children should use it only under the supervision of an adult.

CAUTION

When moving the piano, for safety's sake be sure to close the lid first.

NOTE

Make sure you don't have anything (such as sheet music) on the keyboard when you close the lid.

KR117

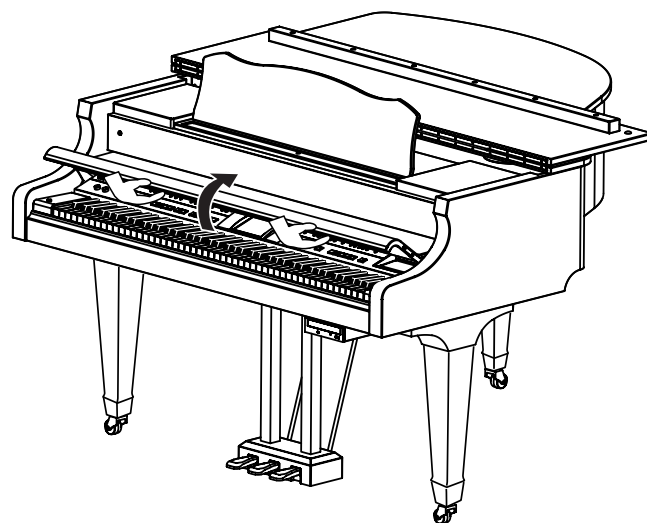



NOTE

Although the KR117's cover is designed to close slowly when you let go of it, it will close immediately if it has been opened only slightly. Take care not to catch or pinch your fingers in the cover.

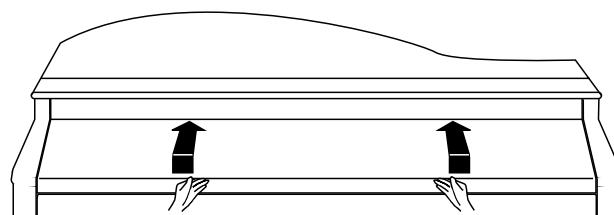
KR115



Connecting the Power Cord

- (b) Screw 
- (c) Screw 
- (e) Cord Cramp 

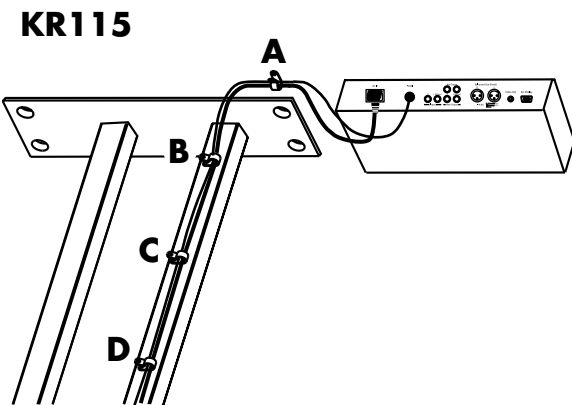
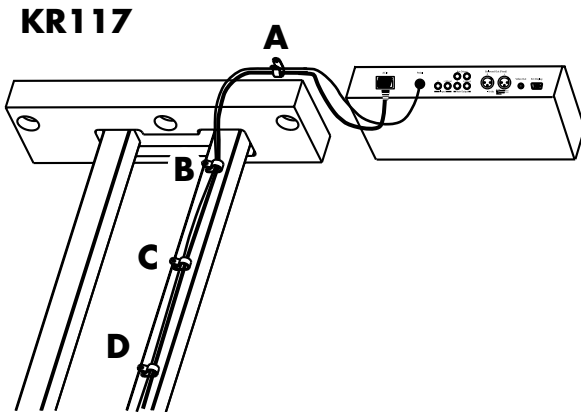

1. Connect the supplied power cord to the AC inlet jack.
2. Connect the pedal cord to the Pedal jack.
3. Cramp the power cord and pedal cord with Cord Cramp (e) and screw (b) at A (see the picture above).
4. Cramp the power cord and pedal cord with Cord Cramp (e) and screw (c) at B, C and D (see the picture above).
5. Plug the power cord into an AC outlet.

Connect the Pedal Cable

Insert the pedal cable into the Pedal connector on the jack panel of the KR.

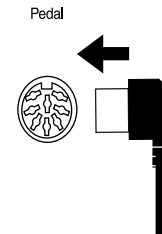

Turning the Power On and Off

NOTE

Turn on power to your various devices in the order specified. By turning on devices in the wrong order, you risk causing malfunction and/or damage to speakers and other devices.

To turn the power on, turn the [Volume] knob all the way down, and then press the [Power] switch.

The power will turn on.

After a few seconds, you will be able to play the keyboard to produce sound.

Use the [Volume] knob to adjust the volume.

NOTE

This unit is equipped with a protection circuit. A brief interval (a few seconds) after power up is required before the unit will operate normally.

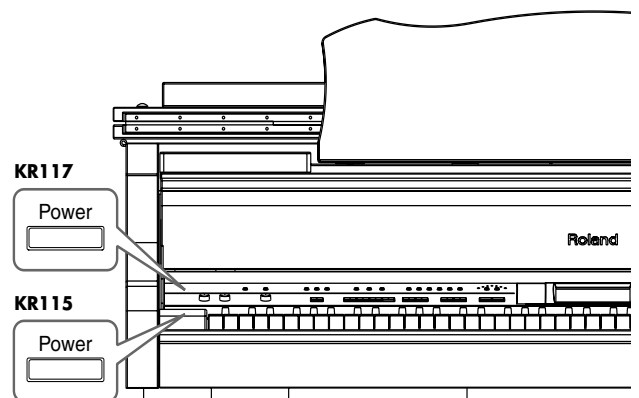

To turn the power off, turn the [Volume] knob all the way to the left, and press the [Power] switch.

The power will be turned off.

* If you need to turn off the power completely, first turn off the POWER switch, then unplug the power cord from the power outlet. Refer to "Power Supply" (p. 6).

Before You Start Playing

About the Pedals

The pedals have the following functions, and are used mainly for piano performance.

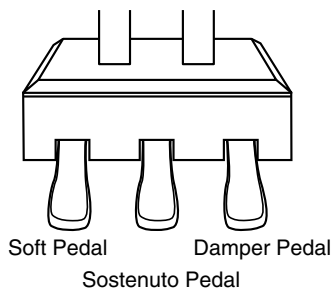

Damper pedal (right pedal)

While this pedal is pressed, notes will be sustained even after you take your fingers off the keys.

The length of the sustain changes subtly according to the extent to which the pedal is depressed.

On an acoustic piano, holding down the damper pedal will allow the remaining strings to resonate in sympathy with the sounds that you played from the keyboard, adding a rich resonance.

The KR simulates this damper resonance.



You can change the amount of resonance applied with the damper pedal. Please refer to “Adjusting the Piano Designer Resonance” (p. 181).

Sostenuto pedal (center pedal)

This pedal sustains only the sounds of the keys that were already played when you pressed the pedal.

Soft pedal (left pedal)

When you hold down this pedal and play the keyboard, the sound will have a softer tone.



You can assign functions to the pedal. Refer to “Assigning Functions to Pedals and Performance Pads (Pedal Setting/User Functions)” (p. 167).

Adjusting the Sound's Volume and Brilliance

Turn the [Volume] knob to adjust the overall volume.

Turn the [Brilliance] knob to adjust the brightness of the sound.



You can use the remote control to change the volume.

Connecting Headphones

The KR has two jacks for plugging in headphones. This allows two people to listen through headphones simultaneously, making it very useful for lessons and performing piano pieces for four hands. Additionally, this allows you to play without bothering others around you, even at night.

Plug the headphones into the Phones jack located at the bottom left of the piano.

Connecting headphones will automatically mute the sound from the internal speakers.

The headphone volume is adjusted by the [Volume] knob of the KR.

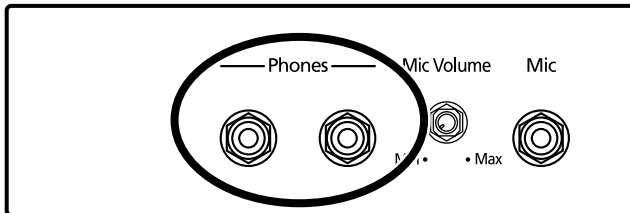
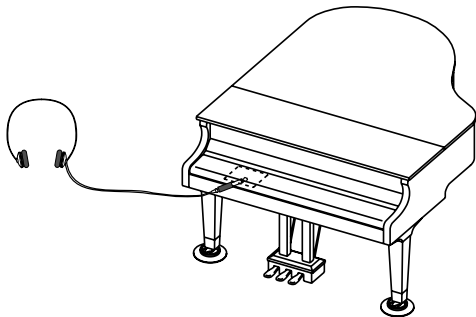

NOTE

Use Stereo headphones.

Some Notes on Using Headphones

- To prevent damage to the cord, handle the headphones only by the headset or the plug.
- Connecting the headphones when the volume of connected equipment is turned up may result in damage to the headphones. Lower the volume on the KR before plugging in the headphones.
- Listening at excessively high volume levels will not only damage the headphones, but may also cause hearing loss. Use the headphones at a moderate volume level.

Connecting a Microphone

You can connect a microphone into the Mic jack, and enjoy karaoke with the KR.

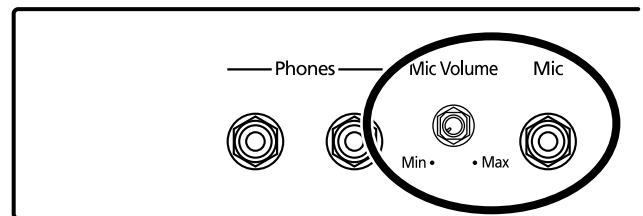
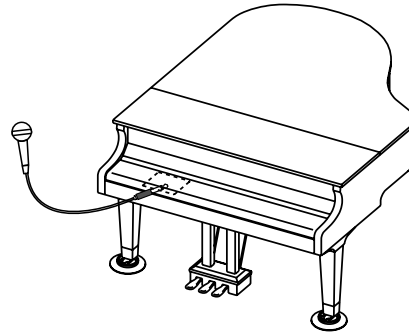

1. Connect a microphone (sold separately) to the Mic jack on the lower-left area of the instrument.
2. Rotate the [Mic Volume] knob in front of the Mic jack to adjust the volume level for the microphone.
3. Adjust the mic echo (p. 48).

Some Notes on Using a Microphone

- Be careful of high volume levels when using mikes late at night or early in the morning.
- When connecting a microphone to the KR, be sure to lower the volume. If the volume control is too high when the microphone is plugged in, noise may be produced by the speakers.
- Howling could be produced depending on the location of microphones relative to speakers. This can be remedied by:
 - Changing the orientation of the microphone.
 - Relocating microphone at a greater distance from speakers.
 - Lowering volume levels.

Before You Start Playing

Connecting an External Display

You can connect a computer monitor or other such external display to the instrument, and display notations and lyrics on the larger screen, and display whatever images as you like.

For more about the external display settings, refer to “Changing the Settings for Showing Images with the External Display and the Television (External Display)” (p. 186). For more on displaying images, refer to “Selecting Images To Be Shown on the KR and External Displays (User Image Display)” (p. 170)

MEMO

If your instrument came with a remote control, you can use the remote control to switch screens. For more information, refer to “Using the Remote Control” (p. 84).

Displays That Can Be Connected to This Instrument

In general, a great many of the VGA monitors and multiscan monitors that are available on the market are compatible with this instrument. However, before you connect any monitor, make sure it meets the following specifications:

- Resolution 640 x 480 pixels
- Horizontal scan frequency 31.5 kHz
- Vertical scan frequency 60 Hz
- Connector 3-row, 15-pin D-Sub type
- Signal Analog

NOTE

Confirm that the display to be used is compatible with the frequencies mentioned above. Using a display that is not compatible with the above frequencies may result in incorrect image output when images move, and in certain cases may even damage the display.

■ Making the Connections

NOTE

To prevent malfunction and/or damage to speakers or other devices, always turn down the volume, and turn off the power on all devices before making any connections.

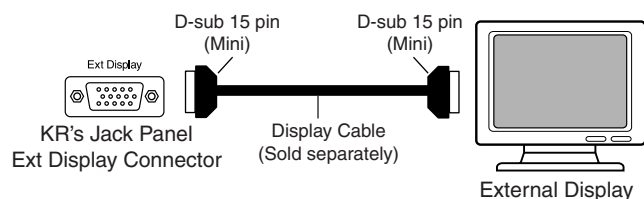

1. Turn off the power to the KR and the display to be connected.

2. Use display cable (sold separately) to connect the display to the Ext Display connector on the KR.
3. Turn on the KR.
4. Turn on the connected display.

MEMO

For more on handling the external display, refer to your display's owner's manual.

Turning the Power Off

After use, turn off the power using the following procedure.

1. Turn the volume all the way down on the KR.
2. Turn off the KR.
3. Turn off the connected display.

About the Touch Screen

The KR makes use of a touch screen. This lets you carry out a wide variety of actions just by touching the screen lightly.

NOTE

The touch screen is operated by touching it lightly with your finger. Pressing hard, or using a hard object can damage the touch screen. Be careful not to press too hard, and be sure to use only your fingers to operate the touch screen.

NOTE

The positioning of the touch screen may become displaced due to changes in the surrounding environment and over time. If this happens, follow the steps in "Calibrating the Touch Screen (Touch Screen)" (p. 175) to correct the pointer position.

NOTE

Do not place items on the touch screen.

Adjusting the Contrast of the Screen

To adjust the contrast of the screen, turn the Contrast knob located at the right side of the screen.

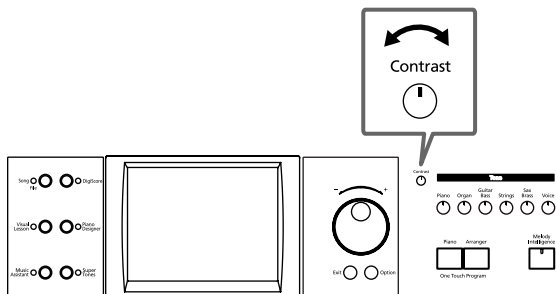

Main Screens

Piano Screen

Immediately after the power is turned on, the Piano screen like the one below is displayed. For details, refer to p. 27.



Basic Screen

The following screen is called Basic screen.

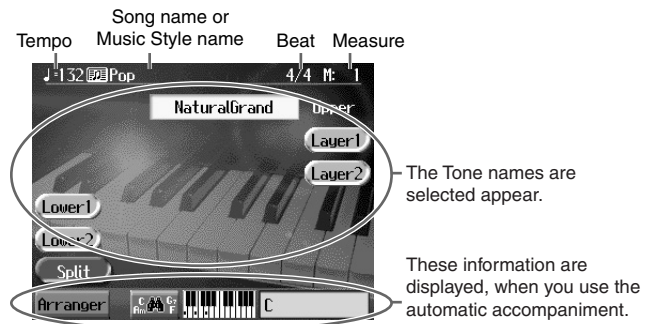

You can usually display this screen by pressing [Exit] button several times.

Follow either of the procedures described below to display it.



- Press the One Touch Program [Arranger] button. The Basic screen appears and the settings are made for automatic accompaniment.
- Press the One Touch Program [Piano] button, then press one of the Tone buttons, then press the [Exit] button.

Before You Start Playing

■ Using the Main Icons

You can use many other screens besides the Basic screen to do things. The on-screen graphics that appear three dimensional work like buttons. These are called "Icons."

The main icons you can use on these screens are as follows.

	<p>Some screens consist on two or more pages. You can display the next page or the previous page of the screen by touching these icons.</p>
	<p>When you select an internal song or music files that includes the lyrics data, this icon appears in the Piano screen or Basic screen. Touch this to display the lyrics.</p>

NOTE

The explanations in this manual include illustrations that depict what should typically be shown by the display. Note, however, that your unit may incorporate a newer, enhanced version of the system (e.g., includes newer sounds), so what you actually see in the display may not always match what appears in the manual.

■ The [Option] Button and The [Exit] Button

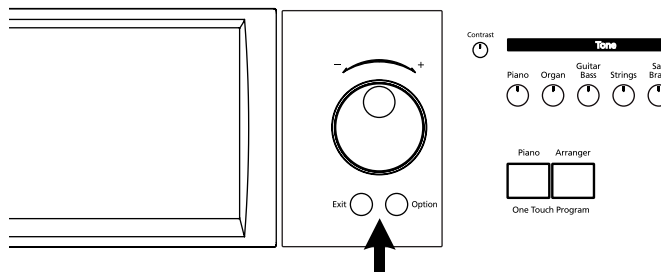

The [Option] Button

This displays a screen for advance function settings.

The screen that opens differs depending on the screen that was displayed when the button was pressed.

The [Exit] Button

Touch to cancel the settings currently being made and close the screen displayed. Normally, pressing the [Exit] button one or more times returns you to the Basic screen.

■ The Scroll Bar and The Page Icon

The Song and Tone selection screens feature a scroll bar at the right of the screen list, with page icons at the top and bottom of the scroll bar.

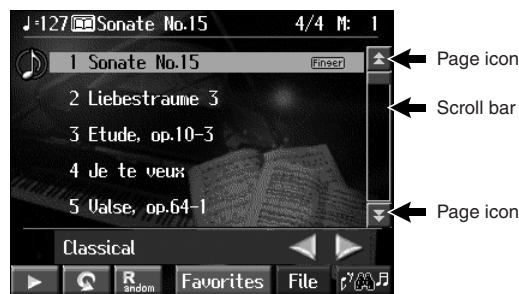

Touch the scroll bar and drag up and down to scroll through the list.

Touch the page icons   to change pages.

Chapter 1 Performance

Playing the Keyboard Like a Piano (One-Touch Piano)

You can create the optimal settings for a piano performance with the press of a single button.

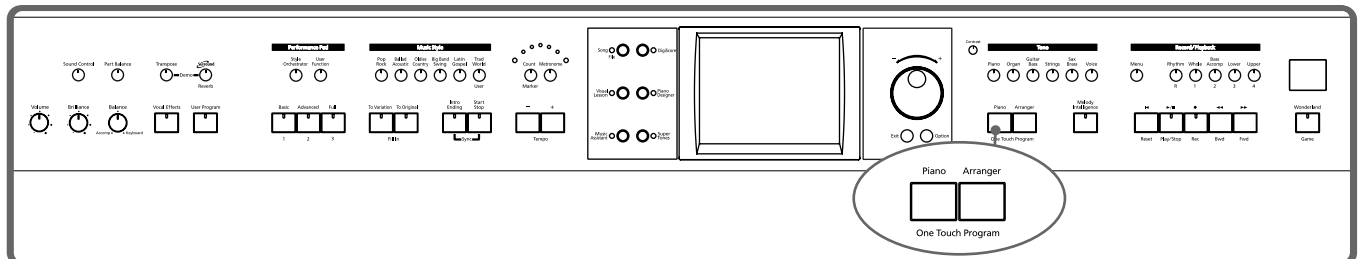

1. Press the One Touch Program [Piano] button.

A “Piano screen” like the one shown below will appear.



When you press the One Touch Program [Piano] button, the KR will switch to the following settings, regardless of the current panel settings.

- If the keyboard has been split into upper and lower sections (p. 32), the keyboard returns to a single section.
- The pedals return to their usual functions (p. 22).
- The Grand Piano sound is automatically selected.
- The effect is automatically set to “Damper Resonance” (p. 46).

MEMO

Since this instrument faithfully reproduces real acoustic piano action and response, keys played in the top one-and-one-half-octave range continue to resonate, regardless of the damper pedal action, and the tone in this range is audibly different. The Key Transpose setting (p. 102) can also be used to change the range that is unaffected by the damper pedal.

MEMO

You can change the piano performance settings by touching the [Piano Designer] button. For more details, refer to “[Piano Designer] Button” in the Quick Start.

MEMO

When you select an internal song or music file that includes the lyrics data, < Lyrics > appears in the Piano screen or Basic screen. Touch this to display the lyrics.

MEMO

< Headphones > appears in the Piano screen or Basic screen when headphones are connected. You can add three-dimensional breadth to the sound from the headphones (p. 39).

Performing with a Variety of Tones (Tone Buttons)

The KR comes with a many built-in instrument sounds and effects. This lets you enjoy perform in a wide range of musical styles.

The built-in sounds are called “Tones.” The sounds are organized into six tone groups, which are assigned to the Tone buttons.



For more about the names of Tones, take a look at the “Tone List” (p. 202).

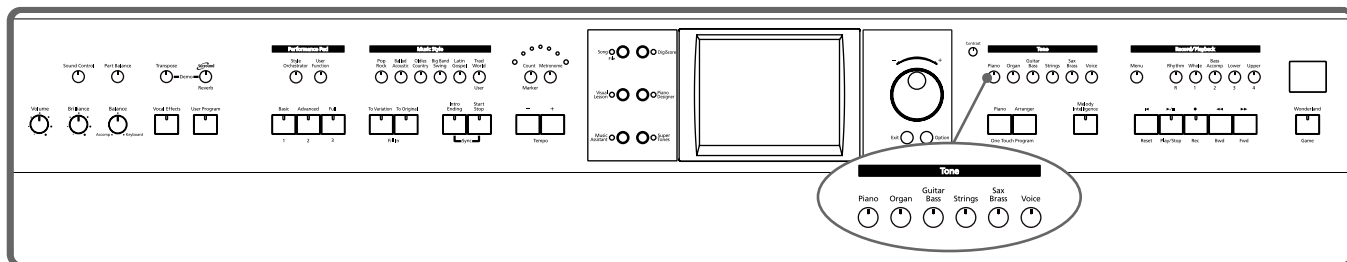

1. Press any one of the Tone buttons to select a tone group.

You’ll see that button’s indicator light up.

The screen displays the tone names included in the tone group you’ve selected.



This screen is called the “Tone selection screen.”

Tones indicated by **EX** is called an “EX voice.” These voices are especially recommended.

Tones indicated by **88** mark is the 88-key multisampled piano tone.

Tones indicated by the red **EX** or **88** mark produce the “Key Off Sound.”

What “Key Off Sound” does is recreate the tonal changes produced when the fingers are released from the keys.

Tones indicated by the blue **EX** icon sound “playing noises” when some keys are played. “Playing noises” refer to noises such as the sound of guitar strings as they are rubbed and other sounds that enhance realism in performance expression.

Tones indicated by “GS” is GS tones.

Touch and drag up and down in the scroll bar to scroll through the screen and display other tones.

Touch the page icons **< ↑ >** **< ↓ >** to change pages.

You can touch **<Audition>** for an audio demonstration of a particular tone.

You can touch the scroll bar and drag up and down to scroll through the list.

You can touch <Effects> to add effect sounds to a variety of tones (p. 46).

You can do searches for tones according to search parameters or by name by touching <Search> (p. 30).

2. Touch a tone name to select the tone.

You'll hear the tone you've selected when you play the keyboard.

You can use the dial to scroll through the screen as you switch the Tones to be played.

3. Press the [Exit] button.

This returns you to the Basic screen or the previous screen.

■ Playing Percussion Instruments or Sound Effects

You can use the keyboard to play percussion sounds or effects like sirens and animal sounds.

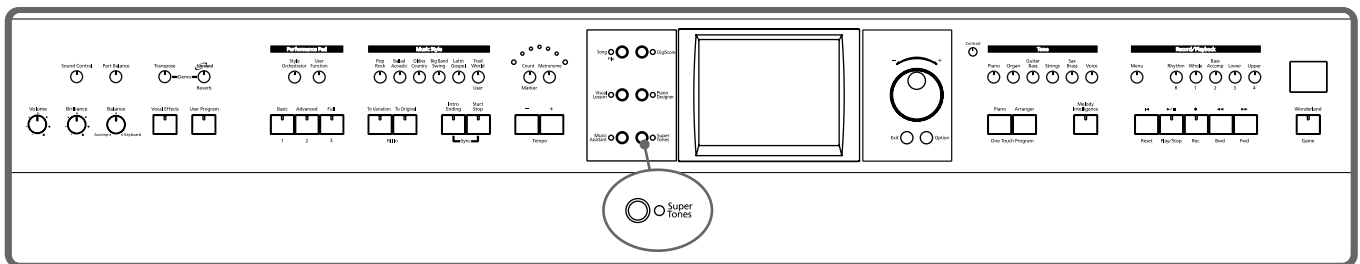

1. Press the [Super Tones] button and watch the indicator light up.

2. Touch <◀▶> <▶▶> several times to display the "Drums" screen or the "SFX (SOUND EFFECT)" screen.

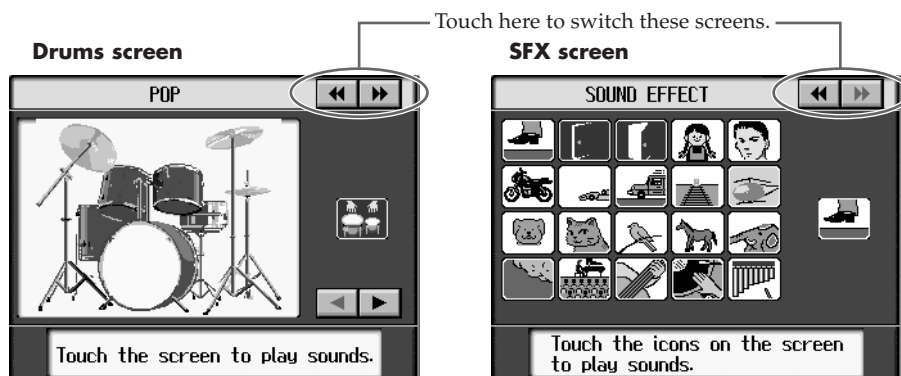

Each note of the keyboard will play a different sound.

You can also have play sounds by touching the screen.

You can select other drum tones by pressing the <◀▶> or <▶▶> buttons.

3. Press the [Exit] button several times.

This returns you to the Basic screen or the previous screen.

MEMO

The combination of sounds assigned to the keyboard varies according to the drum set. Take a look at the "Drum Set List" (p. 205) and "SFX Set" (p. 208).

■ Using Keywords to Search for Tones (Tone Search)

You can search for tones that match the conditions you set for instrument or musical style. You can also search the tones using the first character of the tone name.

1. Press any Tone button.

The tone selection screen appears.

2. Touch <Search>.

The following “Tone search screen” appears.

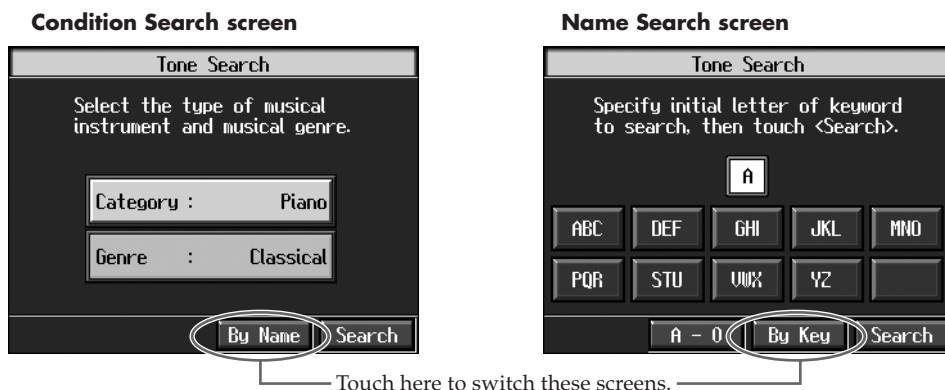

Searching by Conditions

3. Touch <Category> or <Genre>, then use the dial to select the search conditions.

4. Touch <Search>.

The search results appear in the display.

Touch the tone name to select the tone.

After selecting the tone, press the [Exit] button several times to return to the tone selection screen.

Searching by Tone Name

3 Touch <By Name>.

Touch <By Key> to go to the condition search screen.

4. Decide which character is to be used for the search.

The selected character appears in the middle of the screen.

Enter the character you’re searching for. For example, touching <ABC> in succession cycles you through the available choices in that character group (“A”→“B”→“C”...).

Touching <A-0> selects the type of character. Each time you touch <A-0>, the character switches between alphabets and numerals.

5. Touch <Search>.

The search results appear in the display.

Touch the tone name to select the Tone.

Press the [Exit] button several times to return to the Basic screen or the previous screen.



In condition search, tones satisfying all of the selected search criteria are sought.

Performing with Multiple Sounds Layered Together (Layer)

Two tones sounding together when you press a single key is referred to as a “layer performance.”

For instance, it’s possible to play the Tones for both Piano and Strings simultaneously.

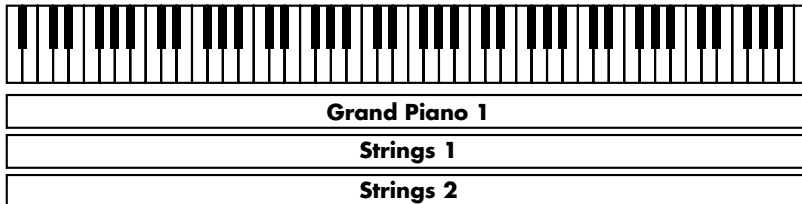

1. Touch <Layer 1> on the Basic screen.



The tone that was sounding before you switched to layer performance, plus the tone indicated in the lower part of the display, are now played together.

Here, the tone appearing in the upper part of the display is called the “upper tone,” and the tone appearing in the lower part of the display is called the “layer tone.”

In the same manner, you can touch <Layer 2> to layer further sounds.

Changing the Tones

2. Touch the name of the tone to be changed.
Touch here to highlight the tone name.
3. Press a Tone button to select the new tone (p. 28).
4. When you have selected the tone, press the [Exit] button.

The display returns to the Basic screen.

Cancelling the Layer

5. Touch <Layer 1>.

Touch <Layer 2> to have <Layer 2> play as well.

The <Layer 1> and <Layer 2> icons are dimmed, and the Layer performance is cancelled.

Now when you play the keys, only the tone indicated on the screen is sounded.



When you select an internal song or music file that includes the lyrics data, <Lyrics> appears in the Basic screen. Touch this to display the lyrics.



<Headphones> appears in the Piano screen or Basic screen when headphones are connected. You can add three-dimensional breadth to the sound from the headphones (p. 39).



When you touch Octave <-><+> on the tone selection screen, the pitch of the keyboard’s sound is changed in octave units. To learn more, see “Shifting the Keyboard Pitch in Octave Steps (Octave Shift)” (p. 33).



You can change the balance of the Upper and Layer Tone volume. For instructions, see “Adjusting the Volume Balance for Each Performance Part (Part Balance)” (p. 73).

Playing Different Tones with the Left and Right Hands (Split)

Dividing the keyboard into right-hand and left-hand areas, then playing different sounds in each section is called “split performance.” The boundary key is called the “split point.”

The split point key is included in the left-hand keyboard area. Each time power to the keyboard is turned on, the split point is reset to “F#3.”

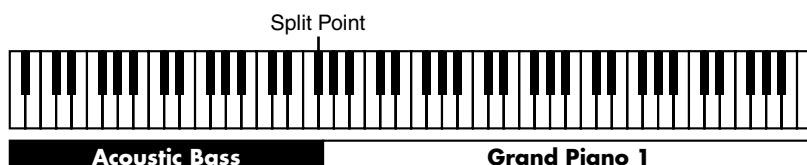

1. At the Basic screen, touch <Split>.



The tone sounding prior to the split performance is played in the right-hand section of the keyboard, and the tone indicated at the left of the screen is played in the left-hand section of the keyboard.

Here, the tone appearing at the right part of the display is called the “upper tone,” and the tone appearing at the left part of the display is called the “lower tone.”

You can turn the tones on and off by touching <Lower 1> or <Lower 2>.

Changing the Tones

2. Touch the name of the tone to be changed.
3. Press a Tone button to select the tone (p. 28).
4. When you have selected the tone, press the [Exit] button.

The display returns to the Basic screen.

Cancelling the Split

5. Touch <Split>.

The <Split> icons are dimmed, and the Split performance is cancelled.

When you play the keys, only the tone indicated on the screen is sounded.



You can change the split point; refer to “Changing the Keyboard’s Split Point (Split Point)” (p. 162).



When you select an internal song or music file that includes the lyrics data, <Lyrics> appears in the Basic screen. Touch this to display the lyrics.



<Headphones> appears in the Piano screen or Basic screen when headphones are connected. You can add three-dimensional breadth to the sound from the headphones (p. 39).



When you touch Octave <-> <+> in the tone selection screen, the pitch of the keyboard’s sound is changed in octave units. To learn more, see “Shifting the Keyboard Pitch in Octave Steps (Octave Shift)” (p. 33).



You can change the volume balance between the upper and lower parts of the keyboard; refer to “Adjusting the Volume Balance for Each Performance Part (Part Balance)” (p. 73).

Turning On Layer and Split Performance Simultaneously

Turning on either Layer Performance or Split Performance allows you to divide the keyboard into an upper and a lower part and play with two Tones layered in the lower part, and three Tones layered in the upper part.



MEMO

When the keyboard has been divided into upper and lower sections, the damper pedal is applied to only the upper section. If you want to add lingering reverberations to the notes of the lower section, see “Assigning Functions to Pedals and Performance Pads (Pedal Setting/User Functions)” (p. 167).

■ Shifting the Keyboard Pitch in Octave Steps (Octave Shift)

When using layer performance (p. 31) or split performance (p. 32), you can change the pitch of the keyboard’s sound in octave units. This function is called “Octave Shift.”

For example, when playing a Layer performance, if you change the pitch of one of the tones and then layer it, it changes the impression created with the tone.

1. On the Basic screen, touch <Layer1> or <Split>.

The KR switches to layer performance or split performance.
2. To apply Octave Shift, touch the name of the tone you’ve selected.
3. Press the Tone button to display the Tone selection screen.



4. Touch Octave <-> or <+> in the lower part of the screen to adjust the pitch of the sound.

Each time you touch <+>, the pitch is raised one octave.

Each time you touch <->, the pitch is lowered one octave.

The sound can be changed from two octaves lower than the original sound (-2) to two octaves above the original (+2).

Press the [Exit] button to return to the Basic screen or the previous screen.

Adding Reverberation to the Sound (Reverb)

Apply a reverb effect to the notes you play with the KR.
 Reverb makes it sound as if you are playing in a concert hall.

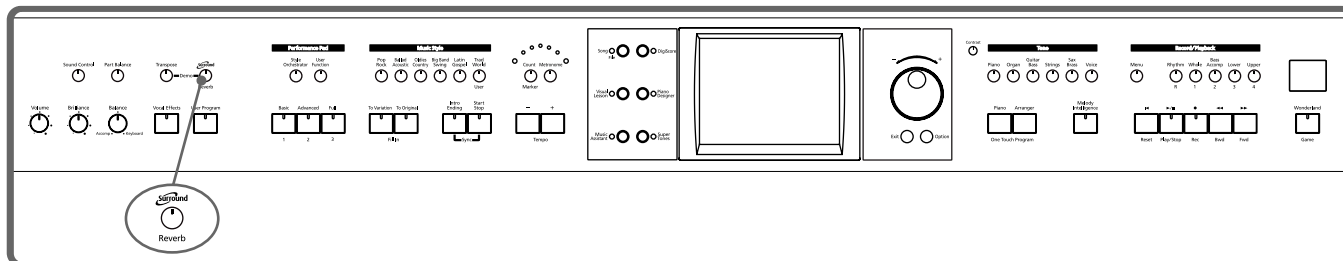

1. Press the [Surround/Reverb] button and watch the its indicator light up.

A “Reverb screen” like the one shown below appears.



Touch   to switch the screens.

2. Touch an icon to select the performance space.

Display	Explanation
Hall1	Hall with bright reverberation
Hall2	Hall with warm reverberation
Room1	Room reverberation
Cathedral	High-ceilinged cathedral
Ground	Wide open space with no reverberations
Room2	Small room
Lounge	Larger room
Studio	A recording studio
Gymnasium	In a gymnasium
Hall3	Large concert hall reverberation
Dome	A domed ballpark
Cave	Adds the extended reverberations found inside a cave
GS Room1	Reproduces an indoor-type reverb. Provides a clear, expansive reverberation.
GS Room2	
GS Room3	

Display	Explanation
GS Hall1	Reproduces the reverberation found in a hall. Gives reverberation with a greater sense of depth than GS Room.
GS Hall2	
GS Plate	Reproduces a plate echo (reverberation created using the vibrations of a metal plate).
GS Delay	A delayed sound that is added to the original, similar to the reflected sounds of mountain echoes.
GS Pan Delay	The reflected sounds are panned (shifted) laterally.

3. Touch the slider beneath the icons to adjust the effect selected.

Touch and slide the knob on the screen to the right for a deeper reverb, and to the left for less.

You can also move the slider with the dial.

When you press the [Exit] button, the reverb effect is activated, and you return to the previous screen.

Cancelling the Effect

4. Press the [Surround/Reverb] button, and watch the indicator light go out.

The reverb effect is eliminated.



No effect is applied when the slider is moved all the way to the left. In this case, the button's indicator won't light up when you press the [Surround/Reverb] button.

Adding the Surround Sound Effect to the Accompaniment Using External Speakers (Surround)

You can connect an amp or external speaker to the Aux Output jacks and play accompaniment and reverb sounds through it. By using an external speaker this way, it will seem that you are surrounded by the accompaniment or reverb. This is called the “surround effect.”

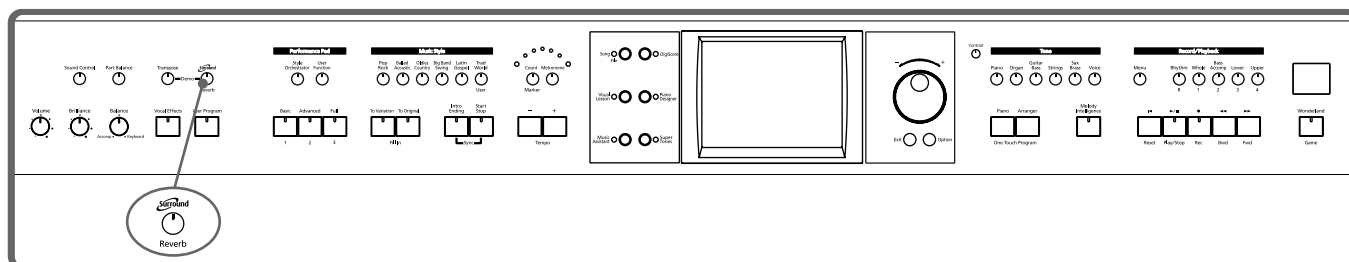

■ Giving More Breadth to the Accompaniment Sound

1. Connect amp or external speaker to the Aux output jacks.
2. Press the [Surround/Reverb] button and watch the indicator light up.
3. Touch <Surround>.

The “Surround Screen” appears.



4. Touch the Type icon <Surround>.
5. When you have selected the type, press the [Exit] button.

■ Cancelling the Effect

6. Touch the Type icon <Surround> and watch the light go out.

The surround effect is eliminated, and the effect is no longer applied to any of the parts.

NOTE

For more on speaker settings when the Surround function is used, refer to “Connecting External Speakers” (p. 194).

NOTE

Only Advanced 3D can be switched on and off when nothing is connected to the Aux Output jacks.

■ Selecting the Part for the Effect

1. Press the [Surround/Reverb] button and watch the indicator light up.
2. Touch <Surround>.
3. On the Surround Screen, press the [Option] button.

The following screen appears.

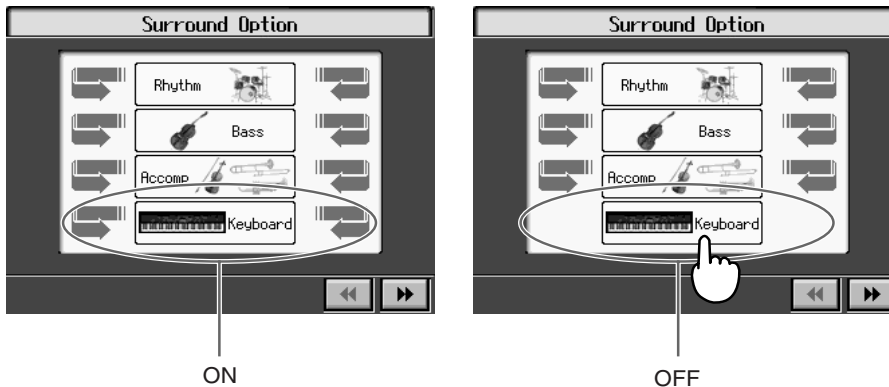

4. Touch the icon to switch individual parts on or off.

When you press the [Exit] button, the Surround effect is activated, and you return to the previous screen.

5. Touch a part's icon to switch the surround on and off.

The sounds of parts set to ON are played from the external speaker and the KR's internal speaker. Parts set to OFF are played only from the KR's speaker.

When you press the [Exit] button, the surround effect is activated, and you return to the previous screen.

■ Selecting the Tone to Which the Effect is Applied

With "Keyboard" in Surround set to On, you can select the parts to which the surround effect is to be applied.

1. Press the [Surround/Reverb] button and watch the indicator light up.
2. Touch <Surround> to display the Surround screen.
3. On the Surround Screen, press the [Option] button.

Touch   to display the following screen.

MEMO

No surround effect is applied, even if the Type icon indicates "On," if all parts are switched off.

MEMO

When you select the <Surround>, you can adjust the volume of the external and built-in speakers (p. 38).

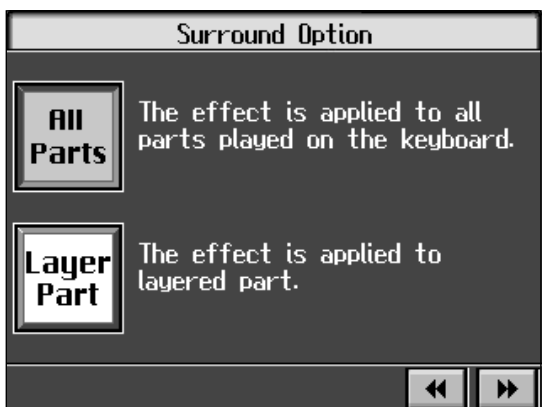

4. Touch <All Parts> or <Layer Part>.

Display	Explanation
All Parts	The effect is applied to all tones played with the keyboard (the left-hand tone, right-hand tone, and layer tone).
Layer Part	The effect is applied only to the layer part. When not using a layer performance (p. 31), the Surround effect is not applied to the keyboard performance, even if <Keyboard> on the Surround Screen is set to On.

When you press the [Exit] button, you return to the Surround Screen.

■ Changing the Amount of Surround Effect

- 1.** Press the [Surround/Reverb] button and watch the indicator light up.
- 2.** Touch <Surround> to display the Surround screen.
- 3.** On the Surround Screen, press the [Option] button.

Touch   to display the following screen.



- 4.** Touch the “Int” and “Ext” sliders to adjust the volume levels of the external speaker and the KR’s speaker.

When you press the [Exit] button, you return to the Surround screen.



This setting is enabled only when the <Surround> type icon is selected.

Using the Internal Speakers to Add Three-Dimensional Spatiality to the Accompaniment Sounds (Advanced 3D)

You can add three-dimensional breadth to the sounds you play with automatic accompaniment (p. 57), or to internal songs or music files. With this effect, called “Advanced 3D,” you seem to be surrounded by the sound of the performance.

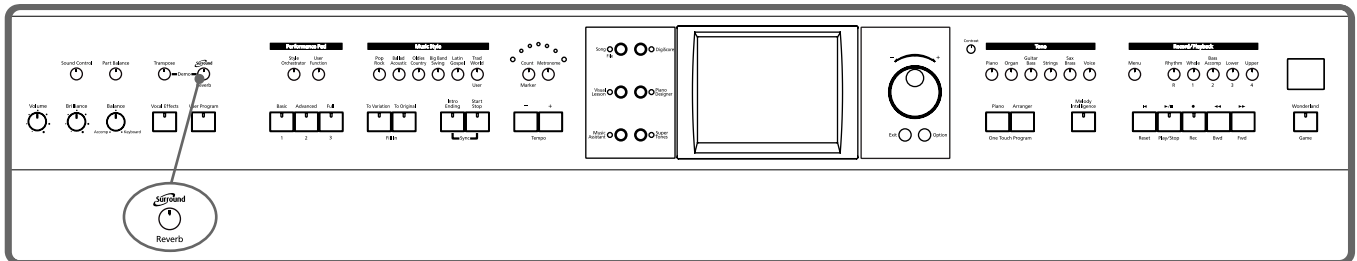

1. Press the [Surround/Reverb] button and watch the indicator light up.
2. Touch <Surround>.
- 3 On the Surround Screen, touch the Type icon <Advanced 3D>.

Three-dimensional breadth is added to the sound.

○ Adding Depth to Sounds Played Through Headphones

When you have headphones connected, the screen for selecting the type of surround effect changes as shown below.



* You cannot select the Type icon <Surround> or <Ensemble> when headphones are connected.

MEMO

<Headphones icon> appears in the screen when headphones are connected.

■ Selecting the Part for the Effect

1. Press the [Surround/Reverb] button and watch the indicator light up.
2. Touch <Surround> to display the Surround screen.
3. Press the [Option] button.

The following screen appears.

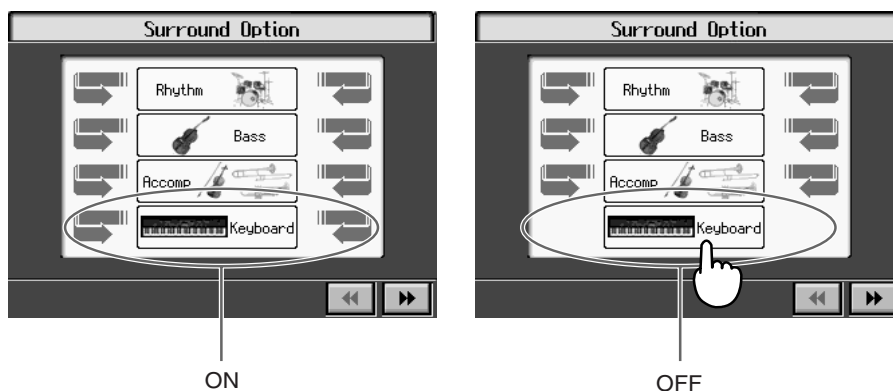

4. Touch the icon to switch the effect on or off for each individual part.
When you press the [Exit] button, the Advanced 3D effect is activated, and you return to the previous screen.

■ Cancelling the Effect



5. Touch the Type icon <Advanced 3D> and watch the light go out.

The Advanced 3D effect is eliminated, and the effect is no longer applied to any of the parts.

MEMO

The Advanced 3D effect is not applied, even when you touch <ON>, if all parts are turned off.

■ Selecting the tone to which the effect is applied

1. Press the [Surround/Reverb] button and watch the indicator light up.
2. Touch <Surround> to display the Surround screen.
3. Press the [Option] button.
4. Touch   to display the following screens.

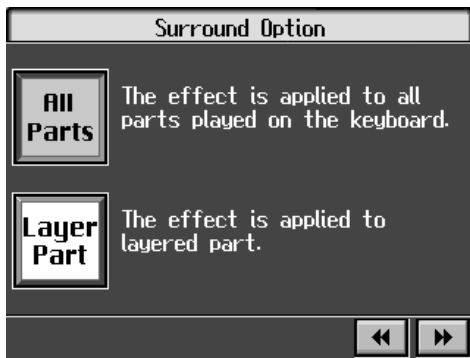



5. Touch the icon to select the value.

Parameter	Display	Explanation
Part	All Parts	The effect is applied to all tones played with the keyboard (the lower tone, upper tone, and layer tone).
	Layer Part	The effect is applied only to the layer part. When not using a layer performance (p. 31), the Advanced 3D effect is not applied to the keyboard performance, even if <Keyboard> on the Surround Option screen is set to On.

6. When you press the [Exit] button, you return to the Surround screen.

■ Making Detailed Settings for Advanced 3D

1. Press the [Surround/Reverb] button and watch the indicator light up.
2. Touch <Surround> to display the Surround screen.
3. Press the [Option] button.
4. Touch   to display the following screens.



5. Touch   for the parameter being set to select the value.

Parameter	Display	Explanation
Mode	Auto	This selects settings that are adjusted for use with headphones when headphones are connected. When no headphones are connected, settings adjusted for speakers are selected.
	Speaker	Settings adjusted for listening to sounds through speakers are selected.
	Headphone	Settings adjusted for listening to sounds through headphones are selected.
Depth	1-4	Changes the apparent depth of the sound. The effect is applied more as the value is increased.
Width	1-128	Changes the breadth of the sound.

You can also change the value with the dial.

6. When you press the [Exit] button, you return to the Surround screen.

Adding Liveliness to the Sound (Dynamic Emphasis)

You can add liveliness to the sound to give it superb clarity and distinctness.

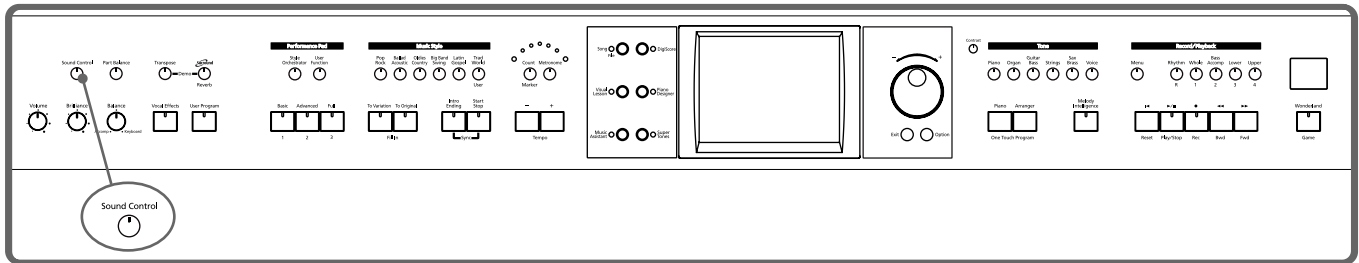

- 1 Press the [Sound Control] button, to display the “Dynamic Emphasis screen.”

The Dynamic Emphasis function is switched on, enlivening the sound.



- 2 Touch the Type icon to select the type.

Indicator	Description
Sharp	Creates a sound with boosted bass and treble.
Clear	Produces a sound with chords in the low registers that are clear and distinct.
Power	Creates a sound with boosted bass.

Canceling the Dynamics Emphasis

- 3 Press the [Sound Control] button once more, and the indicator light goes out.

Adjusting the Sound to Achieve the Preferred Tone Quality (Equalizer)

The KR features a built-in, five-band digital equalizer.

An equalizer boosts or cuts specific sound pitches (frequency ranges) to adjust the sound balance for the overall performance. For example, you can boost the highs to get a crisper sound, or boost the low end for a more powerful sound.

You can also adjust the sound to compensate for the acoustical characteristics of the performance space.

If raising the slider for each frequency ends up distorting the sound, you can correct the distortion with the Master Level slider.

- 1 Press the [Sound Control] button, to display the “Dynamic Emphasis screen.”
2. Touch <Equalizer>.

The “Equalizer screen” appears.



3. Touch the Type icon to make your selection.

Display	Explanation
Piano	The optimal settings for piano performance are selected.
Power	Boosts both the low- and high-frequency ranges.
Mild	Lows and highs are restrained for a pleasant-sounding tone.
Clear	This setting slightly boosts the midrange for a simple pop feeling.
Bright	This setting boosts the high frequencies for a brilliant, sparkling sound.
Flat	All slider values are set to “0.”
User	Store your own preferred settings (p. 45).

4. Touch the slider to make adjustment.

Displayed	Settings Value	Explanation
Low	-60-0-+60	Low-frequency range. This is the range of frequencies for instruments like drums, bass, organ, guitar and strings.
-	-60-0-+60	Mid-low-frequency range. This is the range of frequencies for lower brass and woodwind instruments.
Mid	-60-0-+60	Midrange. This is the range of frequencies where most instrument sounds are concentrated.
-	-60-0-+60	Mid-high-frequency range. The ear is most sensitive to this frequency range.
High	-60-0-+60	High-frequency range. These frequencies add brilliance to the sound.
Master Level	-60-0-+60	You can temper the distortion in the sound by lowering the level. Raising the level too much may cause the sound to become distorted.

You can also move the slider with the dial.

When you press the [Exit] button, the equalization is placed in effect, and you return to the previous screen.

Canceling the Effect

5. Touch <Flat>.

○ Storing the Settings

You can store adjusted equalizer settings to <User>.

Even after editing the settings, you can touch <User> to call up your preferred settings.

1. Press the [Sound Control] button and watch the indicator light up.

2. Touch <Equalizer>.

The "Equalizer screen" appears.

3. Adjust the equalizer.

4. Touch <Write>.

The settings are stored.

Even after editing the settings, you can touch <User> to select the stored settings.

Applying Effects to the Sound (Effects)

You can apply a wide range of different effects to the notes you play on the keyboard.

1. First, press the Tone button to select a Tone (p. 28).

The “Tone selection screen” appears.

2. Then, touch <Effects>.

The “Effects screen” appears.

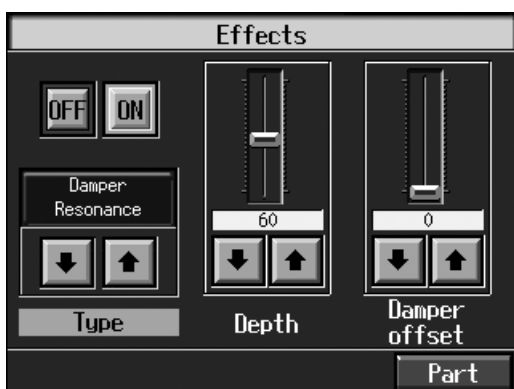

Applying Effects to the Sound

3. Touch <ON>.

The effect selected with <Type> will be applied.

Selecting the Type of Effect

4. Touch <Type>   to select the type of effect.

Setting the Effect

The parameters that can be set change according to the type selected in Step 4.

5. Touch   for the parameter being set to select the value.

You can also move the slider with the dial.

Press the [Exit] button to return to the Tone selection screen.

Cancelling the Effect

6. On the Effects screen, touch <OFF>.



For more on the effect types, refer to the “Effects List” (p. 209).

NOTE

You may find effects not being applied to certain parts when different effects are applied to the upper tone, layer tone, and lower tone. In such instances, you can select which effect is to have priority (p. 179).

Adding Effects to Mic Vocals (Vocal Effect)

With a microphone connected, you can add effects to the microphone vocals. Adding effects to the vocals is referred to as “Vocal Effect.”



For details on connecting a microphone, refer to “Connecting a Microphone” (p. 23).

○ How to select Vocal Effect

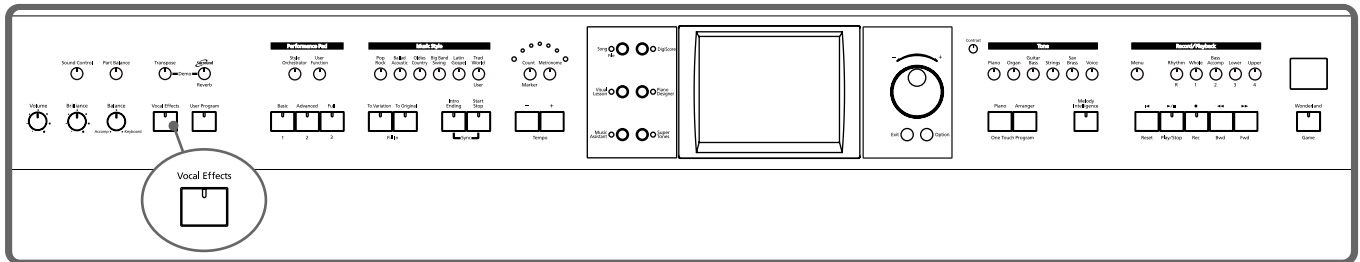

1. Press the [Vocal Effects] button.

The “Vocal Effects screen” appears.

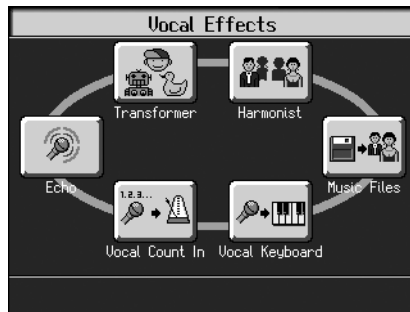

2. Touch any one of the icons.

Icon	Explanation	Page
Echo	Adjusts the microphone echo.	p. 48
Transformer	Alters the microphone vocals.	p. 48
Harmonist	Adds harmonies to the original voice.	p. 49
Vocal Count In	Allows you to start songs and Automatic Accompaniment using your own tempo.	p. 50
Vocal Keyboard	Allows you to produce sounds conforming to the vocal scale.	p. 51
Music Files	You can play a specific part as harmony while playing back a song.	p. 52

3. When you press the [Exit] button, the effect is applied and you return to the previous screen.



If your KR features a built-in CD drive, you can play back the included CD and add vocal effects to vocal parts on CDs.



You can adjust the microphone volume with the Mic Volume knob on the (left) underside of the KR.

Cancelling the Vocal Effect

4. Press the [Vocal Effects] button and watch the indicator light go out.

The Vocal Effect function is cancelled.

○ Adjusting the Echo (Echo)

1. Touch <Echo> in Step 2 of “How to select Vocal Effect” (p. 47).



2. Touch the Echo Type <1> or <2> to change the echo type.

Displayed	Explanation
1	Adds basic reverberations.
2	Adds reverberations for a karaoke-type echo.

3. Touch the bar graph to adjust the amount of echo applied to the vocal.

Press the [Exit] button to return to the Vocal Effects screen.

○ Altering Vocals (Transformer)

You can modify the way your voice sounds through the microphone. This is called the “Voice Transformer” function.

1. Touch <Transformer> in Step 2 of “How to select Vocal Effect” (p. 47).



2. Touch any one of the icons.

Here's what the different icons do.

Display	Explanation
Kids	Transforms the input into the sound of a child's voice.
Bear	Transforms the input sound into the voice of a large animal.
Robot	Transforms the input into the sound of a robot's voice.
Duck	Transforms the input into a duck's quacking sound.
Alien	Transforms the input into an alien voice.
Computer	Transforms the input into a voice like that from a computer.
Female	Transforms male voices into female voices.
Male	Transforms female voices into male voices.

3. Sing through the microphone.

Your voice is transformed according to the item you selected.

Cancelling the Effect

4. Once again, touch the icon you selected in Step 2.



The Voice Transformer effect is eliminated.

Press the [Exit] button to return to the Vocal Effects screen.

○ Adding Harmonies (Harmonist)

You can sing with a harmony accompaniment, even when you're playing solo. This is called the "Harmonist" function.

1. Touch <Harmonist> in Step 2 of "How to select Vocal Effect" (p. 47).

Touch   to switch the screen.



2. Touch any one of the icons.

Here's what the different icons do.

Display	Explanation
Unison	Sounds like two people singing the same melody.
Oct-Up	Adds another voice one octave higher than the original.
Oct-Down	Adds another voice one octave lower than the original.
5th Up	Adds harmony a fifth above the original.
3rd Up	Adds harmony a third above the original.
4th Down	Adds harmony a major fourth below the original.
My Voice	The melody played on the keyboard is played as the harmony. The harmony is added to your voice regardless of the pitch.
Duo 1	The added harmony matches the chords specified on the keyboard. Adding harmony to a single voice gives the effect of two people singing together.
Duo 2	
Variety	The melody played on the keyboard is played as the harmony. The harmony added is matched to the pitch; for example, higher pitches are used for female voices, lower pitches for male voices.
Trio	The added harmony matches the chords specified on the keyboard. This adds a two-voice harmony that makes it seem that a trio is singing.
Chords	The added harmony matches the chords specified on the keyboard. You can change the way harmonies are added with the Melody Intelligence type (p. 70).

Cancelling the Effect

3. Touch the Harmonist type you selected in Step 2 again.

The Harmonist function is cancelled.

Press the [Exit] button to go back to the Vocal Effects screen.

○ Enabling the Start of Songs and Automatic Accompaniment with the Sound of Your Voice (Vocal Count In)

You can start songs and the Automatic Accompaniment by counting into the microphone.

1. Touch <Vocal Count In> in Step 2 of "How to select Vocal Effect" (p. 47).



2. Touch <Arranger> or <Song>.

Display	Explanation
Arranger	Automatic Accompaniment starts at the tempo used for the count.
Song	The song starts at the tempo used for the count.

3. Count to four (“One, two, three, four”) into the microphone.

Count out the number of beats per measure in the time signature of the selected song or Music Style.

For example, if you select a time signature of 4/4, then count to four; count to three when 3/4 time is selected.

The tempo is automatically set according to the interval between the counts as you speak into the microphone, and the song or Arranger begins.

Press the [Exit] button to return to the Vocal Effects screen.

○ Playing Instrument Sounds at Vocal Pitches (Vocal Keyboard)

You can have melodies sung into the microphone played with the KR’s internal Tones.

1. Touch <Vocal Keyboard> in Step 2 of “How to select Vocal Effect” (p. 47).



2. If the <OFF> icon is selected, touch the <ON> icon.

3. Touch any of the icons to select a Tone.

You can also select the Tone by pressing the Tone button.

When you sing into the microphone, the sung pitches are played using the selected Tone.

Cancelling the Effect

4. Touch <OFF>.

The Vocal Keyboard function is cancelled.

Press the [Exit] button to go back to the Vocal Effects screen.



When you play the keys while using Vocal Keyboard, the tone selected for Vocal Keyboard is played.

○ Adding Harmonies to a Specified Part (Music Files)

When you sing while playing back a specified part from song data, harmony is added based on pitches of the specified part.

1. Select the song to which you want to add harmony.

To select a song stored in external memory, connect the external memory to the external memory port.

2. Touch <Music Files> in Step 2 of “How to select Vocal Effect” (p. 47).



3. Touch the icon for the part to which you want to add harmony.

When you play back the song and sing into the microphone, harmonies are added using the pitches of the specified part.

4. Touch <Variety>.

When <Variety> is ON, the melody played on the keyboard is played as the harmony. The harmony added is matched to the pitch.

Cancelling the Effect

5. Touch the icon you selected in Step 3 again.

The Music Files function is cancelled.

Press the [Exit] button to go back to the Vocal Effects screen.

■ Enjoying Karaoke Performances with Music Files

1. Connect a microphone.
2. Adjust the volume level and the amount of echo applied.

On the KR, use the Vocal Effect function to adjust the echo (p. 48).

You can also enjoy this effect with the Voice Transformer function (p. 48) and Harmonist function (p. 49).

3. Select a song.

To select a song stored in external memory, connect the external memory to the external memory port. For instructions on how to select songs, refer to “Playing a Song” (p. 75).

4. Adjust the tempo as required with the Tempo [-] [+] buttons.

5. If necessary, change the key of the song (Transpose: p. 102).

When you press the [▶/■ (Play/Stop)] button, the accompaniment starts playing. Sing along with the accompaniment.

When you play back a Music File with lyrics, the lyrics appear on screen.

6. Press the [▶/■ (Play/Stop)] button to stop the accompaniment.

MEMO

Commercial music files designed for “karaoke” sing-along are also available. Consult your KR dealer when purchasing music files. Refer to “Music Files That the KR Can Use” (p. 217).

MEMO

On the KR, lyrics can also be shown on an external display. Refer to “Connecting an External Display” (p. 185) and “Changing the Settings for Showing Images with the External Display and the Television (External Display)” (p. 186).

MEMO

You can stop lyrics from being displayed. Refer to “Hiding the Lyrics (Lyrics)” (p. 182).

Using the Metronome

The KR features a built-in metronome. During playback of the song and accompaniment, the metronome plays at that tempo and beat.

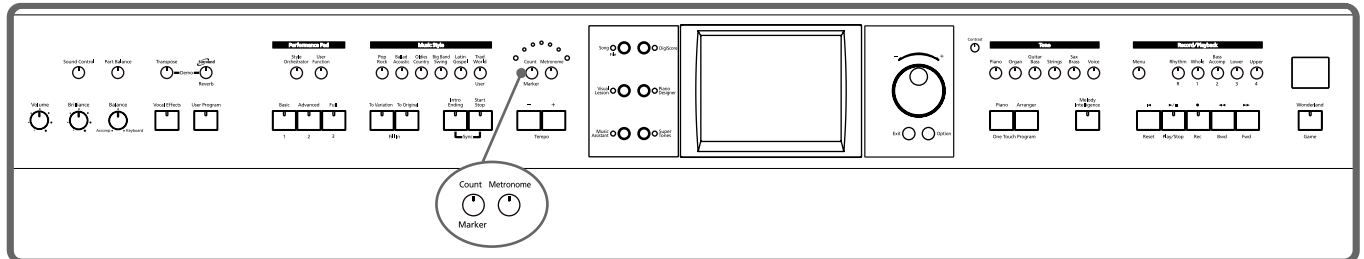

■ Using the Metronome

1. Press the [Metronome] button and watch the indicator light up.

You will hear the metronome.

The following “Metronome screen” appears.



You can press the [Exit] button to have the metronome continue to play while you return to the previous screen.

Stopping the Metronome

2. Press the [Metronome] button once more, and the indicator light goes out.

■ Changing the Metronome Settings

○ Adjusting the Tempo

You can adjust the tempo of the metronome. The tempo and beat of the metronome changes automatically if you use an Automatic Accompaniment or play back a song.

1. Press the Tempo [-] or [+] buttons to adjust a tempo.

You can adjust the metronome tempo over a range of ♩ = 10–500.

Pressing the Tempo [-] and [+] buttons simultaneously returns the selected song accompaniment to the basic tempo.

○ Changing the Beat of the Metronome

1. On the Metronome screen, touch <Beat>.

2. Select the beat with the dial.

MEMO



When $\frac{0}{4}$ is selected, only the upbeat will sound.

○ Changing the Volume

The volume of the metronome can be adjusted to ten different levels.

1. On the Metronome screen, touch <Volume>.

2. Select the volume with the dial.

Choosing  sets the volume to the lowest level, and choosing  sets it to the highest level.

Choose  to silence the metronome sound.



○ Changing the Type of Sound





You can change the sound the metronome makes.

The setting is at “Normal metronome sound” when the KR is powered up.

1. On the Metronome screen, touch <Sound>.

2. Select the sound with the dial.







Displayed	Explanation	Displayed	Explanation
	Normal metronome sound		Electronic metronome sound
いち、二、三	“1, 2, 3” in Japanese	One, two,	“1, 2, 3” in English

Displayed	Explanation	Displayed	Explanation
	Dog and cat sounds		Wood block
	Triangle and castanet		Hand clap

○ Changing How the Metronome Beat (Pattern) Sounds

You can set the Metronome to play at even smaller intervals.

1. On the Metronome screen, touch <Pattern>.
2. Select the pattern with the dial.

Displayed	Explanation	Displayed	Explanation
Normal	Usual sound		Dotted half-note intervals
	Half-note intervals		Dotted quarter-note intervals
	Quarter-note intervals		Dotted eighth-note intervals
	Eighth-note intervals		Sixteenth-note intervals
+Doubl	Single back beat added	+Tripl	Triplet rhythm added
+Shufl	Shuffle rhythm added		

○ Turning Off the Beat Light (Beat Indicator)

The beat light flashes in time with the metronome, accompaniment Styles, and song tempos, but you can set it so that it stays off at all times.

1. Touch <Beat LED> in the Metronome screen.
2. Select ON/OFF (Beat Indicator off) with the dial.

Chapter 2 Automatic Accompaniment

Music Styles and Automatic Accompaniment

What is Automatic Accompaniment?

Press the One Touch Program [Arranger] button for Automatic Accompaniment's optimum settings. Automatic Accompaniment is a function that provides you with accompaniment in a variety of musical genres, just by specifying chords in the left hand. Automatic Accompaniment lets you play with an orchestra, even when performing alone!

What Are Music Styles?

Accompaniment patterns in various musical genres are called "Music Styles."

There are many different kinds of music around the world, and each has its own unique features. What gives jazz or classical music their unmistakable sounds are a unique combination of elements like instrumentation, melody, and phrasing, which interact to create the musical character.

Elements of Music Styles

A Music Style consists of a set of six sections called "divisions."

Division	Explanation
Intro	Played at the start of a song.
Original	The basic accompaniment pattern.
Variation	This is a variation on the Original accompaniment pattern.
Fill In To Original	This is a one-measure phrase inserted at a point where the mood changes and the accompaniment returns to the original.
Fill In To Variation	This is a one-measure phrase inserted at a point where the mood changes and the accompaniment moves ahead to the variation.
Ending	The conclusion of a song.

In addition, the accompaniment Styles are composed of up to a maximum of eight performance parts: "Rhythm," "Bass," "Accompaniment 1," "Accompaniment 2," "Accompaniment 3," "Accompaniment 4," "Accompaniment 5," and "Accompaniment 6."



For instructions on playing the Automatic Accompaniment, refer to "Selecting Music Styles (Music Style Buttons)" (p. 61).

Performing Using Automatic Accompaniment (One-Touch Arranger)

Here's how to create the settings for Automatic Accompaniment.

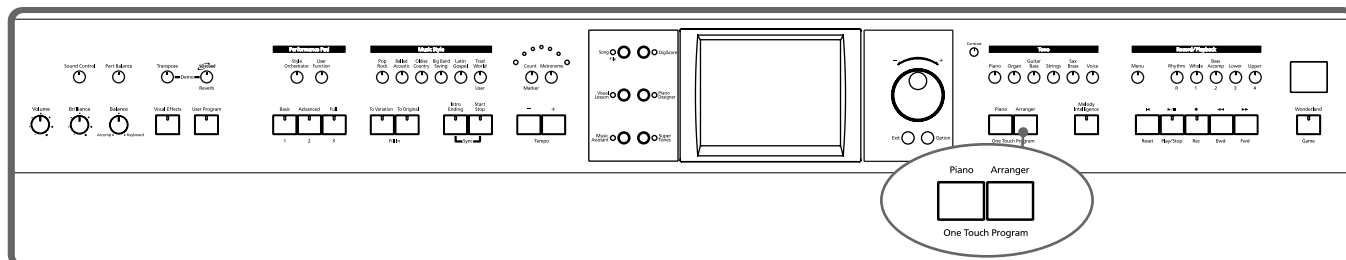

1. Press the One Touch Program [Arranger] button.

The Basic screen like the one shown below appears.



Observe the settings:

- The keyboard is split into left- and right-hand parts, with accompaniment chords specified for the left-hand side of the keyboard.
- A tone appropriate for the selected Music Style is chosen.
- The tempo and beat for the selected Music Style is set.

2. Play a chord on the Lower-part of keyboard.

The accompaniment begins, starting from the intro.

Play chords with the left hand, and the melody with the right.

When you change chords in the left hand, the accompaniment also changes.

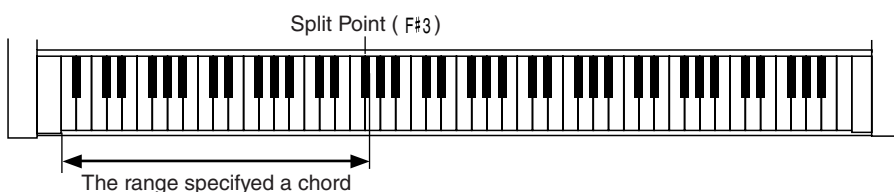

3. Press the [Intro/Ending] button.

After the ending plays, the accompaniment stops.



<🎧> appears in the Piano screen or Basic screen when headphones are connected. You can add three-dimensional breadth to the sound from the headphones (p. 39).



Normally, when you change a Music Style, the tempo and tone change to selections that go well with the selected Music Style. If you do not want to change the tempo and tone, refer to “Changing Music Styles Without Changing the Tone or Tempo (One Touch Setting)” (p. 162).



For instructions on selecting Music Styles, refer to “Selecting Music Styles (Music Style Buttons)” (p. 61).



For instructions on starting and stopping the accompaniment, refer to “Starting and Stopping the Accompaniment” (p. 65).



You can change the range in which chords are played. Please refer to “Changing the Keyboard’s Split Point (Split Point)” (p. 162).

About Chords

A chord is produced when several notes are played simultaneously. Chords are indicated by the pitch of the fundamental note of the chord (the root) and the chord type, which is determined by the other notes of the chord.

For example, the C m chord is expressed in terms of the root note "C" and the chord type "m" (minor). C m is made up of the three notes "C," "E ♭" and "G." "C m" is indicated as the chord name on the Basic screen.

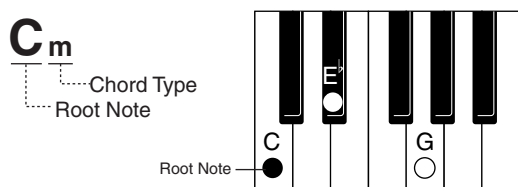

All chord roots are indicated as a letter, sometimes with # or ♭ added, and correspond to the notes shown below.

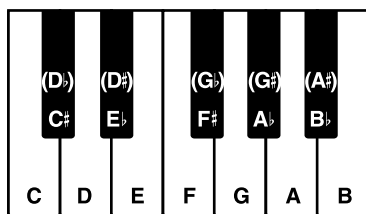

Playing Chords with Simple Fingering (Chord Intelligence)

"Chord Intelligence" is a feature that chooses the accompaniment chords the moment you play a key.

To play a "C" chord, for example, you normally have to play the three keys C, E, and G. But with Chord Intelligence, you only have to press the C key to start a "C" chord accompaniment.

• Intelligence 1

Major



Minor

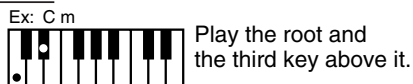

Seventh

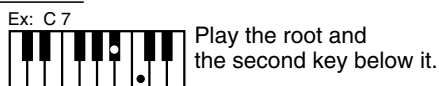

Minor Seventh

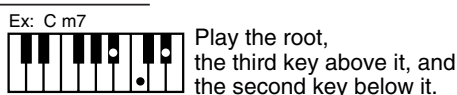

Major Seventh



Diminished

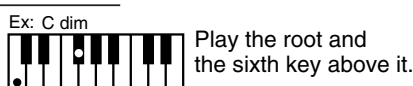

Normally, settings used for the Chord Intelligence function are selected, but there may be settings that are not used. You can also change the rules governing how chords are played. For more information, see "Changing How Chords Are Played and Specified (Arranger Config)" (p. 162).



For more information about chord fingering, refer to the "Chord List" (p. 212).

■ Viewing Chord Fingerings (Chord Finder)

Whenever you are not sure how a certain chord is fingered, you can display the notes of the chord on the screen.

1. On the Basic screen, touch <  >.



2. Touch the root of the chord you want to learn about.

The chord fingering appears on screen.

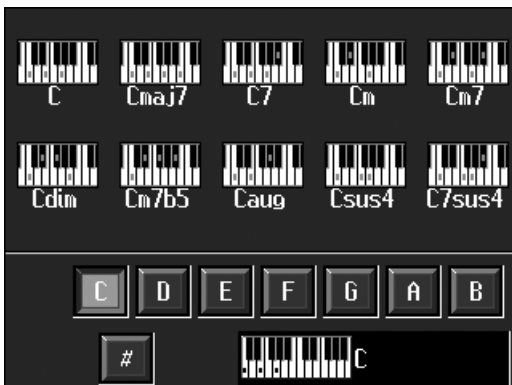

For example, if you wanted to see the fingering for a C# chord, you would touch <C>, then touch <#>.

Press the [Exit] button to go back to the Basic screen.

Selecting Music Styles (Music Style Buttons)

You can select a variety of different Music Styles by pressing the Music Style buttons.

Four different preset styles are assigned to the Music Style.

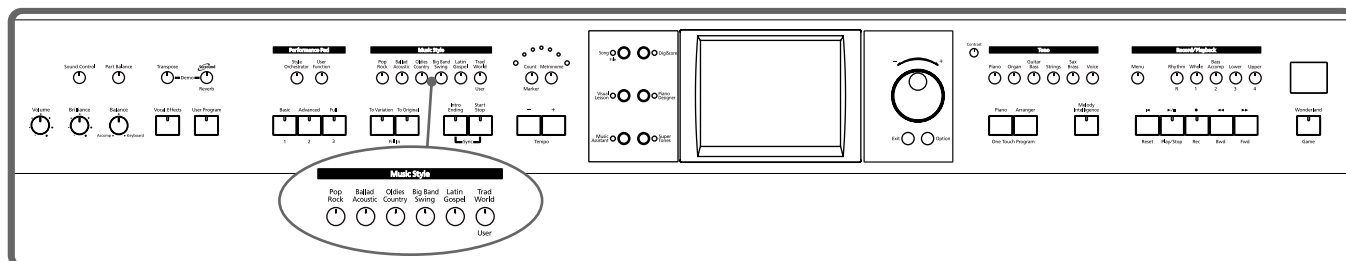

1. Press the One Touch Program [Arranger] button.
2. Press one of the Music Style buttons to select the Music Style group.

Watch the indicator button light up.

Five of the Music Styles included in that group are displayed on the screen.



This screen is called the "Style Selection screen."

Touch and drag up and down in the scroll bar to scroll through the screen and display other styles.

Touch the page icons <  > <  > to change pages.

You can touch <Search> to find Styles that match the selected criteria (p. 62).

3. Touch a Music Style name to select the Music Style.
You can use the dial to automatically switch pages and select Styles.
4. Touch Preset <A>, , <C>, or <D> in the lower part of the screen.
When the Music Style is selected, Preset A is selected.
When any of the Presets from <A> through <D> are selected, the Music Style tempo, Upper Tone, Style Orchestrator settings (p. 69) and other settings change.
5. Press the [Exit] button.

The display returns to the Basic screen.

When you play a chord in the left-hand part of the keyboard, the selected Music Style is automatic.



For more on the Music Style names, refer to the "Music Style List (KR117)" (p. 210).

■ Using Keywords to Search for Music Styles (Style Search)

You can search for Music Styles that match the tempo of the song, musical genre, or other criteria you set.

You can also search Music Styles using the first character of the Style names.

1. Press one of the Music Style buttons.
2. Touch <Search>.

The following “Style Search screen” appears.

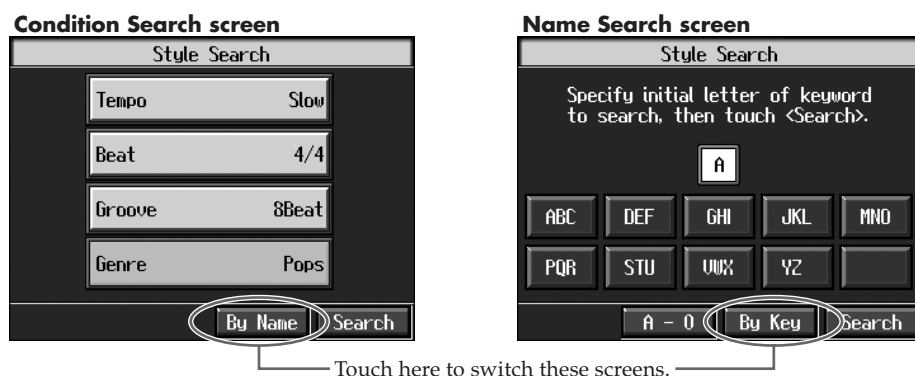

○ Searching by Conditions

3. Touch the parameter you want to set, then use the dial to select the search conditions.
4. Touch <Search>.

The search results appear in the display.

Touch a Music Style name to select a Music Style.

Press the [Exit] button to return to the Style Search screen.

○ Searching by Music Style Name

3. Touch <By Name>.
- Touch <By Key> to return to the Condition Search screen.

4. Decide which character you'll use for the search.

The selected character appears in the middle of the screen.

Enter the character you are searching for. For example, touching <ABC> in succession cycles you through the available choices in that character group (“A”→“B”→“C”...).

Touch <A-0> to toggle between alphabets and numerals.

5. Touch <Search>.

The search results appear on the display.

Touch a Music Style name to select a Music Style.

Press the [Exit] button several times to return to the Basic screen or the previous screen.



Only the KR's internal Music Styles are searchable.



In a condition search, the KR looks for Music Styles satisfying all of the selected search criteria.

■ Selecting Music Styles on External Memories

You can play other User Styles saved to external memories (sold separately) or User memory (p. 158).

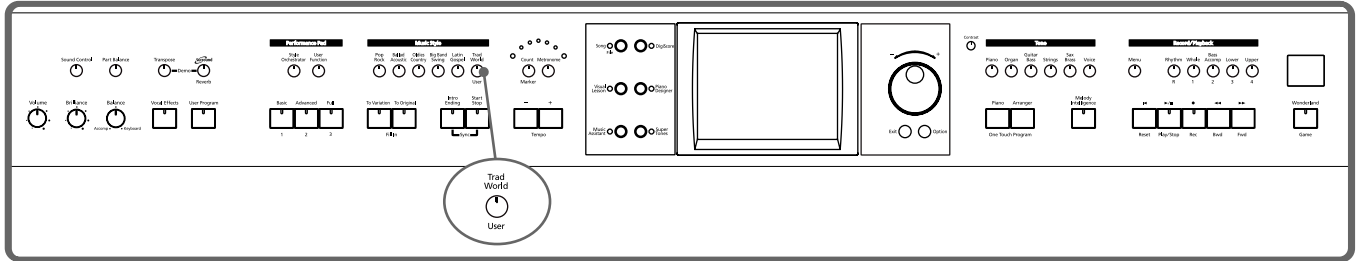

1. Press the Music Style [User] button.



2. Touch <User> in the lower left of the screen.

When you touch <User> on the lower part of the screen, the screen for selecting user memory or external memory Styles appears.

Touching <Preset> in the lower left of this screen returns you to the screen for selecting the “Trad/World” accompaniment Styles.

3. Touch <◀▶> <▶▶> to select the storage media to which the accompaniment Style is saved.

The names of the accompaniment styles stored on the selected storage media are displayed.

4. Select a Music Style, and touch the Music Style name.

5. Press the One Touch Program [Arranger] button.

You can now perform in the selected Music Style.

Music Styles selected from external memories are stored until the power is turned off. Even after ejecting the external memory, by pressing the Music Style [User] button, you can perform using the most recently selected Music Style.



You can save multiple user Styles to user memory. Take a look at “Saving a User Style” (p. 158).

Playing Only Music Style Rhythm Patterns

You can also play only the rhythm patterns of Music Styles.

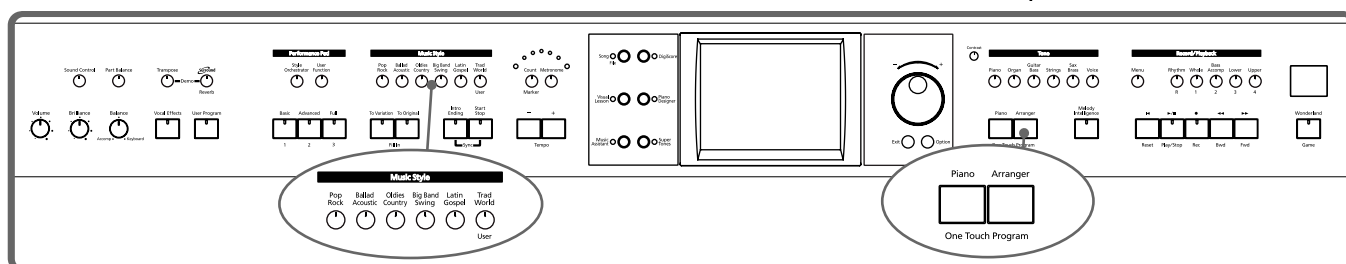

1. Select a Music Style (p. 61).

2. Press the One Touch Program [Piano] button.

The performance is set so that only the rhythm patterns are played.

3. Press the [Intro/Ending] button.

The Rhythm part of accompaniment begins, starting from the Intro.

Just as with regular Automatic Accompaniment, you can add intros and endings by pressing the [Intro/Ending] button, and make changes to the rhythm patterns with the Fill In button (p. 68).

NOTE

Some Music Styles do not include rhythm patterns. When you select these Style patterns, no rhythm patterns are played, even when you play on the left side of the keyboard.

Adjusting the Accompaniment Tempo

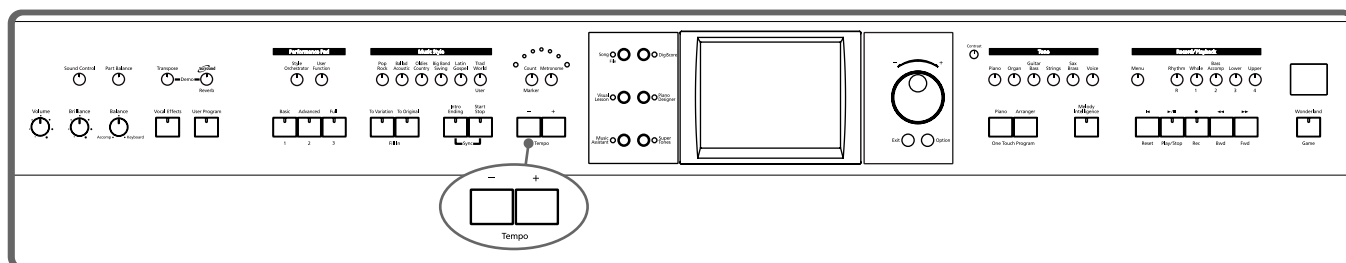

When the Basic screen is displayed, you can use the Tempo [-] [+] buttons or the dial to change the tempo.

The tempo is indicated on the upper left of the screen.



Pressing the Tempo [-] [+] buttons simultaneously returns the selected Music Style or song to the basic tempo.

You can change the tempo of Automatic Accompaniment even while the accompaniment is playing.

Starting and Stopping the Accompaniment

Pressing the One Touch Program [Arranger] button activates Sync Start for the accompaniment (which starts the accompaniment simultaneously when you play on the lower section of the keyboard), and automatically sets an appropriate intro for the accompaniment. You can also change the way the accompaniment starts and stops.

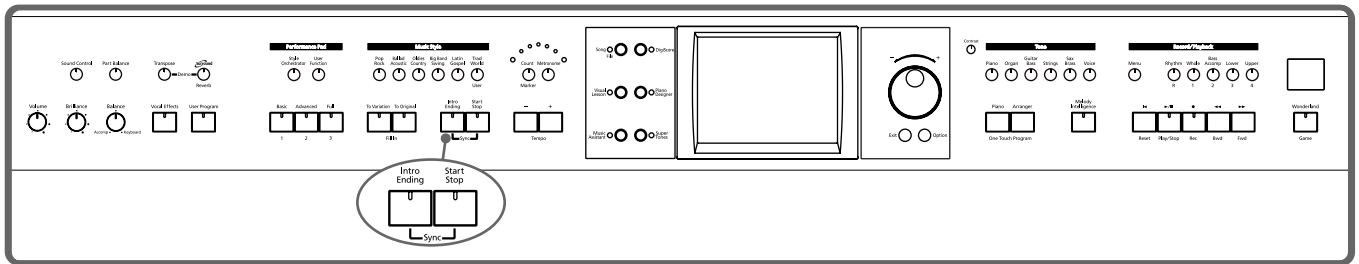

■ Having the Accompaniment Start Simultaneously When You Play the Keyboard (Sync Start)

1. Press the [Intro/Ending] button and [Start/Stop] button simultaneously, causing the indicators of both buttons to flash.

The Sync Start settings go into effect.

2. Play a chord on the lower-part of keyboard.

As you play the keys, the intro and accompaniment begins simultaneously.

○ Changing the Intro

When set for Sync Start (the indicators of both the [Intro/Ending] button and [Start/Stop] button are flashing), you can use the following procedure to change the intro, or prevent the intro from playing.

Starting without an Intro

Press the [Intro/Ending] button and watch the indicator go out.

Now when you play a chord with the keyboard, the accompaniment starts without the intro.

To Start with a Short Intro Added

Touch <Arranger> in the Basic screen to open the arranger screen.

Touch the Intro <2>.

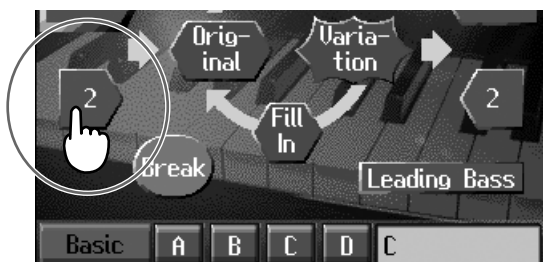

Now when you specify a chord with the keyboard, a short intro is played, and the accompaniment starts.



Sync Start is set immediately after the One Touch Program [Arranger] button is pressed.

Chapter 2 Automatic Accompaniment

○ Starting at the Press of a Button

1. Press the [Intro/Ending] button and [Start/Stop] button simultaneously, and the indicators lights go out.

The Sync Start function is cancelled.

2. Play a chord on the lower part of keyboard.

Choose the chord to be played when the accompaniment begins playing.

3. Press the [Intro/Ending] button or the [Start/Stop] button.

When you press the [Intro/Ending] button, the intro plays, and the accompaniment starts. When you press the [Start/Stop] button, the accompaniment starts without the intro.

When you touch Intro <2> on the Basic screen, a short intro plays.

Chord Tones and Bass Tones

When you play the keys in the left-hand side of the keyboard while the [Start/Stop] button's indicator is not lit, chords play. This note is called the "Chord Tone," and the root of the chord being played at the same time is called the "Bass Tone."



You can change the sound of the chord tone and bass tone. Take a look at "Changing How Chords Are Played and Specified (Arranger Config)" (p. 162).

■ Stopping Automatic Accompaniment

○ Stopping with an Added Ending

1. Press the [Intro/Ending] button.

An ending plays and the Automatic Accompaniment stops.

○ Stopping at the Same Time the Button is Pressed

1. Press the [Start/Stop] button.

The Automatic Accompaniment stops as soon as you press the button.

■ Having a Count Sound Play at the End of the Intro (Countdown)

If an intro plays before your performance, you can have a count-in sound played to the end of the intro, helping you hear when to start playing.

Ex: 4/4

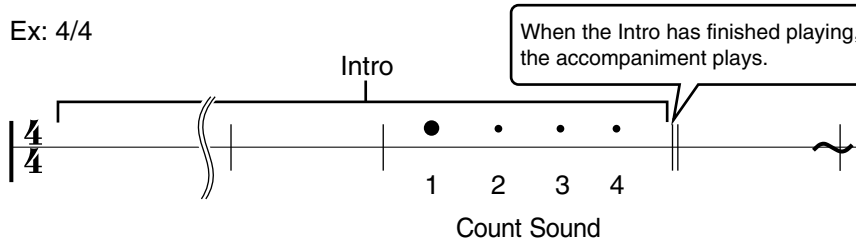

1. Press the [Count/Marker] button and watch the indicator light up.

The following "Count screen" appears.



2. Touch <Count Mode>   to set this to "Count Down" or "Count In/Down."

When you press the One Touch Program [Arranger] button, the performance starts, and the countdown sound plays at the end of the intro.

○ Cancelling the Countdown

3. Press the [Count/Marker] button and the indicator light goes out.

MEMO

When set to "Count In/Down," a count sound is added before playback of the song begins.

MEMO

For more about settings on the Countdown screen, refer to "Changing the Settings for the Count" (p. 164).

Modifying an Accompaniment

When you use Automatic Accompaniment, you can easily add Fill Ins to the accompaniment patterns, change arrangements, and make other changes.

■ Changing the Accompaniment Pattern (Fill In Buttons)

There are two accompaniment patterns: the Original, and a Variation. In addition, a fill-in (or short phrase) is added at the points where the accompaniment patterns change, which adds more interest to the song. It can be effective to use the simpler original pattern for the first half of the song, and the variation pattern for the second half.

What's a "Fill In"?

A short improvisational phrase inserted at the bar line is called a "Fill In." The KR automatically plays the appropriate phrase for the selected Music Style.



You can add variation to the Automatic Accompaniment by assigning different functions to the Performance Pads and pedals. For more information, see "Assigning Functions to Pedals and Performance Pads (Pedal Setting/User Functions)" (p. 167).

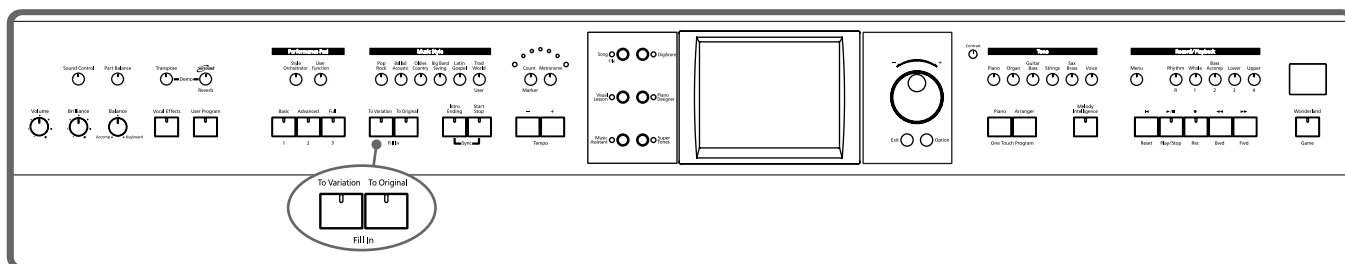

Press the Fill In [To Variation] button and watch the indicator light up.

The instrument is set so that the variation performance pattern is played.

Press the Fill In [To Original] button and watch the indicator light up.

The instrument is set so that the original performance pattern is played.

Pressing these buttons during a performance inserts a one-bar fill-in at the appropriate place and time.

Adding a Fill-in without Changing the Accompaniment Pattern

You can play only the fill-in, without changing the accompaniment pattern.

Press the lit [To Original] or [To Variation] Fill In button during the performance.

■ Changing Accompaniment Patterns in the Screen

You can change accompaniment patterns in intros, fill-ins, endings, and so on by touching the screen. This lets you enjoy even more advanced performances.

1. Press the One Touch [Arranger] button.

The Arranger basic screen is displayed.

2. Touch <Arranger>.

The following screen appears.

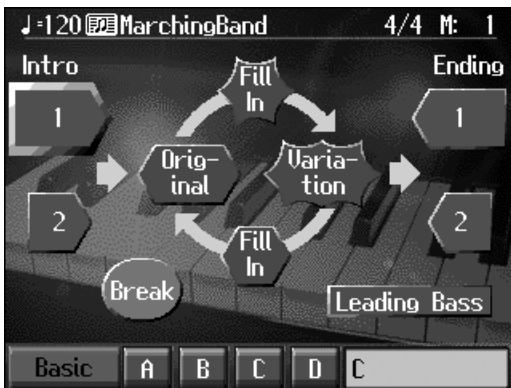

Touch the screen to change the accompaniment pattern.



For more information about leading bass, refer to p. 168.

■ Changing the Instrumental Makeup of Music Styles (Style Orchestrator)

You can change the arrangement of an accompaniment. This function is called “Style Orchestrator.” Each Music Style has three different accompaniment arrangements.

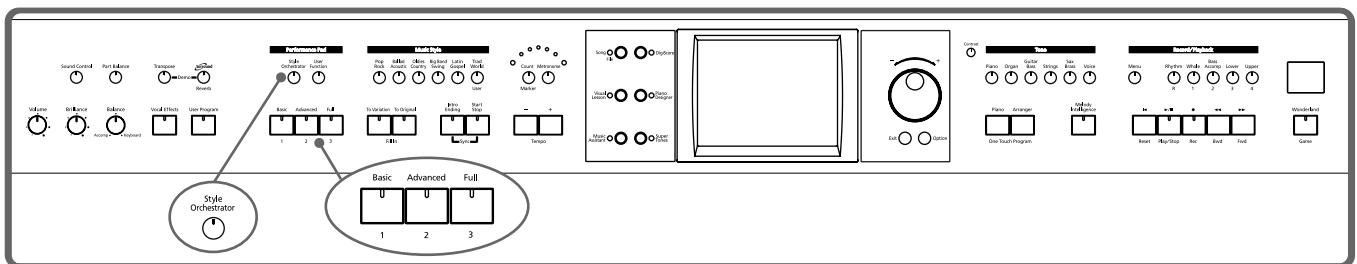

1. Press the [Style Orchestrator] button and watch the indicator light up.

The instrument is set to allow you to change the arrangement with the Performance Pads.

2. Press Performance Pad [1]–[3] to change the arrangement for the accompaniment.

Watch the indicator of the button you pressed light up.



When you press the [User Function] buttons, the [Style Orchestrator] button's indicator goes out, and the function of the Performance Pads changes. For details refer to p. 94 and p. 167.

Button	Explanation
1 (Basic)	This is the simplest arrangement.
2 (Advanced)	This is a more involved arrangement.
3 (Full)	This is the most elaborate arrangement.



When simple Music Styles are selected, there may be no change in the arrangement even when you use the Style Orchestrator function.

Adding Harmony to the Right-Hand Part (Melody Intelligence)

You can add harmony to the notes you play on the keyboard.

While an Automatic Accompaniment is playing, the matching harmony is automatically added to the notes you are playing with the right hand. This function is called “Melody Intelligence.”

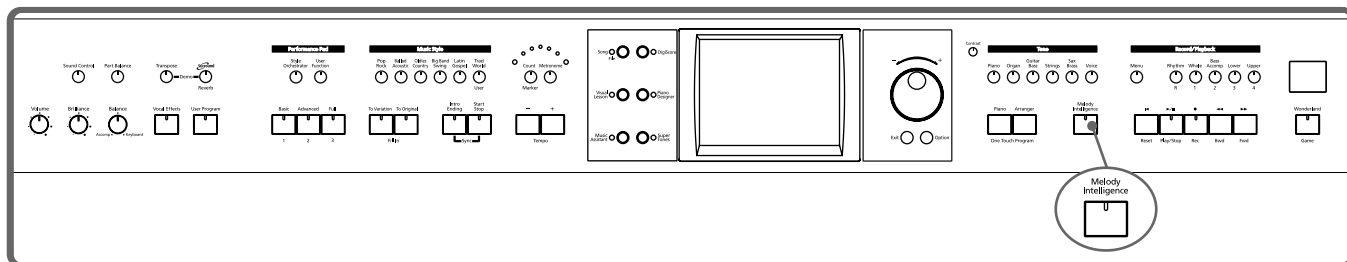

1. Press the [Melody Intelligence] button and watch the indicator light up.

When you play something on the right-hand section of the keyboard, harmony is added.

The following “Melody Intelligence screen” appears.



2. Select and touch a harmony type.

Then when you play a melody on the keyboard, a harmony style is automatically added.

When you press the [Exit] button, you’re returned to the previous screen, while the Melody Intelligence function remains selected.

3. Press the [Melody Intelligence] button once more and the indicator light goes out.

The Melody Intelligence function is cancelled.



With some harmonies, Tones may change automatically. Also, when you play several keys at the same time, in some cases harmony may be added to one note.

Playing Sounds in the Left Hand During a Performance (Lower Tone)

Normally, when using Automatic Accompaniment in a performance, sounds are not produced by playing the left-hand part of the keyboard. When you touch the <Lower 1> or <Lower 2> icon, you can have Tones from the left side of the keyboard play simultaneously with the Automatic Accompaniment.

1. Press the One Touch Program [Arranger] button.

This sets the Automatic Accompaniment.

2. On the Basic screen, touch <Lower 1>.

Now when you play a chord in the left-hand keyboard area, the notes you play will sound, and the accompaniment chord changes.

In the same manner, you can play the lower tone by touching <Lower 2>.

By touching both <Lower 1> and <Lower 2>, you can get a Layer performance for the left-hand.



Stopping the Sound in the Left-hand

3. Touch <Lower 1>.

The <Lower 1> icon returns to the original color.

To have <Lower 2> play as well, also touch <Lower 2>.

The lower Tones stop playing.

Playing the Piano with Accompaniment Added (Piano Style Arranger)

Usually with Automatic Accompaniment, you play chords on the left-hand side of the keyboard and the melody on the right-hand side. Chords can also be recognized over the entire keyboard, allowing you to perform using Automatic Accompaniment without splitting the keyboard. This function is called “Piano Style Arranger.”

This makes it possible to add an accompaniment automatically as you play a song by playing chords in the ordinary way, without giving any thought to the location of a keyboard split.

1. Press the One Touch Program [Arranger] button.
2. Touch <Split> to turn the Split function off.



3. Select a Music Style (p. 61).
4. Play the keyboard.

The accompaniment starts when you play a chord anywhere on the keyboard.

Adjusting the Volume Balance for Each Part (Balance)

You can adjust the volume balance between the accompaniment and the keyboard, and the volume balance for each of the parts in a Music Style.

■ Changing the Volume Balance Between the Accompaniment and the Keyboard (Balance Knob)

You can change the volume balance between a song and accompaniment and the notes you play on the keyboard.

1. Adjust the volume balance with the Balance knob.

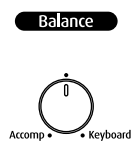

NOTE

When this knob is turned completely to the Accompaniment side, no sounds from the keyboard are audible, even when the keys are pressed. You can usually leave the knob at the center position.

■ Adjusting the Volume Balance for Each Performance Part (Part Balance)

You can adjust the volume of each performance part in a Music Style, and the balance between parts when playing multiple Tones on the keyboard.

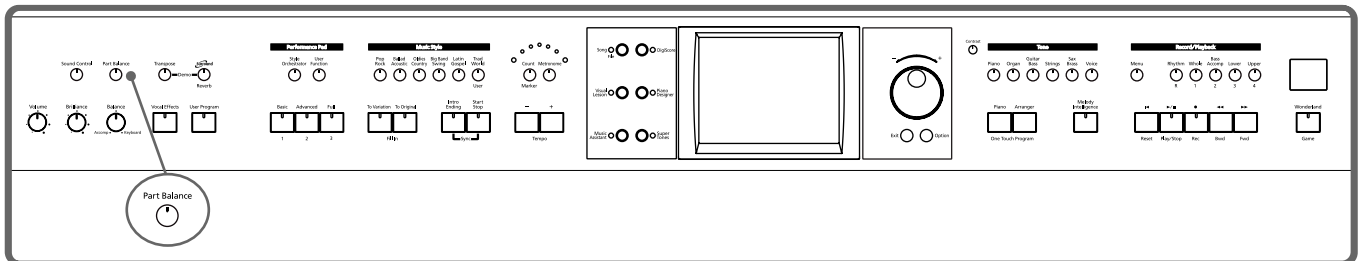

1. Press the [Part Balance] button and watch the indicator light up.

The following "Part Balance screen" appears.



Switch the screens

Chapter 2 Automatic Accompaniment

The volume balance between the performance parts in the Music Style is indicated.

Display	Performance part
Rhythm	Music Style Rhythm Part
Bass	Music Style Bass Part
Accomp1	Accompaniment 1–6
Accomp2	
Accomp3	
Accomp4	
Accomp5	
Accomp6	
Chord Tone	Chord Tone (p. 66)
Bass Tone	Bass Tone (p. 66)
WAV	Audio File
CD (Only with models featuring CD Drive)	Audio CD

When you touch <Keyboard>, a screen like the following appears.

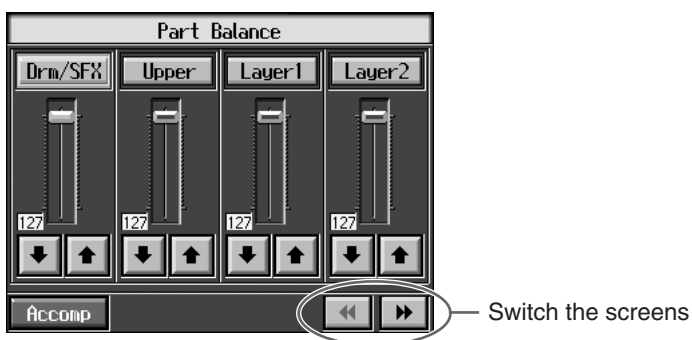

This shows the volume balance between the keyboard's Tones when either layer performance (p. 31) or split performance (p. 32) are used, or the volume balance when using the keyboard to play percussion instruments or sound effects (p. 29).

Displayed	Tone Part
Drum/SFX	Percussion instruments or sound effects played with the keys
Upper	Upper Tone
Lower 1	Lower Tone 1
Lower 2	Lower Tone 2
Layer 1	Layer Tone 1
Layer 2	Layer Tone 2

When you touch <Accomp>, you return to the screen for setting the accompaniment Style volume balance.

Chapter 3 Song Playback

Playing a Song

Now, let's try practicing while playing back internal songs, commercial music files, and songs saved to external memories.

You can use rewind or fast-forward to go to any desired measure, and play back from that point.

You can also play audio files (p. 80).

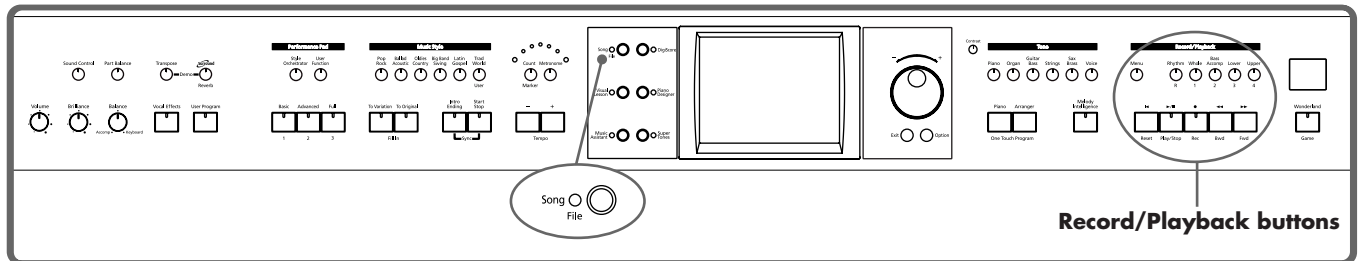

Selecting the Song

When playing back songs on optional external memory, first connect the external memory to the external memory port.

1. Press the [Song] button.

The following "Song Selection screen" appears.



Touch and drag up and down in the scroll bar to scroll through the screen and display other songs.

Touch the page icons < > < > to change pages.

Finger : The fingering is included in the notation.

Chord : The chords are indicated in the notation.

Lyric : You can display song lyrics.

Audio : For audio files.

When you touch < >, songs selected from all of the internal songs are played in random order.



When you touch < >, all of the songs in the genre you have selected are played in order, starting from the selected song. When the last song is finished, playback resumes from the first song in the genre.

MEMO



About Random Performances

When "Favorites" is selected as the genre, songs registered in "Favorites" are played back in random order.

When "External Memory" is selected as the genre, the songs in the folder appearing on the screen are played back in random order.

<  >: The selected song is played back. This changes to <  > while the song is played back; playback stops when you touch <  >.

By touching <File>, you can then view information about the song (p. 182) and save songs to external memory (p. 116).

2. Touch <  > <  > to select the song genre.

3. Touch the name of the song to be played back.

You use and the dial to select songs.

Playing back

4. Press the [] (Play/Stop) button.

The button indicator lights up, and playback of the song begins.

Stopping the Song

5. Press the [] (Play/Stop) button once again.

The button indicator light goes out, and the song stops.

When the song is finished, playback stops automatically.

Press the [] (Reset) button to return to the beginning of the song.

Record/Playback Buttons

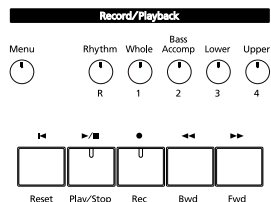

Track buttons (Rhythm, Whole, Bass/Accomp, Lower, Upper):

Each performance part of the song being played back is assigned to a track button. Use these buttons to select the performance parts that are muted or played. For more detailed information, refer to p. 97.

[] (Reset) button: Returns to the beginning of the song.



[] (Play/Stop) button:

Plays back the song, or if the song is currently being played, it stops the song.

[] (Rec) button: Records the performance. For more detailed information, refer to p. 104.

[] (Bwd) button: Moves back the playback position of the song one measure each time the button is pressed. Moves back the playback position of the song one second each when an audio file is being played back. When held down, the song “rewinds” continuously.

[] (Fwd) button: Advances the playback position of the song one measure each time the button is pressed. Advances the playback position of the song one second each when an audio file is being played back. When held down, the song is forwarded continuously.

Holding down the [] (Play/Stop) button and pressing the [] (Fwd) button moves you to the end of the song.

MEMO

If there is recorded song data, the “Delete song” screen appears.

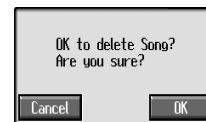

If it’s okay to delete the song, touch <OK>. If you do not want to delete the song, touch <Cancel>, and either save the song to a external memory (p. 116) or register the song to the Favorites (p. 82).

NOTE

When you select a song, the measure number in the Basic screen is highlighted. The performance data is being loaded while the indication is highlighted; please wait a few moments for this to be completed.

NOTE

When using markers to specify a section to be repeated (p. 101), you can rewind and fast forward only within the range between Marker A and Marker B.

■ Listening to Songs on CDs (Only for Instrument Equipped with CD Drive)

Cautions

Handling CDs

- Do not leave discs exposed to direct sunlight for extended periods.
- Handle CDs with your finger and thumb, holding the disc by the center hole and outer rim. Do not touch or scratch the disc's recording surface (the green side).
- Do not drop or stack discs.
- Do not place heavy objects on discs or subject them to strong impact.
- Do not affix stickers or other such materials on the label side. Placing stickers on the disc may result in errors when data writing and scratch the disc.
- Use a felt-tip marker or other soft-tipped implement to write titles and other information on the label side of discs.
- Store discs in their original cases or other suitable cases for protection.
- Before using the CD, please read the warning on the CD cover.

Cleaning Discs

- If a disc becomes dusty or soiled, gently wipe the disc with a soft cloth. Always wipe outwards from the center using light, gentle strokes. Do not wipe the disk in a circular pattern.

Precautions Concerning Use of the CD

- CD-R/RW discs to which audio tracks have been added, and CDs with mixed audio tracks and data will not play back properly.
- The KR is capable of playing back only commercial CDs that conform the official standards-those that carry the "COMPACT DISC DIGITAL AUDIO" logo. The usability and sound quality of audio discs that incorporate copyright protection technology and other non-standard CDs cannot be guaranteed.
- For more detailed information on audio discs featuring copyright protection technology and other non-standard CDs, please consult the disc vendor.
- You cannot save songs and styles to CDs, and you cannot delete songs or styles recorded to CDs. Furthermore, you cannot format CDs.
- The prescribed format for CD-R/RW discs is "ISO9660 Level 1 Mode 1."
- You may be unable to read using other formats.

CDs That Can Be Played Back

- Commercially available audio CDs
- CD-ROMs containing saved SMF music files
- CD included with the KR
- Player piano CDs
- CDs created with the A/V Sync function (p. 122)

NOTE

You may not be able to play back certain commercially available player piano CDs.

Chapter 3 Song Playback

Insert the CD in the CD Drive

1. Press the eject button and open a disc tray.

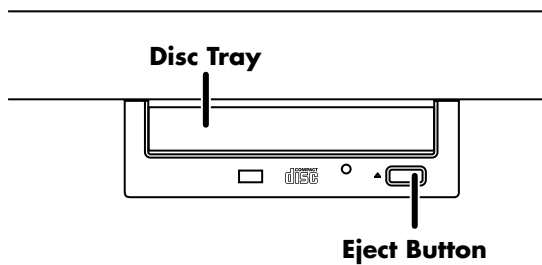

2. Put a CD on a disc tray.
3. Press the eject button again to close the disc tray.

Removing a CD

1. Press the eject button and open a disc tray.
2. Remove the CD from the disc tray.

If a disc tray does not open

If the power is turned off with the disc still in the drive (such as due to a power failure), the disc tray cannot be opened by pressing the eject button. In this case, you can insert a piece of wire to force the tray open.

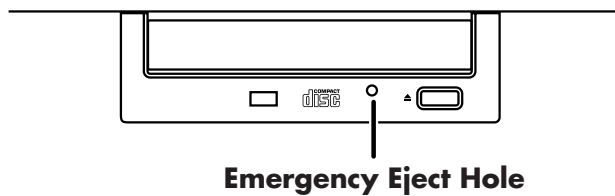



Make sure the KR's power has been turned OFF before attempting to engage the emergency eject hole. If you insert something while the power is on, the disc could be damaged, or unexpected problems may occur.

Playing Back Songs on CDs

You can play back the CD included with the KR, CDs with player piano CDs, audio CDs, and CD-ROMs to which SMF music files are saved.

1. Place the CD you want to play in the CD drive.

2. Touch   to select "CD" as the genre.

If using the remote control, press the remote control's [EXTERNAL] button, then select "CD" as the genre.

3. Press the [▶/■] button to start playback of the CD's songs.

The songs on the CD are played.

When the KR is set to play back all songs (p. 75), once the song currently being played back is finished, the next song starts playing automatically. After all of the songs on the CD have been played, playback automatically resumes from the beginning of the CD. When the KR is set to play back a single song (p. 75), playback stops automatically when the song is finished.

4. Press the [▶/■] button once more to stop playback of the songs.

When Selecting Songs in Folders

1. Touch the folder name.
2. Touch  (Play) at the bottom left of the screen.

After a moment, a list of songs in the folder is displayed.

You can also select the folder using the dial or the [◀◀ (Bwd)] or [▶▶ (Fwd)] button on the remote; the folder can then be opened by pressing the [▶/■ (PLAY)] button.

3. Touch a song from the list that appears to select the song you want to play back.

* Depending on the number of songs contained in a folder, this may take some time.

NOTE

If there is any song data already recorded, a screen appears asking you to confirm that the song is to be erased. If you do not mind erasing the data, touch <OK>. If you do not want to erase the data, touch <Cancel>, and either save the song data to the Favorites or to external memory (p. 116)

NOTE

If a folder contains 500 or more files and/or folders, some of the files and folders may not be displayed.

About Audio Files

Audio files in the following format can be played back:

- “.WAV” extension
- 16 bit linear
- Sampling rate of “44.1 kHz”
- Stereo

You cannot use the following functions in playing back audio files.

- Marker (p. 98)
- Displaying notations (p. 87)
- Registering “Favorites” (p. 82)
- Transposing (p. 102)
- Changing tempos (p. 94)
- Track Mute (p. 97)
- Recording (p. 105)
- Search (p. 81)

*** Saving or performing other procedures during playback of audio files may cause the song to stop while it is playing.**

■ Using Keywords to Search for Songs (Song Search)

You can search for songs that match the conditions you set regarding the song tempo or genre.

You can also search the songs using the first character of the song name.



Only the KR's internal songs are searchable.

1. Press the [Song] button.

2. Touch < >.

The following "Song Search screen" appears.

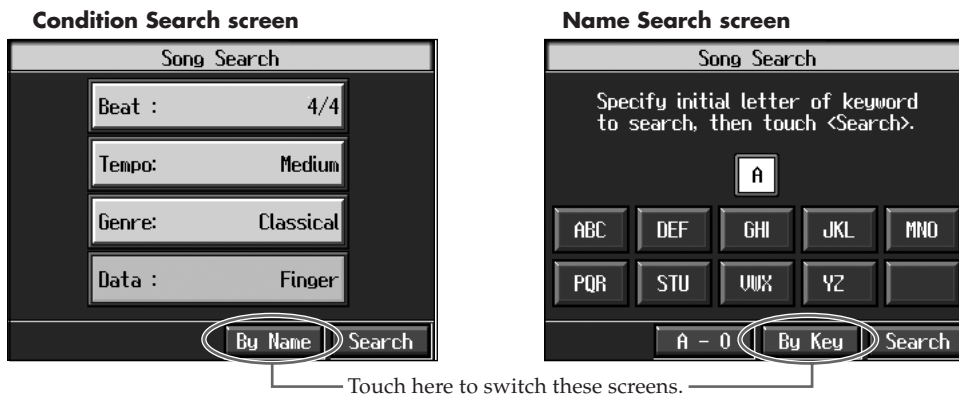

○ Searching by Conditions

3. Touch the parameter you want to set, then use the dial to select the search conditions.

With <Data>, songs are searched according to data included in the internal songs. You can use four different criteria in searches: "Lyrics," "Chords," "Finger" (fingering numbers), and "Any." By selecting a song containing any of this data, then displaying it in the KR's notation, you can display information about the selected data.

4. Touch <Search>.

The search results appear in the display.

Touch the song name to select the song.

Press the [Exit] button to return to the Song Selection screen.

○ Searching by Song Name

3. Touch <By Name>.

Touch <By Key> to return to the Condition Search screen.

4. Decide which character you will use for the search.

The selected character appears in the middle of the screen.

Enter the character you are searching for. For example, touching <ABC> in succession cycles you through the available choices in that character group ("A" → "B" → "C" ...).

Touch <A-0> to toggle between alphabets and numerals.

5. Touch <Search>.

The search results appear in the display.

Touch the song name to select the song.

Press the [Exit] button several times to return to the previous screen.

Registering the Songs You Like (Favorites)

You can register songs you are currently practicing or enjoy playing to “Favorites,” allowing you to select these songs easily.

Selecting the Song

1. Press the [Song] button.

The Song Selection screen appears (p. 75).



2. Touch the song name to select the song to be registered.

Registering to Favorites

3. Touch <Favorites>.

A screen like the one shown below appears.



4. Touch <OK>.

The selected song is registered to Favorites.

Now you can select the registered song by selecting Favorites for the genre in the Song Selection screen.

MEMO

You can also register songs on external memory to the Favorites. For details, refer to “Copying Songs on External Memories to Favorites” (p. 120).

NOTE

You cannot register audio files and audio CD to the Favorites.

■ Removing Songs From Favorites

This deletes registered songs for Favorites.

1. Touch <◀▶><▶▶> in the Song Selection screen to select the “Favorites” from the genre category.



2. Touch the name of the song to be deleted.
3. Touch <Delete>.

A screen like the one shown below appears.



4. Touch <OK>.

The song is deleted.

Using the Remote Control

You can use the included remote control to easily start and stop performances and switch songs.

■ How to Use the Remote Control

When using the remote control, aim the remote control at the infrared receiver, keeping in mind the range of operation (below).

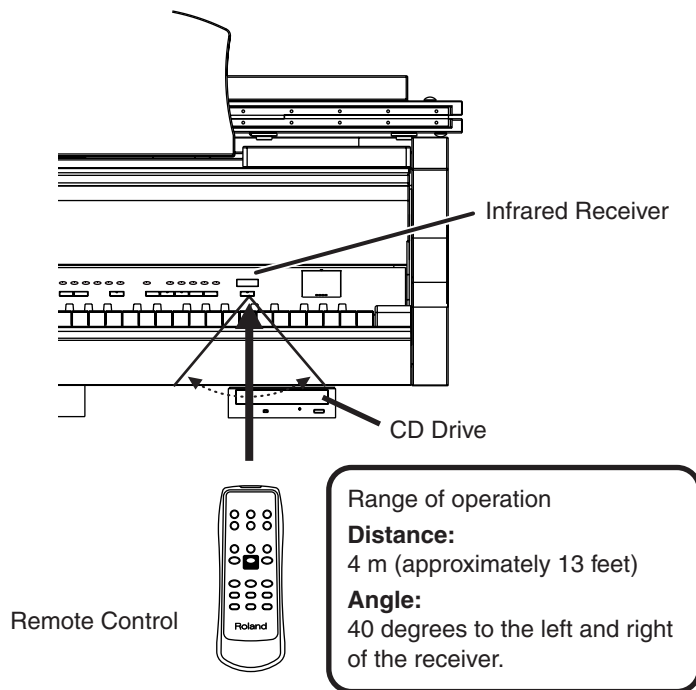

Precautions Concerning Use of the Remote Control

- The remote control is able to transmit only one operation at a time.
- The remote control may not operate even within the range of operation if there is an obstacle between it and the main unit.
- Using the remote control near other equipment that uses remote control systems may result in operational errors.
- The life of the battery depends on the amount and conditions of use. If the operational range of the remote control decreases, change the batteries.
- If you will not be using the remote control for a long period of time, remove the batteries.
- The remote's response may suffer if the remote's sensor is situated under spotlights or exposed to other such strong lighting.



Refer to "Installing Batteries in the Remote Control" (p. 20).



Information from the remote is not received when Remote Sensor setting is switched off. Refer to "Switching ON/OFF of the Remote Control" (p. 172).

■ About the Remote Control

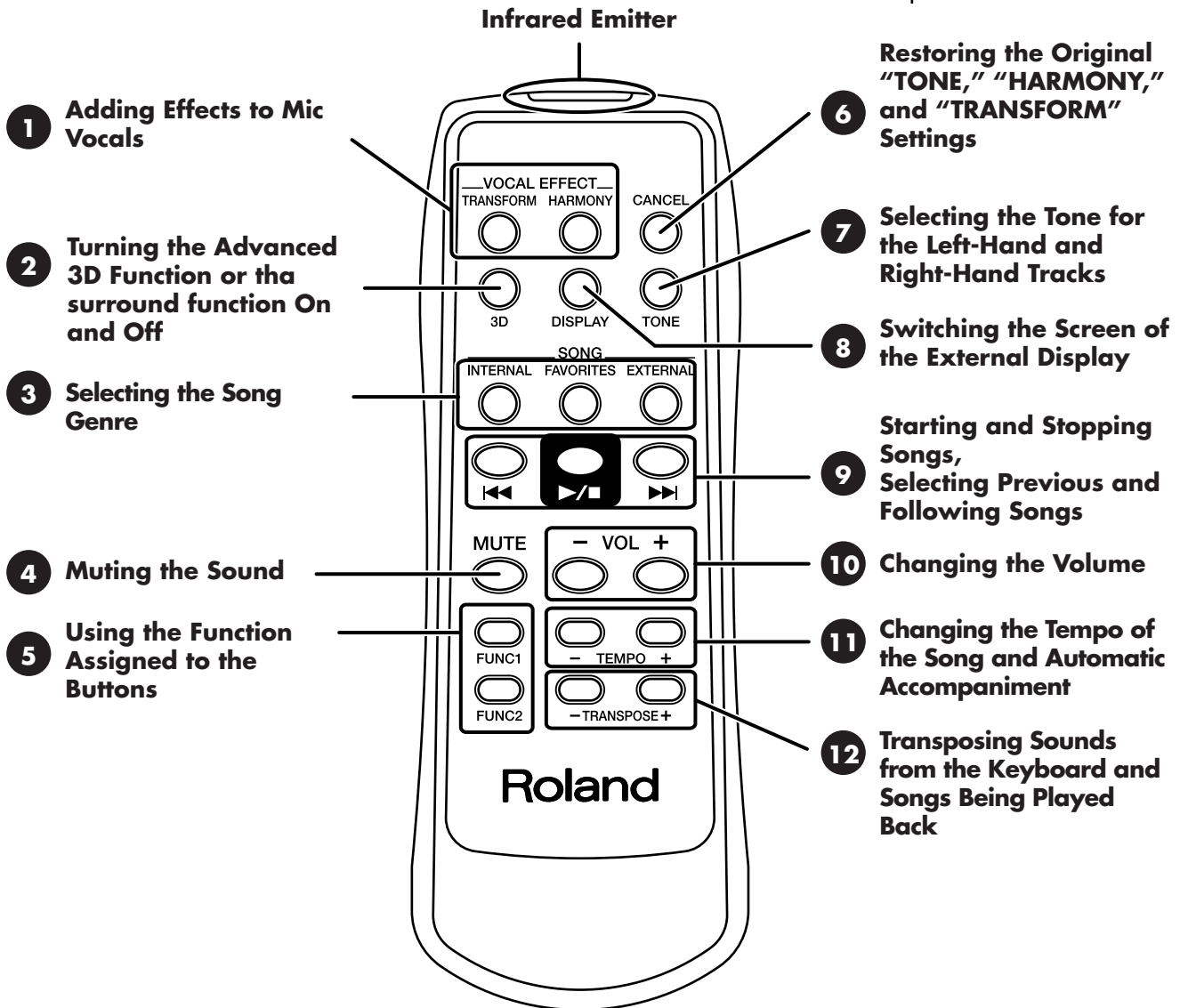

You can also switch the functions for the [▶/■] (Play/Stop) button, the [FUNC 1] [FUNC 2] button, the TEMPO [-] [+] button, and the TRANSPOSE [-] [+] button. Please refer to "Changing the Functions of the Remote Control's Buttons" (p. 172).

	Button	Explanation
1	TRANSFORM	This changes the vocals from the mic. The setting switches each time you press the button, cycling through male, female, Kids, and normal voice settings.
	HARMONY	This adds harmonies to the mic vocals. The harmony setting switches each time you press the button, cycling through Music Files (p. 52), Oct-Up (p. 49), Oct-Down (p. 49), and normal voice settings.
2	3D	This adds greater breadth to the sound. Pressing this button toggles the Surround effect and the Advanced 3D effect on and off.
3	INTERNAL	This switches the genres of the internal songs.
	FAVORITES	Selects songs in the "Favorites."
	EXTERNAL	When you press the button with external memory or a disk connected or CD, the connected storage media is selected.
4	MUTE	This mutes all of the sounds.
5	FUNC1, FUNC2	You can use the function assigned to this button. You can also change the function assigned to the button (p. 172).
6	CANCEL	The settings for the [TONE] button, [HARMONY] button, and [TRANSFORM] button are restored to their original values. The left and right tracks switch to a piano tone.
7	TONE	Pressing the button successively changes tone of the Lower track, Upper track, and User track.
8	DISPLAY	Each press of the button takes you to the next selection among the available choices, which are, in order: panel, notations, notations+keyboard, lyrics, slide show. You can press the [DISPLAY] button while the Tempo screen or Volume screen is displayed to clear the Tempo screen or Volume screen. * Some songs may not feature screens with lyrics.
9	⏮	Pressing the [⏮] button at the beginning of the song selects the previous song. Pressing the [⏮] button at a point other than the beginning of the song returns you to the beginning of the song.
	▶/■	This starts and stops playback of the song. Playback alternately starts and stops each time you press the [▶/■] button. You can also assign functions to the button (p. 172).
	⏭	When you press the [⏭] button, the next song is selected.
10	VOL - + (Volume)	You can adjust the volume.
11	TEMPO - +	This adjusts the tempo. You can also assign functions to the button (p. 172).
12	TRANSPOSE - +	This transposing sounds from the keyboard and songs being played back. You can also assign functions to the button (p. 172).

Chapter 4 Practice Functions

With the KR, you can enjoy practice using a variety of functions.

Displaying the Notation

The KR can display notations not only for the internal songs, but for music files and performances recorded with the KR. This is very convenient for performing while reading the music and for checking songs that have been recorded. When you play back a music file with lyrics, the lyrics appear on screen.

Selecting the song

When playing back songs on external memories, first connect the external memory to the external memory port.

1. Press the [Song] button to select a song.

For details refer to "Playing a Song" (p. 75).

2. Press the [DigiScore] button.

The "Notation screen" appears.

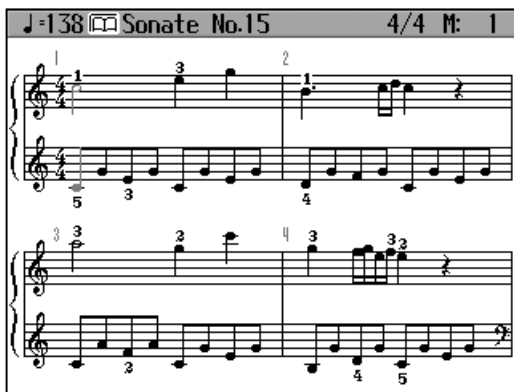

3. Press the [▶/■] (Play/Stop) button.

Playback of the song begins, and the notation advances along with the progression of the performance.

Notes Regarding the Notation Display

- Since the displayed notation data is read from external memory or the internal memory, some time may be required for the notation to be displayed.
- The displayed notations are based on music files. Priority is placed on the readability of the displayed music, not on the accurate rendition of difficult, high-level performances. Thus, there may be discrepancies seen when compared with commercially available printed music. The display is not intended for viewing advanced songs requiring precisely detailed notations, or complex songs.
- On the notation display screen, lyrics and notes may extend beyond the range displayed on the screen and may not be visible.
- Playback may start over from the beginning if you display the notation or change the displayed part during playback of the song.

MEMO

Using "Visual Lesson," you can select practice songs suited to your skill level.

Additionally, you can have the results your performance indicated in points and check the content in the notation.

Refer to the Quick Start.

MEMO

In some internal songs, the fingering is displayed.

The fingering numbers shown in the screen indicate one possible fingering.

MEMO

Chord names can be displayed in some of the internal songs and recorded performances using the KR's Chord Sequencer (p. 143).

MEMO

You can make more advanced settings for the notation by pressing the [Option] button.

NOTE

No notes are shown in the notation if the selected part contains no data. To change the part being displayed, refer to "Making Detailed Settings for the Notation Display" (p. 89).

NOTE

You cannot display the notation for audio files nor audio CD's song.

■ Touching Notes to Confirm the Sounds

(Touch the Notes)



In the Notation screen, you can have notes played by touching the notes on the screen.

When you display the keyboard in the screen (p. 90), the keys on the keyboard for the notes you touch are then shown in the display. This allows you confirm notes by sight, sound, and touch.

In addition, when you trace part of the notation with your finger, the traced segment is played back. This allows you to easily play back phrases you like.

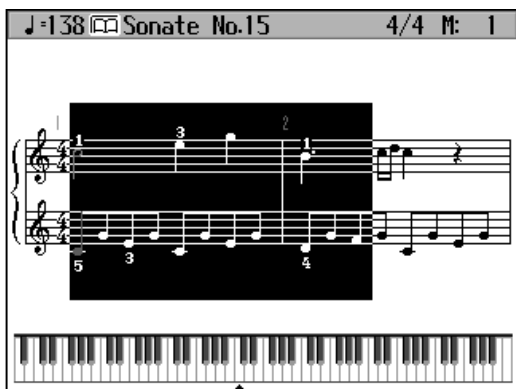

■ Scrolling the Notation Along with the Performances (AutoSync DigiScore)

You can have the notation displayed in the screen scroll automatically as you play, even when the song is not being played back. No more frantically trying to turn to the next page in the notation while you are performing.

This also lets you play difficult passages more slowly and otherwise practice at your own pace.

* *Auto Sync DigiScore is linked to the performance of the part shown in the screen. The notation does not scroll if you are playing a part that is not currently displayed.*

When the Bouncing Ball is Blue

Start playing at the point where the ball is bouncing.

The bouncing ball follows along and the notation scrolls as you play.

When the Bouncing Ball is Red.

If nothing is played for a short while, the bouncing ball turns red. At this time, if you play a phrase near the position of the bouncing ball, the ball automatically moves to the point in the notation where you are playing.



You can change the AutoSync DigiScore settings. Refer to p. 90.

When you play four or more notes while the bouncing ball is red, the ball moves to the point where you are playing.

When you play fewer than four notes, the bouncing ball does not jump to the new position, and the notation does not scroll.

The bouncing ball will move within the range of the notation displayed on the external display or television. If you start playing at a point that is not currently shown in the external display or television, the bouncing ball does not jump to the new position, and the notation does not scroll.

MEMO

Under certain conditions, the bouncing ball may not move as expected.

■ Making Detailed Settings for the Notation Display

You can change the part appearing on the notation display and change the manner in which the notation is displayed.

1. Press the [DigiScore] button to display the Notation screen.

2. Press the [Option] button.

A screen like the one shown below appears.



— Switch the screens

You can select the parts to be displayed in the notation by touching the four icons at the lower left of the screen.

Icon	Description
	The upper part and lower part are displayed.
	The upper part is displayed.
	The lower part is displayed.
	The User part is displayed.

You can also touch <Export> to save the notation as an image file (p. 92).

NOTE

You can change the parts to be displayed when you touch each of the icons (p. 91).

MEMO

In some internal songs, the fingering is displayed. The fingering numbers shown in the screen indicate one possible fingering.

MEMO

Chord names can be displayed in some of the internal songs and recorded performances using the KR's Chord Sequencer (p. 144).

Chapter 4 Practice Functions

3. Touch for the parameter being set to select the value.

Press the [Exit] button to return to the Notation screen.

Item	Setting	
Zoom Sets whether or not the enlarged notation is displayed.	On	Displays an enlarged notation.
	Off	Displays the notation at the normal size.
Keyboard Sets whether the keyboard is displayed beneath the notation.	On	Displayed.
	Off	Not displayed.
AutoSync DigiScore Sets the function whereby the notation screen scrolls automatically as you play, even if the song is not played back.	Off	The notation screen does not scroll automatically.
	Jump	The notation screen scrolls automatically. When the bouncing ball is blue, playback begins from the point in the notation where the ball is set. When the bouncing ball is red, and you start playing a phrase at a point in the notation close to where the ball is located, the ball moves to the point where you are playing. This position is determined after you play at least four notes of the phrase.
	Next Note	The notation screen scrolls automatically from the current position in the song as you play.
Lyrics This setting determines whether or not lyrics in songs that contain lyrics data appear in the notation.	On	The lyrics are displayed.
	Off	Not displayed.
Finger Numbers This setting determines whether or not the fingering in songs that contain fingering data appears in the notation.	On	The fingering is displayed.
	Off	Not displayed.
Chords This setting determines whether or not chord names in songs that contain chord data appears in the notation.	On	The chord names are displayed.
	Off	Not displayed.
Pitches Sets whether or not the note names appear in the music when the notation is expanded.	Off	Not displayed.
	C, D, E	The pitch names (C, D, E) are displayed.
	Do, Re, Mi (Fixed)	The pitch names (fixed Do) are displayed.
	Do, Re, Mi (Movable)	The syllable names (movable Do) are displayed.

Item	Setting	
Pedal Sets the pedal function.	Basic	Controls each of the pedal movements.
	Replay	You can start and stop playback of song data with the left pedal. Pressing the pedal in rapid succession moves you back in the song the number of measures equal to the number of times you press the pedal, after which playback resumes. This allows you to use the pedal to rewind quickly, a useful feature when, for example, you want to repeatedly listen to a difficult phrase.
	Page1	Scrolls the notation in the KR's display. Pressing the center pedal scrolls to the next page. Pressing the left pedal scrolls to the previous page.
	Page2	Scrolls the notation in the external display. Pressing the center pedal scrolls to the next page. Pressing the left pedal scrolls to the previous page.
Resolution Sets the minimum note length indicated in the notation.	16th note	Notes down to sixteenth notes are indicated.
	32nd note	Notes down to thirty-second notes are indicated.
Clef L Determines whether a treble or bass clef is shown in the notation for the lower part.	Auto	Display is switched automatically.
	G Clef	G (treble) clef is displayed in the notation.
	F Clef	F (bass) clef is displayed in the notation.
Clef R Determines whether treble or bass clef is shown in the notation for the upper part.	Auto	Display is switched automatically.
	G Clef	G (treble) clef is displayed in the notation.
	F Clef	F (bass) clef is displayed in the notation.
Key Notation is displayed in the specified key.	Auto	Key is switched automatically.
	# x 6 - 0 - b x 5	Notation is displayed in the specified key.

Item	Setting
User Part Selects the part to display when "User" is selected as the part to be displayed.	User Track, Parts 1-16
Lower Part Selects the part to display when "Lower" is selected as the part to be displayed.	Lower Track, Parts 1-16
Upper Part Selects the part to display when "Upper" is selected as the part to be displayed.	Upper Track, Part 1-16

Item	Setting	
Bouncing Ball This setting determines whether or not the animated ball is shown bouncing in time with the song as it is played back.	On	Displayed.
	Off	Not displayed.
Color Notation This settings determines whether or not the note in the current position is colored.	On	The note is displayed in color.
	Off	Not displayed.

■ Saving Notations as Image Data

You can take notations that are displayed on the KR and save them to external memories. You can also use saved image data to your computer.

- 1.** Insert the external memory onto which you want to save the image data in the KR's external memory port.
- 2.** Record the performance (p. 105).
Alternatively, press the [Song] button to select a song.
- 3.** Press the [DigiScore] button.
The Notation screen appears.
- 4.** Press the [Option] button.
- 5.** Touch <Export>.

A screen like the one shown below appears.

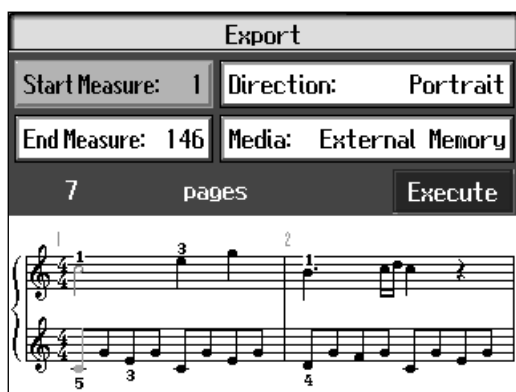

NOTE

Other than for your own personal enjoyment, use of the notations that are output without the permission of the copyright holder is prohibited by law.

- 6.** Touch the respective parameter and set the range of image data and other settings with the dial.

Item	Setting	Description
Start measure	1, 2-	Selects the measure at which output begins.
End Measure	- song end	Selects the measure at which output ends.
Direction	Portrait, Landscape	Sets the orientation of the notation being output.
Media	External Memory, Disk	Selects the media for the save destination.

- 7.** Touch <Execute>.

The notation is saved to the external memory as image data in BMP (bitmap) format.

- * You cannot save copyrighted song data.
- * Other than for your own personal enjoyment, use of the notations that are output without the permission of the copyright holder is prohibited by law.

Saving Your Visual Lesson Performance Results

When you practice with Visual Lesson, the notation showing the model performance appears in the screen above the notation for your own performance. You can save these notation in BMP (bitmap) format.

- 1.** While in the “performance results confirmation screen” in Visual Lesson, press the [Option] button.
- 2.** Touch the parameter whose setting you want to change.
- 3.** Set the value with the dial.
- 4.** Touch <Execute>.

NOTE

Do not remove the external memory while “save” is in progress.

Adjusting the Tempo

This changes the song and Music Style tempos.

If songs seem difficult to play at their original speed, you may find it helpful to first practice with the tempo slowed down. Then, after becoming more familiar with the song, you can practice it at a gradually faster tempo.

Changing the tempo has no effect on the pitch of the notes. And you can change the tempo even when the song is in progress.

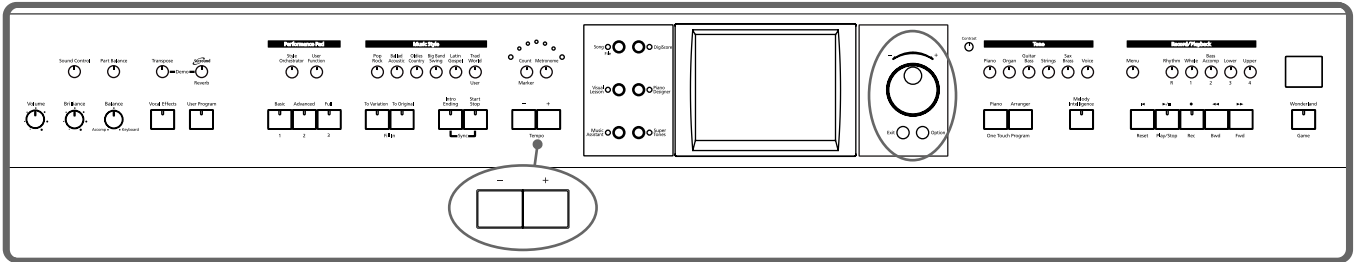

Adjusting the Tempo with the Tempo [-] [+] Buttons

Pressing the [+] button once increases the tempo by one unit. Holding down the button makes the tempo increase continuously.

Pressing the [-] button once decreases the tempo by one unit. Holding down the button makes the tempo decrease continuously.

Pressing the [-] [+] buttons simultaneously returns the selected Music Style or song to the basic tempo.

NOTE

You can not adjust the audio files' tempo and audio CDs' tempo.

■ Setting the Tempo by Pressing the Button in Time (Tap Tempo)

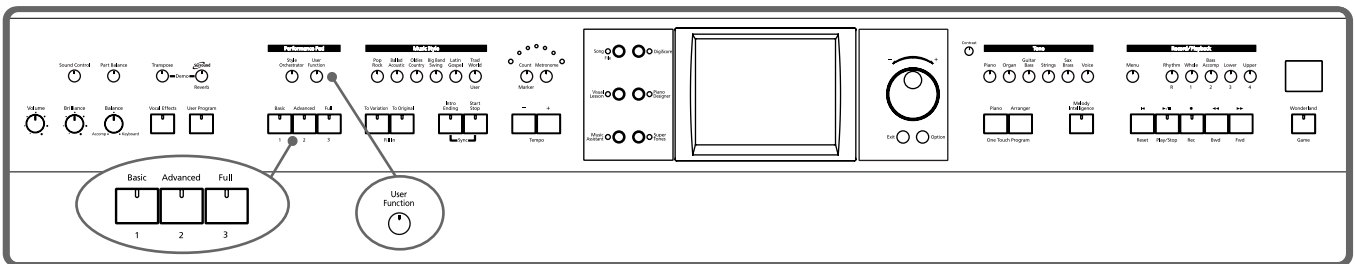

You can also set the tempo by pressing the Performance Pad. This feature is called "Tap Tempo." By using the Tap Tempo function, you can quickly set the tempo you are thinking of, without specifying the tempo in numerical terms.



Assigning Functions to the Performance Pads

1. Press the [User Function] button and watch the indicator light up.



2. Touch   for the Performance Pad to which the function is assigned, then select "Tap Tempo."
3. Press the [Exit] button; the tempo is indicated in the upper left of the screen.

Specifying the Tempo

4. Press the Pad to which "Tap Tempo" is assigned at least twice.
The tempo is set to the song you used when tapping the button.

■ Playing Back at a Fixed Tempo (Tempo Mute)

If a song has tempo changes, it helps to practice the song first at a steady tempo. Overriding tempo changes is called "Tempo Muting."

1. Hold down the [▶/■ (Play/Stop)] button and press one of the Tempo [-] [+] buttons.

When tempo muting is in effect, the tempo display appears in reverse video.

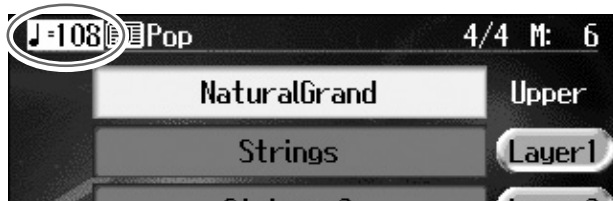

When you play back the song, it will play at a constant tempo.

Cancel the Tempo Mute Setting

1. Hold down the [▶/■ (Play/Stop)] button and press one of the Tempo [-] [+] buttons.

Tempo muting is canceled.

Tempo Mute will also be cancelled when you select a different song.



You can also assign the Tap Tempo function to the pedal, and use the pedal to specify the tempo. For details, refer to "Assigning Functions to Pedals and Performance Pads (Pedal Setting/User Functions)" (p. 167).



You can start the song by giving the count through the microphone. For more detailed information, refer to "Enabling the Start of Songs and Automatic Accompaniment with the Sound of Your Voice (Vocal Count In)" (p. 50).

Match the Tempo Before You Begin Playing (Count In)

When you're playing along with a song, you can listen to the tempo before you start playing by adding a count-in.

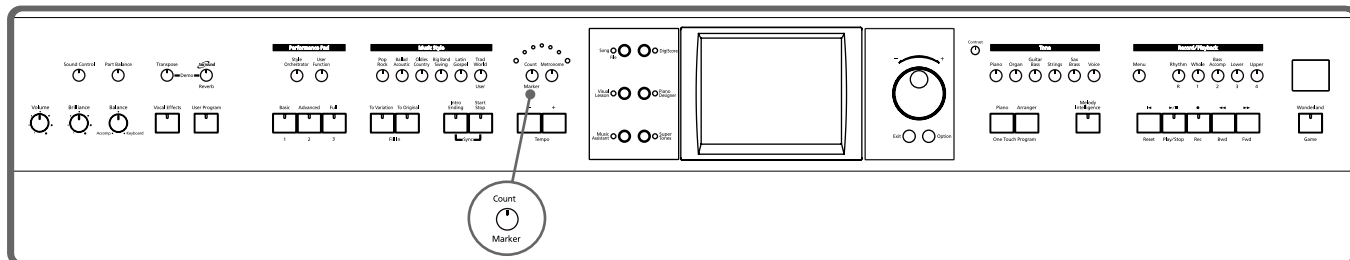

This audible count before the song playback is called a "Count In."



1. Press the [Count/Marker] button and watch the indicator light up.

The following "Count screen" appears.



2. Touch <Count Mode>   to set this to "Count In" or "Count In/Down."

With this setting, two measures count down before the song playback starts.

Canceling the Count In

1. Press the [Count/Marker] button so its indicator is turned off.

By pressing [Exit] instead of the [Count/Mark] button, you can close the Count settings screen without cancelling the count.

MEMO

You can have a count sound be played before the song starts playing back by holding down the [◀ (Reset)] button while you press the [▶/■ (Play/stop)] button. The status of the Count settings won't be affected by your use of this procedure.

MEMO

For more about other settings on the Count settings screen, refer to "Changing the Settings for the Count" (p. 164).

Muting Some Parts Before Playing (Track Buttons)

With commercially available music files for piano lessons, the part for each hand can be played back independently. This makes it easy to practice hands separately. For example, you can follow along with your right hand while you listen to that same right-hand part be played, or you can practice the left-hand part while the right-hand part plays.

A music file for piano lessons may be assigned to the five Track buttons as shown below.

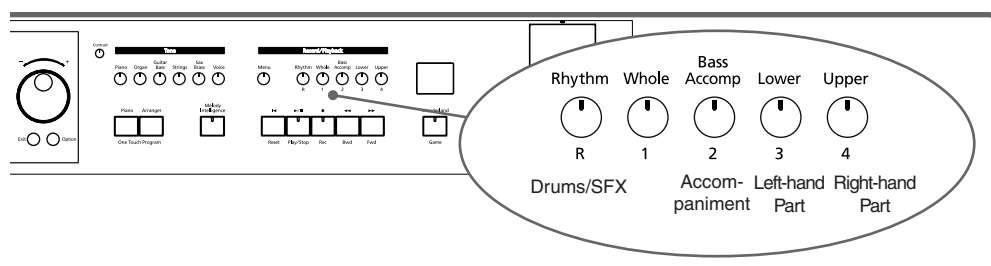

By using these Track buttons, you can eliminate the sound of specific parts. This is referred to as “muting.”

By recording your own performances to the Track Buttons in this fashion, you can mute parts the same way. For details, refer to “Recording While Selecting the Track Buttons (Redoing Recordings)” (p. 110).

1. Select the song that you wish to play back (p. 75).

Selecting the Part that You’ll be Playing

2. Press any one of the Track buttons to make the button’s indicator light or flash go dark.

The sound for the selected part no longer plays.

For example, when practicing the right hand, press the [4/Upper] button.

When you play back the song, the right-hand performance will not sound. Practice your right-hand performance along with the left-hand playback.

Playing Back a Song

3. Press the [▶/■ (Play/Stop)] button.

The song will begin playing back.

The part you selected in step 2 will not sound.

Once again press the button you selected in step 2. The button’s indicator will light up, and the part will be heard once again.

Even while the song is playing, you can press the track buttons to mute or un-mute the sound.

Stopping the Song

4. Press the [▶/■ (Play/Stop)] button.

The song will stop.

MEMO

For more on music files, refer to “Music Files That the KR Can Use” (p. 217).

NOTE

You cannot mute individual parts separately in audio files and audio CDs.

MEMO

If a single Track button includes more than one instrument and you want to mute just one of those instruments, take a look at “Modifying the Settings of Each Part” (p. 137).

MEMO

When a single Part is not played, it is called “Minus One.” Using Minus One, you can mute out a particular instrument and play the part yourself.

MEMO

When playing back SMF files for Roland Piano Digital series instruments, and the [3/Lower] button and [4/Upper] button do not correctly control the lower/ upper performances, please change the “Track Assign” settings. Please refer to “Changing the Parts Assigned to the Track Buttons During SMF Playback (Track Assign)” (p. 183).

MEMO

You can adjust the balance between the keyboard and song volume levels. Check out “Adjusting the Volume Balance for Each Performance Part (Part Balance)” (p. 73).

Setting Markers for Repeated Practice (Marker)

By setting markers at points in a song that you want to practice repeatedly, you can then easily go to and repeat play back of the selected measures.

■ Placing a Marker within a Song

You can place two separate markers (Marker A and Marker B) in one song. These markers are placed at the beginning of a measure to make the beginning and end of a section of music. Placing markers is a handy way to start playback at the same place as many times as you like. You can add markers or move to a marker even while playback is in progress.

NOTE

You cannot place markers in audio files and in audio CDs.

Access the Marker Screen

First, select the song in which you'll set the markers (p. 75).

1. Press the [Count/Marker] button.
2. Touch <Marker>.

The Marker screen appears.

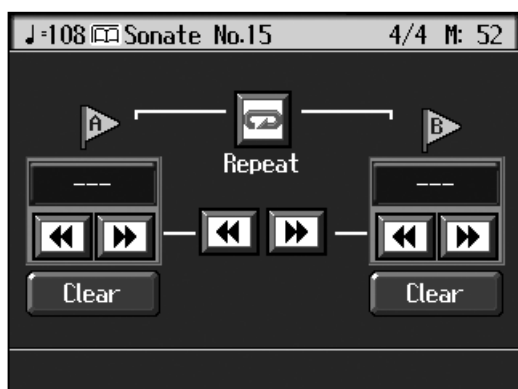

Placing Markers

3. Go to the measure where you want to set a marker using the [<<< (Bwd)] and [>>> (Fwd)] buttons.
4. Touch <- -> for Marker A.

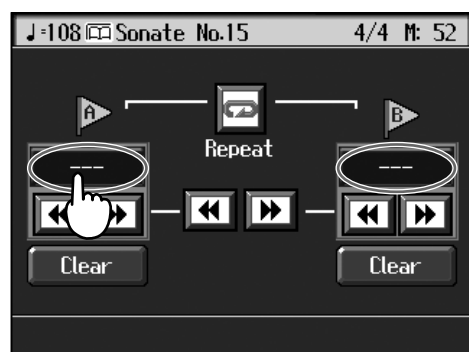

Marker A is placed at the beginning of the measure you selected.

"--" on the screen will change to the number of the measure where you placed the marker.

5. In the same way, touch the Marker B <- -> to set Marker B.

It is not possible to assign marker B to the same location or a measure before marker A.



Markers can also be assigned in units of beats rather than measures. Refer to "Placing a Marker in the Middle of a Measure" (p. 164).

■ Playback from a Marker Location

1. At the marker screen, touch the measure number of the marker you want to go to.

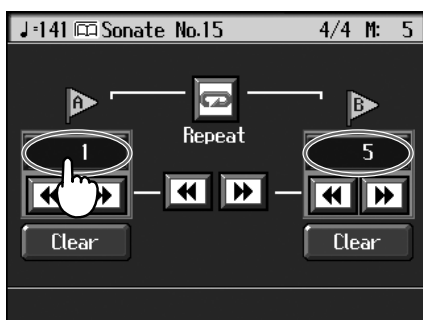

Playback will start from wherever Marker A or Marker B are set.

When you play the song, playback starts from the position of the marker.

With the song playing back, playback will continue if you touch Marker A or Marker B on the Marker screen.

■ Erasing a Marker

1. Touch <Clear> for the marker you want to erase.

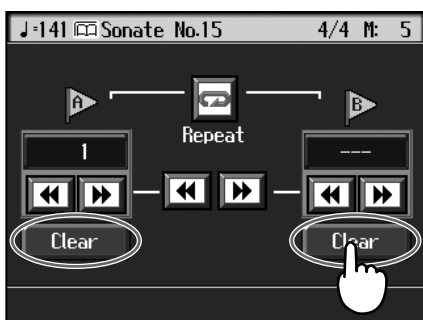



The marker disappears and the on-screen display changes to <- ->.

■ Moving a Marker

You can move a marker that has been placed in a song. You can also move the section of music defined by Markers A and B forward or back, without changing the number of measures of marked.

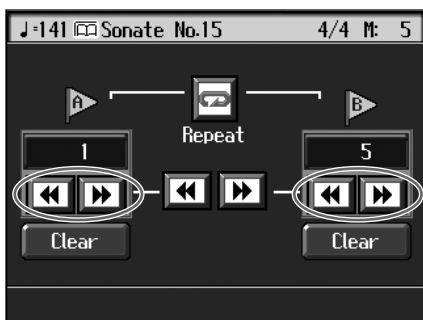
1. On the Marker screen, touch  or  for the marker to be moved.



When you touch , the marker is moved to a previous part of the song.

When you touch , the marker is moved to a later part of the song.

Moving Markers A and B without Changing the Interval Between Them

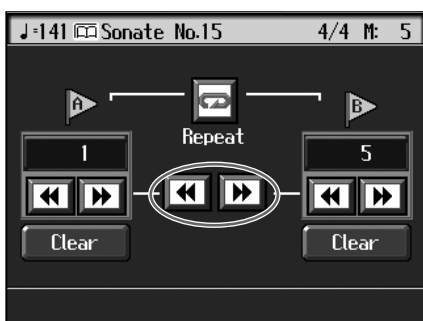

1. On the Marker screen, touch  or  in the middle of the screen.

For example, if you have Marker A set at the beginning of the fifth measure, and

Marker B set at the beginning of the ninth measure, when you touch  in the middle of the screen, Marker A is moved to the beginning of the first measure, and Marker B is moved to the beginning of the fifth measure.

Touch  to shift Marker A to the beginning of the ninth measure and Marker B to the beginning of the thirteenth measure.

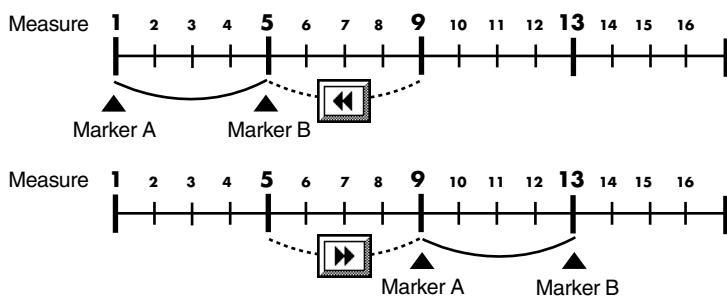

■ Playing Back the Same Passage Over and Over

You can play back a particular passage over and over. This is convenient when you want to focus on a passage.

1. First, set Marker A and Marker B to define the measures you want to repeat.

For instance, suppose you want to play back the passage from the fifth through eighth measures over and over. You should place Marker A at the beginning of the fifth bar and Marker B at the beginning of the ninth bar.

2. Touch <Repeat> in the Marker screen.

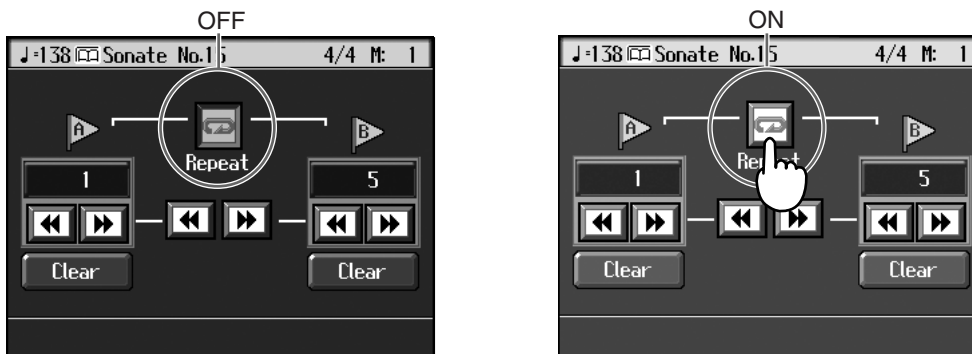

The setting is made for repeated playback of the passage from marker A to marker B. When you play the song, the marked section of music plays back repeatedly.

■ Cancelling Repeat Playback

3. Touch <Repeat> in the Marker screen, and the icon returns to the original color.

Repeat playback is cancelled.



When <Repeat> is On

- If neither Marker A nor Marker B is set, the song is played back from the beginning to the end.
- If you only place marker A, playback repeats from marker A to the end of the song.
- If you only place marker B, playback repeats from the beginning of the song to marker B.

Transposing Keyboard Sounds and Songs Played Back (Transpose)

By using the “Transpose function,” you can transpose your performance without changing the notes you play. For example, even if the song is in a difficult key with many sharps (♯) or flats (♭), you can transpose it to a key that is easier for you to read and play.

You can also use this function to play back a song in a different key.

When accompanying a vocalist, you can easily transpose the pitch to a range that is comfortable for the singer, while still playing the notes as written (i.e., with the same fingering positions).

NOTE

You cannot transpose audio files and audio CDs.

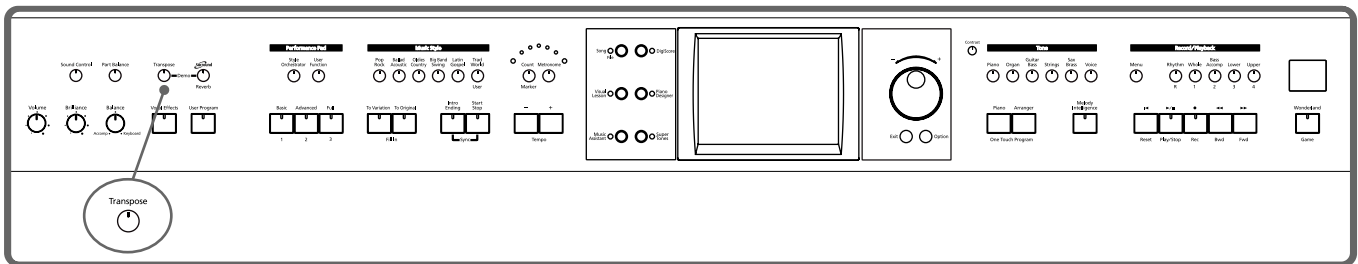

First make sure you have selected the song to be transposed (p. 75).



1. Press the [Transpose] button.

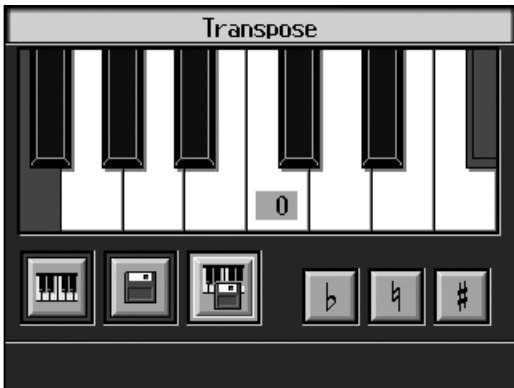

A “Transpose screen” like the one below appears.



2. Touch one of the three icons to select the song or sounds to be transposed.

Icon	Target	Settings Value
	Keyboard sound	-6-0-5
	Song to be played back	-24-0-24
	Keyboard sounds, songs being played back	-6-0-5

- 3.** Touch the screen keyboard or ,  to select the transposition value.

Each time you press  or , it transposes the key by a semitone.

When you touch , a value of "0" is set.

You can also use the dial to change the transposition value.

When you transpose a song or the keyboard, the [Transpose] button's indicator lights up. As you play the keyboard or play back the song, the notes are transposed.

When you press the [Exit] button, the transposition remains in effect, and you're returned to the previous screen.

Cancelling Transposition

- 4.** Press the [Transpose] button and the indicator light goes out.

Transposition is cancelled.

The next time you press the [Transpose] button, illuminating the indicator, the music is transposed by the value set here.



The transposition value reverts to "0" when you turn off the power or select another song.

Example: Playing a song in E major while playing the keys for C major

In this example, C is the root note in the key of C major. E, the root of E major, is the

third in C major. It is up four keys, including the black keys, so touch , then enter "4" for the setting.

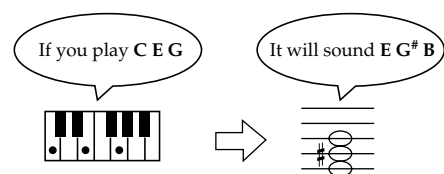

Chapter 5 Recording and Saving the Performance

You can easily record performances using the five track buttons.

A recorded performance can be played back to listen to your own playing, or to add additional parts.

You can use the KR to make the following kinds of recordings.

- Recording just your own keyboard performance
→ “Recording a New Song (New Song)” (p. 105)
- Recording performances using Automatic Accompaniment
→ “Recording With Accompaniment” (p. 107)
- Recording along with the internal songs and songs on external memories
→ “Recording Along with a Song” (p. 109)
- Re-recording
→ “Recording While Selecting the Track Buttons (Redoing Recordings)” (p. 110)

○ If the Following Screen Appears

If you’ve recorded a song or changed a song’s settings (see p. 137), the following message appears on the screen when you try to choose another song.



If it’s okay to delete the song, touch <OK>.

If you do not want to delete the song, touch <Cancel>, and either save the song to an external memory (p. 116) or register the song to the Favorites (p. 82).

NOTE

Recorded performances are discarded when another song is selected, or when the power is turned off. Be sure to save important performances on an external memory (p. 116) or register the song to the Favorites (p. 82).

NOTE

You cannot record while playing along with audio files and audio CDs.

NOTE

You cannot save songs to CDs, and you cannot delete songs recorded to CDs. Furthermore, you cannot format CDs.

Recording a New Song (New Song)

This records keyboard performances without the use of the internal songs or Automatic Accompaniment.

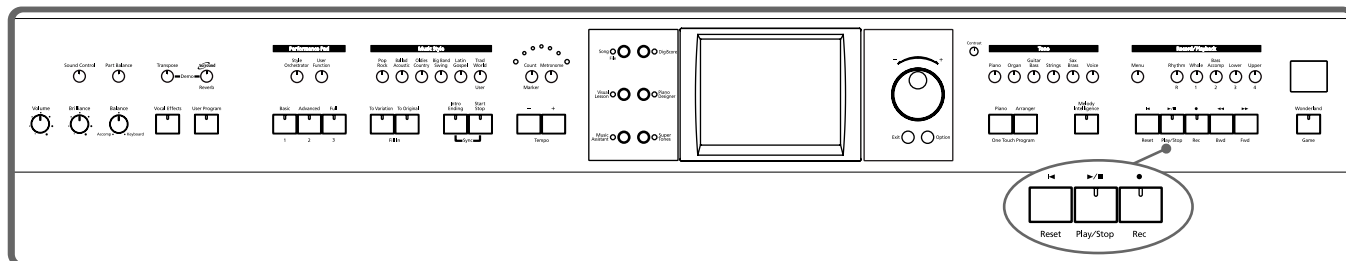

Settings for Recording Performances

1. Press One Touch Program [Piano] button.

This sets the KR for performance without the use of Automatic Accompaniment.

2. Decide on the tone of the performance (p. 28).

Use the Tone buttons and the touch screen to select the tone.

When you have finished choosing the settings, press the [Exit] button to display the Basic screen.

Recording Settings

3. Press the [● (Rec)] button.

If you press the [● (Rec)] button when a song has already been selected, the following message appears.



4. Touch <New Song>.

This switches the KR to the settings required for recording a new song.

The KR is put in recording standby.

To cancel recording, press the [● (Rec)] button once more.

5. Decide on the tempo and beat.

If necessary, press the [Metronome] button to play the metronome.

When you have finished making the settings, press the [Exit] button to display the Basic screen.

MEMO

If you select <New Song> when a song has already been recorded, the “OK to delete song?” prompt appears in the screen. For more detailed information, refer to “If the Following Screen Appears” (p. 104).

Start Recording

6. Press the [▶/■ (Play/Stop)] button.

A two-bar count-in plays, then recording starts.

Even without pressing the [▶/■ (Play/Stop)] button, recording starts when you play the keyboard. There is no count-in played when you start by playing rather than pushing the [▶/■ (Play/Stop)] button.

When recording starts, the [▶/■ (Play/Stop)] and [● (Rec)] buttons' indicators light up.

Stop Recording

7. Press the [▶/■ (Play/Stop)] button.

Recording stops.

The performance is recorded to the [1/Whole] button.

Listening to the Recorded Performance

8. Press the [◀ (Reset)] button, then press the [▶/■ (Play/Stop)] button.

The recorded performance is played back.

When you press the [▶/■ (Play/Stop)] button, playback stops.

Track buttons assignments for recorded performances

When you record only a keyboard performance, the performance will be assigned to the track buttons as follows.

- **Normal performance (playing a single Tone from the entire keyboard)**
The performance is recorded to the [1/Whole] button.
- **Layer performance**
The performance is recorded to the [1/Whole] button.
- **Split performance**
The lower part of the keyboard is recorded to the [3/Lower] button, and the upper part of the keyboard is recorded to the [4/Upper] button.
- **Layer performance and Split performance**
The lower part of the keyboard is recorded to the [3/Lower] button, and the upper part of the keyboard is recorded to the [4/Upper] button.
- **Drum set or sound effect performance**
Recorded on the [R/Rhythm] button.

NOTE

Any performance that has been recorded is deleted when the power to the KR is turned off. If you do not want a performance deleted, then save it to an external memory or to Favorites. Refer to "Saving Songs" (p. 116).

NOTE

When "Auto Start (p. 180)" is set to "ON," and no action is taken for a certain period of time after you have recorded a performance, a confirmation screen asking you if you want to delete the song appears in the display.

If you touch <OK>, the song is deleted and the demo begins. If you want to return to the previous screen and continue with the recorded performance, touch <Cancel>.

Recording With Accompaniment

Try recording a performance along with the Automatic Accompaniment.

Settings for Recording Performances

1. Press the One Touch Program [Arranger] button.

This chooses the setting for Automatic Accompaniment.

2. Decide on the Music Style.

When you have finished choosing the settings, press the [Exit] button to display the Basic screen.

Recording Settings

3. Press the [● (Rec)] button.

You press the [● (Rec)] button and the following messages will appear, when a song has already been recorded.



4. Touch <New Song>.

This switches the KR to the settings required for recording a new song.

The KR is put in recording standby.

To cancel recording, press the [● (Rec)] button once more.

5. Decide on the tempo.

Start Recording

6. Play a chord on the lower part of the keyboard.

An Automatic Accompaniment intro starts, and recording starts at the same time.

Stop Recording

7. Press the [Intro/Ending] button.

An ending plays, then the Automatic Accompaniment, and recording stop at the same time.

Listening to the Recorded Performance

8. Press the [◀ (Reset)] button, then press the [▶/■ (Play/Stop)] button.

The recorded performance plays back.

When you press the [▶/■ (Play/Stop)] button, playback stops.



If you select <New Song> when a song has already been recorded, the “OK to delete song?” prompt appears in the screen. For more detailed information, refer to “If the Following Screen Appears” (p. 104).



You can change how recording is stopped when recording a performance with Automatic Accompaniment. To learn how, see “Changing How Recording Stops” (p. 111).

Track buttons assignments for recorded performances

Performances that have been recorded using Automatic Accompaniment are assigned to the track buttons as shown below.

Track button	Performance Recorded
[R/Rhythm]	The rhythm part of an Automatic Accompaniment is recorded here. In addition, drum sets and effect sounds that are selected with the keys in a performance are recorded to this track.
[1/Whole]	When using Piano Style accompaniment (p. 72), the performance played on the keyboard is recorded here.
[2/ Bass Accomp]	The Automatic Accompaniment bass part and accompaniment part are recorded here.
[3/Lower]	When the KR is set so that sounds from performances on the left-hand side of the keyboard are played while the Automatic Accompaniment sounds (p. 71), your own performance on the left-hand side of the keyboard is recorded here.
[4/Upper]	Your own performance on the right-hand side of the keyboard is recorded here.



Music Styles are composed of eight parts. For details, refer to “Music Styles and Automatic Accompaniment” (p. 57).

Recording Along with a Song

Try recording along with internal songs and songs on external memories.
Here, record your right-hand performance along with the song accompaniment.

Settings for Recording Performances

- 1.** Select a song.
For more on how to select songs, refer to p. 75.
- 2.** Decide on the tone and tempo of the performance.
- 3.** Press the [DigiScore] button to display the notation.
For instructions on displaying the notation, refer to p. 87

Recording Settings

- 4.** Press the [● (Rec)] button.
A screen like the one shown below appears.



- 5.** Touch <Add On>.
With this setting, you can record while listening to the selected song.

Selecting the Track to Record

- 6.** Press the track button for the track that you want to record (i.e., the track that you want to play yourself).
The indicator of the button you pressed will blink, and the KR enters recording-standby mode.
Since in this example we will record the upper part performance, press the [4/Upper] button to make the button's indicator light blink.
To cancel recording, press the [● (Rec)] button once more.

Start Recording

- 7.** Press the [▶/■ (Play/Stop)] button.
A two-bar count-in plays, then recording starts.
Even without pressing the [▶/■ (Play/Stop)] button, recording starts when you play the keyboard. There is no count-in played when you start by playing the keyboard instead of pushing the [▶/■ (Play/Stop)] button.
When recording starts, the [▶/■ (Play/Stop)] and [● (Rec)] buttons' indicators light.

Stop Recording

- 8.** Press the [▶/■ (Play/Stop)] button.



The song tempo is stored within the song you selected.

NOTE

Only drum sets or SFX set are recorded to the [R/Rhythm] button.

Recording stops.

Listening to the Recorded Performance

9. Press the [⏪ (Reset)] button, then press the [▶/■ (Play/Stop)] button.

The recorded performance is played back.

When you press the [▶/■ (Play/Stop)] button, playback stops.

Recording While Selecting the Track Buttons (Redoing Recordings)

When you want to re-record, specify the Track button for the performance you want to re-record, and then record again.

When you select a previously recorded Track button and re-record, everything from the point at which you begin recording up to the point where you stop recording will be replaced by the newly re-recorded performance.

1. Use the [⏪ (Bwd)] and [⏩ (Fwd)] buttons to go to the measure where you want to begin recording.

2. Press the [● (Rec)] button.

A screen like the one shown below appears.



3. Touch <Add on>.
4. Press the Track button for the track you want to re-record.

The indicator for the selected Track button starts blinking.

The [▶/■ (Play/Stop)] button's indicator flashes, and the KR is put in recording standby.

To cancel recording, press the [● (Rec)] button once more.

5. Press the [▶/■ (Play/Stop)] button to begin recording.

Rerecording the Accompaniment Part of Automatic Accompaniment

When rerecording an Automatic Accompaniment performance, set Sync Start (p. 65), then specify a chord or press the [Start/Stop] button.

6. Press the [▶/■ (Play/Stop)] button to stop recording.

If you also want to rerecord the ending of the Automatic Accompaniment, press the [Intro/Ending] button.



When you want to record over again after deleting all of the previous recording, refer to "Erasing Recorded Performances" (p. 111).



The song tempo is stored within the song you selected. If you want to change the tempo of the recorded song, refer to "Changing the Tempo of Recorded Songs" (p. 151) and "Changing the Tempo Within the Song" (p. 151).

Erasing Recorded Performances

You can use the following method to delete a recorded performance.

1. Hold down the [Song] button and press the [● (Rec)] button.

A screen like the one shown below appears.



2. Touch <OK>.

This deletes the recorded song.

When you touch <Cancel>, the song selection screen or basic screen appears and the recorded song is not erased.

■ Erasing the Performance on Specific Tracks

You can select and erase performances on specific tracks.

1. Hold down the Track button for the track containing the performance you want to erase, then press the [● (Rec)] button.

The Track button's light goes dark, and the recorded music is erased.

Changing How Recording Stops

When recording an Automatic Accompaniment performance, you can change the accompaniment and the way recording mode stops.



1. Press the [Menu] button and watch the indicator light up.

The "Composer Menu" or the "A/V Sync" screen appears.

2. Touch <Rec Mode>.

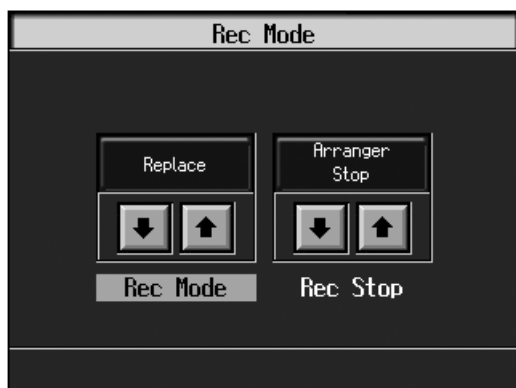
A screen like the one shown below appears.



3. Touch <Rec Stop>   to switch between “Arranger Stop” and “Composer Stop.”

Display	Explanation
Arranger Stop	Recording stops at the same time the Automatic Accompaniment stops.
Composer Stop	Recording does not stop, even when the Automatic Accompaniment stops. When you press the [▶/■ (Play/Stop)] button, recording stops.

Recording Songs Starting with Pickups

You can record songs that start with pickup beats (songs that start on a beat other than the measure’s first beat).

Count Sound

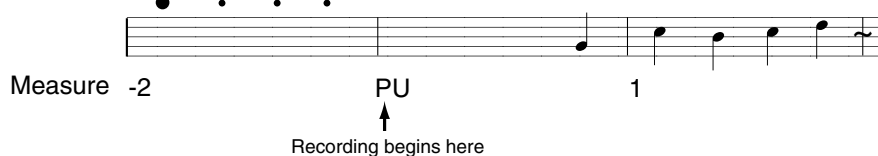

Carry out Steps 1–4 on p. 105 to prepare for recording.

If the [● (Rec)] button’s indicator is not lit, press the [● (Rec)] button so the indicator is lit.

The KR is put in recording standby.

1. Press the [◀◀ (Bwd)] button one time.

The measure number in the upper right of the Basic screen changes to “PU,” and the KR is set to record a song starting with a pickup.

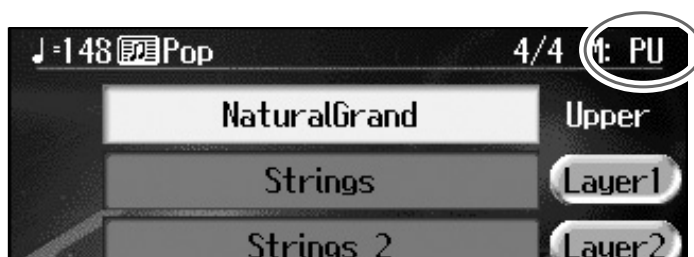

Start recording. After a one-measure count, recording begins.

Using External Memories

If you install separately available external memory or a floppy disk drive, you'll be able to save songs you've recorded and listen to commercially available music data.

■ Connecting and Ejecting an External Memory

1. Press the External Memory port cover and open the cover.

Press the cover in; the cover will open.

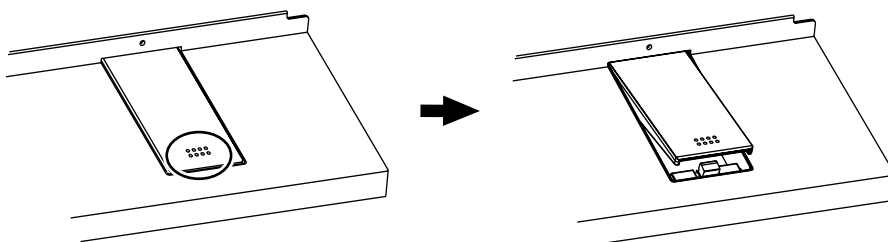

2. Connect the external memory to the External Memory port.

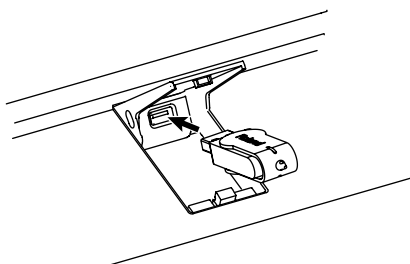

3. Press the cover in again to close the cover.

* Always keep the Ext Memory port cover closed except when connecting and disconnecting external memory.

Locking the External Memory Port Cover

When connecting external memory (sold separately), you can lock the memory port cover to prevent theft of the connected external memory.

1. Connect the external memory to the external memory port.

2. Press the External Memory port cover to close the cover.

3. Secure the lock using the anti-theft lock screws included with the instrument.

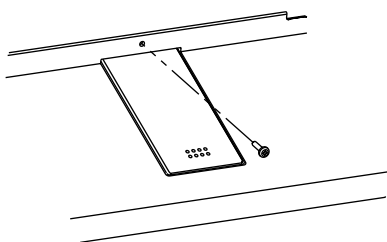

MEMO

If connecting an optional floppy disk drive, substitute "floppy disk" wherever the term "external memory" appears here.

NOTE

Use external memory available from Roland. Proper functioning cannot be guaranteed if other external memory products are used.

NOTE

Carefully insert the an external memory all the way in—until it is firmly in place.

NOTE

Take care not to lose the anti-theft lock screws. Also be sure to use only the included screws to secure the anti-theft lock.

■ Formatting Media (Format)

The process of preparing external memory or disks so that they can be used with the KR is called “initialization” (formatting).

In certain cases, particularly with floppy disks, the media is formatted for a specific type of device. If the media format does not match the KR’s, you will not be able to use that media with the KR.

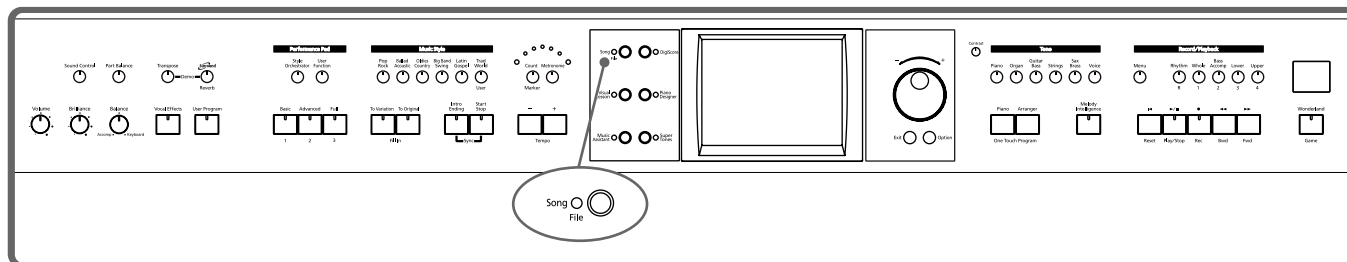

1. Connect the external memory to the external memory port.
2. Press the [Song/File] button.
3. Touch <File>.

A “File screen” like the one below appears.



4. Touch <Format Media>.

The following screen appears.

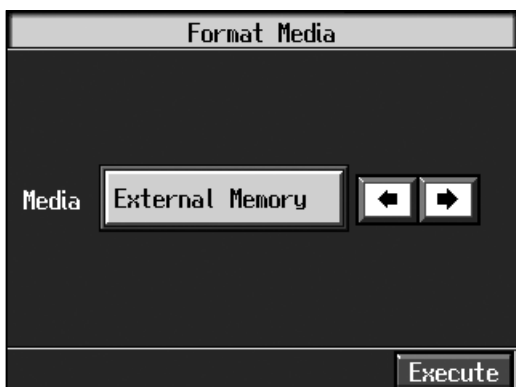



Press the [Exit] button to go back to the previous screen.

NOTE

When an external memory is initialized, all of the data saved on the external memory is erased. If you’re formatting a used external memory for reuse, be sure to check first to make sure the external memory doesn’t contain any data you don’t want to lose.

NOTE

When initializing floppy disks, check to make sure that the disk’s write protect tab is slid to the “write” position (p. 7).

5. Touch <Media>   to select the storage media to be initialized.

6. Touch <Execute>.

A confirmation screen appears. If you want to quit the initialization, touch <Cancel>.

7. Touch <OK>.

Initialization of the external memory begins.

When initialization is completed, you're returned to the previous screen.

NOTE

Do not remove the storage media until the initialization is completed.

NOTE

Do not eject the floppy disk while data is being read from or written to the disk. This may scratch the disk's magnetic surface, rendering the memory unusable. (The disk drive's indicator lights brightly while data is being read from or written to the disk. At all other times, the indicator is lit more dimly, or is not lit at all.)

NOTE

If "Error" appears on screen, take a look at "Error Messages" (p. 201).

Saving Songs

A recorded performance is discarded when you switch off the power or choose another song. Storing recorded performances and other data to external memories or the Favorites is called “saving.” Be sure to save important songs to external memories or Favorites.

What are “Favorites?”

You can register songs you are currently practicing or particularly like to “Favorites,” allowing you to select these songs easily (p. 82).

When you register a song on an external memory to Favorites, you can then play back the song without connecting the external memory to the external memory connector.

If a recorded performance is saved to Favorites, the performance won’t be erased when the power is turned off.

Preparations for Saving Data

When saving to external memories, connect the external memory to the external memory port.

1. Press the [Song/File] button.

2. Touch <File>.

The “Song File screen” appears.

3. Touch <Save>.

The following “Save Song screen” appears.



MEMO

Substitute the words “floppy disk” for “external memory” if using a separately purchased floppy disk drive.

MEMO

When using a new storage media, first initialize (format) the external memory on the KR. Take a look at “Formatting Media (Format)” (p. 114).

NOTE

Some commercially available music files cannot be saved because they are copy protected.

MEMO

When saving to floppy disks, first check to make sure that the floppy disk’s protect tab is set to the “Write” position (p. 7).

MEMO

If not handled with care, a floppy disk and an external memory can be damaged, or the data on it become corrupted, making playback impossible. We recommend saving your songs on two different media.

MEMO

When you want to clear all of the content saved to the “Favorites” and restore the settings to the original factory condition on the KR, refer to “Formatting the User Memory” (p. 180).

Determining the Name of the Song to be Saved**4.** Touch <Rename>.

The following “Rename screen” appears.





When you touch  , the cursor moves.

When you touch the icon for the letter or character to be input, the character appears at the cursor location. For example touching <ABC> in succession cycles you through the available choices in that character group (“A”→“B”→“C” ...).



Each touch of <A-a-0-!> cycles the type of characters through “English (upper case),” “English (lower case),” “numerals,” “symbols,” then back to “English (upper case).”

When you touch , the character at the cursor position is deleted.

When you touch <Ins>, a space is inserted at the cursor position.

5. When you have finished with the name, press the [Exit] button.**Determining the Save Destination****6.** Touch <Media>   to select the save-destination storage media.**7.** Touch <File>   to select the save-destination song number.

If a song name is displayed with a number a song is already saved to that number. If you select a number with a previously saved song and then proceed to save a new song, the previously saved song will be erased. If you do not want to lose a saved song, select a number with no song name indicated in the save-destination column.

Selecting the Save Setting (when saving to external memories)**8.** Press the [Option] button.**9.** Touch “Tone Compatibility”   to select the tone compatibility format.

Chapter 5 Recording and Saving the Performance

Some Tones are unique to the KR. Data that is recorded using these tones may not play back correctly on other Roland Digital Pianos or Music Players. When you want to save data so that it can be played back on another devices, save the data with “MT” set as the Tone compatibility format.

Display	Explanation
KR	The song is saved as data capable of reproducing performances with richness of expression using this unit’s special Tones.
MT	Data is saved in a form that can also be played on the Roland Digital Pianos or Music Players other than this unit. You can listen to songs saved in this format on the Roland HP-G/R series and KR series keyboards as well as on Roland MT series devices.

<Note>

When data saved with “MT” as the Tone compatibility format is played back on this instrument, some of the nuances that were part of the performance at the time the data was recorded may be altered.

Even with data saved with “MT” as the Tone compatibility format, an exact reproduction of the original performance may be unobtainable when using GS devices other than Roland Pianos and Music Players.

Selecting the File Format (when saving to external memories)

10. Touch <File Format>   to select the file format.

Display	Explanation
SMF	Saves the song as an SMF (Standard MIDI Files). Songs saved in this SMF format can be listened to on many instruments that can play SMF music files (p. 217). A song recorded using commercial music files can’t be saved in “Save As SMF” format for reasons of copyright protection.
i-format	Saves the song in this unit’s format. You can listen to songs saved in this format on the Roland HP-G/R series and KR series keyboards as well as on Roland MT series devices. This format is called “i-format”.

11. Press the [Exit] button.

Save

12. Touch <Execute> to start saving.

The time required for saving ranges from several seconds to half a minute or more.

Don’t take the external memory out of the external memory port until the saving process is finished.

Press the [Exit] button to return to the Song File screen.

NOTE

Depending on the playback instrument, some notes may drop out or sound different.

NOTE

Never turn off the power while the saving operation is in progress. Doing so will damage the KR’s internal memory, making it unusable.

MEMO

It’s a good idea to get into the habit of moving the write-protect tab on the floppy disk to the “Protect” position when you’ve finished saving your data. Keeping the tab at “Protect” prevents operations that could erase your songs by mistake.

Deleting Saved Songs

This deletes songs that have been saved on external memories, or to Favorites.

To delete a song on an external memory, first connect the external memory to the external memory port.

1. Press the [Song/File] button.

2. Touch <File>.

The “Song File screen” appears.

3. Touch <Delete>.

A “Delete Song screen” appears.



4. Touch <Media>   to select the storage media.

5. Touch <File>   to select the song to be deleted.

6. Touch <Execute>.

The selected song is deleted.

Do not eject the external memory from the external memory port until the operation is finished.

Press the [Exit] button to return to the Song File screen.

NOTE

Never turn off the power while the operation is in progress. Doing so will damage the KR's internal memory, making it unusable.

Copying Songs on External Memories to Favorites

You can take songs saved on external memories and copy them to Favorites.

You can also copy songs in Favorites to external memories.

1. Connect the external memory with the song to be copied to the external memory port.

2. Press the [Song/File] button.

3. Touch <File>.

The “Song File screen” appears.

4. Touch <Copy>.

The following “Copy Song screen” appears.





Specifying the Copy Source

5. Touch the <Media>   to select the copy source storage media.

6. Touch the <File>   to select the song you want to copy.

When “Copy All” is selected, songs within the selected folder on the external memory are copied to Favorites.

Specifying the Copy Destination

7. Touch <Favorites>   to select the copy destination for the song.

If a song name is displayed with a number, a song is already saved to that number.

If you select a number with previously saved song data and proceed to copy to that location, the previously saved song will be erased. If you don't want to erase a previously saved song, choose a number with no song name appears in the destination column.

8. Touch <Execute>.

Do not eject the external memory from the external memory port until the copy is finished.

The song from the external memory is copied to Favorites.

■ Copying Songs Saved in Favorites to External Memories

Songs that've been saved to Favorites can be copied onto external memories.

In this case, in the "Copy Song screen" in Step 4 above, touch the arrow icon in the center to point the arrow upwards. This sets the KR to copy the song in Favorites to the external memory.



The rest of the procedure is identical to that used for copying songs from external memories to Favorites.

NOTE

Never turn off the power while the operation is in progress. Doing so will damage the KR's internal memory, making it unusable.

NOTE

Some song data cannot copy because they are copy protected.

Chapter 6 Creating Performance Data Including Moving Keys (A/V sync)

With this instrument you can create performance data that, like the CD included with the KR, contains Moving Keys data.

By connecting a Roland CD-2 or similar recording device, you can record not just your piano performances, you can also connect a microphone to record vocals along with the piano performance.

Moreover, you can connect video equipment to the KR and record video images along with the other data as well.

Recording

■ Making the Connections

When connecting audio recording devices

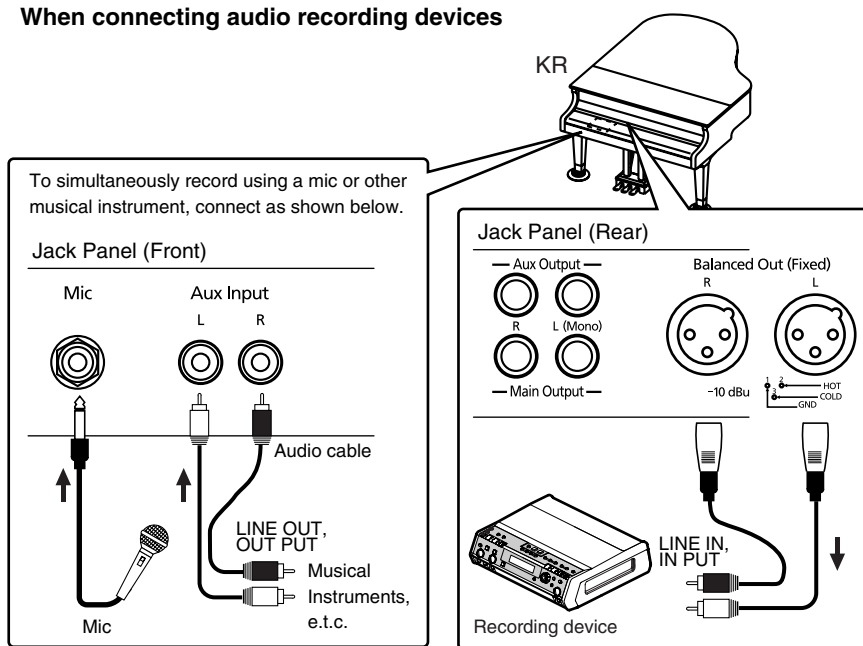

When connecting video recording devices

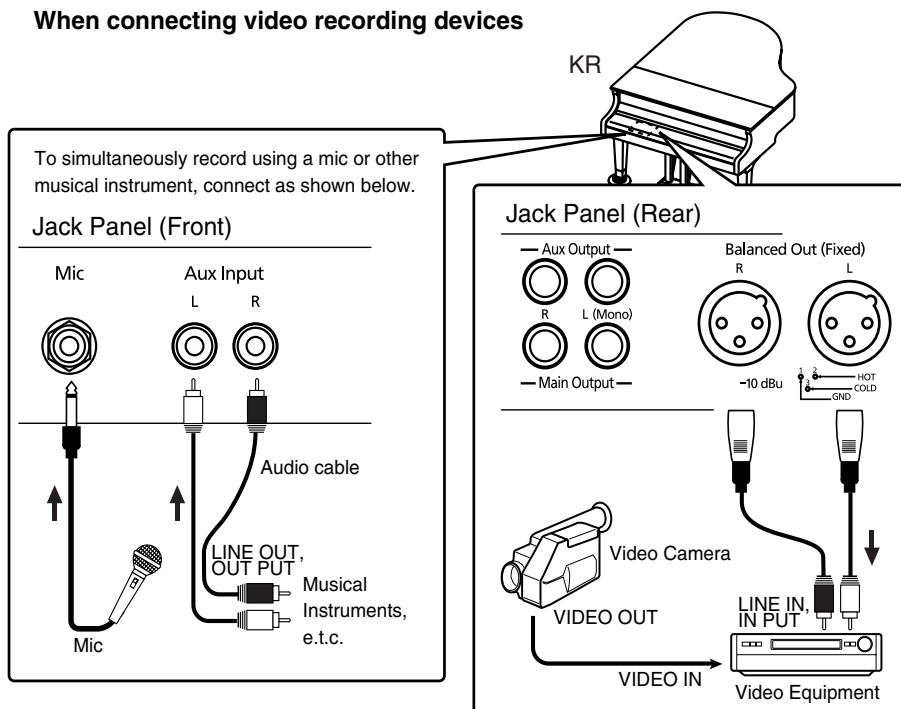

NOTE

If both the output for A/V Sync and AUX input are connected simultaneously, please set "Mode" of the Aux input to "Off."

If this is set to anything other than "Off," make sure to disconnect any cables connected to Aux Out or Balanced Out.

If such connections are left intact, you may likely encounter a loud, continuous beep tone.

1. Press the [Menu] button.

The "A/V Sync" display will appear.

If the "Composer Menu" screen appears, touch  to switch the page.



2. Touch the <A/V Sync Output>.

The following display will appear.



3. Start recording with the connected device.

4. Touch the <Begin Output>.

The following message appears.



When the transmission of the initial setup ends, the following message appears.



5. When the “Start performance” message appears, start playing the KR.



6. When you have finished the performance, touch <Stop Output.>
7. Stop recording with the connected device.

When you touch the <Stop Output>, a screen like the one shown below appears.



Press the [Exit] button to exit the A/V sync function.

When you record other song, touch the <Begin Next Recording>, then repeat the procedure from Step 3.

When you hear the performance recorded to the connected equipment, touch the <Listen to This Recording>.

NOTE

When you display other screen to change tones etc. while outputting data, press [Menu] button once again to display the “A/V Sync” screen, then touch the <A/V Sync Output>.

A screen like the one shown below appears.



When you touch the <Set Aux Input for Playback>, the screen to change the setting is displayed.

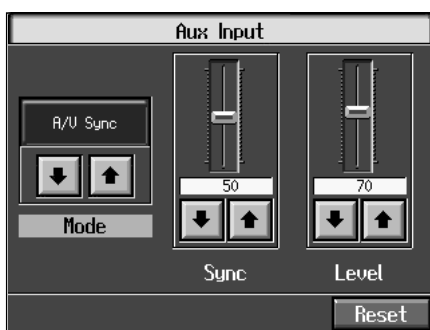

Change the setting and the connections.

Refer to "Making Advanced A/V Sync Input Settings" (p. 128).

Note

With certain Surround settings, data may not be output from the KR as you intend. Turn Surround off when using the A/V sync function. Alternatively, you can switch Surround on and turn on all parts other than the keyboard with the part On/Off settings.

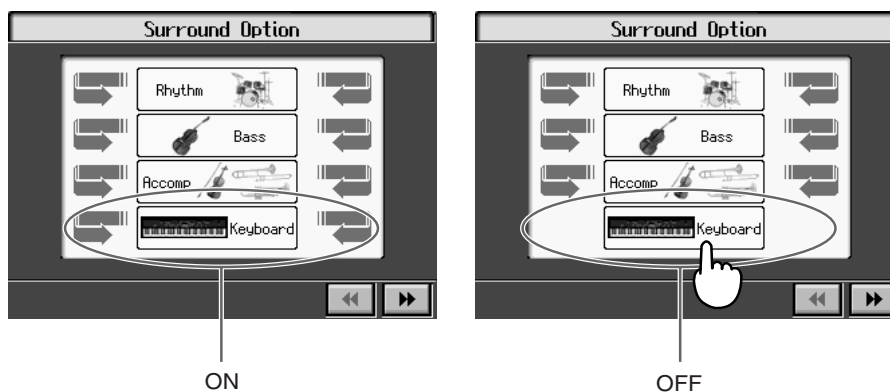

NOTE

Playing back CDs to which this performance data is recorded on CD players other than the KR's internal CD player may result in damage to the speakers. To listen to these CDs, either play them back on the KR's internal CD player or connect to the KR in accordance with the instructions in "Playback (Aux Input)" (p. 127).

■ Making Advanced A/V Sync Output Settings

1. Press the [Menu] button.

The "A/V Sync" display will appear.

If the "Composer Menu" screen appears, touch  to switch the page.

2. Touch the <A/V Sync Output>.

The following display will appear.



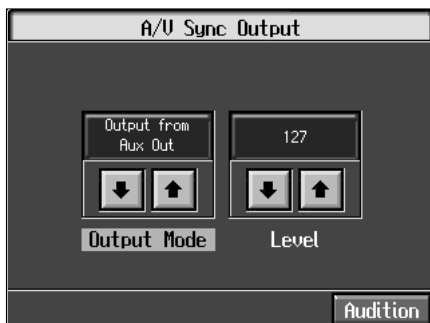

3. Press the [Option] button.

The following display will appear.



4. Touch the <Output Mode> to select output connectors.

When the sound has been distorted, touch the <Level>   to adjust the volume.

Parameter	Setting	Explanation
Output Mode	Balanced Out, AUX Out	Output connectors
Level	0–127	Audio level other than keyboard performance data

You can confirm the settings by touching "Audition."

Playback (Aux Input)

■ Making the Connections

When connecting audio recording devices

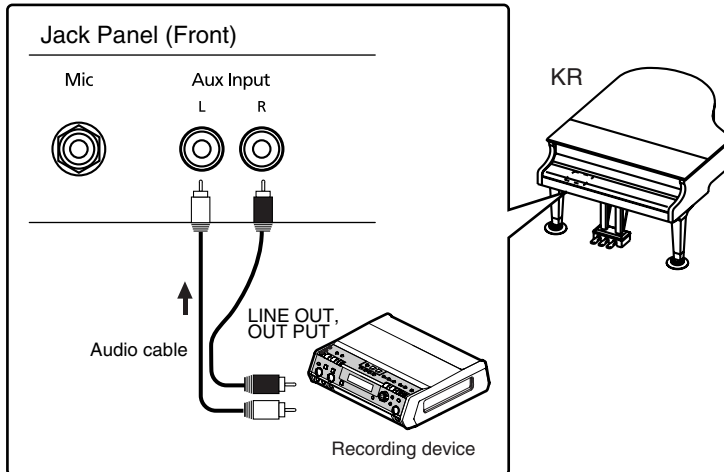

When connecting video recording devices

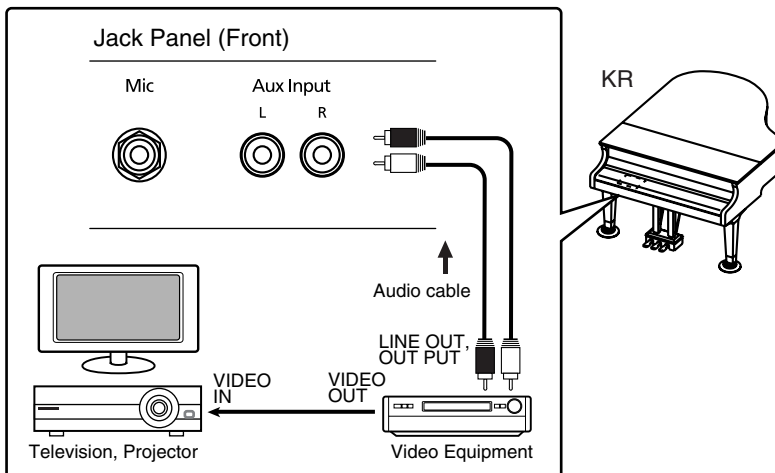

NOTE

If both the output for A/V Sync and AUX input are connected simultaneously, please set "Mode" of the Aux input to "Off."

If this is set to anything other than "Off," make sure to disconnect any cables connected to Aux Out or Balanced Out.

If such connections are left intact, you may likely encounter a loud, continuous beep tone.

Chapter 6

1. Press the [Menu] button.

The "A/V Sync" display will appear.

2. Touch  to switch the page, then touch the <Aux Input>.

The following display will appear.

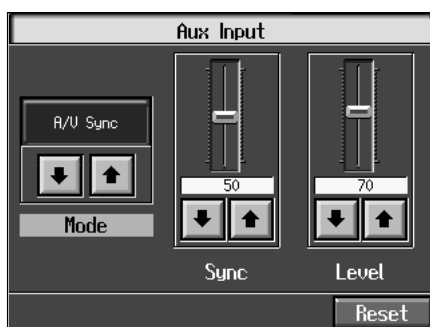

- 3.** Touch the <Mode>   to select “A/V sync.”

When you display the “Song selection screen” after you set “A/V Sync” for the <Mode> setting, and the song category automatically changes to “Aux Input Decode.”

- 4.** Play back the performance on the connected device.

■ Making Advanced A/V Sync Input Settings

- 1.** Press the [Menu] button.

The “A/V Sync” display will appear.

If the “Composer Menu” screen appears, touch  to switch the page.

- 2.** Press the [Option] button.

The following display will appear.

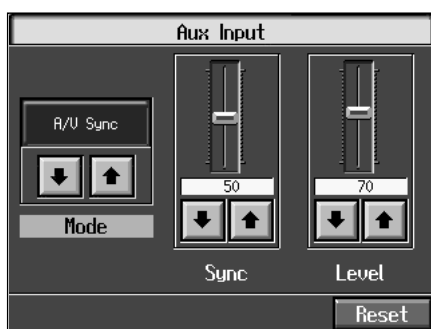

- 3.** Touch the slider or   to set for the parameter.

Parameter	Setting	Explanation
Sync	0–100	On rare occasions, the keyboard performance and accompaniment sounds may not be synchronized properly. In such instances, you can adjust the timing of the keyboard performance sounds so that they are in time with the accompaniment.
Level	0–127	Audio level other than keyboard performance data

NOTE

When “A/V Sync” is selected, the KR automatically distinguishes the type of the encoded signal, then starts playing. In some cases, however, it doesn’t play correctly.

In such cases, press <Reset>. If playback still doesn’t occur correctly, set “Mode” to either “A/V Sync Type A” or “A/V Sync Type B.”

The <Reset> icon is also displayed when you select “Aux Input Decode” as the category in the song selection screen.

MEMO

If the level is set to “0,” only the keyboard performance sound from the device connected to the Aux Input jacks will be heard.

Chapter 7 User Program Registration

You can register the currently selected tones, transposition and volume balance, and a variety of other settings as “favorite performance settings” (User Program). This allows you to call up the registered favorite performance settings whenever you need them. Registering the settings you often use is makes it even more convenient for you.



For more on what can be registered to a User Program, refer to “Parameters Stored to Internal Memory” (p. 216).

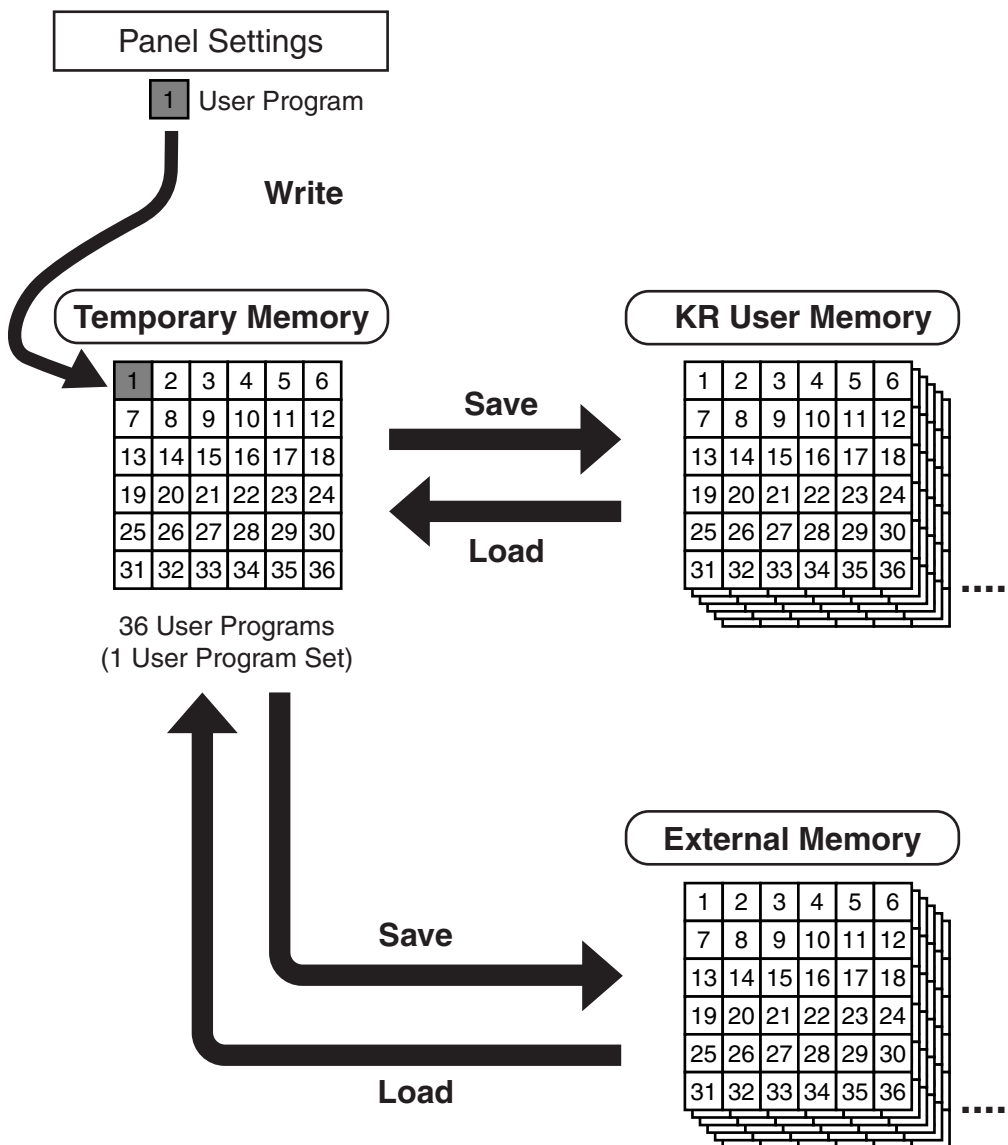

Saving Performance Settings (User Program)

Any collection of settings, including those describing the current status of your data selections or settings Automatic Accompaniment, can be saved to the [User Program] button. You can then call up the stored settings by pressing the [User Program] button. Saving your preferred combinations of Music Styles and Tones, as well as other frequently used settings, makes it more convenient.

You can register up to 36 User Programs to the KR.

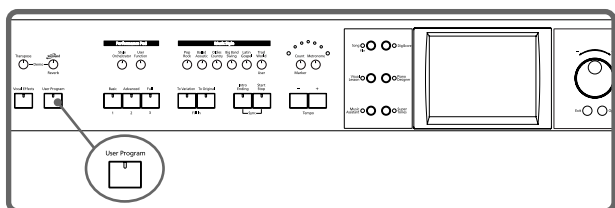

→ For more on what can be registered to a User Program, refer to “Parameters Stored in the User Program” (p. 216).

1. Set the Music Style, Tone, and other data until the settings are the way you want them.
2. Press the [User Program] button.

A “User Program screen” like the one shown below appears.



3. Touch <Write>.

A “Write User Program screen” like the following appears.



Giving a name to a set of User Programs

4. Touch <Rename>.

A “Rename screen” like the following appears.

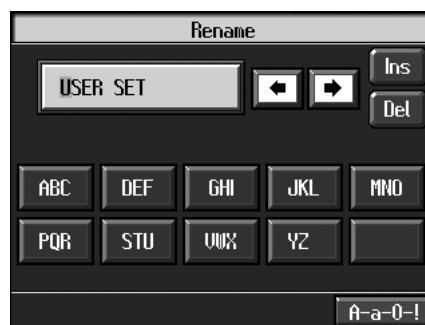

When you touch  , the cursor moves.

When you touch the icon for the character to be input, the character appears of the cursor position.

For example, touching the <ABC> icon in succession cycles you through the available choices in that character group (A→B→C→A...).

Each touch of <A-a-0-!> cycles the type of characters through “upper case,” “lower case,” “numerals,” “symbols,” then back to “English (upper case).”

When you touch , the character at the cursor position is deleted.

When you touch <Ins>, a space is inserted at the cursor position.

5. When you have finished with the name, press the [Exit] button.

You’re returned to the Write User Program screen.

Determining the Write Destination

6. Touch   to select the write-destination number.

7. Touch <Execute>.

The current performance settings are saved to the [User Program] button.

*** Never turn off the power while the display indicates <Writing...>. Doing so will damage the KR’s internal memory, making it unusable.**

→ You can restore the content registered to the [User Program] button to the original factory settings. Refer to “Restoring the Factory Settings (Factory Reset)” (p. 172).

Calling Up Saved User Programs

You can easily call up settings saved to the [User Program] button.

1. Press the [User Program] button.

The “User Program screen” appears.

Touch the scroll bar and drag up or down to scroll through the screen and display other name of User Programs.

Touch the page icons  > <  to change pages.

2. Touch the name of the User Program you want to call up.

When you touch the name of the User Program, the buttons or other performance settings instantly change to the previously saved settings.

■ Changing the Way User Programs Are Called Up

When calling up User Programs by touching program names in the “User Program screen,” you can select different types of settings depending on how long you touch the touch panel.

1. Press the [User Program] button.

2. Press the [Option] button.

A settings screen like the following appears.



3. Touch <Instant> or <Delayed> to select the setting.

Display	Explanation
Instant	Immediately after a User Program name is touched, the Automatic Accompaniment settings also switch.
Delayed	When you continue to touch the User Program name for a few moments, the Automatic Accompaniment settings are switched

4. Press the [Exit] button to return to the User Program screen.

For further information about the content stored in the User Programs, refer to p. 216.

Saving the User Program Sets

You can take the 36 User Programs saved to the [User Program] button and save them as a set to an external memory, or to user memory.

When saving to an external memory, first connect an external memory to the external memory port.

→ For more on working with the external memory, refer to “Using External Memories” (p. 113).

1. Press the [User Program] button.

2. Touch <File>.

3. Touch <Save>.

A “Save User Program screen” like the following appears.

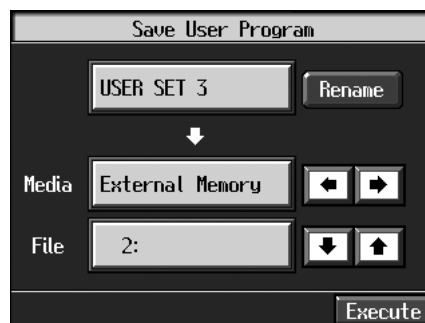

Giving a Name to a Set of User Programs

4. Touch <Rename>.

The Rename screen appears.

When you touch  , the cursor moves.

When you touch the icon for the character to be input, the character appears at the cursor position. For example touching the <ABC> icon in succession cycles you through the available choices in that character group (A→B→C→A...).

Each touch of <A-a-0-!> cycles the type of characters through “English (upper case),” “English (lower case),” “numerals,” “symbols,” then back to “English (upper case).”



When you touch , the character at the cursor position is deleted.

Chapter 7 User Program Registration

When you touch <Ins>, a space is inserted at the cursor position.

5. When you have finished with the name, press the [Exit] button.

Determining the Save Destination

6. Touch <Media>   to select the save-destination storage media.

7. Touch <File>   to select the save-destination User Program number.

If a User Program set name is displayed, a User Program set saved to that number is already.

If you select a number with previously saved User Program set data, then save a new set of data to that same number, the older User Program set will be deleted. If you don't want to lose any previously saved User Programs, select a number in the save-destination column that does not yet have a name.

Saving

8. Touch <Execute> to begin the save.

Press the [Exit] button to return to the User Program File screen.

- * **Never turn off the power or eject the external memory from the external memory port while the operation is in progress. Doing so will damage the KR's internal memory, making it unusable.**

→ When clearing the set of saved User Programs, refer to "Deleting Saved User Program Sets" (p. 133).

Loading Saved User Program Sets

User Programs that have been saved on external memories or in user memory can be called up, on an individual set basis, to the [User Program] button.

- * **Note that calling up these User Programs results in the deletion of all User Programs currently recorded to the [User Program] button.**

When loading a set of User Programs from an external memory, first connect the external memory to the external memory port.

→ For more on working with the external memory, refer to "Using External Memories" (p. 113).

1. Press the [User Program] button.
2. Touch <File>.
3. Touch <Load>.

A "Load User Program screen" like the following appears.

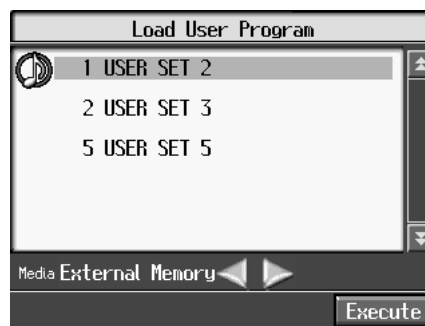

Specifying the Set of User Programs to be Loaded

4. Touch < < > > > to select the storage media to be read from.

Touch the scroll bar and drag up or down to scroll through the screen and display other name of User Programs.

5. Touch the name of User Program to load.
6. Touch <Execute>.

The selected User Programs are loaded to the [User Program] button.

- * **Never turn off the power or eject the external memory from the external memory port while the operation is in progress. Doing so will damage the KR's internal memory, making it unusable.**

Deleting Saved User Program Sets

You can delete individual User Program sets saved to external memories or in user memory.





When deleting a set of User Programs on an external memory, first connect the external memory to the external memory port.

→ For more on working with the external memory, refer to “Using External Memories” (p. 113).

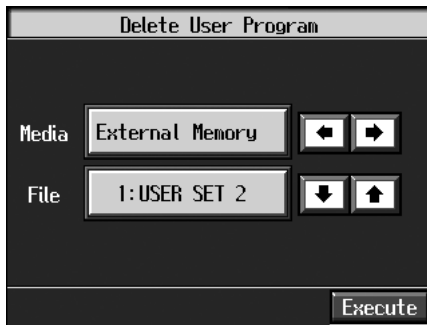
1. Press the [User Program] button.
2. Touch <File>.
3. Touch <Delete>.

A “Delete User Program screen” like the following appears.



4. Touch <Media>   to select the storage media.
5. Touch <File>   to select the set of User Programs to be deleted.
6. Touch <Execute>.

The selected User Programs are deleted.

* *Never turn off the power or eject the external memory from the external memory port while the operation is in progress. Doing so will damage the KR's internal memory, making it unusable.*

Copying Sets of User Programs on External Memories to the User Memory

You can copy sets of User Programs saved on external memories and to user memory.



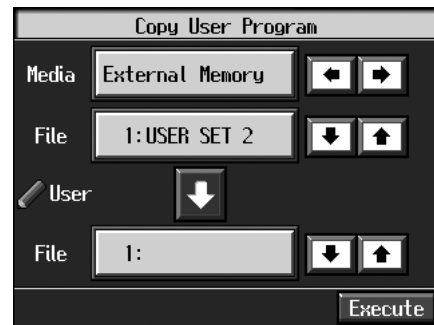

You can also copy sets of User Programs saved in user memory and to external memories.

1. Connect the external memory with the settings to be copied to the external memory port.
2. Touch the [User Program] button.
3. Touch <File>.
4. Touch <Copy>.

A “Copy User Programs screen” like the following appears.





Specifying the Copy Source

5. Touch <Media>   to select the storage media.
6. Touch <File>   to select the set of User Programs you want to copy.

If “All” is selected, all of the sets of User Programs on the external memory are copied to user memory.

Specifying the Copy Destination

7. Touch <User>   to select the copy destination for the set of User Programs.

If a User Program name is displayed, already a User Program saved to that number is already.

If you select a number with User Programs data, and then copy data to that number, the previously saved User Programs are deleted. If you do not want to delete the saved User Programs, select a number in the save-destination column for which no name is displayed.

8. Touch <Execute>.

The set of User Programs on the external memory is saved to user memory.

- * *Never turn off the power or eject the external memory from the external memory port while the operation is in progress. Doing so will damage the KR's internal memory, making it unusable.*

■ Coping Sets of User Programs Stored in the User Memory to External Memories

You can take User Program sets saved in user memory and copy them to external memories.

In this case, in the Copy User Programs screen in Step 4 above, touch the large arrow icon in the center to get the arrow to point up. This sets the KR to copy the User Program set in the user memory to the external memory.

The rest of the procedure is identical to that used for copying sets of User Program set from external memories to user memory.

Using the Pedal to Switch User Programs

You can assign the function of the sequential switching of the "User Programs" to the pedal. That way, each time you depress the pedal, the KR switches to the next User Program.

Great for use in concerts and similar situations, this allows you to prepare and save your User Programs in the sequence they are to be used, and then call up User Programs in the appropriate order while you perform, simply by depressing the pedal.

1. Press the [User Program] button.
2. Touch <Pedal> in the lower part of the screen.
A "PEDAL screen" like the following appears.

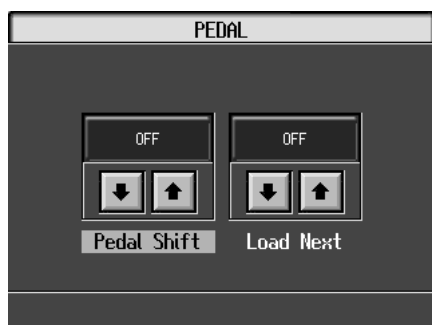

→ The Pedal Shift and Load Next settings are stored in each User Program set.

If you want to use the Load Next function to switch among User Programs saved to external memory, make sure to set Load Next in all of the User Program sets to "ON." Also, be sure to set the Pedal Shift value so it is for the same pedal.

■ Selecting the Pedal Used for Switching Settings (Pedal Shift)

3. Touch <Pedal Shift>   to select the setting.

Display	Explanation
OFF	You can use a function assigned to the pedal.
Left Pedal	The left pedal is dedicated to switching User Programs. The function assigned to the left pedal cannot be used.
Center Pedal	The center pedal is dedicated to switching User Programs. The function assigned to the center pedal cannot be used.

Press the [Exit] button to return to the User Program screen.

■ Sequential Loading of User Program Sets Stored (Load Next)

When using the pedal to switch your User Programs, you can also call up sequential sets of User Programs as saved to external memory. This feature is called the "Load Next" function.

3. Touch <Load Next>   to select the setting.

Display	Explanation
OFF	Switches Load Next off. The next press of the pedal after the 36th User Program is called up returns you to the first User Program of the same User Program set.
ON	Switches Load Next on. The next press of the pedal after the 36th User Program has been called up takes you to the first User Program in the next User Program set.

Press the [Exit] button to return to the User Program screen.

Simultaneously Switching User Program and Transmitting PC Numbers

You can have PC (Program Change) numbers be transmitted to an external MIDI device when you switch the User Program on the KR.

You can register PC number settings to each of the User Programs, just as you can with button settings and other settings preferences.



Calling Up the Performance Settings to Be Set

1. Press the [User Program] button, then touch the name of the performance setting you want to set.

Setting the Transmission of the PC

2. Press the [Option] button.
3. Touch <◀▶> <▶▶> to switch the page to display the following screen.



4. Touch   for the parameter and make the settings.

Display	Description
Bank Select MSB	Sets the Bank Select MSB.
Bank Select LSB	Sets the Bank Select LSB.
Program Change	Sets the Program Change messages (Program Numbers).
Tx PC Channel	This prevents the PC number from being transmitted (Off), or sets the transmission channel (Channel 1–16).

5. Press the [Exit] button.

The User Program screen returns to the display.

Touch <Write> to save the setting to the User Program. For more detailed information, refer to “Saving Performance Settings (User Program)” (p. 130).

Chapter 8 Creating and Editing Songs

Multitrack Recording with 16 Parts (16-Track Sequencer)

Multitrack recording always you to listen to previously recorded material while continuing to add performances of other parts.

The KR is capable of multitrack recording of up to sixteen parts. Since each part's performance is recorded using one tone, you can layer performances, using up to sixteen tones for the data in one song. The function used to layer these sixteen parts, one at a time, is called the "16-Track Sequencer."

16-Track Sequencer

You can record performances for up to 16 parts, overlaying them part by part, to create a single song.

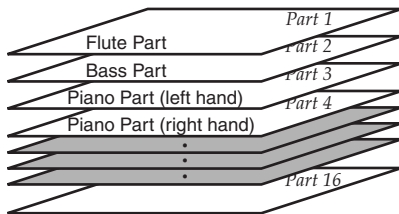

16-Track Sequencer and Track Buttons

In addition to the "16-Track Sequencer" function, the "Track Buttons" (p. 97) are another of the unit's playing/recording functions.

These five "Track buttons" are used for organizing the 16-Track Sequencer's sixteen parts. This allows you to use the 16-Track Sequencer to add more sounds to performances recorded with the Track buttons, and make even more detailed edits of the songs.

You can easily play back the original song data with the 16-Track Sequencer, mute parts by pressing the Track buttons, and more.

You cannot use the Track buttons while the "16-Track Sequencer screen" is displayed.

The Track buttons correspond to 16-track sequencer parts as shown below.

Track button	Part
[R/Rhythm]	D (10), S (11)
[1/Whole]	1
[2/Bass Accomp]	2, 5-9, 12-16
[3/Lower]	3
[4/Upper]	4

Since the 16-Track Sequencer records one tone to one part, you cannot use Layer performance (p. 31), Split performance (p. 32), or other such functions to record two or more tones simultaneously. Also, you can't record the performance with Automatic Accompaniment.

When you want to record with Automatic Accompaniment, then you should use the Track buttons for recording. (Refer to "Recording With Accompaniment" (p. 107)

Commercially Available Music Files

Commercially available song file recorded in Roland's SMF format is also composed of sixteen parts.

By loading the song file from the external memory and using the 16-Track Sequencer, you can then also edit the song file.

→ Although with commercially available Roland SMF music data, Part 11 is included in the [2/Bass Accomp] track button, other tracks match to the corresponding Track buttons.

* With some commercially available music files, you cannot edit the data.

■ The 16-Track Sequencer Screen

When recording with 16-track Sequencer, display the 16-track Sequencer screen.

1. Press the [Menu] button.

The "Composer Menu" or the "A/V Sync" screen appears.



2. Touch to switch the page, then touch <16trk Sequencer>.

A "16-track Sequencer screen" like the one shown below appears.



Icon	Explanation
<1>—<16>	Touch to select the part to be recorded, or the part whose settings are to be changed. The button for the selected part changes color.
	This Part to be played back
	This part is selected (Movement)
	The Part not to be played back (Muted Part)
	Parts that do not have performance data recorded to them.
Solo	Only the selected Part is played back.
Mute	This allows you to prevent the sound for the selected part from playing.
Clear	The performance data for the selected part is deleted.
Part	This displays the Part Settings screen, in which you can make detailed settings for each part. For details refer to p. 137.
Tone Set	The Tone Set screen appears. For details refer to p. 138.

■ Modifying the Settings of Each Part

You can change the Tones and volume, as well as mute the playback, for each individual part in songs recorded with the 16-track Sequencer and the internal songs.

→ Because commercially available Roland SMF music files are also made up of 16 Parts, you can change the settings for the individual Parts and play them back in the same way.

First, select the song for which the settings are to be made (p. 75).

1. Display the 16-track Sequencer screen (p. 136).
2. Touch the screen to choose the Part for which you want to make settings.
Change the settings for the selected Part.

Display	Function
Solo	Only the selected Part is played back.
Mute	Toggles playback of the selected Part to on or off.
Clear	The performance data for the selected part is deleted.

* When you touch <Clear>, a message asking you to confirm the deletion appears. To erase the recorded sound, touch <OK>. If you don't want to erase the recorded sound, touch <Cancel>. Once a performance has been erased, it can't be restored.

* You cannot touch <Clear> during playback of the song.

3. Touch <Part> to make more detailed settings for the selected part.

A screen like the one shown below appears.

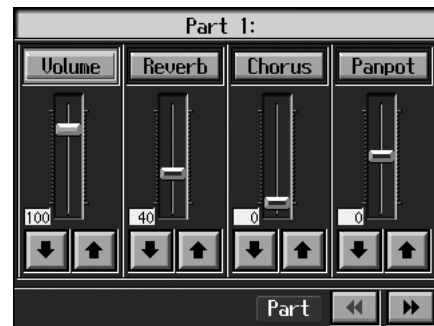

You can change the Tone for the selected Part by pressing a Tone button while this screen is displayed. When selecting Part 10 or 11, you can touch <Drum Set> to select the drum set or effect sound. The Part name and tone name are displayed at the top of the screen.

4. Touch for the corresponding item to change the setting.



You can adjust the values by touching the desired parameter and turning the dial or by touching and dragging the slider.

Display	Explanation
Volume	Changes the volume level.
Reverb	Changes the amount of reverb effect applied to the sound.
Chorus	Changes the amount of chorus applied.
Panpot	Shifts the direction from which the sound is heard between left and right. Touch to shift the sound to the right, or touch to shift it to the left.

What's Panpot?

Panpot is the control that determines the placement of the sound in the stereo sound field between left and right speakers. By altering the Panpot setting, you can change the perceived location of the sound between the left and right speakers.

When you press the [▶/■ (Play/Stop)] button, you hear what the song sounds like as you change the settings. When you press the [▶/■ (Play/Stop)] button, playback of the song stops.

5. Touch   to make settings for other parts.

The Part name appears at the upper part of the screen. Change the settings for other parts as needed.

6. Hold down the [● (Rec)] button and press the [◀ (Reset)] button.

This operation set the changes in the settings.

The song can then be saved to an external memory or to user memory.

If you do not want to delete a song after changing the settings for the individual parts, save the song to an external memory or to user memory (p. 116).

* You cannot save the settings that determine whether sounds for each individual part are played or not (solo and mute).

If the Following Message Appears

If you try to display another screen after you've changed the song's settings for each Part, a message like the one below may appear.



Touch <OK> to change the song's settings.

Touch <Cancel> to discard the changes you're made.

Getting the Most Suitable Part Tones for the Musical Genre (Tone Set)

"Tone Set" is a function that automatically assigns the most suitable tones for the selected musical style.

When you're creating a song, you can assign Tone sets, then change the Tones to suit the ideas you have for your song.

1. Display the 16-track Sequencer screen (p. 136).
2. Touch <Tone Set> in the lower part of the screen.

A screen like the one shown below appears.



3. Touch the screen to select a musical genre.
4. Press the [Exit] button.

The 16-track Sequencer screen appears.

Tones for each part are assigned automatically.

* In some genres, some parts may have no tone assigned.

■ Recording a Performance

○ Start Recording

Selecting the Part to Record

1. Display the 16-track Sequencer screen (p. 136).
2. Touch the number for the Part you want to record.
The button for the touched part being set turns orange.
You can only record drum sounds or effect sounds on Part D (10) or Part S (11). You can select drum sets or effect sounds by selecting Part D (10) or Part S (11) and touching <Drum Set>.

Selecting the Sound to Play

3. Use the Tone buttons to choose a Tone to play.
After selecting a Tone, press the [Exit] button to call up the "16-Track Sequencer screen."

Recording the Performance

4. Press the [◀ (Reset)] button.
Recording will start at the beginning of the song.
If you want to record from a point other than the beginning, use the [◀◀ (Bwd)] and [▶▶ (Fwd)] buttons to select another measure to begin.
5. Press the [● (Rec)] button and watch the indicator is light up.
The KR is put in recording standby.
6. Press the [▶ / ■ (Play/Stop)] button.
A two-bar count-in sounds, then recording starts.
7. Press the [▶ / ■ (Play/Stop)] button.
Recording stops.
When one part is recorded, continue by selecting and recording another part. Continue layering parts to finish recording the song.
→ If necessary, choose a recording method. For more on how to record, refer to the following paragraph. If you record for the first time, there's no need to select the recording method.
* Any performance that has been recorded is deleted when the power to the KR is turned off. It is a good idea to save song data to an external memory or user memory. For more information, refer to "Saving Songs" (p. 116).

○ Prepare for New Song Recording

Selecting the Song to Record

1. Hold down the [Song] button and press the [● (Rec)] button.
The following screen is displayed if there is any previously recorded performance or any song with changed settings.



Touch <OK> to delete the song.

Determining the Song's Beat and Tempo

2. Press the [Metronome] button to select the beat (p. 54).
→ You can't change a song's beat once it's been recorded. If you want to compose a song whose beat changes partway through the song, take a look at "Changing the Beat in the Middle of a Song (Beat Map)" (p. 150).
3. Press the Tempo [-] and [+] buttons to set the basic tempo of the song.
If you do not need the metronome sound, press the [Metronome] button once more.
→ When using song data that has already been recorded, the recording is made using the source song's basic tempo. To change the basic tempo of a song, please refer to "Changing the Tempo of Recorded Songs" (p. 151).

Changing the Recording Method (Rec Mode)

You can use any of the four methods below to record with the KR.

Although you will normally be using “Replace Recording,” where previously recorded material is erased when new sounds are recorded, you’ll find that you can record songs easily by using this method in combination with other recording methods.

Replace Recording (p. 140)

This is the normal method for recording. New material is recorded as previously recorded material is erased.

Mix Recording (p. 141)

New notes are recorded on top of notes previously recorded.

This convenient feature makes it easy for you to record melodies over prerecorded accompaniment.

Loop Recording (p. 141)

Specified measures are recorded repeatedly, while new notes are combined with existing music. A convenient feature for creating rhythm parts. Loop Recording allows you to record over and over within a selected segment, adding a different percussion sound with each pass.

Punch-in Recording (p. 142)

You can re-record only a specified passage as you listen to a recorded performance.

→ Immediately after the power is turned on, Replace Recording is selected.

Changing the Recording Method

1. Press the [Menu] button.

The “Composer Menu” or the “A/V Sync” screen appears.



2. Touch <Rec Mode>.

A “Rec Mode screen” like the following appears.



3. Touch <Rec Mode> to select the recording mode.

Display	Recording Method
Replace	Replace Recording
Mix	Mix Recording
Loop	Loop Recording
Auto Punch-In/Out	Punch-in recording of the interval between set markers.
Manual Punch-In/Out	Punch-in recording starting from the point at which the pedal, the Performance Pad or the [● (Rec)] button is pressed. For more about Punch In Recording, refer to p. 142.
Tempo	You can add tempo changes to a recorded composition. See p. 151.

4. Press the [Exit] button.

Returns to the “Composer Menu” screen.

Recording While Erasing the Previous Recording (Replace Recording)

The recording process where previous material is erased as new material is recorded is called “replace recording.” This setting is in effect when you turn on the power.

1. In the “Rec Mode screen” (p. 140), select <Replace>.

Press the [Exit] button to return to The “Composer Menu” screen.

The KR is set to the replace recording mode.

Record the performance using the procedures described in Chapter 4 (p. 104), “Multitrack Recording with 16 Parts (16-Track Sequencer)” (p. 136).

■ Layering a Recording Over Previously Recorded Sounds (Mix Recording)

You can record a performance layered over a previously recorded performance. This method is called “Mix Recording.”

1. In the “Rec Mode screen,” select <Mix>.

Press the [Exit] button to return to The “Composer Menu” screen.

The KR is set to the mix recording mode.

Record the performance using the procedures described in “Recording While Selecting the Track Buttons (Redoing Recordings)” (p. 110), “Multitrack Recording with 16 Parts (16-Track Sequencer)” (p. 136), or other methods.

* After you have finished with mix recording, return to the usual replace recording mode.

■ Repeated Recording at the Same Location (Loop Recording)

You can record a specified passage over and over, layering sounds with each pass. This method is called “Loop Recording.” This is handy when recording a Rhythm Part.

For example, use this method to make a Loop Recording of a four-measure segment. First record the bass drum, the snare drum next, then the hi-hat and so on, layering a different instrument onto the same four measures. After you have finished recording the four-measure rhythm pattern, you can then use the procedure in “Copying Measures (Copy)” (p. 146) to create as many copies of the four measures as you need to complete your Rhythm part.

1. Place A and B markers at the beginning and end of the passage you want to record.

Take a look at “Setting Markers for Repeated Practice (Marker)” (p. 98).

If you haven’t recorded anything yet, then use “Blank Recording” to create the necessary number of measures before placing the markers.

What is Blank Recording?

Blank Recording is recording a number of silent measures with no content.

1. Set the basic tempo and beat of the song.

2. Hold down the [● (Rec)] button and press the [▶/■ (Play/Stop)] button.

The indicators for the [● (Rec)] and [▶/■ (Play/Stop)] buttons both light up, then after two measures of the count sound, recording begins.

3. Without performing anything, record only the required number of measures, then press the [▶/■ (Play/Stop)] button.

The indicators for the [● (Rec)] and [▶/■ (Play/Stop)] buttons both go out, and recording stops.

2. In the Rec Mode screen (p. 140), select <Loop>.

Press the [Exit] button to return to The “Composer Menu” screen.

The recording method changes to loop recording.

3. Press the [● (Rec)] button.

4. Press the Track button for the track to be recorded.

The KR is put in recording standby.

5. Press the [▶/■ (Play/Stop)] button to begin recording.

Recording starts from Marker A.

When the song reaches Marker B, it then returns to Marker A, where recording continues.

Each time the recording is looped, the newest sounds are layered over previously recorded sounds.

6. When you press the [▶/■ (Play/Stop)] button, recording stops.

* After you have finished with loop recording, return to the usual replace recording mode (p. 140).

Loop Recording Shortcut

You can also use the method described below to set Loop Recording.

1. Place A and B markers at the beginning and end of the passage you want to record.

Take a look at “Setting Markers for Repeated Practice (Marker)” (p. 98).

If you haven’t recorded anything yet, then perform “Blank Recording” for the necessary number of measures before placing the markers.

2. Touch the <Repeat> icon in the Marker screen (p. 99).

This sets the loop recording mode.

Start a recording.

* After you have finished with loop recording, touch the <Repeat> icon in the “Marker screen” once more to return to the usual replace recording mode.

Re-Recording Part of Your Performance (Punch-in Recording)

You can re-record part of a passage as you listen to a recorded performance. This recording method is called “Punch-in Recording.” This convenient function lets you record over a specified points in a part as you listen to a prerecorded performance in another section.

User Punch-In Recording by the following two methods:

Recording the Region Defined by Markers A and B (Auto Punch-In/Out)

Before you start recording, place markers A and B to define the passage you want to re-record. Make the setting for punch-in recording, and re-record just the passage between markers A and B.

Recording From the Point at Which the Pedal or Buttons Are Pressed (Manual Punch-In/Out)

You can play back a performance and depress the pedal at the desired place to start re-recording. Depressing the pedal a second time cancels recording and returns you to playback.

Instead of pressing the pedal, you can press a performance pad or the [● (Rec)] button to start and cancel recording.

Recording a Passage Specified by Markers

1. Before you start re-recording, place markers A and B to define the passage.

Following the procedures described in “Setting Markers for Repeated Practice (Marker)” (p. 98), use Markers A and B to specify the passage.

2. In the Rec Mode screen (p. 140), select <Auto Punch In/Out>.



This changes the recording mode to “Punch-In Recording.”

Press the [Exit] button to return to The “Composer Menu” screen.

3. Begin recording.

Begin recording using the procedures described in “Recording While Selecting the Track Buttons (Redoing Recordings)” (p. 110) or “Multitrack Recording with 16 Parts (16-Track Sequencer)” (p. 136).

Up until the specified passage, the previously recorded performance plays back.

When you reach the specified passage, sounds are erased as recording starts; begin playing now.

When you reach the end of the specified passage, recording stops, and the KR returns to playback of the previously recorded performance.

4. When you press the [▶/■ (Play/Stop)] button, the song stops.

Starting Recording from the Measure Specified by Buttons and Pedals

If using the Performance Pads or pedals, you must first change the function of the pedals and Pads. Follow the procedures in “Assigning Functions to Pedals and Performance Pads (Pedal Setting/User Functions)” (p. 167), and assign <Auto Punch In/Out> to the buttons or pedal.

1. In the Rec Mode screen (p. 140), select <Manual Punch In/Out>.

This changes the recording mode to “Punch-In Recording.”

Press the [Exit] button to return to The “Composer Menu” screen.

2. Begin recording.

Begin recording using the procedures described in “Recording While Selecting the Track Buttons (Redoing Recordings)” (p. 110) or “Multitrack Recording with 16 Parts (16-Track Sequencer)” (p. 136).

The previously recorded performance will be played back.

Press the pedal to which Punch In/Out is assigned (p. 167), a performance pad, or the [● (Rec)] button to begin recording, then start your performance.

Recording stops when you press the pedal, the Performance Pad, or the [● (Rec)] button again, and the previously recorded performance is played back.

3. When you press the [▶/■ (Play/Stop)] button, the performance stops.

* When you’re finished with Punch-In Recording, return to the ordinary Replace Recording mode. Take a look at “Changing the Recording Method” (p. 140).

Composing an Accompaniment By Entering Chords (Chord Sequencer)

You can enter a chord progression and choose the places where the accompaniment pattern will change to create an accompaniment for a song. This feature is called “Chord Sequencer.”

Thanks to the chord sequencer, you can create an accompaniment ahead of time and play along with your right hand.

1. Press the [Menu] button and watch the indicator light up.

The “Composer Menu” screen appears.

2. Touch < ⏪ > < ⏩ > to switch the page, then touch <Chord Sequencer>.

The screen like the one shown below is called “Chord Sequencer screen.”

This is the “cursor.” The cursor shows where the chord change or other information is input. This is the end of the song. When continuing to add input, insert measures by touching <Ins>.

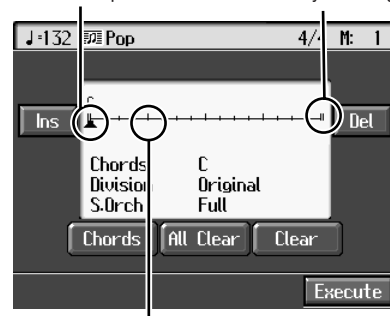

This indicates the position where the accompaniment pattern (Division) or the Style Orchestrator changes.

Display	Explanation
Ins	One measure is inserted before the measure where the cursor is positioned.
Del	The measure in which the cursor is positioned is deleted.
Chords	Allows input of chords without playing the keyboard. Refer to “Inputting Chords without Playing the Keyboard” (p. 144).
All Clear	Deletes all of the data that’s been input.
Clear	Deletes the data at the cursor position.
Execute	Records the input chord progression. Touch this icon when you have finished inputting all of the chords.

3. Press a Music Style button or the touch screen to select a Music Style (p. 61).

Chapter 8 Creating and Editing Songs

4. Press the [Exit] button.

You are returned to the Chord Sequencer screen.

5. Enter the chord progression and the accompaniment pattern.

Refer to "Inputting Chords with the Chord Sequencer."

6. When you have finished inputting all the data, touch <Execute>.

When storage of the data is complete, return to The "Composer Menu" screen.

Now, press the [▶/■] (Play/Stop) button, and try playing the melody along with the accompaniment you created.

* *Songs you've created are discarded as soon as you turn off the power. If you do not want to delete the song, save it to an external memory or to user memory. Refer to "Saving Songs" (p. 116).*

Inputting Chords with the Chord Sequencer

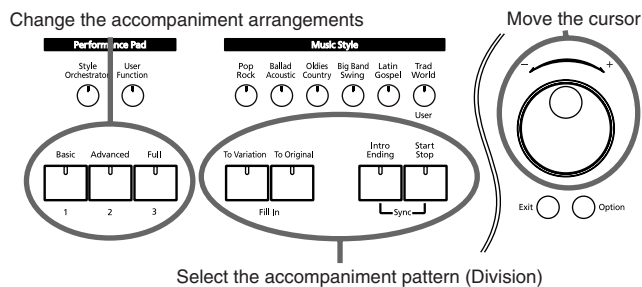

1. Use the dial to move the cursor to the input position.

Use the [◀◀] (Bwd) and [▶▶] (Fwd) buttons to move the cursor one measure at a time.

2. Enter the chord progression and the changes in the accompaniment pattern and arrangement.

Just as when performing with Automatic Accompaniment, press the keys to specify a chord, and press a button to select the accompaniment pattern (p. 68). You can change the Style Orchestrator with the Performance Pads (p. 69).

3. Touch <Ins> once to insert one measure before the measure where the cursor is currently positioned.

If you touch , the measure where the cursor is currently positioned is deleted, while the measures that follow are moved forward.

To remove what you have input, move the cursor to the position with input you want to delete, then touch <Clear>. This deletes the entered setting.

→ *You can only insert an intro at the beginning of a song. When you add an intro, the number of bars corresponding to the length of the intro is inserted automatically.*

Functions That Can Be Assigned to the Pedals and the Performance Pads

→ *For instructions on assigning functions, refer to "Assigning Functions to Pedals and Performance Pads (Pedal Setting/User Functions)" (p. 167).*

- Inputting a short Intro and Ending
Assign "Intro 2/Ending 2" to a pedal or pad.
- Inputting a "Variation" or "Original" without a Fill-In
Assign "Original/Variation" to a pedal or pad.
- Using the keyboard to input slash chords (such as Fm/C)
Assign "Leading Bass" to a pedal or pad.
- Inputting a break somewhere within the song
Assign "Break" to a pedal or pad.
- Insert half fill-ins (fill-ins lasting half a measure)
Assign "Half Fill In" to a pedal or pad.

Check the Accompaniment You Inserted

Here's how to play back as much of the accompaniment as you have input.

1. Press the [◀] (Reset) button to return to the beginning of the song.
2. When you press the [▶/■] (Play/Stop) button, the performance is played back.
3. Playback stops when you press the [▶/■] (Play/Stop) button once more.

Inputting Chords without Playing the Keyboard

You can use <Chords> at the bottom left of the Chord Sequencer screen to specify chords on the screen.

1. At the Chord Sequencer screen, touch <Chords>.

A screen like the one shown below appears.

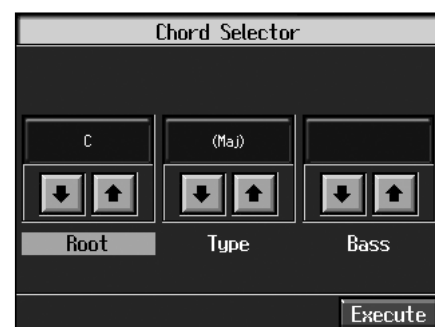

2. Touch [↑] [↓] in each to specify the chords.
3. Touch <Execute> to enter the chord.

You are returned to the Chord Sequencer screen.

Editing Songs

There are many ways you can edit performances recorded using the KR Track button or 16-track sequencer.

Basic Operation of the Editing Functions

- * While songs are being loaded, the measure number in the upper right of the screen is highlighted (text and background are inverted). Start editing the song only after the measure number is no longer highlighted.

Selecting the Editing Function

1. Press the [Menu] button and watch the indicator light up.

The “Composer Menu” or the “A/V Sync” screen appears.

2. Touch <◀▶> <▶▶> to switch the page, then touch <Song Edit>.

A “Song Edit screen” like the following appears.



3. Touch an editing function to select that function.

For more detailed information, refer to the corresponding page for each function.

Function	Explanation	Page
Undo	Undoes editing operations that have been performed.	p. 145
Copy	Copies measures	p. 146
Quantize	Evens out sounds in recorded performances.	p. 146
Delete	Deletes measures.	p. 147
Insert	Inserts a blank measure.	p. 147
Transpose	Transposes parts individually.	p. 148
Erase	Erases data in measures, creating blank measures.	p. 148
Part Exchange	Exchanges the sounds in parts.	p. 149
Note Edit	Allows corrections to be made note by note.	p. 149
PC Edit	Allows editing of the Tones changes that occur during a song.	p. 150

→ “PC” stands for “Program Change,” which is a command that tells an instrument to change the sound it’s using. With songs that rely on the use of a variety of sounds, a “PC” needs to be located at every point within the song where the Tone is to be changed

- * Some edits can’t be undone, not even by choosing “Undo.” We recommend saving songs to external memories or to user memory before editing. For more on how to save songs, refer to “Saving Songs” (p. 116).

Editing

4. Touch the item to be edited.

5. Set the value with the dial.

To cancel the operation once it is underway, press the [Exit] button.

6. When you’re done making all the settings, touch <Execute>.

When you are finished editing the setting, return to the “Song Edit screen.”

Press the [Exit] button to return to The “Composer Menu” screen.

→ You can play back edited songs by pressing the [▶/■ (Play/Stop)] button in the “Song Edit screen.”

Undoing Edits (Undo)

You can cancel an editing operation that you’ve just carried out. This is handy when you want to undo an edit and restore data to the way it was before.

- * There are some edits that can’t be restored.

At Step 3 of “Selecting the Editing Function” (p. 145), select <Undo>.

Editing functions that can be undone appear on screen.

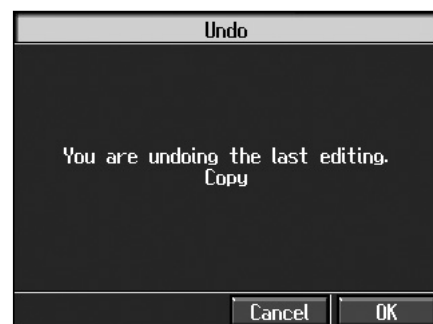

If you touch <Cancel>, the undo is cancelled, and you’re returned to the Song Edit screen.

If you touch <OK>, the confirmation message appears on screen. Touch <OK> to undone the most recent edit.

Chapter 8 Creating and Editing Songs

■ Copying Measures (Copy)

You can copy a portion of a performance to a different bar in the same Part or to a measure in another Part. This is handy when you're composing a song that repeats a similar phrase.

Ex. To copy measures 5–7 to measure 8.

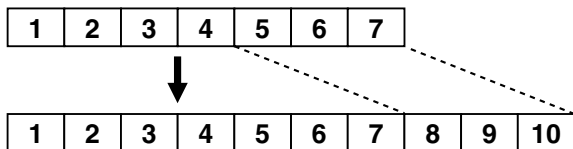

At Step 3 of "Selecting the Editing Function" (p. 145), select <Copy>.

A screen like the one shown below appears.

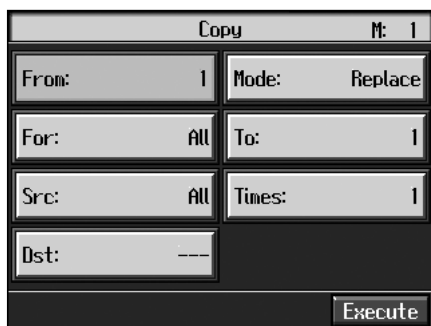

Item	Content
From	Measure number of the first measure of the segment to be copied
For	Number of measures to be copied
Src	Copy-source Track button or part number Choosing "All" copies all Parts. "---" appears in the <Dst> column. If you choose a Track, you can only copy to the selected Track. You cannot copy to the other Track. "---" appears in the <Dst> column.
Dst	Copy-destination part number
Mode	Data can be copied in the following three ways:
	Replace If there is a performance recorded at the copy destination, this previous recording is erased, and the copied data is written in its place.
	Mix If there is a performance recorded at the copy destination, the copied data is layered over the previous recording. If the Tones used for the copy source and copy destination are different, the copy-destination Tone is used.
	Insert If there is a performance recorded at the copy destination, the copied portion is inserted without erasing the previous recording. The song is lengthened by the number of inserted measures.

Item	Content
To	Copy-destination measure number When "End" is selected, the data is copied to the end of the song.
Times	Number of times the data is to be copied

■ Correcting Timing Discrepancies (Quantize)

You can correct for timing discrepancies in a recorded performance by automatically aligning the music with the timing you specify. This is called "Quantizing."

As an example, let's say that the timing of some quarter-notes in a performance is a little off. In this case, you can quantize the performance with quarter-note timing, thus making the timing accurate.

Example: Quarter-note resolution



Example: Sixteenth-note resolution

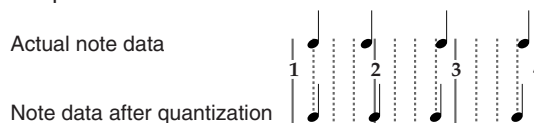

At Step 3 of "Selecting the Editing Function" (p. 145), select <Quantize>.

A screen like the one shown below appears.

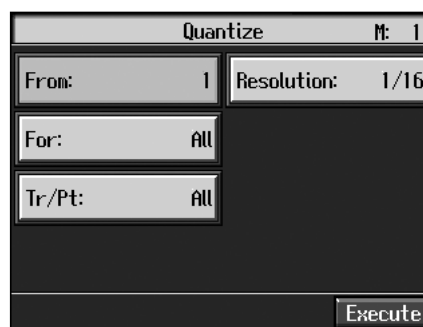

Item	Content
From	Measure number of the first measure of the segment to be quantized
For	Number of measures to be quantized
Tr/Pt	Track button or part number to be quantized Choosing "All" quantizes the same passage in all Parts.

Item	Content
Resolution	Quantization timing
	Select one of the following values 1/2 (half note), 1/4 (quarter note), 1/6 (quarter-note triplet), 1/8 (eighth note), 1/12 (eighth-note triplet), 1/16 (sixteenth note), 1/24 (sixteenth-note triplet), 1/32 (thirty-second note)

When finished with the Quantize settings, return to the Song Edit screen.

■ Deleting Measures (Delete)

You can delete a part of a performance measure by measure. When a portion of a performance is deleted, the rest of the performance is shifted up to fill the gap. Erasing measures in a specified passage is called “deleting.”

Ex. To delete measures (bars) 5–8

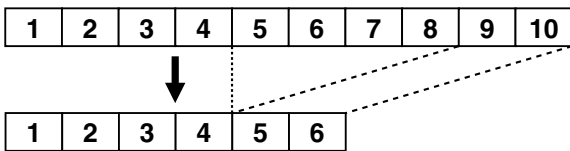

At Step 3 of “Selecting the Editing Function” (p. 145), select <Delete>.

A screen like the one shown below appears.



Item	Content
From	Measure number of the first measure of the segment to be deleted
For	Number of measures to be deleted
Tr/Pt	Track button or part number to be deleted When “All” is selected, the same portion of all parts is deleted.

■ Inserting Blank Measures (Insert)

You can add a blank measure at a location you specify. This addition of a blank measure is called “insertion.”

Ex. To insert measures (bars) 5-7

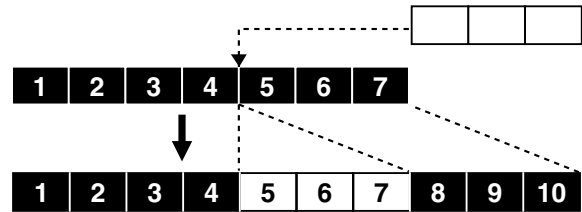

At Step 3 of “Selecting the Editing Function” (p. 145), select <Insert>.

A screen like the one shown below appears.

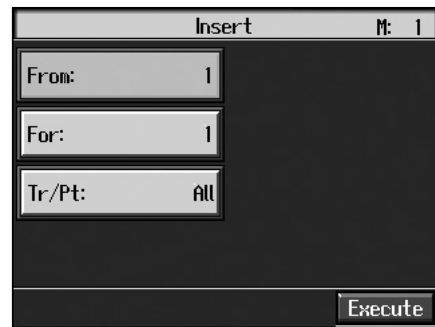

Item	Content
From	Measure number of the first measure of the segment to be inserted
For	Number of measures to be inserted
Tr/Pt	Track button or part number where data will be inserted When “All” is selected, blank measures are inserted at the same place in all parts.

■ Transposing Individual Parts (Transpose)

You can transpose specified parts and tracks individually.

At Step 3 of “Selecting the Editing Function” (p. 145), select <Transpose>.

A screen like the one shown below appears.

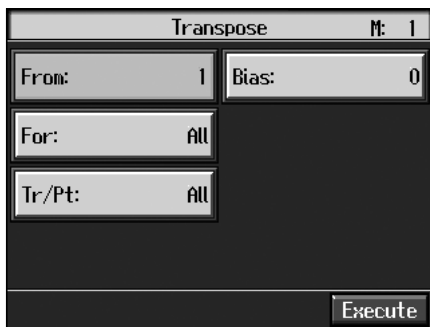

Item	Content
From	Measure number of the first measure of the segment to be transposed
For	Number of measures to be transposed
Tr/Pt	Track button or part number to be transposed When “All” is selected, the same portion of all parts is transposed.
Bias	The range of transposition You can select the range to transpose the data, from -24 (two octaves down) to +24 (two octaves up), adjustable in semitones.

* You cannot transpose performances of the drum sets and sound effect sets (such as the Rhythm Track).

■ Making Measures Blank (Erase)

You can delete the performance data in a specified block of measures, turning them into blank measures without reducing the length of the song. This process is called “erasing.”

Ex. To erase measures (bars) 5-8

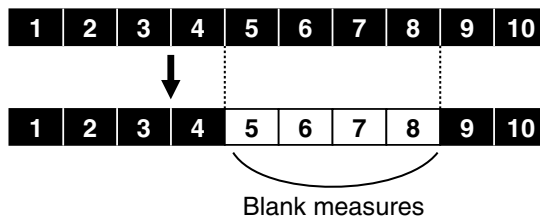

Follow the steps in “Selecting the Editing Function” (p. 145) to choose <Erase>.

A screen like the one shown below appears.



Item	Content
From	Measure number of the first measure of the segment to be erased
For	Number of measures to be erased
Tr/Pt	Track button or part number to be erased When “All” is selected, the same portion of all parts is erased.
Event	Select from the following types of performance data to erase:
	All All performance data, including notes, tempos, tones switches, volume changes, etc., are erased.
	Tempo Tempo data is erased. Erasing the tempo data for all measures results in a single, constant tempo.
	Prog.Change Erases the data for switching Tones (p. 145).
	Note Erases only notes.
Except Note Erases all of the performance data except for the notes.	

Item	Content
Event	Expression Erases Expression (volume change) information.
	Lyric Erases only lyrics.

■ Exchanging Parts (Part Exchange)

You can exchange the notes recorded for a particular part with the notes recorded for another part. This process of exchanging parts is called “part exchange.”

At Step 3 of “Selecting the Editing Function” (p. 145), select <Part Exchange>.

A screen like the one shown below appears.

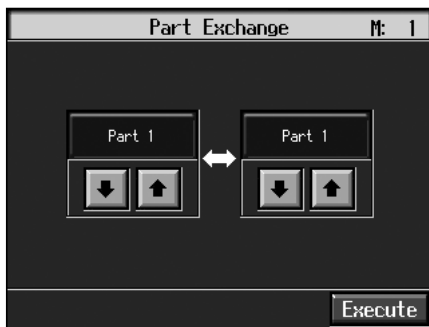

Touch each   to choose Parts you want to exchange.

■ Correcting Notes One by One (Note Edit)

You can make corrections in a recorded performance one note at a time. This process of making changes in individual notes is called “note editing.”

You can make these corrections by using note editing:



- Deleting misplayed notes
- Changing the scale of a single note
- Changing the force used in playing a single key (velocity)
- Change the finger number

At Step 3 of “Selecting the Editing Function” (p. 145), select <Note Edit>.

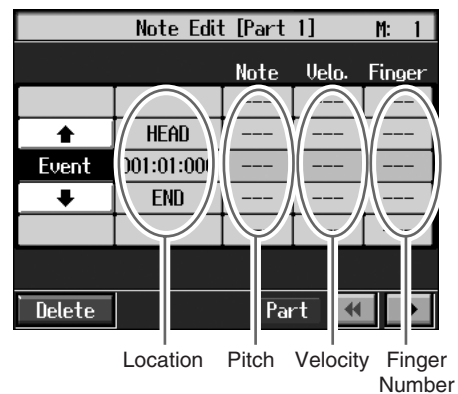
A screen like the one shown below appears.



The note-location display uses “Measure: Beat: Tick” as the format. A tick is a unit of time that’s shorter than a beat.

Touch   to select the part with the note to be corrected. The Part number appears at the top of the screen.

Use the [<<< (Bwd)] button and the [>>> (Fwd)] button or use <↑> <↓> on the screen to find the note to be corrected.

When you’ve found the note you want to correct, touch “Note” or “Velo.” for the note.

Use the dial to correct the pitch or velocity. If you want to delete the note, touch <Delete>.

When you’re done making all the settings, press the [Exit] button.

■ Modifying the Tone Changes in a Song (PC Edit)

In some songs, the instrument sound changes during the course of the song (that is, the Tone changes in the middle of a Part). In such songs, an instruction to switch the Tone is inserted at the place where you want the sound to change. This instruction is called a “Program Change” (PC), and actions such as deleting program changes, or changing the selected Tone by them are called “PC editing.”



* *It is not possible to insert a program change into a measure or beat that does not contain a program change.*

At Step 3 of “Selecting the Editing Function” (p. 145), select <PC Edit>.

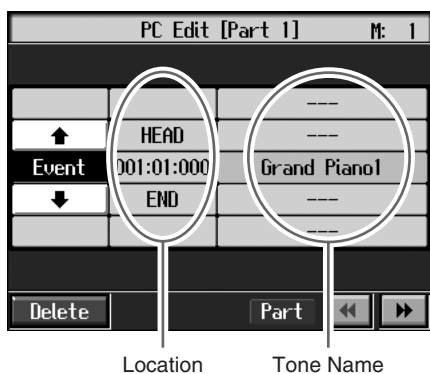

A screen like the one shown below appears.



The PC-location display uses “Measure: Beat: Tick” as the format. A tick is a unit of time that’s shorter than a beat.

Touch   to select the part with the program change to be edited.

The Part number appears at the top of the screen.

Use the [] (Bwd)] button and the [] (Fwd)] button or use <↑> <↓> on the screen to find the program change to be edited.

When you’ve found the Program Change you want to modify, touch “Tone Name” on the screen.

Press a Tone button to select a Tone group, then select a Tone with the dial. When selecting Part 10 or 11, select the drum set or effect sound.

If you want to delete the Program Change, touch <Delete>.

When you’re done making all the settings, press the [Exit] button.

Changing the Beat in the Middle of a Song (Beat Map)

You can create songs that have beat changes during the course of the song.

* *You can’t change a song’s beat once it’s been recorded. Before recording the performance, determine the beat to be used.*

1. Press the [Menu] button.

The “Composer Menu” or the “A/V Sync” screen appears.

2. Touch <Beat Map>.

The following screen is displayed if there is any previously recorded performance or any song with changed settings.



Touch <OK> to change the song’s settings.

Touch <Cancel> to discard the changes you’re made.

A screen like the one shown below appears.

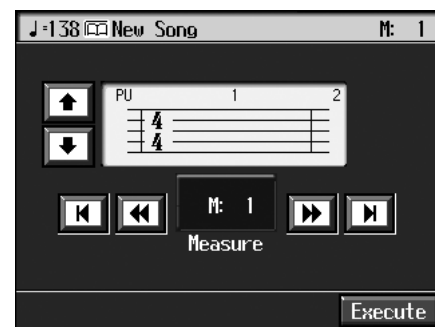

If you’ve recorded a song or changed a song’s settings (see p. 137), a message asking you to confirm the deletion appears.

3. Use <◀▶> in the screen or the [] (Bwd)] and [] (Fwd)] buttons to move to the measure whose beat you want to change.

The measure number appears in the top-right area of the screen.

Touch <⏮> to move to the beginning of the song.

Touch <⏭> to move to the end of the song.

4. Touch in each to set the beat.

5. Touch <Execute>.

The beat change starts with the measure you selected. Repeat Steps 3–5 to make beat settings in other measures as needed.

Recording the Performance

6. Press the [Exit] button twice.

The screen displayed before you pressed the [Menu] button appears.

7. Press the [⏪ (Reset)] button to return the measure number to “1.”

8. Start a recording.

Record the performance using the procedures described in “Chapter 5 Recording and Saving the Performance” (p. 104). Specify the measure, then change the beat.

Changing the Tempo of Recorded Songs

You can change the basic tempo of a composition. The basic tempo was initially set when the song was recorded.

1. Press the Tempo [-] and [+] buttons to choose a tempo.

2. Hold down the [● (Rec)] button and press the [⏪ (Reset)] button.

The song’s basic tempo changes.

The change in basic tempo is discarded when you turn off the power or choose a different song. Save important song data to external memory or to user memory (p. 116).

* If the song you’re working on has tempo changes, press the [⏪ (Reset)] button to go back to the beginning of the song before you carry out this operation.

Changing the Tempo Within the Song

You can add tempo changes to a recorded composition.

The KR stores song tempo information and performance data separately. Therefore, when making changes to the tempo in a song, you must record the changes in the tempo information independently of the performance data.

This recording of the tempo is called “Tempo Recording.”

■ Adjusting the Tempo While Listening to a Song

You can add ritardando and other such gradual tempo changes.

Setting the Rec Mode to “Tempo”

1. Press the [Menu] button.

The “Composer Menu” or the “A/V Sync” screen appears.

2. Touch <Rec Mode>.

A screen like the one shown below appears.



3. Touch the <Rec Mode> [↑] [↓] to select <Tempo>.

This makes the setting for tempo recording.

Press the [Exit] button a number of times to switch to the screen where the measure number is indicated in the upper right of the screen.

When the KR goes into Tempo Recording, the tempo indication is highlighted.

Recording the Tempo

4. Use the [◀◀ (Bwd)] and [▶▶ (Fwd)] buttons to move slightly before the measure where you want to change the tempo.

5. Press the [● (Rec)] button and watch the indicator is flashing.

The KR is put in recording standby.

6. When you press the [▶/■ (Play/Stop)] button, recording begins.
7. When you get to the place where you want to change the tempo, use the Tempo [-] and [+] buttons or the dial to vary the tempo as desired.
8. When you press the [▶/■ (Play/Stop)] button, recording stops.

The song's tempo changes.

* You cannot record performances while in Tempo Recording mode. When you're finished tempo recording, go back to the ordinary Replace Recording. Take a look at "Changing the Recording Method (Rec Mode)" (p. 140).

■ Adjusting the Tempo at a Particular Measure

You can create a tempo change at the beginning of a selected measure. This is handy when you want to make a sudden change in tempo.

First, carry out Steps 1–3 of "Changing the Tempo Within the Song" (p. 151) to make the "Tempo Recording" settings.

1. Use the [◀◀ (Bwd)] and [▶▶ (Fwd)] buttons to move to the measure where you want to change the tempo.

The measure number appears in the top-right area of the Basic screen.

2. Press the [● (Rec)] button and watch the indicator is flashing.

The KR is put in recording standby.

3. Use the Tempo [-] [+] buttons or the dial to change the tempo.

4. Press the [▶/■ (Play/Stop)] button.

The song's tempo changes starts with the measure you selected.

→ While tempo recording is being used to write tempo, the tempo display in the screen will be highlighted.

5. When you press the [▶/■ (Play/Stop)] button, the change in tempo stops.

* You cannot record performances while in Tempo Recording mode. When you're finished tempo recording, go back to the ordinary Replace Recording. Take a look at "Changing the Recording Method (Rec Mode)" (p. 140).

→ If you want to restore the previous tempo, delete the tempo data at the place where the tempo was recorded. For an explanation of how to delete the information of tempo settings, refer to "Making Measures Blank (Erase)" (p. 148).

Tempo Recording Shortcut

Hold down the [● (Rec)] button and press one of the Tempo [-] [+] buttons to switch to the Tempo Recording settings. Record tempo information. In this case, tempo recording is canceled when recording ends.

Chapter 9 Creating Music Styles

Creating Original Styles (User Styles)

Although the KR features a variety of internal Music Styles, you can also create your own. These original Styles are called “User Styles.”

You can use either of the two methods described below to create a User Style.

Style Composer

With this method, you combine internal Music Styles to create new Styles. You can create a new Style by selecting from among the Rhythm, Bass, Accompaniment 1, Accompaniment 2, Accompaniment 3, Accompaniment 4, Accompaniment 5, and Accompaniment 6 parts in different styles.

Style Converter (p. 155)

Create a new Style by extracting the portions you need from songs composed with the 16-track sequencer.

When you’re composing a song, there’s no need to specify all the chords. You can specify just some of the chords, and the KR automatically chooses the other chords and arranges the Style.

Style Converter features an “Auto mode” that allows you to easily create Styles from songs with a single chord, and a “Manual mode,” in which you create Styles from songs with three kinds of chords—major, minor, and seventh chords.

Creating New Styles by Combining Internal Music Styles (Style Composer)

You can create a new style by selecting from among the Rhythm, Bass, Accompaniment 1, Accompaniment 2, Accompaniment 3, Accompaniment 4, Accompaniment 5, and Accompaniment 6 parts in different Styles. This function is called the “Style Composer.”

* You can only combine the KR’s built-in Styles.

Displaying the Style Composer Screen

1. Press the [Menu] button.

The “Composer Menu” or the “A/V Sync” screen appears.



2. Touch < [Left Arrow] > < [Right Arrow] > to display the following screen.



3. Touch <Style Composer>.

* If a User Style has already been recorded, a message like the one shown below appears.

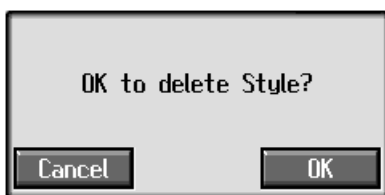

Touch <Cancel> to return to the "Composer Menu" screen. Save User Styles to external memories, or to user memory (p. 158).

When you touch <OK>, the previously recorded User Style is deleted, and a new User Style is created.

A "Style Composer screen" like the one shown below appears.



Display	Part
R	Rhythm
B	Bass
A1	Accompaniment 1
A2	Accompaniment 2
A3	Accompaniment 3
A4	Accompaniment 4
A5	Accompaniment 5
A6	Accompaniment 6

Icon	Function
All Clear	Deletes all of the settings.
Mute	You can mute the sound of particular Parts in specific Divisions. For more information, take a look at "Muting Parts for a Particular Division" (p. 154).
Clear	Deletes the Styles in selected parts.

Icon	Function
Part	The Part Settings screen is displayed, allowing you to make detailed settings to each part. For more information, take a look at "Editing the Volume and Effect Settings for Each Part" (p. 155).
Execute	Records the created Style to the Music Style [User] button. Touch this when you have finished creating the Style.

Selecting the Styles Assigned to Each Part

4. Touch the part to be set.

5. Press a Music Style button, then select a Style with the touch screen or the dial.

When you have decided on a Style, press the [Exit] button to display the Style Composer screen.

6. Repeat steps 3 and 4 to determine the Styles for each Part.

Deciding on a Style

7. Touch <Execute>.

You have created a new Style.

The User Style is recorded to the Music Style [User] button. Try playing with the new Style.

* If you turn off the power or record a new User Style, any User Style you've previously recorded is lost. If you do not want to delete the Style, save it to an external memory or to user memory. Take a look at "Saving a User Style" (p. 158).

○ Muting Parts for a Particular Division

You can mute the sound of particular Parts in specific Divisions.

For example, all parts are played when you use a "Variation" accompaniment pattern, whereas if you select the "Original" accompaniment pattern, every part other than "Accompaniment 1" is muted. With this arrangement, when the accompaniment pattern changes from the original to the variation, it creates a more elaborate effect in the accompaniment.

→ For more on Divisions, refer to the "Style Arrangements" (p. 155).

1. Touch the Style Composer screen to choose the Part you want to mute out.

2. Press the Fill In [To Variation] or [To Original] button to switch to the division that you want to mute.

3. Touch <Mute> on the screen.

The Part you chose is only muted out in the Division you selected.

If you want to hear the muted-out Part, touch <Mute> again.

* To mute out a Division that changes after a few seconds (intro, ending, or fill-in), touch <Mute> immediately after switching to the Division.

○ **Editing the Volume and Effect Settings for Each Part**

Displaying the Part settings screen

1. At the Style Composer screen, touch <Part>.

A screen like the one shown below appears.



Modifying the Settings of Each Part

2. Touch the <Part> [Left Arrow] [Right Arrow] to select the part with the settings to be changed.

The part name and Tone name are indicated in the upper part of the screen.

3. Touch [Up Arrow] [Down Arrow] for each parameter to change the value.

You can also change the values by touching each parameter name and then using the dial.

Display	Explanation
Volume	Adjusts the volume.
Reverb	Adjusts the amount of reverb effect applied to the sound.
Chorus	Adjusts the amount of chorus effect applied to the sound.
Panpot	Changes the left-right direction from which the sound appears to come. When you touch [Up Arrow], the sound moves to the right; touch [Down Arrow] to move the sound to the left.

You can change the Tone for the selected Part by pressing a Tone button to change the Tone while this screen is displayed. When selecting Rhythm Part, you can touch <Drum Set> to select the drum set or effect sound.

Finishing the Settings

4. Press the [Exit] button.

The Style Composer screen appears.

■ Creating a Style from a Song You Composed Yourself (Style Converter)

You can take a song you've composed yourself and extract the portions you need to create your own original Style. When you're composing a song, there's no need to specify all the chords. You can specify some of the chords, and the KR automatically chooses the other chords and arranges the style. This function is called the "Style Converter."

Style Converter features an "Auto mode" that allows you to easily create Styles from songs with a single chord, and a "Manual mode," in which you create Styles from songs with three kinds of chords—major, minor, and seventh chords.

When creating a song in order to create an music style, it's good practice to consider the arrangement of the music style.

Style Arrangements

Music Styles created with the Style Converter function are composed of eight parts: "Rhythm," "Bass," "Accompaniment 1," "Accompaniment 2," "Accompaniment 3," "Accompaniment 4," "Accompaniment 5," "Accompaniment 6."

A song progresses in predictable a sequence, such as intro, melody A, melody B, bridge and ending.

With the KR, such changes in songs are allocated to the following six performance states. We call these six parts of a song "Divisions."

Division	Performance division
Intro	The intro is played at the start of a song.
Ending	This is played at the end of a song.
Original	This is a basic accompaniment pattern.
Variation	This is a developmental accompaniment pattern. It is a variation on an Original.
Fill-In To Variation	This is a one-measure phrase inserted at a juncture where the mood changes. It is used to make a song more lively.
Fill-In To Original	This is a one-measure phrase inserted at a juncture where the mood changes. It is used to make a song more sedate.

You can make a song more lively or more restrained by increasing or reducing played parts by Divisions. You can also modify a song by changing the Tone of the parts in the Divisions.

Chapter 9 Creating Music Styles

○ Creating Styles in Auto Mode

Points to note when creating songs

- Use one of the major, minor, or diminished seventh chords to create the song. We recommend using diminished seventh chords to compose the song.
- It is convenient to record the sounds shown below for the Parts of the 16-track sequencer.

Rhythm	Bass	Accomp 1	Accomp 2	Accomp 3
D (10)	2	7	8	9

→ When using parts other than Part 2, 7, 8, 9, and D, refer to “Changing an Extracted Part” (p. 157).

Creating songs

1. Use the 16-track sequencer to record the song.

Record the song after referring to “Multitrack Recording with 16 Parts (16-Track Sequencer)” (p. 136) and other related sections.

When using music data, first select a song (p. 75).

Displaying the Style Converter screen

2. Press the [Menu] button.

The “Composer Menu” or the “A/V Sync” screen appears.

3. Touch <Style Converter>.

- * If no song for use in creating a new Style is selected, the message “Please select a song” appears. Use the [Song] button to select a song (p. 75), then start the procedure again.
- * If a User Style has already been recorded, a message like the one shown below appears.

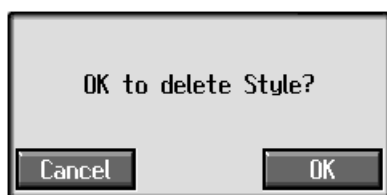

Touch <Cancel> to return to The “Composer Menu” screen. Please save the User Style on an external memory or in the internal memory (p. 158).

When you touch <OK>, the previously recorded User Style is deleted, and a new User Style is created.

A “Style Converter screen” like the one shown appears.



Parameter Name	Settings Content
Conv.Mode	Switches the mode (Auto/Manual)
Chord Root	Chord root for the segment to be extracted
Chord Type	Chord type for the segment to be extracted (major/minor/seventh)
Division	Division
From	Measure number of the first measure of the segment to be extracted
For	Number of measures extracted

Making the Settings

4. Touch <Conv.Mode>, then use the dial to switch the mode to “Auto.”

This makes the setting for the Auto mode.

5. Touch <Chord Root> and <Chord Type>, then use the dial to input the chord root and type for the segment to be extracted.

6. Touch <Division>, then use the dial to select the Division.

Display	Performance division
Intro	Intro
Original	Original accompaniment pattern
Fill To Vari	From the fill-in to the variation
Variation	Variation accompaniment pattern
Fill To Ori	From the fill-in to the original
Ending	Ending

- * Only one measure can be extracted when “Fill To Vari” or “Fill To Ori” is selected for the Division. The number of measures may also be limited in other Divisions.

7. Touch <From> and <For>, then use the dial to select the measures to be extracted.

Touching <Play> at the bottom of the screen, you can listen to performance of the portion which you chose.

8. Repeat Steps 5–7 to create Styles for all of the Divisions.

* If no setting is made for a Division, it uses a simple drum pattern.

Deciding on a Style

9. When you're done making all the Division settings, touch <Execute>.

The User Style is recorded to the [User] button.

* If you turn off the power or record a new User Style, any User Style you've previously recorded is lost. If you do not want to delete the Style, save it to an external memory or to user memory. Take a look at "Saving a User Style" (p. 158).

* The following data is saved to the User Style. If a song includes data other than this, the results you get might not be what was intended.

- Keyboard performance data
- Amount of Reverb effect applied
- Amount of Chorus effect applied

○ Creating a Style in Manual Mode

When you create a Music Style in the Manual mode, you can clearly point up the differences in accompaniment for each individual chord.

Points to Note when Creating Songs

- Record your performance with the three chord types of diminished seventh, major, and minor.
- It is convenient to record the sounds shown below for the Parts of the 16-track sequencer.

Chords	Rhythm	Bass	Accomp 1	Accomp 2	Accomp 3
Major	D (10)	3	4	5	6
Seventh	-	2	7	8	9
Minor	-	12	13	14	15

→ The chords all share the same Rhythm Part.

→ If you want to use the performance of other part, check out "Changing an Extracted Part" (p. 157)

Creating Songs

1. Use the 16-track sequencer to record the song.

Record the song after referring to "Multitrack Recording with 16 Parts (16-Track Sequencer)" (p. 136) and other related sections.

When using music data, first select a song (p. 75).

Displaying the Style Converter screen

2. Press the [Menu] button.

3. Touch <Style Converter>.

The "Style Converter screen" appears.

4. Touch <Conv.Mode>, then use the dial to switch the mode to "Manual."

This makes the setting for the Manual mode.

After that, the steps are the same as for "Creating Styles in Auto Mode" (p. 156).

When you touch <Play> in the lower part of the screen, you can listen to the performance of the part selected with <Options>.

○ Changing an Extracted Part

You can extract and change part of a song created with 16-track sequencer.

1. At the Style Converter screen (p. 156), touch <Part>.

A screen like the one shown below appears.

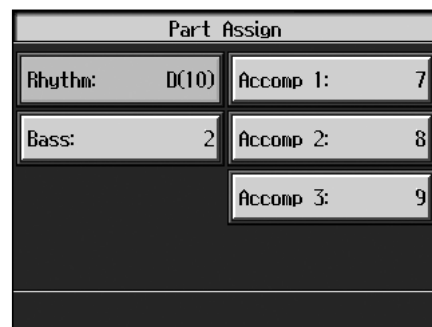

2. Touch the performance Part with settings you want to change.

3. Use the dial to specify which 16-track Sequencer performance part you want to extract.

→ In the Manual mode, the type of chords appear at the bottom of the screen. Set the Parts for all chords.

4. Press the [Exit] button to return to the Style Converter screen.

The Style Converter screen appears.

Saving a User Style

You can save the User Styles you create to external memories and the user memory. When saved to the user memory, User Styles are not deleted when the power is turned off. You can also select Styles saved to the user memory by pressing the Music Style [User] button.

You can save up to 99 User Styles in user memory.

What is the User Memory?

The user memory is the area within the instrument where User Styles created with the KR, sets of User Programs, and other such data are stored.

You can also copy User Styles and sets of User Programs saved on external memories.

Data saved to the user memory is not deleted, even when the KR's power is turned off.

→ When you want to clear all of the content saved to the user memory and restore the settings to the factory settings, refer to "Formatting the User Memory" (p. 180).

Preparations for Saving Data

When saving to an external memory, first connect an external memory to the external memory port.

1. Press the Music Style [User] button.

A "User Style screen" like the following appears.



If the User Style screen is not displayed, touch <User> in the lower part of the screen.

2. Touch <File>.
3. Touch <Save>.

A "Save Style screen" like the following appears.

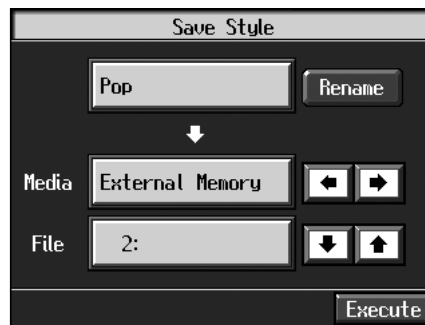

Determining the Name of the Style to be Saved

4. Touch <Rename>.

A "Rename screen" like the following appears.

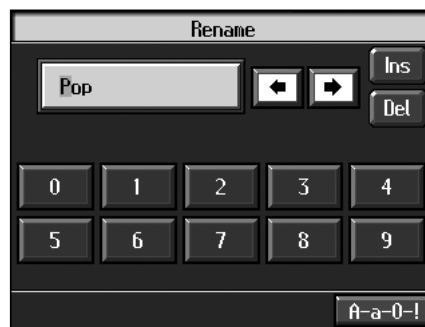

When you touch  , the cursor moves.

When you touch the icon for the character to be input, the character appears at the cursor position.

For example, touching the <ABC> icon in succession cycles you through the available choices in that character group (A→B→C→A...).



Each touch of <A-a-0-!> cycles the type of characters through "English (upper case)," "English (lower case)," "numerals," "symbols," then back to "English (upper case)."

When you touch , the character at the cursor position is deleted.

When you touch <Ins>, a space is inserted at the cursor position.

5. When you have finished with the name, press the [Exit] button.

Determining the Save Destination

6. Touch <Media>   to select the save-destination storage media.

7. Touch   to select the save-destination number.

If a Style name is displayed, a style is already saved to that number.

If you select a number with a previously saved User Style and then save to that number, the previously saved User Style is deleted. If you do not want to delete the User Style being saved, select a number in the save-destination column that does not yet have a name.

8. Touch <Execute>.

The saving process starts.

* **Never turn off the power or eject the external memory from the external memory port while the operation is in progress. Doing so will damage the KR's internal memory, making it unusable.**

■ Deleting Saved User Styles

This deletes User Styles that have been saved to external memories or in user memory.

When deleting a User Style on an external memory, first connect the external memory to the external memory port.

1. Press the Music Style [User] button.

A "User Style screen" appears.



If the User Style screen is not displayed, touch <User> in the lower part of the screen.

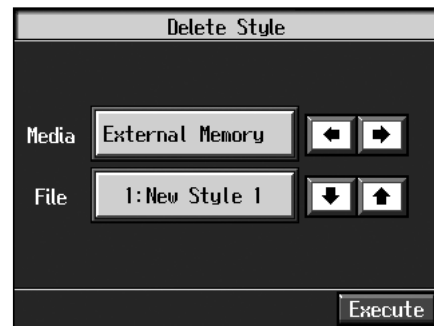

2. Touch <File>.

3. Touch <Delete>.

A "Delete Style screen" like the following appears.



4. Touch <Media>   to select the storage media.

5. Touch  or  to select the Style to be deleted.

6. Touch <Execute>.

The selected Style is deleted.

* **Never turn off the power or eject the external memory from the external memory port while the operation is in progress. Doing so will damage the KR's internal memory, making it unusable.**

Copying Styles on External Memories to the User Memory

You can take User Styles saved on external memories and copy them to user memory.

You can also take User Styles saved in user memory and copy them to external memories.

1. Connect the external memory with the Style to be copied to the external memory port.
2. Press the [User] button.

A “User Style screen” like the following appears.



If the User Style screen is not displayed, touch <User> in the lower part of the screen.

3. Touch <File>.
4. Touch <Copy>.

A “Copy Style screen” like the following appears.

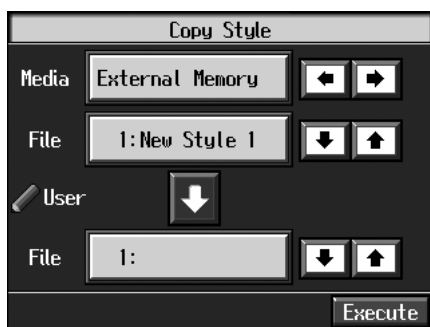

Specifying the Copy Source

5. Touch <Media> to select the copy source media.
6. Touch <File> to select the Style you want to copy.

When “All” is selected, all of the Styles in the selected folder on the external memory are copied to user memory.

Specifying the Copy Destination

7. Touch <User> to select the copy destination for the Style.

If a Style name is displayed, a style is already saved to that number.

If you select a number with a previously saved Style and then copy to that number, the previously saved Style is deleted. If you do not want to lose the Style being saved, select a number in the save-destination column that does not yet have a name.

8. Touch <Execute>.

The Style on the external memory is copied to user memory.

** Never turn off the power or eject the external memory from the external memory port while the operation is in progress. Doing so will damage the KR's internal memory, making it unusable.*

Copying Styles Saved in the User Memory to External Memories

You can take Styles saved in user memory and copy them to external memories.

In this case, touch the large arrow icon in the center of the “Copy Style screen” in Step 4 above so that the arrow points upwards. Turn the KR will copy user memory Styles to the external memory.

The rest of the procedure is identical to that used for copying Styles from external memories to user memory.

Chapter 10 Various Settings

Changing the Settings for One-Touch Arranger

■ Procedure

1. Press the One Touch Program [Arranger] button to display the Basic screen.



2. Press the [Option] button.

A screen like the one shown below appears.

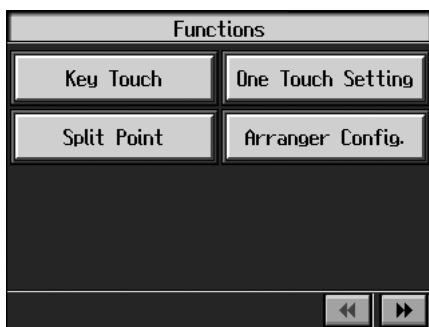

Parameter Name	Explanation
Key Touch	Refer to “Adjusting the Keyboard Touch (Key Touch)” (p. 161).
One Touch Setting	Selects the setting to be specified when the One Touch Program [Arranger] button is pressed (p. 162).
Split Point	Sets the key at which the keyboard is divided (the split point) (p. 162).
Arranger Config.	Sets the way the Automatic Accompaniment plays sounds (p. 162).

→ You set the tuning and make a variety of other settings for the KR starting with the second page of the settings screen.

3. Touch the name of the parameter to be set.

Refer to the corresponding page for each function.

4. Press the [Exit] button to return to the Basic screen.

■ Adjusting the Keyboard Touch (Key Touch)

You can vary the touch of the keyboard when you play the keys.

At Step 3 in “Procedure” (p. 161), touch <Key Touch>.



Display	Explanation
Fixed	Notes sound at an unchanging volume level, regardless of how lightly or forcefully you play the keyboard.
Light	This sets the keyboard to a light touch. You can achieve fortissimo (ff) play with a less forceful touch than usual, so the keyboard feels lighter. This setting makes it easier for children, whose hands have less strength.
Medium	This sets the keyboard to the standard touch. You can play with the most natural touch. This setting is closest to the response of an acoustic piano.
Heavy	This sets the keyboard to a heavy touch. You have to play the keyboard more forcefully than usual in order to play fortissimo (ff), so the keyboard touch feels heavier. This setting allows you to add more expression when playing dynamically.

Touch any of the icons <Fixed>, <Light>, <Medium>, or <Heavy>, to set the key touch for the keyboard.

To make fine adjustments, touch the slider in the screen.

Move the slider to the right to add resistance, and to the left to make the key touch lighter.

→ You can also change the key touch by pressing the [Piano Designer] button. For more details, refer to the Quick Start.

■ Changing Music Styles Without Changing the Tone or Tempo (One Touch Setting)

Normally, when you select a Music Style, the Tone and tempo settings suitable for that Music Style are selected automatically. However, you can also set it so the tempo and Tone settings don't change when you change Music Styles.

At Step 3 "Procedure" (p. 161), touch <One Touch Setting>.

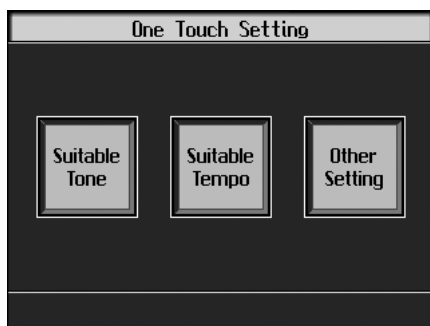

Display	Explanation
Suitable Tone	The suitable tone for a Music Style is selected automatically.
Suitable Tempo	The suitable tempo for a Music Style is selected automatically.
Other Setting	Other settings (Style Orchestrator, etc.) are changed automatically.

Touch each icon to switch individual settings on and off.

Button colors become brighter when the corresponding settings are switched on.

All items are set to ON when you turn on the power.

Parameters switched to OFF do not change, even when the performance Style is changed.

■ Changing the Keyboard's Split Point (Split Point)

This sets the point (the split point) where the keyboard is divided when specifying chords in the left hand while using the Automatic Accompaniment and when playing split performances (p. 32).

The setting is at "F#3" when the KR is powered up.

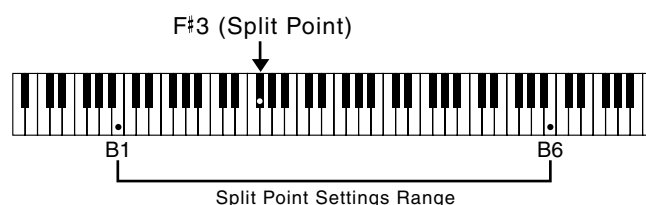

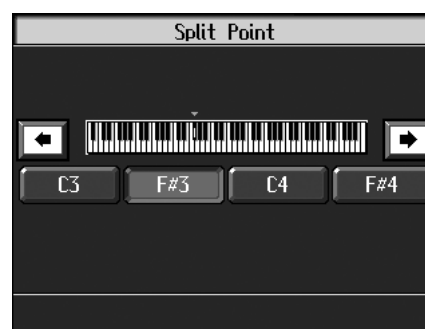

→ The key you chose for the split point belongs to the left-hand section of the keyboard.

At Step 3 in "Procedure" (p. 161), touch <Split Point>.



Touch either <C3>, <F#3>, <C4>, or <F#4> in the lower part of the screen.

The key you chose becomes the split point.

To set another key as the split point, touch   in the screen, then specify the key.

You can set the split point within a range of B1 to B6.

■ Changing How Chords Are Played and Specified (Arranger Config)



This changes the settings determining how Music Styles are played, and how the keys are pressed to specify chords.

What are the Chord Tone and Bass Tone?

When the Automatic Accompaniment is stopped, and Sync Start (p. 65) is turned off, chords are produced when you play in the left-hand side of the keyboard. This is called the "chord tone," and the root of the chord that is played at the same time is called the "bass tone."

At Step 3 “Procedure” (p. 161), touch <Arranger Config>.



Touch   of each item to make settings.

Parameter Name	Value	Explanation
Accomp	Accomp	All Music Style parts are played.
	Chord&Bs	Only Music Style rhythm parts, chord Tones, and bass Tones are played.
Bass Tone	OFF, Acoustic Bs., A. Bass+Cymb1, Fingered Bs., Picked Bass., Fretless Bs., Slap Bass1, Organ Bass, Synth Bass 101, Thum Voice	Selects the bass Tone. When set to “OFF,” no tone is played.
Chord Tone	OFF, E.Piano 1, E. Piano 2, Soft E. Piano, Hard E. Piano, Slow Strings, Strings, Choir, Doos Voice	Selects the chord Tone. When set to “OFF,” no tone is played.
Chord Recognition Mode	Manual, Intelligence 1, Intelligence 2	This selects the way chords are played with the Chord Intelligence function. When you set this to “Manual,” play all of the notes describing the chord.

What is Chord Intelligence?

“Chord Intelligence” (p. 59) is the name of the function that recognizes the chords being specified for an accompaniment when only one or two keys of the chords have been pressed, which can be used while automatic accompaniment is active.

How to play chords in the Chord Intelligence mode:

• Intelligence 1

Major

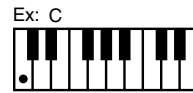

Play the chord root.

Seventh



Play the root and the second key below it.

Major Seventh



Play the root and the first key below it.

Minor

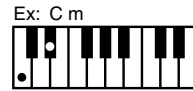

Play the root and the third key above it.

Minor Seventh

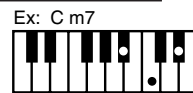

Play the root, the third key above it, and the second key below it.

Diminished

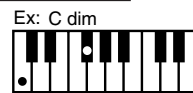

Play the root and the sixth key above it.

• Intelligence 2

Major



Play the root of the chord.

Seventh



Play the root of the chord and the white key to the left of the root.

Minor

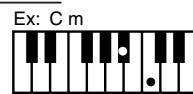

Play the root of the chord and the black key to the left of the root.

Minor Seventh

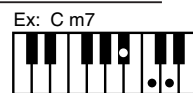

Play the root of the chord and the black and white key to the left of the root.

Placing a Marker in the Middle of a Measure

A marker is normally placed at the start of the selected measure, but you can also set it so that a marker is placed at a position partway through a measure.

→ For detailed information about Marker, refer to “Setting Markers for Repeated Practice (Marker)” (p. 98).

1. Press the [Count/Marker] button.

The Count screen appears.

2. Touch <Marker>.

The Marker screen appears.

3. Press the [Option] button.

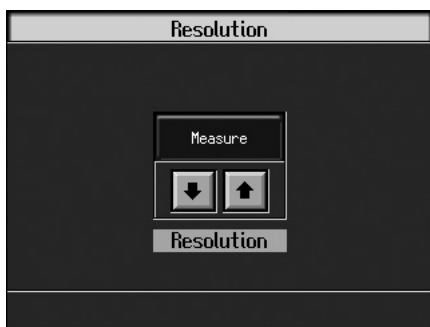

4. Touch <Resolution> [Up] [Down] to choose the marker setting.

Indication	Explanation
Measure	This lets you place a marker at the beginning of the measure.
Beat	This lets you place a marker at the beginning of the beat.

5. Press the [Exit] button to go back to the Marker screen.

Changing the Settings for the Count

→ For detailed information about count, refer to “Match the Tempo Before You Begin Playing (Count In)” (p. 96) and “Having a Count Sound Play at the End of the Intro (Countdown)” (p. 67).

1. Press the [Count/Marker] button.

The Count screen (p. 96) appears.

2. Touch [Up] [Down] of each item to make settings.

3. Press the [Exit] button to return to previous screen.



Parameter Name	Value
Count Mode Specify what type of count will be added.	Count In (add a count before the performance), Countdown (add a count only before you begin playing), Count In/down (add both a count-in and a countdown)
Countdown Sound Specify the countdown sound.	Voice (Japanese), Voice (English)
Countdown Track Specify the track or part that will determine the beginning of the performance when added a countdown.	Lower & Upper Tracks Lower Track Upper Track Part 1–16
Count-In Sound Specify the count-in sound.	Stick, Click, Electronic, Voice (Japanese), Voice (English), Wood Block, Triangle & Castanets, Hand clap Animal
Measures Specify the length (number of measures) of the count-in.	1, 2

Parameter Name	Value
Repeat When "Repeat" is turned ON on the Marker screen (p. 101) this specified whether the count-in will sound each time the range between the markers is repeated, or only the first time.	First Time, Each Time

Other Settings

You can change the tuning, the language shown on the display, and other settings to make the KR easier to use.

■ Procedure

1. Switch to the Basic screen, or press the One Touch Program [Piano] button.

2. Press the [Option] button.

A "Functions screen" like the following appears.



When you press the [Option] button on the Basic screen, the first page displayed shows the parameters for the Automatic Accompaniment settings (p. 161).

Parameter	Explanation
Tuning	Changing the tuning methods.
Pedal Setting	Assigns functions to the pedal and performance pad (p. 167).
Master Tune	Sets the KR's standard pitch (p. 170).
External Display	Selects the content to be shown on the connected external display (p. 186).
Language	Selects the language used in the display (p. 170).
User Image Display	Selects the image data and display used (p. 170).
Opening Message	Sets the message that appears when the power is turned on (p. 171).
MIDI Setting	Refer to p. 189.
Program Change	Refer to p. 189.
Memory Backup	Stores edited settings and other data to the KR (p. 171).
MIDI Ensemble	Refer to p. 189.
Factory Reset	Restores the content stored with Memory Backup to the original factory settings (p. 172).
V-LINK	Refer to p. 187.
USB Driver	Refer to p. 196.
Remote Control	Changing the functions of the remote control's buttons (p. 172).

Chapter 10 Various Settings

Parameter	Explanation
Touch Screen	Allows for calibration of the touch screen (p. 175).
Ir/Serial Port	Sets the remote sensor's on or off (p. 174)

3. Touch the name of the parameter you want to set.

Refer to the corresponding page for each function.

4. Press the [Exit] button to return to the Functions screen.

■ Changing the Tuning (Tuning)

○ Choosing the Tuning

You can play classical styles such as Baroque using historic temperaments (tuning methods).

Most modern songs are composed for and played in equal temperament, the most common tuning in use today. But at one time, there were a wide variety of other tuning systems in existence. By playing in the temperament that was in use when a composition was created, you can experience the sonorities of chords originally intended for that song.

At Step 3 in "Procedure" (p. 165), touch <Tuning>.



You can choose from among the eight tunings described below.

Tuning system	Characteristics
Equal	This temperament divides the octave into 12 equal parts. All intervals will be slightly out of tune by the same amount. This setting is in effect when you turn on the power.
Just (Maj)	This temperament makes the 5th and 3rd intervals pure. It is unsuited to playing melodies and cannot be transposed, but is capable of beautiful sonorities.
Just (min)	Just intonation differs between major and minor keys. The same results as major can be obtained in a minor key.

Tuning system	Characteristics
Arabic	This tuning is suitable for the music of Arabia.
Kirnberger	This temperament is a modification of meantone temperament and just intonation, allowing more freedom of modulation. Performances are possible in all keys (III).
Pythagorean	This temperament is based on the theories of the Greek philosopher Pythagoras, and has pure fourths and fifths. Chords containing a third will sound impure, but melodies will sound good.
Meantone	This temperament is a partial compromise of just intonation in order to allow modulation.
Werkmeister	This temperament is a combination of meantone and Pythagorean temperaments. It allows you to play in all keys. (First method, number three.)

Touch any one of the icons to choose the tuning system.

When playing in a temperament other than equal temperament, you must specify the tonic (the note corresponding to C for a major key, or to A for a minor key) of the key in which you will play.

Touch <Key>   to select the tonic.

If you have selected equal temperament, it is not necessary to select the tonic.

○ Setting the Tuning Curve (Stretch Tuning)

Pianos are generally tuned so that the low range is flatter and the high range is sharper than equal tempered pitches. This method of tuning is unique to the piano, and is known as "stretched tuning."

A graph that shows the changes in pitch of actual tuning compared with the changes in equal temperament pitch is called a tuning curve. Changing the tuning curve produces subtle variations in the reverberations of the chords you play.

Touch the Stretch Tuning <ON> or <OFF> icon to select the tuning curve.

When set to "ON," the tuning curve features extended low and high ranges (Stretch Tuning). It is suitable for piano solos. This setting is selected when the power is turned on.

When set to "OFF," the standard tuning curve is used. It is suitable when playing in an ensemble with other instruments.

■ Assigning Functions to Pedals and Performance Pads (Pedal Setting/User Functions)

You can assign a variety of functions to the left and center pedals, the expression pedals, and the performance pads.



You can call up the assigned functions just by pressing the corresponding pedal or pad.

* Use only the specified expression pedal (EV-7/5; sold separately). By connecting any other expression pedals, you risk causing malfunction and/or damage to the unit.

○ Assigning Functions to Pedals

At Step 3 “Procedure” (p. 165), touch <Pedal Setting>.



Touch   to assign functions to each of the pedals.



→ Pressing the One Touch Program [Piano] button restores the piano performance functions to the pedals (p. 22).

○ Assigning Functions to Performance Pads

1. Press the [User Function] button and watch the indicator light up.

A screen like the one shown below appears.



2. Touch   to assign functions to each of the Performance Pads.

→ If you set the pedal as a dedicated switch for selecting User Programs, the function assigned to the pedal cannot be used. Refer to “Using the Pedal to Switch User Programs” (p. 134).

○ Functions that Can be Assigned (Pedals, Performance Pads)

Function	Explanation
Leading Bass	Toggles the Leading Bass function* on or off. The function stays on as long as the pedal to which this is assigned is pressed. When assigned to a Performance Pad, this is alternately switched on and off each time the pad is pressed.
No Chord	Only the Rhythm part is played. After No Chord is switched on, specifying a chord by playing the actual keys cancels the function, and all of the accompaniment parts are played.
Break	During the performance of Automatic Accompaniment, the accompaniment stops for one measure only.
Fill In to Variation	Performs the same function as the Fill In [To Variation] button (p. 68).
Fill In to Original	Performs the same function as the Fill In [To Original] button (p. 68).
Fill In	A fill-in is inserted, but the accompaniment pattern after that doesn't change.
Half Fill In to Variation	This plays a fill-in half a measure long, then switches to the Variation accompaniment pattern.
Half Fill In to Original	This plays a fill-in half a measure long, then switches to the Original accompaniment pattern.
Original/Variation	This changes the accompaniment pattern without inserting a fill-in.
Arranger Reset	When this function is used during Automatic Accompaniment, the accompaniment returns to the beginning of the Division (p. 57).
Intro 1/Ending 1	Performs the same function as the [Intro/Ending] button (p. 65). Intro 1 and Ending 1 are played.
Intro 2/Ending 2	Performs the same function as the [Intro/Ending] button (p. 65). Intro 2 and Ending 2 are played.
Arranger Start/Stop	Performs the same function as the [Start/Stop] button (p. 65).
Orchestrator Up	This changes the accompaniment to a more elaborate arrangement (p. 69).
Orchestrator Down	Changes the accompaniment to a simpler arrangement (p. 69).
Melody Intelligence	Turns the Melody Intelligence function on and off (p. 70).

Chapter 10 Various Settings

Function	Explanation
Fade In/Out	This starts Automatic Accompaniment with a fade-in (where the volume gets progressively louder), ends it with a fade-out (where the volume gets progressively softer), then stops.
Rotary Slow/Fast	This switches the speed of the rotary effect* when you perform with an organ tone.
Glide	While the pedal or Performance Pad is held down, the pitch of the sound drops temporarily, returning to the original pitch when the pedal or Pad is released. This can be effective for simulating the performance of instruments like a Hawaiian guitar.
Composer Play/Stop	Performs the same function as the [▶ / ■ (Play/Stop)] button (p. 75).
Page Fwd 1	If a song is stopped with the notation shown in the KR display, the notation in the KR display scrolls to the next page when you press the pedal.
Page Bwd 1	If a song is stopped with the notation shown in the KR display, the notation in the KR display scrolls to the preceding page when you press the pedal.
Page Fwd 2	If a song is stopped with the notation shown in the external display, the notation in the external display scrolls to the next page when you press the pedal.
Page Bwd 2	If a song is stopped with the notation shown in the external display, the notation in the external display scrolls to the preceding page when you press the pedal.
Punch In/Out	During Punch-in Recording, this starts and stops recording (p. 142).
Tap Tempo	You can set the tempo according to the interval at which the pedal or pad is pressed (p. 95).

* What is the leading bass function?

The function that sounds the lowest note of a fingered chord as the bass tone is called "Leading Bass." When this function is turned on, the Bass Tone changes when chord inversions are used. Usually the tonic of the chord you play sounds as the bass tone.

* What is the rotary effect?

This adds a sort of spinning effect to the organ sound, similar to the sound when a rotary speaker is used.

Changing the speed increases or decreases the speed of this spinning effect.

○ Functions that Can be Assigned (Pedals Only)

Function	Explanation
Composer Assist	Pressing the pedal during playback of a song stops the playback. When the pedal is released, playback resumes from the beginning of the measure that was playing when the pedal was pressed. When the pedal is pressed in rapid succession, the playback will resume backs up the same number of measures as the number of times the pedal is pressed.
Upper Sostenuto	The pedal functions as a sostenuto pedal (p. 22).
Upper Soft	The pedal functions as a soft pedal (p. 22).
Lower Damper	Applies a damper pedal effect to the sounds in the left-hand side of the keyboard during a split performance.
Bend Up	This raises the pitch of notes you play on the keyboard.
Bend Down	This lowers the pitch of notes you play on the keyboard.
EX1	When the pedal is pressed during a layer performance, the Tone volume changes between two levels, depending on how firmly the pedal is pressed. Pressing the pedal with "Pedal EX1" selected increases the layer Tone volume. The layer Tone is played at a fixed volume, regardless of how forcefully the keys are played.
EX2	Pressing the pedal with "Pedal EX2" selected increases the layer Tone volume, while the volume of the right-hand Tone is decreased. The layer Tone is played at a fixed volume, regardless of how forcefully the keys are played.
EX3	Pressing the pedal with "Pedal EX3" selected increases the layer Tone volume.
EX4	Pressing the pedal with "Pedal EX4" selected increases the layer Tone volume, while the volume of the right-hand Tone is decreased.

* The effect may not be applied correctly when you press a pedal if "Pedal EX1-4" is assigned to more than one pedal.

→ Using the "Bend Up" or "Bend Down" function during a split performance (p. 31) changes the pitch of sounds in the right-hand side of the keyboard. Additionally, the range in which the pitch can change when the Bender effect is used is called the "bend range"; refer to "Changing the Bend Range (Pedal Setting)" (p. 169).

○ **Functions that can be assigned (Expression Pedals Only)**

Function	Explanation
Expression	Adjusts the overall volume.
EX1	When the pedal is pressed during a layer performance, the Tone volume changes between two levels, depending on how firmly the pedal is pressed. Pressing the pedal with "Pedal EX1" selected increases the layer Tone volume. The layer Tone is played at a fixed volume, regardless of how forcefully the keys are played.
EX2	Pressing the pedal with "Pedal EX2" selected increases the layer Tone volume, while the volume of the right-hand Tone is decreased. The layer Tone is played at a fixed volume, regardless of how forcefully the keys are played.
EX3	Pressing the pedal with "Pedal EX3" selected increases the layer Tone volume.
EX4	Pressing the pedal with "Pedal EX4" selected increases the layer Tone volume, while the volume of the right-hand Tone is decreased.

■ **Changing the Bend Range (Pedal Setting)**

The effect of smoothly raising or lowering the pitch of a played note is called the "bender effect."

You can assign the bender function to a pedal, then apply the bender effect by depressing and releasing the pedal.

You can also make a setting that determines how much the pitch of the note changes when you apply the bender. The maximum range of change in pitch is called the "bend range."

At Step 3 "Procedure" (p. 165), touch <Pedal Setting>.

Touch   to switch the screens.

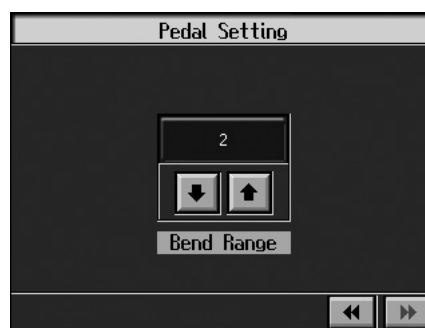

Touch <Bend Range>   to adjust the bend range setting.

You can set this to any value within a range of 1 to 12 (in half-tone steps, up to one octave).

■ Changing Standard Pitch (Master Tune)

“Standard pitch” generally refers to the pitch that is heard when you play middle A. When performing in an ensemble with other instruments, adjust the standard pitch so that the instruments of the ensemble match. Tuning all the instruments to a standard pitch is called “master tuning.”

At Step 3 in “Procedure” (p. 165), touch <Master Tune>. A screen like the one shown below appears.



Touch   to change the pitch.

Standard pitch can be set to any value from 415.3–466.2 Hz.

■ Changing the Language (Language)

Five choices are available for the language used in displaying information on the screen.

At Step 3 in “Procedure” (p. 165), touch <Language>. A screen like the one shown below appears.



Touch   to select the language.

Available settings

English, Japanese, German, French, Spanish

* German, Spanish, and French are displayed for some functions. Other screens will be displayed in English.

■ Selecting Images To Be Shown on the KR and External Displays (User Image Display)

You can have image data from computers and other devices shown on the onboard display, or on an external display you’ve connected. You can store two types of image data, “KR display” data, and “Ext. display” data.

→ “KR-display-use” images appear on the KR’s display when the instrument’s power is turned on.

When you select “Automatic” or “Lyrics” as the image type to be shown with the external display as described in “Changing the Settings for Showing Images with the External Display and the Television (External Display)” (p. 186), the images are shown in the external display.

At Step 3 in “Procedure” (p. 165), touch <User Image Display>.

A screen like the one shown below appears.



Selecting the Display to be Set

1. Touch <KR Display> or <Ext. Display>.

Select the setting either for “KR display” or “Ext. display” images.

Selecting the Images to be Displayed

First, take an external memory to which the image data stored in the KR has been saved, and connect the external memory to the external memory port.

2. Touch <File>.

A screen like the one shown below appears.



3. Touch the name of the stored image data.
When you touch <Preview>, you can then show the selected image data on the display selected in Step 1.
4. Touch <Save>.
The selected image data is stored.
5. Press the [Exit] button to return to the previous screen.
To clear the stored image data, touch <Erase>.

○ Image data that KR can display

Size (Recommended)	320 x 240 pixels (for KR display) 640 x 480 pixels (for external display)
Format	BMP format, JPEG format
Extension	".bmp", ".jpg"

■ Changing the Screen Message When the Power Is Turned On (Opening Message)

You can modify this screen to show your favorite phrase when the power is turned on.

At Step 3 in "Procedure" (p. 165), touch <Opening Message>. A screen like the one shown below appears.



Use     to move the cursor.

When you touch the character icon, the character is input where at the position.

When you touch the icon for the character to be input, the character appears at the cursor position. For example, touching the <ABC> icon in succession cycles you through the available choices in that character group (A→B→C→A...).

Each touch of <A-a-0-!> cycles the type of characters through "English (upper case)," "English (lower case)," "numerals," "symbols," then back to "English (upper case)."

When you touch , the character at the cursor position is deleted.

When you touch <Ins>, a space is inserted at the cursor position.

When you have finished inputting the characters, touch <Execute>.

* **Never turn off the power while the display indicates <Executing...>. Doing so will damage the KR's internal memory, making it unusable.**

→ If you touch <All Clear> at the bottom of the screen and then touch <Execute>, the display reverts to the screen that normally appears when you turn on the power to the instrument.

■ Remembering the Settings Even When the Power is Turned Off (Memory Backup)

Normally, the various settings revert to their default values when the power is turned off. However, you can specify that the settings will be remembered even when the power is turned off. This function is called "Memory Backup."

→ For more on the settings stored using Memory Backup, refer to "Parameters Stored in Memory Backup" (p. 216).

At step 3 in "Procedure" (p. 165), touch <Memory Backup>. A screen like the one shown below appears.

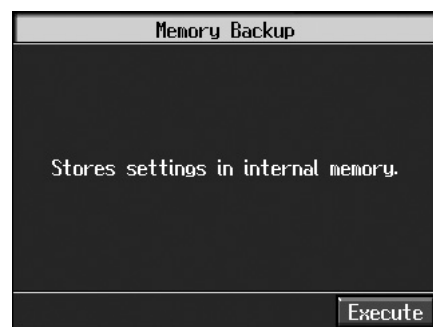

Touch <Execute>.

The confirmation message appears on screen.

Touch <OK> to store the setting.

When the setting has been stored in memory, the previous screen will reappear.

- * **Never turn off the power while the display indicates <Executing...>. Doing so will damage the KR's internal memory, making it unusable.**

■ Restoring the Factory Settings (Factory Reset)

You can return the content stored with "Memory Backup" (p. 171) and the User Programs (p. 129) to their original factory settings. This operation is referred to as "Factory Reset."

- * *When you perform a Factory Reset, all settings that have been stored in memory up to then are erased and reset to their factory defaults.*

→ *This operation does not return the touch screen calibration settings to the original factory condition. To return the touch screen calibration settings to the original factory settings, refer to "Returning the Touch Screen Calibration Settings to the Original Factory Settings" (p. 175)*

→ *When you want to restore the content registered to the KR's User memory to the factory condition, refer to "Formatting the User Memory" (p. 180).*

At step 3 in "Procedure" (p. 165), touch "Factory Reset."

A screen like the one shown below appears.



Touch <Execute>.

The confirmation message appears on screen.

Touch <OK> to restore the original factory settings.

When you have finished making the settings, switch off the power, then switch it back on again.

When you touch <Cancel>, the settings are left untouched, and you're returned to the previous screen.

- * **Never turn off the power while the display indicates <Executing...>. Doing so will damage the KR's internal memory, making it unusable.**

■ Changing the Functions of the Remote Control's Buttons



You can change the functions assigned to the remote control's buttons.

At step 3 in "Procedure" (p. 165), touch <Remote Control>.

A screen like the one shown below appears.





Switching ON/OFF of the Remote Control

1. Touch <ON/OFF>   to switch On/Off of the remote control.

Display	Explanation
Off	Not received.
On	Received.

2. Press the [Exit] button to return to the Functions screen.

Changing the [FUNC1] [FUNC2] Button Functions



1. Touch <FUNC1> <FUNC2>   to assign functions to [FUNC1] [FUNC2] button.

Display	Explanation
Moving Key	Each time the [FUNC1] or [FUNC 2] button is pressed, the piano player function is switched on or off.
Lyric Color	Each time the [FUNC 1] or [FUNC 2] button is pressed, switch the color used for lyric in the external display.
Replay	Pressing the button while the song is playing back stops the playback. When you release the button, playback resumes from the beginning of the measure being played when you pressed the button. Pressing the button a number of times in rapid succession moves the playback position back by the same the number of measures, after which playback resumes.

Display	Explanation
Track 3	Each time the [FUNC 1] or [FUNC 2] button is pressed, the lower track is switched on or off. When turned off, the sound from the lower track does not play.
Track 4	Each time the [FUNC 1] or [FUNC 2] button is pressed, the upper track is switched on or off. When turned off, the sound from the upper track does not play.
Zoom	Displays an enlarged notation.
Repeat	Playback repeats within the marked range.
CD Eject/Load	Opens and shuts the CD drive.
Ir/Serial port (Only with models featuring CD Drive)	The setting alternately switches to the infrared or serial port each time the button is pressed.

2. Press the [Exit] button to return to the Functions screen.



Changing the [▶/■] (PLAY) Button Functions

1. Touch <PLAY>   to assign functions to [▶/■] (PLAY) button.

Display	Explanation
One Song	Only the selected song is played back. Playback stops when the song is finished.
All Song	Songs are played back continuously in sequence, starting from the currently selected song. Internal Song Songs in the selected genre are played back continuously. “Favorites” Songs Songs registered to the “Favorites” are played back in sequence. Songs on External Memories, Floppy Disks, and CDs Songs within the selected folder are played back continuously.
Random	The songs are played back in random order. Internal Song The songs in all genres are played back in random order. “Favorites” Songs Songs registered to the “Favorites” are played back in random order. Songs on External Memories, Floppy Disks, and CDs Songs within the selected folder are played back in random order.

2. Press the [Exit] button to return to the Functions screen.

Changing the TEMPO [-] [+] Button and the TRANSPOSE [-] [+] Button Functions

1. Touch <TEMPO> or <TRANSPOSE>   to assign functions to TEMPO [-] [+] and TRANSPOSE [-] [+] button.

Display	Explanation
Tempo	Changes the tempo. Pressing [-] button slows the tempo down; pressing [+] button speeds up the tempo.
Notation	Scrolls the notation in the external display. Press [-] button to return to the previous page; press [+] button to advance to the next page.
Transpose	Transposes the song. Pressing [-] button lowers the pitch in semitone steps; pressing [+] button raises the pitch in semitone steps.
Bwd/Fwd	Fast forwards and rewinds the song. When [-] button is pressed, the song rewinds; when [+] button is pressed, the song is fast forwarded.
CD Volume (Only with models featuring CD Drive)	Changing the volume of the Song on CDs
CD sync (Only with models featuring CD Drive)	Synchronizing the piano and accompaniment.

2. Press the [Exit] button to return to the Functions screen.

* The remote control buttons' original function assignments are restored when the power is turned off. If you want to save the changed settings, carry out the memory backup (p. 171).

■ Changing the Infrared Transmission Function Settings

Some digital devices equipped with an IrDA (infrared) port are able to transfer song data in SMF format to the KR. For more detailed information, refer to the owner's manual for the digital device.

Note:

Users are responsible for learning how to use infrared transmissions. The KR is not necessarily compatible with all devices equipped with an IrDA port. Roland cannot answer questions regarding infrared transmissions.

Selecting functions Infrared Transmissions or Serial Port



You cannot simultaneously use the remote sensor and infrared receive with the KR.

You can choose to use either one, or to switch both of them off.

At step 3 in "Procedure" (p. 165), touch <Ir/Serial Port>. A screen like the one shown below appears.

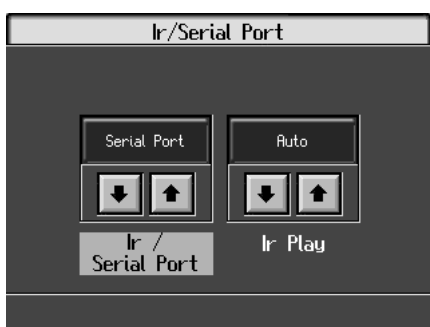
Models Featuring CD Drive



Touch <Ir/Serial>  .

Display	Explanation
Off	Neither is used.
Ir	The infrared receiver is used.
Serial Port	The device connected to the serial port is used.

Models Without Moving Key

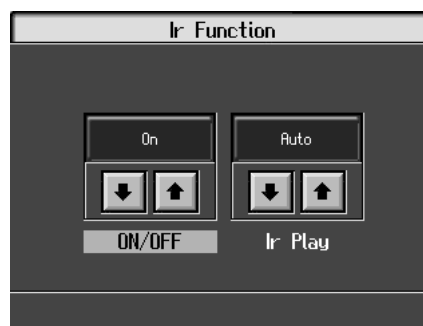

Touch <ON/OFF>  .

Display	Explanation
Off	Not used.
On	The infrared receiver is used.

Setting Playback After the Song is Transferred (Infrared Playback)

This sets the KR to play back a song automatically following transfer of the song from the digital device.

You can also set this so that songs are not played back automatically after the song is transferred.

Touch <Ir Play>  .

Display	Explanation
Standby	Following transfer of the song, the song is ready to play but not played back.
Auto	The song is played back automatically after the song is transferred.

■ Calibrating the Touch Screen (Touch Screen)

If you've been using the touch screen for some time, the pointer may be shifted, making the KR react incorrectly. You should correct this displacement when necessary by performing calibration (repositioning).

At step 3 in "Procedure" (p. 165), touch "Touch Screen."
A screen like the one shown below appears.



Touch <Execute>.

Touch the points indicated.

* Do this carefully, because touching a location that's different from the one indicated for the pointer may make the displacement even worse. Be sure to touch the pointer accurately.

When the calibration is finished, touch <Write> to store the settings.

* If you don't write them to memory, the calibration settings will be discarded as soon as the power is switched off.

Returning the Touch Screen Calibration Settings to the Original Factory Settings

If you touch <Factory Reset> in the above screen, the touch screen calibration settings revert to the original factory settings.

Changing the Part That Makes the Keys Move (Only for Instrument Equipped with Moving Key)

Changing the Moving Keys Settings

You can have the keys move automatically along with the performance.

1. Press the [Menu] button.

The "Composer Menu" or the "A/V Sync" screen appears.



2. Touch <Moving Key> at the lower left of the screen to switch the function on or off.

Icon	Keyboard
On	Movement
Off	No movement

3. Press the [Exit] button to return to the Functions screen.

Chapter 10 Various Settings

Using the Track Buttons to Choose the Part That Makes the Keys Move

Upon power-up, the instrument is set so the keys move along with the performances of the Whole, Upper, and Lower tracks. You can choose a different part to make the keys move by pressing the Track buttons, and changing the buttons that are lighted.

1. Choose the song to play (p. 75).
2. Press the Track button you want to have associated with key movement a number of times, until the button's light is flashing.

Each time you press a Track button, its light changes to the next state, in this order: lighted → extinguished → flashing → lighted →....

The following shows the relationship between the Track buttons, played parts, and keyboard movement.

Indicator	Keyboard	Sound
Indicator flashing	Movement	Sound
Indicator on	No movement	Sound
Indicator off	No movement	No sound

3. Press the [▶/■] (Play/Stop) button.

Song playback starts, and the keys move along with what is played as a result of the flashing Track button or buttons.

Using the 16 Track Sequencer Screen to Choose the Part That Makes the Keys Move

You can get the keys to move along with the performance of parts selected with the 16 Track Sequencer screen.

1. Choose the song to play (p. 75).
2. Press the [Menu] button.

The "Composer Menu" or the "A/V Sync" screen appears.

3. Touch <16tr Sequencer>.

A screen like the one shown below appears.



4. Touch the part you want to have associated with key movement.

The following shows the relationship between the indication in the display (icons), played parts, and keyboard movement.

Icon	Keyboard	Sound
	Movement	Sound
	No Movement (This part is not selected)	Sound
	No movement	No sound (no performance data for this part)
	No movement	No sound

5. Press the [Exit] button to return to the Functions screen.

Changing the CD Settings (Only for Instrument Equipped with CD Drive)

1. Press the [Menu] button.

The “Composer Menu” or the “A/V Sync” screen appears.

2. Touch <⏪> <⏩> to switch the page, then touch <CD>.

A screen like the one shown below appears.

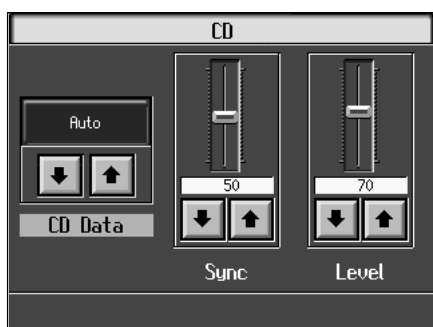

→ This screen is displayed when “CD” is selected as the category in the “Song Select” screen, even when you press the [Option] button.

3. Touch the slider for the respective parameter to change the setting.

Display	Setting	Explanation
Sync	0–100	With some player piano CDs, the piano and accompaniment sounds may not be synchronized properly. In such instances, you can adjust the timing of the piano sounds so that they are in time with the accompaniment.
Level	0–127	Adjusts the CD volume level.

4. Press [Exit] button to go back to The “Composer Menu” screen.

Setting the Type of CD To Be Played Back

The KR may be unable to correctly recognize the type of CD being used. In such instances, you can specify the type of CD manually.

1. Press the [Menu] button.



The “Composer Menu” or the “A/V Sync” screen appears.

2. Touch <⏪> <⏩> to switch the page, then touch <CD>.

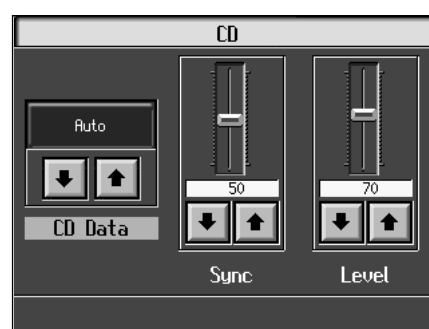
A screen like the one shown below appears.



→ This screen is displayed when “CD” is selected as the category in the “Song Select” screen, even when you press the [Option] button.

3. Touch the <CD Data>   to select the type of CD.

Display	Explanation
Auto	The CD type is detected automatically.
Type A	General CDs for Player Piano contain audio and MIDI data, and the data format may vary from one CD to the next. If the CD’s data format does not match the KR’s settings, a “beep” will sound. Certain general Automatic Piano CDs may not be playable on the KR.
Type B	
Off	Commercial Audio CD (CDs other than those designed for use with the piano player piano)

* Note that certain commercially available CDs cannot be played back on the KR.

4. Press [Exit] button to go back to The previous screen.

Showing a Series of Images on an External Display (Slide Show)

You can use the KR to display your favorite images stored on external memory using a connected external display or television set.

Making the Connection

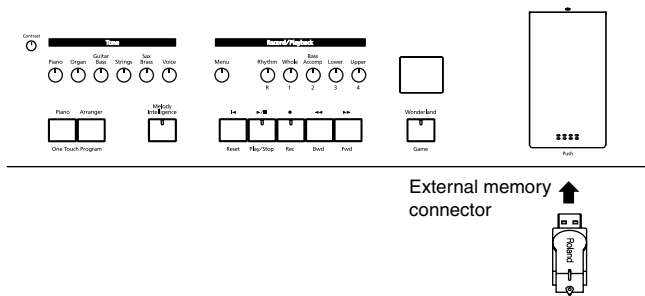

→ For details about connecting an external display, refer to p. 185.

NOTE

Some images may not be displayed in the slide show if 500 or more files, including images, are contained in a single folder.

○ Image data that KR can display

Size	640 x 480 pixels (recommended)
Format	BMP format, JPEG format
Extension	“.bmp”, “.jpg”

■ Running a Slide Show of Images Stored on External Memory

Preparing the Images

- Using a computer, prepare the images you want to display.
- Connect the USB memory to the computer and create a folder named “_PICTURE” on the USB memory.
- Place the images you want to display in the “_PICTURE” folder.

Running the Slide Show

- Connect the external memory to the external memory port.

A slide show of the images stored in the “_PICTURE” folder on the USB memory appears on the external display.

→ The “Mode” value in the External Display Setting screen automatically changes to “Slide Show.”

The “Mode” value may not automatically switch to “Slide Show” while Wonderland, Demo, or certain other functions are in use.

If this occurs, quit the function currently being used.

Afterwards, select “Slide Show” for the “Mode” setting manually in the “External Display Setting” screen.

Changing the Sequence of Images in Slide Shows

You can have images be displayed in the order you prefer by changing the file names.

By adding a number from 001 through 999 to the six- to eight-character file name, you can have the files be displayed according to their numerical order.

■ Changing Slide Shows

- Press the One Touch Program [Piano] button.

The piano screen will appear.

- Press the [Option] button.

- Touch the <External Display> (p. 165).

The following screen will appear.

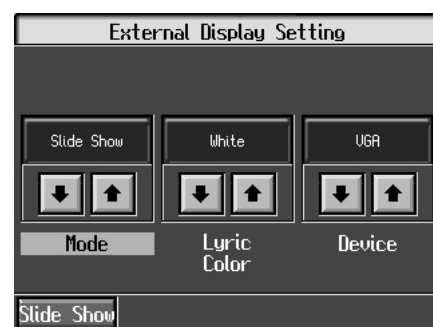

- Touch the <Mode> [↓] [↑] to select a value other than “Slide Show.”

- Press [Exit] button to go back to The “Functions screen.”

→ You can change the “Mode” value by pressing [DISPLAY] on the remote control.

■ Setting the Image Display Duration

When running slide shows of multiple image files saved on external memory, you can specify the length of time each image is to appear.

1. Press the One Touch Program [Piano] button.
The piano screen will appear.
2. Press the [Option] button.
3. Touch the <External Display>.
4. Touch the <Slide Show> at the bottom left of the screen.

The following screen will appear.



5. Touch the <Interval>   to set the interval at which the displayed images are to be switched.

Available settings

Slow, Little Slow, Medium, Little Fast, Fast

Display of images may not, depending on the size of the image, be displayed exactly according to the interval setting.

6. Press [Exit] button to go back to the "Functions screen."



Selecting the Part to Which the Effect is Added (EffectsPart)

You may find effects not being applied to certain parts when different effects are applied to the upper tone, layer tone, and lower tone. In such instances, you can select which effect is to have priority.

1. Press any tone button, and select the tone (p. 28).
2. Touch <Effect>.
3. Touch <Part>.

A screen like the one shown below appears.



4. Touch   to select the part to which the effect is added.

The effect will be applied to the selected part and other parts to which the same effect has been applied.

Available settings

Upper, Layer 1, Layer 2, Lower 1, Lower 2

Formatting the User Memory

The KR features an internal storage area where you can save recorded performances and User Styles. This space is called the “User Memory.”

The following content is stored to the user memory.

- Content registered to the “Favorites” (p. 82)
- Sets of saved User Programs (p. 131)
- User Styles saved on user memory (p. 158)
- Image files set with the “User Image settings” (p. 170)

To delete all of the content held in the user memory and restore the original factory settings, carry out the following procedure.

1. Press the [Song/File] button.

2. Touch <File>.

3. Touch <Format>.

4. Touch   to select “User.”

5. Touch <Execute>.

A screen like the one shown below appears.



6. Touch <OK>.

All of the content in the user memory is deleted. If you touch <Cancel>, the deletion is cancelled, and you’re returned to the previous screen.

- * **Never turn off the power while the display indicates <Executing...>. Doing so will damage the KR’s internal memory, making it unusable.**

→ Carrying out this operation does not initialize any settings other than the user memory settings. To restore settings other than those for the user memory to the original factory settings, carry out Factory Reset (p. 172).

Automatically Starting the Quick Tour

You can set the instrument so that the Quick Tour starts automatically with no operation required.



1. Hold down the [Transpose] button and press the [Surround/Reverb] button.

The Quick Tour screen appears.

2. Press the [Option] button.

A screen like the one shown below appears.



3. Touch   of each parameter to make settings.

Item	Display	Explanation
Auto Start	ON, OFF	This setting determines whether or not Quick Tour starts when no adjustment or other operation is performed within a fixed period of time.
BGM	ON, OFF	This setting determines whether or not background music is added when Auto Demo begins.

When Auto Start is set to “ON,” a period of five to ten minutes passes without the instrument being touched, the demo automatically starts. The demo stops playing if the instrument is operated in any way. When Auto Start is set to “OFF,” the demo does not start unless you touch the <Auto Demo> icon in the Demo screen.

4. Press the [Exit] button to return to the Quick Tour screen.

→ This setting is saved even after the power is turned off.

* For more information about Quick Tour, refer to the Quick Start.

* You cannot start the demo songs if you have any performance recorded but not saved. Before starting the demo, either delete or save the song when the song delete screen(p. 104) is displayed.

Adjusting the Piano Designer Resonance



You can make precise changes to the Piano Designer “Resonance” setting.

More of the resonance effect is applied as the value is increased.

1. Press the [Piano Designer] button.
2. Press the [Option] button.

A screen like the one shown below appears.



3. Touch   of each item to make settings.

Item	Explanation
String	With an acoustic piano, playing a note causes the strings for other keys already being pressed to resonate. The function that reproduces this resonant sound is called “String Resonance.”
Damper	When the damper pedal on an acoustic piano is pressed, the sound of the key that is played causes other strings to resonate, adding rich reverberation and breadth to the sound. This function reproduces the resonant sound created by pressing the damper pedal (Damper Resonance).
Key off	This reproduces the “key off” sound (the subtle sound made when the keys are released) produced when playing an acoustic piano.

Disabling Functions Other Than Piano Performance (Panel Lock)

The “Panel Lock” function locks the KR in a state where only piano performance can be used, and all buttons will be disabled. This prevents the settings from being inadvertently modified even if children press the buttons accidentally.

* *In the Panel Lock state, only the grand piano sound can be played.*

1. Turn down the volume all the way.
2. Press the [Power] switch to turn off the power.
3. While holding down the [Wonderland/Game] button, press the [Power] switch and turn on the power.

Hold down the button for at least ten seconds (until the animation is displayed).

All buttons except for piano play are disabled.

Adjust the volume. When you play the keyboard, the grand piano sound will be heard.

To undo the Panel Lock function, turn the volume down to the minimum, and turn on the power once again.

Detailed Song Playback Settings



■ Changing the Tone Settings When Playing Back Songs (Play Mode)

With the normal setting, GS tones (sounds that are compatible with other GS instruments) will normally be used to play back song data. By changing this setting, you can play back song using KR-specific tones for certain portions of the data.

→ For detailed information about GS, refer to “About the KR Sound Generator” (p. 217).

1. Press the [Menu] button.

The “Composer Menu” or the “A/V Sync” screen appears.

2. Touch   to switch the screens, touch <Play Mode>.

A screen like the one shown below appears.

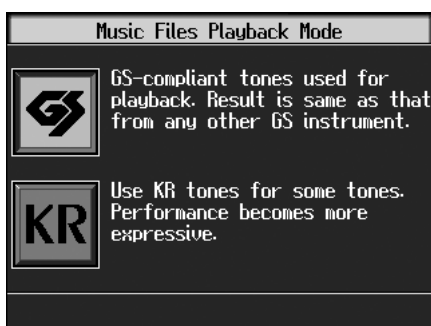

3. Touch the icon to choose the setting.

Icon	Explanation
GS	Playback uses GS-compatible tones for performances that sound like other GS instruments.
KR	Playback uses KR tones for greater expressiveness. However, differences may appear when playing back using devices other than the KR.

4. Press the [Exit] button to go back to The “Composer Menu” screen.

5. After changing this setting, try selecting the song once again.

For more detailed information about selecting a song, refer to “Playing a Song” (p. 75).

■ Viewing Song Information (Information)

You can view file names and other information concerning songs.

1. Press the [Song/File] button.

2. Touch <File>.

3. Touch <Information>.



A song information is displayed.

■ Hiding the Lyrics (Lyrics)

Some commercially available music files for use in karaoke, as well as some of the internal songs include lyrics data. When you play such music files, the lyrics automatically appear in the screen. If you do not want lyrics to appear automatically, set this to “OFF.”

1. Press the [Menu] button.

The “Composer Menu” or the “A/V Sync” screen appears.

2. Touch   to switch the screens, then touch <Lyrics>.

A screen like the one shown below appears.



3. Touch   to select the setting.

Display	Explanation
ON	Lyrics are displayed automatically (when performance data containing lyrics is played back).
OFF	Lyrics are not displayed, even if the song data being played back contains lyrics data.

4. Press the [Exit] button to return to The “Composer Menu” screen.

→ Even when this is set to “OFF,” you can still have the lyrics be displayed by touching <Lyrics> when it appears in the Piano or Basic screen (p. 26).

→ The screen may be switched when you press the button while the Lyrics screen is displayed. To have the lyrics displayed again, touch < **Lyrics** > on the Piano or Basic screen, or stop playback of the song, then press the [▶ / ■ (Play/Stop)] button.

■ Changing the Parts Assigned to the Track Buttons During SMF Playback (Track Assign)

Normally, when playing back Roland Piano Digital-compatible SMFs (p. 217), the lower part is assigned to the [3/Lower] button, and the upper part is assigned to the [4/Upper] button. However, assignment of the upper and lower parts may differ with some SMF data.

If you cannot get the upper and lower parts to work well set on “Auto,” then change the setting to “2/1 Part” or “3/4 Part.”

→ This setting can be used with songs stored in external memory and on CDs, and songs in SMF format. The setting does not work with internal songs or songs registered to the Favorites.

1. Press the [Menu] button.

The “Composer Menu” or the “A/V Sync” screen appears.

Touch   to switch the screens.

2. Touch <Track Assign>.

A screen like the one shown below appears.



3. Touch to select the setting.

Display	Explanation
Auto	The part assigned to each track will be determined automatically, depending on the song data.
2/1 Part	Part 1 will be assigned to the upper part track, part 2 to the lower part track, and part 3 to the user track.
3/4 Part	Part 4 will be assigned to the upper part track, part 3 to the lower part track, and part 1 to the user track.

4. Press the [Exit] button to return to The “Composer Menu” screen.

After changing this setting, try selecting the song once again.

For more detailed information about selecting a song, refer to “Playing a Song” (p. 75).

MEMO

Chapter 11 Connecting External Devices

You can connect the KR to external devices such as audio equipment, MIDI instruments and computer.

○ Connecting an External Display or Television

You can connect a computer monitor or other external display or a television to the KR, enabling you to display the Song Select screen, your favorite images, song lyrics, and notations on a larger screen.

○ Connecting Video Equipment (p. 187)

With a V-LINK compatible device connected, you can switch images with the keyboard.

○ Connecting MIDI Devices (p. 188)

You can connect a MIDI sequencer and record performance data from the KR, or play performance data from the KR on the sequencer. Also, when you connect a MIDI sound module, you can perform on the KR and hear the sounds played through the MIDI sound module.

○ Connecting Audio Equipment (p. 191)

The KR has high-quality built-in stereo speakers, but you can also hook it up a stereo system for an even more impressive sound.

You can also connect it to a tape recorder or other recording equipment and record your performances.

○ Connecting a Computer (p. 195)

You can use a sequencer program to record performance data from the KR and play performance data from the program on the KR.

○ Connecting an Expression Pedal

You can connect an expression pedal to the KR.

Connect the Expression pedal to the Expression Pedal jack on the jack panel of the KR.

* *Use only the specified expression pedal (EV-7/5; sold separately). By connecting any other expression pedals, you risk causing malfunction and/or damage to the unit.*

Connecting an External Display or Television

You can connect a computer monitor or other external display or a television to the KR, enabling you to display the Song Select screen, your favorite images, song lyrics, and notations on a larger screen.

→ *You can switch screens with the remote control. For details, see "Using the Remote Control" (p. 84).*

You cannot simultaneously use both an external display and a television with the KR. Moreover, neither the external display nor the television will be able to display properly if both are connected at the same time.

When using an external display, connect the display to the Ext Display connector, but do not connect a television to the Video Out connector.

If using a television, connect the television to the Video Out connector, but do not connect any external display to the Ext Display connector.

For more information about external display settings, refer to "Changing the Settings for Showing Images with the External Display and the Television (External Display)" (p. 186).

■ Connecting an External Display

Displays That Can Be Connected to This Instrument

In general, a great many of the VGA monitors and multiscan monitors that are available on the market are compatible with this instrument. However, before you connect any monitor, make sure it meets the following specifications:

Resolution	640 x 480 pixels
Horizontal scan frequency	31.5 kHz
Vertical scan frequency	60 Hz
Connector	3-row, 15-pin D-Sub type
Signal	Analog

* *Confirm that the display to be used is compatible with the frequencies mentioned above. Using a display that is not compatible with the above frequencies may result in incorrect image output when images move, and in certain cases may even damage the display.*

Making the Connections

* To prevent malfunction and/or damage to speakers or other devices, always turn down the volume, and turn off the power on all devices before making any connections.

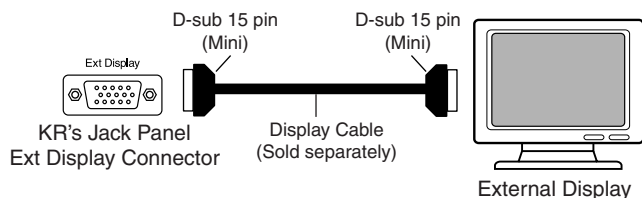

1. Turn off the power to the KR and the display to be connected.

2. Use display cable (sold separately) to connect the display to the Ext Display connector on the KR.

* You cannot display information or images with an external display when a television is connected to the Video Out jack. To use an external display, first disconnect the television from the Video Out jack, then connect the external display connector.

3. Switch on the KR.

4. This sets the display format (device, p. 187).

5. Switch on the connected display.

→ For more on handling the external display, refer to your display's owner's manual.

Turning the Power Off

After use, turn off the power using the following procedure.

1. Turn the volume all the way down on the KR.

2. Turn off the KR.

3. Turn off the connected display.

■ Connecting a Television

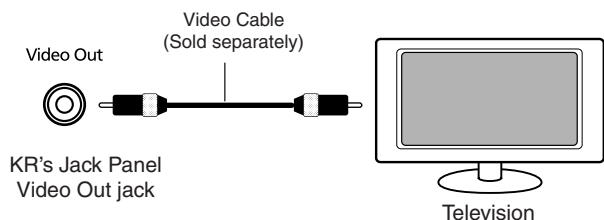

Making the Connections

Always be sure to use the following procedure when connecting a television.

* You cannot display information or images with a television when an external display is connected to the Ext Display connector. To use an television, first disconnect the external display from the Ext Display connector, then connect the Video Out jack.

1. Turn off the power to the KR and the television to be connected.
2. Use a video cable (sold separately) to connect the KR's Video Out jack with the television's video input jack.
3. Turn on the power to the KR.
4. This sets the display format (device, p. 187).
5. Turn on the power to the television.

■ Changing the Settings for Showing Images with the External Display and the Television (External Display)

This selects the content shown on the external display or the television connected to the KR.

1. Press the One Touch Program [Piano] button.
2. Press the [Option] button.
3. Touch <External Display>.

A screen like the following appears.

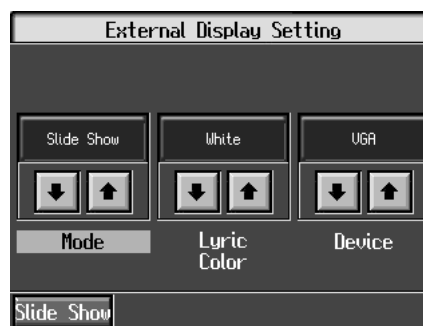

4. Touch the parameter  to make the settings.
5. Press the [Exit] button to return to the Function screen.

■ Explanation of Each Items

Mode

You can have different images displayed on the television or external display than those appearing on the KR's own display.

Settings Value	Explanation
Auto	The display of notations, lyrics, notation and keyboard, and lyric are switched automatically.
Panel	Screens are shown the same way they appear in the KR's display.
Notation	The Notation screen is normally displayed.
Notation and Keyboard	The notation and keyboard are displayed.
Lyric	The Lyrics screen is normally displayed. However, lyrics are displayed only when playing back music files that contains lyrics data.
Slide Show	The image is displayed in the slide show.

Notes When Switching the Display on External Displays and Televisions

- Lyrics are not displayed with audio CDs.
- You cannot display any lyrics screen when playing back music data that does not include lyrics data.
- The internal songs include a number of jazz pieces that are played in an improvised fashion, and you may find notes not conforming to measure lines, odd divisions of the parts played in the left and right hand, and other such features that do not match what is shown in the notation.
- Neither the external display nor the television will be able to display properly if both are connected at the same time.

Lyric Color

Selects the color used for lyric in the display.

Value: **White, Black, Red, Yellow, Green, Blue, Cyan, Magenta**

Device

If you find that the image quality of the television is poor, try switching the television format.

Value: **VGA, PAL, NTSC**

Connecting Video Equipment (V-LINK)

Connecting the KR to a V-LINK compatible image device allows you to control the images with the KR.

V-LINK (**V-LINK**) is functionality promoted by Roland that allows linked performance of music and visual material. By using V-LINK-compatible video equipment, visual effects can be easily linked to, and made part of the expressive elements of a performance.

- * To prevent malfunction and/or damage to speakers or other devices, always turn down the volume, and turn off the power on all devices before making any connections.

Connection Examples:

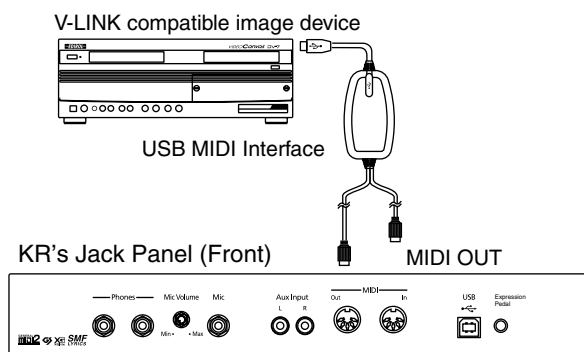

■ Using the V-LINK function

1. Press the One Touch Program [Piano] button.
2. Press the [Option] button.
3. Touch <V-LINK>.
4. Touch <ON>.

Switches to Image Control mode.

You can control images using the twelve keys at the left end of the keyboard.

When V-LINK is on, "V-LINK" is indicated in the Basic screen and other screens.

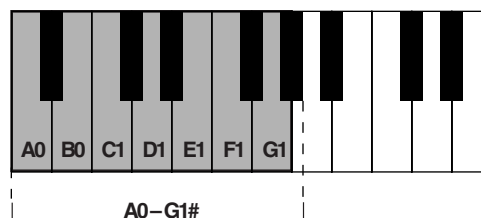

While V-LINK is switched on, no sound is produced when you press any of the twelve keys at the left end of the keyboard.

5. Touch <OFF> to cancel the V-LINK function.

Connecting MIDI Devices

By connecting an external MIDI device and exchanging performance data, you can control one device from the other. For instance, you can output sound from the other instrument or switch Tones on the other instrument.

What's MIDI?

MIDI, short for "Musical Instrument Digital Interface," was developed as a universal standard for the exchange of performance data between electronic instruments and computers.

The KR is equipped with MIDI connectors to let it exchange performance data with external devices. These connectors can be used to connect the KR to an external device for even greater versatility.

Connectors

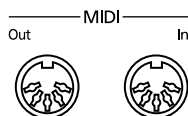

MIDI Out Connector

Connect this to the MIDI In connector on an external MIDI device using a MIDI cable (sold separately).

Performance data when you play the keyboard or depress a pedal is sent from this connector to the external MIDI connector.

MIDI In Connector

Connect this to the MIDI Out connector on an external MIDI device using a MIDI cable (sold separately).

This receives MIDI messages that are sent from external MIDI devices. The KR receiving MIDI messages can output sounds, exchange tones and perform other operations.

* External MIDI devices can't be used for remotely changing the Tones played by the KR's keyboard.

Making the Connections

* To prevent malfunction and/or damage to speakers or other devices, always turn down the volume, and turn off the power on all devices before making any connections.

1. Turn the volume all the way down on the KR and on the device you're about to connect.
 2. Switch off the power to the KR and the device you're about to connect.
 3. Use a MIDI cable (sold separately) to connect the MIDI connectors to each other.
- Please refer to the connection examples below.
4. Switch on the power to the KR and the connected device.
 5. Adjust the volume level on the KR and the connected device.
 6. You should also set the MIDI settings as needed.

For details on the MIDI-related settings, refer to p. 189–p. 191.

Connection Examples:

Setup with a MIDI Sequencer

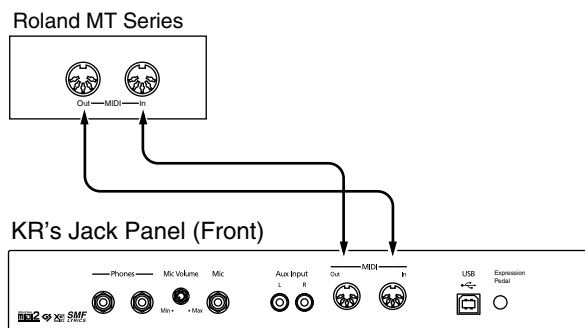

* When the KR is connected to a MIDI sequencer, set it to Local OFF. Refer to "Disconnecting the Internal Sound Generator and Keyboard (Local Control)" (p. 190).

Connecting with a MIDI Sound Module

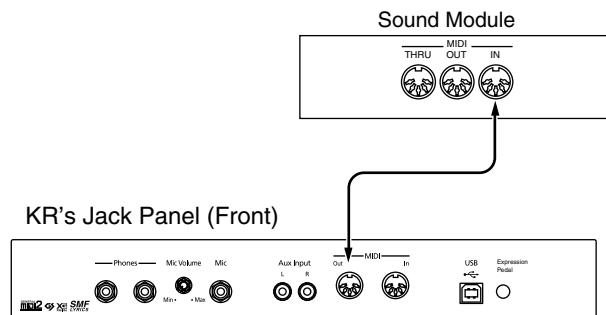

Performing in Ensemble with MIDI Instruments (MIDI Ensemble)

You can connect an electronic percussion device or other MIDI instrument to the KR's MIDI In connector for ensemble playing. Making the MIDI settings for the instrument connected to the MIDI In connector is easy. The sounds from the connected MIDI instrument are played from the KR's speaker.

1. Press the One Touch Program [Piano] button.
2. Press the [Option] button.
3. Touch <MIDI Ensemble>.

A screen like the following appears.



4. Select the method for using the MIDI In connector.

Displayed	Meaning
Normal	Normal setting. Make changes in Tone and other settings from the connected device.
Pad	Select this when you have percussion pads connected to the KR's MIDI In connector. You do not need to make any MIDI settings on the KR. Select pad Tones and make other settings from the connected pads (for further details, refer to the Owner's Manual provided with the pads).
Keyboard	Select this when you have a keyboard connected to the KR's MIDI In connector. You can select tones for the connected keyboard from the KR. No MIDI settings need be made on the KR.

5. When "Keyboard" is selected in Step 4 above, use



to select the Tone.

The connected keyboard plays using the selected Tone.

MIDI Settings

You can make MIDI settings like those described below.

<MIDI Setting>



Display	Explanation
Tx Channel	Chooses the MIDI send channel (p. 190).
Local Control	Switches Local Control on or off (p. 190).

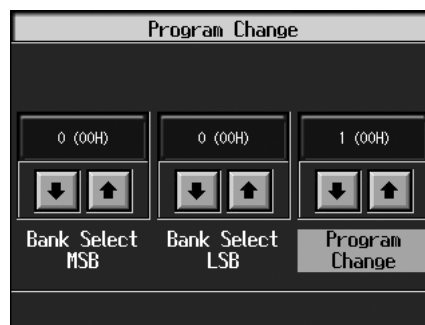

<Program Change>



Display	Explanation
Bank Select MSB	Sends Bank Select MSB messages (p. 191).
Bank Select LSB	Sends Bank Select LSB messages (p. 191).
Program Change	Sends Program Change messages (Program Numbers) (p. 191).

Chapter 11 Connecting External Devices

Making the Settings

1. Press the One Touch Program [Piano] button.
2. Press the [Option] button.
3. Touch <MIDI Setting> or <Program Change>.
4. Touch   to make the setting for each item.

Press the [Exit] button to return to the Functions screen.

Selecting the Transmit Channel (Tx Channel)

MIDI organizes things into “channels,” which are numbered from 1 through 16. Simply connecting a cable is not enough for communication to take place. The connected devices must be set to use the same MIDI channels. Otherwise, no sound will be produced, and no sounds can be selected.

Select the transmit channel (1–16) of the KR.

The channel setting is at “1” when the KR is powered up.

If the keyboard has been split into upper and lower sections, messages from the left-hand section are fixed at “3.”

The KR receives messages on all channels from 1 through 16.

Disconnecting the Internal Sound Generator and Keyboard (Local Control)

When connecting a MIDI sequencer, set Local Control to “OFF.” The setting is at “Local Control ON” when the KR is powered up.

As illustrated, information describing what has been played on the keyboard is passed to the sound module over two different routes, (1) and (2). As a result, you hear overlapping or intermittent sounds. To prevent this from happening, route (1) must be disabled, by setting the unit to what is known as “Local Off.”

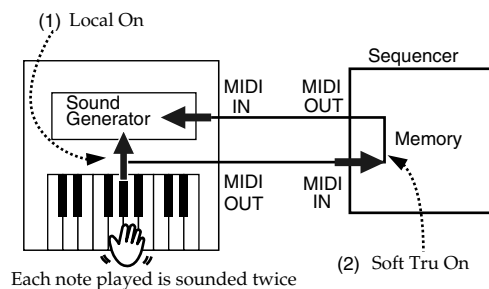

Local On: The keyboard and internal sound generator are connected.

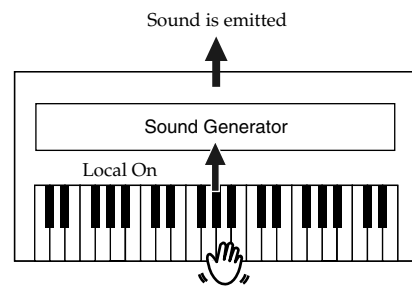

Local Off: The keyboard and internal sound generator are separated. No sound will be produced by the keyboard when it is played.

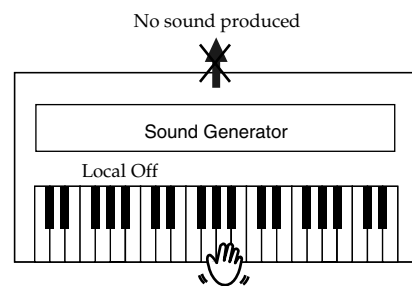

→ When connecting a unit in the Roland MT series, you don't need to switch off Local Control. MT units transmit Local Off messages when their power is switched on. First turn on the power to the KR, then after a few moments, play a note on the KR; when you turn on the power to the MT Series device, Local Off is automatically enabled for the KR.

■ Sending Tone Change Messages (Program Change/Bank Select MSB/Bank Select LSB)

A Program Change is a message that means “change to the Tone of the specified number.” The device that receives this changes to the Tone of the corresponding number.

When you choose a Program Change message (Program Number), the Program Number will be transmitted to the MIDI device connected to the KR. The MIDI device that receives the Program Number changes the tone to the corresponding Program Number.

Normally, the Tone is selected from the 128 Tones available. Some MIDI devices, however, have more than 128 Tones. With such devices, the Tone is selected through a combination of Program Change messages and Bank Select messages. There are two parts of a Bank Select message: the MSB (Controller 0, with a value of 0–127) and the LSB (Controller 32, with a value of 0–127).

* *Some MIDI instruments can't handle Bank Select messages. Others can handle Bank Selects, but do not recognize the LSB part.*



Sending Recorded Performance Data to a MIDI Device (Composer MIDI Out)

When Composer Out is active, you can send performance data recorded with the KR to a connected MIDI device or computer.

When you turn on the power, this is set to “OFF” (data is not sent).

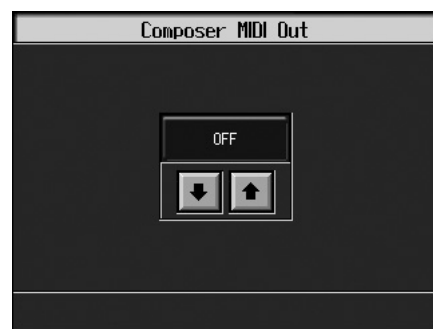
1. Press the [Menu] button.
2. Touch <Composer MIDI Out>.



3. Touch   to set ON or OFF.
4. Press the [Exit] button to return to The “Composer Menu” screen.

Connecting to Audio Equipment

You can connect audio devices to play the sound of the KR through the speakers of your audio system, or to record your performance on a recording device.

■ Connectors

KR's Jack Panel

Front

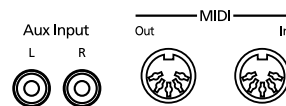

Rear

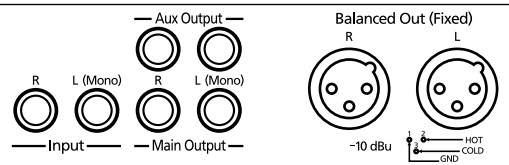

Chapter 11 Connecting External Devices

Output Jacks (Main Output/Aux Output)

You can connect audio equipment using audio cables (sold separately) and play the sounds from the KR through the speakers on the connected equipment, or record your performances on a recording device.

If the input of the connected device is monaural, you must use the L (Mono) jack.

Input Jacks (Input/ Aux Input)

You can connect another sound generator, such as audio equipment or an electronic instrument, using audio cables (sold separately). Play the sounds from the connected device through the speakers on the KR.

If the output of the connected device is monaural, you must use the L (Mono) jack.

* You cannot use the KR to adjust the volume of the connected sound generating device.

About the Output jack

This instrument is equipped with balanced (XLR) type jacks. Wiring diagrams for these jacks are shown below. Make connections after first checking the wiring diagrams of other equipment you intend to connect.

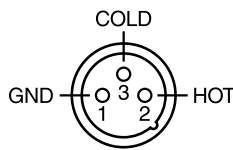

Making the Connections

* To prevent malfunction and/or damage to speakers or other devices, always turn down the volume, and turn off the power on all devices before making any connections.

Playing Sounds from the KR Through the Speakers on Audio Equipment or Recording Your Performances on a Recording Device

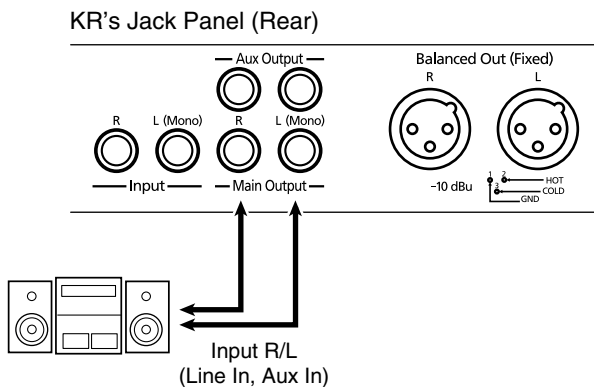

1. Turn the volume all the way down on the KR and on the device you're about to connect.

2. Turn off the power to the KR and other connected equipment.
 3. Use audio cables (sold separately) to make the connection.
 4. Switch on the KR.
 5. Switch on the connected device.
 6. Adjust the volume level on the KR and the connected device.
- You can adjust the volume of a connected sound module with the KR.

Recording KR Performances on a Recording Device

7. Start recording with the connected device.
8. Play the keyboard.
9. When the performance ends, stop recording on the connected equipment.

Turning off the power

1. Set the volume of the KR and of the connected devices to the minimum position.
2. Turn off the connected equipment.
3. Turn off the power to the KR.

Playing Audio Equipment Sounds Through the Speakers on the KR

KR's Jack Panel (Rear)

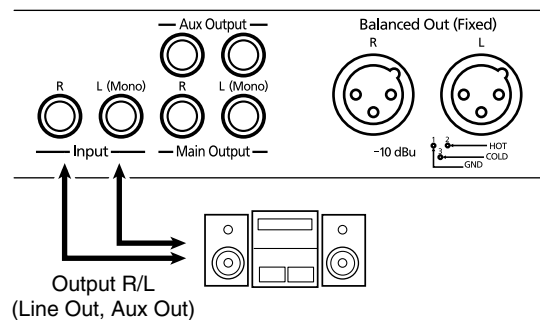

KR's Jack Panel (Rear)

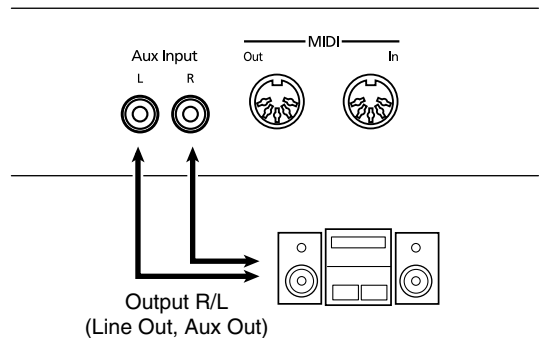

1. Turn the volume all the way down on the KR and on the device you're about to connect.
2. Turn off the power to the KR and other connected equipment.
3. Use audio cables (sold separately) to make the connection.
4. Turn on the connected equipment.
5. Turn on the KR.
6. Adjust the volume level on the KR and the connected device.

* You cannot use the KR to adjust the volume of the connected sound generating device.

Turning off the power

1. Set the volume of the KR and of the connected devices to the minimum position.
2. Turn off the power to the KR.
3. Turn off the connected equipment.

Making the Aux Input Jack Settings

Use this procedure to set the Aux Input jack assignments when using these jacks.

1. Press the [Menu] button.

The "Composer Menu" or the "A/V Sync" screen appears.

2. Touch <Left Arrow> <Right Arrow> to switch the page, then touch <AUX Input>.

The following screen will appear.

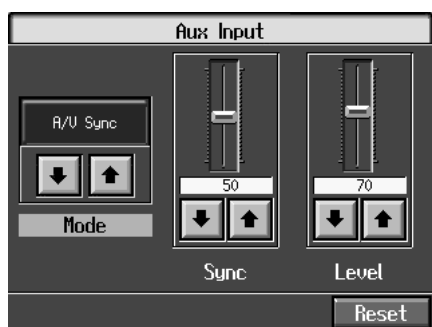

3. Touch the <Mode> <Down Arrow> <Up Arrow> to change the type of the AUX Input.

Indication	Description
Off	The Aux Input jacks cannot be used.
Stereo	Select this setting when connecting an MD player or similar device.
A/V Sync	Select this setting when inputting MIDI encoded signals. The type of encoded signal is determined automatically.
A/V Sync Type A	Select this setting when inputting MIDI encoded signals.
A/V Sync Type B	If the "A/V Sync" setting is not correct, set this to Type A or Type B.

This is set to "Off" at the factory.

→ When "A/V Sync" is selected, the KR automatically distinguishes the type of the encoded signal, then starts playing. In some cases, however, it doesn't play correctly. In such cases, press <Reset>. If playback still doesn't occur correctly, set "Mode" to either "A/V Sync Type A" or "A/V Sync Type B."

* If both the A/V Sync output and AUX input are connected simultaneously, please set "Mode" of the Aux input to "Off." If this is set to anything other than "Off," make sure to disconnect any cables connected to Aux Out or Balanced Out. If such connections are left intact, you may likely encounter a loud, continuous beep tone.

4. Touch the <Sync> or the <Level> <Down Arrow> <Up Arrow> to change the setting.

Indication	Setting	Description
Sync	0-100	Adjust this value if the keyboard performance is not synchronized properly with other audio data with the type set to "A/V sync."
Level	0-128	This adjusts the level for the device connected to the Aux Input jacks.

→ If the level is set to "0," only keyboard performance sound from the device connected to the Aux Input jacks will be heard.

5. Press the [Exit] button.

Connecting External Speakers

You can connect external speakers and have what is played on the keyboard be output through the KR's speakers while the accompaniment is played through the connected external speakers.

Changing the Aux Output Jacks Settings

1. Press the [Surround/Reverb] button.
2. Touch the <Surround>.



3. Touch the Type icon to select the type.

Indication	Description
Ensemble	Select this when playing the keyboard performance through the KR's internal speaker and the accompaniment sound through an amp or speaker connected to the Aux Output jacks.
Surround	The sounds played with the keyboard and the accompaniment sounds are played through the KR's speakers, and the accompaniment sound with reverb applied is played through the speakers connected to the Aux Output jacks. Playing the accompaniment sound with reverb from external speakers the effect of being enveloped by the performance (Surround effect).

When any icon is not chosen, No sound is heard through an amp or speaker connected to the Aux Output jacks.

4. Press the [Exit] button.

Setup Examples With Surround Set to "Surround" or "Ensemble"

The piano sound is played through the KR's speaker, and the surround sound is played through the external speaker.

Spacious Location

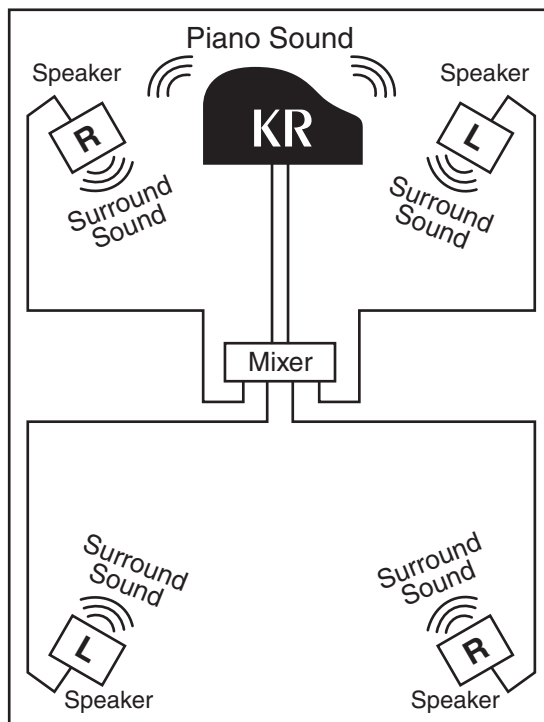

Location Limited in Space

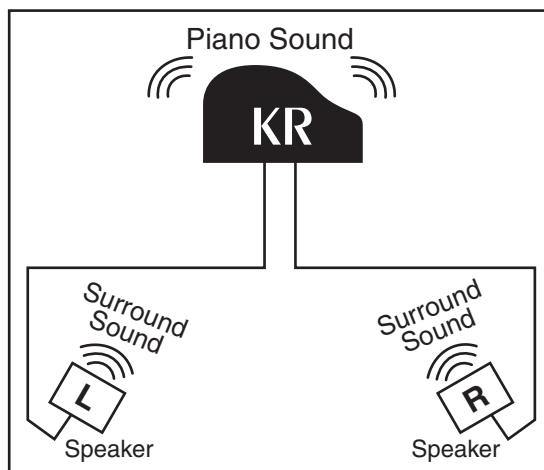

Connecting a Computer

■ Connect to the MIDI Connectors

You can use a USB MIDI interface cable (sold separately) to connect the KR to your computer.

If the KR is connected to a computer in which sequencer software such as Roland's "Visual MT" is installed, a song you've recorded on the KR can be saved on your computer.

Connection Examples

- * To prevent malfunction and/or damage to speakers or other devices, always turn down the volume, and turn off the power on all devices before making any connections.
- * In order to make connections to your computer, you must install "MIDI driver" software on your computer. For details, refer to the owner's manual for your MIDI interface.

Use a USB MIDI interface cable to connect the USB connector of your computer to the MIDI connectors of the KR.

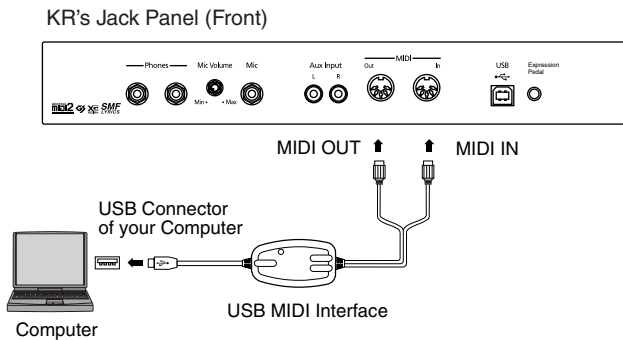

■ Connect to the USB Connector

You can connect your computer with a USB cable to the USB connector, located on the left underside of the KR, and exchange MIDI data between the instrument and the computer. You can use the KR to play SMF data created with the computer and exchange performance data in the same manner as with MIDI devices connected to the MIDI connectors.

Connecting your computer to the KR for the first time requires installation of the "USB Driver" (on the included CD-ROM) to the computer.

The correct driver and the installation procedure will depend on your system and on the other programs you are using. Be sure to read the README file on the CD-ROM before installation.

Windows XP/2000

→ \W2kXP\Readme_E.htm

Windows Me/98/98SE

→ \W98Me\Readme_E.htm

Mac OS X

→ \Driver (Mac OS X)\Readme_e.htm

- * Only MIDI data can be transmitted using USB.
- * To prevent malfunction and/or damage to speakers or other devices, always turn down the volume, and turn off the power on all devices before making any connections.
- * USB cables are not included. Consult your Roland dealer if you need to purchase.
- * Turn on the power to the KR before starting up MIDI applications on the computer. Do not turn the KR on or off while any MIDI application is running.
- * If not using USB, disconnect the USB cable from the KR.
- * If during the transmission/reception of data, the computer switches to energy-saving mode or suspended mode, or if the KR's power is switched on or off, the computer may freeze, or the KR's operation may become unstable.
- * Do not connect or disconnect the USB cable or turn off the power during the transmission/reception of data.

For more on system requirements, refer to the "USB Installation Guide." However, note that the KR is not compatible with Mac OS 9.

Chapter 11 Connecting External Devices

Connection examples

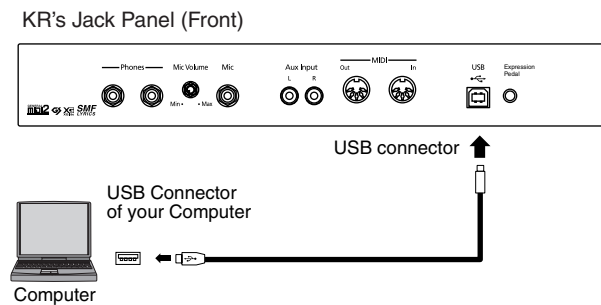



1. Turn off the power to the KR and the computer.
2. Start up the computer.
3. Connect the KR and the computer with a USB cable.
4. Turn on the power to the KR.

→ Refer to the owner's manual that came with your computer

■ Making the Settings for the USB Driver

This sets the USB driver used when you have a computer connected to the USB connector.

In the factory settings, "Original" is selected. Normally, there is no need to change the USB driver settings.

1. Open the Basic screen or press the One Touch [Piano] button.
2. Touch the [Option] button.
3. Touch <USB Driver>.
4. Touch   to select the driver type.

Indication	Description
Generic	Select this when using a generic USB driver included with the OS with a USB connection.
Original	Select this when using the supplied driver with a USB connection. Under ordinary circumstances, use this mode.
Original 2	This is an auxiliary mode. It is not normally used.

5. After changing the settings, turn the power off, then on again.

Troubleshooting

If you think there's a problem, read this first.

Case	Cause/Remedy
The power doesn't come on	Is the power cord connected and plugged in correctly? (p. 21)
The button doesn't work	Is the panel locked? (p. 181) Turn the power off, then back on.
Nothing appears on screen	The KR uses a liquid-crystal screen, so text may not be displayed when the ambient temperature is below freezing.
Vertical lines appear in the screen/Color is "washed out" at the edges of the screen	These occur due to the nature of a liquid crystal display, and do not indicate a malfunction. They can be minimized by adjusting the brightness of the screen (p. 25).
The touch screen doesn't respond correctly	The positioning of the touch screen may become displaced if some time has passed since it was last used. Take a look at "Calibrating the Touch Screen (Touch Screen)" (p. 175) to correct the positioning.
Depressing a pedal has no effect, or the pedal effect doesn't stop	Is the pedal connected correctly? Make sure the pedal cord extending from the stand is securely connected to the pedal connector on the rear of the unit (p. 21).
	Has a different function been assigned to the pedal? See "Assigning Functions to Pedals and Performance Pads (Pedal Setting/User Functions)" (p. 167).
	Normal pedal operation is automatically enabled when the One Touch Program [Piano] button is pressed (p. 22).
The volume level of the instrument connected to Input jacks is too low	Could you be using a connection cable that contains a resistor? Use a connection cable that does not contain a resistor.
Unable to read from/write to external memory	Are you using (optional) Roland memory? Reliable performance cannot be guaranteed if you use non-Roland memory products.
Low hum coming from external device	Do you have different external devices plugged into different power outlets? When connecting external devices, always draw power from the same outlet.
Remote Control not functioning	No data from the remote control is received when the Remote Sensor is switched off. Check (p. 172).

Case	Cause/Remedy
Screen on connected display or television doesn't look right	
Images not shown on external display when external display is connected	Is the external display properly connected (p. 185)?
	Is the external display's power turned on?
	Are you using a display that is compatible with the KR? Refer to "Displays That Can Be Connected to This Instrument" (p. 185).
	Do you have a television and external display connected at the same time? Connect only one of these.
Thin horizontal lines visible in the television screen	Are the KR's settings correct? Follow the instructions in "Selecting Images To Be Shown on the KR and External Displays (User Image Display)" (p. 170) to set the "External Display" image. Also refer to "Changing the Settings for Showing Images with the External Display and the Television (External Display)" (p. 186).
	While narrow horizontal lines may be visible in the television screen, this is a particular characteristic of the television set and does not indicate any problem with the KR.
Poor-quality of images displayed in television	Even when all recommended settings are used, images may still not be displayed well with the television set you are using (images may not match the screen size, and may be clustered towards the center of the screen).

No sound is heard	
No sound is heard	Is the volume level of the KR (p. 22) or connected device turned all the way down?
	Are headphones plugged in? (p. 23) Has a plug remained connected to the Phones jack? When headphones or plugs are connected, the keyboard's speaker stops playing.
	Has the Balance knob been moved all the way to the right or left? Has the volume been set to "0" using the Part Balance? (p. 73)
	Are all sliders in the Equalizer screen at the minimum level? (p. 44)
	Has the footage been adjusted so that all frequency components aren't sounded? (p. 15 in the Quick Start)

Troubleshooting

Case	Cause/Remedy
No sound is heard	Is the speaker cable connected and plugged in correctly?
	Is V-LINK switched on? (p. 187) When V-LINK is switched on, the twelve keys at the left end of the keyboard are used to control images, and no sounds are played with these keys.
No sound is heard (when a MIDI instrument is connected)	Have all devices been switched on?
	Are the MIDI cables connected correctly? (p. 188)
	Does the MIDI channel match the connected instrument? (p. 190)
No sound is heard when the keyboard is played	Has Local Control been set to "Off"? When Local Control is set to Off, no sound is produced by playing the keyboard. Set Local Control to On (p. 190).
Not all played notes are sounded	The maximum number of notes can play simultaneously is 128. Frequent use of the damper pedal during automatic accompaniment or when playing along with a song on external memory may result in performance data with too many notes, causing some notes to drop out.

The sound is strange	
Sounds are heard twice (doubled) when the keyboard is played	Is the KR in layer play? (p. 31)
	When the KR is connected to an external sequencer, set it to the Local OFF mode (p. 190). Alternatively, the sequencer could be set so its Soft Thru feature is OFF.
The tuning or pitch of the keyboard or song is off	Have you set transpose? (p. 102)
	Are the settings for the "Temperament" and "Stretch Tuning" correct? (p. 166)
	Is the setting for the "Master Tune" correct? (p. 170)
Effects cannot be applied to Tones	If different effects have been selected for the upper, lower, Layer, and other Tones, and the effects for the Parts don't match, only one of the effects is applied. It's not possible to apply more than one effect at the same time, so when a performance has been recorded on multiple tracks or when playing along with a song as it's played back, the desired effect may not be applied.
A note doesn't stop playing	Have the Chord Tone and Bass Tone been changed? (p. 162) Some Chord Tone and Bass Tone notes may be sounded continuously.

Case	Cause/Remedy
A loud, continuous beep tone suddenly begins sounding	Have you simultaneously connected devices for both the output for A/V Sync and AUX input? If you use the instrument when two simultaneous connections have been made, a loud, continuous beep tone may suddenly begin sounding. You need to set "Mode" of the Aux input to "Off." Please disconnect whatever you have connected to Aux Out or Balanced Out when set to anything other than "Off."
	During automatic accompaniment, changing the Music Style automatically changes the Tones and tempo of the upper part of the keyboard to match the new Music Style. If you want to change only the Music Style without also altering the tempo and Tone, check out "Changing Music Styles Without Changing the Tone or Tempo (One Touch Setting)" (p. 162).
The Tone has changed	When a performance made along with a Music Files tune has been recorded, recording the performance to button [1/Whole] may make the Tones for buttons [3/Lower] and [4/Upper] change as well.
	Since the KR's piano sounds faithfully reproduce the sense of spaciousness and reverberation of an actual acoustic piano's sound, a certain amount of reverberation is still perceptible, even with the reverb effect deactivated.
Reverberation still audible even with Reverb turned off	
Sound from the Output jacks is not right	Have you made the correct Advanced 3D settings for use with headphones? Changing the Advanced 3D "Mode" to "Headphones" or "Auto" and connecting a pair of headphones configures the settings for use with headphones.
In the upper range, the sound changes abruptly beyond a certain key	On an acoustic piano, notes in the upper one and a half octaves of the keyboard continue to sound until they decay naturally, regardless of the damper pedal. There is a difference in the timbre as well. Roland pianos faithfully simulate such characteristics of the acoustic piano. The range that is unaffected by the damper pedal will change depending on the Key Transpose setting.

Case	Cause/Remedy
A High-pitched whine is produced	<p>When listening through headphones: Some of the more flamboyant and effervescent piano tones feature an ample high-end component, which may make the sound appear to have metallic reverberation added. Since this reverberation becomes particularly audible when supplemented by heavy reverb, you may be able to diminish the problem by reducing the amount of reverb applied to the sound.</p> <p>When listening through speakers: Here, a different cause (such as resonance produced by the KR) would be suspect. Consult your Roland dealer or nearest Roland Service Center.</p>
The bass range sounds odd, or there is a vibrating resonance	<p>When listening through speakers: Playing at loud volumes may cause instruments near the KR to resonate. Resonation can also occur with fluorescent light tubes, glass doors, and other objects. In particular, this problem occurs more easily when the bass component is increased, and when the sound is played at higher volumes. Use the following measures to suppress such resonance.</p> <ul style="list-style-type: none"> • Place speakers so they are 10–15 cm from walls and other surfaces. • Reduce the volume. • Move the speakers away from any resonating objects. <p>When listening through headphones: Here, a different cause (such as resonance produced by the KR) would be suspect. Consult your Roland dealer or nearest Roland Service Center.</p>

The automatic accompaniment doesn't play correctly

Can't select a tone or Music Style	Press the [Exit] button several times to return to the Basic screen (p. 25), and then select a tone or Music Style.
Automatic accompaniment is not heard	Has the Balance knob been moved all the way to the right? (p. 73)
	Have you pressed the One Touch Program [Arranger] button? If the One Touch Program [Arranger] button has not been pressed, only the rhythm pattern is played (p. 64).
	Is the 16-track Sequencer screen displayed? (p. 136)

Case	Cause/Remedy
Chord Intelligence can't be used	Has Chord Intelligence been set to manual? (p. 162)
	Is the setting for "Piano Style Arranger" active? (p. 72)
Accompaniment tempo becomes unstable	In certain cases, such as when playing Music Styles on external memories, the accompaniment may lag when excessive amounts of performance data are used.

Song doesn't play back correctly

Song doesn't play back	Does the screen indicate message, like "OK to delete song?" (p. 104) The internal songs cannot be played back while recorded performance data remains in the KR's memory. Try playing back the song after deleting the performance data.
Only the sound of a particular instrument in a song does not play	Is the light for the Track button extinguished? (p. 97) If the button light is out, the music on that track is not heard. Press the track button so the light is illuminated.
	Have song settings been changed for each Part on the 16-Track sequencer screen (p. 137)?
Pressing the [◀] (Reset) button doesn't return to the beginning of the song	Some music files may contain settings that stop play at a point partway through the song. Press the [◀] (Reset) button several times more to return to the beginning of the tune.
	Has a Marker placed in the song? (p. 98)
The [▶▶] (Fwd) and [◀◀] (Bwd) buttons don't work	The fast-forward and reverse buttons are ignored while music files is being read in. Wait until processing finishes.
	If you attempt to play back performance data that contains more data than the entire capacity of the KR's memory, you may find that operations other than playback (such as rewind or fast forward) become unavailable.
There is a slight delay before playback of a song on external memory starts	There are two types of SMF music files: format 0 and format 1. If the song uses SMF format 1 data, there will be a slight delay until playback starts. Refer to the booklet that came with the music files you're using to determine the format type.

Troubleshooting

Case	Cause/Remedy
KR operation is sluggish when external memory is connected	Is <Mode> in the "External Display Setting" set to "Slide Show?" (p. 186) If the connected external memory contains data to be used in a slide show, the slide show will begin automatically. Set <Mode> in the "External Display Setting" to a value other than "Slide Show."
Lyrics are not indicated properly in the display	With some music files, the lyrics cannot be displayed correctly.
	If you press a button while the lyrics are being shown in the display, the lyrics will disappear. To recall them, touch < Lyrics > in the Piano or Basic screen, or press the [▶ / ■ (Play/Stop)] button.
	In the notation screen, some lyrics or notes could extend beyond the edges of the screen, and not be displayed.
Notation is not indicated properly in the display	If you select a part that does not contain performance data, notes will not be displayed in the notation. Change the part that is displayed (p. 89).
	The notation screen feature is particularly unsuitable for the display of difficult, complex musical works that demand accurate notation. Refer to "Notes Regarding the Notation Display" (p. 87).
	In the notation screen, some lyrics or notes could extend beyond the edges of the screen, and not be displayed.
Movement of notation or keyboard display not smooth	There may be times when a complex variety of information is being displayed or when a large amount of data is displayed at one time. Change the notation display settings as described below (p. 89). - Set "Bouncing Ball" to "Off" - Set "Color Notation" to "Off" - Set "Keyboard" to "Off" - Set "External Display (p. 187)" to "Panel"
Song becomes unstable	In certain cases, such as when playing songs on external memories, the song may lag when excessive amounts of performance data are used.
Unable to play back internal songs	Have you pressed the remote control's [MUTE] button, muting the sound?
Unable to play back audio files	The KR can play back audio files in the following format. • ".WAV" extension • 16bit linear • Sampling rate of "44.1 kHz" • Stereo

Case	Cause/Remedy
Can't record	
Can't record	Has one of the track buttons for recording been selected? (p. 110)
	Has the setting for "Punch-in Recording" (p. 142) or "Tempo Recording" (p. 151) been made? Select the replace recording method (p. 140).
	It is not possible to record while the notation is being generated. Once the unit has finished generating the notation (i.e., when the measure number in the screen is no longer highlighted), try the operation once again.
	You cannot overdub with audio files and audio CDs.
Tempo of recorded song or metronome is off	If you select an internal song in which the tempo changes during the song, and then record, the tempo will change in the same way for the performances that are recorded on the other tracks. The tempo of the metronome will also change in the same way.
	If you record additional material without erasing the previously recorded song, the song will be recorded at the first-recorded tempo. Please erase the previously recorded song before you re-record (p. 111).
The recorded performance has disappeared	Any performance that has been recorded is deleted when the power to the KR is turned off or a song is selected. A performance cannot be restored once it's been deleted. Be sure to save it on an external memory or User Memory before you turn off the power (p. 116).
A screen asking if I want to "OK to delete Song?" suddenly appears.	Is the <Auto Start> set to "On?" (p. 180) If no action is taken for a certain period of time while Auto Start is set to ON, the demo starts playing automatically. If there is any performance you have recorded at that time, a confirmation screen asking you if you want to delete the song appears in the display. If you want to return to the previous screen and continue with the recorded performance, touch <Cancel>. If you touch <OK>, the song is deleted and the demo song begins.

Error Messages

Indication	Meaning
Error 01:	You can only read the music file. It can not be saved.
Error 02:	An error occurred during writing. The storage media's protect tab may be in the "Protect" (writing prohibited) position, or the storage media may not yet be initialized.
Error 10:	No storage media is inserted. Insert the storage media and try again.
Error 11:	There is not sufficient free memory in the save destination. Either insert other storage media or delete unneeded files and try again.
Error 14:	An error occurred during writing. The storage media may be corrupted. Insert other storage media and try again. Alternatively, you can initialize the storage media.
Error 15:	The file is unreadable. The data format is not compatible with the KR.
Error 16:	Data was not called up in time for playback of the song. After waiting several seconds, you may be able to play back the song by pressing the [▶ / ■] button again.
Error 17:	The selected image data cannot be displayed. Prepare image data that can be used with the KR (p. 171).
Error 30:	The internal memory capacity of the KR is full.
Error 40:	The KR cannot deal with the excessive MIDI data sent from the external MIDI device. Reduce the amount of MIDI data sent to the KR.
Error 41:	A MIDI cable has been disconnected. Connect it properly and securely.
Error 43:	A MIDI transmission error has occurred. Check the MIDI cable and connected MIDI device.
Error 51:	There may be a problem with the system. Repeat the procedure from the beginning. If it is not solved after you have tried several times, contact the Roland service center.
Error 60:	Moving Key Error. Repeat the procedure from the beginning. If it is not solved after you have tried several times, contact the Roland service center.
Error 61:	
Error 62:	
Error 63:	
Error 65:	The Ext Memory port was subjected to excessive current. Check the storage media to confirm that no damage has occurred to it.

Tone List

[Piano]

1	Superior Grd
2	NaturalGrand
3	Vintage EP
4	Natural Hps.
5	Vibraphone
6	MagicalPiano
7	EP Belle
8	Mallet Isle
9	FM E.Piano 2
10	'60sE.Piano1
11	Music Bell 3
12	Superior+Str
13	Superior+Pad
14	Superior+Cho
15	Ariel Piano
16	Phase Clav.2
17	FM E.Piano
18	Morning Lite
19	Jazzy Vib+Gt
20	Honky-tonk
21	Rock Piano
22	Stage EP
23	Stage Phazer
24	Vibrations
25	Celesta
26	Marimba
27	Xylophone
28	NaturalC.Hps
29	Clav.
30	Music Box
31	Glockenspiel
32	SuperiorGrd2
33	Natural Gnd2
34	NaturalMello
35	Piano Str2
36	Grand Piano1
37	Grand Piano2
38	MellowPiano1
39	PianoStrings
40	Bright Piano
41	DetunedPiano
42	Honky-tonk 2
43	MellowPiano2
44	Piano Oohs
45	PianoKidsCho
46	Air Grand
47	Ballad Piano
48	UprightPiano
49	Mono Piano
50	FM+SA EP
51	MIDI Piano1
52	EG+E.Piano 1
53	EG+E.Piano 2
54	Bell Piano
55	E. Grand
56	Mild E.Grand
57	Soft E.Piano
58	Phase EP
59	E.Piano 1
60	Pop E.Piano
61	Tremolo EP
62	'60sE.Piano2
63	E.Piano 2
64	EP Phase
65	St.FM EP

66	EP Legend
67	Harpsichord
68	Coupled Hps.
69	Harpsichord2
70	Comp Clav.
71	Reso Clav.
72	Phase Clav.
73	Pulse Clav
74	Celesta 2
75	Soft Marimba
76	Vibe Tr.
77	Marimba Tr.
78	Kalimba
79	Music Box 2
80	Music Bell
81	Music Bell 2
82	Tubular-bell
83	Church Bell
84	Ballad Bells
85	Bell Monitor
86	Timeline
87	Vibra Bells

[Organ]

1	ChurchOrgan1
2	Gospel Spin
3	Rock Organ2
4	German Acco.
5	Blues Harp
6	Full Stops
7	Perc. Organ2
8	Surf's Up!
9	R&B Organ
10	Rocker Spin
11	Combo Jz.Org
12	Ballad Organ
13	L-Organ
14	Jazz Organ1
15	Masked Opera
16	Grand Pipe
17	Theater Org.
18	La Seine
19	ParisRomance
20	Mellow Bars
21	Organ 1
22	Organ 2
23	Lower Organ1
24	Trem. Organ
25	'70s E.Organ
26	'60s Organ
27	Jazz Organ2
28	Jazz Organ3
29	Jazz Organ4
30	Chorus Organ
31	Perc. Organ
32	Rock Organ1
33	Rotary Organ
34	Rotary Org.S
35	Rotary Org.F
36	ChurchOrgan2
37	Pipe Organ
38	Trem.Flute
39	Organ Flute
40	Nason flt 8'
41	Organ Bass
42	Pipe Org. Bs

43	Digi Church
44	VS Organ
45	Metalic Org.
46	CheeseOrgan
47	Accordion Fr
48	AccordionFr2
49	Accordion It
50	Bright Acco.
51	Soft Acco.
52	Bandoneon
53	Harmonica

[Guitar / Bass]

1	EX Nylon Gtr
2	ClearSteelGt
3	Jazz Guitar2
4	Fl.Gtr Roll
5	Mandolin
6	JC Chorus Gt
7	TC Clean ff
8	Overdrive Gt
9	DistortionGt
10	Amore Story
11	EX A.Guitar2
12	EX Steel Gt2
13	Uncle Martin
14	Flamenco Gtr
15	Jazz Guitar
16	Wild Ac.Bs
17	Wood Bass
18	W.Bass+Ride
19	Fingered Bs.
20	Picked Bass
21	Fretless Bs.
22	Nylon Guitar
23	Requint Gtr
24	EX Ac.Guitar
25	EX Steel Gt.
26	Steel-str.Gt
27	12-str.Gt
28	Steel + Body
29	Nylon+Steel
30	EX A.Guitar3
31	Steel Vox
32	Ukulele
33	Hawaiian Gt
34	Clean Gt.
35	JC Clean Gt.
36	Mid Tone GTR
37	TC Rear Pick
38	Acid Guitar
39	Open Hard
40	Feedback Gt.
41	Power Guitar
42	Guitar Pinch
43	Mystic Gtr
44	Funk Gt.
45	Funk Gt.2
46	Muted Gt.
47	Muted Dis.Gt
48	Rock Rhythm
49	Dist Rtm GTR
50	Wah Brush Gt
51	A.Bass+Cymb
52	Acoustic Bs.
53	Rockabilly

54	Finger Slap
55	Mr.Smooth
56	Slap Bass 1
57	Slap Bass 2
58	Synth Bass 1
59	Jungle Bass
60	Hammer
61	SynthBass101
62	ResoSH Bass
63	Acid Bass
64	Clavi Bass
65	Synth Bass 2
66	Beef FM Bass
67	Attack Pulse
68	Rubber Bass
69	Sitar
70	Sitar 2
71	Banjo
72	Shamisen
73	Koto
74	Taisho Koto

[Strings]

1	Full Strings
2	Rich Strings
3	Studio Sect.
4	Dolce Qrt
5	Lunar Strngs
6	R&B SoftPad
7	Wind & Str
8	Aerial Harp
9	Violin
10	Cello
11	Octave Pizz.
12	Silky Way
13	Strings Pad
14	2-way Sect.
15	DolceStrings
16	Velo Strings
17	Harp Strings
18	Mellow Str
19	EX Orchestra
20	Slow Violin
21	PizzicatoStr
22	Strings
23	Oct Strings
24	Strings 2
25	DecayStrings
26	Bright Str
27	Slow Strings
28	SlowStrings2
29	Legato Str
30	Warm Strings
31	Sahara Str
32	Decay Str2
33	Decay Str3
34	Tremolo Str
35	Orchestra
36	Orchestra 2
37	Farewell
38	Choir Str
39	Bell Strings
40	Pearly Harp
41	Harp
42	St. Harp
43	Viola

44	Contrabass
45	Santur
46	Yang Qin
47	Yang Qin 2
48	Er Hu
49	Soft Pad
50	Soft Pad 2
51	Syn.Strings1
52	Syn.Strings2
53	Syn.Slow Str
54	OB Strings
55	JP Saw Str
56	Timpani
57	Warm JP Str
58	OrchestraHit
59	Good Old Hit
60	Euro Hit
61	6th Hit
62	Bass Hit
63	Philly Hit
64	Philly Hit 2
65	Mix Hit 1
66	Mix Hit 2

[Sax/Brass]

1	BlowAltoVib
2	Mariachi Tp.
3	Romantic Tp.
4	PowerBrass 2
5	Flute
6	ChamberWinds
7	Wood Symphny
8	Sax Section
9	Rom&Mar Tp.
10	Mar Tp&Shake
11	Flute+Clari.
12	Multi-Winds
13	Brass Sect 2
14	EX Tp&Shake
15	Super Tenor
16	AltoSax Soft
17	Soprano Sax
18	Clarinet
19	Oboe
20	EX Trumpet
21	Flugel Horn
22	Pan Flute
23	Qu Di
24	SuperF.Horns
25	Angel Pipes
26	Trumpet
27	Tp Shake
28	Bright Tp.
29	Warm Tp.
30	Dark Trumpet
31	Romantic Tp2
32	Trombone
33	Trombone 2
34	Twin bones
35	Bones Sect.
36	Bright Tb.
37	Tuba
38	MutedTrumpet
39	MuteTrumpet2
40	MuteTrumpet3
41	French Horns

42	French Horn2
43	OrchestraBrs
44	Brass 1
45	Brass 2
46	BrassSection
47	PowerBrass
48	Pop Orch
49	Contemp'Orch
50	Brass sfz
51	Brass Fall
52	Trumpet Fall
53	EX Alto Sax
54	AltoSax + Tp
55	Alto Sax
56	Grow Sax
57	BreathyTenor
58	Tenor Sax
59	Tenor Sax 2
60	Tenor Sax f
61	Tenor Sax B
62	Baritone Sax
63	English Horn
64	Bassoon
65	Piccolo
66	Flute 2
67	Recorder
68	Bottle Blow
69	Shakuhachi
70	Whistle
71	Ocarina
72	Bagpipe
73	Lochscape
74	Andes Mood
75	HimalayaPipe
76	Wide SynBrss
77	DeepSynBrass
78	Jump Brass
79	Saw Brass1
80	Saw Brass2
81	Synth Brass1
82	Synth Brass2
83	DetuneSawBrs
84	Pro Brass
85	SynBrass sfz

[Voice]

1	Aerial Choir
2	Jazz Scat
3	Gregorian
4	Dreaming Box
5	Glass Pad
6	Rich Choir
7	Gospel Oohs
8	Female Aahs
9	F.Chorus Luh
10	Jazz Doos
11	Kid's Choir
12	Angels Choir
13	Boys Choir
14	Opera Voice
15	Mellow Choir
16	Holy Voices
17	Morning Star
18	Mystic Str
19	Trancy X

20	HPF Slicer
21	Side Band X
22	Glasswaves
23	Church Choir
24	Voice Oohs
25	Voice Oohs 2
26	Choir Hahs
27	Decay Choir
28	DcyGregorian
29	Doos Voice
30	Doot Accent
31	Dat Accent
32	Bap Accent
33	Thum Voice
34	Humming
35	SynVox
36	Analog Voice
37	InfinitePhsr
38	X Super Saws
39	Fat Stacks
40	Frgile Saws
41	SuperSawSlow
42	Electrostars
43	Bending Logo
44	2600 Sine
45	Square Wave
46	Mg Square
47	JP8 Square
48	LM Square
49	Syn.Square
50	CC Solo
51	Sleeper
52	Dual Sqr&Saw
53	Jupiter Lead
54	Sinetic
55	FM Lead 1
56	FM Lead 2
57	Saw Wave
58	Saw
59	Doctor Solo
60	Mg Lead
61	P5 Saw Lead
62	JP SuperSaw
63	Rhythmic Saw
64	Natural Lead
65	SequencedSaw
66	Waspy Synth
67	Velo SawLead
68	Attack Lead
69	DelyResoSaws
70	Wezcoast
71	Syn.Calliope
72	JP8 Pulse
73	LM PureLead
74	Orgaenia
75	Chiffer Lead
76	Cheese Saw
77	JP OctAttack
78	Charang
79	Reso Saw
80	Wire Lead
81	2600 SubOsc
82	Solo Vox
83	RAVE Vox
84	5th Saw Wave
85	Freeze Synth
86	Bass & Lead

87	Fat & Perky
88	Delayed Lead
89	Fantasia
90	Fantasia 2
91	New Age Pad
92	New Age Pad2
93	Sugar Key
94	FreezinNight
95	New Year Day
96	Warm Pad
97	Sine Pad
98	Nu Epic Pad
99	Hollow Pad
100	Decay Pad
101	Decay Pad2
102	DecayDoosPad
103	Polysynth
104	P5 Poly
105	Poly King
106	Octave Stack
107	Hoovercraft
108	DOC Stack
109	Bustranza
110	Space Voice
111	Heaven II
112	Warm SquPad
113	Voyager
114	Film Cue
115	HumanKindnes
116	Bowed Glass
117	Metal Pad
118	Orbiting
119	Visionary
120	Halo Pad
121	JP8 Sqr Pad
122	Vox Sweep
123	Consolament
124	JP-8 Phase
125	Sweep Pad
126	Sweep Pad 2
127	Ice Rain
128	Clavi Pad
129	Toy Box
130	Soundtrack
131	Crystal
132	Syn Mallet
133	ChristmasBel
134	Clear Bells
135	Himalaya Ice
136	Glittery Pad
137	Atmosphere
138	Harpvox
139	Nylon Harp
140	Nylon + EP
141	HollowReleas
142	Tubulence
143	Landing Pad
144	Shangri-La
145	Motion Pad
146	Brightness
147	Org Bells
148	Goblin
149	Saturn Siren
150	RandomEnding
151	Echo Drops
152	Echo Bell
153	Echo Pan

Tone List

154	Echo Pan 2
155	Big Panner
156	Ai-yai-a
157	Saturn Rings
158	Star Theme
159	Rising Osc
160	Galaxy Way
161	12th Planet
162	PolySweep Nz
163	En-co-re
164	Piano 1
165	Piano 1w
166	Piano 1d
167	Piano 2
168	Piano 2w
169	Piano 3
170	Piano 3w
171	Honky-tonk
172	Honky-tonk 2
173	E.Piano 1
174	E.Piano 2
175	'60s E.Piano
176	E.Piano 1v
177	E.Piano 2v
178	Detuned EP 1
179	Detuned EP 2
180	Harpsichord
181	Coupled Hps.
182	Harpsi.w
183	Harpsi.o
184	Clav.
185	Celesta
186	Glockenspiel
187	Music Box
188	Vibraphone
189	Vibe.w
190	Marimba
191	Marimba w
192	Xylophone
193	Tubular-bell
194	Church Bell
195	Carillon
196	Santur
197	Organ 1
198	Organ 2
199	Pop Organ 1
200	Detuned Or.1
201	Detuned Or.2
202	Church Org.1
203	Church Org.2
204	Church Org.3
205	Full Organ
206	Jazz Organ1
207	Rock Organ
208	Reed Organ
209	Accordion Fr
210	Accordion It
211	Harmonica
212	Bandoneon
213	Nylon-str.Gt
214	Nylon Gt.2
215	Nylon Gt.o
216	Ukulele
217	Steel-str.Gt
218	12-str.Gt
219	Mandolin
220	Jazz Guitar

221	Hawaiian Gt
222	Clean Gt.
223	Chorus Gt.
224	Muted Gt.
225	Funk Gt.
226	Funk Gt.2
227	Overdrive Gt
228	DistortionGt
229	Feedback Gt.
230	Gt.Harmonics
231	Gt. Feedback
232	Acoustic Bs.
233	Fingered Bs.
234	Picked Bs.
235	Fretless Bs.
236	Slap Bass 1
237	Slap Bass 2
238	SynthBass101
239	Synth Bass 1
240	Synth Bass 2
241	Synth Bass 3
242	Synth Bass 4
243	Rubber Bass
244	Violin
245	Slow Violin
246	Viola
247	Cello
248	Contrabass
249	Tremolo Str
250	PizzicatoStr
251	Harp
252	Timpani
253	Strings
254	Orchestra
255	Slow Strings
256	Syn.Strings1
257	Syn.Strings2
258	Syn.Strings3
259	Choir Aahs
260	Choir
261	Pop Voice
262	SynVox
263	OrchestraHit
264	Trumpet
265	Trombone
266	Trombone 2
267	Tuba
268	MutedTrumpet
269	French Horns
270	French Horn2
271	Brass 1
272	Brass 2
273	Synth Brass1
274	Synth Brass2
275	Synth Brass3
276	Synth Brass4
277	AnalogBrass1
278	AnalogBrass2
279	Soprano Sax
280	Alto Sax
281	Tenor Sax
282	Baritone Sax
283	Oboe
284	English Horn
285	Bassoon
286	Clarinet
287	Piccolo

288	Flute
289	Recorder
290	Pan Flute
291	Bottle Blow
292	Shakuhachi
293	Whistle
294	Ocarina
295	Square Wave
296	Square
297	Sine Wave
298	Saw Wave
299	Saw
300	Doctor Solo
301	Syn.Calliope
302	Chiffer Lead
303	Charang
304	Solo Vox
305	5th Saw Wave
306	Bass & Lead
307	Fantasia
308	Warm Pad
309	Polysynth
310	Space Voice
311	Bowed Glass
312	Metal Pad
313	Halo Pad
314	Sweep Pad
315	Ice Rain
316	Soundtrack
317	Crystal
318	Syn Mallet
319	Atmosphere
320	Brightness
321	Goblin
322	Echo Drops
323	Echo Bell
324	Echo Pan
325	Star Theme
326	Sitar
327	Sitar 2
328	Banjo
329	Shamisen
330	Koto
331	Taisho Koto
332	Kalimba
333	Bagpipe
334	Fiddle
335	Shanai
336	Tinkle Bell
337	Agogo
338	Steel Drums
339	Woodblock
340	Castanets
341	Taiko
342	Concert BD
343	Melo. Tom 1
344	Melo. Tom 2
345	Synth Drum
346	808 Tom
347	Elec Perc.
348	Reverse Cym.
349	Gt.FretNoise
350	Gt.Cut Noise
351	String Slap
352	Breath Noise
353	Fl.Key Click
354	Seashore

355	Rain
356	Thunder
357	Wind
358	Stream
359	Bubble
360	Bird
361	Dog
362	Horse-Gallop
363	Bird 2
364	Telephone 1
365	Telephone 2
366	DoorCreaking
367	Door
368	Scratch
369	Windchime
370	Helicopter
371	Car-Engine
372	Car-Stop
373	Car-Pass
374	Car-Crash
375	Siren
376	Train
377	Jetplane
378	Starship
379	Burst Noise
380	Applause
381	Laughing
382	Screaming
383	Punch
384	Heart Beat
385	Footsteps
386	Gun Shot
387	Machine Gun
388	Lasergun
389	Explosion

Drum Set List

* -----: No sound.

* [EXC]: will not sound simultaneously with other percussion instruments of the same number.

	POP	ROCK	JAZZBRUSH	HIP HOP	VOX DRUM
21	R&B Snare	R&B Snare	R&B Snare	Jungle BD 2	R&B Snare
22	Rock Snare m 1	Pop Snare m 2	Pop Snare m 1	Metronome E.Click	Rock Snare m 1
23	Rock Snare m 2	Pop Snare m 1	Pop Snare m 2	Metronome Pi	Rock Snare m 2
24	Pop Snare m 1	Pop Snare m 1	Pop Snare m 1	Concert SD	Pop Snare m 1
25	Pop Snare Ghost	Pop Snare Ghost	Pop Snare Ghost	Snare Roll	Pop Snare Ghost
26	Pop Snare m 1	Pop Snare m 2	Pop Snare m 1	Finger Snap	Pop Snare m 1
27	Finger Snap	Finger Snap 2	Finger Snap 2	High Q	Finger Snap
28	TR-707 Claps	TR-707 Claps	TR-707 Claps	Slap	TR-707 Claps
29	Hand Clap [EXC7]	Hand Clap [EXC7]	Hand Clap [EXC7]	Scratch Push [EXC7]	Hand Clap [EXC7]
30	Hand Clap 2 [EXC7]	Hand Clap 2 [EXC7]	Hand Clap 2 [EXC7]	Scratch Pull [EXC7]	Hand Clap 2 [EXC7]
31	Hand Clap	Hand Clap	Hand Clap	Sticks	Hand Clap
32	Pop Pedal HH [EXC1]	Pop Pedal HH [EXC1]	Pop Pedal HH [EXC1]	Square Click	Pop Pedal HH
33	Gospel Hand Clap	Gospel Hand Clap	Gospel Hand Clap	Metronome Click	Gospel Hand Clap
34	Snare Roll	Snare Roll	Snare Roll	Metronome Bell	Vox Dut
35	Pop Kick 2	Rock Kick 2	Jazz Kick 2	Jungle BD 2	Vox Dum
C2 36	Pop Kick 1	Rock Kick 1	Rock Kick 1	HipHop BD1	Vox Tuush
37	Pop Side Stick	Rock Side Stick	Jazz Snare Swing 1	TR-808 Rimshot	Vox Hehho
38	Pop Snare s 1	Rock Snare s 1	Jazz Snare 1	Power Snare 1A	Vox Doyear
39	Pop Snare Ghost	Pop Snare Ghost	Jazz Snare Swing 2	TR-707 Clap	Vox Thu!
40	Pop Snare s 2	Rock Snare s 2	Jazz Snare 2	Power Snare 2A	Vox That
41	Pop Low Tom f	Rock Low Tom f	Jazz Low Tom f	Low Tom 2	Vox Aahhh
42	Pop CHH 1 [EXC1]	Rock CHH 1 [EXC1]	Pop CHH 1 [EXC1]	Pop CHH 1 [EXC1]	Vox Tu
43	Pop Low Tom	Rock Low Tom	Jazz Low Tom	Low Tom 1	Vox DooH
44	Pop CHH 2 [EXC1]	Rock CHH 2 [EXC1]	Pop CHH 2 [EXC1]	Pedal Hi-hat 3 [EXC1]	Vox Ptu
45	Pop Mid Tom f	Rock Mid Tom f	Jazz Mid Tom f	Mid Tom 2	Vox Down
46	Pop OHH [EXC1]	Rock OHH [EXC1]	Pop OHH [EXC1]	Pop OHH [EXC1]	Vox Pa
47	Pop Mid Tom	Rock Mid Tom	Jazz Mid Tom	Mid Tom 1	Vox Bom
C3 48	Pop High Tom f	Rock High Tom f	Jazz High Tom f	High Tom 2	Vox Toear
49	Pop Crash Cymbal 1	Rock Crash Cymbal	Jazz Crash Cymbal 1	Crash Cymbal 3	Vox Aahhu
50	Pop High Tom	Rock High Tom	Jazz High Tom	High Tom 1	Vox Toya
51	Pop Ride Cymbal 1	Rock Ride Cymbal 1	Jazz Ride Cymbal 1	Ride Cymbal 1	Vox Thu
52	Pop Chinees Cymbal	Pop Chinees Cymbal	Jazz Chinees Cymbal	Reverse Cymbal	Vox Cheey
53	Pop Ride Bell	Pop Ride Bell	Jazz Ride Cymbal 2	Ride Bell	Vox Cymm
54	Tambourine 2	Tambourine 2	Tambourine 2	Shake Tambourine	Vox Tub
55	Splash Cymbal	Splash Cymbal	Splash Cymbal	Splash Cymbal	Vox Pruru
56	Cha Cha CowBell	Cha Cha CowBell	Cha Cha CowBell	TR-808 Cowbell	Vox Tut
57	Pop Crash Cymbal 2	Chinees Cymbal	Jazz Crash Cymbal 2	Crash Cymbal 2	Vox Tyun
58	Vibra-slap	Vibra-slap	Vibra-slap	Vibra-slap	Vox Tdum
59	Pop Ride Cymbal 2	Pop Ride Cymbal 3	Jazz Ride Cymbal 3	Ride Cymbal 2	Vox Afahhhh
C4 60	High Bongo 1	High Bongo 1	High Bongo 1	High Bongo 2	High Bongo 1
61	Low Bongo 1	Low Bongo 1	Low Bongo 1	Low Bongo 2	Low Bongo 1
62	Mute High Conga 1	Mute High Conga 1	Mute High Conga 1	Mute High Conga 2	Mute High Conga 1
63	Open High Conga 1	Open High Conga 1	Open High Conga 1	Open High Conga 2	Open High Conga 1
64	Low Conga 1	Low Conga 1	Low Conga 1	Low Conga 2	Low Conga 1
65	High Timbale	High Timbale	High Timbale	High Timbale	High Timbale
66	Low Timbale	Low Timbale	Low Timbale	Low Timbale	Low Timbale
67	High Agogo	High Agogo	High Agogo	High Agogo	High Agogo
68	Low Agogo	Low Agogo	Low Agogo	Low Agogo	Low Agogo
69	Shaker 3	Shaker 3	Shaker 3	Cabasa	Shaker 3
70	Shaker 4	Shaker 4	Shaker 4	Maracas	Shaker 4
71	Short Hi Whistle [EXC2]	Short Hi Whistle [EXC2]	Short Hi Whistle [EXC2]	Short Hi Whistle [EXC2]	Short Hi Whistle [EXC2]
C5 72	Long Low Whistle [EXC2]	Long Low Whistle [EXC2]	Long Low Whistle [EXC2]	Long Low Whistle [EXC2]	Long Low Whistle [EXC2]
73	Short Guiro [EXC3]	Short Guiro [EXC3]	Short Guiro [EXC3]	Short Guiro [EXC3]	Short Guiro [EXC3]
74	Long Guiro [EXC3]	Long Guiro [EXC3]	Long Guiro [EXC3]	HipVibraslap [EXC3]	Long Guiro [EXC3]
75	Claves	Claves	Claves	TR-808 Claves	Claves
76	High Wood Block	High Wood Block	High Wood Block	High Wood Block	High Wood Block
77	Low Wood Block	Low Wood Block	Low Wood Block	Low Wood Block	Low Wood Block
78	Mute Cuica [EXC4]	Mute Cuica [EXC4]	Mute Cuica [EXC4]	High Hoo [EXC4]	Mute Cuica [EXC4]
79	Open Cuica [EXC4]	Open Cuica [EXC4]	Open Cuica [EXC4]	Low Hoo [EXC4]	Open Cuica [EXC4]
80	Mute Triangle1 [EXC5]	Mute Triangle1 [EXC5]	Mute Triangle1 [EXC5]	Mute Triangle2 [EXC5]	Mute Triangle1 [EXC5]
81	Open Triangle 1 [EXC5]	Open Triangle 1 [EXC5]	Open Triangle 1 [EXC5]	Open Triangle 2 [EXC5]	Open Triangle 1 [EXC5]
82	Shaker	Shaker	Shaker	Shaker	Shaker
83	Jingle Bell	Jingle Bell	Jingle Bell	Jingle Bell	Jingle Bell
C6 84	Bell Tree	Bell Tree	Bell Tree	Bell Tree	Bell Tree
85	Castanets	Castanets	Castanets	Castanets	Castanets
86	Mute Surdo [EXC6]	Mute Surdo [EXC6]	Mute Surdo [EXC6]	Mute Surdo [EXC6]	Mute Surdo [EXC6]
87	Open Surdo [EXC6]	Open Surdo [EXC6]	Open Surdo [EXC6]	Open Surdo [EXC6]	Open Surdo [EXC6]
88	Cana	Cana	Cana	Applause 2	Cana
89	Hi-Timbale Flam	Hi-Timbale Flam	Hi-Timbale Flam	HipHop SD 2	Hi-Timbale Flam
90	Lo-Timbale Flam	Lo-Timbale Flam	Lo-Timbale Flam	LoFi SD Rim	Lo-Timbale Flam
91	Timbale Phrase	Timbale Phrase	Timbale Phrase	TR-808 Clap	Timbale Phrase
92	Shekere 1	Shekere 1	Shekere 1	Room Snare 1	Shekere 1
93	Shekere 2	Shekere 2	Shekere 2	Standard 1 Snare 2A	Shekere 2
94	Low Bongo Mute	Low Bongo Mute	Low Bongo Mute	Room Snare 2	Low Bongo Mute
95	High Bongo Mute	High Bongo Mute	High Bongo Mute	Standard 1 Snare 1	High Bongo Mute
C7 96	----	----	----	Standard 1 Snare 2B	----
97	----	----	----	----	----
98	----	----	----	----	----
99	----	----	----	----	----
100	Flamenco Hand Clap	Flamenco Hand Clap	Flamenco Hand Clap	----	Flamenco Hand Clap
101	Flamenco Hand Clap	Flamenco Hand Clap	Flamenco Hand Clap	----	Flamenco Hand Clap
102	Bongo CowBell	Bongo CowBell	Bongo CowBell	----	Bongo CowBell
103	----	----	----	Tape Rewind	----
104	Bongo CowBell	Bongo CowBell	Bongo CowBell	Phono Noise	Bongo CowBell
105	----	----	----	Room Snare 1	----
106	----	----	----	Room Snare 2A	----
107	----	----	----	Elec Snare 4A	----
C8 108	----	----	----	Elec Snare 4B	----

Drum Set List

* ----: No sound.

* [EXC]: will not sound simultaneously with other percussion instruments of the same number.

	STD CHINA	STANDARD 1	STANDARD 2	STANDARD 3	ROOM
21	----	----	----	----	----
22	----	----	----	----	----
23	----	----	----	----	----
24	Bar Chime	Bar Chime	Bar Chime	Bar Chime	Bar Chime
25	Snare Roll	Snare Roll	Snare Roll	Snare Roll	Snare Roll
26	Finger Snap	Finger Snap	Finger Snap	Finger Snap	Finger Snap
27	High Q	High Q	High Q	High Q	High Q
28	Slap	Slap	Slap	Slap	Slap
29	Scratch Push [EXC7]	Scratch Push [EXC7]	Scratch Push [EXC7]	Scratch Push [EXC7]	Scratch Push [EXC7]
30	Scratch Pull [EXC7]	Scratch Pull [EXC7]	Scratch Pull [EXC7]	Scratch Pull [EXC7]	Scratch Pull [EXC7]
31	Sticks	Sticks	Sticks	Sticks	Sticks
32	Square Click	Square Click	Square Click	Square Click	Square Click
33	Metronome Click	Metronome Click	Metronome Click	Metronome Click	Metronome Click
34	Metronome Bell	Metronome Bell	Metronome Bell	Metronome Bell	Metronome Bell
35	Standard 1 Kick 1	Standard 1 Kick 1	Standard 2 Kick 2	Standard 3 Kick 2	Room Kick 2
C2 36	Standard 1 Kick 2	Standard 1 Kick 2	Standard 2 Kick 1	Standard 3 Kick 1	Room Kick 1
37	Side Stick 1	Side Stick 1	Side Stick 2	Side Stick 2	Side Stick 2
38	Standard 1 Snare 1	Standard 1 Snare 1	Standard 2 Snare 1	Standard 3 Snare 1	Room Snare 1
39	TR-909 Clap	TR-909 Clap	TR-808 Clap	TR-808 Clap	TR-808 Clap
40	Standard 1 Snare 2	Standard 1 Snare 2	Standard 2 Snare 2	Standard 3 Snare 2	Room Snare 2
41	Low Tom 2	Low Tom 2	Low Tom 2	Low Tom 2	Room Low Tom 2
42	Close Hi-hat1 [EXC1]	Close Hi-hat1 [EXC1]	Closed Hi-hat 2 [EXC1]	Closed Hi-hat 3 [EXC1]	Closed Hi-hat 4 [EXC1]
43	Low Tom 1	Low Tom 1	Low Tom 1	Low Tom 1	Room Low Tom 1
44	Pedal Hi-hat 1 [EXC1]	Pedal Hi-hat 1 [EXC1]	Pedal Hi-hat 2 [EXC1]	Pedal Hi-hat 2 [EXC1]	Pedal Hi-hat 2 [EXC1]
45	Mid Tom 2	Mid Tom 2	Mid Tom 2	Mid Tom 2	Room Mid Tom 2
46	Open Hi-hat 1 [EXC1]	Open Hi-hat 1 [EXC1]	Open Hi-hat 2 [EXC1]	Open Hi-hat 3 [EXC1]	Open Hi-hat 4 [EXC1]
47	Mid Tom 1	Mid Tom 1	Mid Tom 1	Mid Tom 1	Room Mid Tom 1
C3 48	High Tom 2	High Tom 2	High Tom 2	High Tom 2	Room High Tom 2
49	Crash Cymbal 1	Crash Cymbal 1	Crash Cymbal 1	Crash Cymbal 1	Crash Cymbal 1
50	High Tom 1	High Tom 1	High Tom 1	High Tom 1	Room High Tom 1
51	Ride Cymbal 1	Ride Cymbal 1	Ride Cymbal 1	Ride Cymbal 1	Ride Cymbal 1
52	Chinese Cymbal	Chinese Cymbal	Chinese Cymbal	Chinese Cymbal	Chinese Cymbal
53	Ride Bell	Ride Bell	Ride Bell	Ride Bell	Ride Bell
54	Tambourine	Tambourine	Tambourine	Tambourine	Tambourine
55	Splash Cymbal	Splash Cymbal	Splash Cymbal	Splash Cymbal	Splash Cymbal
56	Cowbell	Cowbell	Cowbell	Cowbell	Cowbell
57	Crash Cymbal 2	Crash Cymbal 2	Crash Cymbal 2	Crash Cymbal 2	Crash Cymbal 2
58	Vibra-slap	Vibra-slap	Vibra-slap	Vibra-slap	Vibra-slap
59	Ride Cymbal 2	Ride Cymbal 2	Ride Cymbal 2	Ride Cymbal 2	Ride Cymbal 2
C4 60	----	High Bongo 1	High Bongo 1	High Bongo 1	High Bongo 1
61	----	Low Bongo 1	Low Bongo 1	Low Bongo 1	Low Bongo 1
62	----	Mute High Conga 1	Mute High Conga 1	Mute High Conga 1	Mute High Conga 1
63	Cana	Open High Conga 1	Open High Conga 1	Open High Conga 1	Open High Conga 1
64	Ban Gu 1	Low Conga 1	Low Conga 1	Low Conga 1	Low Conga 1
65	Taiko 1	High Timbale	High Timbale	High Timbale	High Timbale
66	Nao Bo [EXC8]	Low Timbale	Low Timbale	Low Timbale	Low Timbale
67	Taiko 2	High Agogo	High Agogo	High Agogo	High Agogo
68	Xiao Bo 1 [EXC8]	Low Agogo	Low Agogo	Low Agogo	Low Agogo
69	Taiko 3	Cabasa	Cabasa	Cabasa	Cabasa
70	Open High HuYinLuo 2 [EXC8]	Maracas	Maracas	Maracas	Maracas
71	Taiko 4	Short Hi Whistle [EXC2]	Short Hi Whistle [EXC2]	Short Hi Whistle [EXC2]	Short Hi Whistle [EXC2]
C5 72	Taiko 5	Long Low Whistle [EXC2]	Long Low Whistle [EXC2]	Long Low Whistle [EXC2]	Long Low Whistle [EXC2]
73	Open High HuYinLuo 1	Short Guiro [EXC3]	Short Guiro [EXC3]	Short Guiro [EXC3]	Short Guiro [EXC3]
74	Taiko 6	Long Guiro [EXC3]	Long Guiro [EXC3]	Long Guiro [EXC3]	Long Guiro [EXC3]
75	Shou Luo 1	Claves	Claves	Claves	Claves
76	Mute Low HuYinLuo 2	High Wood Block	High Wood Block	High Wood Block	High Wood Block
77	Shou Luo 2	Low Wood Block	Low Wood Block	Low Wood Block	Low Wood Block
78	Xiao Bo 2	Mute Cuica [EXC4]	Mute Cuica [EXC4]	Mute Cuica [EXC4]	Mute Cuica [EXC4]
79	Ban Gu 2	Open Cuica [EXC4]	Open Cuica [EXC4]	Open Cuica [EXC4]	Open Cuica [EXC4]
80	Xiao Bo 3	Mute Triangle1 [EXC5]	Mute Triangle1 [EXC5]	Mute Triangle1 [EXC5]	Mute Triangle1 [EXC5]
81	Open High HuYinLuo 3	Open Triangle 1 [EXC5]	Open Triangle 1 [EXC5]	Open Triangle 1 [EXC5]	Open Triangle 1 [EXC5]
82	Mute High HuYinLuo	Shaker	Shaker	Shaker	Shaker
83	Mute Low HuYinLuo 1	Jingle Bell	Jingle Bell	Jingle Bell	Jingle Bell
C6 84	----	Bell Tree	Bell Tree	Bar Chime	Bell Tree
85	----	Castanets	Castanets	Castanets	Castanets
86	----	Mute Surdo [EXC6]	Mute Surdo [EXC6]	Mute Surdo [EXC6]	Mute Surdo [EXC6]
87	----	Open Surdo [EXC6]	Open Surdo [EXC6]	Open Surdo [EXC6]	Open Surdo [EXC6]
88	----	----	----	----	----
89	----	----	----	----	----
90	----	----	----	----	----
91	----	----	----	----	----
92	----	----	----	----	----
93	----	----	----	----	----
94	----	----	----	----	----
95	----	----	----	----	----
C7 96	----	----	----	----	----
97	Open Sagat	----	----	----	----
98	Close Sagat	----	----	----	----
99	Ban Gu 1	----	----	----	----
100	Ban Gu 3	----	----	----	----
101	----	----	----	----	----

Drum Set List

* ----: No sound.

* [EXC]: will not sound simultaneously with other percussion instruments of the same number.

	POWER	ELECTRONIC	TR-808/909	DANCE
21	----	----	----	----
22	----	----	----	----
23	----	----	----	----
24	Bar Chime	Bar Chime	Bar Chime	Bar Chime
25	Snare Roll	Snare Roll	Snare Roll	Snare Roll
26	Finger Snap	Finger Snap	Finger Snap	Finger Snap
27	High Q	High Q	High Q	High Q
28	Slap	Slap	Slap	Slap
29	Scratch Push [EXC7]	Scratch Push 2 [EXC7]	Scratch Push 2 [EXC7]	Scratch Push 2 [EXC7]
30	Scratch Pull [EXC7]	Scratch Pull 2 [EXC7]	Scratch Pull 2 [EXC7]	Scratch Pull 2 [EXC7]
31	Sticks	Sticks	Sticks	Sticks
32	Square Click	Square Click	Square Click	Square Click
33	Metronome Click	Metronome Click	Metronome Click	Metronome Click
34	Metronome Bell	Metronome Bell	Metronome Bell	Metronome Bell
35	Power Kick2	Elec Kick 2	TR-909 Kick	TR-808 Kick 2
C2 36	Power Kick1	Elec Kick 1	TR-808 Kick	HipHop BD1
37	Side Stick 2	Side Stick 2	TR-808 Rimshot	Side Stick 2
38	Dance Snare1	Elec Snare 1	TR-808 Snare 1	Power Snare 2
39	TR-808 Clap	TR-808 Clap	TR-808 Clap	TR-808 Clap
40	Power Snare 1	Elec Snare 2	TR-909 Snare 1	Elec Snare 3
41	Power Low Tom 2	Elec Low Tom 2	TR-808 Low Tom 2	Elec Low Tom 2
42	Closed Hi-hat 4 [EXC1]	Closed Hi-hat 3 [EXC1]	TR-808 CHH [EXC1]	CR-78 CHH [EXC1]
43	Power Low Tom 1	Elec Low Tom 1	TR-808 Low Tom 1	Elec Low Tom 1
44	Pedal Hi-hat 2 [EXC1]	Pedal Hi-hat 2 [EXC1]	TR-808 CHH [EXC1]	TR-808 CHH [EXC1]
45	Power Mid Tom 2	Elec Mid Tom 2	TR-808 Mid Tom 2	Elec Mid Tom 2
46	Open Hi-hat 4 [EXC1]	Open Hi-hat 3 [EXC1]	TR-808 OHH [EXC1]	CR-78 OHH [EXC1]
47	Power Mid Tom 1	Elec Mid Tom 1	TR-808 Mid Tom 1	Elec Mid Tom 1
C3 48	Power High Tom 2	Elec High Tom 2	TR-808 High Tom 2	Elec High Tom 2
49	Crash Cymbal 1	Crash Cymbal 1	TR-808 Cymbal	Crash Cymbal 1
50	Power High Tom 1	Elec High Tom 1	TR-808 High Tom 1	Elec High Tom 1
51	Ride Cymbal 1	Ride Cymbal 1	Ride Cymbal 1	Ride Cymbal 1
52	Chinese Cymbal	Reverse Cymbal	Chinese Cymbal	Reverse Cymbal
	Ride Bell	Ride Bell	Ride Bell	Ride Bell
53	Tambourine	Tambourine	Tambourine	Tambourine
55	Splash Cymbal	Splash Cymbal	Splash Cymbal	Splash Cymbal
56	Cowbell	Cowbell	TR-808 Cowbell	TR-808 Cowbell
57	Crash Cymbal 2	Crash Cymbal 2	Crash Cymbal 2	Crash Cymbal 2
58	Vibra-slap	Vibra-slap	Vibra-slap	Vibra-slap
59	Ride Cymbal 2	Ride Cymbal 2	Ride Cymbal 2	Ride Cymbal 2
C4 60	High Bongo 1	High Bongo 1	High Bongo 1	High Bongo 1
	Low Bongo 1	Low Bongo 1	Low Bongo 1	Low Bongo 1
62	Mute High Conga 1	Mute High Conga 1	TR-808 High Conga	Mute High Conga 1
63	Open High Conga 1	Open High Conga 1	TR-808 Mid Conga	Open High Conga 1
64	Low Conga 1	Low Conga 1	TR-808 Low Conga	Low Conga 1
65	High Timbale	High Timbale	High Timbale	High Timbale
66	Low Timbale	Low Timbale	Low Timbale	Low Timbale
67	High Agogo	High Agogo	High Agogo	High Agogo
68	Low Agogo	Low Agogo	Low Agogo	Low Agogo
69	Cabasa	Cabasa	Cabasa	Cabasa
70	Maracas	Maracas	TR-808 Maracas	TR-808 Maracas
71	Short Hi Whistle [EXC2]	Short Hi Whistle [EXC2]	Short Hi Whistle [EXC2]	Short Hi Whistle [EXC2]
C5 72	Long Low Whistle [EXC2]	Long Low Whistle [EXC2]	Long Low Whistle [EXC2]	Long Low Whistle [EXC2]
73	Short Guiro [EXC3]	Short Guiro [EXC3]	Short Guiro [EXC3]	Short Guiro [EXC3]
74	Long Guiro [EXC3]	Long Guiro [EXC3]	Long Guiro [EXC3]	Long Guiro [EXC3]
75	Claves	Claves	TR-808 Claves	TR-808 Claves
76	High Wood Block	High Wood Block	High Wood Block	High Wood Block
	Low Wood Block	Low Wood Block	Low Wood Block	Low Wood Block
77	Mute Cuica [EXC4]	Mute Cuica [EXC4]	Mute Cuica [EXC4]	High Hoo [EXC4]
79	Open Cuica [EXC4]	Open Cuica [EXC4]	Open Cuica [EXC4]	Low Hoo [EXC4]
80	Mute Triangle1 [EXC5]	Mute Triangle1 [EXC5]	Mute Triangle1 [EXC5]	Mute Triangle1 [EXC5]
81	Open Triangle 1 [EXC5]	Open Triangle 1 [EXC5]	Open Triangle 1 [EXC5]	Open Triangle 1 [EXC5]
82	Shaker	Shaker	Shaker	Shaker
83	Jingle Bell	Jingle Bell	Jingle Bell	Jingle Bell
C6 84	Bell Tree	Bell Tree	Bell Tree	Bell Tree
	Castanets	Castanets	Castanets	Castanets
86	Mute Surdo [EXC6]	Mute Surdo [EXC6]	Mute Surdo [EXC6]	Mute Surdo [EXC6]
87	Open Surdo [EXC6]	Open Surdo [EXC6]	Open Surdo [EXC6]	Open Surdo [EXC6]
88	----	----	----	----

Drum Set List

* -----: No sound.

* [EXC]: will not sound simultaneously with other percussion instruments of the same number.

	JAZZ	BRUSH	ORCHESTRA	SFX Set
21	-----	-----	-----	-----
22	-----	-----	-----	-----
23	-----	-----	-----	-----
24	Bar Chime	Bar Chime	Bar Chime	-----
25	Snare Roll	Snare Roll	Snare Roll	-----
26	Finger Snap	Finger Snap	Finger Snap	-----
27	High Q	High Q	Closed Hi-hat 3 [EXC1]	-----
28	Slap	Slap	Pedal Hi-hat 2 [EXC1]	-----
29	Scratch Push [EXC7]	Scratch Push [EXC7]	Open Hi-hat 3 [EXC1]	-----
30	Scratch Pull [EXC7]	Scratch Pull [EXC7]	Ride Cymbal 1	-----
31	Sticks	Sticks	Sticks	-----
32	Square Click	Square Click	Square Click	-----
33	Metronome Click	Metronome Click	Metronome Click	-----
34	Metronome Bell	Metronome Bell	Metronome Bell	-----
35	Jazz Kick 2	Jazz Kick 2	Jazz Kick 1	-----
C2 36	Jazz Kick 1	Jazz Kick 1	Concert BD	-----
37	Side Stick 2	Side Stick 2	Side Stick 2	-----
38	Jazz Snare 1	Brush Tap	Concert SD	-----
39	Hand Clap 3	Brush Slap	Castanets	High Q
40	Standard 2 Snare 2	Brush Swirl	Concert SD	Slap
41	Low Tom 2	Brush Low Tom 2	Timpani F	Scratch Push [EXC7]
42	Closed Hi-hat 3 [EXC1]	Brush Closed Hi-hat [EXC1]	Timpani F#	Scratch Pull [EXC7]
43	Low Tom 1	Brush Low Tom 1	Timpani G	Sticks
44	Pedal Hi-hat 2 [EXC1]	Pedal Hi-hat 2 [EXC1]	Timpani G#	Square Click
45	Mid Tom 2	Brush Mid Tom 2	Timpani A	Metronome Click
46	Open Hi-hat 3 [EXC1]	Brush Open Hi-hat [EXC1]	Timpani A#	Metronome Bell
47	Mid Tom 1	Brush Mid Tom 1	Timpani B	Guitar sliding Finger
C3 48	High Tom 2	Brush High Tom 2	Timpani c	Guitar cutting noise (up)
49	Crash Cymbal 1	Brush Crash Cymbal	Timpani c#	Guitar cutting noise (down)
50	High Tom 1	Brush High Tom 1	Timpani d	String slap of double bass
51	Ride Cymbal 1	Brush Ride Cymbal	Timpani d#	Fl.Key Click
52	Chinese Cymbal	Chinese Cymbal	Timpani e	Laughing
53	Ride Bell	Brush Ride Bell	Timpani f	Screaming
54	Tambourine	Tambourine	Tambourine	Punch
55	Splash Cymbal	Splash Cymbal	Splash Cymbal	Heart Beat
56	Cowbell	Cowbell	Cowbell	Footsteps1
57	Crash Cymbal 2	Crash Cymbal 2	Concert Cymbal 2	Footsteps2
58	Vibra-slap	Vibra-slap	Vibra-slap	Applause
59	Ride Cymbal 2	Ride Cymbal 2	Concert Cymbal 1	Door Creaking
C4 60	High Bongo 1	High Bongo 1	High Bongo 1	Door
61	Low Bongo 1	Low Bongo 1	Low Bongo 1	Scratch
62	Mute High Conga 1	Mute High Conga 1	Mute High Conga 1	Wind Chimes
63	Open High Conga 1	Open High Conga 1	Open High Conga 1	Car-Engine
64	Low Conga 1	Low Conga 1	Low Conga 1	Car-Stop
65	High Timbale	High Timbale	High Timbale	Car-Pass
66	Low Timbale	Low Timbale	Low Timbale	Car-Crash
67	High Agogo	High Agogo	High Agogo	Siren
68	Low Agogo	Low Agogo	Low Agogo	Train
69	Cabasa	Cabasa	Cabasa	Jetplane
70	Maracas	Maracas	Maracas	Helicopter
71	Short Hi Whistle [EXC2]	Short Hi Whistle [EXC2]	Short Hi Whistle [EXC2]	Starship
C5 72	Long Low Whistle [EXC2]	Long Low Whistle [EXC2]	Long Low Whistle [EXC2]	Gun Shot
73	Short Guiro [EXC3]	Short Guiro [EXC3]	Short Guiro [EXC3]	Machine Gun
74	Long Guiro [EXC3]	Long Guiro [EXC3]	Long Guiro [EXC3]	Lasergun
75	Claves	Claves	Claves	Explosion
76	High Wood Block	High Wood Block	High Wood Block	Dog
77	Low Wood Block	Low Wood Block	Low Wood Block	Horse-Gallop
78	Mute Cuica [EXC4]	Mute Cuica [EXC4]	Mute Cuica [EXC4]	Birds
79	Open Cuica [EXC4]	Open Cuica [EXC4]	Open Cuica [EXC4]	Rain
80	Mute Triangle1 [EXC5]	Mute Triangle1 [EXC5]	Mute Triangle1 [EXC5]	Thunder
81	Open Triangle 1 [EXC5]	Open Triangle 1 [EXC5]	Open Triangle 1 [EXC5]	Wind
82	Shaker	Shaker	Shaker	Seashore
83	Jingle Bell	Jingle Bell	Jingle Bell	Stream
C6 84	Bell Tree	Bell Tree	Bell Tree	Bubble
85	Castanets	Castanets	Castanets	Cat
86	Mute Surdo [EXC6]	Mute Surdo [EXC6]	Mute Surdo [EXC6]	Bird
87	Open Surdo [EXC6]	Open Surdo [EXC6]	Open Surdo [EXC6]	BabyLaughing
88	-----	-----	Applause	Boeeeen
89	-----	-----	-----	Glass & Glam
90	-----	-----	-----	Ice Ring
91	-----	-----	-----	Crack Bottle
92	-----	-----	-----	Pour Bottle
93	-----	-----	-----	Car Horn
94	-----	-----	-----	R.Crossing
95	-----	-----	-----	SL 1
C7 96	-----	-----	-----	SL 2
97	-----	-----	-----	Seal
98	-----	-----	-----	Fancy Animal
99	-----	-----	-----	Elephant
100	-----	-----	-----	Bike
101	-----	-----	-----	-----
102	-----	-----	-----	Small Club
103	-----	-----	-----	-----
104	-----	-----	-----	-----
105	-----	-----	-----	-----

Effects List

Effect Type	Explanation
Equalizer	This is a four-band stereo equalizer (low, high).
Spectrum	This is a stereo spectrum.
Enhancer	Adds sparkle and tightness to the sound.
Isolator	Adds a special effect to the sound by cutting the volume in varying ranges.
Low Boost	Boosts the volume of the lower range, creating powerful lows.
High Pass Filter	This is a low-cut filter. It cuts the low-frequency component.
Overdrive	Creates a soft distortion similar to that produced by vacuum tube amplifiers.
Distortion	Produces a more intense distortion than Overdrive.
Overdrive2	This is an overdrive that provides heavy distortion.
Distortion2	This is a distortion effect that provides heavy distortion.
Speaker Simulator	Simulates the speaker type and mic settings used to record the speaker sound.
Guitar Amp Simulator	This is an effect that simulates the sound of a guitar amplifier.
Phaser	A phase-shifted sound is added to the original sound and modulated.
Multi Stage Phaser	Extremely high settings of the phase difference produce a deep phaser effect.
Infinite Phaser	A phaser that continues raising/lowering the frequency at which the sound is modulated.
Stereo Flanger	It produces a metallic resonance that rises and falls like a jet airplane taking off or landing.
3D Flanger	This applies a 3D effect to the flanger sound.
2Band Flanger	A flanger that lets you apply an effect independently to the low-frequency and high-frequency ranges.
Auto Wah	Cyclically controls a filter to create cyclic change in timbre.
Humanizer	Adds a vowel character to the sound, making it similar to a human voice.
Ring Modulator	This is an effect that applies amplitude modulation (AM) to the input signal, producing bell-like sounds.
Tremolo	Cyclically modulates the volume to add tremolo effect to the sound.
Auto Pan	Cyclically modulates the stereo location of the sound.
Slicer	By applying successive cuts to the sound, this effect turns a conventional sound into a sound that appears to be played as a backing phrase.
Compressor	Flattens out high levels and boosts low levels, smoothing out fluctuations in volume.
Limiter	Compresses signals that exceed a specified volume level, preventing distortion from occurring.
Stereo Chorus	This is a stereo chorus.
Hexa Chorus	Uses a six-phase chorus (six layers of chorused sound) to give richness and spatial spread to the sound.
Tremolo Chorus	This is a chorus effect with added Tremolo (cyclic modulation of volume).
Space D	Produces a transparent chorus effect.
3D Chorus	This applies a 3D effect to the chorus sound.
2 Band Chorus	A chorus effect that lets you apply an effect independently to the low-frequency and high-frequency ranges.

Effect Type	Explanation
Rotary	The Rotary effect simulates the sound of the rotary speakers often used with the electric organs of the past.
Rotary2	This type provides modified response for the rotary speaker, with the low end boosted further.
Rotary Multi	It comprises vibrato/chorus, overdrive, and rotary effects.
Stereo Delay1	This is a stereo delay. The delay time is set to a length of one eighth note.
Stereo Delay2	This is a stereo delay. The delay time is set to a length of one quarter-note triplet.
Stereo Delay3	This is a stereo delay. The delay time is set to a length of one dotted eighth note.
Stereo Delay4	This is a stereo delay. The delay time is set to a length of one quarter note.
Stereo Delay5	This is a stereo delay. The delay time is set to a length of one half note.
Monaural Delay	This is a monaural delay.
Modulation Delay	Adds modulation to the delayed sound.
Triple Tap Delay	Produces three delay sounds; center, left and right.
3D Delay	This applies a 3D effect to the delay sound.
Tape Echo	A virtual tape echo that produces a realistic tape delay sound.
Reverse Delay	This is a reverse delay that adds a reversed and delayed sound to the input sound.
Lo-Fi	This is an effect that intentionally degrades the sound quality for creative purposes.
Telephone	This applies a telephone sound.
Gate Reverb	This is a special type of reverb in which the reverberant sound is cut off before its natural length.
Overdrive -> Chorus	This effect connects an overdrive and a chorus in series.
Overdrive -> Flanger	This effect connects an overdrive and a flanger in series.
Overdrive -> Delay	This effect connects an overdrive and a delay in series.
Distortion -> Chorus	This effect connects an distortion and a chorus in series.
Distortion -> Flanger	This effect connects an distortion and a flanger in series.
Distortion -> Delay	This effect connects an distortion and a delay in series.
Enhancer -> Chorus	This effect connects an enhancer and a chorus in series.
Enhancer -> Flanger	This effect connects an enhancer and a flanger in series.
Enhancer -> Delay	This effect connects an enhancer and a delay in series.
Chorus -> Delay	This effect connects a chorus and a delay in series.
Flanger -> Delay	This effect connects a flanger and a delay in series.
Chorus -> Flanger	This effect connects a chorus and a flanger in series.
Damper Resonance	On an acoustic piano, holding down the damper pedal allows other strings to resonate in sympathy with the notes you play, creating rich and spacious resonances. This effect simulates these damper resonances.

Music Style List (KR117)

[Pop/Rock]

1	'80s Rock
2	Idol Ballad
3	Pop
4	'80s Pop 1
5	Funky Disco
6	AdultContemp
7	Uptown Rock
8	80sRetroDSCO
9	UK Rock 21st
10	16BtBrassRck
11	Barry Dance
12	70's Pop
13	Soft Rock
14	Cool Pop
15	DiscoShuffl
16	Analog Beat
17	Rock Beat
18	Hip Beat
19	EZ Listening
20	Strumin'Awy
21	'70s Disco 1
22	SmoothContmp
23	Simple Rock
24	'60s Feelin'
25	16Beat Pop
26	Light Pop
27	Bright Pop
28	Heart Beat
29	Easy Pop
30	'80s Pop 2
31	'80s Pop 3
32	Cute Pop
33	LovelyShuffl
34	'70s Disco 2
35	'70s Dance
36	Fever Dance
37	Euro Dance
38	Hard Tekno
39	Big House
40	'90s House
41	House Pop
42	Ibiza Dance
43	Cool Rap
44	Now Hip Hop
45	Twostep
46	HipHop Beat
47	Hip'n Hop
48	Easy Hop
49	MorningShffl
50	Groovy Pop
51	Smile Pop
52	Warm Pop
53	Sunny Pop
54	Feel Good
55	US Groove
56	Steady Rock
57	Shuffle Rock
58	Dyno Rock
59	Power Rock
60	Heavy Rock
61	Thump Rock
62	Asian Pop

[Ballad/Acoustic]

1	AmericanRock
2	GtrUnplugged
3	Movie Ballad

4	ModernBallad
5	'80s Ballad
6	AcoustBallad
7	AcoustEzLstn
8	UnpluggedPop
9	UnplugBallad
10	Adult Pop 1
11	Adult Pop 2
12	6/8Unplugged
13	6/8GuitarPop
14	Acoustic Pop
15	Live Pop
16	Love Ballad
17	6/8 Ballad
18	Love Beat
19	UnplugShuffl
20	CoolLiveBand
21	Night Ballad
22	GuitarShuffl
23	Euro Ballad
24	Guitar Trio
25	Midnight Bld
26	Pop Ballad
27	Piano Pop
28	Love Songs
29	12/8 Ballad
30	Scat Ballad
31	'60s Ballad
32	Torch Song 1
33	Torch Song 2
34	Strings
35	8BeatBallad1
36	8BeatBallad2
37	Fireside
38	Piano Ballad
39	Story Ballad
40	SimpleBallad
41	ClassicBalad
42	Symph Ballad
43	R.8-Beat 1
44	R.8-Beat 2
45	R.16-Beat 1
46	R.16-Beat 2
47	R.16-Beat 3
48	R.16-Beat 4
49	R.Afro&Swing
50	R.5BeatSwing
51	R.Shuffle
52	R.Waltz
53	R.March
54	R.5-Beat
55	R.7-Beat
56	P.Pop 1
57	P.Classic 1
58	P.Night
59	P.Bossa Nova
60	P.Ragtime
61	P.Classic 2
62	P.Ballad 2
63	P.Swing Pop
64	P.Rock'nRoll
65	P.Concerto 1
66	P.Concerto 2
67	P.Swing
68	P.Shuffle
69	P.Boogie
70	P.'50s Rock
71	P.Latin

[Oldies/Country]

1	Guitar Lady
2	EasySlowRock
3	CountryFox 2
4	Country Gtr
5	Easy Country
6	Detroit Pop
7	'60s Rock'n
8	DreamSloRock
9	CountryRock1
10	CntryBallad1
11	Groovin R&B
12	Oldies 1
13	Clock Rock'n
14	CountryPop 1
15	SwinginCntry
16	Soul
17	Rock'n Slow
18	Oldies 2
19	CntryBallad2
20	CountrySwing
21	Rock'n Fever
22	Country Beat
23	Slow Country
24	CountryRock2
25	CountryFox 1
26	Blues
27	R&B
28	Slow Dance
29	Twist
30	'60s Beach
31	Slow Oldies
32	Early Rock
33	Go Go Rock
34	Mersey Beat
35	CountryPop 2
36	Cajun
37	Country
38	Cntry Dreams
39	Charleston
40	Bluegrass
41	Deep Country

[Big Band/Swing]

1	MidnitSloSwg
2	BigBand Slow
3	Big Band
4	BigBand Med
5	BigBand Fast
6	PnoBndBoogie
7	SoftJzBallad
8	Slow Fox
9	Medium Swing
10	Jive
11	Slow Swing
12	Quick Step
13	StringsSwing
14	Foxtrot
15	Swing Fox
16	Fox Band
17	Gipsy Swing
18	Fast Swing
19	JzGuitrSwing
20	Jazz Waltz
21	Blue Boogie
22	BigBandBalad
23	'30s BigBand

24	Big Band 2
25	Jazz Ballad
26	LooseBigBand
27	Smooth Jazz
28	A Cappella
29	Scat Swing
30	Organ Swing
31	Dixieland
32	Hawaiian
33	Hula

[Gospel/Latin]

1	SimplyChaCha
2	Latin Pop 1
3	Orch Bossa
4	AmazinGospel
5	SimpleCumbia
6	Medium Gipsy
7	ModrnBeguine
8	Fast Gipsy
9	Rhumba
10	GospelShuffl
11	ContPraise 1
12	ContPraise 2
13	Gospel
14	Samba
15	ModernChaCha
16	Salsa
17	Soft Gospel
18	Gospel Shout
19	AcoustRhumba
20	Acoust Samba
21	Trad Rhumba
22	Gospel Pop
23	GospelBallad
24	Latin Dance
25	Cha Cha
26	Trad Tango
27	SunshineBosa
28	Jazz Bossa
29	Merengue
30	GuitarRhumba
31	Mambo
32	Fast Samba
33	Fast Bossa
34	Big Samba
35	Luv Bossa
36	Mid Bossa
37	Latin Pop 2
38	Reggae
39	Tango
40	Beguine
41	Oye Son
42	Revival
43	Gospel Piano
44	Asian Rhumba

[Trad/World]

1	OrchMariachi
2	Orch Polka
3	Boston Waltz
4	Euro Pop
5	FolkValzer 1
6	FolkValzer 2
7	Polka Yanks
8	Polka Party
9	Madison
10	Musical
11	Pub Boogie
12	Vienna Waltz
13	Kids Shuffle
14	Movie March
15	Music Hall
16	Orch Bolero
17	Orch Waltz
18	Holiday 1
19	Classic
20	Jing Ju
21	MarchingBand
22	March
23	Slow Waltz
24	Fast Waltz
25	Paris
26	Quiet Waltz
27	Holiday 2
28	Holiday 3
29	2 Beat
30	Lager Polka
31	Slow Polka
32	AustrianPolk
33	AustrianWalz
34	Irish
35	Tejano
36	Celtic
37	Musette
38	Scotland
39	Japan
40	Ireland
41	Paso Doble
42	China Pop
43	Jiang Nan
44	Xi Bei
45	SchlagerBeat
46	PartySchlagr
47	'70sSchlager
48	Disco Fox
49	Party Polka
50	RockSchlager
51	ShufflSchlgr
52	SimpleMarch1
53	SimpleMarch2
54	Simple Waltz
55	Kids 4/4
56	Kids 6/8
57	Kids
58	Kids Dance
59	Cinema 2Beat

Music Style List (KR115)

[Pop/Rock]

1	'80s Rock
2	Idol Ballad
3	Pop
4	'80s Pop 1
5	Funky Disco
6	AdultContemp
7	Uptown Rock
8	80sRetroDSCO
9	UK Rock 21st
10	Barry Dance
11	Soft Rock
12	EZ Listening
13	Strumin' Away
14	'70s Disco 1
15	SmoothContmp
16	Simple Rock
17	'60s Feelin'
18	16Beat Pop
19	Light Pop
20	Bright Pop
21	Heart Beat
22	Easy Pop
23	'80s Pop 2
24	'80s Pop 3
25	Cute Pop
26	LovelyShuffl
27	'70s Disco 2
28	'70s Dance
29	Fever Dance
30	Euro Dance
31	Hard Tekno
32	Big House
33	'90s House
34	House Pop
35	Ibiza Dance
36	Cool Rap
37	Now Hip Hop
38	Twostep
39	HipHop Beat
40	Hip'n Hop
41	Easy Hop
42	MorningShffl
43	Groovy Pop
44	Smile Pop
45	Warm Pop
46	Sunny Pop
47	Feel Good
48	US Groove
49	Steady Rock
50	Shuffle Rock
51	Dyno Rock
52	Power Rock
53	Heavy Rock
54	Thump Rock
55	Asian Pop

[Ballad/Acoustic]

1	AmericanRock
2	GtrUnplugged
3	Movie Ballad
4	ModernBallad
5	'80s Ballad
6	AcoustBallad
7	AcoustEzLstn
8	UnpluggedPop

9	UnplugBallad
10	Adult Pop 1
11	Adult Pop 2
12	6/8Unplugged
13	6/8GuitarPop
14	Acoustic Pop
15	Live Pop
16	Love Ballad
17	6/8 Ballad
18	Love Beat
19	UnplugShuffl
20	CoolLiveBand
21	Night Ballad
22	GuitarShuffl
23	Euro Ballad
24	Guitar Trio
25	Midnight Bld
26	Pop Ballad
27	Piano Pop
28	Love Songs
29	12/8 Ballad
30	Scat Ballad
31	'60s Ballad
32	Torch Song 1
33	Torch Song 2
34	Strings
35	8BeatBallad1
36	8BeatBallad2
37	Fireside
38	Piano Ballad
39	Story Ballad
40	SimpleBallad
41	ClassicBalad
42	Symph Ballad
43	R.8-Beat 1
44	R.8-Beat 2
45	R.16-Beat 1
46	R.16-Beat 2
47	R.16-Beat 3
48	R.16-Beat 4
49	R.Afro&Swing
50	R.5BeatSwing
51	R.Shuffle
52	R.Waltz
53	R.March
54	R.5-Beat
55	R.7-Beat
56	P.Pop 1
57	P.Classic 1
58	P.Night
59	P.Bossa Nova
60	P.Ragtime
61	P.Classic 2
62	P.Ballad 2
63	P.Swing Pop
64	P.Rock'nRoll
65	P.Concerto 1
66	P.Concerto 2
67	P.Swing
68	P.Shuffle
69	P.Boogie
70	P.'50s Rock
71	P.Latin

[Oldies/Country]

1	Guitar Lady
2	EasySlowRock
3	Detroit Pop
4	'60s Rock'n
5	DreamSloRock
6	CountryRock1
7	CntryBallad1
8	Groovin R&B
9	Oldies 1
10	Clock Rock'n
11	CountryPop 1
12	SwinginCntry
13	Soul
14	Rock'n Slow
15	Oldies 2
16	CntryBallad2
17	CountrySwing
18	Rock'n Fever
19	Country Beat
20	Slow Country
21	CountryRock2
22	CountryFox 1
23	Blues
24	R&B
25	Slow Dance
26	Twist
27	'60s Beach
28	Slow Oldies
29	Early Rock
30	Go Go Rock
31	Mersey Beat
32	CountryPop 2
33	Cajun
34	Country
35	Cntry Dreams
36	Charleston
37	Bluegrass
38	Deep Country

[Big Band/Swing]

1	MidnitSloSwg
2	BigBand Slow
3	Big Band
4	BigBand Med
5	BigBand Fast
6	PnoBndBoogie
7	Medium Swing
8	Jive
9	Slow Swing
10	Quick Step
11	StringsSwing
12	Foxtrot
13	Swing Fox
14	Fox Band
15	Gipsy Swing
16	Fast Swing
17	JzGuitrSwing
18	Jazz Waltz
19	Blue Boogie
20	BigBandBalad
21	'30s BigBand
22	Big Band 2
23	Jazz Ballad
24	LooseBigBand

25	Smooth Jazz
26	A Cappella
27	Scat Swing
28	Organ Swing
29	Dixieland
30	Hawaiian
31	Hula

[Gospel/Latin]

1	SimplyChaCha
2	Latin Pop 1
3	Orch Bossa
4	AmazinGospel
5	Rhumba
6	GospelShuffl
7	ContPraise 1
8	ContPraise 2
9	Gospel
10	Samba
11	ModernChaCha
12	Salsa
13	Soft Gospel
14	Gospel Shout
15	AcoustRhumba
16	Acoust Samba
17	Trad Rhumba
18	Gospel Pop
19	GospelBallad
20	Latin Dance
21	Cha Cha
22	Trad Tango
23	SunshineBosa
24	Jazz Bossa
25	Merengue
26	GuitarRhumba
27	Mambo
28	Fast Samba
29	Fast Bossa
30	Big Samba
31	Luv Bossa
32	Mid Bossa
33	Latin Pop 2
34	Reggae
35	Tango
36	Beguine
37	Oye Son
38	Revival
39	Gospel Piano
40	Asian Rhumba

[Trad/World]

1	OrchMariachi
2	Orch Polka
3	Musical
4	Pub Boogie
5	Vienna Waltz
6	Kids Shuffle
7	Movie March
8	Music Hall
9	Orch Bolero
10	Orch Waltz
11	Holiday 1
12	Classic
13	Jing Ju
14	MarchingBand
15	March
16	Slow Waltz
17	Fast Waltz
18	Paris
19	Quiet Waltz
20	Holiday 2
21	Holiday 3
22	2 Beat
23	Lager Polka
24	Slow Polka
25	AustrianPolk
26	AustrianWalz
27	Irish
28	Tejano
29	Celtic
30	Musette
31	Scotland
32	Japan
33	Ireland
34	Paso Doble
35	China Pop
36	Jiang Nan
37	Xi Bei
38	SchlagerBeat
39	PartySchlagr
40	'70sSchlager
41	Disco Fox
42	Party Polka
43	RockSchlager
44	ShufflSchlgr
45	SimpleMarch1
46	SimpleMarch2
47	Simple Waltz
48	Kids 4/4
49	Kids 6/8
50	Kids
51	Kids Dance
52	Cinema 2Beat

Chord List

* ● symbol: Indicates the constituent note of chords.

* ★ symbol: Chord shown with an "★" can be played by pressing just the key marked with the "★" (p. 59).

C	C#	D	E \flat	E	F
Cmaj7	C#maj7	Dmaj7	E \flat maj7	Emaj7	Fmaj7
C7	C#7	D7	E \flat 7	E7	F7
Cm	C#m	Dm	E \flat m	Em	Fm
Cm7	C#m7	Dm7	E \flat m7	Em7	Fm7
Cdim	C#dim	Ddim	E \flat dim	Edim	Fdim
Cm7 (b5)	C#m7 (b5)	Dm7 (b5)	E \flat m7 (b5)	Em7 (b5)	Fm7 (b5)
Caug	C#aug	Daug	E \flat aug	Eaug	Faug
Csus4	C#sus4	Dsus4	E \flat sus4	Esus4	Fsus4
C7sus4	C#7sus4	D7sus4	E \flat 7sus4	E7sus4	F7sus4
C6	C#6	D6	E \flat 6	E6	F6
Cm6	C#m6	Dm6	E \flat m6	Em6	Fm6

* ● symbol: Indicates the constituent note of chords.

* ★ symbol: Chord shown with an “★” can be played by pressing just the key marked with the “★” (p. 59).

F#	G	A \flat	A	B \flat	B
F#maj7	Gmaj7	A \flat maj7	A maj7	B \flat maj7	Bmaj7
F#7	G7	A \flat 7	A7	B \flat 7	B7
F#m	Gm	A \flat m	Am	B \flat m	Bm
F#m7	Gm7	A \flat m7	Am7	B \flat m7	Bm7
F#dim	Gdim	A \flat dim	Adim	B \flat dim	Bdim
F#m7 (b5)	Gm7 (b5)	A \flat m7 (b5)	Am7 (b5)	B \flat m7 (b5)	Bm7 (b5)
F#aug	Gaug	A \flat aug	Aaug	B \flat aug	Baug
F#sus4	Gsus4	A \flat sus4	Asus4	B \flat sus4	Bsus4
F#7sus4	G7sus4	A \flat 7sus4	A7sus4	B \flat 7sus4	B7sus4
F#6	G6	A \flat 6	A6	B \flat 6	B6
F#m6	Gm6	A \flat m6	Am6	B \flat m6	Bm6

Internal Song List

Folks	
1	Greensleeves
2	Entertainer
3	Annie Laurie
4	Londonderry Air
5	Ave Maria
6	Amazing Grace
7	Little Brown Jug
8	When The Saints Go Marchin' In
9	Stagecoach
10	Hallelujah!

Jazzy	
1	Grand Symphoney
2	Trio Grande
3	Fly Free
4	Secret Agent
5	Late Night Chopin
6	Blue Sky Rag
7	Preludelight
8	Sun Daze
9	Keepers Tale
10	Count On The Blues
11	One Down And Easy
12	A Prelude To ...
13	Bach's A Boppin'
14	Kismet's Salsa
15	From Matthew's Passion
16	Roll Over Ludwig

Kids	
1	Grandfather's Clock
2	Old MacDonald Had A Farm
3	Twinkle Twinkle, Little Star
4	Mary Had A Little Lamb
5	London Bridge

Kids	
6	Jingle Bells
7	Silent Night, Holy Night
8	Joy To The World
9	Puppy's March
10	Frog Song
11	Little Fox
12	Lightly Row
13	The Cuckoo

EZ Classical	
1	La Fille Aux Cheveux De Lin
2	La Campanell
3	Eine Kleine Nachtmusik
4	Les patineurs, Valse
5	Divertimento
6	Impromptu, Op.90-2
7	Grossienne 1
8	Die Lorelei
9	Brindisi
10	Air sul G
11	FantaisieImpromptu
12	Grande Valse Brillante
13	Gymnopedie 1
14	Liebestraume 3
15	Mondschein
16	Nocturne No.2
17	Valse, op.64-1
18	Prelude, op.28-15
19	Traumerei
20	Turkischer Marsch(Mozart)
21	Ungarische Tanze 5
22	O'sole Mio
23	La Primavera
24	Trepak
25	Canon (Pachelbel)
26	Ombra maifu

EZ Classical	
27	Sonata (Haydn)
28	Italian Concerto

Classical	
→ Song files of this genre corresponds to the included collection of printed music entitled "Roland 60 Classical Piano Masterpieces."	
1	Sonate No.15
2	Liebestraume 3
3	Etude, op.10-3
4	Je te veux
5	Valse, op.64-1
6	Golliwog'sCakewalk
7	FantaisieImpromptu
8	Arabesque 1
9	Blauen Donau
10	Auf Flugeln des Gesanges
11	Mazurka No.5
12	Gymnopedie 1
13	Etude, op.25-1
14	Clair de Lune
15	Etude, op.10-5
16	Dr.GradusAdParnassum
17	Grande Valse Brillante
18	La priere d'une Vierge
19	Course en Troika
20	To The Spring
21	Valse, op.64-2
22	Radetzky Marsch
23	Traumerei
24	Moments Musicaux 3
25	Prelude, op.28-15
26	Harmonious Blacksmith
27	Ungarische Tanze 5
28	Turkischer Marsch(Beethoven)
29	Nocturne No.2

Classical	
30	Fruhlingslied
31	Praludium
32	Jagerlied
33	Menuet Antique
34	Fur Elise
35	Turkischer Marsch(Mozart)
36	Standchen
37	Humoreske
38	Blumenlied
39	Alpenglockchen
40	Menuett G dur(Beethoven)
41	Venezianisches Gondellied
42	Alpenabendrote
43	Farewell to the Piano
44	Brautchor
45	Battle of Waterloo
46	Wiener Marsch
47	Le Coucou
48	Menuett G dur(Bach)
49	Spinnerlied
50	Gavotte
51	Heidenroslein
52	Zigeuner Tanz
53	La Cinquantaine
54	Csikos Post
55	Dolly's Dreaming Awakening
56	La Violette
57	Frohlicher Landmann
58	Sonatine op.36-1(Clementi)
59	Sonatine op.20-1(Kuhlau)
60	Sonatine No.5(Beethoven)

Practice	
1	Arabesque
2	Pastoral
3	A Small Gathering

Practice	
4	Innocence
5	Progress
6	The Clear Stream
7	Gracefulness
8	The Hunt
9	Tender Flower
10	The Young Shepherdess
11	Farewell
12	Consolation
13	Austrian Dance
14	Ballad
15	Sighing
16	The Chatterbox
17	Restlessness
18	Ave Maria
19	Tarantella
20	Angelic Harmony
21	Gondola Song
22	The Return
23	The Swallow
24	The Knight Errant
25	Openness
26	Invention 1
27	Invention 2
28	Invention 3
29	Invention 4
30	Invention 5
31	Invention 6
32	Invention 7
33	Invention 8
34	Invention 9
35	Invention 10
36	Invention 11
37	Invention 12
38	Invention 13
39	Invention 14

Practice	
40	Invention 15
41	Beyer 15
42	Beyer 21
43	Beyer 25
44	Beyer 29
45	Beyer 34
46	Beyer 38
47	Beyer 42
48	Beyer 46
49	Beyer 51
50	Beyer 55
51	Beyer 60
52	Beyer 64
53	Beyer 67
54	Beyer 73
55	Beyer 78
56	Beyer 81
57	Beyer 90
58	Beyer 93
59	Beyer 98
60	Beyer 103
61	Czerny 100- 1
62	Czerny 100-10
63	Czerny 100-20
64	Czerny 100-30
65	Czerny 100-38
66	Czerny 100-43
67	Czerny 100-60
68	Czerny 100-75
69	Czerny 100-86
70	Czerny 100-96

* All rights reserved. Unauthorized use of this material for purposes other than private, personal enjoyment is a violation of applicable laws.

Parameters Stored to Internal Memory

Parameters Stored in the User Program

→ "Saving Performance Settings (User Program)" (p. 130)

Parameters that switch immediately after the User Program name is touched when <Option> on the User Program screen is set to "Delayed"	
Organ	Rotary effect (Slow/Fast), Footage (Upper, Lower), Percussion
Selected Right-hand Tone, Layer Tone, Left-hand Tone	Tone, Octave Shift, Effect (Type, Control 1, Control 2, On/Off, The part to which the effect is added)
Bass Tone, Chord Tone	
Part Balance	Keyboard Parts
Melody Intelligent	On/Off, Type
Keyboard Mode	Lower 1, Lower 2, On/Off for the Part, Layer 1, Layer 2, On/Off for the Part, Keyboard Transpose, Split Point, Split On/Off
Pedal Settings	Functions Assigning to the Left Pedal and Center Pedal Bend Range Functions Assigning to the Expression Pedal
Performance Pad Settings	User Function
Reverb	On/Off, Type, Depth
Vocal Effects	On/Off, Echo (Type, Depth), Transformer Type, Harmonist Type, Transformer/Harmonist, Music Files Part
MIDI Settings for User Program	Bank Select LSB, Bank Select MSB, Program Change, MIDI Transmit Channel
Equalizer	On/Off, Each Sliders Level, Master Level
Dynamic Emphasis	On/Off, Type

Parameters Stored in the User Program Set	
Pedal Shift	
Load Next	

Parameters that switch after the User Program name is touched for a few moments when <Option> on the User Program screen is set to "Delayed"

Music Style	
Tempo	
Part Balance	Accompaniment Part
Arranger Settings	Accompaniment On/Off, Chord Recognize Mode, Leading Bass On/Off, Original/Variation, Sync Start On/Off, <Accomp> Setting for Arranger Configuration, Style Orchestrator, Division

Parameters Stored in Memory Backup

→ "Remembering the Settings Even When the Power is Turned Off (Memory Backup)" (p. 171)

System Parameters	Tuning (Tuning, Key, Stretch Tunings)
	Master Tune
	Effect: the part to which the effect is added
	Metronome: Sound
	Count-In: Measures, Sound
	Countdown: Sound
	Language
	Track Assign
	Reverb: On/Off, Type, Depth
	Advanced 3D: On/Off, On/Off for Each Part, Various Settings
	Remote Control's Setting
	External Display (Device)
	Infrared Transmission Function
	AUX Input settings
	MIDI Setting: Tx Channel
A/V Sync Output: Output Mode	

Parameters That are Stored After the Power is Turned Off

Touch Screen	
Opening Message	
Auto Demo	Start: On/Off BGM: On/Off
USB Driver	
Equalizer	User Settings
Jazz Organ Footage	User Settings
Piano Designer	User Settings

Music Files That the KR Can Use

What Are Music Files?

Music Files contain information describing the details of a musical performance, such as “the C3 key on a keyboard was pressed for this amount of time, using this amount of force.” By connecting the external memory to the external memory port on the KR, the performance information is sent from the external memory to the piano, and played faithfully by the piano. This is different than a CD, since the music file does not contain a recording of the sound itself. This makes it possible to erase certain parts, or to change instruments, tempos and keys freely, allowing you to use it in many different ways.

Regarding Copyright

Other than for your own personal enjoyment, any use of the song data programmed in this instrument without the consent of the copyright holder is prohibited by law. Additionally, this data must not be copied, nor used in a secondary copyrighted work without the permission of the copyright holder.

■ The KR allows you to use the following music files

- Floppy disks saved on a Roland MT Series, or Roland Piano Digital HP-G/R and KR Series instrument
 - Roland Digital Piano Compatible Music Files
Roland’s original music file is made specifically for practicing the piano. Some follow an instructional curriculum, allowing for a complete range of lessons, such as “practicing each hand separately” or “listening to only the accompaniment.”
 - SMF Music Files (720KB/1.44MB format)
SMFs (Standard MIDI Files) use a standard format for music file that was formulated so that files containing music file could be widely compatible, regardless of the manufacturer of the listening device. An enormous variety of music is available, whether it be for listening, for practicing musical instruments, for Karaoke, etc.
- * If you wish to purchase SMF Music Files, please consult the retailer where you purchased your KR.

SMF with Lyrics

“SMF with Lyrics” refers to SMF (Standard MIDI File) that contains the lyrics. When Music Files carrying the “SMF with Lyrics” logo are played back on a compatible device (one bearing the same logo), the lyrics will appear in its display.

■ About the KR Sound Generator

The KR come equipped with GM 2/GS sound generators.

General MIDI

The General MIDI is a set of recommendations which seeks to provide a way to go beyond the limitations of proprietary designs, and standardize the MIDI capabilities of sound generating devices. Sound generating devices and music files that meets the General MIDI standard bears the General MIDI logo. Music files bearing the General MIDI logo can be played back using any General MIDI sound generating unit to produce essentially the same musical performance.

General MIDI 2

The upwardly compatible General MIDI 2 recommendations pick up where the original General MIDI left off, offering enhanced expressive capabilities, and even greater compatibility. Issues that were not covered by the original General MIDI recommendations, such as how sounds are to be edited, and how effects should be handled, have now been precisely defined. Moreover, the available sounds have been expanded. General MIDI 2 compliant sound generators are capable of reliably playing back music files that carry either the General MIDI or General MIDI 2 logo.

In some cases, the conventional form of General MIDI, which does not include the new enhancements, is referred to as “General MIDI 1” as a way of distinguishing it from General MIDI 2.

GS Format

The GS Format is Roland’s set of specifications for standardizing the performance of sound generating devices. In addition to including support for everything defined by the General MIDI, the highly compatible GS Format additionally offers an expanded number of sounds, provides for the editing of sounds, and spells out many details for a wide range of extra features, including effects such as reverb and chorus. Designed with the future in mind, the GS Format can readily include new sounds and support new hardware features when they arrive. Since it is upwardly compatible with the General MIDI, Roland’s GS Format is capable of reliably playing back GM Scores equally as well as it performs GS music files (music files that have been created with the GS Format in mind). This product supports both the General MIDI 2 and the GS Format, and can be used to play back music data carrying either of these logos.

XG lite

XG is a tone generator format of YAMAHA Corporation, that defines the ways in which voices are expanded or edited and the structure and type of effects, in addition to the General MIDI 1 specification. XGlite is a simplified version of XG tone generation format. You can play back any XG music files using an XGlite tone generator. However, keep in mind that some music files may play back differently compared to the original files, due to the reduced set of control parameters and effects.

MIDI Implementation Chart

Function...	Transmitted	Recognized	Remarks	
Basic Channel	Default Changed	1 1-16	1-16 1-16	
Mode	Default Messages Altered	Mode 3 x *****	Mode 3 Mode 3, 4 (M=1)	* 2
Note Number :	True Voice	15-113 *****	0-127 0-127	
Velocity	Note ON Note OFF	O O	O O	
After Touch	Key's Ch's	x x	O *1 O *1	
Pitch Bend		O	O	
Control Change		0, 32 O 1 O *1 5 O *1 6, 38 O *1 7 O 10 O *1 11 O *1 64 O 65 O *1 66 O 67 O 84 O *1 91 O 93 O 98, 99 O *1 100, 101 O *1	O *1 O *1 O *1 O *1 O *1 O *1 O *1 O *1 O *1 O *1 O *1 O *1 O *1 O (Reverb) *1 O (Chorus) *1 O *1 O *1	Bank select Modulation Portamento time Data entry Volume Panpot Expression Hold 1 Portamento Sostenuto Soft Portamento control Effect1 depth Effect3 depth NRPN LSB, MSB RPN LSB, MSB
Prog Change	: True #	0-127 *****	O 0-127	Program number 1-128
System Exclusive		O	O	
System Common	: Song Pos : Song Sel : Tune	x x x	x x x	
System Real Time	: Clock : Commands	O x	x x	
Aux Message	: All sound off : Reset all controllers : Local Control : All Notes OFF : Active Sense : Reset	x x x x O x	O (120, 126, 127) O O O (123-125) O O x	
Notes		* 1 O x is selectable by SysEx. * 2 Recognized as M=1 even if M≠1.		

Mode 1 : OMNI ON, POLY Mode 2 : OMNI ON, MONO O : Yes
 Mode 3 : OMNI OFF, POLY Mode 4 : OMNI OFF, MONO X : No

Main Specifications

	KR117M	KR115M	KR115
<Keyboard>			
Keyboard	88 keys (Progressive hammer action keyboard with escapement)		
Touch Sensitivity	100 levels		
Keyboard Mode	Whole, Split (adjustable split point), Layer, Arranger, Piano Style Arranger, Manual Drums / SFX		

<Sound Generator> Conforms to GM2 / GS / XG Lite	
Max. Polyphony	128 voices
Tones (Tone Search by terms and by letters)	6 groups 780 variations (including 8 tone wheel Organs, 17 drum sets, SFX set)
Temperament	8 types, selectable tonic
Stretched Tuning	2 types
Master Tuning	415.3 Hz–466.2 Hz (adjustable in increments of 0.1 Hz)
Transpose	Key Transpose (-6→+5 in units of semitone), Playback Transpose (-24→+24 in units of semitone)
Effects	Reverb (12 types, 127 levels), Chorus, Rotary and 60 other types, Surround, Advanced 3D, Dynamic Emphasis (3 types), Equalizer (5 bands, Master level)

<Arranger>		
Music Styles (Style Search by terms and by letters)	6 groups 310 styles x 3 types (Style Orchestrator)	6 groups 285 styles x 3 types (Style Orchestrator)
Music Assistant (Search by terms and by letters)	Over 550 sets x 6 presets, Visual Music Assistant	
Programmable Music Styles	Style Converter, Style Composer	
Melody Intelligence	24 types	

<User Programs>	
Internal	36
External Memory	Max. 99 sets

<Metronome>	
Tempo	Quarter note = 10–500
Beat	2/2, 0/4, 2/4, 3/4, 4/4, 5/4, 6/4, 7/4, 3/8, 6/8, 9/8, 12/8
Volume	10 levels
Metronome Pattern	11 patterns
Metronome Sound	8 types

<Composer>	
Tracks	5 tracks / 16 tracks
Note Storage	Approx. 30,000 notes
Resolution	120 ticks per quarter notes
Recording Method	Realtime (Replace, Mix, Auto Punch In, Manual Punch In, Loop, Tempo), Step (Chord Sequencer), Beat Map
Edit	Copy, Quantize, Delete, Insert, Erase, Transpose, Part Exchange, Note Edit, PC Edit
Other Functions	Touch the Notes, Replay Pedal, Super Tones, Piano Designer, Visual Lesson, Wonderland/Game, Demo, Tone Audition, Panel Lock, User Image Display, BMP Export, V-LINK, IR function, Slide Show, A/V Sync Output/Input

Main Specifications

	KR117M	KR115M	KR115
--	--------	--------	-------

<External Storage> USB Flash Memory			
Playable Software	Song: Standard MIDI Files (Format 0/1), Roland Original Format (i-Format)		
	Music Style: MSA, MSD, MSE		
	Audio File: WAV Format (44.1 kHz 16 bits linear, stereo)		
Save	Song: Standard MIDI Files (Format 0), Roland Original Format (i-Format)		
	Music Style: MSE		

<Internal Memory>	
Internal Songs (Song Search by terms and by letters)	Over 190 songs
User Memory	Max. 200 songs on Favorites, Max. 99 User Styles, Max. 70 User Program Sets, User Image (Internal x 1, External x 1)

<Others>			
Rated Power Output	70 W x 4	70 W x 2	
Speakers	20 cm x 2, 16 cm x 2, 8 cm x 2, 5 cm x 2	20 cm x 2, 5 cm x 2	
Display	Bouncing Beat Indicator, Graphical Color LCD 320 x 240 dot (backlit LCD)		
Notation	Grand staff / G Clef staff / F Clef staff, with note name /lyrics/ chords / fingering		
Language	English / Japanese / German / French / Spanish		
Lyrics	Yes (built-in, external display)		
One Touch Program	One Touch Piano, One Touch Arranger		
Pedals	Damper Pedal (half-pedal recognition) Soft Pedal (half-pedal recognition, functions assignable) Sostenuto Pedal (functions assignable)		
Vocal Effects	Echo, Voice Transformer, Vocal Keyboard, Harmonist		
Connectors	USB memory connector, FDD connector, Output jacks (L/Mono, R), Input jacks (L/Mono, R), Mic Input jack, Headphones jack (Stereo) x 2, MIDI In connector x 2, MIDI Out connector, USB connector, Ext Display connector (15-pin D-Sub type), Video Out jack, Expression Pedal jack, Balanced Output jacks (L, R)(XLR, Level Fixed), Aux Output jacks (L/Mono, R), Aux Input jacks (L, R), Serial connector (KR115M, KR117M only)		
Power Supply	AC 115 V, AC 117 V, AC 220 V, AC 230 V, AC 240 V (50/60 Hz)		
Power Consumption	360 W	270 W	230 W
Dimensions (including the caster cup)	1503 (W) x 1579 (D) x 1007 (H) mm 59-3/16(W) x 62-3/16(D) x 39-11/16(H) inches	1473 (W) x 937 (D) x 930 (H) mm 58(W) x 36-15/16(D) x 36-5/8(H) inches	
	Lid Open 1503 (W) x 1579 (D) x 1741 (H) mm 59-3/16(W) x 62-3/16(D) x 68-9/16(H) inches	Lid Open 1473 (W) x 937 (D) x 1446 (H) mm 58(W) x 36-15/16(D) x 56-15/16 inches	
Weights (including the piano stand)	240 kg / 530 lbs	140 kg / 310 lbs	115 kg / 255 lbs
Accessories	Quick Start, Owner's Manual, Roland 60 Classical Piano Masterpieces, Remote Control, CD (Music Data Disc with vocals) (KR117M, KR115M), Dry-cell Batteries, USB Installation Guide, CD-ROM (Roland Digital Piano USB Driver), Power cord, Anti-theft lock screws, Maintenance Kit, Key Cover, Caster Cup		
Options	USB Memory, Floppy Disk Drive		

* In the interest of product improvement, the specifications and/or appearance of this unit are subject to change without prior notice.

Index

Numerics

16-Track Sequencer 136

A

A/V sync 122
AC Inlet 16, 21
Access Indicator 17
Accompaniment
 Start and Stop 65
 Sync Start 65
Advanced 3D 39
[Ambience/Reverb] button 39–40
Arranger basic screen 69
Arranger Config 162
Audio Equipment 191
Auto Punch-In/Out 142
Automatic Accompaniment 57
AutoSync DigiScore 88
Aux Input Jacks 16
Aux Output Jacks 16, 194

B

Balance 73
Balance Knob 73
Balanced Out (Fixed) Jacks 16, 192
Bank Select LSB 191
Bank Select MSB 191
Basic Screen 25
Basic tempo 151
Bass Tone 66, 162
Beat
 Metronome 55
Beat Map 150
Bend Range 169
Blank Recording 141
Bouncing Ball 92
[Brilliance] knob 22
[Song] button 75
[Bwd] button 76

C

Calibration 175
CD 177
CD Drive 78
CD Settings 177
Chord Finder 60
Chord Intelligence 59
Chord List 212
Chord Sequencer 143
Chord Tone 66, 162
Chord Type 59
Chords 59, 90
Clef L 91
Clef R 91
Color Notation 92
Composer MIDI Out 191
Computer 195

Connected
 Expression Pedal 185
Connecting
 Audio Equipment 191
 Computer 195
 External Display 185
 External Speakers 194
 MIDI device 188
 Television 185
 Video Equipment 187
Contrast 25
Contrast knob 25
Copy (Song Edit) 146
Copying
 Songs 120
 User Program 133
 User Styles 160
Count In 96
Countdown 67

D

Damper pedal 22
Damper Resonance 22
Delete (Song Edit) 147
Deleting
 A song 119
 User Style 159
[DigiScore] button 87
Disc Tray 17, 78
Divisions 57
Drum Set List 205
Drums 29
Dynamic Emphasis 43

E

Echo 48
Editing 145
Effects 46
Effects List 209
EffectsPart 179
Eject Button 78
 CD Drive 17
Emergency Eject Hole 78
Emergency eject hole 17
Ending 57, 66
Equalizer 44
Erase (Song Edit) 148
Erasing
 Performance on specific tracks 111
 Recorded performance 111
Error Messages 201
Export 92
Expression Pedal 185
Ext Display Connector 16
Ext Display connector 24, 186
External Display 24, 185–186
External Memory 113

F			
Factory Reset	172	Memory Backup	171
Factory Setting		Metronome	54
Touch Screen	175	Beat	55
User Memory	180	Pattern	56
Favorites	82, 116	Sound	55
Registering	82	Volume	55
Removing	83	[Metronome] button	54
Fill In	68	Mic Jack	16
Fill In To Original	57	Mic jack	23
Fill In To Variation	57	[Mic Volume] knob	23
Finger Numbers	90	Mic Volume Knob	16
Format	114	Microphone	23
[Fwd] button	76	MIDI	188
		MIDI Connector	188
G		MIDI Connectors	16
General MIDI	217	MIDI Devices	188
General MIDI 2	217	MIDI Ensemble	189
GS	217	MIDI Settings	189
GS Format	217	Minus One	97
		Mix Recording	141
H		Moving Key	175–176
Harmonist	49	Multitrack Recording	136
Harmony	70	Music Files	52
Headphones	23	Music Holder	20
		Music Style	57
I		On External Memory	63
Icon	26	Rhythm Pattern	64
i-format	118	Music Style Buttons	61
Input Jacks	16, 192	Music Style List	210
Insert (Song Edit)	147	Mute	97, 137
Internal Song List	214		
Intro	57, 65	N	
[Intro/Ending] button	65	New Song	105
		Notation	87
K		Saving as image data	92
Karaoke	53	Settings	89
Key	91	Note Edit (Song Edit)	149
Key Touch	161		
		O	
L		Octave Shift	33
Language	170	One Touch Program [Arranger] button	58
Layer	31	One Touch Program [Piano] button	27
Layer tone	31	One Touch Settings	162
LCD Contrast knob	16	One-Touch Arranger	58
Leading bass	168	Settings	161
Local Control	190	One-Touch Piano	27
Loop Recording	141	Opening Message	171
Lower Tone	71	Original	57
Lyrics	26, 90, 182	[Original] button	68
		Output Jacks	192
M			
Main Output Jacks	16, 192	P	
Manual Punch-In/Out	142	Panel Lock	181
Marker	98, 164	Part Balance	73
Erasing	99	[Part Balance] button	73
Moving	100	Part Exchange (Song Edit)	149
Placing	98	PC Edit (Song Edit)	150
Repeat	101	Pedal	22, 91
Master Tuning	170	Pedal Cable	21
Melody Intelligence	70	Pedal Connector	16
[Melody Intelligence] button	70	Pedal connector	21
		Pedal jack	185
		Pedal Settings	167

Percussion	29	Effects screen	46
Performance Pad	69, 167	Equalizer screen	44–45
Phones jack	23	File screen	114
Phones Jacks	16	Functions screen	165
Piano	27	Load User Program screen	132
Piano Screen	25	Marker screen	98
Pickup	112	Melody Intelligence screen	70
Pitches	90	Metronome screen	54
Play Mode	182	MIDI Setting Screen	189
[Play/Stop] button	76	Notation screen	87
Playing	75	Part Balance screen	73
All of the internal songs	75	PEDAL screen	134
At a fixed tempo (Tempo Mute)	95	Piano screen	25, 27
In random	75	Program Change Screen	189
Repeat	101	Rec Mode screen	140
Songs on CDs	77	Rename screen	117, 130, 158
Power On and Off	21	Reverb screen	34
[Power] switch	21	Save Song screen	116
Preset	61	Save Style screen	158
Program Change	191	Save User Program screen	131
PU (Pickup)	112	Song Edit screen	145
Punch-in Recording	142	Song Search screen	81
		Song Selection screen	75
Q		Style Composer screen	154
Quantize (Song Edit)	146	Style Converter screen	156
Quick Tour		Style Search screen	62
Automatically starting	180	Style Selection screen	61
		Surround screen	36
R		Tone search screen	30
Rec Mode	111, 140	Tone selection screen	28
Record/Playback Buttons	76	Transpose screen	102
Recording	104	User Program screen	130
16-Track Sequencer	139	Vocal Effects screen	47
A new song	105	Write User Program screen	130
Along with a Song	109		
Redoing recordings	110	Search	
Track buttons	110	Music Style	62
With Accompaniment	107	Song	81
Remote Control	84–85, 172	Tone	30
Repeat	101	Slide Show	178
Replace Recording	140	SMF	217
[Reset] button	76	SMF Music files	217
Resolution	91	Soft pedal	22
Restoring the Factory Settings	172	Solo	137
Reverb	34	Song Search	81
Root note	59	Sostenuto pedal	22
Rotary effect	168	[Sound Control] button	44
		Sound Effects	29
S		Sound Generator	217
Saving	116	Split	72
User Style	158	Split Point	162
Screens		[Start/Stop] button	65
16-track Sequencer screen	136	Stretch Tuning	166
Basic screen	25, 58	Style Composer	153
Chord Sequencer screen	143	Style Converter	155
Copy Song screen	120	Style Orchestrator	69
Copy Style screen	160	[Style Orchestrator] button	69
Copy User Programs screen	133	Style Search	62
Count settings screen	96	Surround	36
Countdown settings screen	67	Sync Start	65
Delete Song screen	119		
Delete Style screen	159		
Delete User Program screen	133		

T	[Volume] knob	22
	X	
Tap Tempo	XG lite	217
Television	Z	
Temperament	Zoom	90
Tempo		
Tempo [-] [+] buttons		
Tempo Mute		
Tempo Recording		
Tone Buttons		
Tone List		
Tone Search		
Tone Set		
Topslip		
Topsticks		
Touch Screen		
Touch the Notes		
Track Assign		
Track Buttons		
Transformer		
Transpose		
Transpose (Song Edit)		
[Transpose] button		
Troubleshooting		
Tuning		
Tuning Curve		
Tx Channel		
U		
Undo (Song Edit)		
Upper tone		
USB Connector		
USB Driver		
User Functions		
User Image Display		
User Memory		
Formatting		
User Program		
Calling up		
Copying		
Deleting		
Loading		
Registering		
Saving		
Transmitting PC Numbers		
User Style		
Copying		
Deleting		
Saving		
V		
Variation		
[Variation] button		
Video Out Jack		
V-LINK		
Vocal Count-In		
Vocal Effect		
[Vocal Effect] button		
Vocal Keyboard		
Volume		
Metronome		
Microphone		
Overall		
Remote Control		

Information

When you need repair service, call your nearest Roland Service Center or authorized Roland distributor in your country as shown below.

AFRICA

EGYPT

Al Fanny Trading Office
9, EBN Hagar A1 Askalany Street,
ARD El Golf, Heliopolis,
Cairo 11341, EGYPT
TEL: 20-2-417-1828

REUNION

Maison FO - YAM Marcel
25 Rue Jules Hermann,
Chaudron - BP79 97 491
Ste Clotilde Cedex,
REUNION ISLAND
TEL: (0262) 218-429

SOUTH AFRICA

That Other Music Shop(PTY)Ltd.
11 Melle St., Braamfontein,
Johannesburg,
SOUTH AFRICA
TEL: (011) 403 4105
FAX: (011) 403 1234

Paul Bothner(PTY)Ltd.

Royal Cape Park, Unit 24
Londonderry Road, Ottery 7800
Cape Town, SOUTH AFRICA
TEL: (011) 799 4900

ASIA

CHINA

Roland Shanghai Electronics Co.,Ltd.
5F, No.1500 Pingliang Road
Shanghai 200090, CHINA
TEL: (021) 5580-0800

Roland Shanghai Electronics Co.,Ltd.

(BEIJING OFFICE)
10F, No.18 3 Section Anhuaxili
Chaoyang District Beijing
100011 CHINA
TEL: (010) 6426-5050

Roland Shanghai Electronics Co.,Ltd.

(GUANGZHOU OFFICE)
2/F., No.30 Si You Nan Er Jie
Yi Xiang, Wu Yang Xin Cheng,
Guangzhou 510600, CHINA
TEL: (020) 8736-0428

HONG KONG

Tom Lee Music Co., Ltd.
Service Division
22-32 Pun Shan Street, Tsuen
Wan, New Territories,
HONG KONG
TEL: 2415 0911

Parsons Music Ltd.

8th Floor, Railway Plaza, 39
Chatham Road South, T.S.T,
Kowloon, HONG KONG
TEL: 2333 1863

INDIA

Rivera Digitec (India) Pvt. Ltd.
409, Nirman Kendra
Mahalaxmi Flats Compound
Off. Dr. Edwin Moses Road,
Mumbai-400011, INDIA
TEL: (022) 2493 9051

INDONESIA

PT Citra IntiRama
Jl. Cideng Timur No. 15J-150
Jakarta Pusat
INDONESIA
TEL: (021) 6324170

KOREA

Cosmos Corporation
1461-9, Seocho-Dong,
Seocho Ku, Seoul, KOREA
TEL: (02) 3486-8855

MALAYSIA

Roland Asia Pacific Sdn. Bhd.
45-1, Block C2, Jalan PJU 1/39,
Dataran Prima, 47301 Petaling
Jaya, Selangor, MALAYSIA
TEL: (03) 7805-3263

PHILIPPINES

G.A. Yupangco & Co. Inc.
339 Gil J. Puyat Avenue
Makati, Metro Manila 1200,
PHILIPPINES
TEL: (02) 899 9801

SINGAPORE

SWEE LEE MUSIC COMPANY PTE. LTD.
150 Sims Drive,
SINGAPORE 387381
TEL: 6846-3676

TAIWAN

ROLAND TAIWAN ENTERPRISE CO., LTD.
Room 5, 9fl. No. 112 Chung
Shan N.Road Sec.2, Taipei,
TAIWAN, R.O.C.
TEL: (02) 2561 3339

THAILAND

Theera Music Co., Ltd.
330 Soi Verg NakornKasem,
New Road, Sumpantawongse,
Bangkok 10100, THAILAND
TEL: (02) 224-8821

VIETNAM

SAIGON MUSIC DISTRIBUTOR (TAN DINH MUSIC)
138 Tran Quang Khai Street
Dist. 1, Ho Chi Minh City
VIETNAM
TEL: (08) 848-4068

AUSTRALIA/NEW ZEALAND

AUSTRALIA/NEW ZEALAND

Roland Corporation Australia Pty.,Ltd.
38 Campbell Avenue
Dee Why West. NSW 2099
AUSTRALIA

For Australia

TEL: (02) 9982 8266

For New Zealand

TEL: (09) 3098 715

CENTRAL/LATIN AMERICA

ARGENTINA

Instrumentos Musicales S.A.
Av.Santa Fe 2055
(1123) Buenos Aires
ARGENTINA
TEL: (011) 4508-2700

BARBADOS

A&B Music Supplies LTD
12 Webster Industrial Park
Wilkey, St.Michael, Barbados
TEL: (246)430-1100

BRAZIL

Roland Brasil Ltda.
Rua San Jose, 780 Sala B
Parque Industrial San Jose
Cotia - Sao Paulo - SP, BRAZIL
TEL: (011) 4615 5666

CHILE

Comercial Fancy II S.A.
Rut.: 96.919.420-1
Natanuel Cox #739, 4th Floor
Santiago - Centro, CHILE
TEL: (02) 688-9540

COLOMBIA

Centro Musica Ltda.
Cra 43 B No 25 A 41 Bododega 9
Medellin, Colombia
TEL: (574)3812529

COSTA RICA

JUAN Banschbach Instrumentos Musicales
Ave.1. Calle 11, Apartado 10237,
San Jose, COSTA RICA
TEL: 258-0211

CURACAO

Zeelandia Music Center Inc.
Orionweg 30
Curacao, Netherland Antilles
TEL:(305)5926866

DOMINICAN REPUBLIC

Instrumentos Fernando Giraldez
Calle Proyecto Central No.3
Ens.La Esperilla
Santo Domingo,
Dominican Republic
TEL:(809) 683 0305

ECUADOR

Mas Musica
Rumichaca 822 y Zaruma
Guayaquil - Ecuador
TEL:(593-4)2302364

EL SALVADOR

OMNI MUSIC
75 Avenida Norte y Final
Alameda Juan Pablo II,
Edificio No.4010 San Salvador,
EL SALVADOR
TEL: 262-0788

GUATEMALA

Casa Instrumental
Calzada Roosevelt 34-01,zona 11
Ciudad de Guatemala
Guatemala
TEL:(502) 599-2888

HONDURAS

Almaec Pajaro Azul S.A. de C.V.
BO.Paz Barahona
3 Ave.11 Calle S.O
San Pedro Sula, Honduras
TEL: (504) 553-2029

MARTINIQUE

Musique & Son
Z.L.Les Mangle
97232 Le Lamantin
Martinique F.W.I.
TEL: 596 596 426860

Gigamusic SARL

10 Rte De La Folie
97200 Fort De France
Martinique F.W.I.
TEL: 596 596 715222

MEXICO

Casa Veerkamp, s.a. de c.v.
Av. Toluca No. 323, Col. Olivar
de los Padres 01780 Mexico
D.F. MEXICO
TEL: (55) 5668-6699

NICARAGUA

Banschbach Instrumentos Musicales Nicaragua
Altamira D'Este Calle Principal
de la Farmacia 5ta.Avenida
1 Cuadra al Lago.#503
Managua, Nicaragua
TEL: (505)277-2557

PANAMA

SUPRO MUNDIAL, S.A.
Boulevard Andrews, Albrook,
Panama City, REP. DE
PANAMA
TEL: 315-0101

PARAGUAY

Distribuidora De Instrumentos Musicales
J.E. Olear y ESQ. Manduvira
Asuncion PARAGUAY
TEL: (595) 21 492147

PERU

Audionet
Distribuciones Musicales SAC
Juan Fanning 530
Miraflores
Lima - Peru
TEL: (511) 4461388

TRINIDAD

AMR Ltd
Ground Floor
Maritime Plaza
Barataria Trinidad W.I.
TEL: (868) 638 6385

URUGUAY

Todo Musica S.A.
Francisco Acuna de Figueroa
1771
C.P.: 11.800
Montevideo, URUGUAY
TEL: (02) 924-2335

VENEZUELA

Instrumentos Musicales Allegro,C.A.
Av.las industrias edf.Guitar
import
#7 zona Industrial de Turomo
Caracas, Venezuela
TEL: (212) 244-1122

EUROPE

AUSTRIA

Roland Elektronische Musikinstrumente HmbH.
Austrian Office
Eduard-Bodem-Gasse 8,
A-6020 Innsbruck, AUSTRIA
TEL: (0512) 26 44 260

BELGIUM/FRANCE/HOLLAND/LUXEMBOURG

Roland Central Europe N.V.
Houtstraat 3, B-2260, Oevel
(Westerlo) BELGIUM
TEL: (014) 575811

CZECH REP.

K-AUDIO
Kardasovska 62a.
CZ-198 00 Praha 9,
CZECH REP.
TEL: (2) 666 10529

DENMARK

Roland Scandinavia A/S
Nordhavnsvej 7, Postbox 880,
DK-2100 Copenhagen
DENMARK
TEL: 3916 6200

FINLAND

Roland Scandinavia As, Filial Finland
Elannontie 5
FIN-01510 Vantaa, FINLAND
TEL: (09) 68 24 020

GERMANY

Roland Elektronische Musikinstrumente HmbH.
Oststrasse 96, 22844
Norderstedt, GERMANY
TEL: (040) 52 60090

GREECE

STOLLAS S.A.
Music Sound Light
155, New National Road
Patras 26442, GREECE
TEL: 2610 435400

HUNGARY

Roland East Europe Ltd.
Warehouse Area 'DEPO' Pf.83
H-2046 Torokbalint,
HUNGARY
TEL: (23) 511011

IRELAND

Roland Ireland
G2 Calmout Park, Calmout
Avenue, Dublin 12
Republic of IRELAND
TEL: (01) 4294444

ITALY

Roland Italy S. p. A.
Viale delle Industrie 8,
20020 Arese, Milano, ITALY
TEL: (02) 937-78300

NORWAY

Roland Scandinavia Avd.
Kontor Norge
Lillekerveien 2 Postboks 95
Lilleaker N-0216 Oslo
NORWAY
TEL: 2273 0074

POLAND

MX MUSIC SP.Z.O.O.
UL. Gibraltarska 4.
PL-03664 Warszawa POLAND
TEL: (022) 679 44 19

PORTUGAL

Roland Iberia, S.L. Portugal Office
Cais das Pedras, 8/9-1 Dto
4050-465, Porto, PORTUGAL
TEL: 22 608 00 60

ROMANIA

FBS LINES
Piata Libertatii 1,
535500 Gheorgheni,
ROMANIA
TEL: (266) 364 609

RUSSIA

MuTek
Dorozhnaya ul.3,korp.6
117 545 Moscow, RUSSIA
TEL: (095) 981-4967

SPAIN

Roland Iberia, S.L.
Paseo Garcia Faria, 33-35
08005 Barcelona SPAIN
TEL: 93 493 91 00

SWEDEN

Roland Scandinavia A/S
SWEDISH SALES OFFICE
Danvik Center 28, 2 tr.
S-131 30 Nacka SWEDEN
TEL: (08) 702 00 20

SWITZERLAND

Roland (Switzerland) AG
Landstrasse 5, Postfach,
CH-4452 Itingen,
SWITZERLAND
TEL: (061) 927-8383

UKRAINE

TIC-TAC
Mira Str. 19/108
P.O. Box 180
295400 Munkachevo,
UKRAINE
TEL: (03131) 414-40

UNITED KINGDOM

Roland (U.K.) Ltd.
Atlantic Close, Swansea
Enterprise Park, SWANSEA
SA7 9EJ,
UNITED KINGDOM
TEL: (01792) 702701

MIDDLE EAST

BAHRAIN

Moon Stores
No.16, Bab Al Bahrain Avenue,
P.O.Box 247, Manama 304,
State of BAHRAIN
TEL: 17 211 005

CYPRUS

Radex Sound Equipment Ltd.
17, Diagorou Street, Nicosia,
CYPRUS
TEL: (022) 66-9426

IRAN

MOCO INC.
No.41 Nike St., Dr.Shariyati Ave.,
Roberoye Cerah Mirdamad
Tehran, IRAN
TEL: (021) 285-4169

ISRAEL

Halilit P. Greenspoon & Sons Ltd.
8 Retziv Ha'aliya Hashnya St.
Tel-Aviv-Yafo ISRAEL
TEL: (03) 6823666

JORDAN

MUSIC HOUSE CO. LTD.
FREDDY FOR MUSIC
P. O. Box 922846
Amman 11192 JORDAN
TEL: (06) 5692696

KUWAIT

EASA HUSAIN AL-YOUSIFI & SONS CO.
Abdullah Salem Street,
Safat, KUWAIT
TEL: 243-6399

LEBANON

Chahine S.A.L.
Gerge Zeidan St., Chahine
Bldg., Achrafieh, P.O.Box: 16-
5857
Beirut, LEBANON
TEL: (01) 20-1441

OMAN

TALENTZ CENTRE L.L.C.
Malatan House No.1
Al Noor Street, Ruwi
SULTANATE OF OMAN
TEL: 2478 3443

QATAR

Al Emadi Co. (Badie Studio & Stores)
P.O. Box 62, Doha, QATAR
TEL: 4423-554

SAUDI ARABIA

aDawlah Universal Electronics APL
Corniche Road, Aldossary
Bldg., 1st Floor, Alkhobar,
SAUDI ARABIA

P.O.Box 2154, Alkhobar 31952
SAUDI ARABIA
TEL: (03) 898 2081

SYRIA

Technical Light & Sound Center
Rawda, Abdul Qader Jazairi St.
Bldg. No. 21, P.O.BOX 13520,
Damascus, SYRIA
TEL: (011) 223-5384

TURKEY

ZUHAL DIS TICARET A.S.
Galip Dede Cad. No.37
Beyoglu - Istanbul / TURKEY
TEL: (0212) 249 85 10

U.A.E.

Zak Electronics & Musical Instruments Co. L.L.C.
Zabeel Road, Al Sherooq Bldg.,
No. 14, Grand Floor, Dubai,
U.A.E.
TEL: (04) 3360715

NORTH AMERICA

CANADA

Roland Canada Music Ltd.
(Head Office)
5480 Parkwood Way
Richmond B. C., V6V 2M4
CANADA
TEL: (604) 270 6626

Roland Canada Music Ltd.

(Toronto Office)
170 Admiral Boulevard
Mississauga On L5T 2N6
CANADA
TEL: (905) 362 9707

U. S. A.

Roland Corporation U.S.
5100 S. Eastern Avenue
Los Angeles, CA 90040-2938,
U. S. A.
TEL: (323) 890 3700

For the USA

DECLARATION OF CONFORMITY Compliance Information Statement

Model Name : KR117M, KR115M & 115
Type of Equipment : Digital Piano
Responsible Party : Roland Corporation U.S.
Address : 5100 S. Eastern Avenue, Los Angeles, CA 90040-2938
Telephone : (323) 890-3700

For EU Countries



This product complies with the requirements of European Directives EMC 89/336/EEC and LVD 73/23/EEC.

For the USA

FEDERAL COMMUNICATIONS COMMISSION RADIO FREQUENCY INTERFERENCE STATEMENT

This equipment has been tested and found to comply with the limits for a Class B digital device, pursuant to Part 15 of the FCC Rules. These limits are designed to provide reasonable protection against harmful interference in a residential installation. This equipment generates, uses, and can radiate radio frequency energy and, if not installed and used in accordance with the instructions, may cause harmful interference to radio communications. However, there is no guarantee that interference will not occur in a particular installation. If this equipment does cause harmful interference to radio or television reception, which can be determined by turning the equipment off and on, the user is encouraged to try to correct the interference by one or more of the following measures:

- Reorient or relocate the receiving antenna.
- Increase the separation between the equipment and receiver.
- Connect the equipment into an outlet on a circuit different from that to which the receiver is connected.
- Consult the dealer or an experienced radio/TV technician for help.

This device complies with Part 15 of the FCC Rules. Operation is subject to the following two conditions:

- (1) This device may not cause harmful interference, and
- (2) This device must accept any interference received, including interference that may cause undesired operation.

Unauthorized changes or modification to this system can void the users authority to operate this equipment.
This equipment requires shielded interface cables in order to meet FCC class B Limit.

For Canada

NOTICE

This Class B digital apparatus meets all requirements of the Canadian Interference-Causing Equipment Regulations.

AVIS

Cet appareil numérique de la classe B respecte toutes les exigences du Règlement sur le matériel brouilleur du Canada.



04017912 '06-03-3N