

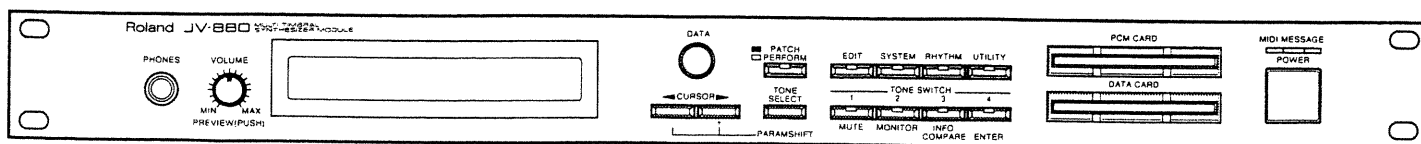

Roland

MULTI TIMBRAL SYNTHESIZER MODULE

JV-880

OWNER'S MANUAL



	CAUTION RISK OF ELECTRIC SHOCK DO NOT OPEN	
ATTENTION : RISQUE DE CHOC ELECTRIQUE NE PAS OUVRIR		
CAUTION: TO REDUCE THE RISK OF ELECTRIC SHOCK, DO NOT REMOVE COVER (OR BACK). NO USER-SERVICEABLE PARTS INSIDE. REFER SERVICING TO QUALIFIED SERVICE PERSONNEL.		



The lightning flash with arrowhead symbol, within an equilateral triangle, is intended to alert the user to the presence of un-insulated "dangerous voltage" within the product's enclosure that may be of sufficient magnitude to constitute a risk of electric shock to persons.



The exclamation point within an equilateral triangle is intended to alert the user to the presence of important operating and maintenance (servicing) instructions in the literature accompanying the product.

INSTRUCTIONS PERTAINING TO A RISK OF FIRE, ELECTRIC SHOCK, OR INJURY TO PERSONS.

IMPORTANT SAFETY INSTRUCTIONS

WARNING — When using electric products, basic precautions should always be followed, including the following:

1. Read all the instructions before using the product.
2. Do not use this product near water — for example, near a bathtub, washbowl, kitchen sink, in a wet basement, or near a swimming pool, or the like.
3. This product should be used only with a cart or stand that is recommended by the manufacturer.
4. This product, either alone or in combination with an amplifier and headphones or speakers, may be capable of producing sound levels that could cause permanent hearing loss. Do not operate for a long period of time at a high volume level or at a level that is uncomfortable. If you experience any hearing loss or ringing in the ears, you should consult an audiologist.
5. The product should be located so that its location or position does not interfere with its proper ventilation.
6. The product should be located away from heat sources such as radiators, heat registers, or other products that produce heat.
7. Avoid using the product where it may be affected by dust.
8. The product should be connected to a power supply only of the type described in the operating instructions or as marked on the product.
9. The power-supply cord of the product should be unplugged from the outlet when left unused for a long period of time.
10. Do not tread on the power-supply cord.
11. Do not pull the cord but hold the plug when unplugging.
12. When setting up with any other instruments, the procedure should be followed in accordance with instruction manual.
13. Care should be taken so that objects do not fall and liquids are not spilled into the enclosure through openings.
14. The product should be serviced by qualified service personnel when:
 - A. The power-supply cord or the plug has been damaged; or
 - B. Objects have fallen, or liquid has been spilled into the product; or
 - C. The product has been exposed to rain; or
 - D. The product does not appear to operate normally or exhibits a marked change in performance; or
 - E. The product has been dropped, or the enclosure damaged.
15. Do not attempt to service the product beyond that described in the user-maintenance instructions. All other servicing should be referred to qualified service personnel.

For Canada

For Polarized Attachment Plug

CAUTION: TO PREVENT ELECTRIC SHOCK, MATCH WIDE BLADE OF PLUG TO WIDE SLOT, FULLY INSERT.

ATTENTION: POUR ÉVITER LES CHOCs ÉLECTRIQUES, INTRODUIRE LA LAME LA PLUS LARGE DE LA FICHE DANS LA BORNE CORRESPONDANTE DE LA PRISE ET POUSSER JUSQU' AU FOND.

SAVE THESE INSTRUCTIONS

For the U.K.

WARNING: THIS APPARATUS MUST BE EARTHED

IMPORTANT: THE WIRES IN THIS MAINS LEAD ARE COLOURED IN ACCORDANCE WITH THE FOLLOWING CODE.
 GREEN-AND-YELLOW: EARTH, BLUE: NEUTRAL, BROWN: LIVE

As the colours of the wires in the mains lead of this apparatus may not correspond with the coloured markings identifying the terminals in your plug proceed as follows:

The wire which is coloured GREEN-AND-YELLOW must be connected to the terminal in the plug which is marked by the letter E or by the safety earth symbol  or coloured GREEN or GREEN-AND-YELLOW.

The wire which is coloured BLUE must be connected to the terminal which is marked with the letter N or coloured BLACK.

The wire which is coloured BROWN must be connected to the terminal which is marked with the letter L or coloured RED.

The product which is equipped with a THREE WIRE GROUNDING TYPE AC PLUG must be grounded.

Thank you for purchasing the Roland JV-880 Multi Timbral Synthesizer Module. To take full advantage of this module, and to ensure years of trouble-free service, please read this manual carefully.

CONTENTS

■ IMPORTANT NOTES	IV	■ MIDI CONTROL	2-9
■ FEATURES	VII	● Receiving MIDI Data	2-9
■ MANUAL ORGANIZATION	VIII	● Changing Patches	2-10
■ PANEL CONTROLS AND TERMINALS	IX	● Changing Performances	2-10
		● Main MIDI Messages Handled by the JV-880	2-11
		■ MODES	2-14

Section 1

SET UP/LISTENING TO THE SOUNDS

1. PREPARATIONS	1-1
● Connection	1-1
● Turning On the Power	1-2
● Display Contrast	1-3
2. PLAYING THE DEMO SONGS	1-4
3. PLAYING THE SOUNDS	1-7

Section 2

OVERVIEW

■ THE JV'S SOUND UNITS	2-1
● Patches	2-1
● Performance	2-2
● Voices and Maximum Polyphony	2-3
■ MEMORY	2-4
■ CHORUS AND REVERB	2-6
■ OUTPUT	2-7

Section 3

PLAYING PATCHES

PATCH PLAY MODE

■ WHAT IS THE PATCH PLAY MODE?	3-1
■ OPERATION GUIDE	3-2
Changing patch	3-2
Changing Parameter Settings	3-3
Switching Tones On and Off	3-4
Preview Function	3-5
Storing Edited Patches	3-5
■ PATCH PLAY MODE PARAMETERS	3-6

Section 4

PLAYING PERFORMANCES

PERFORMANCE PLAY MODE

■ WHAT IS THE PERFORMANCE PLAY MODE?	4-1
■ OPERATION GUIDE	4-2
Changing Performances	4-2
Changing the Patch/Part Assignments	4-3
Muting the Sound of a Part	4-4
Part Monitor	4-5
Preview Function	4-5

Monitoring MIDI Data Reception of a Part (Part Information)	4-6
Storing Edited Performances	4-7

Section 5
**EDITING SYSTEM COMMON
PARAMETERS**
SYSTEM EDIT MODE

■ WHAT IS THE SYSTEM EDIT MODE?	5-1
■ OPERATION GUIDE	5-2
■ PARAMETER FUNCTIONS	5-4

Section 6
EDITING PATCHES
PATCH EDIT MODE

■ WHAT IS THE PATCH EDIT MODE?	6-1
■ OPERATION GUIDE	6-3
Tone On/Off Switches	6-6
Preview Function	6-6
■ PARAMETER FUNCTIONS	6-7
Patch Common Parameters	6-7
Tone parameters	6-16

Section 7
EDITING PERFORMANCES
PERFORMANCE EDIT MODE

■ WHAT IS THE PERFORMANCE EDIT MODE? ..	7-1
■ OPERATION GUIDE	7-2
Preview Function	7-5
■ PARAMETER FUNCTIONS	7-6
Performance Common Parameters	7-6
Part Parameters	7-10

Section 8
EDITING RHYTHM TONES
RHYRHM EDIT MODE

■ WHAT IS THE RHYTHM EDIT MODE?	8-1
■ OPERATION GUIDE	8-2
Preview Function	8-5
■ PARAMETER FUNCTIONS	8-6

Section 9
**WRITE OPERATION ADDITIONAL
FUNCTIONS**
UTILITY MODE

■ THE UTILITY MODE	9-1
■ WRITE	9-2
Patch Write	9-3
Performance Write (Perf Write)	9-4
Rhythm Write	9-5
■ COPYING DATA	9-6
Patch Copy	9-6
Performance Copy (Perf copy)	9-7
Rhythm Copy	9-9
■ INITIALIZE	9-11
Patch Initialize	9-11
Performance Initialize (Perf Initialize)	9-11
Rhythm Initialize	9-12
■ DATA CARD	9-13
■ BULK DUMP	9-16
■ TEMPORARY DUMP	9-18
■ LOAD PATCH	9-19
Load Patch Single	9-19
Load Patch Group	9-20
■ MEMORY PROTECT	9-22
■ FACTORY PRESETS	9-23

Section 10

REFERENCE

■ ERROR MESSAGES (miscellaneous messages).....	10-1
■ TROUBLESHOOTING	10-4
■ PARAMETERS LIST	10-8
■ INITIALIZE DATA	10-14
■ WAVEFORMS LIST	10-18
■ FACTORY SETTINGS	10-19
■ BLANK CHART	10-25
Roland Exclusive Messages	10-30
MIDI Implementation.....	10-32
MIDI Implementation Chart	10-43
■ SPECIFICATIONS	10-44
■ INDEX OF FUNCTIONS AND OPERATIONS	10-45
■ INDEX.....	10-50
■ IINSTALLING THE EXPANSION BOARD.....	10-54

Copyright © 1992 by ROLAND CORPORATION

All rights reserved. No part of this publication may be reproduced in any form the permission of ROLAND CORPORATION.

In addition to the items listed under Safety Precautions on page II, please read and adhere to the following

Power supply

- When making any connections with other devices, always turn off the power to all equipment first; this will help prevent damage or malfunction.
- Do not use this unit on the same power circuit with any device that will generate line noise, such as a motor or variable lighting system.

Placement

- Using the unit near power amplifiers (or other equipment containing large transformers) may induce hum.
- This unit may interfere with radio and television reception. Do not use this unit in the vicinity of such receives.

Maintenance

- For everyday cleaning wipe the unit with a soft, dry cloth (or one that has been slightly dampened water). To remove stubborn dirt, use a mild, neutral detergent. Afterwards, be sure to wipe the unit thoroughly with a soft, dry cloth.
- Never use benzine, thinners, alcohol or solvents of any kind, to avoid the risk of discoloration and/or deformation.

Additional precautions

- Protect the unit from strong impact.
- Never strike or apply strong pressure to the display.
- A small amount of heat will radiate from the unit, and thus should be considered normal.
- Before using the unit in a foreign country, consult with qualified service personnel.

Memory backup

- The unit contains a battery which maintains the contents of memory while the main power is off. The expected life of this battery is 5 years or more. However, to avoid the unexpected loss of memory data, it is strongly recommended that you change the battery every 5 years. Please be aware that the actual life of the battery will depend on the physical environment (especially temperature) in which the unit is used. When it is time to change the battery, consult with qualified service personnel.
- When the battery becomes weak the following message will appear in the display: **"Internal battery low"**. Please change the battery as soon as possible to avoid the loss of memory data.
- Please be aware that the contents of memory may at times be lost; when the unit is sent for repairs or when by some chance a malfunction has occurred. Important data should be stored on a DATA (Memory) card, or written down on paper. During repairs, due care is taken to avoid the loss of data. However, in certain cases, (such as when circuitry related to memory itself is out of order) we regret that it may be impossible to restore the data.

FEATURES

● Wide Range of Waveforms

Naturally, the JV-880 contains all the basic synthesizer waveforms; sawtooth, square, pulse, etc. It also contains many special waveforms and digital samples.

As waveforms can be processed by FXM (Frequency Cross-Modulation), the JV-880 is capable of functioning in the most demanding of programming applications, from recreating acoustic instruments to generating unusual, otherworldly effects. Additional waveforms can be added by using optional PCM Cards (SO-PCM1 series) or an expansion board (SR-JV80 series).

● On-board Digital Effects

Rich stereo effects that add spaciousness and depth to the sound can be obtained by using the chorus and reverb sections.

● Multi-timbral Operation

The JV-880 features seven independent synthesizer Parts and one rhythm Part. This allows you to create ensemble performances with the JV's sound sources controlled via MIDI.

● Multiple Outputs

The JV-880 has two sets of stereo outputs: the MAIN OUTPUT and the SUB OUTPUT. Using these outputs allows you to apply external effects to individual sounds.

● Memory Cards

Internal settings can be stored for future use on optional Data Cards (Roland M-256E). Sound data stored on a Data Card can be selected at any time.

MANUAL ORGANIZATION

This manual is organized according to the following outline. We do recommend that you read the entire manual; however, if you have a basic knowledge of synthesizers, you may find it sufficient to refer only to specific sections.

Section 1	Set up/Listening to the sounds	This section explains set up and connection of the JV-880 for playing, use of the ROM play feature, and how to select and play the sound programs.
Section 2	Overview	This section covers the basic structure of the JV-880. You should read this no matter what level of experience with synthesizers you have.
Section 3	Playing Patches Patch Play Mode	These sections explain the operations of playing Patches or Performances.
Section 4	Playing Performances Performance Play Mode	
Section 5	Editing System Common Parameters System Edit Mode	These sections explain how the functions of the various parameters and how to change (or edit) them.
Section 6	Editing Patches Patch Edit Mode	
Section 7	Editing Performances Performance Edit Mode	
Section 8	Editing Rythm Tones Rhythm Edit Mode	
Section 9	Write operation Additional Functions Utility Mode	This section explains how to store (or write) the data you've created to memory, and covers other convenient functions used before editing operations.
Section 10	Reference	Includes Error Messages, Data list, MIDI Implementation chart.

●Designations and Conventions in this Manual

The panel buttons and controls are indicated by the characters and symbols printed above (or below) them.

[Examples]

- Edit button ⇒ **EDIT**
- System button ⇒ **SYSTEM**
- Cursor buttons ⇒ **◀CURSOR▶**
- Specific cursor button ⇒ **◀CURSOR** or **CURSOR▶**

PANEL CONTROLS AND TERMINALS

[Front Panel]

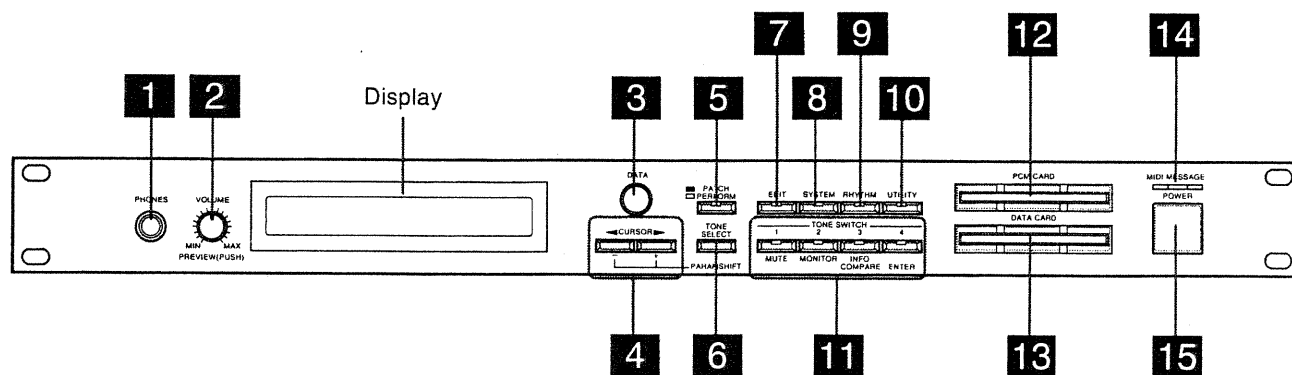

1 PHONES jack

Connect stereo headphones to this jack. We recommend the use of Roland RH-20/80/120 headphones (optional). The audio signal is output through the MAIN OUTPUT jacks even when headphones are connected.

2 VOLUME knob

This knob controls the unit's overall volume level: MAIN OUTPUT jacks and PHONES jack. Pressing this knob also triggers the currently selected sound (PREVIEW function).

3 DATA dial

This dial is used primarily to select Patches or change parameter values. Large changes occur if you press the dial in while rotating it. During editing, parameter changes can be cancelled by quickly pressing the dial twice.

4 CURSOR (+/-) buttons

These buttons move the cursor the flashing underline in the display which indicates where data can be entered or edited. During editing, parameters can be changed (regardless of the cursor position) by holding down the **PARAM SHIFT** button and pressing **+** or **-**.

5 PATCH/PERFORM button

This button is used to switch between the Patch Play mode and the Performance Play mode. The indicator lights when the Patch Play mode is selected.

6 TONE SELECT/PARAM SHIFT button

When in the Patch Edit mode, you can select the Tone you wish to edit by holding down this button and pressing the desired **TONE SWITCH** button. During editing, parameters can be changed (regardless of the cursor position) by holding down the **PARAM SHIFT** button and pressing **+** or **-**.

7 EDIT button

Pressing this button while in the Patch Play mode switches the unit to the Patch Edit mode. Likewise, pressing it from the Performance Play Mode switches the unit to the Performance Edit mode.

8 SYSTEM button

Pressing this button selects the System Edit mode, making it possible to change settings related to the overall operation of the JV-880 (master tuning, for example).

9 RHYTHM button

Pressing this button selects the Rhythm Edit mode. Rhythm settings can be set and the Rhythm Tone edited.

10 UTILITY button

Pressing this button selects the Utility mode. In this mode, edited data can be stored, copied, and transferred to (or from) optional memory cards.

11 TONE SWITCH buttons 1 — 4

These buttons turn the sound of a Tone on and off. From the Patch Edit mode, you can select the Tone you wish to edit by holding down the **TONE SELECT** button and pressing one of these buttons. These buttons function differently depending on the selected mode.

TONE SWITCH 1

From the Performance Play mode, this button functions as a Mute (**MUTE**) switch, allowing you to mute any Part.

TONE SWITCH 2

From the Performance Play mode, this button functions as a Monitor (**MONITOR**) switch, allowing you to hear any Part.

TONE SWITCH 3

From the Performance Play mode, this button functions as an Information (**INFO**) button, displaying the status of each Part. From the Utility mode, it functions as a Compare (**COMPARE**) button, allowing you to check the destination Patch before attempting to overwrite (replace) it with another Patch.

TONE SWITCH 4

From the Utility mode, this button functions as an enter (**ENTER**) button, allowing you to execute Write and Copy operations.

12 PCM CARD slot

Optional PCM Cards (SO-PCM1 series) can be inserted into this slot.

13 DATA CARD slot

Optional Data Cards (Roland M-256E etc.) can be inserted into this slot.

14 MIDI MESSAGE indicator

This indicator lights when MIDI messages are received.

15 POWER switch

This switch turns the unit on and off.

[Rear Panel]

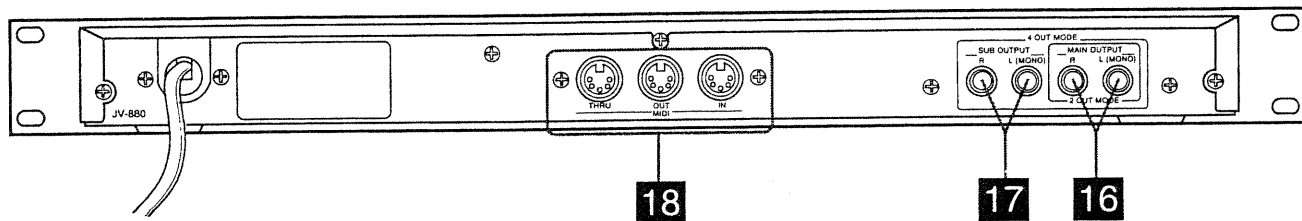

16 MAIN OUTPUT jacks

The enhanced stereo signal (processed by chorus/reverb) is output through these jacks. Connect an audio cable to the left L(MONO) jack when you need a mono output.

17 SUB OUTPUT jacks

The dry (no chorus/reverb) stereo signal is output through these jacks.

18 MIDI Connectors (IN/OUT/THRU)

These terminals allow the JV to be connected to other MIDI devices:

- MIDI IN : For receiving data from other MIDI devices.
- MIDI OUT : For transmitting internal data to other MIDI devices.
- MIDI THRU : For re-transmitting data received via the MIDI IN connector

Section

1

**SET UP /
LISTENING
TO THE SOUNDS**

1. PREPARATIONS

■ Connection

- * As neither an amplifier or speaker system is built into the JV-880, you should use some kind of amplification/speaker system to hear the unit.
- * When using the optional PJ-1M cable, the unit can be directly connected to the input jacks of a stereo set by removing the phone plug adaptors and using the RCA pin connectors.

When using the JV with an amp/speaker setup, be sure all the volume levels are set to zero before tuning your system on. This will help prevent damage to your speakers.

Plug any headphones you wish to use into the PHONES jack.

To take full advantage of the JV's great sound, use a stereo output whenever possible. If you require a mono output, connect an audio cable to the L (MONO) jack.

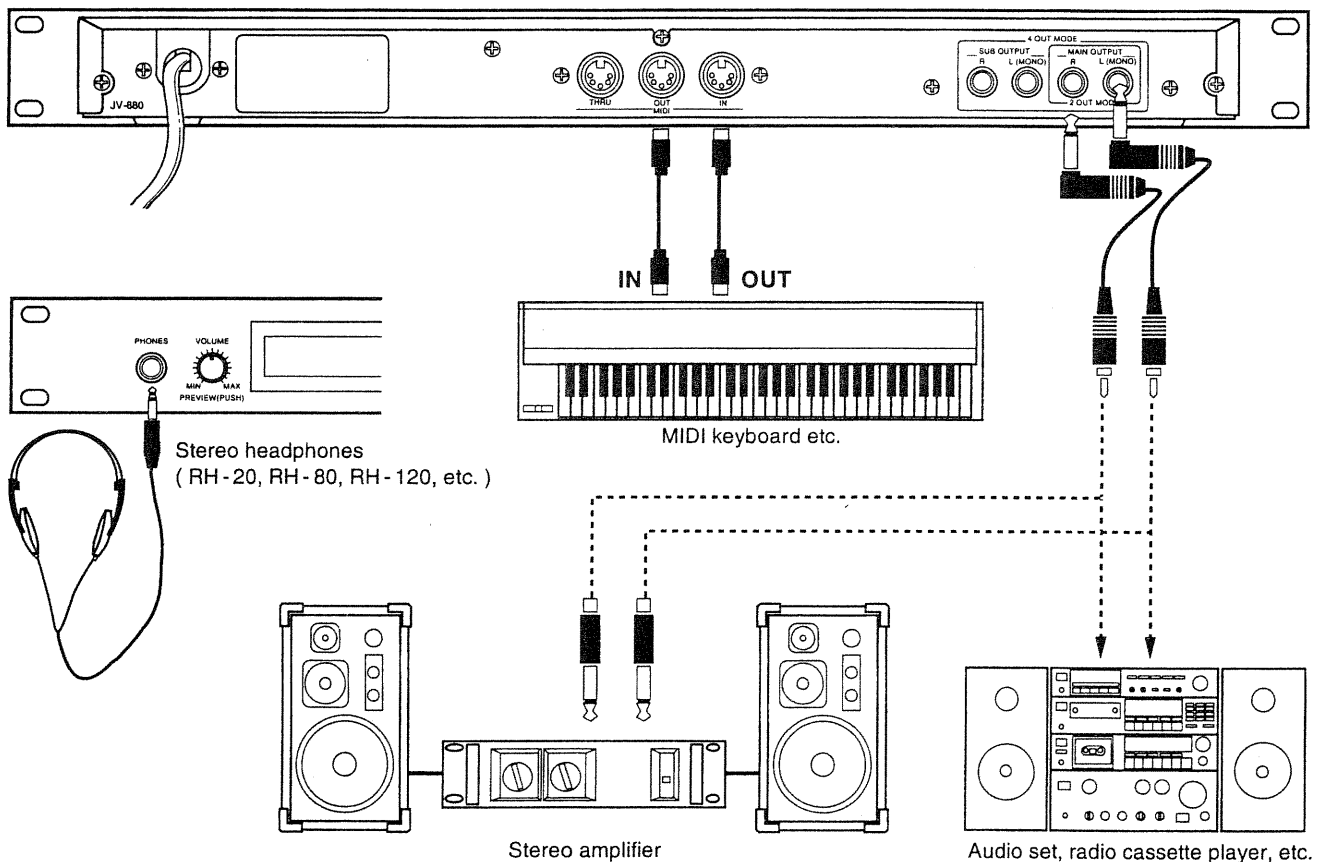

■ Turning On the Power

After making all necessary connections, turn on the power, observing the following steps.

[Operation]

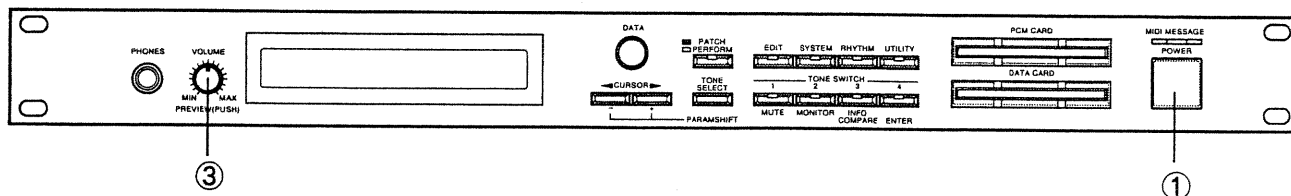

Check the following points before turning on the power.

- All connections have been made properly.
- The volume settings on connected amplifiers are set to the minimum level.
- The volume of the JV-880 is set to the minimum level.

① Turn on the JV-880.

The following display appears:

```
Perf  |1|2|3|4|5|6|7|8|
I-01:Syn Lead [U001]
```

- * The JV's protection circuitry will mute the output for a few seconds. No sound will be heard during this time.
- ② Turn on your amplifier, mixer, etc. Set the volume as required.
- ③ Set the JV-880's level with the **VOLUME** knob.
- * Power down your system in the reverse order, that is, turn the JV-880 off last.
 - * Excessive volume levels can damage your ears and your speakers. Take care when setting output levels.

■ Display Contrast

If the JV's display is difficult to read (because of poor lighting conditions or placement), adjust the display contrast:

[Operation]

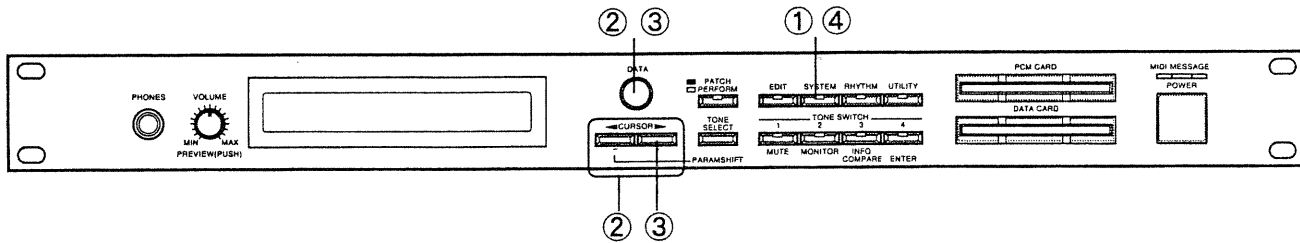

- ① Press **SYSTEM**. (The indicator lights.)
- ② Move the cursor to the parameter name by using **◀ CURSOR ▶**, and select "Display contrast" by rotating the **DATA** dial.

```
System
Display contrast=05
↑
Cursor
```

- ③ Move the cursor to the number field using **CURSOR ▶**, then adjust the contrast setting by rotating the **DATA** dial.

```
System
Display contrast=05
↑
Cursor
```

- ④ Press **SYSTEM** again when you are finished. (The indicator goes out.)

2. PLAYING THE DEMO SONGS

The JV-880 contains several demo songs that showcase the unit's capabilities. The ROM Play function automatically plays these songs. Again we recommend using a stereo system (or headphones) to fully appreciate the unit.

[Operation]

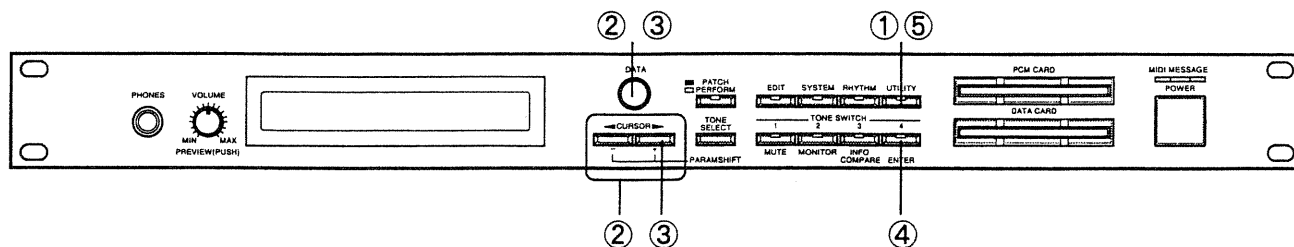

- ① Press **UTILITY**. (The indicator lights.)
- ② Move the cursor to the parameter name by using **◀ CURSOR ▶**, and select "ROM play" by rotating the **DATA** dial.

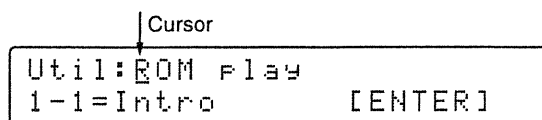

- ③ Move the cursor to the bottom left of the display using **CURSOR ▶**, then select a song by rotating the **DATA** dial.

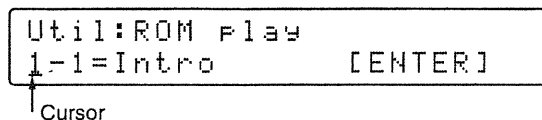

1-1	Intro	Songs 1 - 1 through 1 - 5 are parts that play back as a medley, and together form one whole song.
1-2	Guitars	
1-3	Synphony	
1-4	Piano Hop	
1-5	String Thing	
2	Lost Weekend	Music by Mitsuru Sakaue Copyright © 1992, Roland
3	The Race	Music by Chas Smith Copyright © 1992, Roland UK

- ④ Press **ENTER** to start playback.
Press **ENTER** again to stop playback.

- ⑤ Press **UTILITY** to return to the standard operating mode. (The indicator goes out.)
- * All other functions of the JV-880 are temporarily suspended during ROM Play. That is, with the exception of the buttons mentioned above, all other controls will have no affect.
- * The data of the ROM Play songs is not transmitted via the MIDI OUT connector.

● Composer Profiles

Marvin Sanders
As Keyboard Product Manager for Roland US, Marvin Sanders has performed at clinics all over the world. In between his involvement with their marketing and promotional efforts, he has created sounds for products from the JV-80 to the JD-800, factory patterns for the JW-50, and ROM-plays found in the SC-155, U-220, and Model 760. Marvin also maintains an active freelance career in Los Angeles, composing and consulting for a variety of clients from Toyota, Acura, and Alpine, to Max Factor and Michael Jackson.
Mitsuru Sakaue
Mitsuru Sakaue began composing and doing arrangements for commercials and videos while still in school. In particular, his studio work earned for him a solid reputation. Currently, as a chief producer within Idecs, Inc., he produces commercial musics and jingles for FM stations. His range of activity is broad, and includes his work as an instructor and expert on musical instruments/computer music for the Roland Learning Center(Japan), as well as for other schools. In addition, he has had numerous other opportunities for displaying his talents well while serving as demonstrator/product specialist for Roland.
Chas Smith
Roland UK's Senior Product Specialist/Demonstrator joined the company in 1987, after a free — lance career playing in rock bands. He is an active composer, principally for the jingle market. His particular interests lie in the use of the latest sampling technology, and in programming synthesizers.

* **Warning: All rights reserved. Unauthorized use of this material is a violation of applicable copyright laws.**

■ The chart below lists the Patches (Rhythm sets) used in each of the demo songs.

	Part	Patch (Rhythm Set)			
1 – 1 Intro	1	A14 : Stiky Rhodes	B28 : Harmon Mute2		
	2	B34 : Stab Brass			
	3	B25 : Trumpet			
	4	B45 : Flute mod			
	5	B26 : Trombone			
	6	A56 : RockOut Bass			
	7	A57 : Slap Bass	A49 : Fretless		
	8	PRA : PR- A RHYTHM			
1 – 2 Guitars	1	A38 : Velo Harmnix			
	2	A39 : Nylon+Steel			
	3	A11 : SA Rhodes			
	4				
	5				
	6				
	7	A58 : Thumpin Bass			
	8	PRA : PR- A RHYTHM			
1 – 3 Synthyony	1	B20 : Beauty Vox			
	2	B57 : Pizza Hutt			
	3	B23 : GlassVoices			
	4	B63 : RevCymBend			
	5	B19 : Arasian Morn			
	6	A23 : Wave Bells			
	7				
	8	PRB : PR- B RHYTHM			
1 – 4 Piano Hop	1				
	2	A01 : A.Piano 1			
	3				
	4				
	5	A63 : Rubber Bs 2			
	6				
	7	A60 : Wonder Bass			
	8	PRB : PR- B RHYTHM			
1 – 5 Sting Thing	1	B07 : St String			
	2	B06 : Marcato			
	3				
	4	B34 : Stab Brass			
	5	B02 : Real Pizz	B25 : Trumpet	B28 : Harmon Mute2	
	6	B45 : Flute mod			
	7				
	8	PRB : PR- B RHYTHM			
2 Lost Weekend	1	B38 : AltoLead Sax			
	2	A54 : House Bass			
	3	B30 : Brass Sect			
	4	A05 : Pop Piano 2			
	5	B48 : Air Lead			
	6	A46 : Funk Gtr			
	7	B05 : Warm Strings			
	8	PRB : PR- B RHYTHM			
3 The Race	1	B09 : Slow Strings	A14 : Stiky Rhodes	B59 : JP- 8 Pad	
	2	B18 : New Age Box	A64 : Stereoww Bass	B19 : Arasian Morn	
	3	B34 : Stab Brass	A01 : A.Piano 1	B30 : Brass Sect 1	B13 : Orch Stab 1
	4	B48 : Air Lead	B38 : AltoLead Sax		
	5	B50 : Log Drum			
	6	A53 : Analog Bs 1	A39 : Nylon+Steel		
	7	A28 : E.Organ 1	A59 : Pick Bass		
	8	PRA : PR- A RHYTHM			

3. PLATING THE SOUNDS

When shipped, the JV-880 contains a number of Patches, or preset sounds. In this section, we'll select and play some of these sounds.

[Operation]

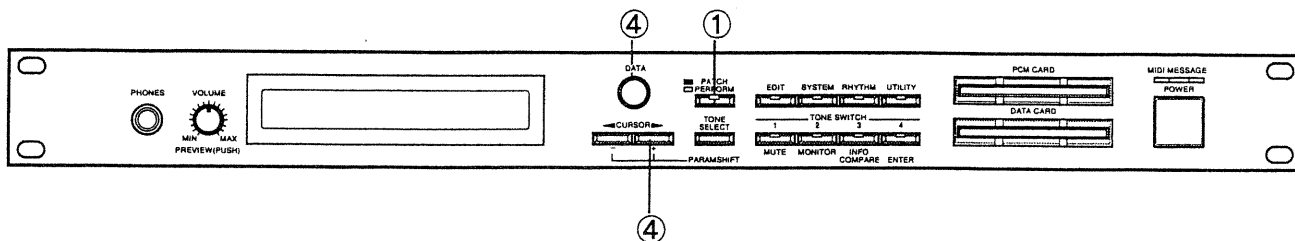

- ① Press **PATCH**. (The indicator lights.)
- ② Set the channel of the connected MIDI keyboard to 1.
- ③ Play the MIDI keyboard to hear the currently selected sound of the JV-880.
- ④ You can select the various Patches by moving the cursor to the Patch number using **CURSOR**, then rotating the **DATA** dial. The number and name of the currently selected Patch is displayed.

```

Patch          Rxch:01
I15:Analog Brass [U015]
  
```

↑ Patch number

The JV's Patches are divided into four groups:

The Internal and Preset groups are explained in Section 2 (See P.2-4).

I01 — 64	:	Internal
C01 — 64	:	Data Card (optional)
A01 — 64	:	Preset
B01 — 64	:	Preset

The different groups are selected by simultaneously pressing and rotating the **DATA** dial. Try selecting and playing Patches from the other groups.

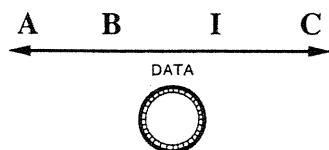

- * Patches from the "C" group can only be selected when a Data Card (optional) has been properly inserted into the DATA CARD slot.

Preview Function

One of the most convenient functions of the JV-880 is the Preview function. By pressing the **VOLUME** knob, the currently selected Patch can be heard. This allows you to hear the JV's sounds even if you don't have a MIDI keyboard handy.



※ You can set the pitch and volume of the preview sound as required. Refer to Section 5 (See P.5-13) for details.

MEMO

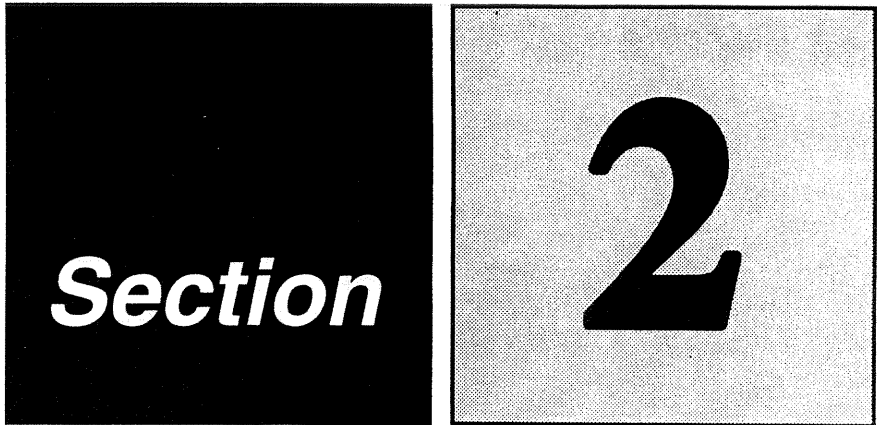

OVERVIEW

THE JV'S SOUND UNITS

The basic sound building blocks of the JV-880 are described in this section.

● Patches

The sound programs used in playing the instrument are called Patches. A single Patch is itself made up of several Tones.

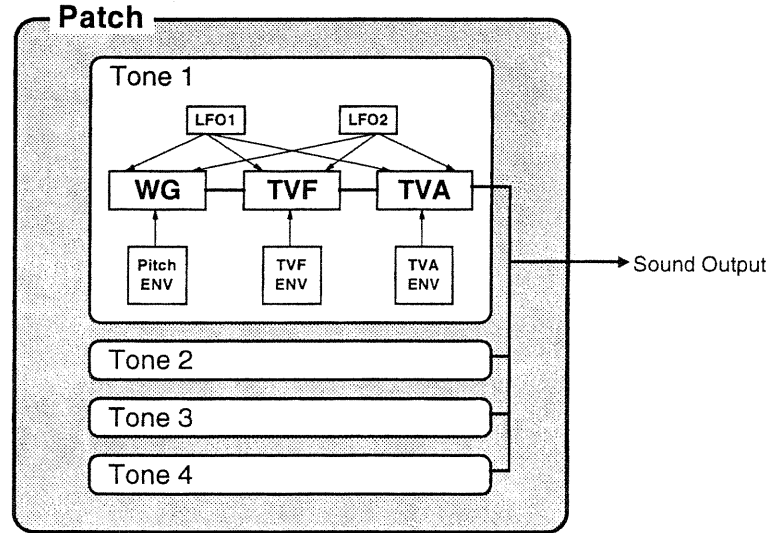

TONES

Tones are the basic sound elements used in creating Patches.

It is possible to create a Patch using only a single Tone; however, sounds of remarkable complexity and richness can be created by using up to four Tones in one Patch.

The structure of a Tone is shown below.

WG (Wave Generator)

The Wave Generator accesses a waveform stored in internal memory, on optional PCM Cards or expansion board, to be used as the basic sonic building block.

The Wave Generator also controls the pitch of the waveform at the same time. As the waveform is the basic sound unit, it is largely responsible for determining the character of the final sound.

TVF (Time Variant Filter)

This filter is used to process the sound program by cutting or boosting the frequency elements of the original waveform produced by the Wave Generator.

TVA (Time Variant Amplifier)

This filter controls the volume of the sound.

ENV (Envelope Generator)

The envelope generator is used to change pitch, frequency or volume over time, when used with the WG, TVF or TVA, respectively.

LFO (Low Frequency Oscillator)

This oscillator applies a periodic or regular change to the pitch, frequency or volume when used with the WG, TVF and TVA, respectively. It adds expression to the sound by creating various vibrato effects.

● Performance

A Performance is a collection of Patches and settings. A Performance contains several Patches, a Rhythm Set, and chorus/reverb settings. There are eight Parts (seven standard Parts and one rhythm Part) in a Performance.

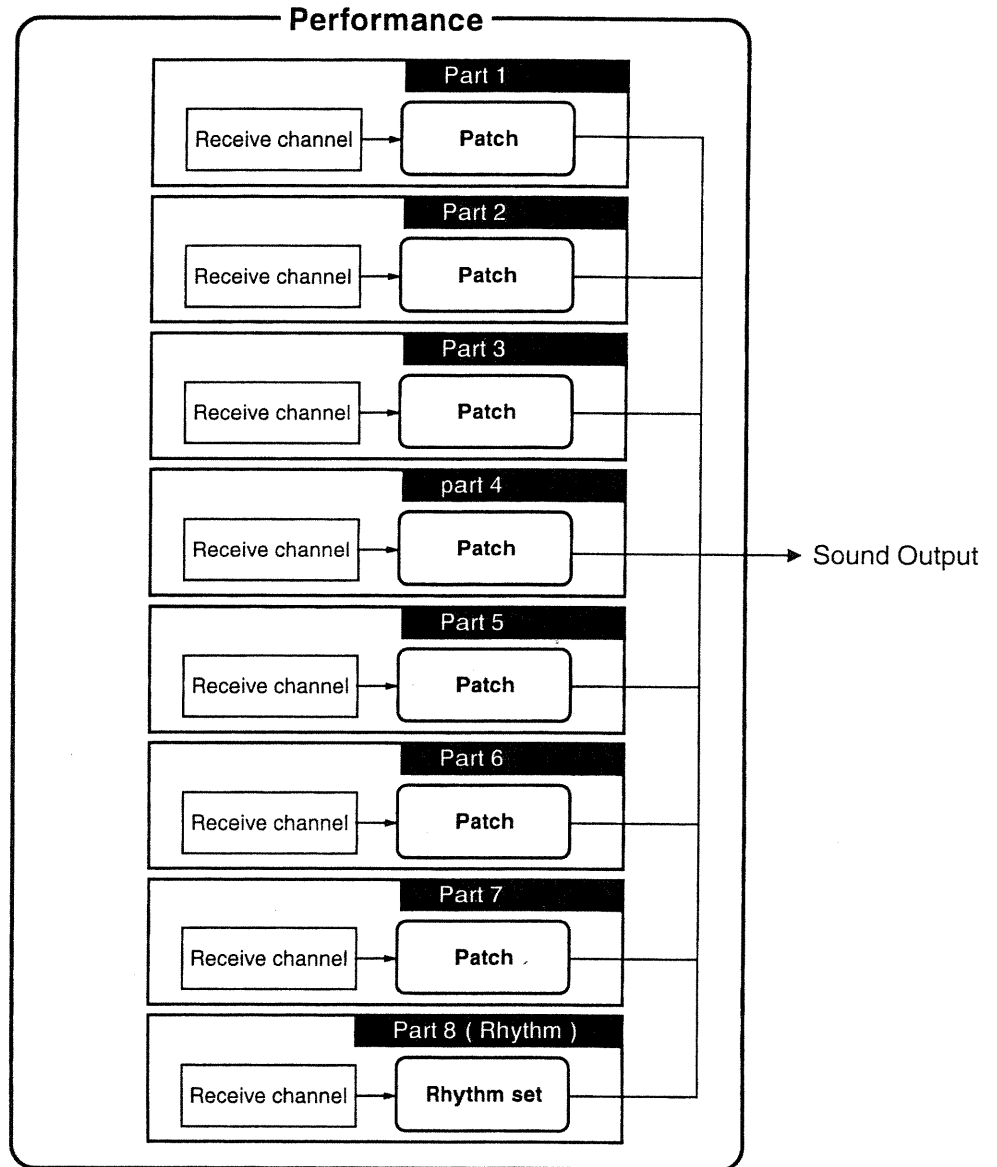

PART

Patches are assigned to Parts 1 — 7, and the Rhythm Set is assigned to Part 8. Each Part can be used as an independent sound module as each has its own MIDI channel.

Rhythm Set

In Parts 1 — 7, the pitch of the Patch depends on the note number. In the Rhythm Set, however, different percussion sounds are assigned to different note numbers. In other words, each rhythm or percussion sound is assigned to a different key on the keyboard. Each percussion sound in a Rhythm Set is called a Rhythm Tone.

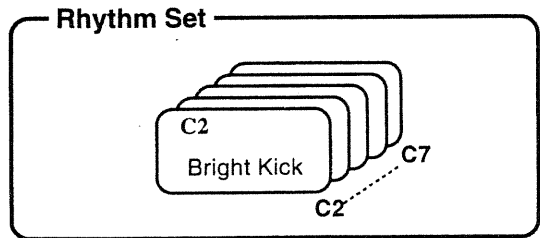

● Voices and Maximum Polyphony

Because of the complex sound generation system of the JV-880, there is a limit to the number of sounds that can be played simultaneously. This limit is called the maximum polyphony and it amounts to 28 sounds, or "voices." A single Tone requires one voice in order to be played. Therefore, when a Patch is made up of just one Tone, up to 28 notes can be played simultaneously. However, if a Patch is comprised of 4 Tones, each of which requires one voice to sound one note, the maximum number of notes that can be played simultaneously is reduced to 7.

MEMORY

The areas in which Performances, Patches and other data is stored is called memory. The JV-880 has the following memory types:

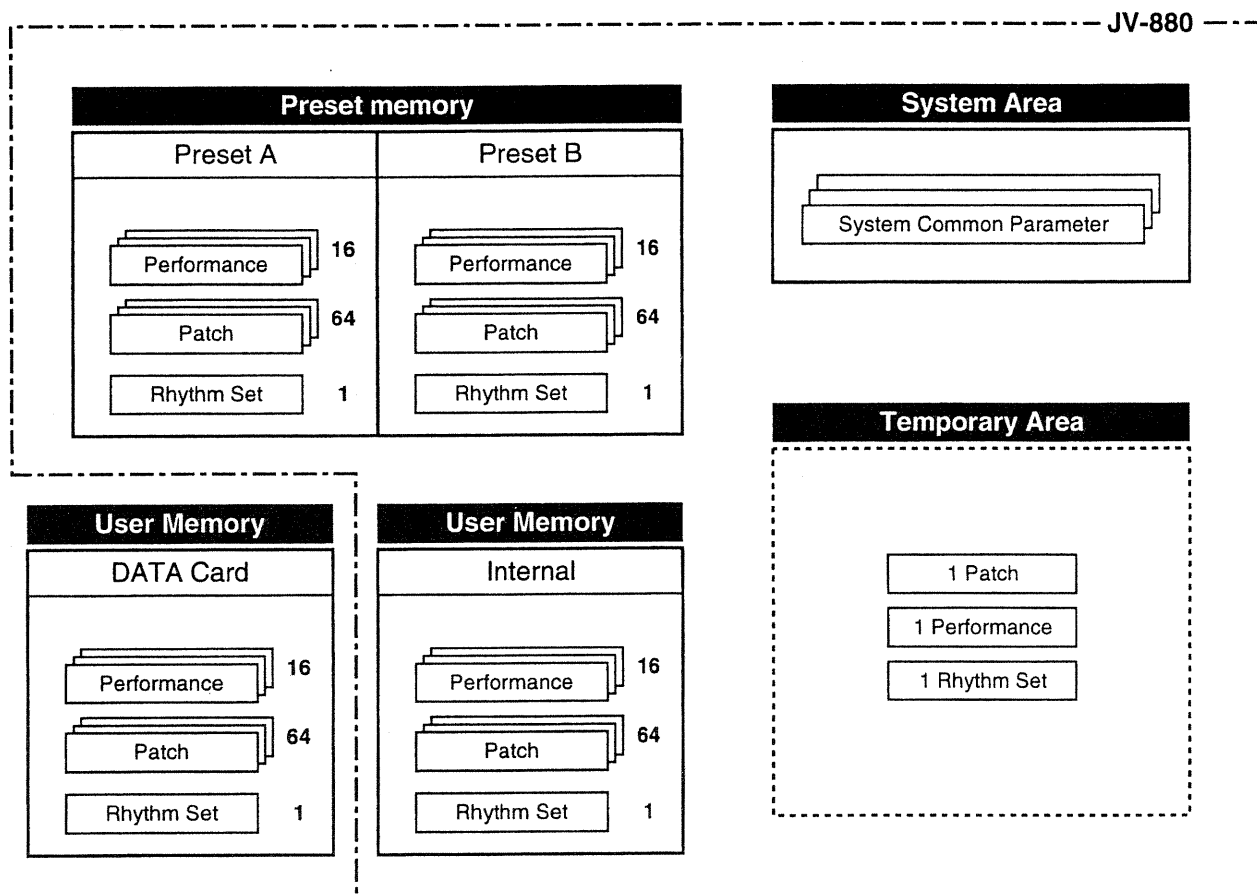

User Memory

The internal memory and Data Cards (optional) are memory areas that can be used to store original sounds. Each of the memory areas can accommodate 16 Performances, 64 Patches and 1 Rhythm Set.

Preset Memory

Each of the preset areas (A and B) contain 16 Performances, 64 Patches and 1 Rhythm Set. The Performance data and the Patch data stored in these areas cannot be overwritten (replaced). However, you can copy this data to the User memory area and then edit it to create new sounds.

System Area

The System area contains parameters which are related to the JV's entire system (System Common parameters), such as display contrast or master tuning settings. The settings made here are effective immediately.

Temporary Area

This area is used for temporarily storing sound data. Performance data and Patch data are called up from User memory (or Preset Memory A/B) by panel buttons or MIDI messages. (Simply put, the temporary area is a place where a copy of the data is kept.) The JV-880 is ultimately controlled by the data in the temporary area. As any editing of the data occurs in the temporary area only, the original data will not be affected.

CHORUS AND REVERB

The JV contains two stereo effects: chorus and reverb. The following explains how these effects are applied to Patches and Performances.

Patches

Chorus and reverb can be set for each Patch. The depth of the chorus/reverb effect on each Tone can be changed by editing the signal level (send level) which is sent to the chorus/reverb unit.

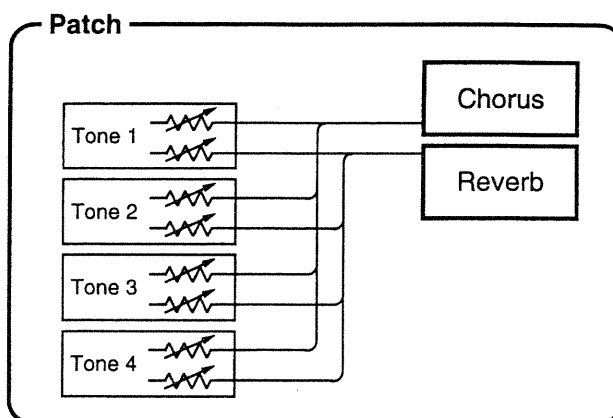

Performance

Chorus and reverb can be set for each Performance. The chorus/reverb settings for each Patch, assigned to each Part, are ignored. However, the depth of the chorus/reverb for each Part may differ, since the send level for each Tone is still in effect.

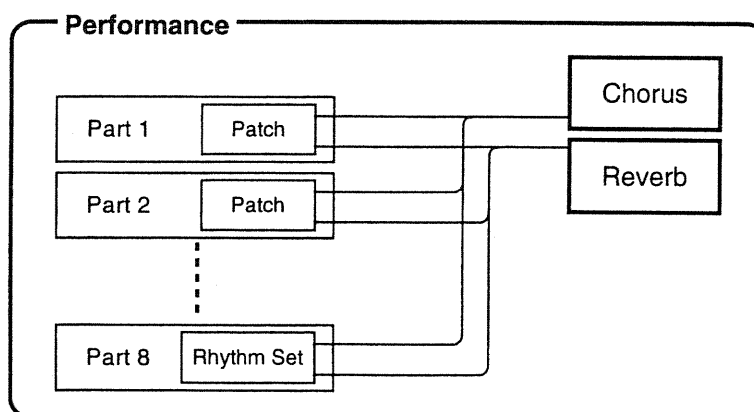

OUTPUT

The JV features two pairs of stereo output jacks. At the factory, the sound is routed to the MAIN OUTPUT jacks. You can change this setting to either the SUB OUTPUT jacks or both the MAIN OUTPUT and SUB OUTPUT jacks (See P.5-4.).

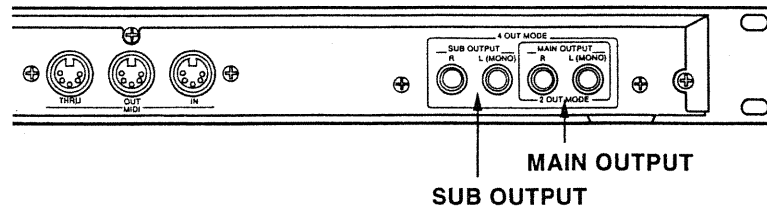

MAIN OUTPUT

When using these jacks, the chorus/reverb effect is part of the output signal.

The pan setting (See P.6-45, 7-11), the chorus (See P.6-9, 7-6) and the reverb (See P.6-11, 7-8) applied to the Part and Patch determine the stereo position and the effect to be used respectively.

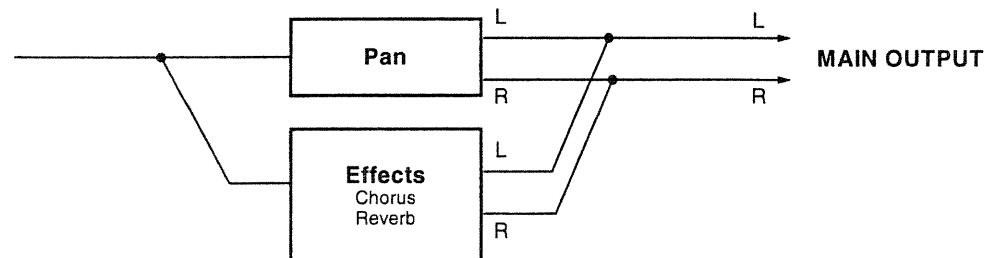

MAIN OUTPUT and SUB OUTPUT

When using both pairs of output jacks, the chorus/reverb effect is removed from the output signal.

The settings of the Patch, Performance and Rhythm Set determine the specific output assignments (MAIN OUTPUT or SUB OUTPUT).

● Patch

Within a Patch, the output destination for each Tone can be set.

● Performance

Within a Performance, the output destination for each Part can be set. The output destination can also be set for each Patch assigned to a Part. In this case, the output destination is that set for each Tone. (For Part 8, each Rhythm Tone has its own assignment.)

● Rhythm Set

The output destination can be set for each Rhythm Tone.

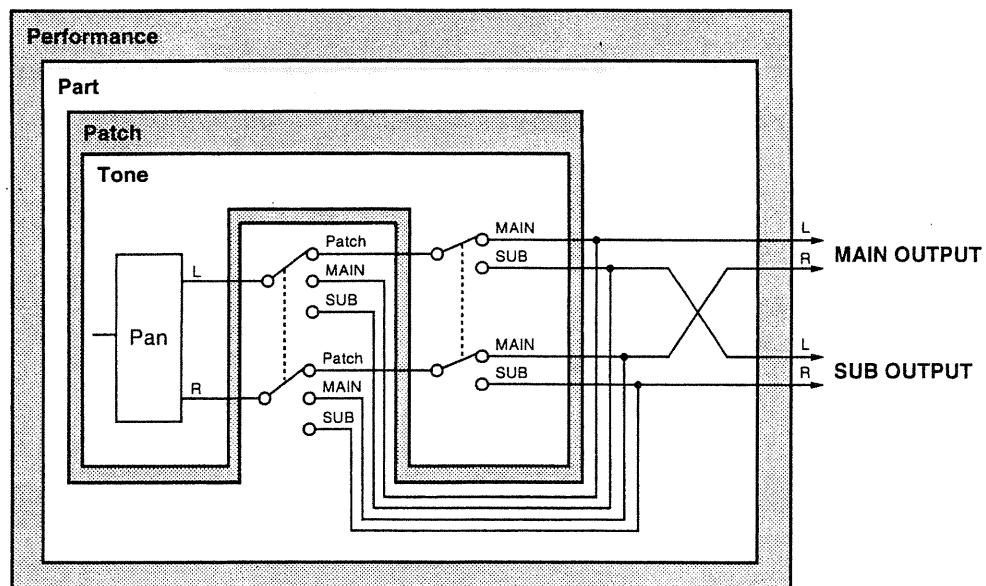

- * The output level from the SUB OUTPUT jacks is fixed; it is independent of the **VOLUME** knob setting.
- * Sound will not be output through the SUB OUTPUT, even when output assignment has been set to the SUB OUTPUT, if a cable has not been properly inserted in the SUB OUT jacks.
- * The signal output through the SUB OUTPUT jacks cannot be heard through headphones.

MIDI CONTROL

● Receiving MIDI Data

Patch Play mode

MIDI data from external MIDI devices is received via the receive channel, which is set in the System Common parameters (Rx channel).

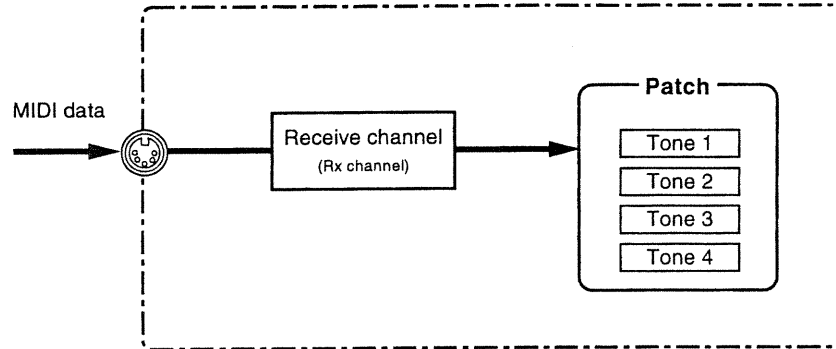

Performance Play mode

Since the receive channel can be set independently for each of the eight Parts, only those Parts whose receive channel matches the transmit channel will respond to incoming MIDI data.

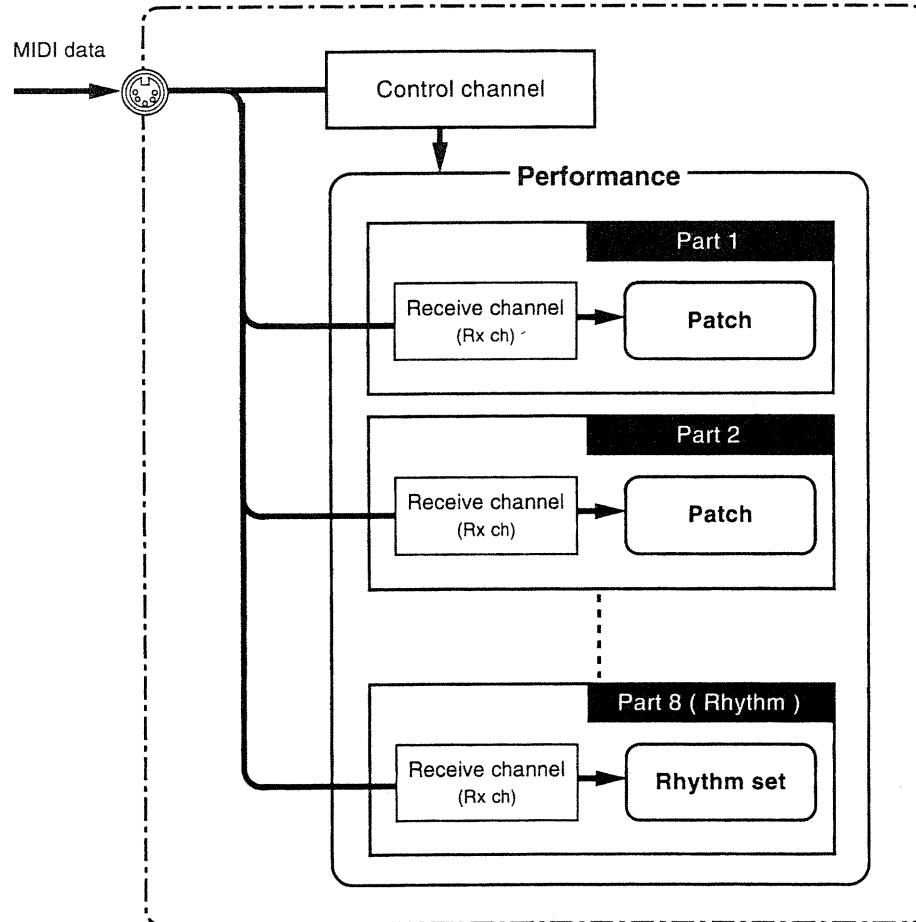

● Changing Patches.....

Patches can be changed via MIDI by reception of a bank select message (a value of 80 or 81 over controller number 0; bank select), and then an appropriate Program Change message.

From the Performance Play mode, Patches which are assigned to the received Part are changed. The Rhythm Set is changed when appropriate data is received by Part 8.

When only a Program Change message is received (without a proper bank select message), the Patches change only between presets A and B, or between internal memory and a Data Card.

Bank select value	Program change number	Patch (or Rhythm Set) to be changed
80	1 — 64	I01 — 64 (Internal)
	65 — 128	C01 — 64 (DATA card)
81	1 — 61	A01 — 64 (Preset A)
	65 — 128	B01 — 64 (Preset B)

● Changing Performances.....

Much the same as with Patches, Performances can be changed by reception of a bank select message (a value of 80 or 81 over controller number 0), then an appropriate Program Change message both over the MIDI channel set in Control Channel in the System Common parameters.

When only a Program Change message is received, the Performances change only between presets A and B, or between internal memory and a Data Card.

Bank select value	Program change number	Performance to be changed
80	1 — 16 (17 — 32, 33 — 48, 49 — 64)	I-01 — 16
	65 — 80 (81 — 96, 97 — 112, 113 — 128)	C-01 — 16
81	1 — 16 (17 — 32, 33 — 48, 49 — 64)	A-01 — 16
	65 — 80 (81 — 96, 97 — 112, 113 — 128)	B-01 — 16

- * The Control Channel has priority when the Control Channel and the receive channel of the Part (Performance) are the same.
- * When value of controllers No.0 and No.32 are sent as a pair, the JV-880 recognizes only the No.0 value.

● Main MIDI Messages Handled by the JV-880.....

MIDI includes a wide variety of messages and data for different performance controls. The following are the main MIDI messages handled by the JV-880.

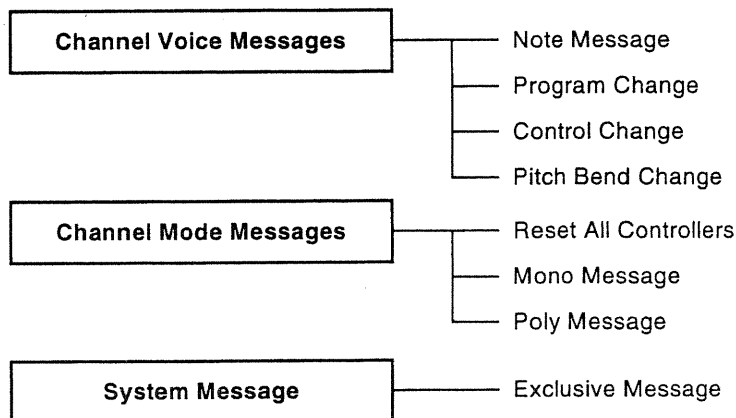

Channel Voice messages

Channel voice message is handled for each MIDI channel.

Note messages

Note messages indicates keyboard performance information, such as which key (note number) is played, when it is played (note on), how strongly it is played (velocity), and when it is released (note off).

Program Change messages

This message indicates sound program changes. When the JV-880 receives a program change message, the Performances, Patches and Rhythm Sets of the selected memory type (between presets A and B, or between internal memory and Data card) are changed.

Control Change messages

These messages are used for various expression controls in performance.

Bank Select (No.0)

This message switches between the banks (between presets A and B or between the internal memory and the DATA card).

Preset and User memory are selected by values of 80 and 81.

When receiving a program change message after receiving bank select, the Performance, Patch or Rhythm Set of the selected memory type is changed.

Modulation (No.1)

When this message is received, the parameter selected from Mod1 — 4 (P.6-18) of the Patch is changed.

- * Use exclusive messages in order to change the modulation effect or the way in which the modulation effect is applied.

Portamento time (No.5)

Reception of this message changes the time of the portamento effect (the time over which the pitch glides between successive notes).

Volume (No.7)

When this message is received, the level of the selected sound changes.

Pan pot (No.10)

When this message is received, the stereo position is shifted between left and right.

Expression (No.11)

When this message is received, the parameter selected from the Patch EXP1 — 4 (P.6-18) changes.

Hold 1 (No.64)

When an ON (value: 64 — 127) message is received, the sound continues until an OFF (value: 0 — 63) message is received.

Portamento (No.65)

When this message is received, the portamento effect is switched either on or off.

Reverb (No.91)

When this message is received, the reverb is switched either on or off.

Chorus (No.93)

When this message is received, the chorus is switched either on or off.

RPN (No. 100, 101)

This message switches among the bend range, master tune and fine/coarse tune parameters. The value is set with the data entry message.

Data entry (No.6/38)

When this message is received, the parameter value of the selected RPN parameter changes.

- * The same parameters may change differently when receiving MIDI messages, depending on the mode settings and channel settings. Refer to the MIDI Implementation (P.10-32) for details.
-

Pitch Bend Change message

This message indicates the position of a pitch bend lever (or wheel) of a connected MIDI controller or synthesizer. Moving the lever transmits this data. When this message is received, the pitch of the selected sound is changed.

Only data indicating the movement or position of the lever is transmitted from the synthesizer; the amount of pitch change (bend range) is set on the JV-880.

Aftertouch message

This message indicates how strongly a key on the connected MIDI keyboard is pressed down (for keyboards that transmit after touch data).

There are two kinds of aftertouch: channel aftertouch, which applies the effect equally over the entire keyboard, and polyphonic aftertouch, which applies the effect individually for each key. The JV-880 responds only to channel aftertouch.

Channel Mode message

Channel mode messages are handled regardless of the specified MIDI channel.

Reset All Controllers

This message initializes or resets various parameter settings, such as pan and volume, to certain values. Refer to the MIDI Implementation (P.10-32) for the available parameters and their initialized values.

Mono Message/Poly Message

Mono message switches the JV-880 to mono operation, so that only the most recently received note number is sounded. Poly message switches to poly operation, so that all received note numbers will sound, within the polyphonic limit of the instrument (the maximum number of simultaneous sounds).

The POLY/SOLO status of key assign is switched when these messages are received.

System messages

System messages are also handled regardless of the specified MIDI channel.

Exclusive messages

Exclusive messages are messages for the particular sound programs of each device. These messages can be transferred between identical devices of the same maker.

The sound program data can be transferred to another JV-880 or can be stored to a sequencer.

MODES

The various operations of the JV-880 are divided into the following seven modes:

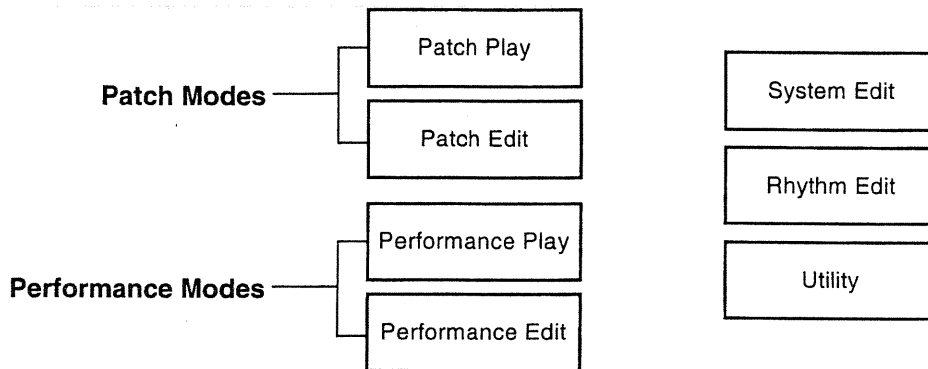

Patch Play mode(Section 3)

In this mode, a single Patch is selected and played.

Performance Play mode(Section 4)

In this mode, a single Performance is selected and played. This mode must be selected when using the JV as a multi-timbral sound source.

System Edit mode(Section 5)

In this mode, you can make settings related to the JV's entire system (such as master tuning).

Patch Edit mode(Section 6)

Patch editing (changing the elements that determine the character of the sound) is accomplished in this mode.

Performance Edit mode(Section 7)

In this mode, 7 Patches and 1 Rhythm Set are combined as Parts of the overall sound. Rich, "fat" sounds can be created by combining several similar Patches. Multi-timbral Patch combinations can also be created, allowing you to create an ensemble of several different instruments.

* The Patch Play and Patch Edit modes are together referred to as the Patch mode. Likewise, the Performance Play and Performance Edit modes are together called the Performance mode.

Rhythm Edit mode(Section 8)

This mode lets you change the settings of the Rhythm Set, which is assigned to Part 8 of a Performance. Separate Rhythm Tones are assigned to each note number and are combined as a single Rhythm Set. This mode allows you to determine how the Rhythm Tones will sound.

Utility mode(Section 9)

You can store your original sound data in this mode. There are also convenient functions that can be used in editing operations.

Press the appropriate button to select the desired mode. (In all cases, except the Performance Play mode, the button indicator will light.)

Press the button again to exit the mode. (The indicator will go out.)

Patch Mode

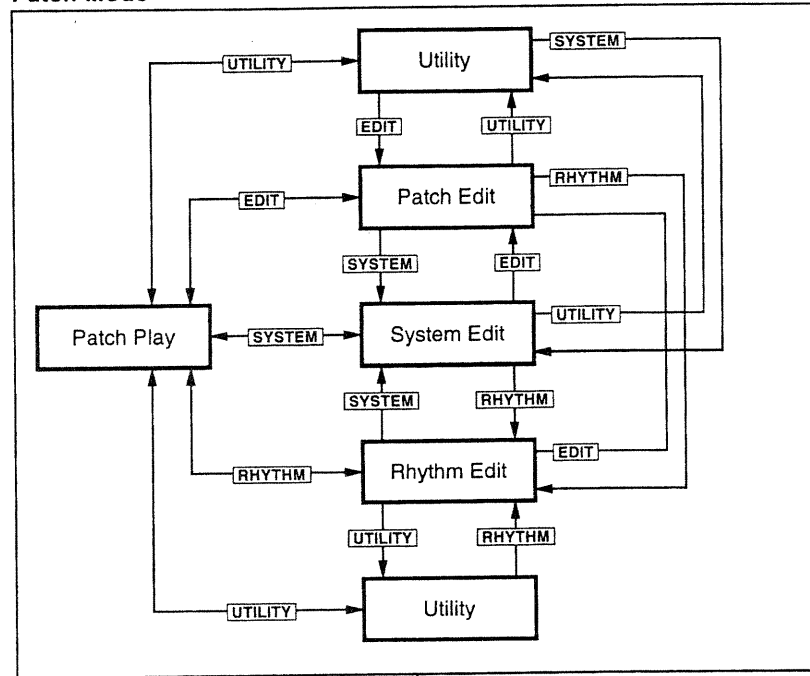

PATCH/PERFORM

Performance Mode

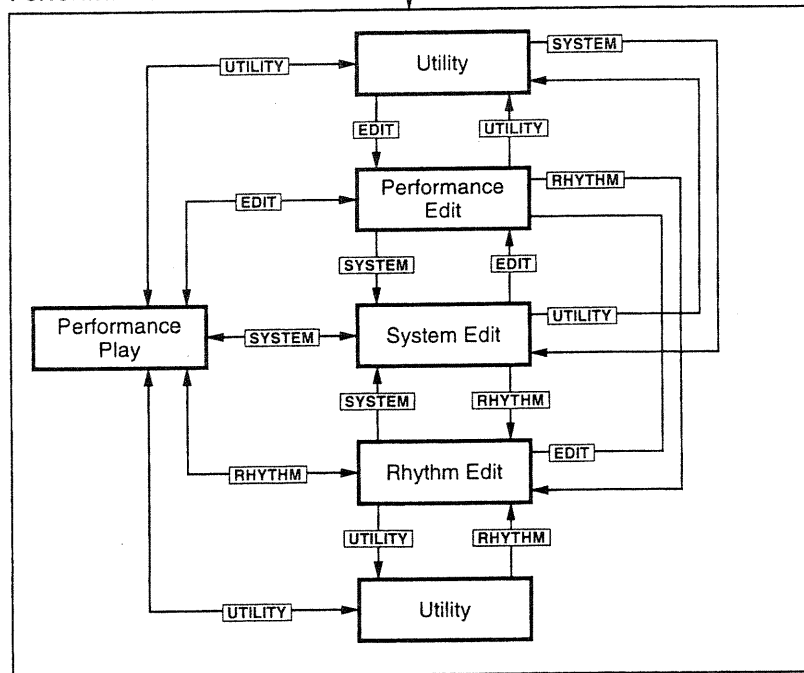

■ Panel Button Color-Coding

For ease of operation, the button names are color-coded: blue, orange and white.

Orange characters indicate functions in the Patch Play/Edit modes. Blue characters indicate functions in the Performance Play/Edit modes. Buttons with white characters can be used in any of the modes (with the exception of **COMPARE** and **ENTER**, which can only be used in the Utility mode).

MEMO

Section

3

**PLAYING
PATCHES**

PATCH PLAY MODE

WHAT IS THE PATCH PLAY MODE?

In the Patch Play mode, a single Patch is called up to the temporary area. Here the Patch can be played.

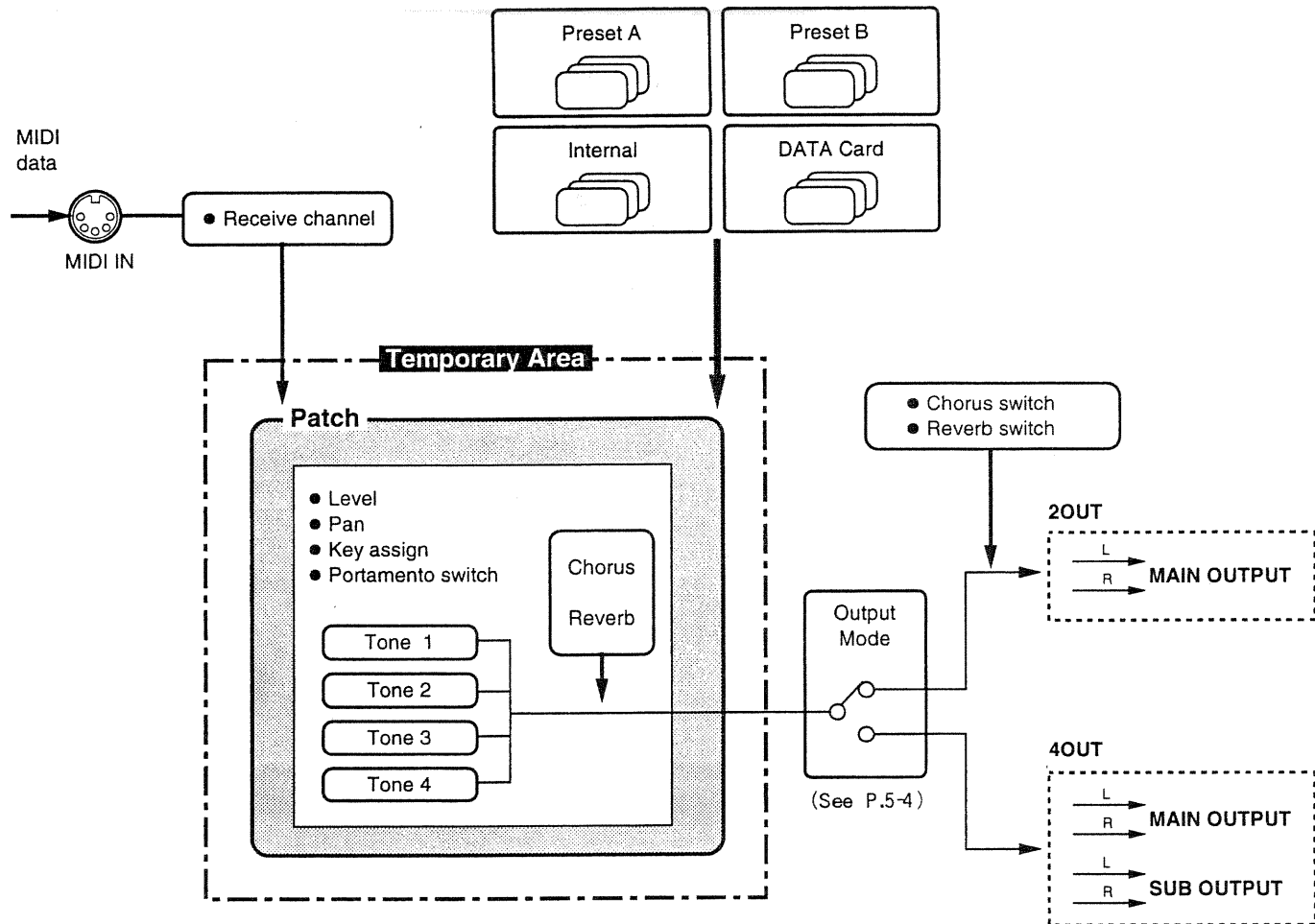

Points

- ◆ Some System Common parameters and Patch Common parameters can be controlled even while playing.
- ◆ As only the data in the temporary area is used during operation, the original Patch data in the User memory (internal memory or Data Card) or in the Preset memory (A/B) will be unchanged.
- ◆ A Patch whose settings have been changed can be stored in the User memory as a new Patch (See P.9-2).

OPERATION GUIDE

Press **PATCH/PERFORM** to select the Patch Play mode. (The indicator lights.)

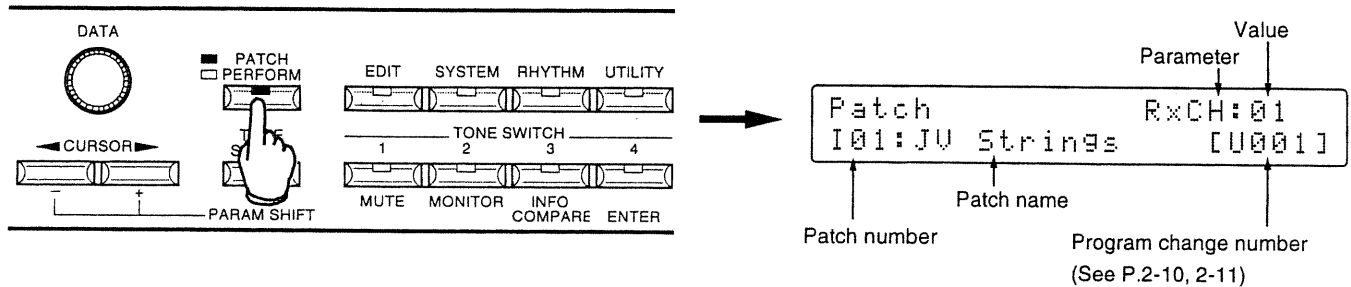

Changing patch

- ① Move the cursor to the Patch number in the display using **◀ CURSOR ▶**.

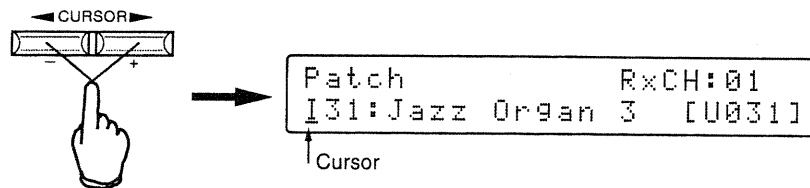

- ② Rotate the **DATA** dial to change the Patch number one by one.

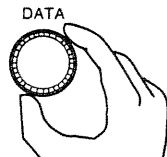

Simultaneously hold down and rotate the **DATA** dial; the Patch number stays the same but the Patch group indication (A, B, I, C) changes.

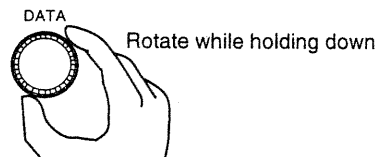

- * Patches of the Data card cannot be selected if a Data card has not been inserted.

Press the **DATA** dial twice quickly to return to Patch number 01 of the selected Patch group. Press the dial twice again to return to the previously selected Patch number.



Inserting DATA Cards

When you wish to use Patches from a Data Card, gently but firmly insert the Data Card (label side up) into the DATA CARD slot.

A Data Card (Roland M-256E) has a special 'protect switch' used to prevent accidental erasure of data stored on the Card. Normally this protect switch should be left ON. Always be sure the protect switch is ON when inserting or removing a Data Card in order to avoid possible loss of data.

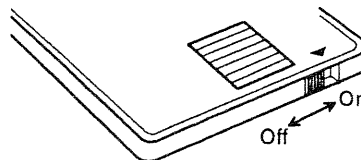
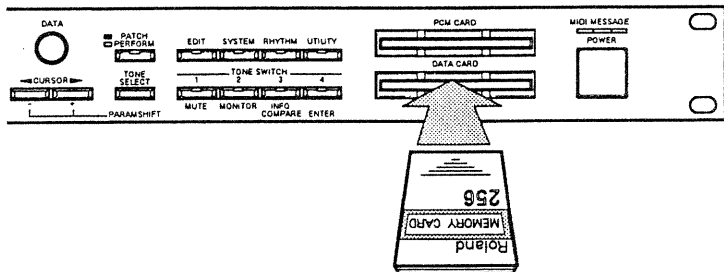

Changing Parameter Settings

- ① Move the cursor to the desired parameter using **◀CURSOR▶**.

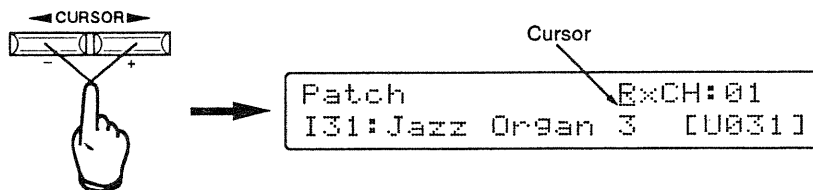

- ② Select the desired parameter by rotating the **DATA** dial.

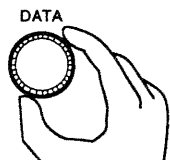

- ③ Move the cursor to the value field (where the value/setting is displayed) using **CURSOR▶**.

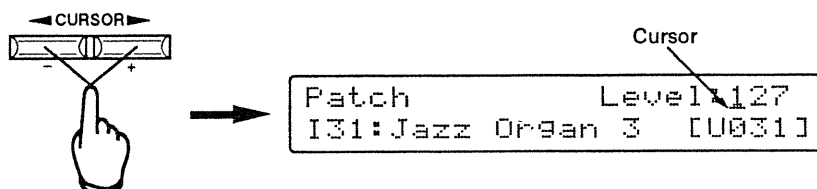

④ Change the value.

Rotate the **DATA** dial to change the value in small steps.

Simultaneously hold down and rotate the **DATA** dial to change the value in large jumps.

Press the **DATA** dial twice quickly to return to the originally set value. Press the dial twice quickly again to restore the value you set previous.

Parameters can be changed regardless of the cursor position by simultaneously holding down **PARAM SHIFT** and pressing **+** / **-**, when selecting the parameter to be edited.

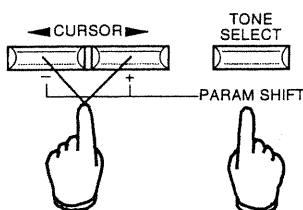

Switching Tones On and Off

Individual Tones can be turned on or off by pressing the **TONE SWITCH** buttons 1 — 4.

Each time a button is pressed, the corresponding Tone is switched on or off. The indicator lights when the Tone is on.

The on/off status of each Tone is stored as a Patch setting.

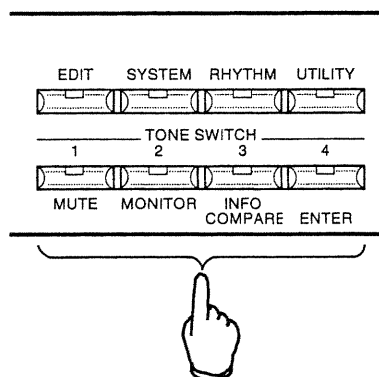

* The on/off status of each Tone is stored as a Patch setting.

Preview Function

You can hear the currently selected Tone(s) (that make up a Patch) simply by pressing the **VOLUME** knob.



- * Only those **TONE SWITCH** which are ON will sound.
- * If all the **TONE SWITCH** are OFF, no sound will be heard when the **VOLUME** knob is pressed.

Storing Edited Patches

- ① Press **UTILITY** to select the Utility mode. (The indicator lights.)

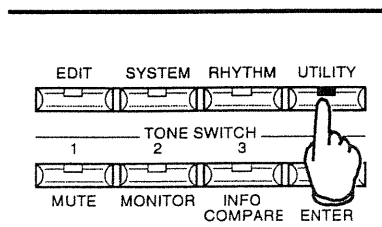

- ② Write the Patch to memory.
See (P.9-3) for details of the Write operation.

PATCH PLAY MODE PARAMETERS

```
Patch          RxCH:01
I01:JV Strings [U001]
```

● **RxCH** : Receive channel (System Common parameter)

This parameter determines the receive channel of the Patch.

Range: 1 — 16

```
Patch          Level:100
I01:JV Strings [U001]
```

● **Level** : Patch level (Patch Common parameter)

This parameter determines the sound level of the Patch.

Range: 0 — 127

```
Patch          Pan:L05
I01:JV Strings [U001]
```

● **Pan** : Patch pan (Patch Common parameter)

This parameter determines the stereo position (L or R) of the Patch.

Pan can also be set for each Tone in the Patch (See P.6-8).

Range: L64 — 0 — R63

The sound position is at the farthest left at L64, in the center at 0, and at the farthest right at R63.

```
Patch          Reverb sw:ON
I01:JV Strings [U001]
```

● **Reverb sw** : Reverb switch (System Common parameter)

This parameter determines whether reverb is applied (ON) or not.

If this switch is OFF, no reverb is applied to the sound, even when reverb is set for a Patch (or each Tone in a Patch).

Settings: ON/OFF

* This parameter is not displayed when the output mode of the system common parameter is set at 4OUT.

```
Patch          Chorus sw:ON
I01:JV Strings [U001]
```

● **Chorus sw** : (System Common parameter)

This parameter determines whether the chorus effect is applied (ON) or not.

If this switch is OFF, no chorus effect is applied to the sound, even when chorus is set for a Patch (or each Tone in a Patch).

Settings: ON/OFF

* This parameter is not displayed when the output mode of the system common parameter is set at 4OUT.

```
Patch      Key assign:SOLO
I01:JV Strings  [U001]
```

● **Key assign :** (Patch Common parameter)

This parameter determines whether the Patch is played in POLY or SOLO mode.

Settings: POLY/SOLO

POLY: Several notes can be played at one time.

SOLO: Only one note at a time can be played.

The note number which was received last will sound.

```
Patch      Portamento:OFF
I01:JV Strings  [U001]
```

● **Portamento : Portamento switch** (Patch Common parameter)

This parameter determines whether the portamento effect is applied (ON) or not. When portamento is ON, the pitch smoothly “slides” between successively played notes.

Settings: ON/OFF

Section

4

**PLAYING
PERFORMANCES**

PERFORMANCE PLAY MODE

WHAT IS THE PERFORMANCE PLAY MODE?

In the Performance Play mode, a single Performance is called up to the temporary area. The selected Performance can then be played.

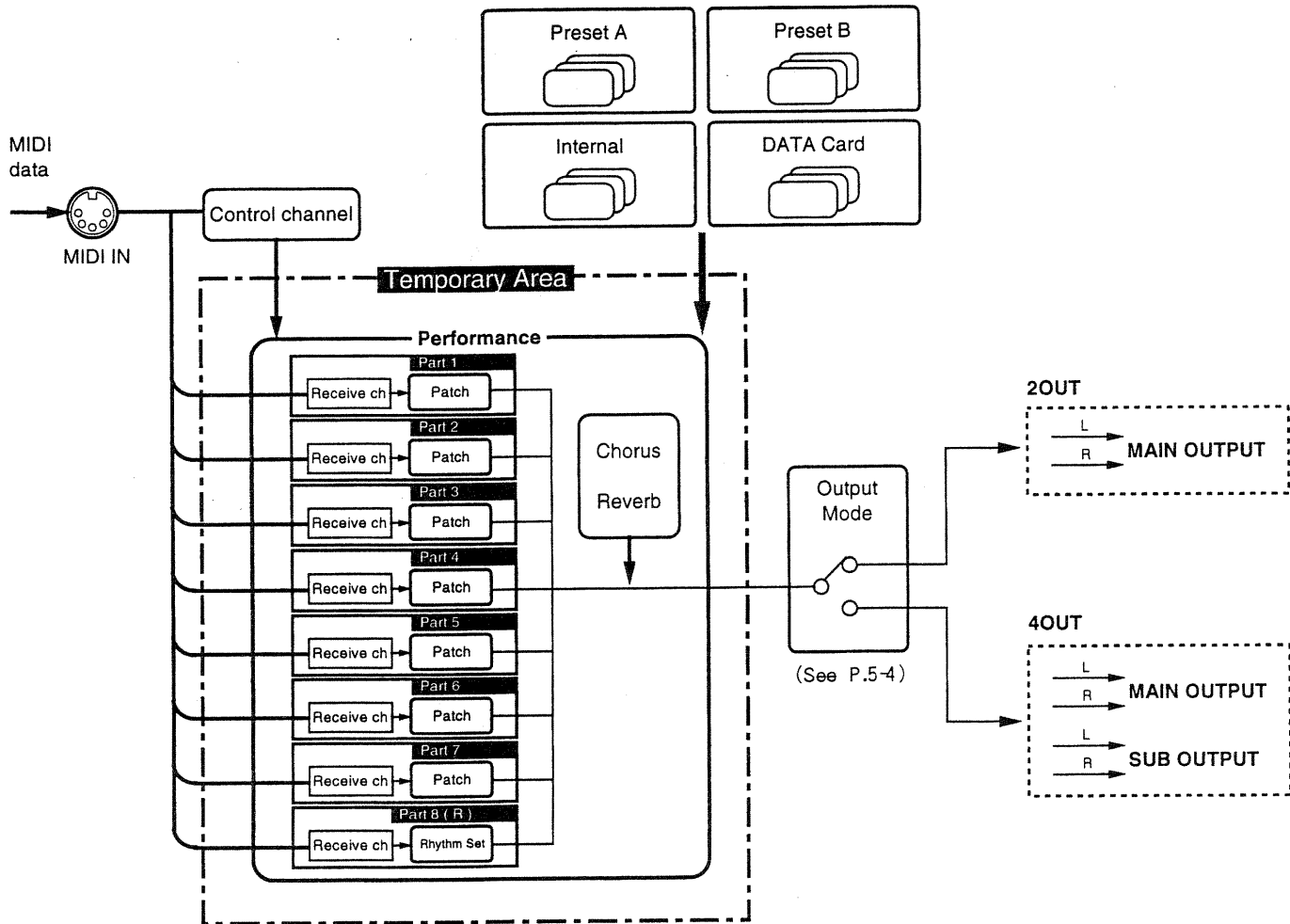

Points

- ◆ Patches assigned to each Part can be changed (Part 8 is reserved for the Rhythm Set).
- ◆ The sound of any Part can be muted (turned off).
- ◆ One of the any Part can be monitored (Part monitor).
- ◆ The status of MIDI data reception for each Part can be displayed (Part information).
- ◆ As only the data called up to the temporary area is used in operation, the original Performance data (in the internal memory or on a Data Card) will be unaffected.
- ◆ An edited Performance can be stored in User memory as a new Performance (See P.9-4).

OPERATION GUIDE

Press **PATCH/PERFORM** to enter the Performance Play mode. (The indicator should be off; if it's ON, you're in the Patch Play mode.)

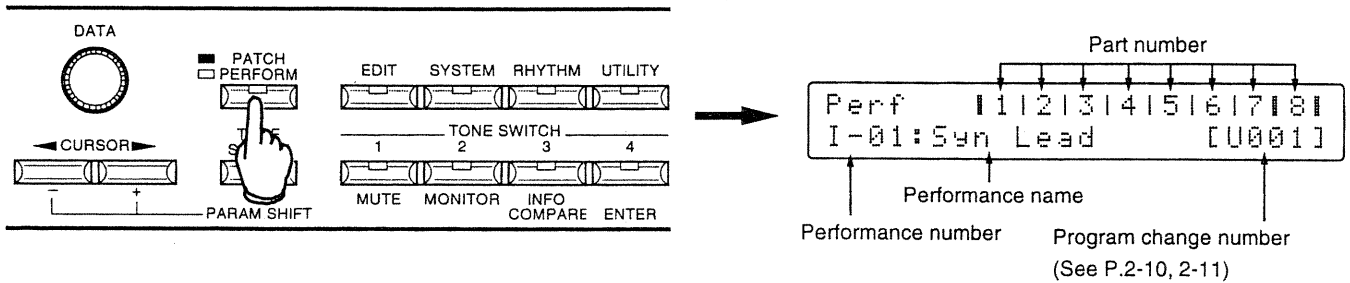

When the Part number indication in the screen display is a "↓" mark, it shows that part is currently sounding.

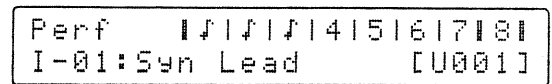

Changing Performances

- ① Move the cursor to the Performance number using **◀ CURSOR ▶**.

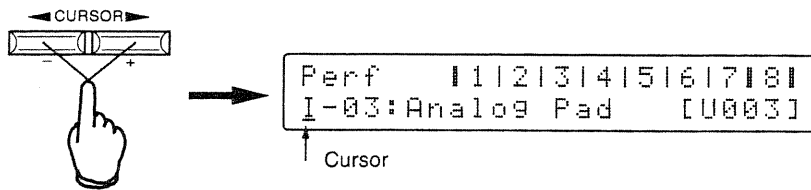

- ② Rotate the **DATA** dial to change the Patch number one by one.

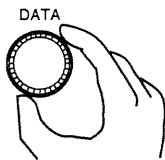

Simultaneously hold down and rotate the **DATA** dial; the Patch number stays the same but the Patch group indication (A, B, I, C) changes.

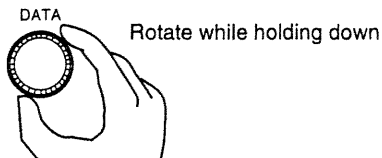

* Patches of the Data card cannot be selected if a Data card has not been inserted.

Press the **DATA** dial twice quickly to return to Patch number 01 of the selected Patch group.



Inserting DATA Cards

When you wish to use Performances on a Data Card, gently but firmly insert the Data Card (label side up) into the DATA CARD slot.

A Data Card (Roland M-256E) has a special protect switch used to prevent accidental erasure of data stored on the Card. Normally this protect switch should be left ON. Always be sure the protect switch is ON when inserting or removing a Data Card in order to avoid possible loss of data.

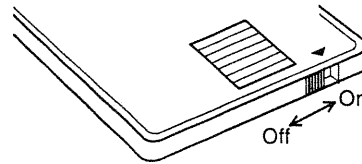
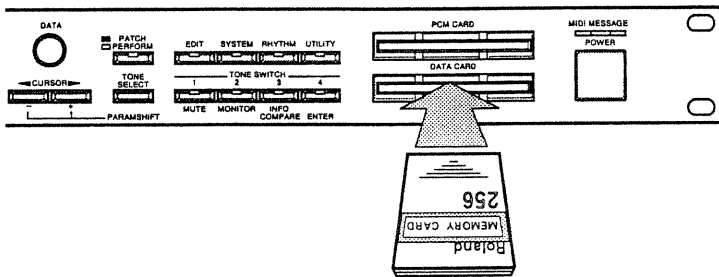

Changing the Patch/Part Assignments

- Using **◀ CURSOR ▶**, move the cursor to the Part number (on the top line) whose Patch is to be changed.

The Part number, Patch number and the Patch name (eg. 1:163:DistanceCall) will be displayed on the bottom line of the LCD when the cursor is moved to the Part number on the top line.

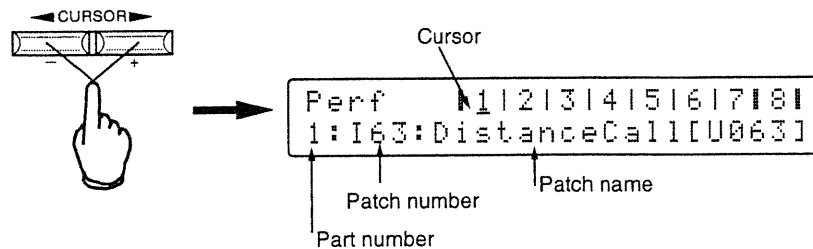

- ② Rotate the **DATA** dial to change the Patch number one by one.

Simultaneously hold down and rotate the **DATA** dial; the Patch number stays the same but the Patch group indication (A, B, I, C) changes.

- * Patches of the Data card cannot be selected if a Data card has not been inserted.

Press the **DATA** dial twice quickly to return to the originally set patch number. Press the dial twice again to return to the previously selected Patch number.

Muting the Sound of a Part

When a Part is muted, it will not sound when played.

This function is convenient when you want to temporarily keep a Part from sounding.

- ① Using **◀ CURSOR ▶**, move the cursor to the Part number (on the top line) to be muted.

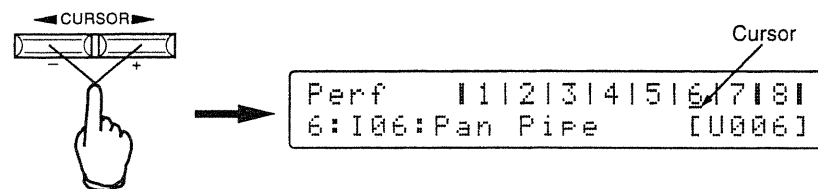

- ② Press **MUTE** (the indicator will light).

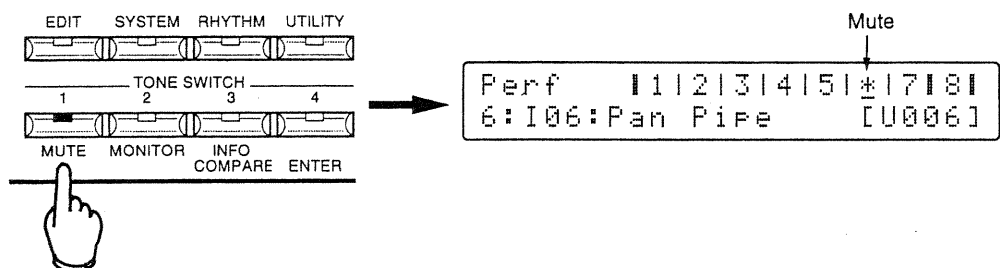

Each press of the button switches between the mute on condition (indicator is lit) and the normal sounding condition (indicator is off).

An asterisk "∗" appears at the Part number indication in the display for the Part currently being muted.

- ③ Repeat steps ① and ② to mute other Parts.

Part Monitor

The Part Monitor function allows you to “solo” a specific Part, letting you hear just that Part while the others are muted.

This function is convenient for checking the sound of individual Parts.

- Using **◀ CURSOR ▶**, move the cursor to the Part number (on the top line) to be monitored.

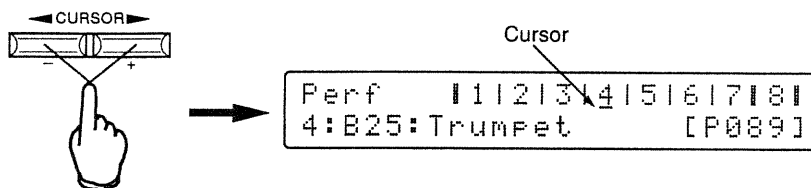

- Press **MONITOR** (the indicator lights).

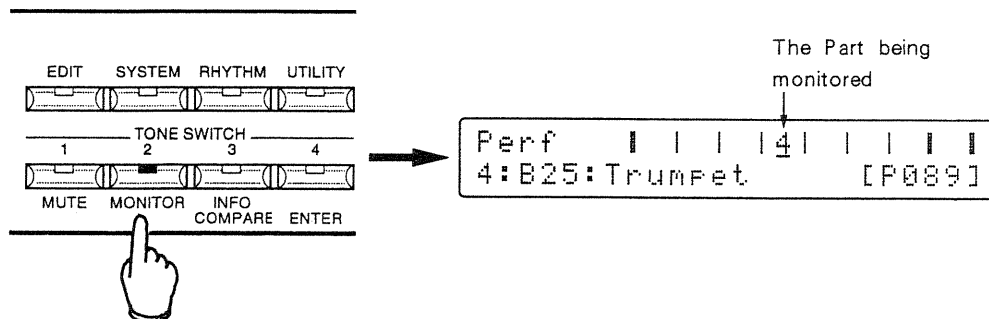

Only the number of the Part being monitored is indicated.

- Press **◀ CURSOR ▶** (while in this monitoring “mode”) to select different Parts.
- Press **MONITOR** again to cancel the Part Monitor function and return to the original display. (The indicator goes out.)

Preview Function

You can hear the Patch currently assigned to a Part by selecting the desired Part number (on the top line) with the cursor, and then pressing the **VOLUME** knob.

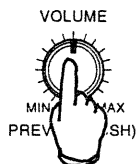

- * This function temporarily overrides muting, allowing even muted Parts to be heard.
- * When the Part Monitor function is being used, the Patch which is assigned to the Part being monitored will sound.

Monitoring MIDI Data Reception of a Part (Part Information)

This function allows you to monitor MIDI data reception for each Part.

- * The current value of received MIDI data is indicated in the display. The actual effect differs from the indicated value.
- * MIDI data is not received when the receiving switches (See P.5-6—5-9) of specified types of MIDI data are turned off. The Part will not respond to any data if its receiving switch (See P.7-15) is turned off (or if it is muted).

① Press **INFO**. (The indicator lights.)

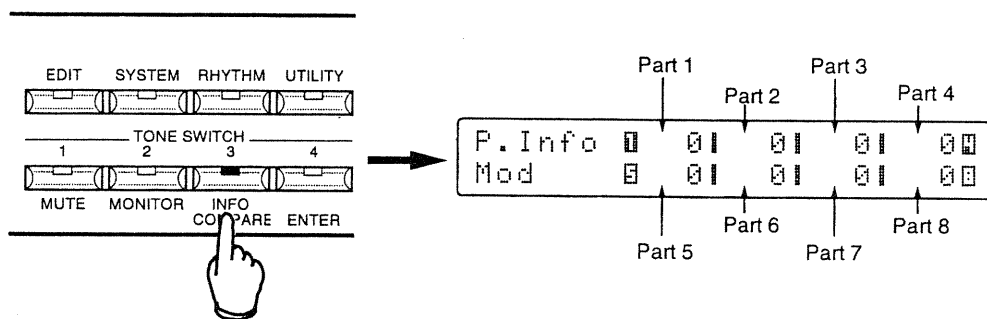

- ② Rotate the **DATA** dial to change the type of MIDI data indicated in the display.
- ③ Press **INFO** again to return to the original display. (The indicator goes out.)

The types of MIDI data indicated are described below.

	MIDI Data/Explanation	Range
<pre> P.Info 0 01127 20 200 Mod 0 01 01 01 00 </pre>	<p>● Mod (Modulation): MIDI data used to create modulation effects (vibrato, for example).</p>	0 — 127
<pre> P.Info 0100 127 100 800 Volume 0 01 01 50 1000 </pre>	<p>● Volume: MIDI data used to change the volume level.</p>	0 — 127
<pre> P.Info 0 0 L20 20R L400 Pan 040R 0 0 63R0 </pre>	<p>● Pan: MIDI data which determines the stereo (L/R) position.</p>	L64 — 63R
<pre> P.Info 0100 127 80 200 Exp 0 80 0 100 1270 </pre>	<p>● Exp (Expression): MIDI data for expression control.</p>	0 — 127

<pre>P.Info OFFI ONIOFFIOFFI Hold-1 ONIOFFIOFFI ONI</pre>	<p>● Hold-1: MIDI data for the hold (sustain) pedal.</p>	<p>ON/OFF</p>
<pre>P.Info 01127I 01 20I After 01 01 50I 00</pre>	<p>● After (Aftertouch): Aftertouch data.</p>	<p>0 — 127</p>
<pre>P.Info 01+20I 01-40I Bender +14I 01 01 00</pre>	<p>● Bender: Pitch bend change MIDI data for making continuous pitch changes.</p>	<p>— 64 — +63</p>
<pre>P.Info 06I 02I 08I 0I Voice 01 01 01 06I</pre>	<p>● Voice: Number of voices used The total number of voices used depends on how many Tones are used to make a Patch. For example, when playing a Part that has two Patches, each made up of one Tone, "2" (2 voices) is displayed. When playing two Patches made up of two Tones each, "4" (4 voices) is displayed. A single asterisk "*" appears to the right of "Voice" in the display when the number of voices used exceeds 24; two asterisks "*" * " are displayed when the maximum of 28 is reached.</p>	<p>0 — 28</p>

Storing Edited Performances

- ① Press **UTILITY** to select the Utility mode. (The indicator lights.)

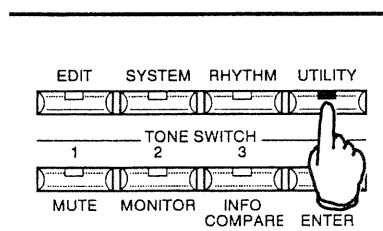

- ② Store the Performance in memory.
See (P.9-4) for details of the Write operation.

Section

5

**EDITING
SYSTEM COMMON
PARAMETERS**

SYSTEM EDIT MODE

WHAT IS THE SYSTEM EDIT MODE?

In the System Edit mode, the System Common parameters those related to the entire unit (such as master tuning) can be edited.

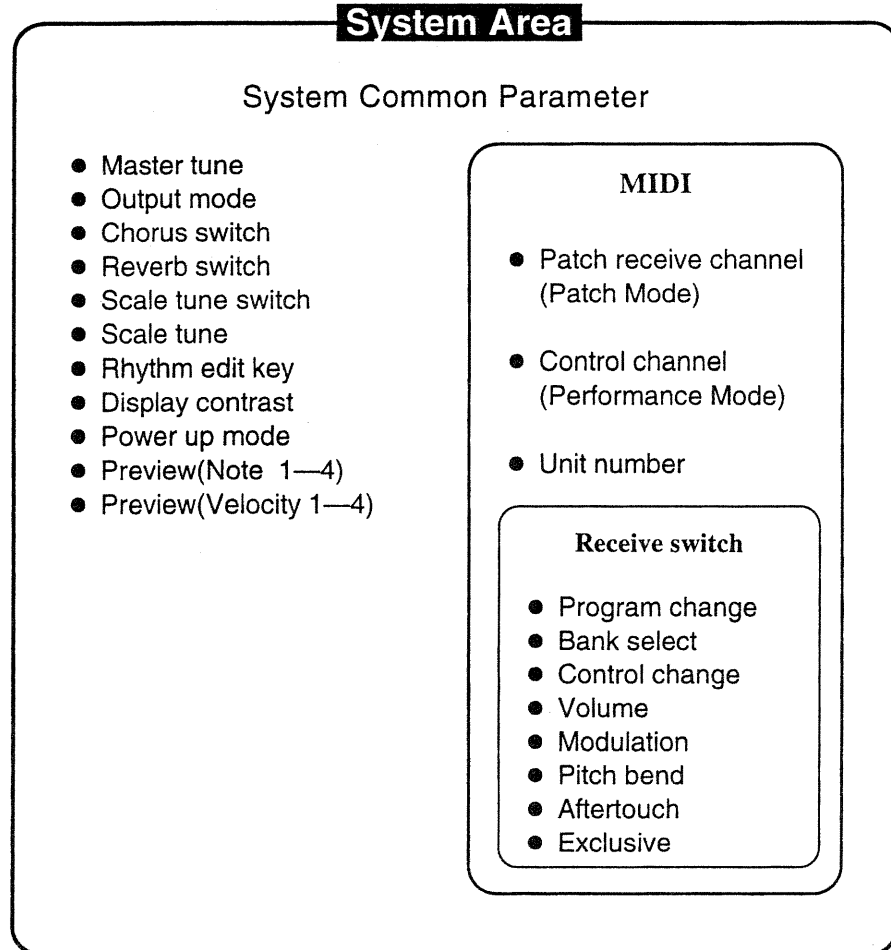

Points

- ◆ Changes of these settings take effect immediately.

OPERATION GUIDE

- ① Press **SYSTEM** to enter the System Edit mode. (The indicator lights.)

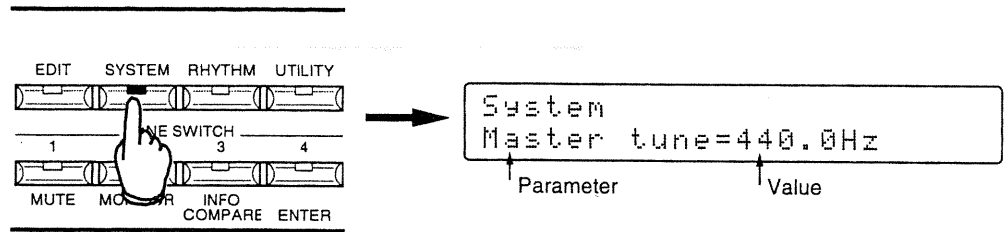

- ② Move the cursor to the parameter field of the display using **◀CURSOR▶**.

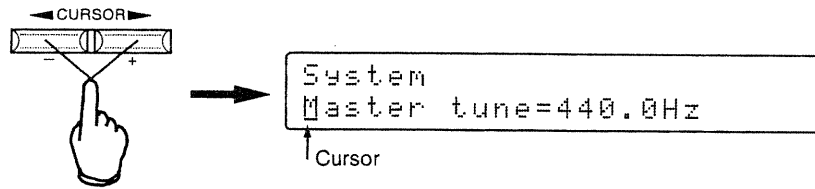

- ③ Select the parameter to be edited.
Step through the parameters by rotating the **DATA** dial.

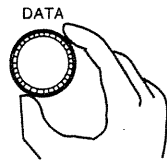

- ④ Move the cursor to the parameter value with **◀CURSOR▶**.

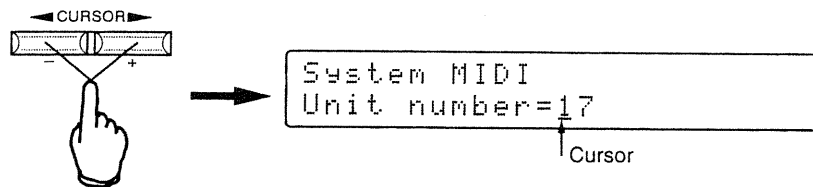

- ⑤ Change the value.
◆ Rotate the **DATA** dial to change the value in small steps.

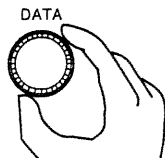

- ◆ Simultaneously hold down and rotate the **DATA** dial to change the value in large jumps.

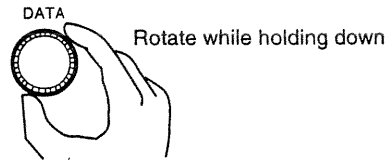

- ◆ Press the **DATA** dial twice quickly in the originally set value.
Press the dial twice again to return to the previously selected value.



- ⑥ Repeat steps ② through ⑤ as necessary.
- ⑦ Press **SYSTEM** to exit the System Edit mode. (The indicator goes out.)

Parameters can be changed regardless of the cursor position by simultaneously holding down **PARAM SHIFT** and pressing **+**/**-**, when selecting the parameter to be edited.

A diagram showing two control buttons. The left button is labeled "CURSOR" and has a double-headed arrow above it. The right button is labeled "TONE SELECT" and has a plus sign (+) and a minus sign (-) above it. A line labeled "PARAM SHIFT" connects the two buttons. Below each button is a hand with a finger pressing it, indicating simultaneous operation.

PARAMETER FUNCTIONS

Note

Some of the parameters explained in this section may not be active, depending on settings in the System Common parameters. These inactive parameters are not displayed in the LCD. For such parameters, the relevant System Common parameters are described at the side of the LCD illustration.

Master tune

```
System  
Master tune=440.0Hz
```

This parameter controls the overall tuning (pitch) of the JV-880. The value is expressed as the frequency of the A4 key. The greater the value, the higher the pitch.

Range: 427.4 — 452.6Hz

Output mode

```
System  
Output mode=4OUT
```

This parameter determines the jacks from which the sound will be output.

Settings: 2 OUT/4 OUT

2 OUT : The stereo (L/R) signal with effects is output through the MAIN OUTPUT jacks.

4 OUT : Sounds without effects are output through both the MAIN OUTPUT and SUB OUTPUT jacks. The settings of the Output Select of each Patch (See P.6-53) and the Performance (See P.7-15) determine from which set of jacks, MAIN or SUB, the sound will be output.

2OUT

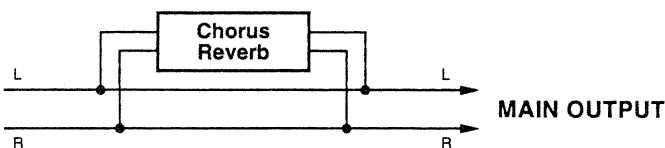

4OUT

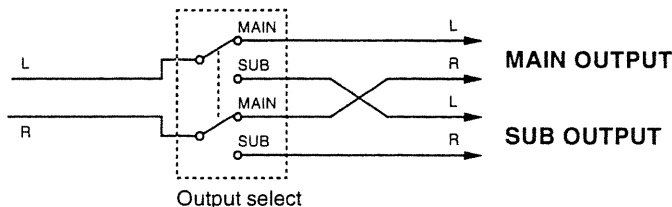

* When 4 OUT is selected, the **VOLUME** knob only controls the level of the MAIN OUTPUT jacks. The level of the SUB OUTPUT jacks is fixed.

Chorus switch

```
System
Chorus switch=ON
```

Output mode = 2OUT

This parameter determines whether the chorus effect is applied (ON) or not.

Settings: ON/OFF

- * The chorus depth changes depending on the settings made for the Patch or Performance.
- * The chorus setting in the Patch Common parameters (See P.6-9) and the chorus setting in the Performance Common parameters (See P.7-6) have no effect when this is set to OFF.

Reverb switch

```
System
Chorus switch=ON
```

Output mode = 2OUT

This parameter determines whether the reverb effect is applied (ON) or not.

Settings: ON/OFF

- * The reverb depth changes depending on the settings made for the Patch or Performance.
- * The reverb setting in the Patch Common parameters (See P.6-11) and the reverb setting in the Performance Common parameters (See P.7-8) have no effect when this is set to OFF.

Rx channel

Patch Receive Channel

```
System MIDI
Rx channel=01
```

This parameter determines the Patch receive channel.

Patches can be changed (over the set channel) by reception of a bank select message and an appropriate Program Change message. When only a Program Change message is received, the Patches change only between presets A and B, or between internal memory and a Data Card (See P.2-10).

Range: 1 — 16

- * This parameter is only selected when the mode is changed from Patch Play/Edit to System Edit.

Control channel

```
System MIDI  
Control channel=16
```

This parameter lets you change Performances by MIDI message, or sets the channel for turning the chorus/reverb switch on and off (See P.7-13).

Range: 1 — 16/OFF

1 — 16 : Performances can be changed (over the set channel) by reception of a bank select message and an appropriate Program Change message. When only a Program Change message is received, the Performances change only between presets A and B, or between internal memory and a Data Card (See P.2-10).

Also, the chorus/reverb switch is turned on or off when receiving chorus/reverb control change data.

OFF : Performances cannot be selected via MIDI.

Also, the chorus/reverb switch cannot be turned on or off via MIDI.

- * This parameter is only selected when the mode is changed from Performance Play/Edit to System Edit.

Unit number

```
System MIDI  
Unit number=17
```

The Unit number is a device identification number designed for use with System Exclusive data operations. The JV-880 receives System Exclusive data only when the appropriate Unit number is specified.

Set the Unit number to match the number of the sending/receiving device when sending/receiving System Exclusive data.

Range: 17 — 32

When controlling a setup of several JV-880s, assign different Unit numbers to each JV; in this way, System Exclusive data can be sent and received by individual units (See P.10-35).

Program change

Program Change Receive Switch

```
System MIDI Rx switch  
Program change=ON
```

This parameter determines whether or not the JV-880 will respond to Program Change messages from an external MIDI device.

Settings: ON (respond)/OFF (ignore)

- * Performances, Patches or Rhythm Sets may sometimes not change as expected if either the Program Change receiving switch or the bank select receiving switch has been set to OFF.
- * The setting of the Program Change receiving switch in the Performance Part parameters has no effect when this switch is OFF.

Program bank select

Bank Select Receive Switch

```
System MIDI Rx switch  
Program bank sel=ON
```

This parameter determines whether or not the JV-880 will respond to bank select (Control change No.0) messages from an external MIDI device.

Settings: ON (respond)/OFF (ignore)

Control change

Control Change Receive Switch

```
System MIDI Rx switch  
Control change=ON
```

This parameter determines whether or not the JV-880 responds to Control Change messages other than modulation, volume, bank select (See P.2-11) and RPN from an external MIDI device.

Settings: ON (respond)/OFF (ignore)

Volume

Volume Receive Switch

```
System MIDI Rx switch  
Volume=ON
```

This parameter determines whether or not the JV-880 will respond to volume data from an external MIDI device.

Settings: ON (respond)/OFF (ignore)

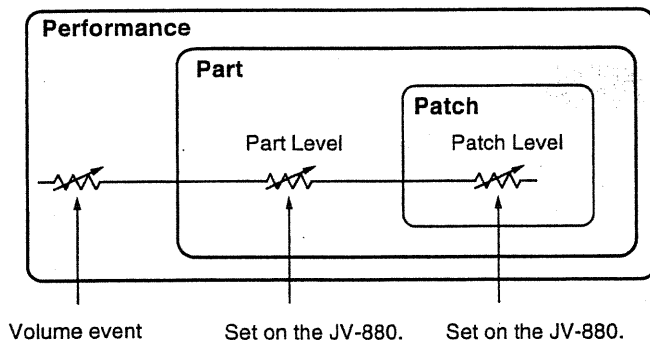

- * The setting of the volume receive switch in the Patch Tone parameters (See P.6-16) and the setting of the volume receive switch in the Performance Part parameters (See P.7-14) have no effect when this switch is set to OFF.

The actual sound level changes when MIDI volume data is received. However, the setting of the Performance's Part level (See P.7-10) and the setting of the Patch level (See P.6-8) do not change.

Send the volume data again or re-select the mode in order to return to the original setting.

Modulation

Modulation Receive Switch

```
System MIDI Rx switch  
Modulation=ON
```

This parameter determines whether or not the JV-880 will respond to modulation data from an external MIDI device.

Settings: ON (respond)/OFF (ignore)

Pitch bend

Pitch Bend Receive Switch

```
System MIDI Rx switch  
Pitch bend=OFF
```

This parameter determines whether or not the JV-880 will respond to pitch bend data from an external MIDI device.

Settings: ON (respond)/OFF (ignore)

Aftertouch

Aftertouch Receive Switch

```
System MIDI Rx switch  
Aftertouch=OFF
```

This parameter determines whether or not the JV-880 will respond to aftertouch data from an external MIDI device.

Settings: ON (respond)/OFF (ignore)

Exclusive

Exclusive Receive Switch

```
System MIDI Rx switch  
Exclusive=ON
```

This parameter determines whether or not the JV-880 will respond to System Exclusive data from an external MIDI device.

Settings: ON (respond)/OFF (ignore)

Scale tune switch

```
System  
Scale tune switch=ON
```

This parameter determines whether or not the Scale Tune function is applied (ON).
Refer to "Scale Tune" below for information on how to set this function.

Settings: ON/OFF

Scale tune

The Scale Tune function allows you to precisely adjust the individual pitches of notes in an octave (C to B). Adjustments made here will apply to the entire keyboard. This function makes it possible to use tunings other than conventional equal temperament.

[When a Patch is selected]

Tune each note of the octave.

```
System  
Scale tune C=00
```

Scale Tune switch = ON

:

```
System  
Scale tune B=00
```

[When a Performance is selected]

Tune each note of a Part.

```
System Part1  
Scale tune C=00
```

Scale Tune switch = ON

:

```
System Part8  
Scale tune B=00
```

Range: - 64 — +63 (in 1-cent units) for each note C — B

(+) value : The greater the value, the higher the pitch.

(-) value : The greater the value, the lower the pitch.

- The Scale Tune function allows you to create different tunings for the notes of a scale.

Equal Temperament

This tuning divides one octave into twelve equally spaced tones. This temperament is the most commonly used in western music.

An OFF setting of the scale tune switch sets the JV-880 to equal temperament.

Just Temperament (when tonic is C)

Compared to equal temperament, in which all notes of the scale are equally "out of tune," this tuning puts the three notes of a major triad in perfect tune. However, this effect is possible only when playing in one key. Chords for other keys are more dissonant. The chart below shows the pitch differences for each note when the tonic is C.

Arabic Scale

In the Arabic scale, the pitches of E and B are lower than those of the equal temperament scale by half of a semitone, and C#, F# and G# are higher by half of a semitone. Besides the scales of G—B, C—E, F—G#, A#—C# and D#—F#, there are three neutral keys (the scale between major third and minor third), and on the JV-880 the Arabic scale can be played in the keys of G, C or F.

[Setting example]

Note	Equal Temperament	Just Temperament (when tonic is C)	Arabic Scale
C	0	0	- 6
C#	0	- 8	- 5
D	0	+4	- 2
D#	0	+16	- 12
E	0	- 14	- 51
F	0	- 2	- 8
F#	0	- 10	+43
G	0	+2	- 4
G#	0	+14	+47
A	0	- 18	0
A#	0	+14	- 10
B	0	- 12	- 49

Rhythm edit key

```
System  
Rhythm edit key=INT&MIDI
```

When editing, writing, copying or initializing each percussion sound in a Rhythm Set, the Rhythm Edit key determines whether the percussion sound can be selected by the operations of the JV-880, or by both the JV-880 and the keys of a connected MIDI keyboard.

Settings: INT & MIDI/INT

INT & MIDI : The sounds can be selected by both the **DATA** dial and a connected MIDI keyboard.

INT : The sounds can only be selected by the JV's **DATA** dial.

Display contrast

```
System  
Display contrast=05
```

This parameter adjusts the display contrast.

Range: 0 — 10

Higher values brighten the display.

Power up

Power Up Mode

```
System  
Power up=DEFAULT
```

This parameter determines the default condition of the JV-880 when the power is turned on.

Settings: LASTSET/DEFAULT

LASTSET : The Patch or Performance last selected before shut down is selected again at power up.

DEFAULT : Patch I01 or Performance I-01 is selected.

Preview Note

Note 1 — 4

```
System Preview
Note=A2  A3#  A4  OFF
  ↑      ↑      ↑      ↑
  Note 1 Note 2 Note 3 Note 4
```

This parameter determines the pitch of the Preview sound heard by pressing the **VOLUME** knob; four pitches (Notes 1 — 4) are available.

Each time the **VOLUME** knob is pressed, one of the four pitches is selected; Note 1, Note 2, Note 3 or Note 4.

Range: For each Note (1 — 4): C -1 — G9/OFF
No sound is output when this parameter is set to OFF.

* If all Notes (1 — 4) are set to OFF, no Preview sound is heard when the **VOLUME** knob is pressed.

Preview Velocity

velocity 1 — 4

```
System Preview
Velocity=01  40  80  127
  ↑      ↑      ↑      ↑
  Note 1 Note 2 Note 3 Note 4
```

This parameter determines the volume level of each note (1 — 4) of the Preview sound.

Range: For each Note (1 — 4): 1 — 127

Section

6

EDITING PATCHES

PATCH EDIT MODE

WHAT IS THE PATCH EDIT MODE?

In the Patch Edit mode, you can select a single Patch and edit the various elements (mainly Tones) to create original sounds.

When creating a Patch, it is helpful to think of it as carefully layering Tones.

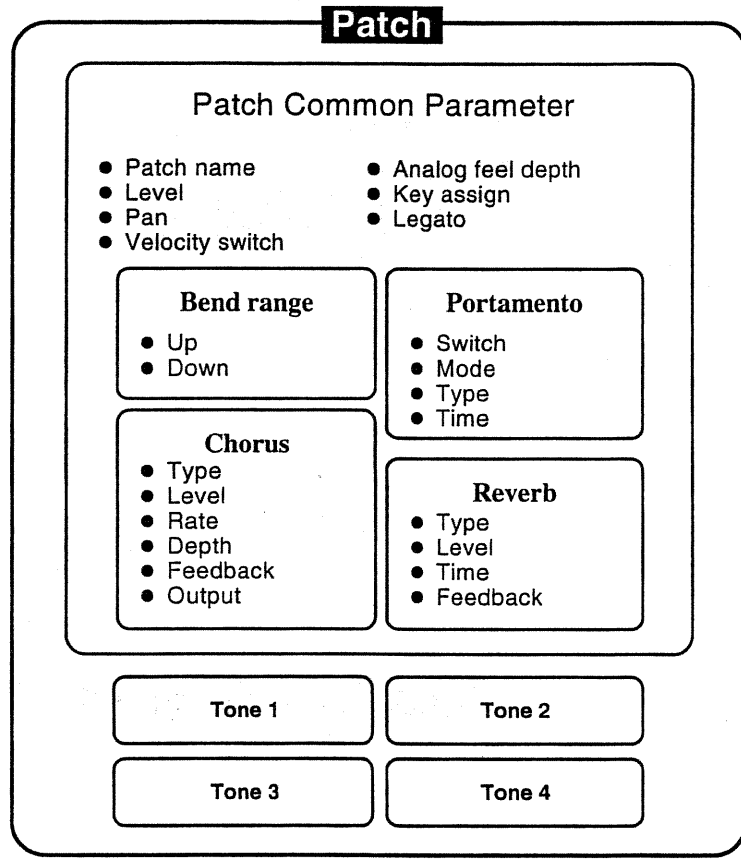

The parameters that comprise a Patch (Patch parameters) are divided into the categories shown below.

Patch Common Parameters

These are the parameters which are common to an entire Patch and are not affected by the settings for each Tone. The parameters for naming a Patch, and settings for chorus/reverb volume, pan and bend range belong to this group.

Tone Parameters

These parameters let you shape the sound of each Tone individually. The quality of sound, frequency, volume, and how they are to be changed, can be determined. The main work in crafting sounds with a synthesizer is in setting and adjusting these parameters. The Tone parameters make it possible to subtly alter a sound, or “synthesize” a completely new one. See P.2-1 for the details on Tones.

[How a Tone parameter is organized]

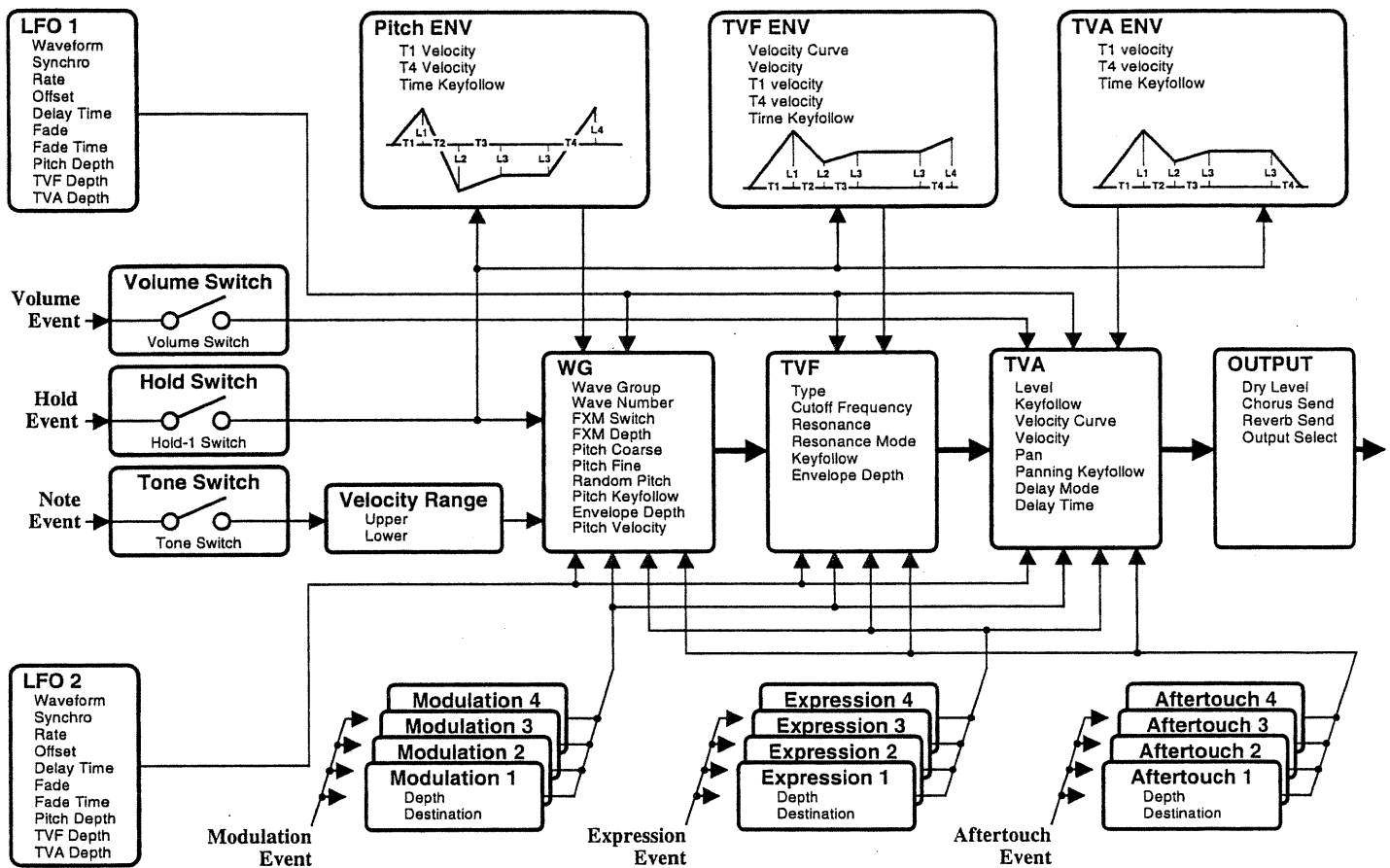

OPERATION GUIDE

- ① Select the Patch Edit mode.
Press **EDIT** from the Patch Play mode. (The indicator lights.)

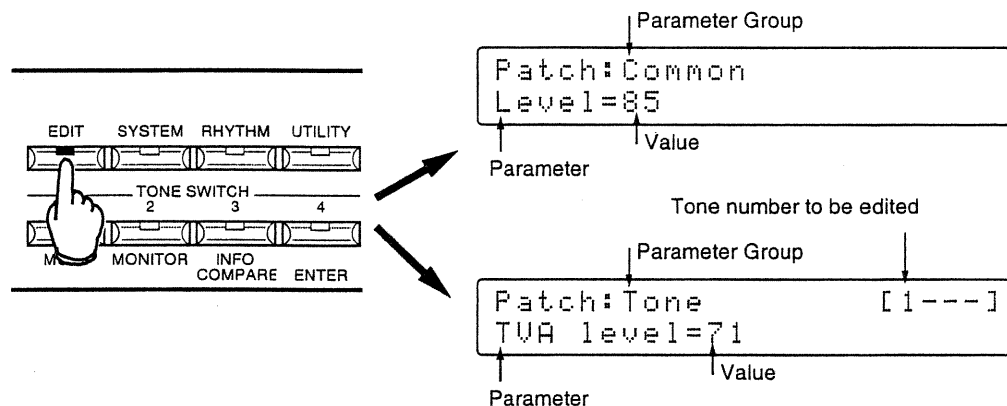

- ② Move the cursor to the upper part of the display using **◀ CURSOR ▶**.

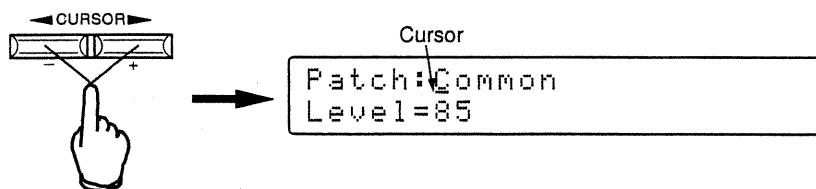

- ③ Select the group or type of parameter to be edited.
By rotating the **DATA** dial, you can select "Common" when editing Patch Common parameters, or "Tone" when editing Tone parameters.

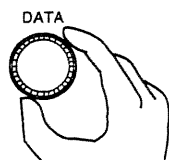

- * Skip to step ⑤ if you've selected "Common."
- ④ Select the Tone to be edited.
Press and hold **TONE SELECT** and then press the **TONE SWITCH** button corresponding to the Tone number you wish to edit.

Each press of **TONE SWITCH** changes the button indicator from flashing to off; the indicator flashes when the Tone is selected.

The selected Tone number is indicated at the top right of the display.

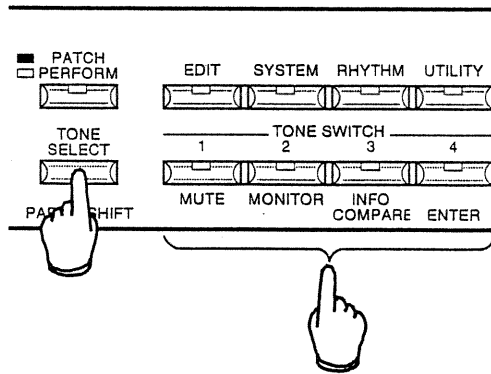

It is also possible to select several Tones simultaneously.

(In this case, all the selected Tones will be set the same way.) The Tone number which was last selected is displayed in the LCD, and other selected Tone numbers are indicated by an asterisk “*”.

(When several tones are selected.)

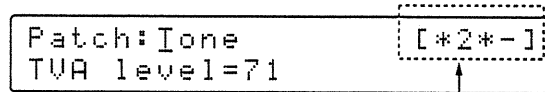

Tones 1 — 3 are selected.

- ⑤ Move the cursor to the parameter name field of the display using **◀ CURSOR ▶**.

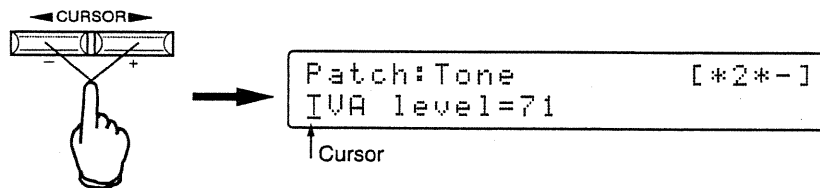

- ⑥ Select the parameter to be edited.

- ◆ Rotating the **DATA** dial changes the parameters one by one.

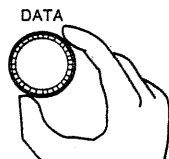

- ◆ Simultaneously hold down and rotate the **DATA** dial to jump to a certain parameter, skipping the parameters in between.

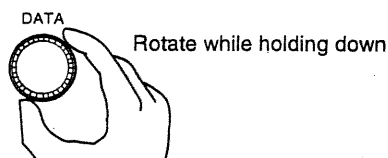

* The parameters which can be selected when turning around the DATA dial are shown below.

Patch Common Parameter	Tone Parameter
Patch name	Volume switch
Level	Hold - 1 switch
Pan	Velocity range
Velocity switch	Modulation 1
Chorus type	Aftertouch 1
Reverb type	Expression 1
Analog feel	LFO1 waveform
Key assign	LFO2 waveform
Legato	WGwave group
Bend range	P - ENV T1 velocity
Portamento switch	TVF type
Portamento time	F - ENV velocity curve
	TVA level
	A - ENV T1 velocity
	Output dry level

⑦ Move the cursor to the value field in the display using **◀ CURSOR ▶**.

⑧ Change the value.

- ◆ Rotate the **DATA** dial to change the value in small steps.
- ◆ Simultaneously hold down and rotate the **DATA** dial to change the value in large jumps.
- ◆ Press the **DATA** dial twice quickly to return to the originally set value. Press the dial twice quickly again to restore the value you set previous.



⑨ Repeat steps ② through ⑧ as necessary.

⑩ Execute the Write operation (See P.9-3) to store the settings.

Press **EDIT** to exit the Patch Edit mode.

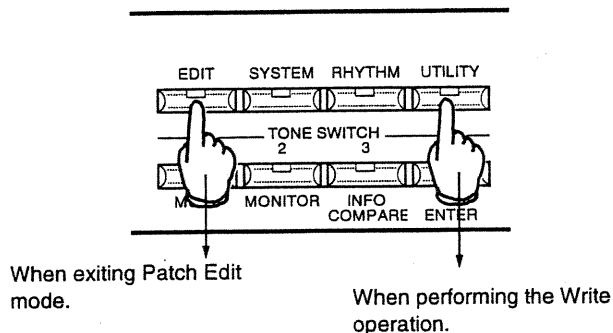

Parameters can be changed regardless of the cursor position by simultaneously holding down **PARAM SHIFT** and pressing **+**/**-**, when selecting the parameter to be edited (step ⑥).

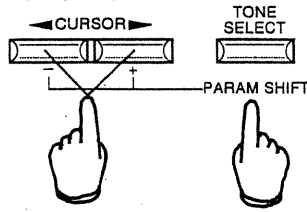

Tone On/Off Switches

The **TONE SWITCH** buttons (1 — 4) function as on/off switches for individual Tones. When on, the button indicator lights and the Tone can be played.

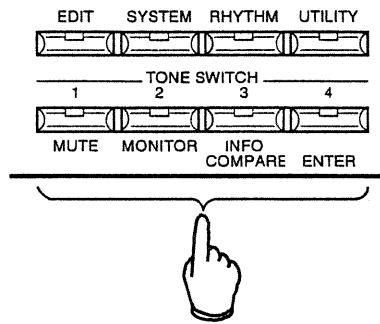

* The on/off setting of a Tone is stored as a Patch setting.

Preview Function

A Tone can be heard (previewed) by pressing the **VOLUME** knob.



* Tones whose **TONE SWITCH** buttons are On will be heard.

* If all **TONE SWITCH** buttons are Off, no preview sound will be heard.

PARAMETER FUNCTIONS

Note

Some of the parameters explained in this section may not be active, depending on settings in the System Common parameters. These inactive parameters are not displayed in the LCD. For such parameters, the relevant System Common parameters are described at the side of the LCD illustration.

Patch Common Parameters

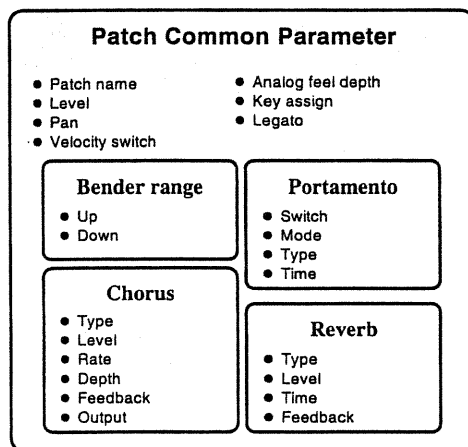

Patch name

```
Patch:Common  
Patch name=JV Strings
```

A name of up to 12 characters can be assigned to the edited Patch.

Use **CURSOR** to move the cursor to the part of the display in which the name appears, then select the desired characters with the **DATA** dial.

Available characters: space, A—Z, a—z, 1—9, 0, +, -, *, /, #, !, , .

* The character group (space ↔ A ↔ a ↔ 1 ↔ +) changes when you simultaneously press and rotate the **DATA** dial.

Patch Level

```
Patch:Common  
Level=127
```

This parameter determines the Patch level (sound volume). The TVA level (See P.6-43) is set for each Tone of a Patch, but this parameter determines the overall level of the Patch.

Range: 0 — 127

The greater the value, the greater the level.

Patch Pan

```
Patch:Common  
Pan=L20
```

This parameter determines the stereo position of the Patch.

The pan position (See P.6-45) is set for each Tone of the Patch. Each Tone moves from its current position to the position set here.

Range: L64 — 0 — 63R

L64 is the farthest left; 0 is center; and 63R the farthest right.

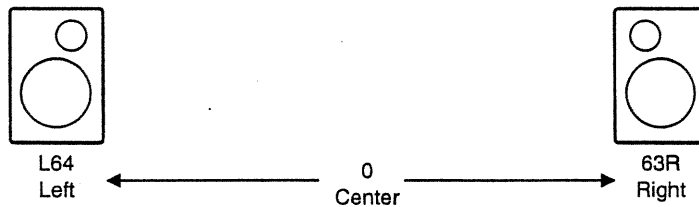

Velocity switch

```
Patch:Common  
Velocity switch=ON
```

This parameter determines whether the velocity range setting of the Tone parameter (See P.6-17) is effective (ON) or not.

Settings: ON/OFF

Chorus type

```
Patch:Common  
Chorus type=CHORUS2
```

Output mode = 2OUT
Chorus switch = ON

This parameter determines the type of chorus effect.

Settings: CHORUS 1 — 3

CHORUS1	Standard chorus
CHORUS2	Chorus with a slow modulation rate. It can also be used as a flanger effect by applying feedback.
CHORUS3	Chorus with deep modulation, creating a wide variation in pitch.

Chorus adds depth and warmth to sounds. For example, adding chorus to orchestral strings creates a warmer, more expansive sound. Brightness and depth are enhanced when the chorus effect is added to electric piano and bell sounds.

Chorus also lets you create movement and vibrato by modulating the sound. The speed of the modulation is set by the rate, and the depth of modulation is set by the depth. Using this with LFO (Low Frequency Oscillation) allows you to create a highly animated, complex modulation effect.

Chorus level

```
Patch:Common  
Chorus level=25
```

Output mode = 2OUT
Chorus switch = ON

This parameter determines the level of the chorus sound.

Range: 0 — 127

The greater the value, the greater the level.

Chorus rate

```
Patch:Common  
Chorus rate=60
```

Output mode = 2OUT
Chorus switch = ON

This parameter determines the speed of the modulation of the chorus sound.

Range: 0 — 127

The greater the value, the faster the modulation.

Chorus depth

```
Patch:Common  
Chorus depth=30
```

Output mode = 2OUT
Chorus switch = ON

This parameter determines the depth of the modulation of the chorus sound.

Range: 0 — 127

The greater the value, the greater the depth of the modulation.

Chorus feedback

```
Patch:Common  
Chorus feedback=30
```

Output mode = 2OUT
Chorus switch = ON

This parameter determines the level of the re-routed (feedback) chorus sound. A richer, more complex chorus effect can be gained by setting this parameter.

Range: 0 — 127

The greater the value, the greater the feedback level.

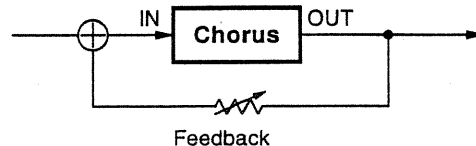

* The sound may become distorted if the feedback level is set too high.

Chorus output

```
Patch:Common  
Chorus output=MIX
```

Output mode = 2OUT
Chorus switch = ON

This parameter determines the destination of the chorus sound output.

Settings: MIX/REVERB

MIX : The chorus sound and the reverb sound are mixed with the dry (unprocessed) sound.

REVERB : The chorus sound is mixed with the dry signal after reverb is added.

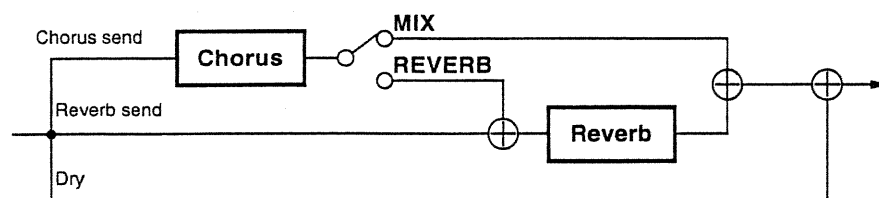

Reverb type

```
Patch:Common  
Reverb type=HALL2
```

Output mode = 2OUT
Reverb switch = ON

This parameter determines the type of reverb.

Settings: ROOM1 — 2/STAGE1 — 2/HALL1 — 2/DELAY/PAN-DLY

ROOM1	Reverb with short and dense reverberant wash
ROOM2	Reverb with short and sparse reverberant wash
STAGE1	Reverb with strong reverberant wash in the final portion of the sound
STAGE2	Reverb with strong initial reflections
HALL1	Reverb with distinct echo
HALL2	Reverb with rich echo
DELAY	Conventional delay
PAN — DLY	Delay in which the reflected sound pans left and right

The reverb effect simulates the wash of reflected sounds that follow the direct sound heard inside a room or hall. It lends a feeling of distance and spaciousness to the overall sound, and makes it richer and more natural sounding. The Reverb type and reverb time simulate the material of the walls and size of the space, and the reverb level determines the intensity of the reverberation.

Reverb level

```
Patch:Common  
Reverb level=40
```

Output mode = 2OUT
Reverb switch = ON

This parameter determines the level of the reverb sound.

Range: 0 — 127

The greater the value, the greater the level.

Reverb time

```
Patch:Common
Reverb time=30
```

Output mode = 2OUT
Reverb switch = ON

When ROOM1 — HALL2 is selected as the reverb type, this parameter determines the time (duration) of the reflected-sound; when DELAY/PAN-DLY is selected, this parameter determines the delay time.

Range: 0 — 127

The greater the value, the longer the reverb time or delay time.

When Reverb is selected:

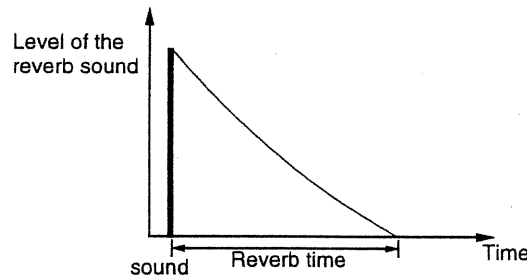

When Delay is selected:

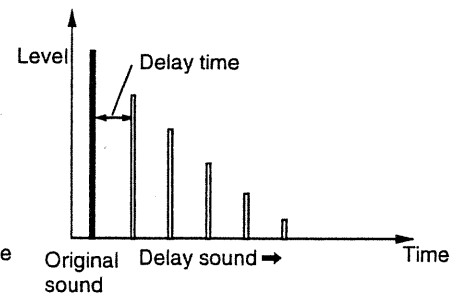

Reverb feedback

```
Patch:Common
Reverb feedback=20
```

Output mode = 2OUT
Reverb switch = ON

When set to DELAY or PAN-DELAY, this parameter determines the re-routed level (feedback) of the delay sound in the delay unit.

Range: 0 — 127

The greater the value, the greater the feedback level.

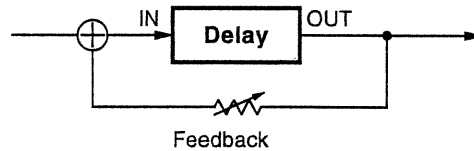

Analog feel depth

```
Patch:Common  
Analog feel depth=20
```

This parameter determines the depth of the Analog Feel effect. As this effect adds a special modulation (1/f modulation) to the level (volume) and to the pitch, a more natural (less digital!) sound can be created.

Range: 0 — 127

The greater the value, the greater the modulation.

Chorus/reverb are used to apply effects to the Tones, and the Analog Feel parameter applies the 1/f modulation at a point just after the generation of the original waveform.

The 1/f modulation includes special types of modulation noises, such as the murmur of a stream or the rustling sound of a gentle breeze.

Key assign

```
Patch:Common  
Key assign=POLY
```

This parameter determines whether the Patch sounds polyphonically (POLY) or monophonically (SOLO).

Settings: POLY/SOLO

POLY : Several notes can be played at one time.

SOLO : Only one note at a time can be played.

Legato

```
Patch:Common  
Legato=ON
```

This parameter determines whether the Legato function is on or off.

Settings: ON/OFF

ON : When a note is held, while another note is played, only the pitch changes while the envelope and LFO remain constant.

OFF : The legato function is not used.

* The Legato effect is not active when the Key assign is set to POLY, even if the Legato parameter is set to ON.

Bender range

```
Patch:Common  
Bend range D=-12 U=+03
```

Bend range receive switch = ON

This parameter determines the range over which the pitch is changed, when pitch bend data is received from an external MIDI device. The up and down ranges of the pitch bend can be set independently. Pitch bend is usually executed from a bender/modulation lever on a MIDI keyboard, and is effective especially when playing guitar sounds and some sound effects.

Settings: D (down) = -48 — 0/U (up) = 0 — 12

D : This parameter determines the downward range of the pitch in semitone steps.

U : This parameter determines the upward range of the pitch in semitone steps.

When both the up and down values are set to 0, the pitch does not change even when pitch bend data is received.

Porta switch

```
Patch:Common  
Porta switch=OFF
```

This parameter determines whether the Portamento effect is used (ON) or not. The Portamento function creates a smooth pitch change between notes played.

Settings: ON/OFF

Porta mode

```
Patch:Common  
Porta mode=NORMAL
```

This parameter determines how the Portamento effect is applied.

Settings: LEGATO/NORMAL

LEGATO : Portamento is applied only when notes are played in a legato manner (i.e., releasing one key only after the second key has been pressed).

NORMAL : Portamento is always applied.

Porta type

Portamento Type.....

```
Patch:Common  
Porta type=TIME
```

This parameter determines the type of Portamento effect.

Settings: TIME/RATE

TIME : The length of the time it takes to move from one note to the next is constant, regardless of the pitch interval between the two notes.

RATE : The time it takes to move from one note to the next depends on how large the pitch interval is between the two notes.

When set to TIME :

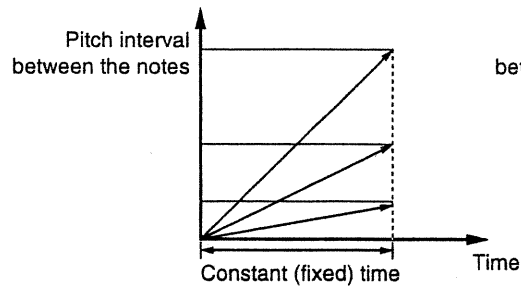

When set to RATE :

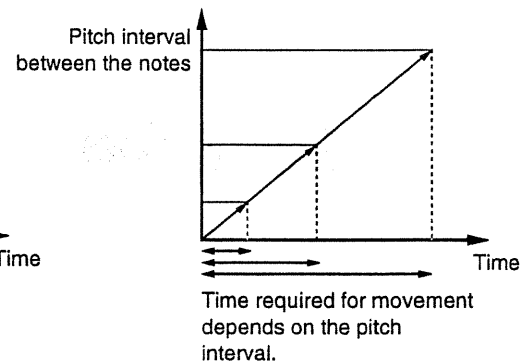

Porta time

Portamento Time.....

```
Patch:Common  
Porta time=50
```

This parameter determines the time it takes for the pitch to shift between two notes when using the Portamento effect.

Range: 0 — 127

The greater the value, the slower the pitch shift speed.

Tone parameters

Volume Switch

```
Patch:Tone      [-*3*]  
Volume switch=OFF
```

Volume receive switch = ON

This parameter determines whether a Tone responds to MIDI volume data or not.

Settings: ON/OFF

ON : The volume of a Tone changes in response to received MIDI volume data.

OFF : MIDI volume data is ignored.

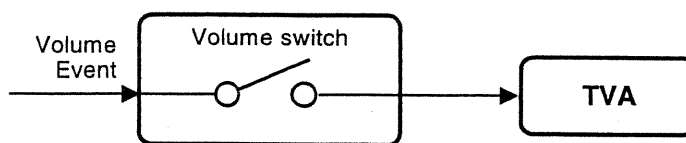

* The MIDI standard assigns MIDI volume to Control Change number 7.

Hold-1 Switch

```
Patch:Tone      [1*--]  
Hold -1 switch=ON
```

Control Change receive switch = ON

This parameter determines whether the Tone responds to MIDI Hold - 1 messages or not.

Settings: ON/OFF

ON : Sustain effect is applied when MIDI Hold - 1 data is received.

OFF : MIDI Hold - 1 data is ignored.

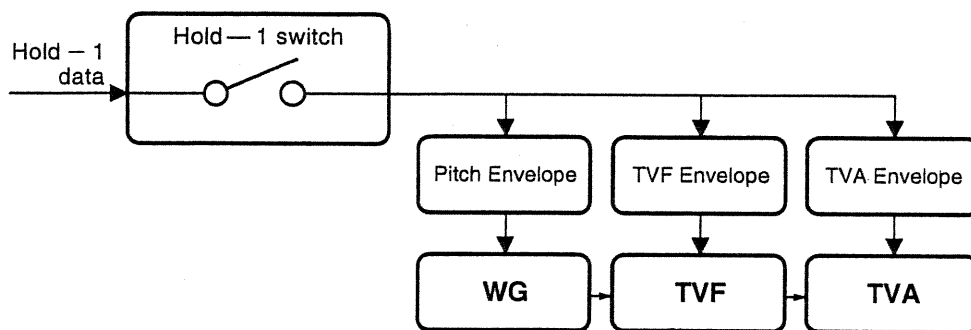

* The MIDI standard assigns Hold - 1 to Control Change number 64.

Velo Range

Velocity Range

```
Patch:Tone [1---]
Velo range=00 ↔ 127
```

This parameter determines the velocity range (lower/upper) over which each Tone sounds.

Range: lower = 0 — 127/upper = 0 — 127

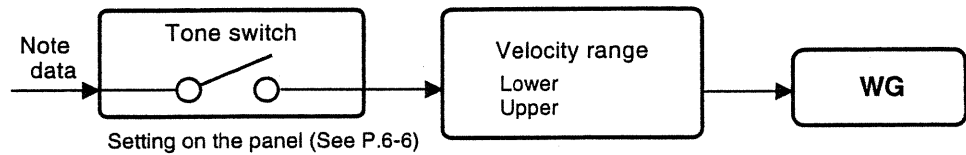

MIDI Control of the Tone Parameters

Tone parameters can be controlled by Control Changes and aftertouch data from an external MIDI device. A maximum of 4 Tone parameters can be controlled simultaneously by each data type.

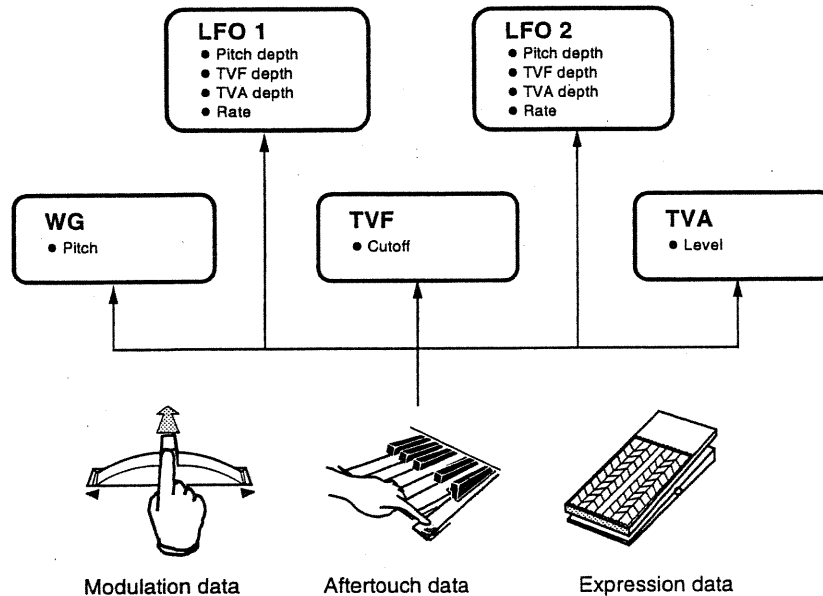

Mod1 — 4

Modulation Control 1 — 4

```

Patch:Tone      [1---]
Mod1=+63 :PITCH

Patch:Tone      [1---]
Mod2=00  :PITCH LF01

Patch:Tone      [1---]
Mod3=00  :PITCH LF02

Patch:Tone      [1---]
Mod4=00  :PITCH LF01

```

Modulation receive switch = ON

↑ Sensitivity ↑ Parameter to be controlled

This parameter determines which parameter the modulation data is to control, and the sensitivity (or range over which the parameter changes).

After1 — 4

After Touch Control 1 — 4

```

Patch:Tone      [1---]
After1=+10 :CUTOFF

Patch:Tone      [1---]
After2=-05  :RSONANCE

Patch:Tone      [1---]
After3=-05  :PITCH LF02

Patch:Tone      [1---]
After4=-05  :LF01 RATE

```

Aftertouch receive switch = ON

↑ Sensitivity ↑ Parameter to be controlled

This parameter determines which parameter the aftertouch data is to control, and the sensitivity (or range over which the parameter changes).

Exp1 — 4

Expression Control 1 — 4

```

Patch:Tone      [1---]
Exp1=+50 :LF02 RATE

Patch:Tone      [1---]
Exp2=-30  :TVF LF01

Patch:Tone      [1---]
Exp3=-30  :TVA LF02

Patch:Tone      [1---]
Exp4=-30  :TVA LF01

```

Control change receive switch = ON

↑ Sensitivity ↑ Parameter to be controlled

This parameter determines which parameter the expression data is to control, and the sensitivity (or range over which the parameter changes).

The available parameters and the sensitivity range are the same for modulation control, aftertouch control and expression control.

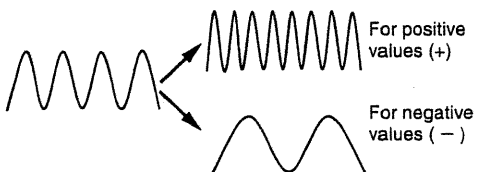
Destination, or parameters which can be controlled		adjustable range	Comments
Display	Meaning		
OFF	Control is disabled		
PITCH	Pitch (in semitone units)	- 63 — + 63	
CUTOFF	Cutoff frequency	- 63 — + 63	When set to a positive value (+), the change is greater or higher, and when set to a negative value (-), the change is smaller or lower.
RESONANCE	Resonance	- 63 — + 63	
LEVEL	Level (volume)	- 63 — + 63	
PITCH LFO1	Depth of LFO1 which is applied to pitch	- 63 — + 63	The phase of the LFO is reverse for positive (+) and negative (-). For both positive and negative settings, the effect becomes more pronounced as the value is set further from 0.
PITCH LFO2	Depth of LFO2 which is applied to pitch	- 63 — + 63	
TVF LFO1	Depth of LFO1 which is applied to cutoff	- 63 — + 63	
TVF LFO 2	Depth of LFO2 which is applied to cutoff	- 63 — + 63	
TVA LFO1	Depth of LFO1 which is applied to volume	- 63 — + 63	
TVA LFO 2	Depth of LFO2 which is applied to volume	- 63 — + 63	
LFO1 RATE	Rate of LFO1	- 63 — + 63	For positive values(+), the LFO frequency is high (fast), and for negative values(-), the frequency is low(slow). 
LFO2 RATE	Rate of LFO2	- 63 — + 63	

(Example) When changing the TVA LFO1 parameter with the modulation lever:

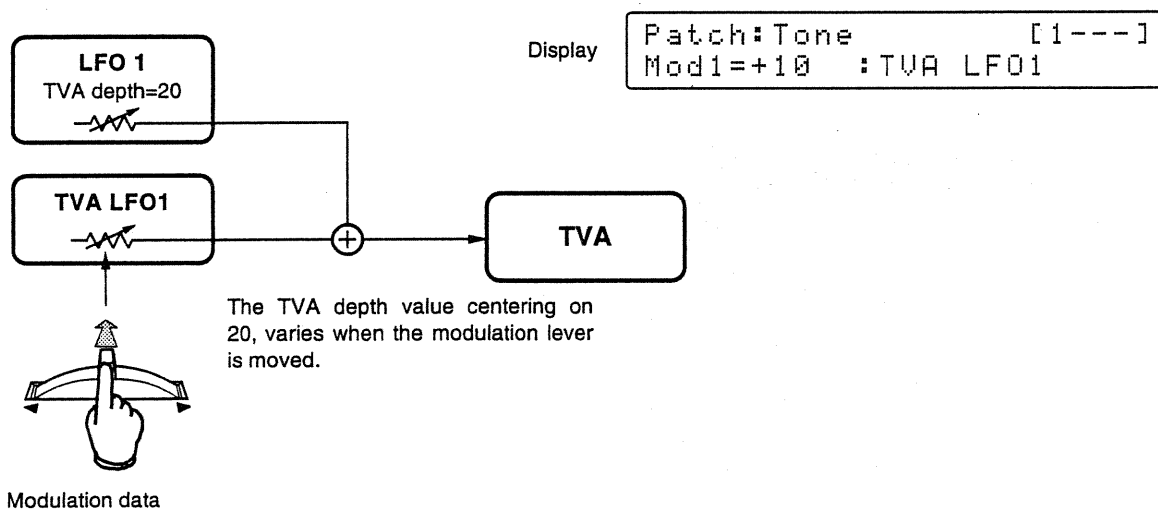

* The MIDI standard assigns expression control to Control Change number 11, and modulation to Control Change number 1. Aftertouch is defined separately from Control Change data. (See the MIDI Implementation chart.)

LFO1, 2 (LFO parameters)

LFO is an abbreviation for Low Frequency Oscillator, and is used to periodically modulate the pitch of the Tone, cutoff frequency of the filter, and the volume. LFO is applied to the WG, TVF and TVA (explained below) for creating tremolo, pitch change, and other effects. The JV-880 has two independent LFOs (LFO1 and LFO2) for each Tone.

* The parameters are the same for both LFO1 and 2.

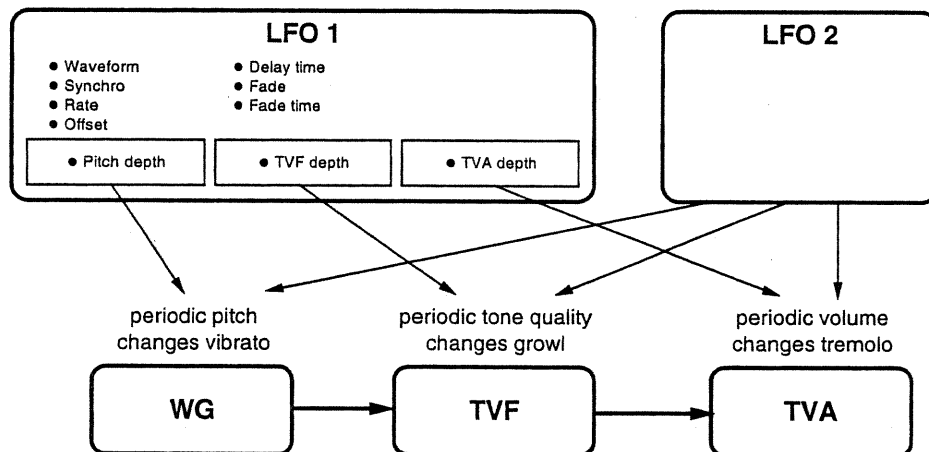

LFO waveform

```
Patch:Tone [1---]
LFO1 waveform=SQR▷

Patch:Tone [1---]
LFO2 waveform=SQR▷
```

This parameter lets you select the waveform of the LFO. A mark indicating the shape of the waveform is displayed along with the name in the LCD.

Settings: TRI/SIN/SAW/SQR/RND1 — 2

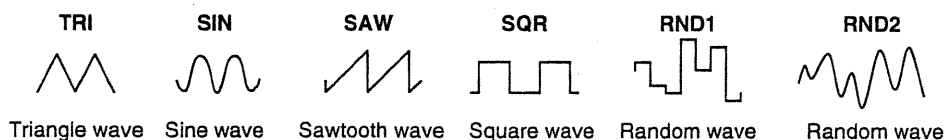

In order to add modulation and vibrato, select the sine wave or triangle wave, and apply it in small degrees to the level (volume) and the pitch. The random waveforms are useful in creating special sound effects and modulation.

LFO synchro

```
Patch:Tone [1---]  
LFO1 synchro=OFF
```

```
Patch:Tone [1---]  
LFO2 synchro=ON
```

This parameter determines whether or not the Note On is synchronized (ON) with the start of the LFO effect.

Settings: ON/OFF

ON : Since the LFO frequency cycle begins from the same point with each Note On, the phase of the LFO differs for each note played.

OFF : Regardless of when the Note On occurs, the phase of the LFO is synchronous for all notes played.

Synchro=ON

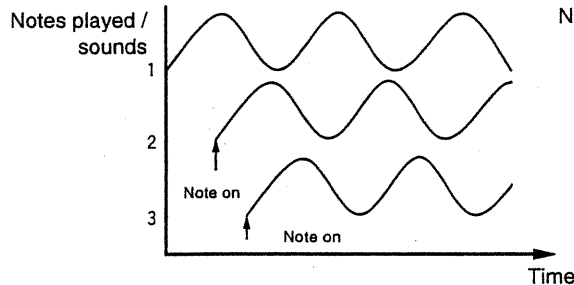

Synchro=OFF

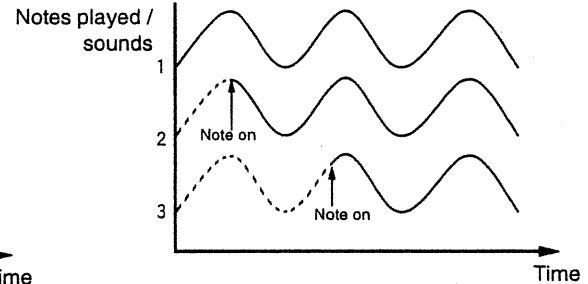

With LFO synchro set to ON, try playing an arpeggiated chord. The set LFO frequency cycle begins with each note played, creating a random, natural modulation. When this parameter is set to OFF, the modulation is uniform for all the notes, since one LFO is applied to all the sounds.

LFO rate

```
Patch:Tone [1---]  
LFO1 rate=60
```

```
Patch:Tone [1---]  
LFO2 rate=20
```

This parameter determines the speed of the LFO.

Range: 0 — 127

The greater the value, the faster the speed.

Setting a low rate is good for vibrato and tremolo effects, while higher values create more unusual, distorted sounds and effects.

LFO offset

```
Patch:Tone      [1---]
LFO1 offset=+50
```

```
Patch:Tone      [1---]
LFO2 offset=+50
```

This parameter determines how much the waveform is shifted up or down with respect to the central value (pitch/cutoff frequency) of the LFO waveform.

Settings: -100/-50/0/+50/+100

Positive (+) values : Taking the lowest parts of the waveform as the minimum value, the waveform is shifted up along the X-axis. The center of the waveform becomes higher or greater than the original pitch or level.

0 : No shift in the waveform.

Negative (-) values : Taking the highest parts of the waveform as the maximum value, the waveform is shifted down along the X-axis. The center of the waveform becomes lower than the original pitch or level.

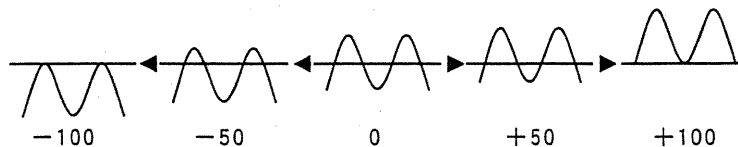

You can create automatic trills by setting the offset of a square waveform to +100 or -100, and applying it to the pitch with an appropriate depth setting.

LFO delay

```
Patch:Tone      [1---]
LFO1 delay=KEY-OFF
```

```
Patch:Tone      [1---]
LFO2 delay=KEY-OFF
```

This parameter determines the time that elapses between the start of the Tone's sound (Note On) and the start of the LFO.

Range: 0 — 127/KEY-OFF

0 — 127 : The greater the value, the longer the delay before the LFO is applied.

KEY-OFF : LFO is applied only after the note is released.

You should use delay when you don't want to have the LFO start at the same time as the sound itself starts, or when you want to simulate the sound of an actual musical instrument in which vibrato is usually applied after the sound begins. In such a case, the depth of the vibrato can be made to gradually increase by using the fade time settings, letting you create natural vibrato and tremolo effects.

LFO fade

```
Patch:Tone          [1---]  
LFO1 fade=IN
```

```
Patch:Tone          [1---]  
LFO2 fade=IN
```

This parameter determines the time over which the LFO is applied.

Settings: IN/OUT

IN : The LFO is applied gradually after the Note On, according to the set LFO fade time.

OUT : The LFO is applied from the Note On until the end of the delay time, and then gradually fades out according to the set fade time.

* When the delay time is set to KEY-OFF, this effect is applied only after the note is released.

LFO fade time

```
Patch:Tone          [1---]  
LFO1 fade time=50
```

```
Patch:Tone          [1---]  
LFO2 fade time=50
```

This parameter determines the time of the fade-in or the fade-out of the LFO.

Range: 0 — 127

The greater the value, the longer the fade time.

Fade = IN

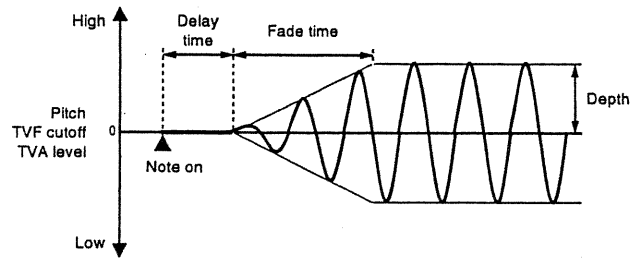

Fade = OUT

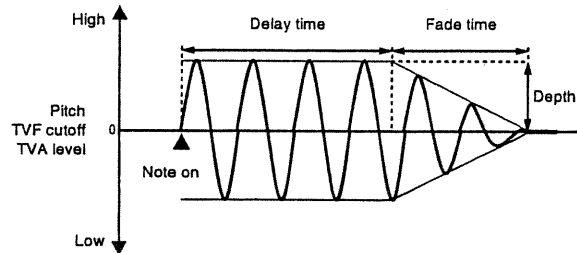

LFO pitch depth

```
Patch:Tone      [1---]  
LFO1 pitch depth=+20
```

```
Patch:Tone      [1---]  
LFO2 pitch depth=+20
```

This parameter determines the depth of LFO as applied to the pitch of a Tone.

Range: - 63 — +63

The further the value is set from 0, the more pronounced the variation in pitch. The further the value is set from 0, the more pronounced the variation in pitch and vibrato effect.

LFO TVF depth

```
Patch:Tone      [1---]  
LFO1 TVF depth=-30
```

```
Patch:Tone      [1---]  
LFO2 TVF depth=-30
```

This parameter determines the depth of LFO as applied to the cutoff frequency of a Tone.

Range: - 63 — +63

The further the value is set from 0, the more pronounced the "growling" sound of the filter sweep.

LFO TVA depth

```
Patch:Tone [1---]
LFO1 TVA depth=00
```

```
Patch:Tone [1---]
LFO2 TVA depth=00
```

This parameter determines the depth of LFO, as applied to the level of a Tone.

Range: - 63 — +63

The further the value is set from 0, the more pronounced the tremolo (swell) effect.

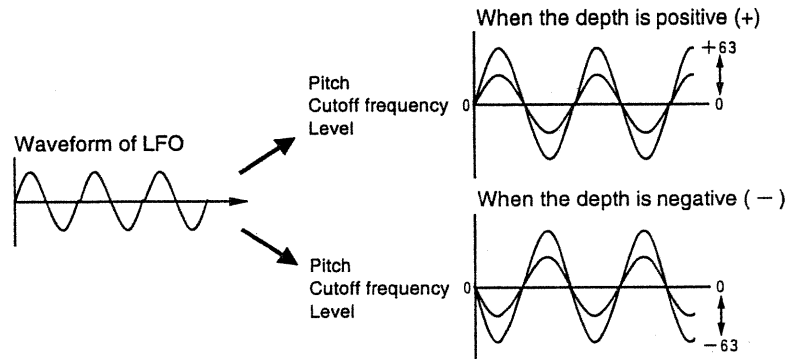

The manner of changing the pitch and volume are reversed, when the depth values are positive (+) and negative (-). For example, the phase of the modulation becomes reversed when setting the depth to a positive value for one Tone, and setting the same amount of the depth on the negative side for another Tone. Using this operation, different Tones can be sounded alternately, and the sounds can be moved back and forth in the stereo image in combination with the pan function (explained later). You can create a bell-like effect if you set the offset depth of the saw waveform to 100, with a negative value for the level and cutoff.

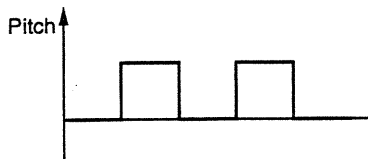

Make the following pitch modulation settings to the continuous portion of the sound

Waveform : Square wave
Offset : -100
depth : +14

By using the above settings, a semitone trill will be produced.

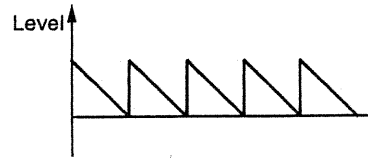

Make the following TVA modulation settings to the continuous portion of the sound

Waveform : Square wave
Offset : +100
Depth : -63

By using the above settings, the sound will ring out continuously like a bell.

● WG (Wave Generator parameters)

The wave generator accesses the waveform data stored in internal memory, on PCM Cards or an expansion board, and generates an original waveform. This section of parameters allows you to select the waveform, which is the basic building block of the sound, and make pitch-related settings.

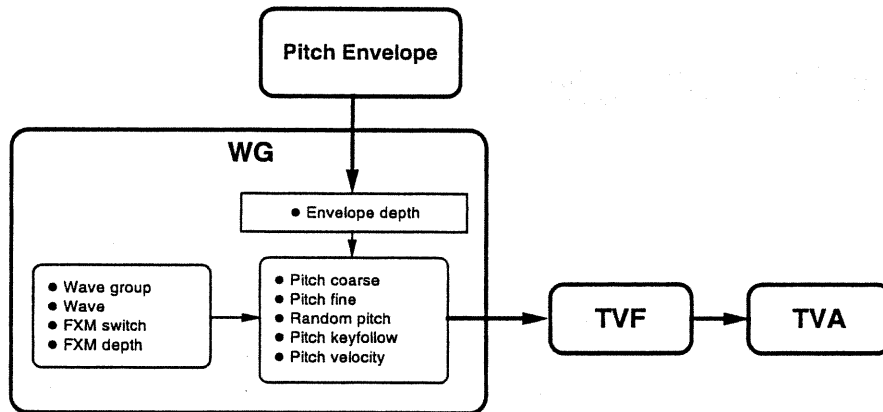

WG wave group

```
Patch:Tone      [-2--]
WG wave group=INT
```

This parameter determines the waveform group that is to be used. The JV-880 has 129 internal waveforms. The waveforms on the optional expansion board (SR-JV80 series) and on PCM Cards (SO-PCM1 series) can also be used.

Settings: INT (internal)/EXP (expansion board)/ PCM (PCM Card)

- * "PCM" or "EXP" cannot be selected if an expansion board has not been installed or a PCM Card has not been properly inserted into the PCM CARD slot.

How to Insert the PCM Card

When using waveforms of a PCM card (SO-PCM1 series), insert the PCM card in the PCM card slot on the front panel with the label side up.

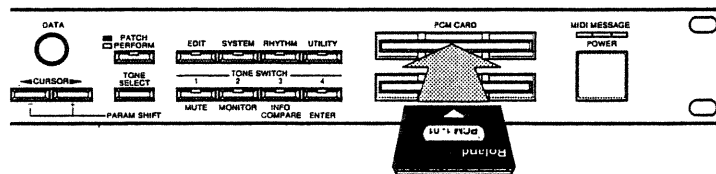

- * See P.10-54 for instructions on installing the expansion board.

WG wave

```
Patch:Tone      [-2--]  
WG wave=100 POWER Tom Hi
```

This parameter determines the number of the waveform to be used. The number and the name of the waveform are displayed in the LCD.

WG FXM switch

```
Patch:Tone      [-2--]  
WG FXM switch=OFF
```

This parameter determines whether the FXM (frequency cross modulation) function is on (ON) or not. New waveforms can be created by mixing (or cross-modulating) one waveform with another. FXM makes it possible to create unusually dynamic sounds.

Settings: ON/OFF

WG FXM depth

```
Patch:Tone      [-2--]  
WG FXM depth=05
```

This parameter determines the depth of the FXM function.

Setting: 1 — 16

The greater the value, the deeper the FXM effect.

WG pitch coarse

```
Patch:Tone      [-2--]  
WG pitch coarse=+02
```

This parameter offsets the pitch of the Tone in semitone steps.

Range: - 48 — +48

The pitch is shifted higher than normal when the value is positive (+), and shifted lower when the value is negative (-).

WG pitch fine

```
Patch:Tone      [-2--]  
WG pitch fine=-10
```

This parameter offsets the pitch of the Tone in units of 1/100th of a semitone.

Range: - 50 — +50

The pitch is shifted higher than normal when the value is positive (+), and shifted lower when the value is negative (-).

The coarse/fine pitch shift parameters determine the basic pitch or tuning at which notes will sound. For example, when the fine pitch parameter of two Tones are set to slightly different values, a rich, "fat" sound results.

It is also possible to create special effects like "single key" chords, by setting the coarse pitch parameter of two or more Tones to appropriate values.

WG random pitch

```
Patch:Tone      [-2--]  
WG random pitch=1200
```

The pitch of the Tone is shifted over random amounts within the range set below. The value is expressed in units of 1/100th of a semitone.

Settings: 0/5/10/20/30/40/50/70/100/200/300/400/500/600/800/1200

The greater the value, the greater the random pitch shift range.

As this randomly detunes the pitch for each note played, it is particularly effective for reproducing the sound of fretless string instruments and percussion instruments.

WG pitch KF WG Pitch Keyfollow

```
Patch:Tone      [-2--]
WG pitch KF=+100
```

This parameter determines how the pitch of the Tone changes according to the note number. Note C4 (note number 60) is the standard or reference key.

Settings: -100/-70/-50/-30/-10/0/+10/+20/+30/+40/+50/+70/+100/+120/+150/+200

At a setting of +100, the pitch change over 12 keys is the standard octave.

Positive (+) values : The higher the note number, the higher the pitch. In addition, higher settings produce a greater pitch difference between successive notes.

0 : No change.

Negative (-) values : The larger the note number, the lower the pitch.

Keyfollow is normally set to +100.

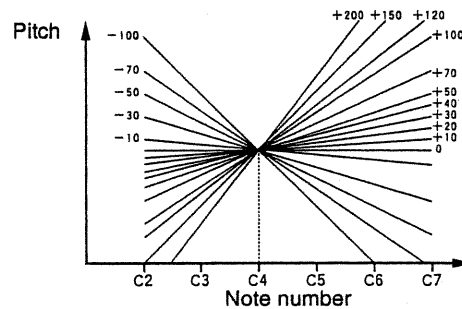

WG ENV depth

```
Patch:Tone      [-2--]
WG ENV depth=+10
```

This parameter determines the depth of the pitch envelope.

Range: -12 +12

Positive (+) values : The larger the pitch envelope level, the higher the pitch.

Negative (-) values : The larger the pitch envelope level, the lower the pitch.

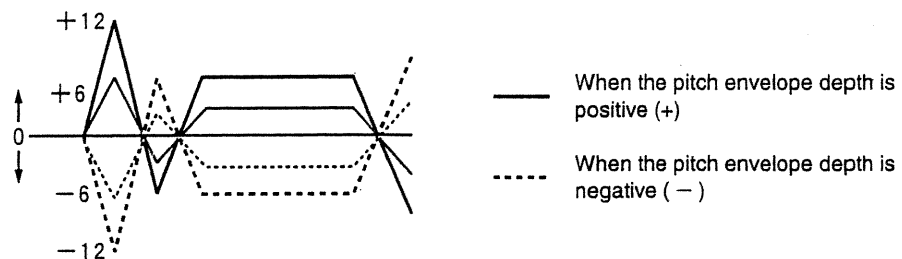

Envelope

The envelope makes changes in the pitch over time, within the range set by the envelope depth parameter. If you find that the pitch doesn't change as much as you want it to, even when the envelope is set to a high value, you can increase the depth. On the other hand, when you want to set the pitch to change in minute gradations, even though the pitch change itself is narrow, set the depth to a low value.

When simulating the sound of a human voice or choir, a more realistic sound can be obtained by making the initial pitch slightly lower than the main pitch. These parameters can also be used to imitate acoustic wind instruments, like the Japanese shakuhachi, the pitch of which often fluctuates according to the player's technique.

WG pitch velocity

```
Patch:Tone      [-2--]  
WG pitch velocity=+50
```

This parameter determines how velocity affects the pitch envelope level.

Range: -63 — +63

Positive (+) values : The greater the velocity, the greater the level.
0 : No change.
Negative (-) values : The lower the velocity, the greater the level.

● P-ENV (Pitch Envelope parameters)

The Pitch Envelope determines how the pitch (set in the WG parameters) changes over time.

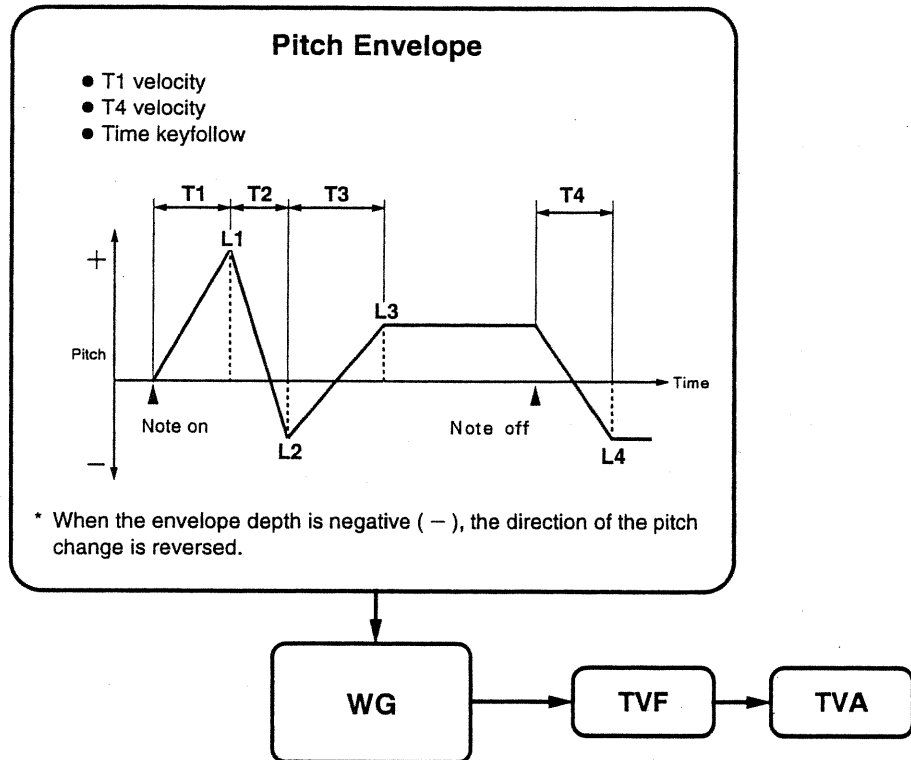

P-ENV T1 velocity

```
Patch:Tone          [-2--]
P-ENV T1 velocity=00
```

This parameter determines how the T1 time of the pitch envelope is affected by velocity.

Settings: - 100/ - 70/ - 50/ - 40/ - 30/ - 20/ - 10/0/+10/+20/+30/+40/+50/+70/+100

Positive (+) values : The greater the velocity, the longer the time.

0 : No change.

Negative (-) values : The greater the velocity, the shorter the time.

P-ENV T4 velocity

```
Patch:Tone      [-2--]  
P-ENV T4 velocity=+50
```

This parameter determines how the T4 time of the pitch envelope is affected by Note Off velocity.

Settings: - 100/ - 70/ - 50/ - 40/ - 30/ - 20/ - 10/0/+10/+20/+30/+40/+50/+70/+100

Positive (+) values : The greater the Note Off velocity, the longer the time.

0 : No change.

Negative (-) values : The greater the Note Off velocity, the shorter the time.

* This setting has no effect if the connected MIDI device does not transmit Note Off velocity.

P-ENV time KF

```
Patch:Tone      [-2--]  
P-ENV time KF=+20
```

The time of the pitch envelope can be made to change depending on the note number. The key C4 (note number 60) is the standard (reference key) of the envelope time.

Settings: - 100/ - 70/ - 50/ - 40/ - 30/ - 20/ - 10/0/+10/+20/+30/+40/+50/+70/+100

Positive (+) values : The higher the note number, the shorter the time from T2 to T4.

0 : No change.

Negative (-) values : The higher the note number, the longer the time.

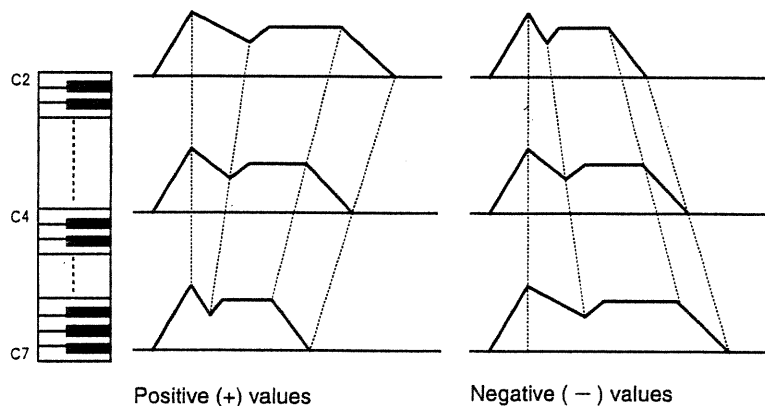

P-ENV T1/T2/T3/T4, L1/L2/L3/L4

Patch:Tone	[-2--]
P-ENV T1=05	L1=+40
Patch:Tone	[-2--]
P-ENV T2=10	L2=-10
Patch:Tone	[-2--]
P-ENV T3=20	L3=+50
Patch:Tone	[-2--]
P-ENV T4=05	L4=+40

These parameters determine the time settings (T1, T2, T3 and T4) and the level settings (L1, L2, L3 and L4) of the pitch envelope.

Each time setting (T) represents the time it takes for the pitch to change from one point to the next; for example, T1 is the time it takes the pitch to change from the Note On to L1.

The "L" parameters determine the amount by which the pitch is changed at each point.

Range: T = 0 — 127 / L = - 63 — +63

T : The greater the value, the longer the time it takes to reach the next level.

L : When the value is positive (+), the pitch is higher (lower) than standard pitch.
When the value is negative (-), the pitch is lower (higher) than standard pitch.

● TVF parameters

TVF stands for Time Variant Filter, a filter which changes over time.

The filter cuts a specific range of frequencies, and changes the brightness of the sound.

In this section, by setting the type of the filter and cutoff frequency, the sound generated by the WG and pitch envelope is processed.

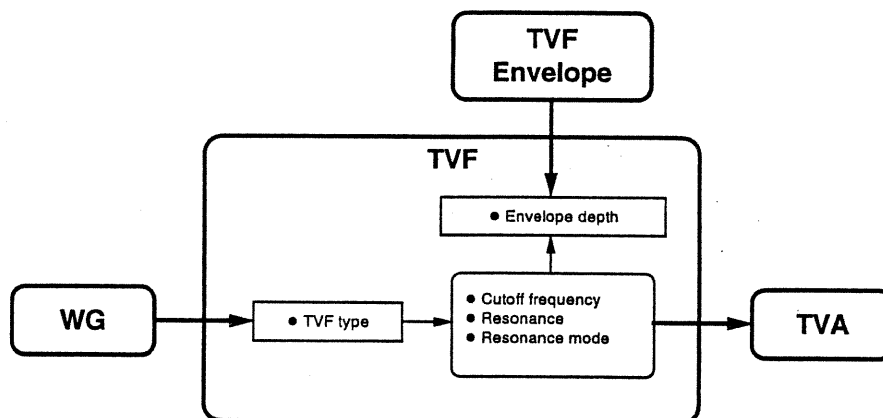

TVF type

```
Patch:Tone      [-2--]
TVF type=LPF
```

This parameter determines the filter type, or what frequencies are filtered (removed).

Settings: OFF/LPF/HPF

OFF : Filter doesn't function.

LPF : Low pass filter. This filter removes frequencies above the cutoff frequency, and is the more commonly used filter type. Since the high range frequencies are cut, the sound becomes more mellow.

HPF : High pass filter. This filter removes frequencies below the cutoff frequency. The sound becomes brighter as low range frequencies are removed.

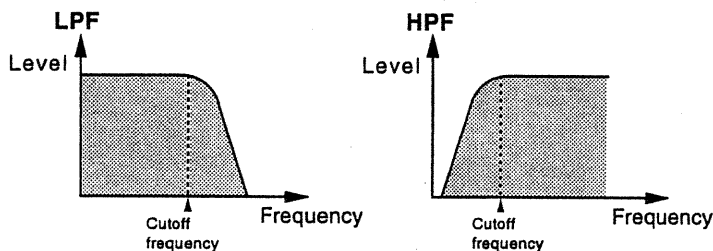

TVF cutoff freq

```
Patch:Tone      [-2--]  
TVF cutoff freq=70
```

This parameter determines the cutoff frequency, above or below which the TVF is applied to filter out the specified frequencies of the waveform.

Range: 0 — 127

The greater the value, the higher the cutoff frequency.

- ◆ If the filter has been set to LPF, lower cutoff frequency values will decrease the higher partials of the spectrum, causing the sound to become darker, and lower in volume.

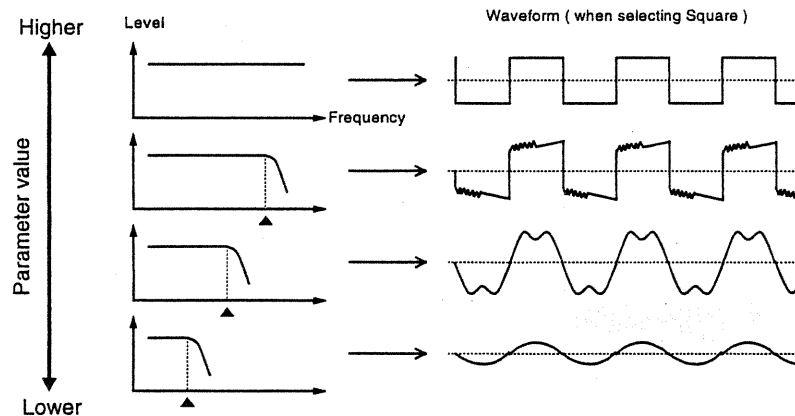

- ◆ If the filter has been set to HPF, higher cutoff frequency values will decrease the lower partials of the spectrum, causing the sound to become harder or brighter. Depending on the waveform, high cutoff frequency values may result in no sound if the selected waveform does not contain any partials in the frequency range that is allowed to pass.

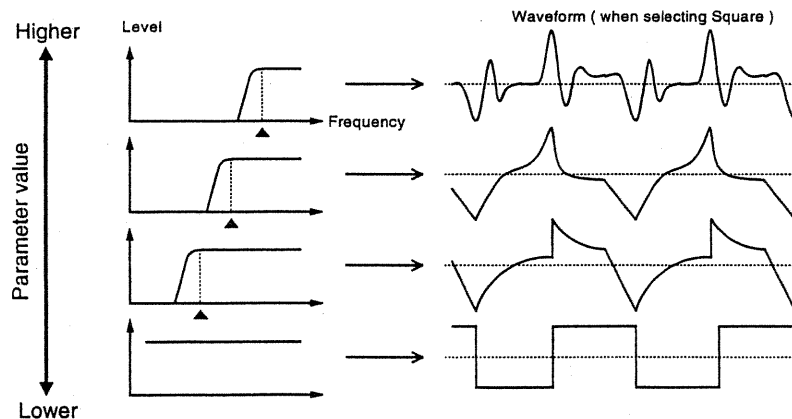

Cutoff and Envelope

The normal cutoff frequency, set in the cutoff parameter, is that frequency where the level of the envelope is 0. Therefore, the cutoff frequency increases or decreases according to changes in the envelope level.

TVF resonance

```
Patch:Tone      [-2--]  
TVF resonance=20
```

This parameter creates a characteristic sound by emphasizing the frequency elements around the cutoff frequency of the TVF. It is effective in making sounds which have a characteristic electronic or synthesizer-like sound.

The emphasized frequency changes along with the cutoff frequency, when the cutoff frequency is modulated by the envelope.

Range: 0 — 127

The higher the value, the greater the resonance effect.

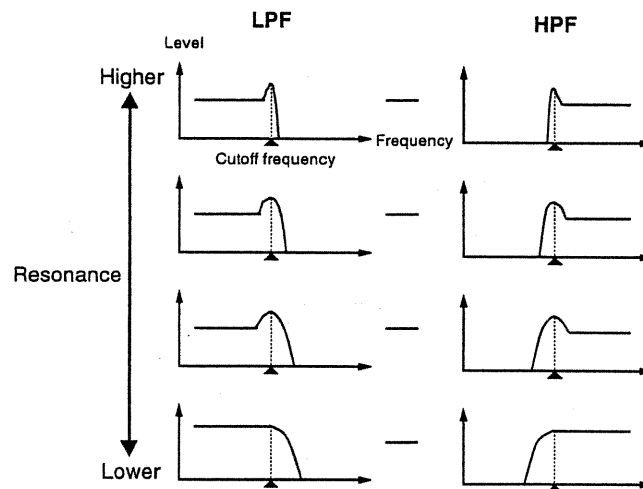

- * There are some cases in which the resonance effect decreases, such as when the Tone level is high when it sounds, or when the cutoff frequency is high.

TVF reso mode

TVF Resonance Mode

```
Patch:Tone      [-2--]  
TVF reso mode=HARD
```

This parameter determines the type of resonance.

Settings: SOFT/HARD

SOFT : The resonance effect is moderate.

HARD : The resonance effect is pronounced.

Resonance Mode

When set to SOFT, the sound has a subtle, moderately electronic quality. When set to HARD, the timbre (quality) of the sound is drastically changed. Use the HARD setting when you want to reproduce dynamic resonance effects (characteristic of analog synthesizers), like the resonance that results just before oscillation.

TVF keyfollow

```
Patch:Tone      [-2--]  
TVF keyfollow=+70
```

This parameter lets you change the cutoff frequency depending on the note number played. The key C4 (note number 60) is the central (or reference) key.

Settings: -100/-70/-50/-30/-10/0/+10/+20/+30/+40/+50/+70/+100/+120/+150/+200

Positive (+) values : The larger the note number, the higher the cutoff frequency. In addition, the higher the value, the more marked the increase.

+100 : The standard frequency of the sound becomes the cutoff frequency.

0 : No change.

Negative (-) values : The higher the note number, the lower the cutoff frequency.

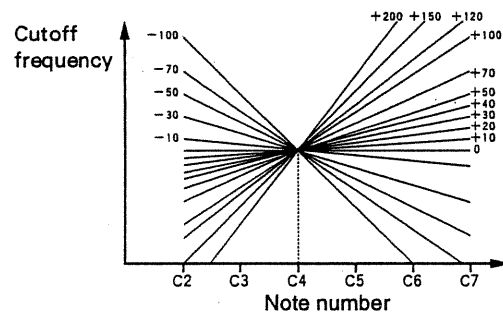

For example, set the keyfollow value to less than 100 for piano sounds, as the sound of a real piano becomes softer the higher up on the keyboard you play. If you set different keyfollow values for each Tone, the sound can be made to change in unusual ways.

TVF ENV depth

TVF Envelope Depth

```
Patch:Tone      [-2--]
TVF ENV depth=+10
```

This parameter determines the depth of the TVF envelope.

Range: - 63 — +63

Positive (+) values : The greater the TVF envelope level, the higher the cutoff frequency.

Negative (-) values : The greater the envelope level, the lower the cutoff frequency.

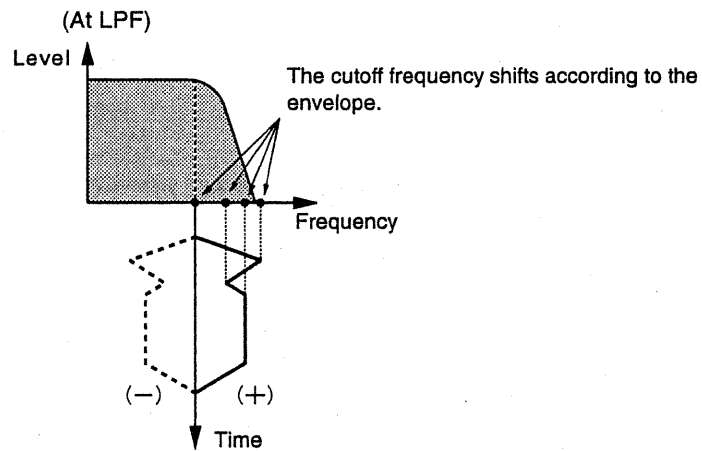

● F — ENV (TVF Envelope parameters)

The TVF Envelope determines how the cutoff frequency set in the TVF parameters changes over time.

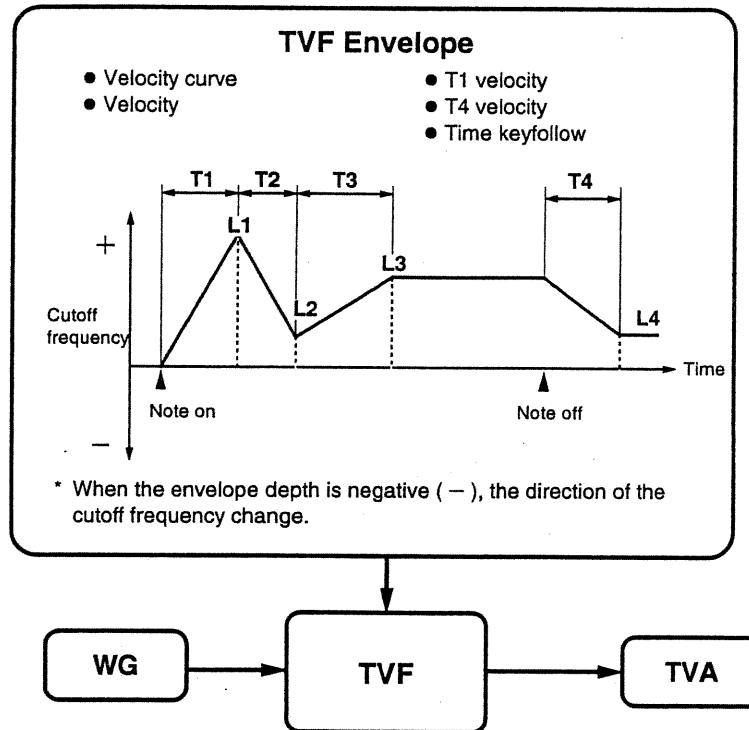

F-ENV velo curve

```
Patch:Tone          [-2--]
F-ENV velo curve=2_✓
```

This parameter selects one of seven different curve types that determine how changes in velocity affect the change in cutoff frequency (when changing the cutoff frequency by velocity).

Range: 1 — 7

The indications in the display, which show the shape of the curves, correspond to the curve type number.

Velocity curves

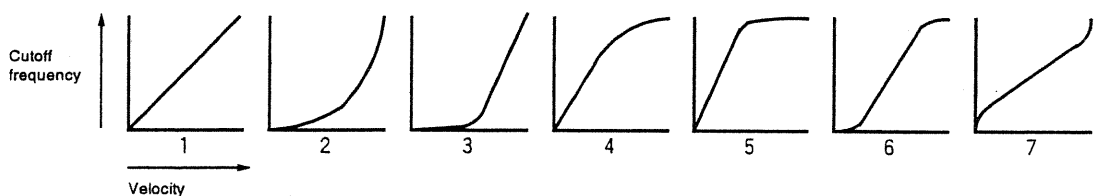

F-ENV velocity

```
Patch:Tone      [-2--]  
F-ENV velocity=+20
```

This parameter determines how velocity affects the TVF envelope level.

Range: -63 — +63

- Positive (+) values : The higher the velocity, the greater the envelope level.
0 : The envelope level is constant, regardless of the velocity.
Negative (-) values : The lower the velocity, the greater the level.

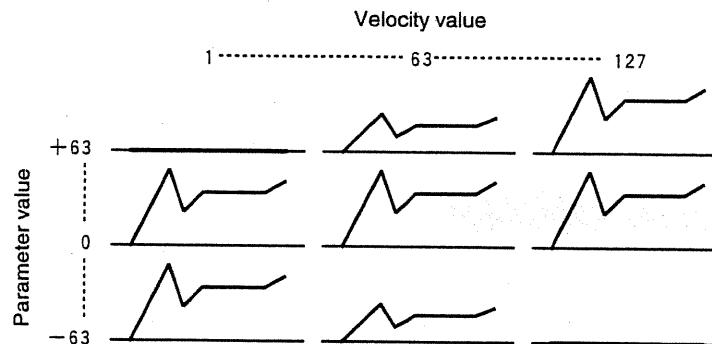

F-ENV T1 velocity

```
Patch:Tone      [-2--]  
F-ENV T1 velocity=+10
```

This parameter determines how the T1 time of the TVF envelope is affected by velocity.

Settings: -100/ -70/ -50/ -40/ -30/ -20/ -10/0/+10/+20/+30/+40/+50/+70/+100

- Positive (+) values : The higher the velocity, the longer the time of T1.
0 : No change.
Negative (-) values : The higher the velocity, the shorter the time.

F-ENV T4 velocity

```
Patch:Tone      [-2--]  
F-ENV T4 velocity=-30
```

This parameter determines how the T4 time of the TVF envelope is affected by Note Off velocity.

Settings: - 100/ - 70/ - 50/ - 40/ - 30/ - 20/ - 10/0/+10/+20/+30/+40/+50/+70/+100

Positive (+) values : The higher the Note Off velocity (releasing the key fast), the longer the time of T4.

0 : No change.

Negative (-) values : The higher the Note Off velocity, the shorter the time.

* This setting has no effect if the connected MIDI device does not transmit Note Off velocity.

F-ENV time KF

F-ENV Time Keyfollow

```
Patch:Tone      [-2--]  
F-ENV time KF=+20
```

The time between T2 and T4 within the TVF envelope can be made to change depending on the note number. The key C4 (note number 60) is the central (reference) key of the envelope time function.

Settings: - 100/ - 70/ - 50/ - 40/ - 30/ - 20/ - 10/0/+10/+20/+30/+40/+50/+70/+100

Positive (+) values : The greater the note number, the shorter the time of T2 — T4.

0 : No change.

Negative (-) values : The greater the note number, the longer the time.

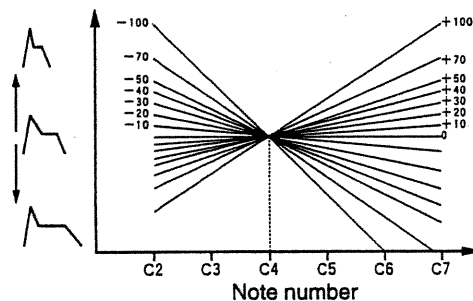

F-ENV T1/T2/T3/T4, L1/L2/L3/L4

Patch:Tone	[-2--]
F-ENV T1=05	L1=10

Patch:Tone	[-2--]
F-ENV T2=10	L2=10

Patch:Tone	[-2--]
F-ENV T3=20	L3=50

Patch:Tone	[-2--]
F-ENV T4=05	L4=100

These parameters determine the time settings (T1, T2, T3 and T4) and the level settings (L1, L2, L3 and L4) of the TVF envelope.

The "T" parameters indicate the time it takes for the cutoff frequency to reach the next cutoff frequency. (For example, T1 is the time it takes from Note On to L1.)

The "L" parameters determine the cutoff frequency at each point.

Settings: T = 0 — 127/L = 0 — 127

T : The greater the value, the longer the time it takes to reach the next level.

L : The greater the value, the higher (lower) the cutoff frequency.

The set value here follows adjustment by the TVF envelope depth before changing the cutoff frequency.

● TVA parameters

TVA stands for Time Variant Amplifier, meaning an amplifier which changes over time.

These parameters determine the level of the sounds generated by the WG, and processed with the pitch envelope, TVF, and TVA envelope.

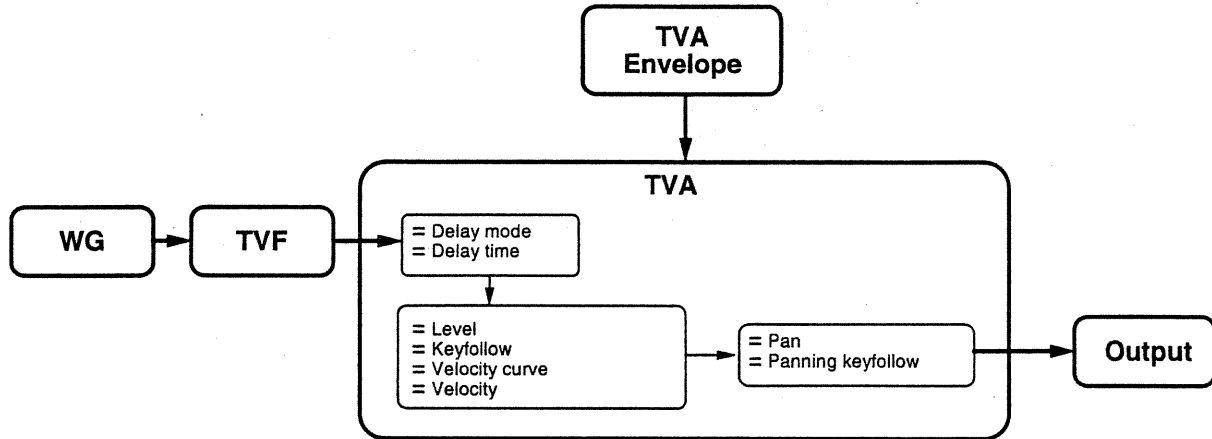

TVA level

```
Patch:Tone      [-2--]
TVA level=127
```

This parameter determines the Tone level. When creating a single sound using several Tones, you can change the volume balance of the Tones to emphasize certain parts of the sound.

Range: 0 — 127

The greater the value, the greater the level.

- * The overall pan setting of the Patch is determined by a combination of the pan parameter in the Patch Common parameters (See P.6-8) and the received external MIDI volume data.

TVA keyfollow

```
Patch:Tone      [-2--]
TVA keyfollow=+100
```

This parameter determines how the Tone level changes with note number.

Settings: -100/ -70/ -50/ -40/ -30/ -20/ -10/0/+10/+20/+30/+40/+50/+70/+100

Positive (+) values : The higher the note number, the greater the level. In addition, the higher the setting, the sharper the increase.

0 : No change.

Negative (—) values : The higher the note number, the lower the level.

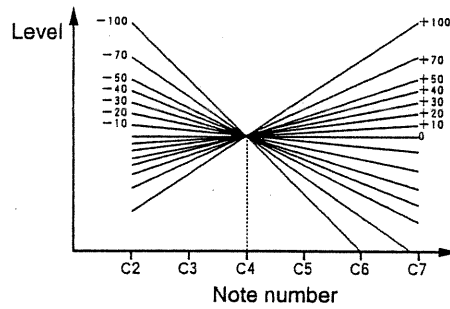

TVA velo curve

```
Patch:Tone [-2--]
TVA velo curve=2 ✓
```

This parameter selects one of seven different curve types that determines how changes in velocity affect the change in the Tone level (when changing the level by velocity).

Range: 1 — 7

The indications in the display, which show the shape of the curves, correspond to the curve type number.

Velocity curves

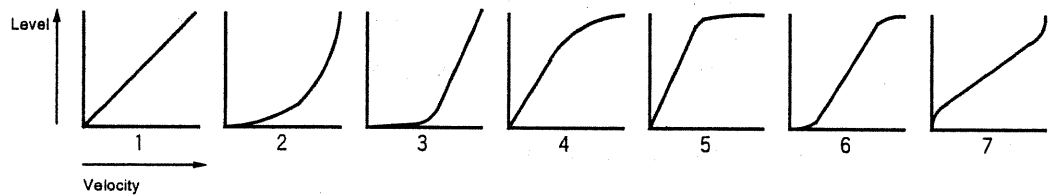

Level Keyfollow and Velocity Curve

These parameters allow you to change the level by note number or velocity. One effective application for keyboard sounds is to set a negative level key follow value to reproduce the characteristics of an acoustic piano, in which the high range of the keyboard has a lower volume than the low range. Also, when setting the key follow parameters of two Tones to opposite values (of 100 and -100), the quality of sound changes as you play from the lower range of the keyboard to the higher range.

TVA velocity

```
Patch:Tone      [-2--]  
TVA velocity=-50
```

This parameter determines how the Tone level is affected by velocity.

Range: - 63 — +63

Positive (+) values : The greater the velocity, the higher the level.

0 : No change.

Negative (-) values : The greater the velocity, the lower the level.

A commonly used technique is to set the velocity level sensitivity to a positive value, to increase the volume of the sound in relation to playing strength. Another possible application is to set two Tones to opposite values (for example, - 32 and +32), so that the sound itself changes in relation to playing strength.

TVA pan

```
Patch:Tone      [-2--]  
TVA pan=RND
```

This parameter determines the stereo position of the Tone.

Range: L64 — 0 — 63R/RND

The sound position is at the farthest left at L64, at the center at 0, and at the farthest right at 63R.

When this is set to RND, the stereo position changes randomly for each note played.

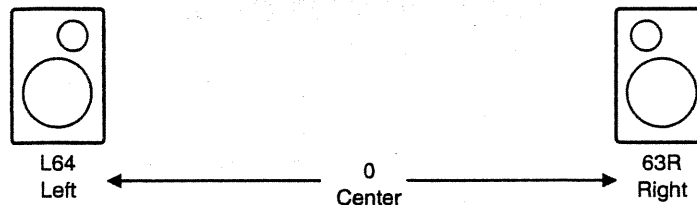

- * The overall level of the Patch is determined by a combination of the level parameter in the Patch Common parameters (See P.6-8) and the received external MIDI pan data.

TVA panning KF

TVA Panning Keyfollow

```
Patch:Tone      [-2--]  
TVA panning KF=+100
```

This parameter determines how the stereo position of the sound changes with the note number.

The stereo position of key C4 (note number 60) is the central (reference) key.

Settings: -100/-70/-50/-40/-30/-20/-10/0/+10/+20/+30/+40/+50/+70/+100

Positive (+) values : The higher the note number, the farther right the sound is shifted in the stereo position.

0 : The stereo position of the sound remains constant, regardless of the note number.

Negative (-) values : The higher the note number, the farther left the sound is shifted in the stereo position.

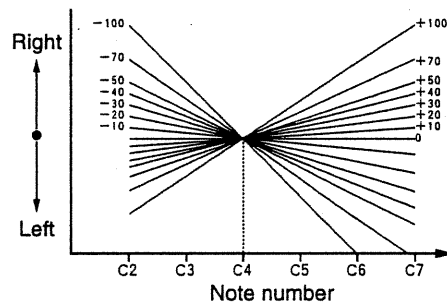

When determining the stereo image of a Tone, first set the panning keyfollow value to 0, then decide the stereo position. Also, when creating a conventional keyboard sound (like a piano), set the pan parameter to the center, and the panning keyfollow to a positive value, so that the sound image moves toward the right as higher notes are played.

TVA delay mode

```
Patch:Tone      [-2--]  
TVA delay mode=NORMAL
```

This parameter determines the type of Tone delay. This applies a delay to the start of the Tone after a Note On.

Settings: NORMAL/HOLD/PLAYMATE

NORMAL : Tone delay is effective even after a note is released.

HOLD : Tone delay is applied only while the note is on. Therefore, the Tone will not sound if the note is released before the delay time has elapsed.

PLAYMATE : The time from the first Note On to the second Note On becomes the delay time, if this time is less than two seconds.

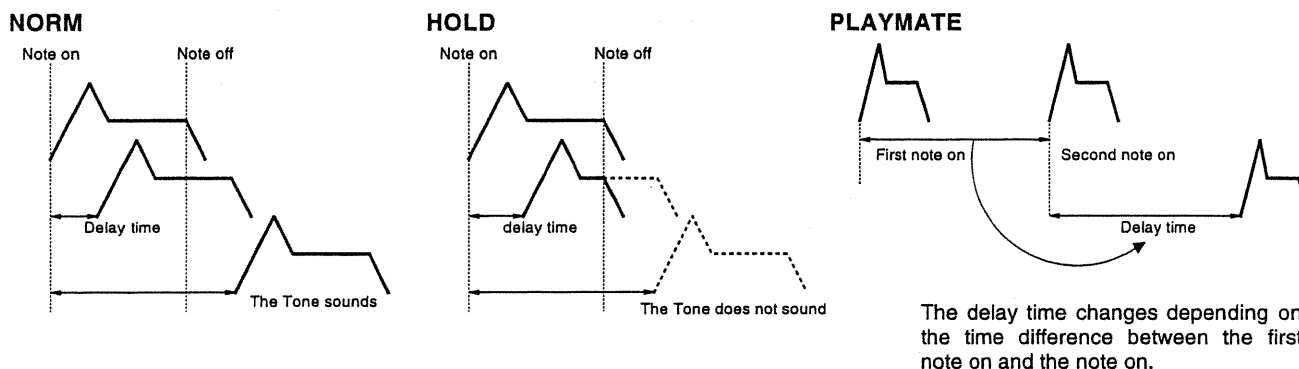

TVA delay time

```
Patch:Tone      [-2--]  
TVA delay time=KEY-OFF
```

This parameter determines the time that elapses from Note On until each Tone starts to sound.

Range: 0 — 127/KEY-OFF

The greater the value, the longer the delay time.

When set to **KEY-OFF**, the sound starts the moment the key is released (Note Off), regardless of the mode setting.

When the delay mode is set to **PLAYMATE**, the time from the first Note On to the second Note On becomes the delay time, if this parameter value is set to 64.

When set to 127, the delay interval is approximately twice that of setting 64.

You can create an echo effect by setting different delay times for various Tones with the same sound. You can also use this function to produce arpeggios (at the touch of a single key), by changing the delay time for each Tone (e.g., Patch 164 REVERSE MAD) ,or by changing the pitch for each Tone with the same sound.

● A-ENV (TVA Envelope parameters)

TVA envelopes determine how the level set by TVA changes over time.

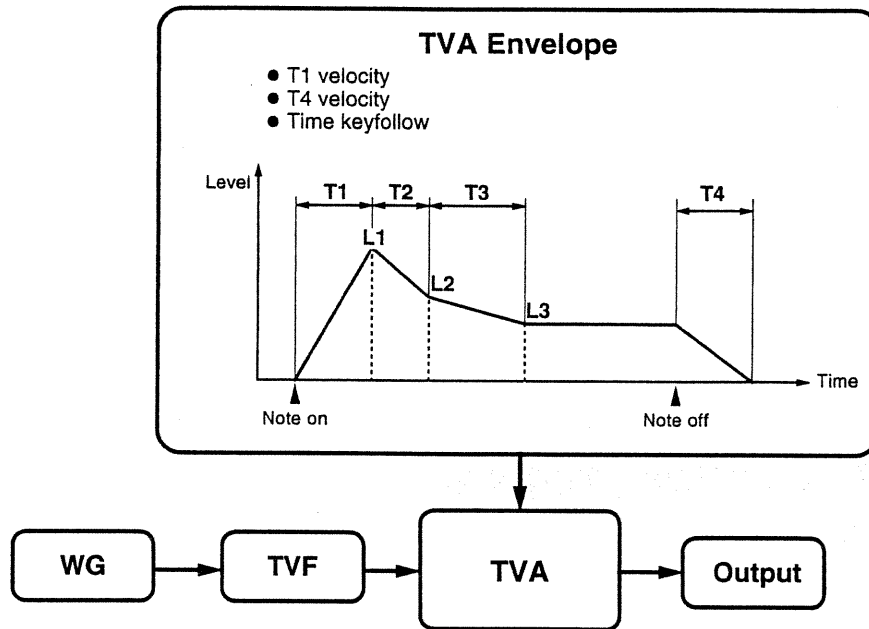

A-ENV T1 velocity

```
Patch:Tone      [-2--]
A-ENV T1 velocity=-70
```

This parameter determines how the T1 time of the TVA envelope is affected by velocity.

Settings: - 100/ - 70/ - 50/ - 40/ - 30/ - 20/ - 10/0/+10/+20/+30/+40/+50/+70/+100

Positive (+) values : The higher the velocity, the longer the time of T1.

0 : No change.

Negative (-) values : The higher the velocity, the shorter the time.

A-ENV T4 velocity

```
Patch:Tone          [-2--]  
A-ENV T4 velocity=+40
```

This parameter determines how the T4 time of the TVA envelope is affected by Note Off velocity.

Settings: - 100/ - 70/ - 50/ - 40/ - 30/ - 20/ - 10/0/+10/+20/+30/+40/+50/+70/+100

Positive (+) values : The higher the Note Off velocity, the longer the time of T4.

0 : No change.

Negative (-) values : The higher the Note Off velocity, the shorter the time.

* This setting has no effect if the connected MIDI device does not transmit Note Off velocity.

A-ENV time KF

A-ENV Time Keyfollow

```
Patch:Tone          [-2--]  
A-ENV time KF=+20
```

The time of T2 — T4 can be changed by the note number within the TVA envelope.

The envelope time of key C4 (note number 60) is the central (reference) time.

Settings: - 100/ - 70/ - 50/ - 40/ - 30/ - 20/ - 10/0/+10/+20/+30/+40/+50/+70/+100

Positive (+) values : The higher the note number, the shorter the time of T2 — T4.

0 : No change.

Negative (-) values : The higher the note number, the longer the time.

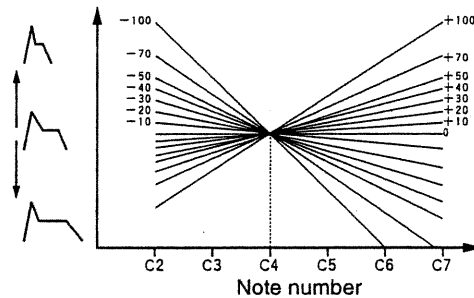

To reproduce the characteristic sound of stringed instruments, we suggest that you set the keyfollow to a positive value to make the sounds decay more quickly in the upper registers.

A-ENV T1/T2/T3/T4 ,L1/L2/L3

```
Patch:Tone      [-2--]  
A-ENV T1=05    L1=20
```

```
Patch:Tone      [-2--]  
A-ENV T2=10    L2=10
```

```
Patch:Tone      [-2--]  
A-ENV T3=20    L3=50
```

```
Patch:Tone      [-2--]  
A-ENV T4=05
```

These parameters determine the time settings (T1, T2, T3 and T4) and the level settings (L1, L2 and L3) of the TVA envelope.

The "T" parameters indicate the time it takes for the sound to reach the next level. (For example, T1 is the time it takes between Note On and L1.)

The "L" parameters determine the level at each point.

Settings: T = 0 — 127/L = 0 — 127

T : The higher the value, the longer it takes to reach the next level.

L : The higher the value, the higher the level.

In the case of the TVA, the envelope level after Note Off becomes 0.

Envelope

The L3 parameter should be set to a relatively low value for sounds like pianos, bells or guitars, whose volume decays relatively quickly. On the other hand, the L3 parameter should be set to a relatively high value for sounds which have a fairly steady, continuous sound, such as violin or clarinet.

This envelope setting can be added to waveforms which already have a level change, such as one-shot waveforms and rhythm waveforms.

Decaying sounds, like bells or a piano

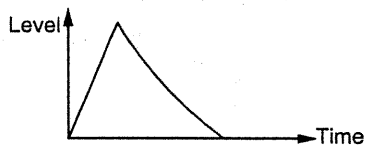

Continuous sounds, like a violin or clarinet

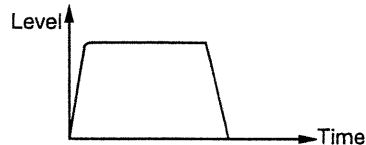

● Output parameters

These parameters determine the output level and destination of each Tone.

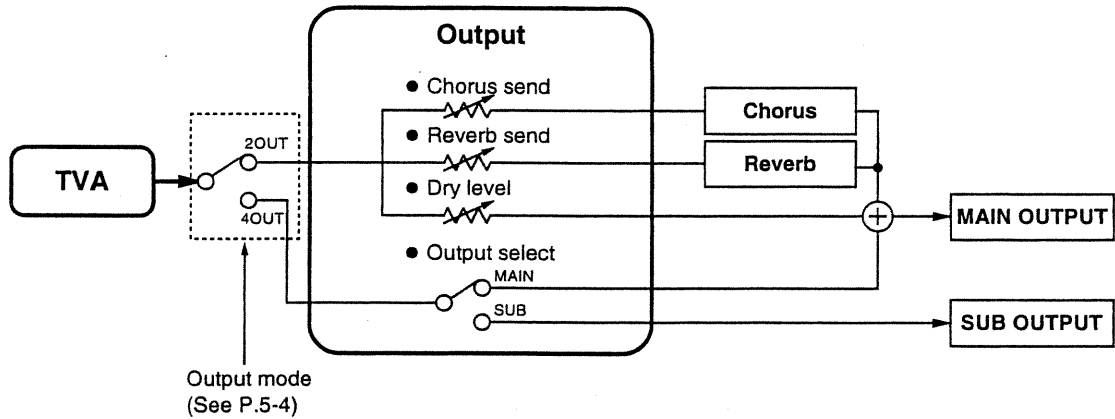

About Send Level:

The ratio of the effect sound of each Tone to the overall effect sound is controlled by the chorus send level and the reverb send level. The level of the unprocessed (dry) signal is set by the dry level parameter.

You can create a sound in which the level of the effect applied to a Tone is greater than the level of the Tone itself, since the level of the original unprocessed sound (dry level) can be set separately from the effect (or processed) sound.

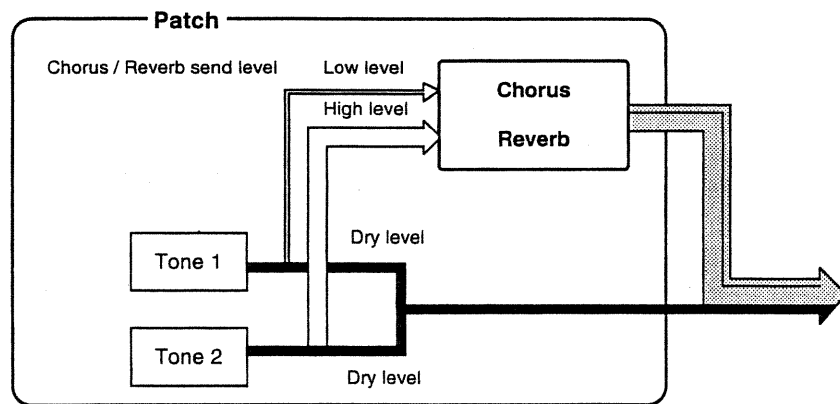

Output dry level

```
Patch:Tone      [-2--]  
Output dry level=127
```

Output mode = 2OUT

This parameter determines the level of the direct or unprocessed sound. If no effect has been applied to a Tone, you should set this parameter value to 127, and adjust the sound volume from the Tone Level parameter of the TVA (See P.6-43).

Range: 0 — 127

The higher the value, the higher the level of the unprocessed sound.

Output chorus send

```
Patch:Tone      [-2--]  
Output chorus send=25
```

Output mode = 2OUT
Chorus switch = ON

This parameter determines the level of the signal sent to the chorus unit. This setting can change the amount of chorus applied to each Tone.

Range: 0 — 127

The higher the value, the higher the level of the signal sent to the chorus unit.

Set the level higher to add a soft sheen to a sound, or lower to emphasize a sharp attack and overall clarity.

Output reverb send

```
Patch:Tone      [-2--]  
Output reverb send=30
```

Output mode = 2OUT
Reverb switch = ON

This parameter determines the level of the signal sent to the reverb unit. This setting can change the amount of reverb applied to each Tone.

Range: 0 — 127

The higher the value, the higher the level of the signal sent to the reverb unit.

Output select

```
Patch:Tone      [-2--]  
Output select=MAIN
```

Output mode = 4OUT

This parameter determines which set of stereo outputs is to be used when the output mode setting (See P.5-4) of the System Common parameter is set to "4OUT."

Settings: MAIN/SUB

MAIN : Output through MAIN OUTPUT

SUB : Output through SUB OUTPUT

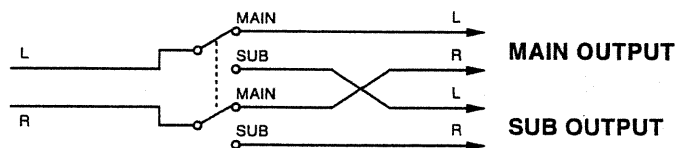

- * The final output assignment of a Patch, when playing in the Performance Play mode, is determined by the output select parameter (See P.7-15) in the Performance Part parameters.

Section

7

**EDITING
PERFORMANCES**

PERFORMANCE EDIT MODE

WHAT IS THE PERFORMANCE EDIT MODE?

In the Performance Edit mode, you can select and edit a single Performance. A maximum of 7 Patches and 1 Rhythm Set can be assigned to the Parts of a Performance.

Editing a Performance doesn't involve changing the actual settings of a Patch or Rhythm Set, but rather determining how each Part is to be used and what its balance settings (for example, level and pan) are to be.

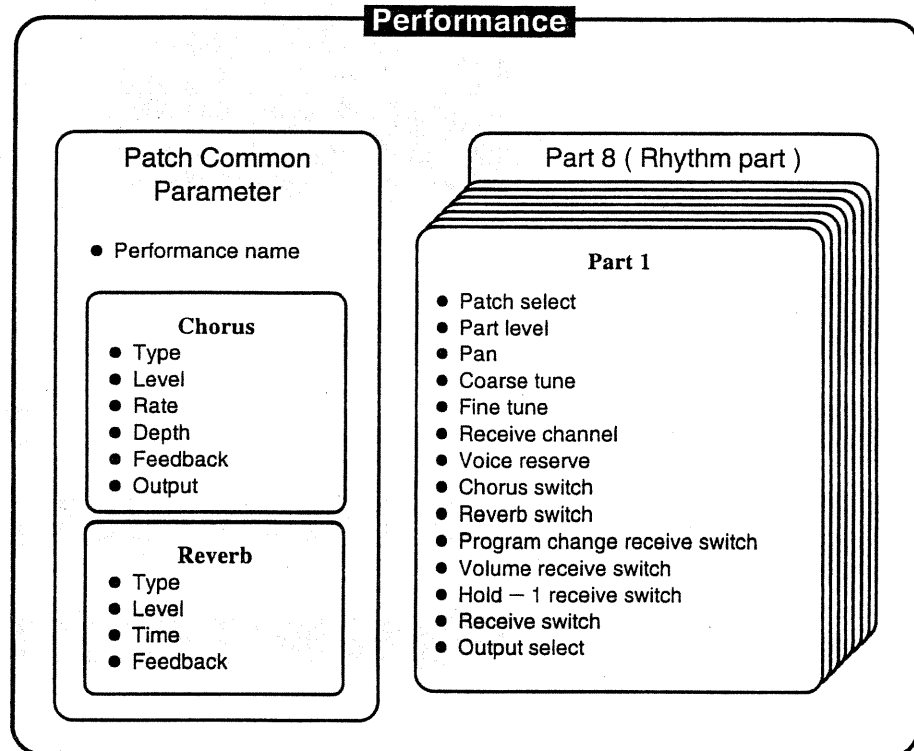

The parameters that comprise a Performance (Performance parameters) are divided into the categories shown below.

Performance Common Parameters

These are the parameters which are common to an entire Performance and are not affected by the settings of each Patch.

Part Parameters

These parameters (receive channel, level, etc.) are set for each Part.

* See P.2-2 for information on using Performances.

OPERATION GUIDE

- ① Select the Performance Edit mode.

Press **EDIT** from the Performance Play mode. (The indicator lights.)

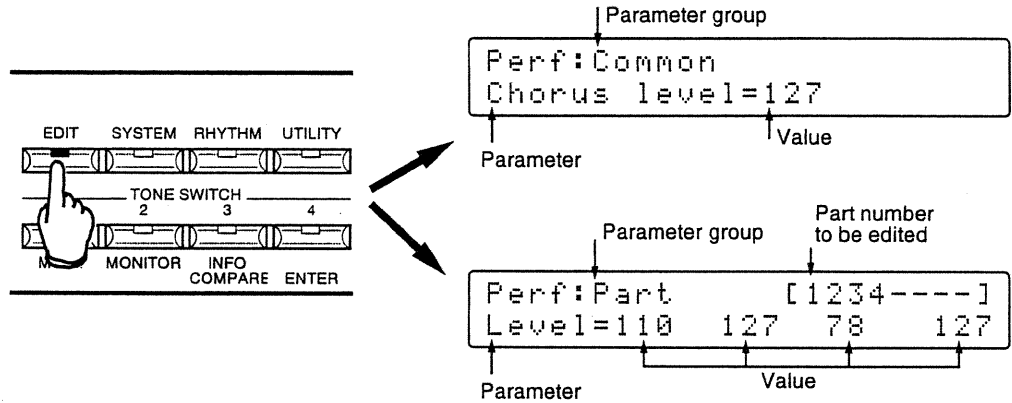

- ② Move the cursor to the upper part of the display using **◀CURSOR▶**.

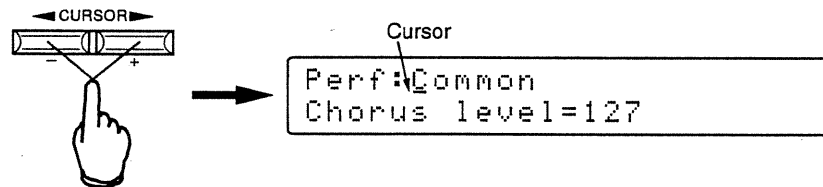

- ③ Select the group or type of parameter to be edited by rotating the **DATA** dial. Select "Common" when editing Performance Common parameters, and "Part" when editing Part parameters.

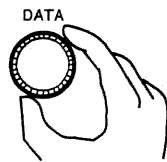

- ④ Move the cursor to the parameter field using **◀CURSOR▶**.

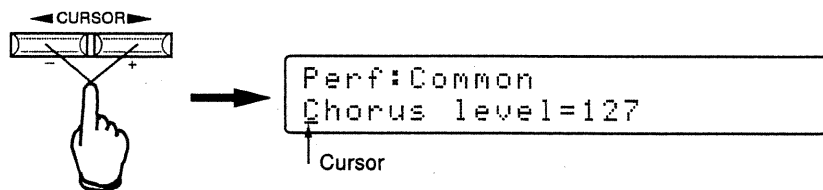

⑤ Select the parameter to be edited.

- ◆ Rotating the **DATA** dial changes the parameters one by one.

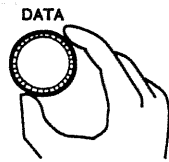

- ◆ Simultaneously hold down and rotate the **DATA** dial to jump to a certain parameter of the Performance Common parameters, skipping the parameters in between.

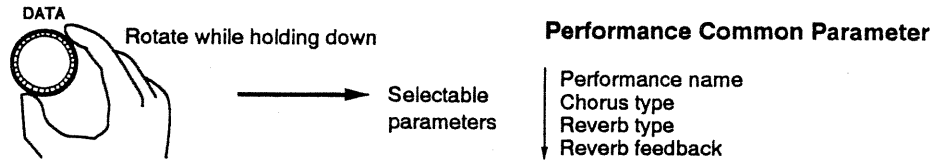

⑥ Move the cursor to the value field in the display using **◀CURSOR▶**.

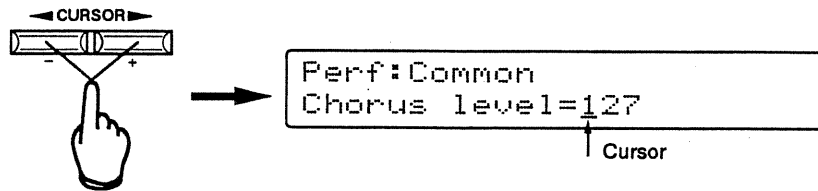

- * The setting values are indicated in two separate groups when selecting a Part parameter; one is Parts 1 — 4, and the other is Parts 5 — 8.

To switch to Parts 5 — 8, press **CURSOR▶** when the cursor is at Part 4.

To switch to Parts 1 — 4, press **◀CURSOR** when the cursor is at Part 5.

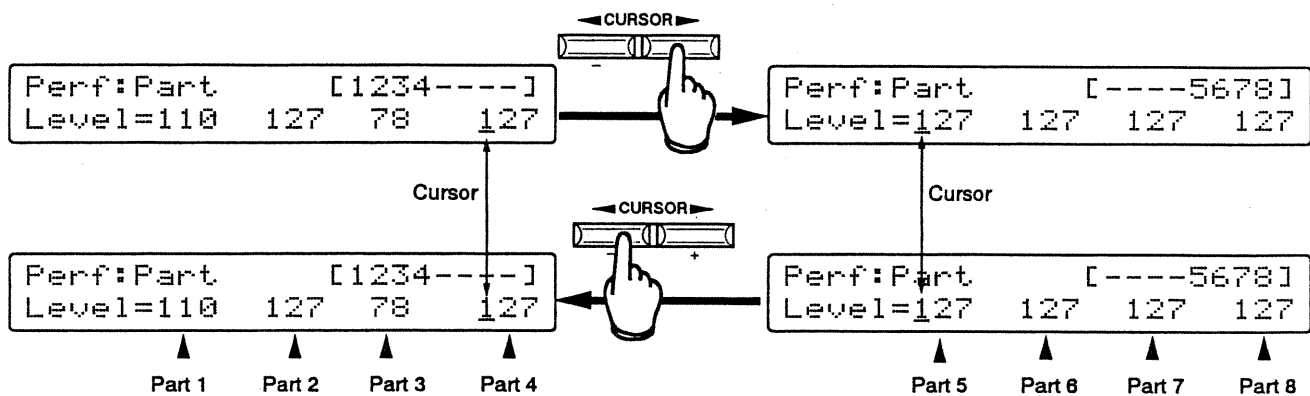

⑦ Change the value.

- ◆ Rotate the **DATA** dial to change the value in small steps.
- ◆ Simultaneously hold down and rotate the **DATA** dial to change the value in large jumps.
- ◆ Press the **DATA** dial twice quickly to return to the originally set value. Press the dial twice quickly again to restore the value you set previous.



⑧ Repeat steps ② through ⑦ as necessary.

⑨ Execute the Write operation (See P.9-4) to store the settings.

Press **EDIT** to exit the Performance Edit mode.

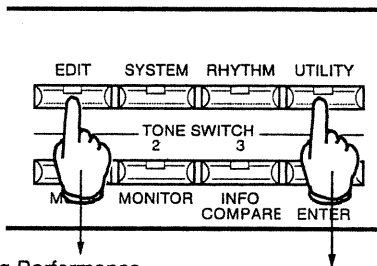

When exiting Performance Edit mode.

When performing the Write operation.

Parameters can be changed regardless of the cursor position by simultaneously holding down **PARAM SHIFT** and pressing **+**/**-**, when selecting the parameter to be edited (step ⑤).

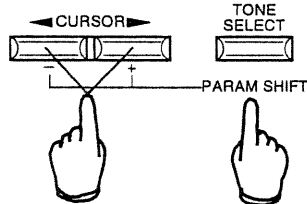

Preview Function

To hear (preview) sounds when selecting the Part parameter, move the cursor to the value field of the desired Part and then press the **VOLUME** knob.



PARAMETER FUNCTIONS

Note

Some of the parameters explained in this section may not be active, depending on settings in the System Common parameters. These inactive parameters are not displayed in the LCD. For such parameters, the relevant System Common parameters are described at the side of the LCD illustration.

Performance Common Parameters

Perf name

```
Perf:Common  
Perf name=Syn Lead
```

A name of up to 12 characters can be assigned to an edited Performance Patch.

Use **◀ CURSOR ▶** to move the cursor to the name field in the display, then select the desired characters with the DATA dial. Use **CURSOR ▶** to advance to the next character space. Proceed until the name is complete.

Available characters: space, A — Z, a — z, 1 — 9, 0, + — * / # ! , .

- * The character group changes (from space ↔ A ↔ a ↔ 1 ↔ +) by pressing and rotating the DATA dial.

Chorus type

```
Perf:Common  
Chorus type=CHORUS1
```

Output mode = 2OUT
Chorus switch = ON

This parameter determines the type of chorus effect.

Settings: CHORUS 1 — 3

CHORUS1	Standard chorus
CHORUS2	Chorus with a slow modulation rate. It can also be used as a flanger effect by applying feedback.
CHORUS3	Chorus with deep modulation, creating a wide variation in pitch.

Chorus level

```
Perf: Common  
Chorus level=50
```

Output mode = 2OUT
Chorus switch = ON

This parameter determines the level of the chorus sound.

Range: 0 — 127

The higher the value, the higher the level.

Chorus rate

```
Perf: Common  
Chorus rate=70
```

Output mode = 2OUT
Chorus switch = ON

This parameter determines the chorus modulation speed.

Range: 0 — 127

The higher the value, the faster the modulation.

Chorus depth

```
Perf: Common  
Chorus depth=60
```

Output mode = 2OUT
Chorus switch = ON

This parameter determines the chorus modulation depth.

Range: 0 — 127

The higher the value, the greater the modulation depth.

Chorus feedback

```
Perf: Common  
Chorus feedback=20
```

Output mode = 2OUT
Chorus switch = ON

This parameter determines the level of the re-routed (feedback) chorus sound.

Range: 0 — 127

The higher the value, the higher the feedback level.

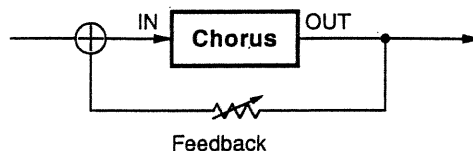

Chorus output

```
Perf:Common
Chorus output=REVERB
```

Output mode = 2OUT
Chorus switch = ON

This parameter determines the destination of the chorus sound output.

Settings: MIX/REVERB

MIX : The chorus and reverb sounds are mixed with the dry (unprocessed) sound.

REVERB : The chorus sound is mixed with the dry signal after reverb is added.

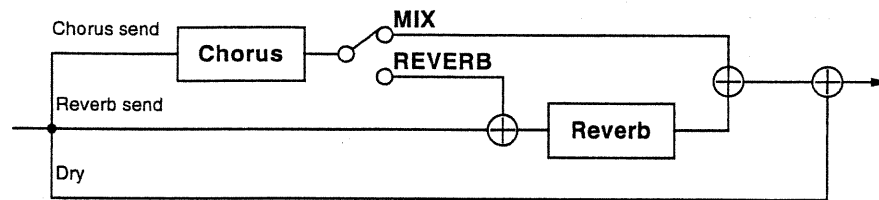

Reverb type

```
Perf:Common
Reverb type=ROOM1
```

Output mode = 2OUT
Reverb switch = ON

This parameter determines the type of reverb.

Settings: ROOM1 — 2/STAGE1 — 2/HALL1 — 2/DELAY/PAN-DLY

ROOM1	Reverb with short and dense reverberant wash
ROOM2	Reverb with short and sparse reverberant wash
STAGE1	Reverb with strong reverberant wash in the final portion of the sound
STAGE2	Reverb with strong initial reflections
HALL1	Reverb with distinct echo
HALL2	Reverb with rich echo
DELAY	Conventional delay
PAN-DLY	Delay in which the reflected sound pans left and right

Reverb level

```
Perf:Common  
Reverb level=50
```

Output mode = 2OUT
Reverb switch = ON

This parameter determines the level of the reverb sound.

Range: 0 — 127

The higher the value, the higher the level.

Reverb time

```
Perf:Common  
Reverb time=40
```

Output mode = 2OUT
Reverb switch = ON

When ROOM1 — HALL2 is selected as the reverb type, this parameter determines the duration of the reflected-sound; when DELAY/PAN-DLY is selected, this parameter determines the delay time.

Range: 0 — 127

The higher the value, the longer the reverb time or delay time.

Reverb feedback

```
Perf:Common  
Reverb feedback=30
```

Output mode = 2OUT
Reverb switch = ON

When DELAY or PAN-DLY is selected, this parameter determines the re-routed level (feedback) of the delay sound in the delay unit. Multiple echo repeats can be obtained from this setting.

Range: 0 — 127

The higher the value, the higher the feedback level.

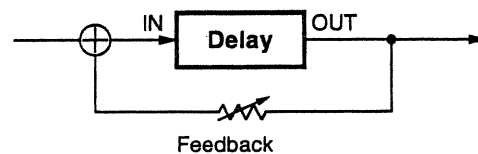

When playing a Patch assigned to a Part of a Performance, the effect setting made to the Patch itself is ignored, as this setting is common to the entire Part.

Part Parameters

These parameters determine how each Part is to be used, and how the 7 Patches and the Rhythm Set are to be combined.

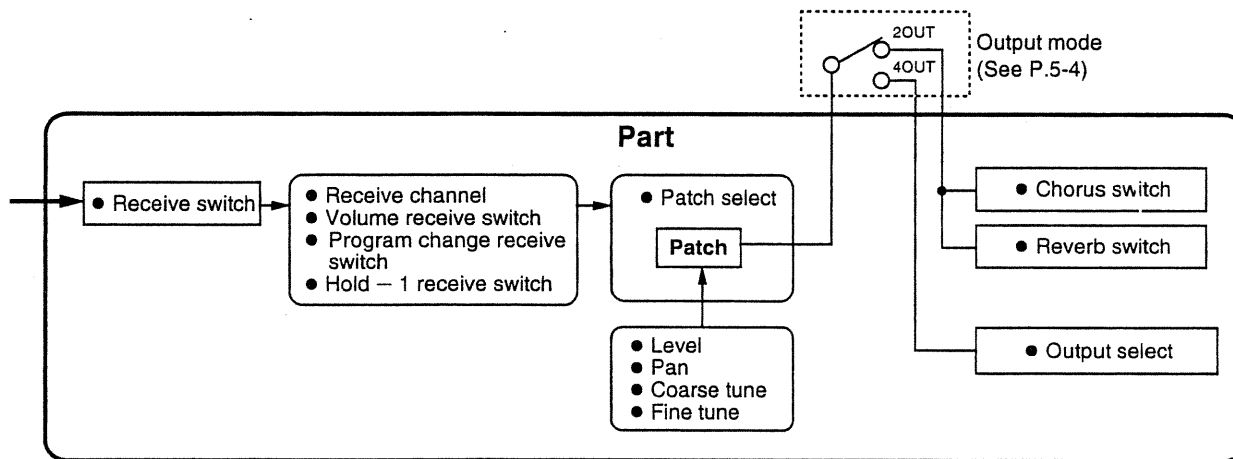

Patch#

Patch Select

Perf:Part [1234----]	Perf:Part [----5678]
Patch#=I11 A21 B88 C11	Patch#=C31 A11 I48 PRA

This parameter determines which Patch is to be assigned to Parts 1—7, and which Rhythm Set to Part 8.

Selection can be made from a total of 256 Patches: 64 from internal (I), 64 from a Data Card (C), and 64 each from presets A and B. The Rhythm Set can be selected from preset A (PRA), preset B (PRB), internal (INT), and a Data Card (CRD).

Settings: A01-64/B01-64/I01-64/C01-64/Rhythm Set (PRA/PRB/INT/CRD)

Part Level

.....

Perf:Part [1234----]	Perf:Part [----5678]
Level=50 100 100 100	Level=100 80 100 127

This parameter determines the level of each Part. This should be set to the maximum level (127) when there is no need to achieve a special balance among the Parts.

Range: 0 — 127

The higher the value, the higher the level.

* The final volume of the Part is determined by the combination of the TVA level of each Tone which is set for the Patch, and the received external MIDI volume data.

Part pan

```
Perf:Part [1234----]  
Pan=L20 L10 00 15R
```

```
Perf:Part [----5678]  
Pan=10R 00 00 L10
```

This parameter determines the stereo position of each Part. Keep in mind that the actual pan setting also depends on, and is affected by, the pan setting made for each Patch.

Range: L64 — 0 — 63R

The sound position is at the farthest left at L64, at the center at 0, and at the farthest right at 63R.

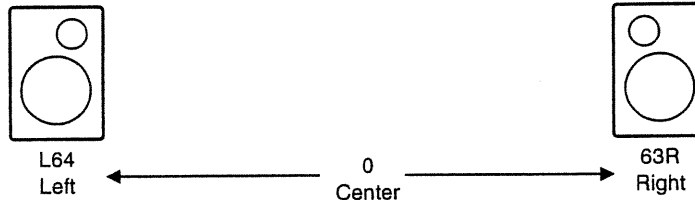

Part Tune

Part Coarse Tune

```
Perf:Part [1234----]  
Tune=00 +03 -02 00
```

```
Perf:Part [----5678]  
Tune=+01 00 -05 +10
```

This parameter determines the pitch at which a Part will sound. This parameter changes the pitch in semitone steps.

Range: - 48 — +48

Positive values : The pitch is higher than normal.

Negative values : The pitch is lower than normal.

Part Fine

Part Fine Tune

```
Perf:Part [1234----]  
Fine=00 +10 -05 00
```

```
Perf:Part [----5678]  
Fine=00 00 00 -01
```

This parameter determines the pitch at which a Part will sound. The Fine Tune parameter changes the pitch in units of 1/100th of a semitone.

Range: - 50 — +50

Positive values : The pitch is higher than normal.

Negative values : The pitch is lower than normal.

The Coarse Tune and Fine Tune settings for the Part shift the pitch relative to the setting made for the Patch. In other words, the actual pitch that sounds depends also upon the Patch setting.

Part Rx ch

Receive Channel

Perf:Part [1234----]	Perf:Part [----5678]
Rx ch=01 02 03 04	Rx ch=05 06 07 10

This parameter determines the MIDI receive channel of each Part.

Range: 1 — 16

- * Keep in mind that when this is set to the same channel as the Control Change parameter (See P.5-6) in the System Common parameters, the setting of the Control Channel has priority. The Performance will be changed when a Program Change message is received.

Part Reserve

Voice Reserve

Perf:Part [1234----]	Perf:Part [----5678]
Reserve=08 04 04 04	Reserve=00 00 00 08

This parameter determines the number of voices that are reserved for each Part. As the total number of voices of the JV-880 is 28, the total of the voice reserve settings for all Parts cannot exceed 28.

Range: 0 — 28

Voice Reserve

The JV has a maximum polyphony of 28 voices. Since one voice is used when sounding a single Tone, many voices are required when playing just one Patch consisting of several Tones:

If you try to play more voices than the 28 voice limit, previously played Tones will be cancelled to accommodate newly played ones.

You can, however, reserve a minimum number of voices for specific Parts by setting the voice reserve function; this comes in handy when you have an important Part (the melody Part, for example) that you wish to continue to sound.

For example, when you want a certain Patch which is made up of three Tones to sound at least two notes, the number of the voices you should reserve is six; two times three.

Chorus Switch

Perf:Part [1234----]	Perf:Part [----5678]
Chorus=OFF OFF OFF OFF	Chorus=ON ON ON ON

Output mode = 2OUT Chorus switch = ON

This parameter determines whether signals are sent to the chorus unit (ON) or not.

Settings: ON/OFF

- * The level of the signal to be sent is determined by the chorus send level (See P.6-52), which is set individually for each Tone in a Patch.

Reverb Switch

Perf:Part [1234----]	Perf:Part [----5678]
Reverb=ON OFF OFF ON	Reverb=OFF ON ON OFF

Output mode = 2OUT Reverb switch = ON

This parameter determines whether signals are sent to the reverb unit (ON) or not.

Settings: ON/OFF

- * The level of the signal to be sent is determined by the reverb send level (See P.6-52), which is set individually for each Tone in a Patch.

By turning the effects of each Part on and off, you can choose the proper ambience and dynamics for your sound. For example, turn off Parts which require a tightly defined stereo position or a clear sonic outline.

Rx P.Chg

Program Change Receive Switch

Perf:Part	[1234----
Rx P.chg=ON	OFF OFF ON

Perf:Part	[----5678]
Rx P.chg=OFF	ON ON OFF

Program change receive switch = ON

This parameter determines whether each Part responds to Program Change messages (ON) or not.

Settings: ON/OFF

- * Performances may not change as expected if either the Program Change receive switch or the bank select receive switch have been set to OFF. (See P.5-7.)

Rx Vol

Volume Receive Switch

Perf:Part	[1234----
Rx vol=ON	OFF OFF ON

Perf:Part	[----5678]
Rx vol=OFF	ON ON OFF

Volume receive switch = ON

This parameter determines whether each Part responds to volume data (ON) or not.

Settings: ON/OFF

- * The MIDI standard assigns volume to Control Change number 7.

Rx Hold

Hold - 1 Receive Switch

Perf:Part	[1234----
Rx hold=ON	OFF OFF ON

Perf:Part	[----5678]
Rx hold=OFF	ON ON OFF

Control change receive switch = ON

This parameter determines whether a Tone responds to MIDI Hold - 1 messages (ON) or not.

Settings: ON/OFF

- * The MIDI standard assigns Hold - 1 to Control Change number 64.

Rx sw

MIDI Receive Switch

Perf:Part	[1234----	Perf:Part	[----5678]
Rx sw=ON	OFF ON OFF	Rx sw=ON	ON ON OFF

This parameter determines whether each Part responds to MIDI data (ON) or not.

Settings: ON/OFF

Output

Output Select

Perf:Part	[1234----	Perf:Part	[----5678]
Output=	PAT MN SB PAT	Output=	MN SB PAT MN

Output mode=4OUT

This parameter determines the output assignment for each Part.

Settings: MN/SB/PAT

MN : Part sound is output through the main output jacks.

SB : Part sound is output through the sub output jacks.

PAT : Part sound is output according to the output assignment of the Patch.

For a Rhythm Set, the output assignment depends upon the output setting of the Rhythm Set (See P.6-53).

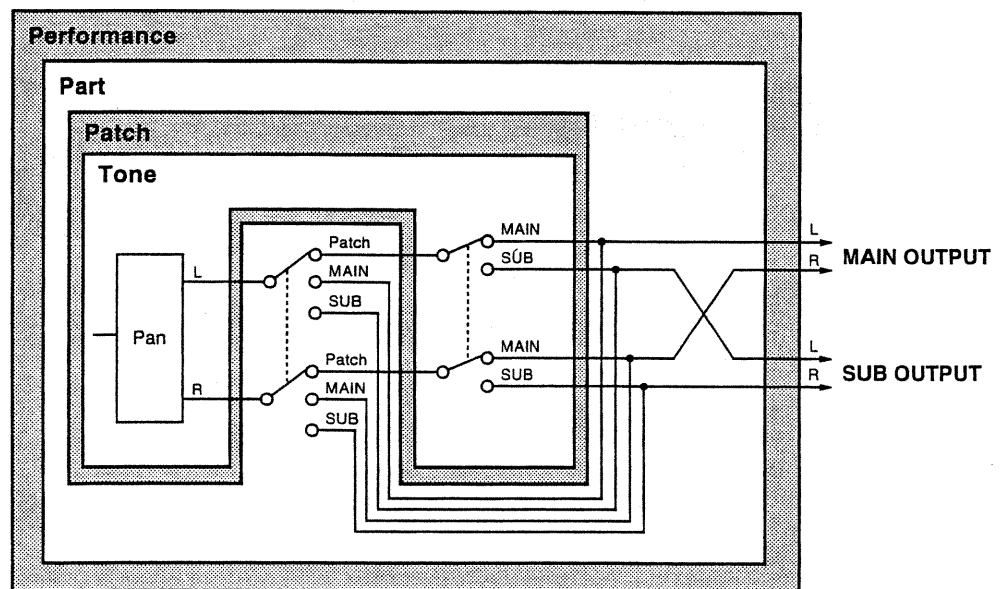

* The output setting of a Patch is ignored when this parameter is set to MN or SB.

Section

8

**EDITING
RHYTHM TONES**

RHYTHM EDIT MODE

WHAT IS THE RHYTHM EDIT MODE?

In the Rhythm Edit mode, you can edit the Rhythm Tones assigned to a Rhythm Set.

An edited Rhythm Set can be stored in internal memory (INT) or on a Data Card (CARD).

* See P.10-24 for a list of the factory set Rhythm Tone/key assignments.

[How a Parameter is organized]

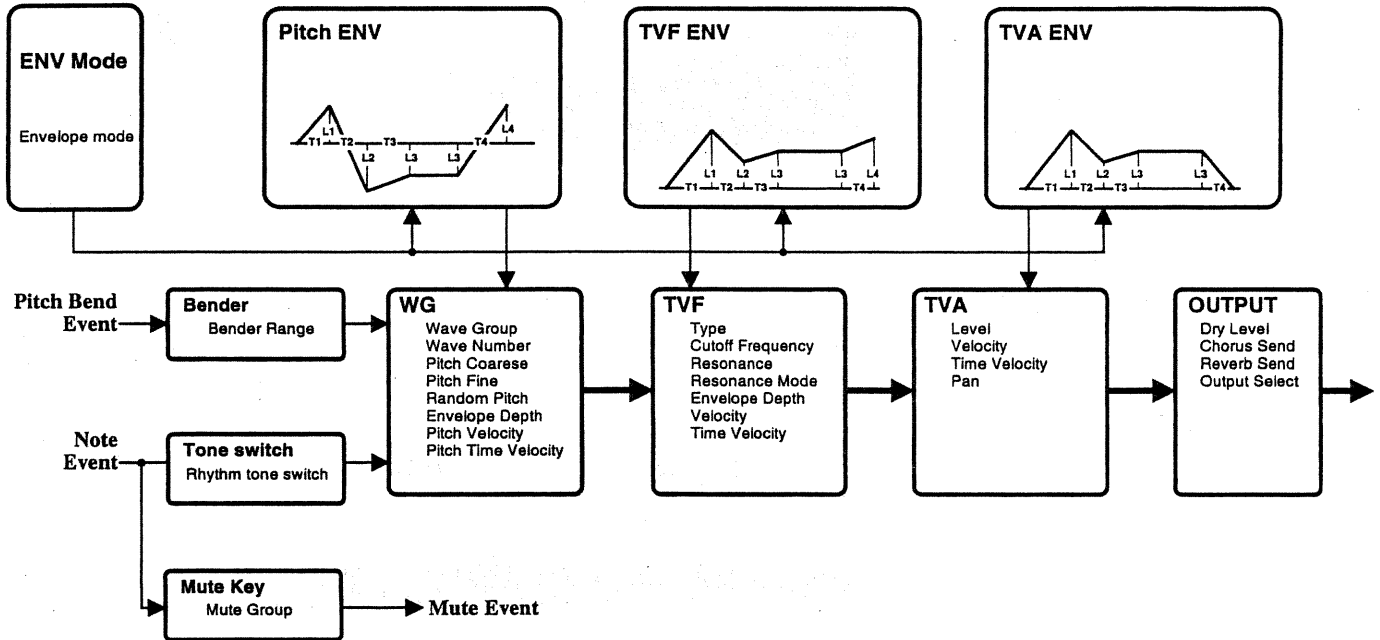

OPERATION GUIDE

- ① Select the Rhythm Edit mode.

Press **[RHYTHM]**. (The indicator lights.)

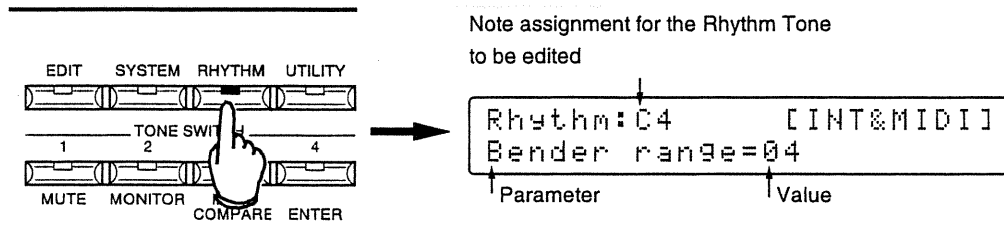

The Rhythm Set selected before entering the Rhythm Edit mode will be selected for editing.

In order to edit another Rhythm Set, select the Performance Play mode, change the Rhythm Set assigned to Part 8, then select the Rhythm Edit mode again.

- ② Move the cursor to the top of the display using **[CURSOR]**.

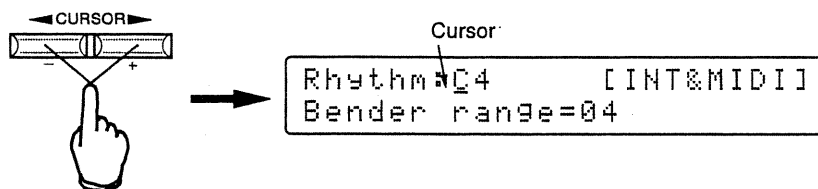

- ③ Select the note number to which the Rhythm Tone to be edited is assigned.

◆ Rotate the **DATA** dial → The note numbers change one by one.

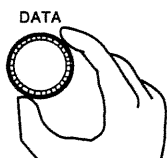

◆ Simultaneously press and rotate the **DATA** dial → The key numbers change in octaves.
For example; C2 ↔ C3 ↔ C4 ↔ C5 ↔ C6 ↔ C7.

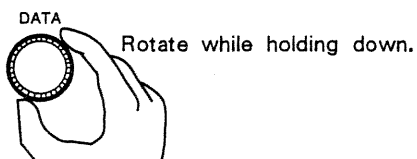

- ④ Move the cursor to the parameter field of the display using **◀ CURSOR ▶**.

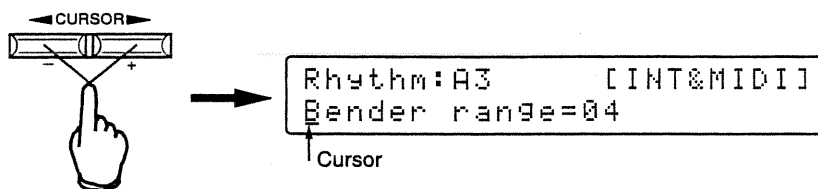

- ⑤ Select the parameter to be edited.

- ◆ Rotate the **DATA** dial → The parameters change one by one.
- ◆ Simultaneously press and rotate the **DATA** dial → the parameters change in large jumps.

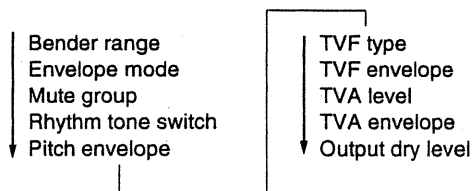

- ⑥ Move the cursor to the value field of the display using **◀ CURSOR ▶**.

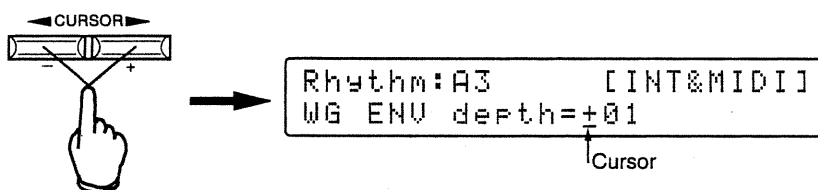

- ⑦ Change the value.

- ◆ Rotate the **DATA** dial → the value changes in small steps.
- ◆ Simultaneously press and rotate the **DATA** dial → the value changes in large jumps.
- ◆ Quickly press the **DATA** dial twice → the edited value is cancelled and the original value is restored.
Press the **DATA** dial twice quickly again → restore the value you set previous.



- ⑧ Repeat steps ② through ⑦ as many times as necessary.
- ⑨ Perform the Write operation to store the setting(s) (See P.9-5).
Press **EDIT** to exit the Rhythm Edit mode.

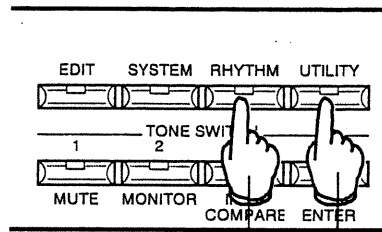

When exiting Rhythm Edit mode.

When performing the Write operation.

During editing (step ⑤), parameters can be changed (regardless of the cursor position) by holding down the **PARAM SHIFT** button and pressing **+** or **-**.

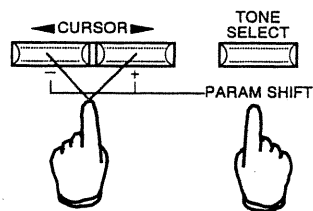

When "INT & MIDI" is indicated at the top of the display, the note numbers can be changed by pressing the desired keys on the connected MIDI keyboard, regardless of the position of the cursor.

- * Match the transmit channel of the keyboard to the receive channel of Part 8 of the Performance to which the presently selected Rhythm Set is assigned.
- * Change the setting of the Rhythm Edit key (P.5-12) in the System Common parameters in order to enable control from a connected MIDI keyboard (when "INT" is indicated).

Preview Function

The sound of the Rhythm Tone (assigned to the indicated note number in the display) can be heard by pressing the **VOLUME** knob.



* The pitch of the sound is not changed.

PARAMETER FUNCTIONS

Note

Some of the parameters explained in this section may not be active, depending on settings in the System Common parameters. These inactive parameters are not displayed in the LCD. For such parameters, the relevant System Common parameters are described at the side of the LCD illustration.

Bender range

```
Rhythm:C2 [INT]
Bender range=02
```

Pitch bend receive switch = ON

This parameter determines the range over which the pitch is changed, when pitch bend data is received from an external MIDI device.

Range: 0 — 12

The greater the value, the greater the range of the pitch bend. The parameter changes the pitch by \pm one octave at the maximum value (12).

Env mode

Envelope Mode

```
Rhythm:C2 [INT]
ENV mode=NO-SUSTAIN
```

This parameter determines how the Rhythm Tone will sound.

Settings: NO — SUSTAIN/SUSTAIN

NO — SUSTAIN : The time from the sustain level (L3) to the Note off point is ignored by the TVA envelope of the Rhythm Tone, and the decay starts immediately. The sound stops after a specific period ($T1 + T2 + T3 + T4$).

SUS : The Rhythm Tone can be muted by releasing the note played, as the sustain level is maintained until the Note Off occurs.

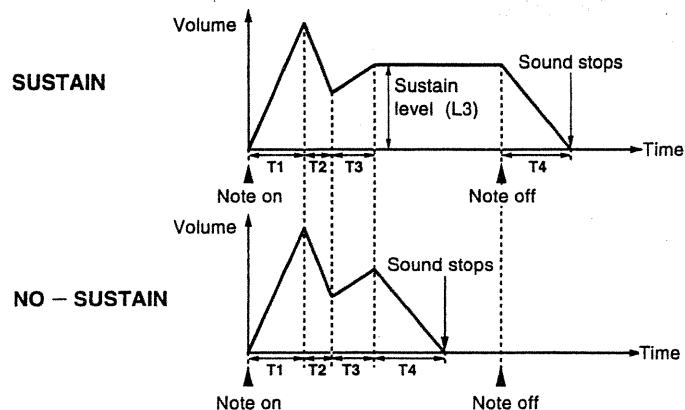

Set the Envelope mode to NO-SUSTAIN for sounds like castanets or snare drum, the sounds of which decay quickly, to prevent the decay from being altered by Note Off data or the use of a sustain pedal.

On the other hand, for instruments like timpani and cymbals, the sound is often muted in the middle of the sound. For these types of sounds, set the Envelope mode to SUSTAIN, and release the note (Note Off) when you want to mute the sound.

Mute group

```
Rhythm:C2      [INT&MIDI]  
Mute group=OFF
```

Similarly numbered Tones are treated as a Mute Group. A Mute Group functions such that when one Rhythm Tone of the group sounds, the other Rhythm Tones in the group cannot sound. Up to 31 groups can be created.

Range: OFF/1 — 31

The mute function has no effect when this parameter is set to OFF.

This is especially effective for hi-hat sounds. Assign the open hi-hat and closed hi-hat sounds the same Mute Group number. By doing so, playing one of the sounds automatically cuts off the other.



The Closed Hi-hat sounds and the open Hi-hat is muted

The Open Hi-hat sounds

Tone switch

Rhythm Tone Switch

```
Rhythm:C2      [INT&MIDI]  
Tone switch=ON
```

This parameter determines whether the presently selected Rhythm Tone sounds (ON) or not.

Settings: ON/OFF

● WG (Wave Generator parameters)

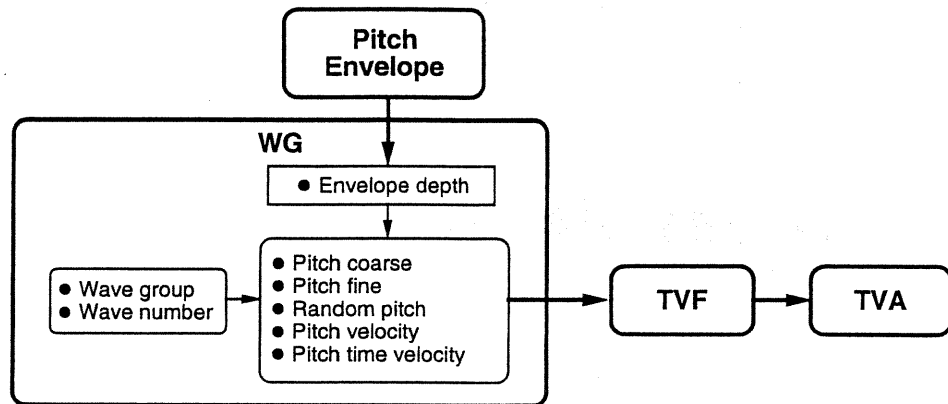

WG wave group

```
Rhythm:C2 [INT&MIDI]
WG wave group=INT
```

This parameter determines the waveform group to be used as the basis for the Rhythm Tone. The JV-880 contains 129 internal waveforms. The waveforms in the optional expansion board (SR-JV80 series) and on PCM Cards (SO-PCM1 series) can also be used.

Settings: INT (internal)/EXP (expansion)/PCM (PCM Card)

- * "PCM" or "EXP" cannot be selected if an expansion board has not been installed, or a PCM Card has not been properly inserted into the PCM CARD slot.

How to Insert the PCM Card

When using waveforms of a PCM card (SO-PCM1 series), insert the PCM card in the PCM card slot on the front panel with the label side up.

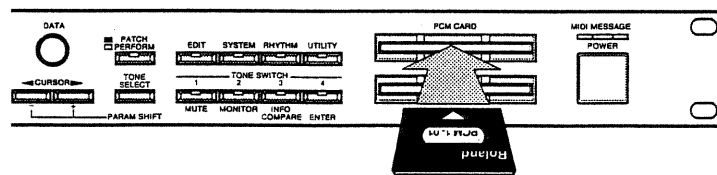

- * See P.10-54 for instructions on installing the expansion board.

WG wave

Wave Number

```
Rhythm:C2      [INT&MIDI]  
WG wave=100 Power Tom Hi
```

This parameter determines the waveform to be used. The waveform number and name are indicated in the display.

WG pitch coarse

.....

```
Rhythm:C2      [INT&MIDI]  
WG pitch coarse=C#-1
```

This parameter determines the pitch of the Rhythm Tone (in semitone steps).

Range: C-1 — G9

- * The range over which some waveforms will sound has an upper limit. When the coarse pitch setting is higher than this limit, the pitch that sounds will be the pitch of the upper limit.

WG pitch fine

.....

```
Rhythm:C2      [INT&MIDI]  
WG pitch fine=-10
```

This parameter offsets the pitch of the Tone (in units of 1/100th of a semitone).

Range: -50 — +50

The pitch is shifted higher than normal when the value is positive, and shifted lower when the value is negative.

WG random pitch

.....

```
Rhythm:C2      [INT]  
WG random pitch=1200
```

The pitch of the Rhythm Tone is shifted over random amounts within the range set here. The value is expressed in units of 1/100th of a semitone.

Settings: 0/5/10/20/30/40/50/70/100/200/300/400/500/600/800/1200

The greater the value, the greater the randomly shifted pitch range.

WG ENV depth

WG Envelope Depth

```
Rhythm:C2 [INT]
WG ENV depth=+10
```

This parameter determines the depth of the pitch envelope.

Range: - 12 — +12

Positive (+) values : The greater the level of the pitch envelope, the higher the pitch.

Negative (-) values : The greater the level of the pitch envelope, the lower the pitch.

WG pitch velocity

.....

```
Rhythm:C2 [INT&MIDI]
WG pitch velocity=+50
```

This parameter determines how the level of the pitch envelope responds to velocity.

Range: - 63 — +63

Positive (+) values : The higher the velocity, the greater the level.

Negative (-) values : The lower the velocity, the greater the level.

WG pitch time velo

WG Pitch Time Velocity

```
Rhythm:C2 [INT&MIDI]
WG pitch time velo=+100
```

This parameter determines how the T1 time of the pitch envelope is affected by velocity.

Settings: - 100/ - 70/ - 50/ - 40/ - 30/ - 20/ - 10/0/+10/+20/+30/+40/+50/+70/+100

Positive (+) values : The greater the velocity, the longer the time of T1.

0 : No change.

Negative (-) values : The greater the velocity, the shorter the time.

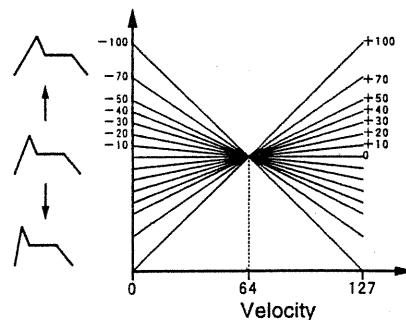

● P - ENV (Pitch Envelope parameters)

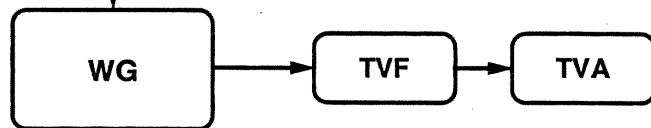
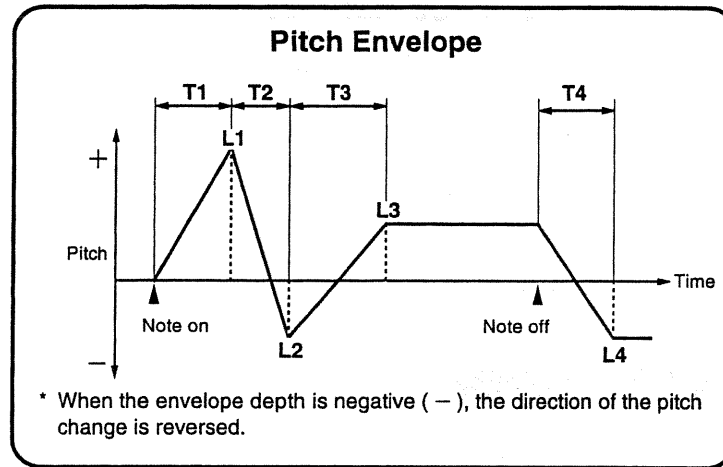

T1/T2/T3/T4, L1/L2/L3/L4

Rhythm:C2	[INT&MIDI]
P-ENV T1=05	L1=+60
Rhythm:C2	[INT&MIDI]
P-ENV T2=10	L2=-10
Rhythm:C2	[INT&MIDI]
P-ENV T3=20	L3=+50
Rhythm:C2	[INT&MIDI]
P-ENV T4=05	L4=-40

These parameters determine the time settings (T1, T2, T3 and T4) and the level settings (L1, L2, L3 and L4) of the pitch envelope.

Each time setting (T) represents the time it takes for the pitch to change from one point to the next; for example, T1 is the time it takes the pitch to change from the Note On to L1.

The "L" parameters determine the amount by which the pitch is changed at each point.

Range: T = 0 — 127 / L = - 63 — +63

T : The greater the value, the longer the time it takes to reach the next level.

L : When the value is positive, the pitch is higher (lower) than standard pitch. When the value is negative, the pitch is lower (higher) than standard pitch.

TVF parameters

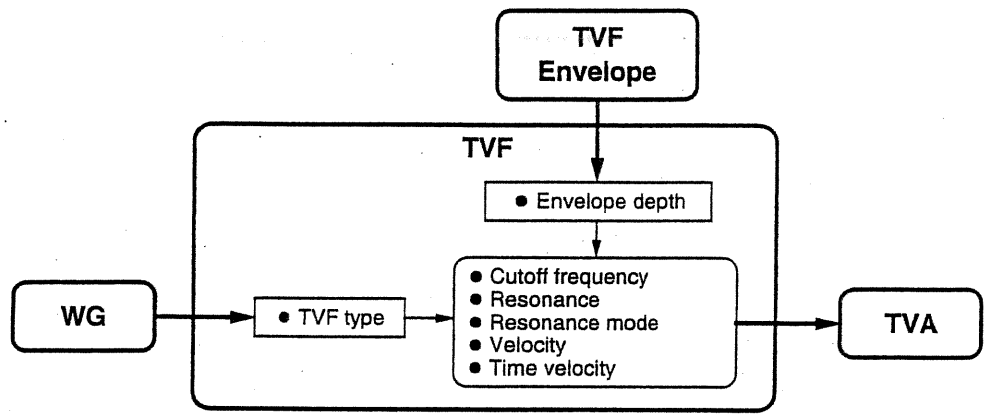

TVF type

Filter Type

```

Rhythm:C2 [INT&MIDI]
TVF type=LPF
  
```

This parameter determines the filter type, or what frequencies are filtered (removed).

Settings: OFF/LPF/HPF

- OFF : Filter doesn't function.
- LPF : Low pass filter. This filter removes frequencies above the cutoff frequency, and is the more commonly used filter type. Since the high range frequencies are cut, the sound becomes more mellow.
- HPF : High pass filter. This filter removes frequencies below the cutoff frequency. The sound becomes brighter as low range frequencies are removed.

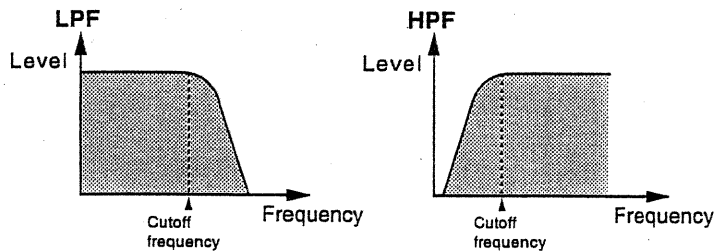

TVF cutoff freq

Cutoff Frequency

```
Rhythm:C2 [INT&MIDI]  
TVF cutoff freq=70
```

This parameter determines the cutoff frequency, above or below which the TVF is applied for filtering out the specified frequencies of the waveform.

Range: 0 — 127

The greater the value, the higher the cutoff frequency.

- ◆ If the filter has been set to LPF, lower cutoff frequency values will decrease the higher partials of the spectrum, causing the sound to become darker, and lower in volume.

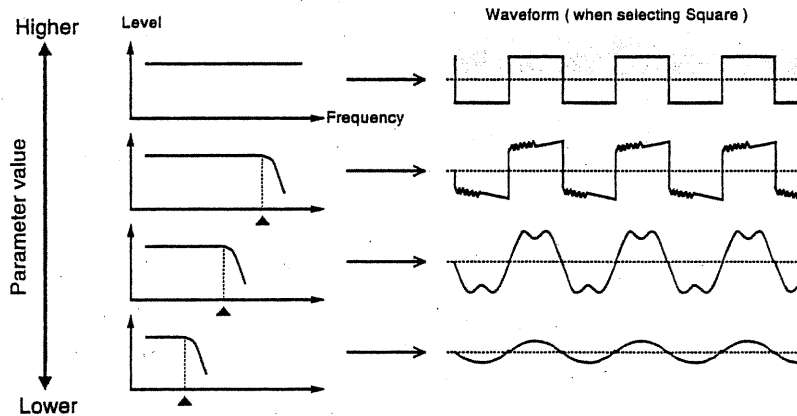

- ◆ If the filter has been set to HPF, higher cutoff frequency values will decrease the lower partials of the spectrum, causing the sound to become harder or brighter. Depending on the waveform, high cutoff frequency values may result in no sound if the selected waveform does not contain any partials in the frequency range that is allowed to pass.

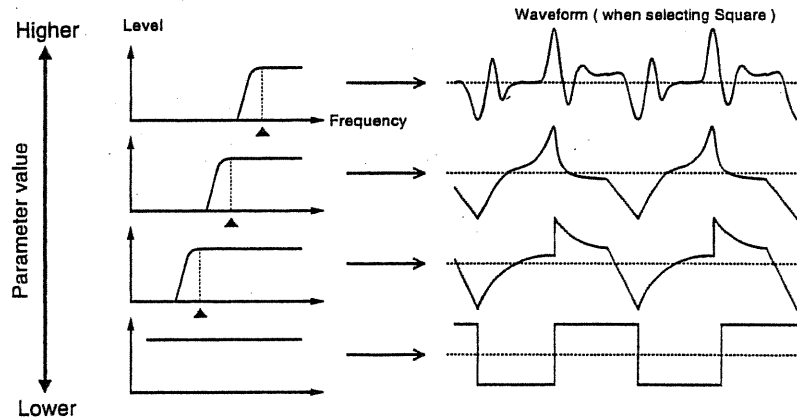

TVF resonance

```
Rhythm:C2 [INT&MIDI]  
TVF resonance=20
```

This parameter creates a characteristic sound by emphasizing the frequency elements around the cutoff frequency of the TVF.

The emphasized frequency changes along with the cutoff frequency, when the cutoff frequency is modulated by the envelope.

Range: 0 — 127

The greater the value, the greater the resonance effect.

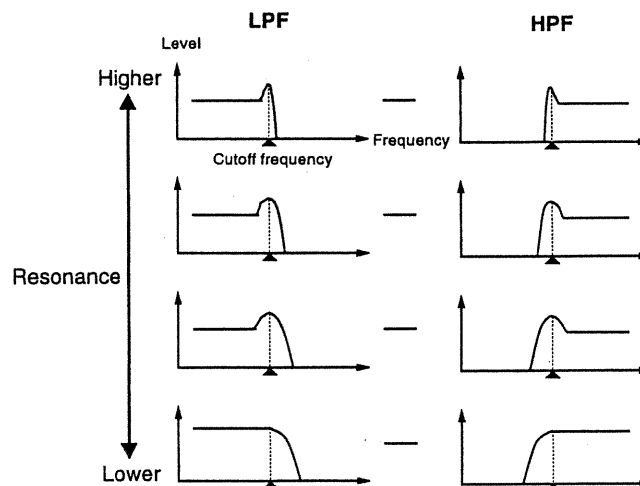

- * There are some cases in which the resonance effect decreases, such as when the Tone level is high when it sounds, or when the cutoff frequency is high.

TVF reso mode

TVF Resonance Mode

```
Rhythm:C2 [INT&MIDI]  
TVF reso mode=HARD
```

This parameter determines the type of resonance.

Settings: SOFT/HARD

SOFT : The resonance effect is moderate.

HARD : The resonance effect is pronounced.

TVF ENV depth

TVF Envelope Depth

```
Rhythm:C2      [INT&MIDI]  
TVF ENV depth=+10
```

This parameter determines the depth of the TVF envelope.

Range: - 63 — +63

Positive (+) values : The greater the TVF envelope level, the higher the cutoff frequency.

Negative (-) values : The greater the envelope level, the lower the cutoff frequency.

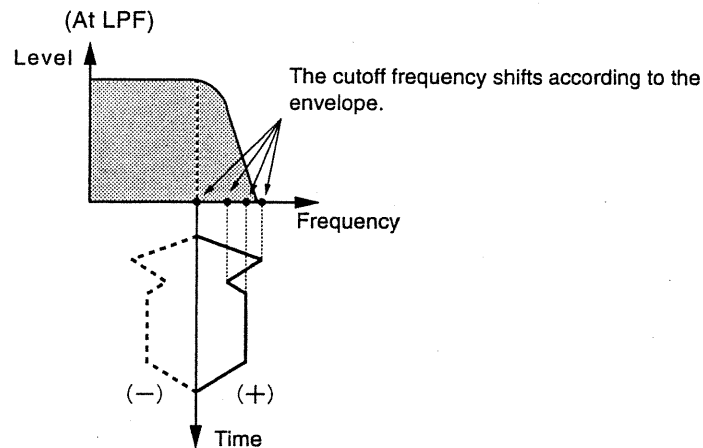

TVF velocity

.....

```
Rhythm:C2      [INT&MIDI]  
TVF velocity=+20
```

This parameter determines how the level of the TVF envelope is affected by velocity.

Range: - 63 — +63

Positive (+) values : The higher the velocity, the greater the level of envelope.

0 : The envelope level remains constant, regardless of the velocity.

Negative (-) values : The lower the velocity, the greater the level.

TVF time velocity

```
Rhythm:C2 [INT&MIDI]  
TVF time velocity:+70
```

This parameter determines how the T1 time of the TVF envelope is affected by velocity.

Settings: - 100/ - 70/ - 50/ - 40/ - 30/ - 20/ - 10/0/+10/+20/+30/+40/+50/+70/+100

Positive (+) values : The higher the velocity, the longer the time of T1.

0 : No change.

Negative (-) values : The higher the velocity, the shorter the time.

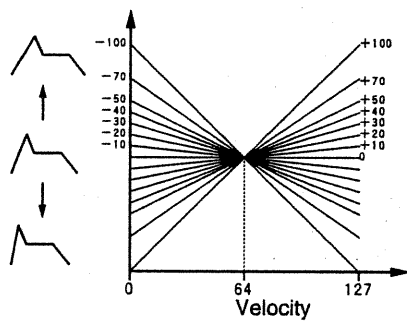

● F-ENV (TVF envelope parameters)

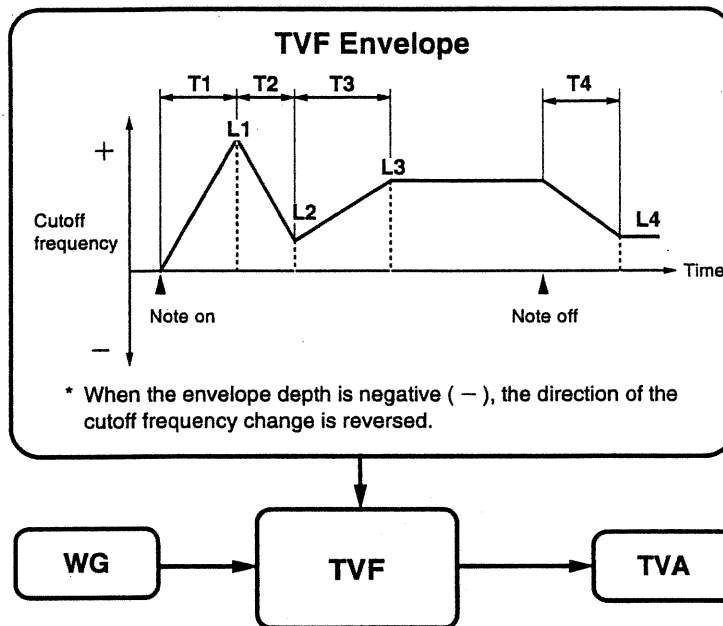

T1/T2/T3/T4, L1/L2/L3/L4

Rhythm:C2	[INT&MIDI]
F-ENV T1=05	L1=100
Rhythm:C2	[INT&MIDI]
F-ENV T2=10	L2=10
Rhythm:C2	[INT&MIDI]
F-ENV T3=20	L3=50
Rhythm:C2	[INT&MIDI]
F-ENV T4=05	L4=100

These parameters determine the time settings (T1, T2, T3 and T4) and the level settings (L1, L2, L3 and L4) of the TVF envelope.

The "T" parameters indicate the time it takes for the cutoff frequency to reach the next cutoff frequency. (For example, T1 is the time it takes the cutoff frequency to change from Note On to L1).

The "L" parameters determine the amount by which the cutoff frequency is changed at each point.

Range: T = 0 — 127/L1 = 0 — 127

T : The greater the value, the longer the time it takes to reach the next level.

L : The greater the value, the higher the cutoff frequency.

The value set here follows adjustment by the TVF envelope depth before changing the cutoff frequency.

● TVA parameters

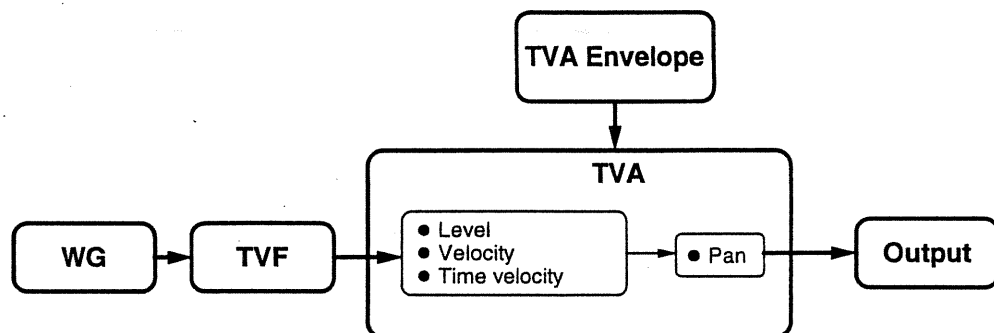

TVA level

```
Rhythm:C4 [INT&MIDI]  
TVA level=127
```

This parameter determines the level of the Rhythm Tone.

Range: 0 — 127

The greater the value, the greater the level.

TVA velocity

```
Rhythm:C4 [INT&MIDI]  
TVA velocity=-10
```

This parameter determines how velocity affects the level of the Rhythm Tone.

Range: - 63 — +63

Positive (+) values : The higher the velocity, the higher the level.

0 : No change.

Negative (-) values : The higher the velocity, the lower the level.

TVA time velocity

```
Rhythm:C4 [INT&MIDI]  
TVA time velocity=-50
```

This parameter determines how the T1 time of the TVA envelope is affected by velocity.

Settings: -100/-70/-50/-40/-30/-20/-10/0/+10/+20/+30/+40/+50/+70/+100

Positive (+) values : The higher the velocity, the longer the time of T1.

0 : No change.

Negative (-) values : The higher the velocity, the shorter the time.

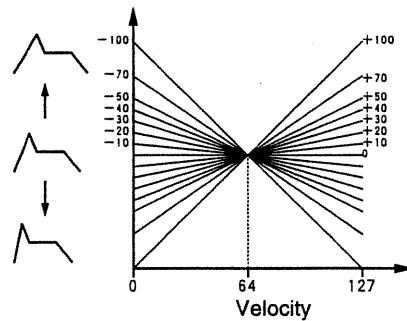

TVA pan

```
Rhythm:C4 [INT&MIDI]  
TVA pan=RND
```

This parameter determines the stereo (L/R) position of the Rhythm Tone.

Range: L64 — 0 — 63R/RND

The stereo position is at the farthest left at L64, in the center at 0, and at the farthest right at 63R.

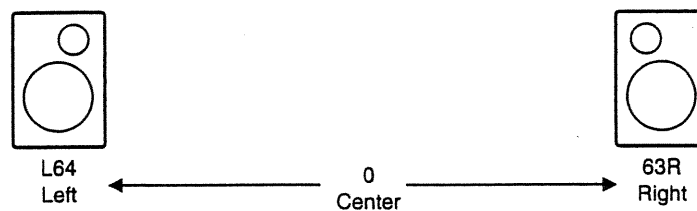

● A-ENV (TVA envelope parameters)

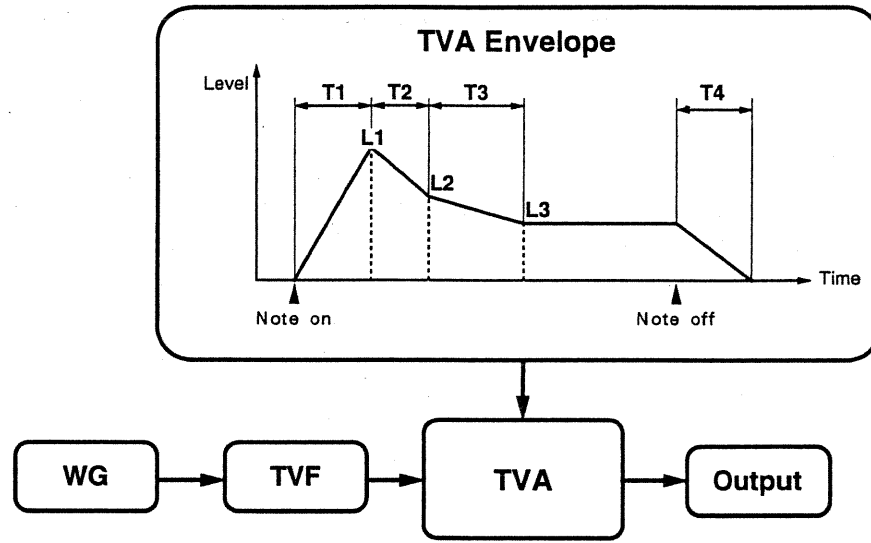

T1/T2/T3/T4, L1/L2/L3

```
Rhythm:C4 [INT&MIDI]
A-ENV T1=05 L1=100
```

```
Rhythm:C4 [INT&MIDI]
A-ENV T2=10 L2=10
```

```
Rhythm:C4 [INT&MIDI]
A-ENV T3=20 L3=50
```

```
Rhythm:C4 [INT&MIDI]
A-ENV T4=05
```

These parameters determine the time settings (T1, T2, T3 and T4) and the level settings (L1, L2 and L3) of the TVA envelope.

The "T" parameters indicate the time it takes for the level of the sound to reach from one point to the next; for example, T1 is the time between Note On and L1.

The "L" parameters determine the level at each point.

Range: T = 0 — 127 / L = 0 — 127

T : The greater the value, the longer it takes to reach the next level.

L : The greater the value, the greater the level.

In the case of the TVA, the envelope level becomes 0 after Note Off.

● Output parameters

These parameters determine the output level and destination of each Rhythm Tone.

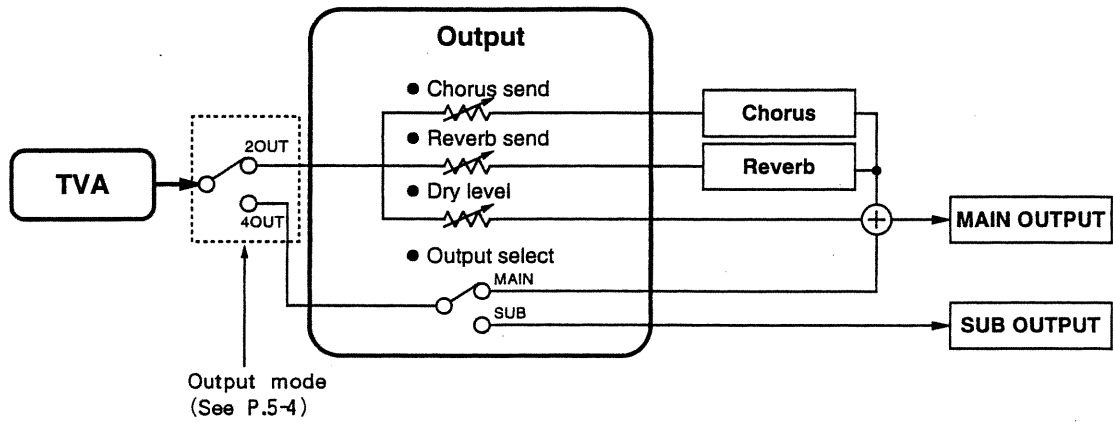

Output dry level

```
Rhythm:C4      [INT&MIDI]
Output dry level=127
```

Output mode = 2OUT

This parameter determines the level of the dry (unprocessed) sound. If no effect has been applied to the Tone, you should set this parameter value to 127, and adjust the sound volume from the Tone Level parameter of the TVA (See P.8-18).

Range: 0 — 127

The greater the value, the greater the level of the dry sound.

Output chorus send

```
Rhythm:C4      [INT&MIDI]
Output chorus send=25
```

Output mode = 2OUT
Chorus switch = ON

This parameter determines the level of the signal sent to the chorus unit. This setting changes the amount of chorus applied to each Rhythm Tone.

Range: 0 — 127

The greater the value, the greater the level of the signal sent to the chorus unit.

Output reverb send

```
Rhythm:C4      [INT&MIDI]  
Output reverb send=30
```

Output mode = 2OUT
Reverb switch = ON

This parameter determines the level of the signal sent to the reverb unit. This setting changes the amount of the reverb applied to each Rhythm Tone.

Range: 0 — 127

The greater the value, the greater the level of the signal sent to the reverb unit.

Output select

```
Rhythm:C4      [INT&MIDI]  
Output select=MAIN
```

Output mode = 4OUT

This parameter determines which set of stereo outputs will be used when the output mode setting (See P.5-4) of the System Common parameter is set to "4OUT."

Settings: MAIN/SUB

MAIN : Output through MAIN OUTPUT jacks

SUB : Output through SUB OUTPUT jacks

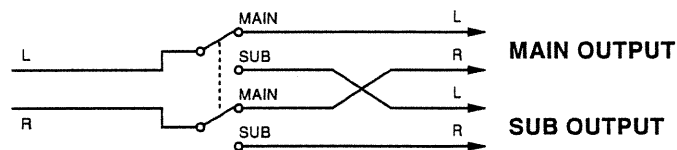

- * The final output assignment of the Patch, when playing in the Performance Play mode, is determined by the output setting (See P.7-15) in the Performance Part parameters.

MEMO

Section

9

- ◆ **WRITE OPERATION**
- ◆ **ADDITIONAL
FUNCTIONS**

UTILITY MODE

THE UTILITY MODE

Press **UTILITY** to select the Utility mode. (The indicator lights.)

write

Write operation

This operation stores edited data (Patches, Performances or Rhythm Sets) to internal memory or to a Data Card.

copy

Copying data

This operation copies Patch, Performance and Rhythm Set data to the temporary area.

initialize

This operation initializes (returns) Patch, Performance and Rhythm Set data in the temporary area to the factory preset parameter values.

Data card

This operation allows you to transfer data between internal memory and a Data Card. This operation also initializes a Data Card.

Bulk dump

This operation transfers data to an external MIDI device.

Temporary dump

This operation transfers the data in the temporary area to an external MIDI device.

Load patch single

Loading a Single Patch

This operation copies the data of a single Patch stored on a PCM Card (SO-PCM 1 series) or in an expansion board (SR-JV80 series) to the temporary area, internal memory or Data Card.

Load patch group

Loading a Group of Patches

This operation copies Patch data (in groups) from a PCM Card (SO-PCM 1 series) or an expansion board (SR-JV80 series) to internal memory or Data Card.

Memory protect

This operation prevents data stored in internal memory from inadvertently being erased or edited.

Factory preset

This operation restores the data in internal memory, temporary area and system area to the factory preset data.

ROM play

This operation allows you to listen to the demo songs stored in memory. Refer to P.1-4 for details on operation.

WRITE

Edited Patch, Performance or Rhythm Set data can be stored in internal memory or on a Data Card.

The type of data stored depends on the mode which was selected before entering the Utility mode.

Patch Play/Edit mode	: Patch Write
Performance Play/Edit mode	: Performance (Perf) Write
Rhythm Edit mode	: Rhythm Write

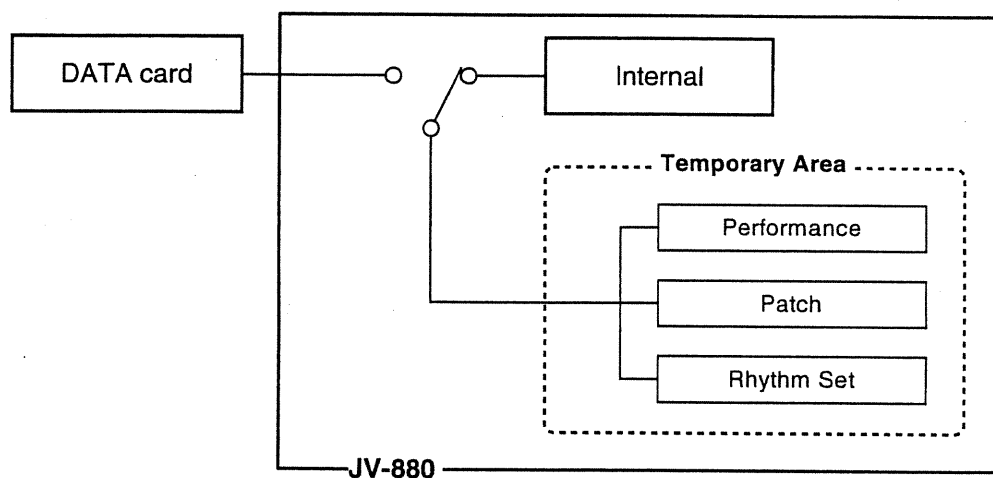

- * When storing data in internal memory, the Write operation can only be executed after turning the memory protect function (See P.9-22) off.
- * When writing to a Data Card, turn off the protect switch on the Card after inserting it into the DATA CARD slot. The Write operation cannot be executed with the switch in the ON position. To protect data stored on a Card, turn the protect switch ON.

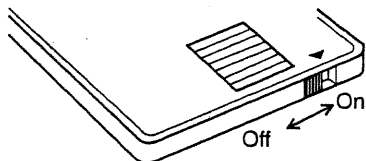

Patch Write

```
Util:Patch write  
TEMP → C01 [ENTER]
```

Patch number to be stored

- ① Press **PATCH/PERFORM** to enter the Patch mode. (The indicator lights.)
 - ② Press **UTILITY**. (The indicator lights.)
 - ③ Move the cursor to the top line of the display using **◀CURSOR▶**.
 - ④ Select "Patch write" by rotating the **DATA** dial.
- * During editing, parameters can be changed (regardless of the cursor position) by holding down the **PARAM SHIFT** button and pressing **+** or **-**.
- ⑤ Move the cursor to the bottom line of the display using **◀CURSOR▶**.
 - ⑥ Select the data destination by rotating the **DATA** dial.
Destination → I01 — 64
 C01 — 64

- * Simultaneously press and rotate the **DATA** dial to switch between I (internal) and C (Data Card).
- * Data Card cannot be selected if a Data Card has not been properly inserted into the DATA CARD slot.
- * You can check the Patch sound already stored at the destination by pressing **COMPARE**. Press **COMPARE** again after checking the sound.

```
Util:Patch compare  
C01 [COMPARE]
```

- ⑦ Execute the Write operation by pressing **ENTER**.
- * When Internal is selected as the destination, and memory protect is currently ON, pressing **ENTER** calls up the following display:

```
Turn protect off once?  
[ENTER]
```

Memory protect will be temporarily turned OFF if **ENTER** is pressed when this display appears.

Press **ENTER** again to execute the Write operation.

"Complete" is displayed when the Write operation is finished. The unit automatically returns to the Patch Play mode.

Performance Write (Perf Write)

```
Util:Perf write  
TEMP → I-01 [ENTER]
```

Performance number to be stored

- ① Press **PATCH/PERFORM** to enter the Performance mode. (The indicator goes out.)
- ② Press **UTILITY**. (The indicator lights.)
- ③ Move the cursor to the top line of the display using **◀ CURSOR ▶**.
- ④ Select "Perf write" by rotating the **DATA** dial.
 - * During editing, parameters can be changed (regardless of the cursor position) by holding down the **PARAM SHIFT** button and pressing **+** or **-**.
- ⑤ Move the cursor to the bottom line of the display using **◀ CURSOR ▶**.
- ⑥ Select the data destination by rotating the **DATA** dial.

```
Destination → I-01 — 64  
                  C-01 — 64
```

 - * Simultaneously press and rotate the **DATA** dial to switch between I (internal) and C (Data Card).
 - * Data Card cannot be selected if a Data Card has not been properly inserted into the DATA CARD slot.
- ⑦ Execute the Write operation by pressing **ENTER**.

- * When Internal is selected as the destination, and memory protect is currently ON, pressing **ENTER** calls up the following display.

```
Turn protect off once?  
[ENTER]
```

Memory protect will be temporarily turned OFF if **ENTER** is pressed when this display appears.

Press **ENTER** again to execute the Write operation.

"Complete" is displayed when the Write operation is finished. The unit automatically returns to the Performance Play mode.

Rhythm Write

```
Util:Rhythm write
TEMP → INT      [ENTER]
```

↑
Memory of the destination

- ① Press **RHYTHM** to enter the Rhythm Edit mode. (The indicator lights.)
- ② Press **UTILITY**. (The indicator lights.)
- ③ Move the cursor to the top line of the display using **◀ CURSOR ▶**.
- ④ Select "Rhythm write" by rotating the **DATA** dial.
 - * During editing, parameters can be changed (regardless of the cursor position) by holding down the **PARAM SHIFT** button and pressing **+** or **-**.
- ⑤ Move the cursor to the bottom line of the display using **◀ CURSOR ▶**.
- ⑥ Select the data destination by rotating the **DATA** dial.
 - Destination → INT (Internal)
 - CRD (Data Card)
 - * Data Card cannot be selected if a Data Card has not been properly inserted into the DATA CARD slot.
- ⑦ Execute the Write operation by pressing **ENTER**.
 - * When Internal is selected as the destination, and memory protect is currently ON, pressing **ENTER** calls up the following display.

```
Turn protect off once?
                        [ENTER]
```

Memory protect will be temporarily turned OFF if **ENTER** is pressed when this display appears.

Press **ENTER** again to execute the Write operation.

"Complete" is displayed when the Write operation is finished. The unit automatically returns to the Rhythm Edit mode.

COPYING DATA

The type of data copied depends on the mode which was selected before entering the Utility mode.

Patch Play/Edit mode : Patch copy
Performance Play/Edit mode : Performance (Perf) copy
Rhythm Edit mode : Rhythm copy

Patch Copy

This operation copies data of a Tone of the Patch to a Tone in the temporary area. This operation also copies the settings of the Patch Common parameters to the Patch in the temporary area.

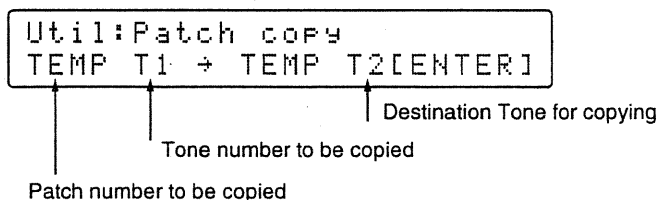

- ① Press **PATCH/PERFORM** to enter the Patch mode. (The indicator lights.)
 - ② Press **UTILITY**. (The indicator lights.)
 - ③ Move the cursor to the top line of the display using **◀ CURSOR ▶**.
 - ④ Select "Patch copy" by rotating the **DATA** dial.
- * During editing, parameters can be changed (regardless of the cursor position) by holding down the **PARAM SHIFT** button and pressing **+** or **-**.
- ⑤ Move the cursor to the Patch number to be copied using **◀ CURSOR ▶**.
 - ⑥ Select the Patch to be copied by rotating the **DATA** dial.
Source Patch → TEMP (temporary)
A01 — 64
B01 — 64
I01 — 64
C01 — 64
- * You can switch among the Patch groups (TEMP, A, B, I and C) by pressing and rotating the **DATA** dial.
- * Patches on a Data Card cannot be selected if the Data Card has not been properly inserted into the DATA CARD slot.

- ⑦ Move the cursor to the Tone number to be copied using **◀ CURSOR ▶**.
- ⑧ Select the Tone to be copied by rotating the **DATA** dial.
Source Tone → T1 — 4
COM (Patch Common parameters)
- * Select **"COM"** and skip to step ⑩ when copying the settings of the Patch Common parameters.
- ⑨ Move the cursor to the Tone destination number using **◀ CURSOR ▶**.
- ⑩ Select the Tone destination number by rotating the **DATA** dial.
Destination Tone → T1 — 4
- ⑪ Execute the Copy operation by pressing **ENTER**.

"Complete" is displayed when the Copy operation is finished.

Performance Copy (Perf copy)

This operation copies the settings of a Part (of a Performance) to a Part of the Performance in the temporary area. This operation also copies the settings of the Performance Common parameters to a Performance in the temporary area.

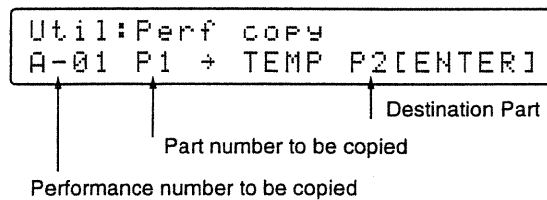

- ① Press **PATCH/PERFORM** to enter the Performance mode. (The indicator goes out.)
- ② Press **UTILITY**. (The indicator lights.)
- ③ Move the cursor to the top line of the display using **◀ CURSOR ▶**.
- ④ Select **"Perf copy"** by rotating the **DATA** dial.
- * During editing, parameters can be changed (regardless of the cursor position) by holding down the **PARAM SHIFT** button and pressing **+** or **-**.
- ⑤ Move the cursor to the Performance number to be copied using **◀ CURSOR ▶**.

-
- ⑥ Select the Performance to be copied by rotating the **DATA** dial.

Source Performance → TEMP (temporary)

A 01 — 16

B 01 — 16

I 01 — 16

C 01 — 16

- * You can select the Performance group (TEMP, A, B, I or C) by simultaneously pressing and rotating the **DATA** dial.
- * A Performance on a Data Card cannot be selected if the Data Card has not been properly inserted into the DATA CARD slot.

- ⑦ Move the cursor to the Part number to be copied using **◀ CURSOR ▶**.

- ⑧ Select the Part to be copied by rotating the **DATA** dial.

Source Part → P1 — 8

COM (Performance Common parameters)

- * Select "**COM**" and skip to step ⑪ when copying the settings of the Performance Common parameters.

- ⑨ Move the cursor to the Part destination number using **◀ CURSOR ▶**.

- ⑩ Select the Part destination number by rotating the **DATA** dial.

Destination Part → P1 — 8

- ⑪ Execute the Copy operation by pressing **ENTER**.

"**Complete**" is displayed when the Copy operation is finished.

Rhythm Copy

This operation copies the data of a Rhythm Tone (in a Rhythm Set) to a Rhythm Tone of the Rhythm Set in the temporary area.

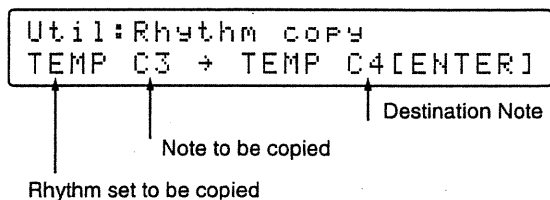

- ① Press **RHYTHM** to enter the Rhythm Edit mode. (The indicator lights.)
- ② Press **UTILITY**. (The indicator lights.)
- ③ Move the cursor to the top line of the display using **◀ CURSOR ▶**.
- ④ Select "Rhythm copy" by rotating the **DATA** dial.
- * During editing, parameters can be changed (regardless of the cursor position) by holding down the **PARAM SHIFT** button and pressing **+** or **-**.
- ⑤ Move the cursor to the Rhythm Set to be copied using **◀ CURSOR ▶**.
- ⑥ Select the Rhythm Set to be copied by rotating the **DATA** dial.
Source Rhythm Set → TEMP (temporary)
PRA (preset A)
PRB (preset B)
INT (internal)
CRD (Data card)
- * A Rhythm Set on a Data Card cannot be selected if the Data Card has not been properly inserted into the DATA CARD slot.
- ⑦ Move the cursor to the note to be copied using **◀ CURSOR ▶**.
- ⑧ Select the note to be copied by rotating the **DATA** dial.
Source Note → C2 — C7
- * Rotate the **DATA** dial to move through the notes in one octave jumps.
- ⑨ Move the cursor to the destination note using **◀ CURSOR ▶**.

-
- ⑩ Select the destination note by rotating the DATA dial.

Destination Note → C2 — C7

- ⑪ Execute the Copy operation by pressing **ENTER**.

“Complete” is displayed when the Copy operation is finished.

When the Rhythm Edit key (See P.5-12) of the System Common parameters is set to **“INT & MIDI”**, notes can be selected on a connected MIDI keyboard when the cursor is at the note position in the display.

* Match the transmit channel of the connected MIDI device to the receive channel of Part 8 of the Performance selected before entering the Utility mode.

INITIALIZE

The type of data initialized depends on the mode which was selected before entering the Utility mode.

Patch Play/Edit mode : Patch Initialize
Performance Play/Edit mode : Performance (Perf) Initialize
Rhythm Edit mode : Rhythm Initialize

* See P.10-14 for information about initialized data.

Patch Initialize

This operation restores the Patch data in the temporary area to initialized data.

```
Util:Patch initialize  
[ENTER]
```

- ① Press **RATCH/PERFORM** to enter the Patch mode. (The indicator lights.)
- ② Press **UTILITY**. (The indicator lights.)
- ③ Select “Patch initialize” by rotating the **DATA** dial.

* During editing, parameters can be changed (regardless of the cursor position) by holding down the **PARAM SHIFT** button and pressing **+** or **-**.

- ④ Execute the Initialize operation by pressing **ENTER**.

“Complete” is displayed when the Initialize operation is finished. The JV automatically returns to the Patch Play mode.

Performance Initialize (Perf Initialize)

This operation restores the Performance data in the temporary area to initialized data.

```
Util:Perf initialize  
[ENTER]
```

- ① Press **RATCH/PERFORM** to enter the Performance mode. (The indicator goes out.)
- ② Press **UTILITY**. (The indicator lights.)
- ③ Select “Perf initialize” by rotating the **DATA** dial.

* During editing, parameters can be changed (regardless of the cursor position) by holding down the **PARAM SHIFT** button and pressing **+** or **-**.

- ④ Execute the Initialize operation by pressing **ENTER**.

“**Complete**” is displayed after the Initialize operation is finished. The JV automatically returns to the Performance Play mode.

Rhythm Initialize

This operation restores the data of a Rhythm Tone of the Rhythm Set in the temporary area to factory preset values.

```
Util:Rhythm initialize  
C#4 [ENTER]
```

↑ Note to be initialized

- ① Press **RHYTHM** to enter the Rhythm Edit mode. (The indicator lights.)
 - ② Press **UTILITY**. (The indicator lights.)
 - ③ Select “**Rhythm initialize**” by rotating the **DATA** dial.
- * During editing, parameters can be changed (regardless of the cursor position) by holding down the **PARAM SHIFT** button and pressing **+** or **-**.
- ④ Move the cursor to the bottom line of the display using **◀ CURSOR ▶**.
 - ⑤ Select the note to be initialized by rotating the **DATA** dial.
C2 — C 7 : The Rhythm Tone assigned to the selected note will be initialized.
ALL : All Rhythm Tones are initialized.
- * Rotate the **DATA** dial to move through the notes in one octave jumps.
- ⑥ Execute the Initialize operation by pressing **ENTER**.

“**Complete**” is displayed after the Initialize operation is finished. The JV automatically returns to the Rhythm Edit mode.

When the Rhythm Edit key (See P.5-12) of the System Common parameters is set to “**INT & MIDI**”, notes can be selected on a connected MIDI keyboard when the cursor is at the note position in the display.

* Match the transmit channel of the connected MIDI device to the receive channel of Part 8 of the Performance selected before entering the Utility mode.

DATA CARD

The following Data Card functions are available:

INT → CARD

All Performance, Patch and Rhythm Set data in internal memory can be copied to a Data Card.

CARD → INT

All Performance, Patch and Rhythm Set data in a Data Card can be copied to internal memory.

INT ← → CARD

The Performance, Patch and Rhythm Set data on a Data Card, and the Performance, Patch and Rhythm Set data in internal memory can be swapped, or exchanged.

INITIALIZE

All data in a Data Card can be initialized.
See P.10-14 for information about initialized data.

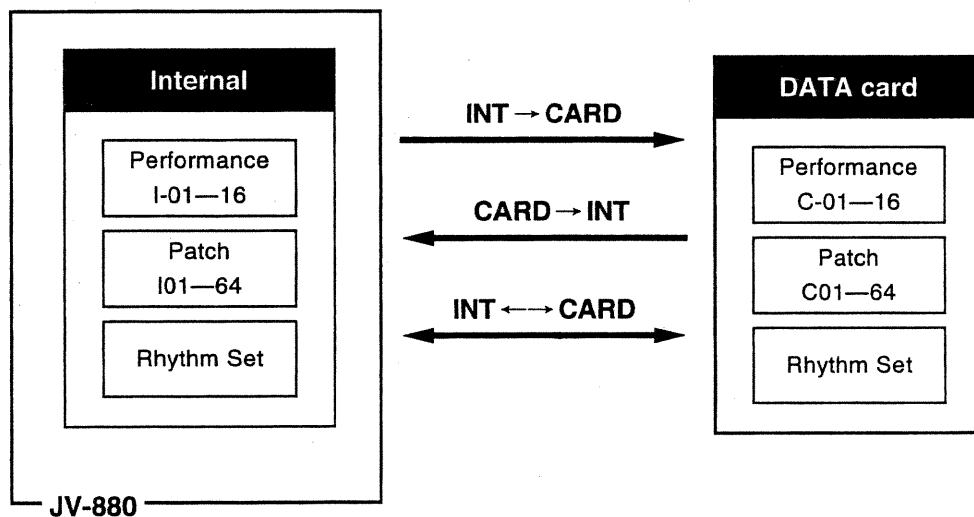

- * When copying to a Data Card (or when initializing a Data Card), turn the protect switch on the Card to OFF (after the Card has been inserted into the Card slot). The Write operation cannot be executed with the switch ON. When you have finished storing data on the Card, turn the protect switch to the ON position to protect your data from accidental erasure.

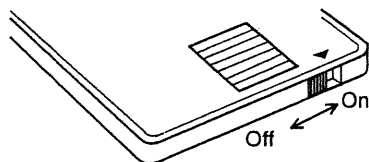

```
Util:Data card
INT → CARD      [ENTER]
```

↑
Function

- ① Press **UTILITY**. (The indicator lights.)
- ② Move the cursor to the top line of the display using **◀ CURSOR ▶**.
- ③ Select "Data card" by rotating the **DATA** dial.
 - * During editing, parameters can be changed (regardless of the cursor position) by holding down the **PARAM SHIFT** button and pressing **+** or **-**.
- ④ Move the cursor to the bottom line of the display using **◀ CURSOR ▶**.
- ⑤ Select the desired function by rotating the **DATA** dial.
 - Functions → INT → CARD
 - CARD → INT
 - INT ↔ CARD
 - INITIALIZE
- ⑥ Execute the function by pressing **ENTER**.
 - * This operation prepares a new Card (or a Card previously used with another device) for use with the JV-880.
 - * The following display appears if you attempt to execute the CARD → INT or INT ↔ CARD function while memory protect is ON.

```
Turn protect off once?
[ENTER]
```

Memory protect will be temporarily turned OFF if **ENTER** is pressed from this display.
Press **ENTER** again to execute the function.

"Complete" is displayed when this operation is finished. Return one of these modes: Patch Play, Performance Play or Rhythm Edit.

Note

You can create Performances by combining Patches from both internal memory and a Data Card. When copying Performance data created in this way from internal memory to a Data Card (or vice versa), take care to avoid possible problems, such as those described in the following example.

Example:

In this example, a Performance (numbered **I-01**) has been created, and in it Patch **I12** has been assigned to Part 1, and Patch **C11** has been assigned to Part 2. When the Performance is copied from internal memory to a Data card, it is stored as "**C01**" in the Card. In this operation, the Patch of Part 1 is stored as "**C12**" and the Patch of Part 2 remains the same (**C11**).

If this copied Performance is copied again, this time from the Data Card back to internal memory, the Performance is stored as "**I-01**," and Part 1 is stored as "**I12**." However, Part 2 is now stored as "**I11**." Therefore, even though the Performance number is the same as that of the original data, the Patch number set for Part 2 has been changed.

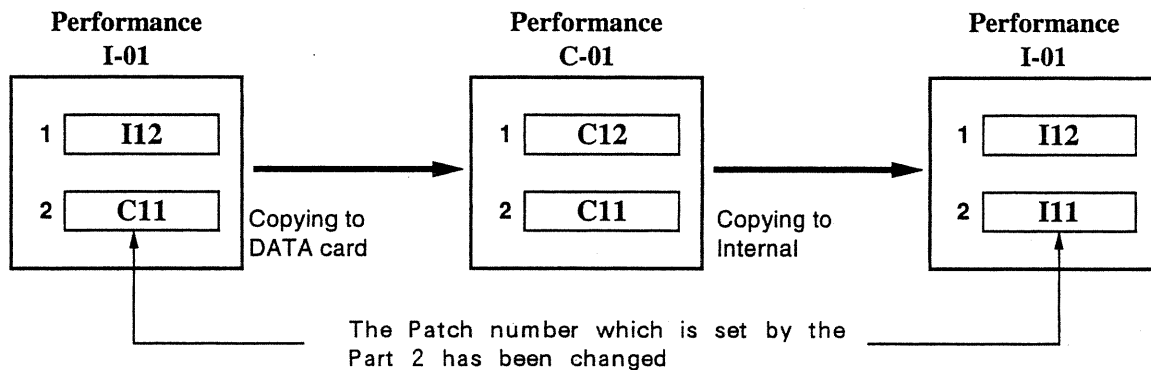

* Use the Bulk Dump function (See P.9-16) when you want to store the internal data as it is (without being changed).

BULK DUMP

The JV-880 is capable of transmitting data via the MIDI OUT terminal.

Sound data can be transferred via MIDI to and from another JV-880, or a device specifically designed for recording bulk data (such as the Roland MC-50).

This function is useful for backing up (copying) important data.

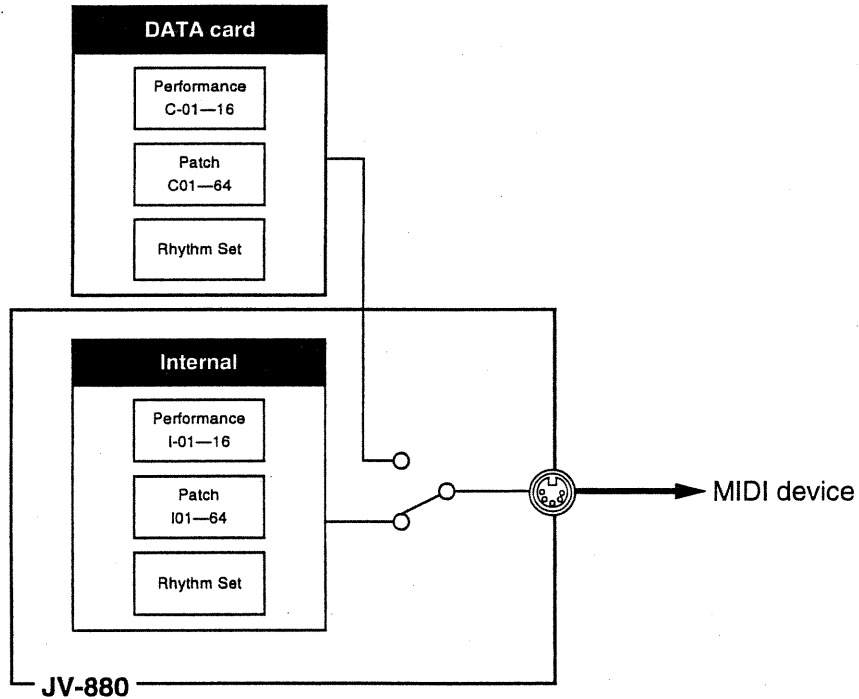

Connections

Refer to the following chart.

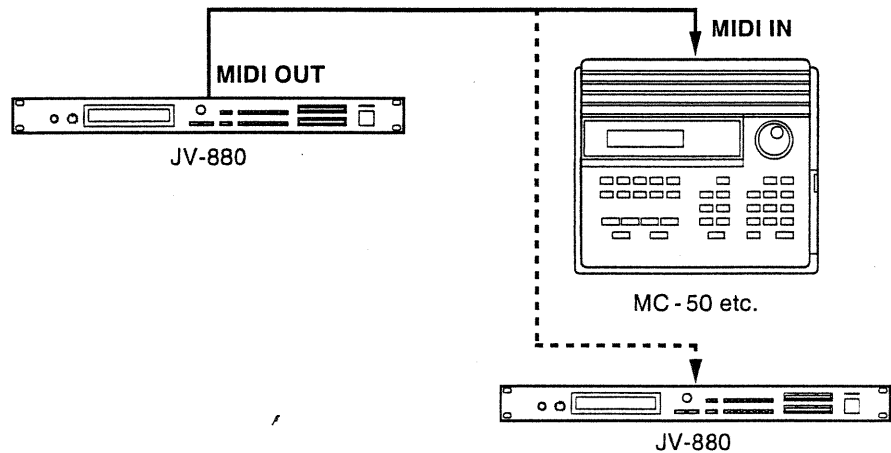

- * Match the unit numbers (See P.5-6) of the transmitting and receiving devices.
- * The data is transferred by a one-way method which involves no "handshaking."
- * Keep in mind that all data in the transfer destination is destroyed if the data transfer operation is interrupted.

```
Util: Bulk dump
INT → MIDI          [ENTER]
```

↑
Data to be transferred

- ① Press **UTILITY**. (The indicator lights.)
- ② Move the cursor to the top line of the display using **◀ CURSOR ▶**.
- ③ Select "**Bulk dump**" by rotating the **DATA** dial.
- * During editing, parameters can be changed (regardless of the cursor position) by holding down the **PARAM SHIFT** button and pressing **+** or **-**.
- ④ Move the cursor to the bottom line of the display using **◀ CURSOR ▶**.
- ⑤ Select the data to be transferred by rotating the **DATA** dial.
INT → MIDI : Data in the internal memory is transferred.
CARD → MIDI : Data on a Data Card is transferred.
- ⑥ Execute the Bulk Dump operation by pressing **ENTER**.

"**Now Sending**" is displayed when the transfer of data begins.

"**Complete**" is displayed when the transfer is finished. Return one of the these modes: Patch Play, Performance Play or Rhythm Edit.

TEMPORARY DUMP

The Temporary Dump function can transmit the data in the temporary area via the MIDI OUT terminal.

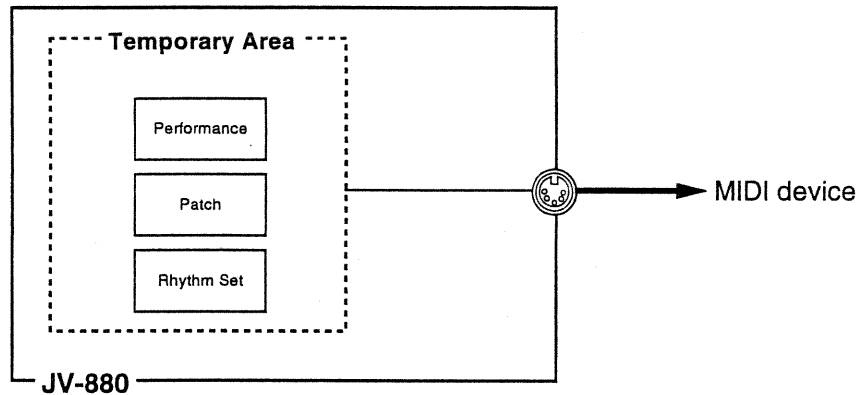

* See the Bulk Dump instructions for information on connections.

```
Util:Temporary dump  
PERFORMANCE [ENTER]
```

↑
Data to be transferred

- ① Press **UTILITY**. (The indicator lights.)
- ② Move the cursor to the top line of the display using **◀ CURSOR ▶**.
- ③ Select "Temporary dump" by rotating the **DATA** dial.

* During editing, parameters can be changed (regardless of the cursor position) by holding down the **PARAM SHIFT** button and pressing **+** or **-**.

- ④ Move the cursor to the bottom line of the display using **◀ CURSOR ▶**.
- ⑤ Select the data to be transferred by rotating the **DATA** dial.

PERFORMANCE	: Performance data is transmitted.
PATCH	: Patch data is transmitted.
RHYTHM	: Rhythm Set data is transmitted.
ALL	: Performance, Patch specified with each performance part and Rhythm Set data are all transmitted.

- ⑥ Execute the Temporary Dump function by pressing **ENTER**.

"Now Sending" is displayed when the transfer of data begins.

"Complete" is displayed when the transfer is finished. Return one of the these modes: Patch Play, Performance Play or Rhythm Edit.

LOAD PATCH

Load Patch Single

This operation allows you to copy the data of a single Patch from an optional PCM Card (SO-PCM1 series) or expansion board (SR-JV80 series) to one of three locations: temporary area, internal memory or Data Card.

```
Util:Load Patch single
PCM 001 → TEMP [ENTER]
```

Media to be copied Patch number to be copied Destination Patch number

- ① Press **UTILITY**. (The indicator lights.)
- ② Move the cursor to the top line of the display using **◀ CURSOR ▶**.
- ③ Select "Load patch single" by rotating the **DATA** dial.
- * During editing, parameters can be changed (regardless of the cursor position) by holding down the **PARAM SHIFT** button and pressing **+** or **-**.
- ④ Move the cursor to the field showing the media to be copied using **◀ CURSOR ▶**.
- ⑤ Select the media to be copied by rotating the **DATA** dial.
Media to be copied → PCM (PCM card)
EXP (expansion board)
- ⑥ Move the cursor to the Patch number to be copied using **◀ CURSOR ▶**.
- ⑦ Select the Patch to be copied by rotating the **DATA** dial.
- * The Patch to be copied can be checked at this time by playing your MIDI keyboard.
- * When the PCM card is not inserted, a " --- " display will be shown.
- ⑧ Move the cursor to the destination Patch number using **◀ CURSOR ▶**.
- ⑨ Select the destination Patch number by rotating the **DATA** dial.
Destination Patch → TEMP (temporary area)
I01 — 61
C01 — 64
- * Data Card cannot be selected if a Data Card has not been properly inserted into the DATA CARD slot.

- ⑩ Execute the Copy operation by pressing **ENTER**.

“**Complete**” is displayed when this operation is finished. Return one of the these modes: Patch Play, Performance Play or Rhythm Edit.

Load Patch Group

This operation allows you to copy data of a group of Patches from a PCM Card (or expansion board) to either internal memory or a Data Card.

There are a maximum 255 Patches in a PCM card and expansion board. These Patches are divided into four groups (of approximately 64 Patches each), and then copied.

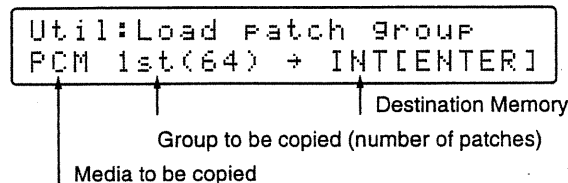

- ① Press **UTILITY**. (The indicator lights.)

- ② Move the cursor to the top line of the display using **◀ CURSOR ▶**.

- ③ Select “**Load patch group**” by rotating the **DATA** dial.

* During editing, parameters can be changed (regardless of the cursor position) by holding down the **PARAM SHIFT** button and pressing **+** or **-**.

- ④ Move the cursor to the field displaying the media to be copied using **◀ CURSOR ▶**.

* When the PCM card is not inserted, a “ --- ” display will be shown.

- ⑤ Select the media to be copied by rotating the **DATA** dial.

Media to be copied → PCM (PCM Card)
EXP (expansion board)

- ⑥ Move the cursor to the group to be copied using **◀ CURSOR ▶**.

- ⑦ Select the group to be copied by rotating the **DATA** dial.

The number of Patches is indicated in parentheses.

* Occasionally there will be a group that does not contain 64 Patches, as the number of Patches differs depending on the PCM Card or expansion board used.

⑧ Move the cursor to the memory destination field using **◀ CURSOR ▶**.

⑨ Select the memory destination by rotating the **DATA** dial.

Destination memory → INT (internal)

CRD (Data card)

* Data Card cannot be selected if a Data Card has not been properly inserted into the DATA CARD slot.

⑩ Execute the Copy operation by pressing **ENTER**.

* If you attempt to copy to internal memory with the memory protect function set to ON, the following message appears in the display:

```
Turn protect off once?  
[ENTER]
```

Pressing **ENTER** while this message is displayed temporarily turns off the memory protect function. Press **ENTER** again to execute the copy.

“Complete” is displayed when this operation is finished. Return one of the these modes: Patch Play, Performance Play or Rhythm Edit.

MEMORY PROTECT

This function prevents data stored in internal memory from being inadvertently erased or edited.

- * **Protect is automatically set to ON after the power is turned on.**
- * Be sure to set protect to OFF when transferring Patch and Tone data from the temporary area to internal memory.

```
Util:Memory Protect
ON
```

- ① Press **UTILITY**. (The indicator lights.)
- ② Move the cursor to the top line of the display using **◀CURSOR▶**.
- ③ Select **"Memory protect"** by rotating the **DATA** dial.
 - * During editing, parameters can be changed (regardless of the cursor position) by holding down the **PARAM SHIFT** button and pressing **+** or **-**.
- ④ Move the cursor to the bottom line of the display using **◀CURSOR▶**.
- ⑤ Select ON or OFF by rotating the **DATA** dial.
 - ON : Data cannot be written to memory.
 - OFF : Data can be written to memory.
- ⑥ Press **UTILITY** to return one of these modes: Patch Play, Performance Play or Rhythm Edit.

FACTORY PRESETS

The data in internal memory, the system area and temporary area, is restored to factory preset values.

* See P.10-19 for information about factory set values.

```
Util:Factory preset  
[ENTER]
```

- ① Press **UTILITY**. (The indicator lights.)
 - ② Move the cursor to the top line of the display using **◀ CURSOR ▶**.
 - ③ Select **"Factory preset"** by rotating the **DATA** dial.
- * During editing, parameters can be changed (regardless of the cursor position) by holding down the **PARAM SHIFT** button and pressing **+** or **-**.
- ④ Press **ENTER**.
The message **"Are you sure?"** appears in the display.
 - ⑤ Press **ENTER** to proceed.
Press **UTILITY** to cancel.

In either case, return one of these modes: Patch Play, Performance Play or Rhythm Edit.

Section

10

REFERENCE

■ ERROR MESSAGES (miscellaneous messages)

When operations have been incorrectly executed, or when some unexpected condition arises, an error message will be displayed. Check the displayed error message and implement the suggested solution (or solutions) in this section.

All the messages listed below are displayed for approximately 1.5 seconds, after which the LCD returns to the previous

Internal battery low

Problem: The internal backup battery has run down.

Solution: Consult your nearest Roland dealer.

Data card battery low

Problem: The DATA card backup battery has run down.

Solution: Transfer the data to another DATA card, then replace the battery in the original card.

Data card not ready

Problem: The DATA card has not been inserted into the DATA card slot or has not been inserted correctly.

Solution: Insert the DATA card correctly and securely.

PCM card not ready

Problem: The PCM card has not been inserted into the PCM card slot or has not been inserted correctly.

Solution: Insert the PCM card correctly and securely.

EXP board not ready

Problem: Without a properly installed expansion board, a Tone (or Patch) that uses waveforms from the expansion board cannot be called up.

Solution: Install the expansion board.

Improper data card

Problem: The DATA card inserted has not been properly formatted for use with the JV-880.

Solution: Initialize the DATA card from the Utility Mode (P.9-13).

Improper PCM card

Problem: A PCM card not designed for use with the JV-880 has been inserted.

Solution: Use only a proper PCM card.

Improper EXP board

Problem: A expansion board not designed for use with the JV-880 has been installed.

Solution: Use only a proper expansion board.

Data card write protect

Problem: The protect switch of the DATA card is on and data cannot be stored to the card.

Solution: Set the protect switch of the DATA card to off (P.9-22), then perform the operation again.

Data card write error

Problem: Data cannot be stored to the DATA card.

Solution: Check that the DATA card is inserted firmly into the slot.

It is also possible that the card itself is broken. Try storing the data again, this time with a different DATA card.

Internal RAM write error

Problem: Data cannot be saved to internal memory.

Solution: Consult your nearest Roland dealer.

Data card read error

Problem: The data of the DATA card has somehow been corrupted or destroyed.

Solution: Consult your nearest Roland dealer.

Internal RAM read error

Problem: The data of the internal memory has somehow been corrupted or destroyed.

Solution: Consult your nearest Roland dealer.

Wave number error

Problem: You attempted to select a Patch which uses waveforms of a PCM card or expansion board from the wrong card or board. As a result, there is no wave number at the selected number.

Solution: Select the Patch from the correct PCM card or expansion board.

MIDI:Communication error

Problem: Either an excessive amount of data was received at once, or the active sensing function was cut off.

Solution: Do not attempt to continuously transmit large amounts of data (like program change messages) that require processing on reception and, hence, take more time than usual. Also make sure that all MIDI cables are connected correctly.

MIDI:Buffer full

Problem: Excessive data has been transmitted at once by the bulk dump function.

Solution: Make adjustments to the exclusive data so that it is sent in several "packets" of smaller amounts.

MIDI:Check sum error

Problem: The checksum value of the bulk dump is incorrect.

Solution: Correct the exclusive data.

MIDI:Data card not ready

Problem: The DATA card has not been inserted into the DATA card slot or has not been inserted properly.

Solution: Insert the DATA card properly and securely.

MIDI:Improper data card

Problem: A DATA card not properly formatted for use with the JV-880 has been inserted and the data received by bulk dump cannot be written or stored.

Solution: After formatting the DATA card from the Utility mode (P.9-13), perform the operation again.

MIDI:Card write protect

Problem: The protect switch of the card is on and data received during execution of the bulk dump function could not be written or stored.

Solution: Set the protect switch of the card to off (P.9-22), then perform the operation again.

```
Util:Load patch single
PCM[---] + TEMP [ENTER]
```

Problem: When loading Patch data from the PCM card, the Patch number cannot be selected since the PCM card is not inserted.

Solution: Insert the PCM card.

```
Turn protect off once?
[ENTER]
```

Problem: The internal memory write-protect function is on and data cannot be stored.

Solution: Press **ENTER** to temporarily cancel the protect function. Then try the write operation again.

Other Messages

```
Complete
```

This is indicated when an operation is completed in the Utility Mode.

```
Turn protect off once?
Cancel
```

The write operation to internal memory is aborted.

```
Util:Temporary dump
Now Sending.....Cancel
```

```
Util:Temporary dump
Now Sending.....Cancel
```

```
Util:Temporary dump
Now Sending.....Cancel
```

```
Util:Temporary dump
Now Sending.....Cancel
```

The temporary dump operation is aborted.

```
Util:Factory preset
Cancel
```

The operation of restoring the factory settings is aborted.

```
Util:Bulk dump
Now Sending.....Cancel
```

The bulk dump operation is aborted.

■ TROUBLESHOOTING

Check through the following situations and conditions when your JV-880 fails to operate properly.

■ No sound

- Check that the JV-880, amplifier and mixer are all turned on.
- Check that all devices are connected correctly and securely.
- Check that the connecting cables are not defective.
- Check whether the sound is output through a connected set of headphones. If you can hear the sound normally through the headphones, the connected device or cables are probably the cause of the problem.
- Check that the volume of the amplifier, mixer or external MIDI sound source are set to suitable levels.
- Check that the volume of JV-880 is set to a suitable level. Any of the following settings may apply:
 - The position of the **VOLUME** knob
 - The Part level value (Part parameter: P.7-10)
 - Patch level value (Patch Common parameter: P.6-8)
 - TVA level value (Tone parameter: P.6-43; Rhythm Tone parameter: P.8-18)
 - The value of the volume data received via MIDI IN
- Check that the MIDI receive switch (P.7-15) of the Part parameter (Performance) is on.
- Check that the Tone switch for the Patch is on.
- Check that the MIDI channel has been set properly. Any of the following settings may apply:
 - The value of the Patch receiving channel (System Common parameter: P.5-5)
 - The value of the receiving channel (Part parameter: P.7-12)
- Sound may not be produced if: 1) the cutoff is set to 0 and the TVF filter type for the Tone of a Patch or a Rhythm Tone is set to LPF, or 2) the cutoff is set to 127 and the filter type is set to HPF. Any of the following settings may apply:
 - (Tone parameters)
 - TVF cutoff value (P.6-35)
 - TVF envelope depth value (P.6-38)
 - The velocity sensitivity value and the key follow setting of the TVF envelope (P.6-40, 6-41)
 - The level setting of TVF envelope (P.6-42)
 - The depth setting when the modulation/aftertouch/expression control parameter is set to cutoff (Tone parameter: P.6-18)
- Check that the TVA level of the Patch Tone or Rhythm Tone is set to 0. Any of the following settings may apply:
 - (Tone parameters)
 - Dry level value (P.6-52)
 - TVA level value (P.6-43)
 - The velocity sensitivity value and the time key follow setting of the TVA envelope (P.6-48, 6-49)
 - The level setting of TVA envelope (P.6-50)
 - TVA delay time value (P.6-47)
 - The depth setting when the modulation/aftertouch/expression control parameter is set to level (Tone parameter: P.6-18)
- The sound range may be limited depending on the wave selected. Check the following parameter for the various sections:
 - Coarse tune value (Part: P.7-11; Tone: P.6-27; Rhythm Tone parameter: P.8-9)
- Check that the JV-880 is not in the ROM play mode. The internal sounds of the JV-880 will not sound from received MIDI IN performance data when the instrument is in the ROM play mode.
- When the output mode is 4 OUT and the output select parameter is set to SUB OUTPUTS:
 - The sound output through the SUB OUTPUTS cannot be heard over the headphones.
 - The sound is output through the MAIN OUTPUTS when the connecting cable is not connected to the SUB OUTPUT.

■ Volume cannot be controlled

- Check that the receiving switch for the volume is not off.
Check the following parameter for the various sections:
 - Setting of the volume receiving switch (System Common: P.5-8; Part: P.7-14; Tone parameters: P.6-16)

■ Dynamic changes in the sound do not respond correctly or as you expect them to.

- Check the following velocity sensitivity settings:
 - The value of TVA velocity curve/velocity (Tone parameter: P.6-44, 6-45)
- Check the velocity curve setting of the connected keyboard.

■ The sound is distorted

- Check that the levels of the connected amplifier and mixer and the master volume of the JV-880 are set properly.
- When the Part parameter level (P.7-10) is set too high, the sound sometimes may be distorted.
- When the TVA level (P.6-43, 8-18) or the resonance (P.6-36, 8-14) value set for a Tone/Rhythm Tone parameter is set too high, the sound sometimes may be distorted.

■ The pitch is wrong or does not change

- Check that the tune settings are correct:
 - Master tune value (System Common parameter: P.5-4)
 - Coarse tune/fine tune values (Part parameter: P.7-11)
 - Coarse tune/fine tune/random pitch values (Tone parameter: P.6-27, 6-28)
 - Coarse tune/fine tune/random pitch values (Rhythm Tone parameter: P.8-9)
 - Pitch keyfollow value (Tone parameter: P.6-29)
 - Pitch envelope value (Tone: P.6-31—33; Rhythm tone parameter: P.8-11)
 - Tuning value of external MIDI sound source
- Check that the pitch bender has not been moved.
 - Check the pitch bend value received via MIDI IN.
- Check the setting of the pitch bend in the following parameter:
 - Bender range value (Patch Common: P.6-14; Rhythm Tone parameter: P.8-6)
- Check that the pitch bend receiving switch (P.5-9) of the System Common parameters is on.
- Check that the effects and LFO are correctly set. Any of the following settings may apply:
 - Chorus value (Performance: P.7-7; Patch Common parameter: P.6-9, 10)
 - Analog feel depth value (Patch Common parameter: P.6-13)
 - (Tone parameters)
Switch/depth value of FXM (P.6-27)
 - LFO pitch depth value (P.6-24)
 - The depth setting when the modulation/aftertouch/expression control parameter is set to pitch LFO (Tone parameter: P.6-18)
- It may happen that the sounding pitch range is limited, or that a Tone doesn't deviate from a certain pitch range, or that the tuning sounds off, depending on the selected wave.
- Check the scale tune setting (P.5-10)

■ The controllers do not work

- Check the receiving switch of the controller. Any of the following settings may apply:
 - The setting of each MIDI data receiving switch (System Common parameter: P.5-7—9)
 - The settings of the volume receiving switch, Hold — 1 receiving switch and the program change receiving switch (Part parameter: P.7-14)
- Check the modulation/aftertouch/expression controls in the Tone parameters. The effect cannot be applied when the parameters are set to off or the depth is set to 0.
- JV-880 receives only channel aftertouch. The effect is not applied even when the polyphonic aftertouch is transmitted from the connected keyboard.

■ The sound program does not change

- Check that the program change receiving switch is on in the following parameter:
 - The setting of the program change receiving switch (System Common: P.5-7; Part parameter: P.7-14)
- Check that the MIDI channel settings are correct. Any of the following settings may apply:
 - (System Common parameter)
Control channel value (P.5-6)
Patch receiving channel value (P.5-5)
 - Part receiving channel value (Part parameter: P.7-12)
- Check that the program change is received after the bank select message has been received.
- Check that the Edit mode has not been selected:
 - Changing Performances or receiving program changes is not possible in the Performance Edit mode.
 - Changing Patches or receiving program changes is not possible in the Patch Edit mode.
 - Changing Rhythms or receiving program changes is not possible in the Rhythm Edit mode.

■ The effects do not work

- Check that the effects are correctly set. Any of the following settings may apply:
 - (System Common parameters)
Chorus/reverb switch setting (P.5-5)
Setting of the output mode (P.5-4)
 - Chorus/reverb setting (Patch: P.6-9—12; Performance Common parameter: P.7-6—9)

■ Portamento does not work

- Check that the Portamento is set correctly.
 - Portamento switch setting (Patch Common parameter: P.6-14)
 - When the portamento mode of the Patch Common parameters is set to legato, portamento is not applied unless you actually play the keyboard with legato technique; that is, holding down one key and not releasing it until after the next key has been pressed.
- Portamento is not applied to Rhythm Tones.

■ The sound is muted or cut off

- The maximum Polyphony of the JV-880 is twenty-eight. Decrease the number of Tones you are using or adjust the voice reserve setting (P.7-12) of the Part parameters.
- When the key assign (P.6-13) of the Patch Common parameters is set to solo, only a single Tone sounds even when several key are played.
- If the mute group (P.8-7) of a Rhythm Tone parameter is on, the sound which has been sounding is muted when another sound from the same group is played.

■ The Tone cannot be edited as intended

- Check that the sounding Tone and the Tone number to be edited match.
- The sound doesn't change when editing a Tone whose Tone switch has been turned off.

■ The Rhythm Tone cannot be edited as intended

- Check that the note number to be edited and the sounding note number match.
- The sound doesn't change when editing a Tone whose Tone switch has been turned off.

■ Card cannot be used

- Cards which have not been formatted for use with the JV-880 cannot be used. Format the DATA card from the Utility mode (P.9-13).
- PCM cards which have not been designed for use with the JV-880 cannot be used.

■ Data cannot be transferred by MIDI exclusive messages

- Check that the exclusive receiving switch (P.5-9) of the System Common parameters is on.
- Check that the unit number (P.5-6) of the System Common parameters is correct. Match it to the unit number of the connected device.
- The temporary data will not be changed, even though the data is transferred by exclusive messages to internal memory or DATA card. Transfer to the temporary area or switch the Performance/Patch by program change messages after transferring the data by exclusive messages.
- Check that the DATA card has been inserted properly. Data cannot be stored on the DATA card if it has not been properly inserted.
- Check that the DATA card has been formatted for use with the JV-880. Data cannot be stored on the DATA card if it has not been properly formatted for the JV-880. Format the DATA card from the Utility mode (P.9-13).
- Check that the protect switch of the DATA card is on. When transferring data to the DATA card, the data cannot be written unless the protect switch is set to off.

PARAMETERS LIST

System Common Parameter

Parameter Name		Value	Page	
Master tune		427.4Hz—452.6Hz	5-4	
Output mode		2OUT, 4OUT		
Chorus switch		OFF, ON	5-5	
Reverb switch		OFF, ON		
MIDI	Rx channel (Patch Mode)	1—16	5-6	
	Control channel (Performance Mode)	1—16, OFF		
	Unit number	17—32		
	Rx switch	Program change	OFF, ON	5-7
		Program bank sel	OFF, ON	
		Control change	OFF, ON	
		Volume	OFF, ON	5-8
		Modulation	OFF, ON	
		Pitch bend	OFF, ON	5-9
		Aftertouch	OFF, ON	
Exclusive	OFF, ON			
Scale tune switch		OFF, ON	5-10	
Scale tune (Patch mode)	C	-64—0—+63 (cent)		
	C#	-64—0—+63		
	D	-64—0—+63		
	D#	-64—0—+63		
	E	-64—0—+63		
	F	-64—0—+63		
	F#	-64—0—+63		
	G	-64—0—+63		
	G#	-64—0—+63		
	A	-64—0—+63		
	A#	-64—0—+63		
	B	-64—0—+63		
	Part 1-8	Scale Tune (Performance mode)		C
C#				-64—0—+63
D				-64—0—+63
D#				-64—0—+63
E			-64—0—+63	
F			-64—0—+63	
F#			-64—0—+63	
G			-64—0—+63	
G#			-64—0—+63	
A			-64—0—+63	
A#	-64—0—+63			
B	-64—0—+63			
Rhythm edit key		INT & MIDI, INT	5-12	
Display contrast		0—10		
Power up		DEFAULT, LAST SET		
Preview	Note (1)	C -1—G9, OFF	5-13	
	Note (2)	C -1—G9, OFF		
	Note (3)	C -1—G9, OFF		
	Note (4)	C -1—G9, OFF		
	Velocity (1)	1—127		
	Velocity (2)	1—127		
	Velocity (3)	1—127		
	Velocity (4)	1—127		

● Patch Parameter

Parameter Name		Value	Page	
Common	Patch name	(Space) A-Z a-z 1-0 + - * / # ! , .	6-7	
	Level	0-127	6-8	
	Pan	L64-0-63R		
	Velocity switch	OFF, ON		
	Chorus	type	CHORUS1, CHORUS2, CHORUS3	6-9
		level	0-127	
		rate	0-127	
		depth	0-127	
		feedback	0-127	
	Reverb	output	MIX, REVERB	6-10
		type	ROOM1-2, STAGE1-2, HALL1-2, DELAY, PAN-DLY	
		level	0-127	
		time	0-127	
	Analog feel depth	feedback	0-127	6-11
		level	0-127	
		time	0-127	
	Key assign	POLY, SOLO	6-12	
	Legato	OFF, ON		
	Bend Range	U (Up)	0-+12	6-13
		D (Down)	-48-0	
Porta (Portamento)	switch	OFF, ON	6-14	
	mode	LEGATO, NORMAL		
	type	TIME, RATE		
	time	0-127		
Tone 1-4	Tone switch (※)	OFF, ON	6-16	
	Volume switch	OFF, ON		
	Hold - 1 switch	OFF, ON		
	Velo range	(Upper)	0-127	6-17
		(Lower)	0-127	
	Mod1 (Modulation 1)	(Depth)	-63-0-+63	6-18
		(Destination)	OFF, PITCH, CUTOFF, RESONANCE, LEVEL, PITCH LFO1, PITCH LFO2, TVF LFO1, TVF LFO2, TVA LFO1, TVA LFO2, LFO1 RATE, LFO2 RATE	
	Mod2	(Depth)	-63-0-+63	
		(Destination)	OFF, PITCH, CUTOFF, RESONANCE, LEVEL, PITCH LFO1, PITCH LFO2, TVF LFO1, TVF LFO2, TVA LFO1, TVA LFO2, LFO1 RATE, LFO2 RATE	
	Mod3	(Depth)	-63-0-+63	
		(Destination)	OFF, PITCH, CUTOFF, RESONANCE, LEVEL, PITCH LFO1, PITCH LFO2, TVF LFO1, TVF LFO2, TVA LFO1, TVA LFO2, LFO1 RATE, LFO2 RATE	
	Mod4	(Depth)	-63-0-+63	
		(Destination)	OFF, PITCH, CUTOFF, RESONANCE, LEVEL, PITCH LFO1, PITCH LFO2, TVF LFO1, TVF LFO2, TVA LFO1, TVA LFO2, LFO1 RATE, LFO2 RATE	
	After1 (Aftertouch 1)	(Depth)	-63-0-+63	
		(Destination)	OFF, PITCH, CUTOFF, RESONANCE, LEVEL, PITCH LFO1, PITCH LFO2, TVF LFO1, TVF LFO2, TVA LFO1, TVA LFO2, LFO1 RATE, LFO2 RATE	
	After2	(Depth)	-63-0-+63	
		(Destination)	OFF, PITCH, CUTOFF, RESONANCE, LEVEL, PITCH LFO1, PITCH LFO2, TVF LFO1, TVF LFO2, TVA LFO1, TVA LFO2, LFO1 RATE, LFO2 RATE	
	After3	(Depth)	-63-0-+63	
		(Destination)	OFF, PITCH, CUTOFF, RESONANCE, LEVEL, PITCH LFO1, PITCH LFO2, TVF LFO1, TVF LFO2, TVA LFO1, TVA LFO2, LFO1 RATE, LFO2 RATE	
	After4	(Depth)	-63-0-+63	
(Destination)		OFF, PITCH, CUTOFF, RESONANCE, LEVEL, PITCH LFO1, PITCH LFO2, TVF LFO1, TVF LFO2, TVA LFO1, TVA LFO2, LFO1 RATE, LFO2 RATE		

Exp1 (Expression 1)	(Depth)	- 63-0-+63	6-18	
	(Destination)	OFF, PITCH, CUTOFF, RESONANCE, LEVEL, PITCH LFO1, PITCH LFO2, TVF LFO1, TVF LFO2, TVA LFO1, TVA LFO2, LFO1 RATE, LFO2 RATE		
Exp2	(Depth)	- 63-0-+63		
	(Destination)	OFF, PITCH, CUTOFF, RESONANCE, LEVEL, PITCH LFO1, PITCH LFO2, TVF LFO1, TVF LFO2, TVA LFO1, TVA LFO2, LFO1 RATE, LFO2 RATE		
Exp3	(Depth)	- 63-0-+63		
	(Destination)	OFF, PITCH, CUTOFF, RESONANCE, LEVEL, PITCH LFO1, PITCH LFO2, TVF LFO1, TVF LFO2, TVA LFO1, TVA LFO2, LFO1 RATE, LFO2 RATE		
Exp4	(Depth)	- 63-0-+63		
	(Destination)	OFF, PITCH, CUTOFF, RESONANCE, LEVEL, PITCH LFO1, PITCH LFO2, TVF LFO1, TVF LFO2, TVA LFO1, TVA LFO2, LFO1 RATE, LFO2 RATE		
LFO1	waveform	TRI, SIN, SAW, SQR, RND1, RND2		6-20
	synchro	OFF, ON		6-21
	rate	0-127		
	offset	-100, -50, 0, +50, +100		6-22
	delay	0-127, KEY - OFF		
	fade	IN, OUT	6-23	
	fade time	0-127		
	pitch depth	- 63-0-+63		
	TVF depth	- 63-0-+63	6-24	
TVA depth	- 63-0-+63			
LFO2	waveform	TRI, SIN, SAW, SQR, RND1, RND2	6-20	
	synchro	OFF, ON	6-21	
	rate	0-127		
	offset	-100, -50, 0, +50, +100	6-22	
	delay	0-127, KEY - OFF		
	fade	IN, OUT	6-23	
	fade time	0-127		
	pitch depth	- 63-0-+63		
	TVF depth	- 63-0-+63	6-24	
TVA depth	- 63-0-+63			
WG	wave	group	INT, EXP, PCM	6-26
		(Number)	01-256	
	FXM	switch	OFF, ON	6-27
		depth	01-16	
	pitch	coarse	- 48-0-+48	
		fine	- 50-0-+50	
	random pitch	0, 5, 10, 20, 30, 40, 50, 70, 100, 200, 300, 400, 500, 600, 800, 1200	6-28	
	pitch KF (Pitch Keyfollow)	-100, -70, -50, -30, -10, 0, +10, +20, +30, +40, +50, +70, +100, +120, +150, +200	6-29	
	ENV depth	- 12-0-+12		
pitch velocity	- 63-0-+63	6-30		
P - ENV (Pitch ENV)	T1 velocity	-100, -70, -50, -40, -30, -20, -10, 0, +10, +20, +30, +40, +50, +70, +100	6-31	
	T4 velocity	-100, -70, -50, -40, -30, -20, -10, 0, +10, +20, +30, +40, +50, +70, +100	6-32	
	time KF (Time Keyfollow)	-100, -70, -50, -40, -30, -20, -10, 0, +10, +20, +30, +40, +50, +70, +100		
	T1 (Time 1)	0-127		
	L1 (Level 1)	- 63-0-+63		
	T2 (Time 2)	0-127		
	L2 (Level 2)	- 63-0-+63	6-33	
	T3 (Time 3)	0-127		
	L3 (Level 3)	- 63-0-+63		
	T4 (Time 4)	0-127		
L4 (Level 4)	- 63-0-+63			

TVF	type	OFF, LPF, HPF	6-34
	cutoff freq (Cutoff frequency)	0—127	6-35
	resonance	0—127	6-36
	reso mode (Resonance Mode)	SOFT, HARD	
	keyfollow	-100, -70, -50, -30, -10, 0, +10, +20, +30, +40, +50, +70, +100, +120, +150, +200	6-37
	ENV depth	-63—0—+63	6-38
F — ENV (TVF ENV)	velo curve (Velocity Curve)	1—7	6-39
	velocity	-63—0—+63	6-40
	T1 velocity	-100, -70, -50, -40, -30, -20, -10, 0, +10, +20, +30, +40, +50, +70, +100	
	T4 velocity	-100, -70, -50, -40, -30, -20, -10, 0, +10, +20, +30, +40, +50, +70, +100	
	time KF (Time Keyfollow)	-100, -70, -50, -40, -30, -20, -10, 0, +10, +20, +30, +40, +50, +70, +100	6-41
	T1 (Time 1)	0—127	6-42
	L1 (Level 1)	0—127	
	T2 (Time 2)	0—127	
	L2 (Level 2)	0—127	
	T3 (Time 3)	0—127	
	L3 (Level 3)	0—127	
	T4 (Time 4)	0—127	
	L4 (Level 4)	0—127	
	TVA	level	0—127
keyfollow		-100, -70, -50, -40, -30, -20, -10, 0, +10, +20, +30, +40, +50, +70, +100	
velo curve (Velocity Curve)		1—7	6-44
velocity		-63—0—+63	6-45
pan		L64—0—63R, RND	6-46
panning KF		-100, -70, -50, -40, -30, -20, -10, 0, +10, +20, +30, +40, +50, +70, +100	
delay mode		NORMAL, HOLD, PLAYMATE	
delay time	0—127, KEY — OFF	6-47	
A — ENV (TVA ENV)	T1 velocity	-100, -70, -50, -40, -30, -20, -10, 0, +10, +20, +30, +40, +50, +70, +100	6-48
	T4 velocity	-100, -70, -50, -40, -30, -20, -10, 0, +10, +20, +30, +40, +50, +70, +100	6-49
	time KF (Time Keyfollow)	-100, -70, -50, -40, -30, -20, -10, 0, +10, +20, +30, +40, +50, +70, +100	
	T1 (Time 1)	0—127	6-50
	L1 (Level 1)	0—127	
	T2 (Time 2)	0—127	
	L2 (Level 2)	0—127	
	T3 (Time 3)	0—127	
L3 (Level 3)	0—127		
T4 (Time 4)	0—127		
Output	dry level	0—127	6-52
	chorus send	0—127	
	reverb send	0—127	
	select	MAIN, SUB	6-53

The parameters marked with a “※” are not displayed in the LCD as a parameter. They are set by the **TONE SWITCH** operation.

● Performance Parameter

Parameter Name		Value	Page	
Common	Perf name (Performance Name)	(Space) A—Z a—z 1—0 + - * / # ! , .	7-6	
	Chorus	type	CHORUS1, CHORUS2, CHORUS3	7-7
		level	0—127	
		rate	0—127	
		depth	0—127	
		feedback	0—127	
		output	MIX, REVERB	
	Reverb	type	ROOM1—2, STAGE1—2, HALL1—2, DELAY, PAN—DLY	7-8
		level	0—127	7-9
		time	0—127	
		feedback	0—127	
Part 1~8	Patch# (Patch Select)	(Part 1—8) A01—C64 (Part 8) PRA, PRB, INT, CRD	7-10	
	Level	0—127	7-11	
	Pan	L64—0—63R		
	Tune (Coarse Tune)	- 48—0—+ 48		
	Fine (Fine Tune)	- 50—0—+ 50		
	Rx ch	1—16		
	Reserve (Voice Reserve)	0—28		
	Chorus (Chorus Switch)	OFF, ON	7-13	
	Reverb (Reverb Switch)	OFF, ON		
	Rx P.Chg (Rx Program change)	OFF, ON	7-14	
	Rx vol (Rx Volume)	OFF, ON		
	Rx hold (Rx Hold — 1)	OFF, ON		
	Rx sw	OFF, ON		
	Output (Output Select)	MN, SB, PAT	7-15	

Rhythm Tone Parameter

Parameter Name		Value	Page	
Bender range		0—12	8-6	
ENV mode		NO — SUSTAIN, SUSTAIN		
Mute group		OFF, 1—31	8-7	
Tone switch		OFF, ON		
WG	wave	group	INT, EXP, PCM	8-8
		(Number)	01—256	
	pitch	coarse	C -1—G9	8-9
		fine	-50—0—+50	
	random pitch	0, 5, 10, 20, 30, 40, 50, 70, 100, 200, 300, 400, 500, 600, 800, 1200		
	ENV depth	-12—0—+12		
	pitch velocity	-63—0—+63		
pitch time velo (Pitch Time Velocity)	-100, -70, -50, -40, -30, -20, -10, 0, +10, +20, +30, +40, +50, +70, +100			
P — ENV (Pitch ENV)	T1 (Time 1)	0—127	8-11	
	L1 (Level 1)	-63—0—+63		
	T2 (Time 2)	0—127		
	L2 (Level 2)	-63—0—+63		
	T3 (Time 3)	0—127		
	L3 (Level 3)	-63—0—+63		
	T4 (Time 4)	0—127		
	L4 (Level 4)	-63—0—+63		
TVF	type	OFF, LPF, HPF	8-12	
	cutoff freq (Cutoff Frequency)	0—127	8-13	
	resonance	0—127	8-14	
	reso mode (Resonance Mode)	SOFT, HARD		
	ENV depth	-63—0—+63	8-15	
	velocity	-63—0—+63	8-16	
F — ENV (TVF ENV)	T1 (Time 1)	0—127	8-17	
	L1 (Level 1)	0—127		
	T2 (Time 2)	0—127		
	L2 (Level 2)	0—127		
	T3 (Time 3)	0—127		
	L3 (Level 3)	0—127		
	T4 (Time 4)	0—127		
	L4 (Level 4)	0—127		
TVA	level	0—127	8-18	
	velocity	-63—+63	8-19	
	time velocity	-100, -70, -50, -40, -30, -20, -10, 0, +10, +20, +30, +40, +50, +70, +100		
	pan	L64—63R		
A — ENV (TVA ENV)	T1 (Time 1)	0—127	8-20	
	L1 (Level 1)	0—127		
	T2 (Time 2)	0—127		
	L2 (Level 2)	0—127		
	T3 (Time 3)	0—127		
	L3 (Level 3)	0—127		
	T4 (Time 4)	0—127		
Output	dry level	0—127	8-21	
	chorus send	0—127		
	reverb send	0—127	8-22	
	select	MAIN, SUB		

INITIALIZE DATA

● Patch

Patch name	INITIAL DATA
------------	--------------

Common					
Level	127	Chorus	type	CHORUS 1	
Pan	0		level	60	
Velocity switch	OFF		rate	60	
Analog feel depth	0		depth	80	
Key assign	POLY		feedback	0	
Legato	OFF		output	MIX	
Bend range Up	+2		Reverb	type	STAGE2
Bend range Down	-2	level		100	
Portamento	switch	OFF		time	60
	mode	NORMAL		feedback	0
	type	TIME			
	time	50			

Tone																	
		TONE 1				TONE 2				TONE 3				TONE 4			
TONE SWITCH		ON				OFF				OFF				OFF			
Volume switch		ON				ON				ON				ON			
Hold - 1 switch		ON				ON				ON				ON			
Velocity range (Low - UP)		0 - 127				0 - 127				0 - 127				0 - 127			
Modulation	destination	OFF	OFF	OFF	OFF	OFF	OFF	OFF	OFF	OFF	OFF	OFF	OFF	OFF	OFF	OFF	OFF
	depth	0	0	0	0	0	0	0	0	0	0	0	0	0	0	0	0
Aftertouch	destination	OFF	OFF	OFF	OFF	OFF	OFF	OFF	OFF	OFF	OFF	OFF	OFF	OFF	OFF	OFF	OFF
	depth	0	0	0	0	0	0	0	0	0	0	0	0	0	0	0	0
Expression	destination	OFF	OFF	OFF	OFF	OFF	OFF	OFF	OFF	OFF	OFF	OFF	OFF	OFF	OFF	OFF	OFF
	depth	0	0	0	0	0	0	0	0	0	0	0	0	0	0	0	0
LFO 1,2	waveform	TRIANGLE				TRIANGLE				TRIANGLE				TRIANGLE			
	synchro	ON				ON				ON				ON			
	rate	60				60				60				60			
	offset	0				0				0				0			
	delay	0				0				0				0			
	fade	IN				IN				IN				IN			
	fade time	0				0				0				0			
	pitch depth	0				0				0				0			
	TVF depth	0				0				0				0			
	TVA depth	0				0				0				0			

		TONE 1				TONE 2				TONE 3				TONE 4			
WG	wave group	INT				INT				INT				INT			
	wave number (Name)	1 (Ac Piano 1)				1 (Ac Piano 1)				1 (Ac Piano 1)				1 (Ac Piano 1)			
	FXM switch	OFF				OFF				OFF				OFF			
	FXM depth	1				1				1				1			
	pitch coarse	0				0				0				0			
	pitch fine	0				0				0				0			
	random pitch	0				0				0				0			
	pitch keyfollow	+100				+100				+100				+100			
	ENV depth	0				0				0				0			
	pitch velocity	0				0				0				0			
Pitch — ENV	T1 velocity	0				0				0				0			
	T4 velocity	0				0				0				0			
	time keyfollow	0				0				0				0			
	time 1—4	0	0	0	0	0	0	0	0	0	0	0	0	0	0	0	0
	level 1—4	0	0	0	0	0	0	0	0	0	0	0	0	0	0	0	0
TVF	type	LPF				LPF				LPF				LPF			
	cutoff frequency	127				127				127				127			
	resonance	0				0				0				0			
	resonance mode	SOFT				SOFT				SOFT				SOFT			
	keyfollow	0				0				0				0			
	ENV depth	0				0				0				0			
TVF — ENV	velocity curve	1				1				1				1			
	velocity	0				0				0				0			
	T1 velocity	0				0				0				0			
	T4 velocity	0				0				0				0			
	time keyfollow	0				0				0				0			
	time 1—4	0	0	0	0	0	0	0	0	0	0	0	0	0	0	0	0
	level 1—4	0	0	0	0	0	0	0	0	0	0	0	0	0	0	0	0
TVA	level	127				127				127				127			
	keyfollow	0				0				0				0			
	velocity curve	1				1				1				1			
	velocity	+32				+32				+32				+32			
	pan	0				0				0				0			
	panning keyfollow	0				0				0				0			
	delay mode	NORMAL				NORMAL				NORMAL				NORMAL			
	delay time	0				0				0				0			
TVA — ENV	T1 velocity	0				0				0				0			
	T4 velocity	0				0				0				0			
	time keyfollow	0				0				0				0			
	time 1—4	0	0	0	50	0	0	0	50	0	0	0	50	0	0	0	50
	level 1—3	127	127	127	/	127	127	127	/	127	127	127	/	127	127	127	/
Output	dri level	127				127				127				127			
	chorus send	127				127				127				127			
	reverb send	127				127				127				127			
	output select	MAIN				MAIN				MAIN				MAIN			

Performance

Performance name	INITIAL DATA
-------------------------	---------------------

Common					
Chorus	type	CHORUS1	Reverb	type	STAGE1
	level	60		level	100
	rate	60		time	80
	depth	80		feedback	0
	feedback	0			
	output	MIX			

Part								
	Part 1	Part 2	Part 3	Part 4	Part 5	Part 6	Part 7	Part 8 (R)
Patch select	I-01	I-02	I-03	I-04	I-05	I-06	I-07	INT
Level	127	127	127	127	127	127	127	127
Pan	0	0	0	0	0	0	0	0
Tune	0	0	0	0	0	0	0	0
Fine tune	0	0	0	0	0	0	0	0
Rx channel	1	2	3	4	5	6	7	10
Voice reserve	0	0	0	0	0	0	0	0
Chorus switch	ON	ON	ON	ON	ON	ON	ON	ON
Reverb switch	ON	ON	ON	ON	ON	ON	ON	ON
Rx program change	ON	ON	ON	ON	ON	ON	ON	ON
Rx volume	ON	ON	ON	ON	ON	ON	ON	ON
Rx Hold - 1	ON	ON	ON	ON	ON	ON	ON	ON
Rx switch	ON	ON	ON	ON	ON	ON	ON	ON
Output select	MN	MN	MN	MN	MN	MN	MN	MN

● Rhythm Tone

Bender range		ON			
ENV mode		NO — SUSTAIN			
Mute group		OFF			
Tone switch		ON			
WG	wave group	INT			
	wave number (Name)	84 (808 SNR 1)			
	pitch coarse	C4			
	pitch fine	0			
	random pitch	0			
	ENV depth	0			
	pitch velocity	0			
	pitch time velocity	0			
P-ENV	time 1—4	0	0	0	0
	level 1—4	0	0	0	0
TVF	type	LPF			
	cutoff frequency	127			
	resonance	0			
	resonance mode	SOFT			
	ENV depth	0			
	velocity	0			
	time velocity	0			
F-ENV	time 1—4	0	0	0	0
	level 1—4	0	0	0	0
TVA	level	127			
	velocity	+32			
	time velocity	0			
	pan	0			
A-ENV	time 1—4	0	0	127	50
	level 1—3	127	127	127	
Output	dry level	127			
	chorus send	127			
	reverb send	127			
	output select	MAIN			

WAVEFORMS LIST

No.	Wave Name
1	Ac Piano 1
2	SA Rhodes 1
3	SA Rhodes 2
4	E.Piano 1
5	E.Piano 2
6	Clav 1
7	Organ 1
8	Jazz Organ
9	Pipe Organ
10	Nylon GTR
11	6STR GTR
12	GTR HARM
13	Mute GTR 1
14	Pop Strat
15	Stratus
16	SYN GTR
17	Harp 1
18	SYN Bass
19	Pick Bass
20	E.Bass
21	Fretless 1
22	Upright BS
23	Slap Bass 1
24	Slap & Pop
25	Slap Bass 2
26	Slap Bass 3
27	Flute 1
28	Trumpet 1
29	Trombone 1
30	Harmon Mute1
31	Alto Sax 1
32	Tenor Sax 1
33	French 1
34	Blow Pipe
35	Bottle
36	Trumpet SECT
37	ST.Strings-R
38	ST.Strings-L
39	Mono Strings
40	Pizz

No.	Wave Name
41	SYN VOX 1
42	SYN VOX 2
43	Male Ooh
44	ORG VOX
45	VOX Noise
46	Soft Pad
47	JP Strings
48	Pop Voice
49	Fine Wine
50	Fantasyth
51	Fanta Bell
52	ORG Bell
53	Agogo
54	Bottle Hit
55	Vibes
56	Marimba wave
57	Log Drum
58	DIGI Bell 1
59	DIGI Chime
60	Steel Drums
61	MMM VOX
62	Spark VOX
63	Wave Scan
64	Wire String
65	Lead Wave
66	Synth Saw 1
67	Synth Saw 2
68	Synth Saw 3
69	Synth Square
70	Synth Pulse1
71	Synth Pulse2
72	Triangle
73	Sine
74	ORG Click
75	White Noise
76	Wind Agogo
77	Metal Wind
78	Feedbackwave
79	Anklungs
80	Wind Chimes

No.	Wave Name
81	Rattles
82	Tin Wave
83	Spectrum 1
84	808 SNR 1
85	90's Snare
86	Piccolo SN
87	LA Snare
88	Whack Snare
89	Rim Shot
90	Bright Kick
91	Verb Kick
92	Round Kick
93	808 Kick
94	Closed HAT 1
95	Closed HAT 2
96	Open HAT 1
97	Crash 1
98	Ride 1
99	Ride Bell 1
100	Power Tom Hi
101	Power Tom Lo
102	Cross Stick1
103	808 Claps
104	Cowbell 1
105	Tambourine
106	Timbale
107	CGA Mute Hi
108	CGA Mute Lo
109	CGA Slap
110	Conga Hi
111	Conga Lo
112	Maracas
113	Cabasa Cut
114	Cabasa Up
115	Cabasa Down
116	REV Steel DR
117	REV Tin Wave
118	REV SN 1
119	REV SN 2
120	REV SN 3

No.	Wave Name
121	REV SN 4
122	REV Kick 1
123	REV Cup
124	REV Tom
125	REV Cow Bell
126	REV TAMB
127	REV Conga
128	REV Maracas
129	REV Crash 1

FACTORY SETTINGS

Patch

Preset A					
CC0 : 81					
No.	Name	PG#	No.	Name	PG#
A01	A.Piano 1	1	A33	Nylon Gtr 1	33
A02	A.Piano 2	2	A34	Flanged Nyln	34
A03	Mellow Piano	3	A35	Steel Guitar	35
A04	Pop Piano 1	4	A36	PickedGuitar	36
A05	Pop Piano 2	5	A37	12 strings	37
A06	Pop Piano 3	6	A38	Velo Harmnix	38
A07	MIDled Grand	7	A39	Nylon+Steel	39
A08	Country Bar	8	A40	SwitchOnMute	40
A09	Glist EPiano	9	A41	JC Strat	41
A10	MIDI EPiano	10	A42	Stratus	42
A11	SA Rhodes	11	A43	Syn Strat	43
A12	Dig Rhodes 1	12	A44	Pop Strat	44
A13	Dig Rhodes 2	13	A45	Clean Strat	45
A14	Stiky Rhodes	14	A46	Funk Gtr	46
A15	Guitr Rhodes	15	A47	Syn Guitar	47
A16	Nylon Rhodes	16	A48	Overdrive	48
A17	Clav 1	17	A49	Fretless	49
A18	Clav 2	18	A50	St Fretless	50
A19	Marimba	19	A51	Woody Bass 1	51
A20	Marimba SW	20	A52	Woody Bass 2	52
A21	Warm Vibe	21	A53	Analog Bs 1	53
A22	Vibe	22	A54	House Bass	54
A23	Wave Bells	23	A55	Hip Bass	55
A24	Vibrobell	24	A56	RockOut Bass	56
A25	Pipe Organ 1	25	A57	Slap Bass	57
A26	Pipe Organ 2	26	A58	Thumpin Bass	58
A27	Pipe Organ 3	27	A59	Pick Bass	59
A28	E.Organ 1	28	A60	Wonder Bass	60
A29	E.Organ 2	29	A61	Yowza Bass	61
A30	Jazz Organ 1	30	A62	Rubber Bs 1	62
A31	Jazz Organ 2	31	A63	Rubber Bs 2	63
A32	Metal Organ	32	A64	Stereoww Bs	64

Preset B					
CC0 : 81					
No.	Name	PG#	No.	Name	PG#
B01	Pizzicato	65	B33	Brass Combo	97
B02	Real Pizz	66	B34	Stab Brass	98
B03	Harp	67	B35	Soft Brass	99
B04	SoarinString	68	B36	Horn Brass	100
B05	Warm Strings	69	B37	French Horn	101
B06	Marcato	70	B38	AltoLead Sax	102
B07	St Strings	71	B39	Alto Sax	103
B08	Orch Strings	72	B40	Tenor Sax 1	104
B09	Slow Strings	73	B41	Tenor Sax 2	105
B10	Velo Strings	74	B42	Sax Section	106
B11	BrightStrngs	75	B43	Sax Tp Tb	107
B12	TremoloStrng	76	B44	FlutePiccolo	108
B13	Orch Stab 1	77	B45	Flute mod	109
B14	Brite Stab	78	B46	Ocarina	110
B15	JP — 8 Strings	79	B47	OverblownPan	111
B16	String Synth	80	B48	Air Lead	112
B17	Wire Strings	81	B49	Steel Drum	113
B18	New Age Vox	82	B50	Log Drum	114
B19	Arasian Morn	83	B51	Box Lead	115
B20	Beauty Vox	84	B52	Soft Lead	116
B21	Vento Voxx	85	B53	Whistle	117
B22	Pvox Oooze	86	B54	Square Lead	118
B23	GlassVoices	87	B55	Touch Lead	119
B24	Space Ahh	88	B56	NightShade	120
B25	Trumpet	89	B57	Pizza Hutt	121
B26	Trombone	90	B58	EP+Exp Pad	122
B27	Harmon Mute1	91	B59	JP — 8 Pad	123
B28	Harmon Mute2	92	B60	Puff	124
B29	TeaJay Brass	93	B61	SpaciosSweep	125
B30	Brass Sect 1	94	B62	Big n Beefy	126
B31	Brass Sect 2	95	B63	RevCymBend	127
B32	Brass Swell	96	B64	Analog Seq	128

Internal

CC0 : 80

No.	Name	PG#	No.	Name	PG#
I01	JV Strings	1	I33	Mute TP mod	33
I02	BrightGuitar	2	I34	JV Heaven	34
I03	Von Greece	3	I35	Tria Bells	35
I04	Brass Sect.	4	I36	Analog Bs 2	36
I05	SA Rhodes !!	5	I37	THE STRINGS	37
I06	Pan Pipe	6	I38	Hammer Bell	38
I07	Slap !!!	7	I39	Fine Organ	39
I08	DooWah Diddy	8	I40	Stackoid	40
I09	A.Piano 3	9	I41	Huff N Stuff	41
I10	Turbo Sax	10	I42	Autumn Breez	42
I11	Orch Stab 2	11	I43	Toy Box	43
I12	Analog Pad 1	12	I44	Analog Horn	44
I13	Great Church	13	I45	Orch Stab 3	45
I14	Rubber Bs 3	14	I46	Reincarnate	46
I15	Analog Brass	15	I47	Wave Bells 2	47
I16	X/Y/Z	16	I48	Whistle Lead	48
I17	Lumber Jacow	17	I49	UTAKATA	49
I18	Nylon Gtr 2	18	I50	Analog Pad 2	50
I19	YASURAGI	19	I51	Dist Line	51
I20	House Hunter	20	I52	Super Vibe	52
I21	Mighty Pad	21	I53	Stratusphere	53
I22	SAW Lead	22	I54	Voiccy PiZZ	54
I23	Ice Hall	23	I55	Black Brass	55
I24	Organarimba	24	I56	Glass Pad	56
I25	Spr Trumpet	25	I57	Reso Pad	57
I26	Mix On Mute	26	I58	Hardy Winery	58
I27	P - P - P - Puff	27	I59	Steel Pizz	59
I28	Fantasia JV	28	I60	WhistlinAtom	60
I29	Glasswaves	29	I61	ChuChu Vox	61
I30	El.Piano	30	I62	Arctic Winds	62
I31	Jazz Organ 3	31	I63	DistanceCall	63
I32	5 - Strng Bass	32	I64	REVERCE MAD	64

● Performance(Preset A)

A — 01 Jazz Split

CC0 : 81
PG# : 1 (17,33,49)

1	A01 : A.Piano 1
2	A49 : Fretless
3	A39 : Nylon+Steel
4	B40 : Tenor Sax 1
5	A30 : Jazz Organ 1
6	B43 : Sax Tp Tb
7	A21 : Warm Vibe
8	PRA : PR — A RHYTHM

A — 05 OLD Bar

CC0 : 81
PG# : 5 (21,37,53)

1	A03 : Mellow Piano
2	A52 : Woody Bass 2
3	B28 : Harmon Mute2
4	B39 : Alto Sax
5	B28 : Harmon Mute2
6	A33 : Nylon Gtr 1
7	A03 : Mellow Piano
8	PRB : PR — B RHYTHM

A — 09 Heavy

CC0 : 81
PG# : 9 (25,41,57)

1	A07 : MIDled Grand
2	A56 : RockOut Bass
3	A43 : Syn Strat
4	A47 : Syn Guitar
5	A48 : Overdrive
6	A32 : Metal Organ
7	B55 : Touch Lead
8	PRA : PR — A RHYTHM

A — 13 Perc Harmnix

CC0 : 81
PG# : 13 (29,45,61)

1	B01 : Pizzicato
2	A30 : Jazz Organ 1
3	A38 : Velo Harmnix
4	A49 : Fretless
5	A56 : RockOut Bass
6	A01 : A.Piano 1
7	A47 : Syn Guitar
8	PRA : PR — A RHYTHM

A — 02 Softly.....

CC0 : 81
PG# : 2 (18,34,50)

1	B40 : Tenor Sax 1
2	A57 : Slap Bass
3	A01 : A.Piano 1
4	B55 : Touch Lead
5	A42 : Stratus
6	A14 : Stiky Rhodes
7	B37 : French Horn
8	PRA : PR — A RHYTHM

A — 06 FUNKY

CC0 : 81
PG# : 6 (22,38,54)

1	A17 : Clav 1
2	A49 : Fretless
3	A37 : 12 strings
4	B39 : Alto Sax
5	B48 : Air Lead
6	B20 : Beauty Vox
7	A10 : MIDI EPiano
8	PRB : PR — B RHYTHM

A — 10 Rockin Split

CC0 : 81
PG# : 10 (26,42,58)

1	A48 : Overdrive
2	A53 : Analog Bs 1
3	B54 : Square Lead
4	A58 : Thumpin Bass
5	B10 : Velo Strings
6	B20 : Beauty Vox
7	A19 : Marimba
8	PRA : PR — A RHYTHM

A — 14 Classy Piano

CC0 : 81
PG# : 14 (30,46,62)

1	A01 : A.Piano 1
2	B06 : Marcato
3	B11 : BrightStrngs
4	B06 : Marcato
5	B04 : SoarinString
6	B20 : Beauty Vox
7	A25 : Pipe Organ 1
8	PRA : PR — A RHYTHM

A — 03 Bossa nova

CC0 : 81
PG# : 3 (19,35,51)

1	A21 : Warm Vibe
2	A52 : Woody Bass 2
3	B45 : Flute mod
4	A33 : Nylon Gtr 1
5	A28 : E.Organ 1
6	B26 : Trombone
7	A19 : Marimba
8	PRA : PR — A RHYTHM

A — 07 Pop Fusion

CC0 : 81
PG# : 7 (23,39,55)

1	A11 : SA Rhodes
2	A56 : RockOut Bass
3	A43 : Syn Strat
4	B38 : AltoLead Sax
5	B26 : Trombone
6	B54 : Square Lead
7	A04 : Pop Piano 1
8	PRA : PR — A RHYTHM

A — 11 Brass Rock

CC0 : 81
PG# : 11 (27,43,59)

1	A48 : Overdrive
2	A56 : RockOut Bass
3	A41 : JC Strat
4	A01 : A.Piano 1
5	B16 : Strings Synth
6	B42 : Sax Section
7	B29 : TeaJay Brass
8	PRA : PR — A RHYTHM

A — 15 Perc Strings

CC0 : 81
PG# : 15 (31,47,63)

1	A20 : Marimba SW
2	A57 : Slap Bass
3	B08 : Orch Strings
4	B02 : Real Pizz
5	B03 : Harp
6	B31 : Brass Sect 2
7	B20 : Beauty Vox
8	PRA : PR — A RHYTHM

A — 04 Jazzygroove

CC0 : 81
PG# : 4 (20,36,52)

1	A30 : Jazz Organ 1
2	A49 : Fretless
3	B40 : Tenor Sax 1
4	B26 : Trombone
5	B25 : Trumpet
6	A01 : A.Piano 1
7	A42 : Stratus
8	PRA : PR — A RHYTHM

A — 08 Fusion Set

CC0 : 81
PG# : 8 (24,40,56)

1	A07 : MIDled Grand
2	A58 : Thumpin Bass
3	A10 : MIDI EPiano
4	A45 : Clean Strat
5	B39 : Alto Sax
6	B41 : Tenor Sax 2
7	B48 : Air Lead
8	PRB : PR — B RHYTHM

A — 12 Hard Wire

CC0 : 81
PG# : 12 (28,44,60)

1	A43 : Syn Strat
2	A57 : Slap Bass
3	A48 : Overdrive
4	A01 : A.Piano 1
5	B01 : Pizzicato
6	B55 : Touch Lead
7	B14 : Brite Stab
8	PRA : PR — A RHYTHM

A — 16 PopOrchestra

CC0 : 81
PG# : 16 (32,48,64)

1	A21 : Warm Vibe
2	A59 : Pick Bass
3	B08 : Orch Strings
4	A17 : Clav 1
5	B03 : Harp
6	B35 : Soft Brass
7	B44 : FlutePiccolo
8	PRA : PR — A RHYTHM

Performance(Preset.B)

B — 01 GTR Players
 CC0 : 81
 PG# : 65 (81,97,113)

1	A33 : Nylon Gtr 1
2	A59 : Pick Bass
3	A38 : Velo Harmnix
4	A37 : 12 Strings
5	A41 : JC Strat
6	A36 : PickedGuitar
7	A34 : Flanged Nyln
8	PRB : PR — B RHYTHM

B — 05 YMBA Choir
 CC0 : 81
 PG# : 69 (85,101,117)

1	B24 : Space Ahh
2	A53 : Analog Bs 1
3	B10 : Velo Strings
4	A39 : Nylon+Steel
5	A28 : E.Organ 1
6	B35 : Soft Brass
7	A45 : Clean Strat
8	PRB : PR — B RHYTHM

B — 09 for CompuMix
 CC0 : 81
 PG# : 73 (89,105,121)

1	A02 : A.Piano 2
2	A56 : RockOut Bass
3	B04 : SoarinString
4	A45 : Clean Strat
5	A13 : Dig Rhodes 2
6	A39 : Nylon+Steel
7	A28 : E.Organ 1
8	PRA : PR — A RYHTHM

B — 13 Acoustics
 CC0 : 81
 PG# : 77 (93,109,125)

1	A38 : Velo Harmnix
2	A37 : 12 strings
3	A50 : St Fretless
4	A38 : Velo Harmnix
5	B09 : Slow Strings
6	B08 : Orch Strings
7	B10 : Velo Strings
8	PRB : PR — B RHYTHM

B — 02 Synth Plus
 CC0 : 81
 PG# : 66 (82,98,114)

1	A11 : SA Rhodes
2	A53 : Analog Bs 1
3	B07 : St Strings
4	B52 : Soft Lead
5	B59 : JP — 8 Pad
6	B36 : Horn Brass
7	B45 : Flute mod
8	PRB : PR — B RHYTHM

B — 06 THE MALLETS
 CC0 : 81
 PG# : 70 (86,102,118)

1	A19 : Marimba
2	B50 : Log Drum
3	A21 : Warm Vibe
4	B49 : Steel Drum
5	A23 : Wave Bells
6	A20 : Marimba SW
7	B50 : Log Drum
8	PRB : PR — B RHYTHM

B — 10 Introduction
 CC0 : 81
 PG# : 74 (90,106,122)

1	A01 : A.Piano 1
2	A64 : Stereoww Bs
3	B08 : Orch Strings
4	A07 : MIDled Grand
5	A14 : Stiky Rhodes
6	A15 : Guitr Rhodes
7	B58 : EP+Exp Pad
8	PRB : PR — B RHYTHM

B — 14 Finale!!
 CC0 : 81
 PG# : 78 (94,110,126)

1	A38 : Velo Harmnix
2	A37 : 12 strings
3	A50 : St Fretless
4	A38 : Velo Harmnix
5	B09 : Slow Strings
6	B08 : Orch Strings
7	B10 : Velo Strings
8	PRB : PR — B RHYTHM

B — 03 PianoEnsembl
 CC0 : 81
 PG# : 67 (83,99,115)

1	A01 : A.Piano 1
2	B06 : Marcato
3	B07 : St Strings
4	B02 : Real Pizz
5	B03 : Harp
6	B35 : Soft Brass
7	B09 : Slow Strings
8	PRB : PR — B RHYTHM

B — 07 South Shore
 CC0 : 81
 PG# : 71 (87,103,119)

1	B49 : Steel Drum
2	A51 : Woody Bass 1
3	A45 : Clean Strat
4	B46 : Ocarina
5	B41 : Tenor Sax 2
6	B26 : Trombone
7	A20 : Marimba SW
8	PRB : PR — B RHYTHM

B — 11 House Sounds
 CC0 : 81
 PG# : 75 (91,107,123)

1	A54 : House Bass
2	A01 : A.Piano 1
3	A54 : House Bass
4	A62 : Rubber Bs 1
5	A58 : Thumpin Bass
6	B63 : RevCymBend
7	A45 : Clean Strat
8	PRB : PR — B RYHTHM

B — 15 Perseverance
 CC0 : 81
 PG# : 79 (95,111,127)

1	A59 : Pick Bass
2	A46 : Funk Gtr
3	B22 : Pvox Oooze
4	A61 : Yowza Bass
5	A13 : Dig Rhodes 2
6	B63 : RevCymBend
7	A45 : Clean Strat
8	PRB : PR — B RHYTHM

B — 04 Church Choir
 CC0 : 81
 PG# : 68 (84,100,116)

1	A01 : A.Piano 1
2	A49 : Fretless
3	A26 : Pipe Organ 2
4	B22 : Pvox Oooze
5	A25 : Pipe Organ 1
6	A23 : Wave Bells
7	A37 : 12 strings
8	PRB : PR — B RHYTHM

B — 08 Guitar Club
 CC0 : 81
 PG# : 72 (88,104,120)

1	A39 : Nylon+Steel
2	A38 : Velo Harmnix
3	A59 : Pick Bass
4	A58 : Thumpin Bass
5	A39 : Nylon+Steel
6	A37 : 12 strings
7	A31 : Jazz Organ 2
8	PRB : PR — B RHYTHM

B — 12 Cosmo Space
 CC0 : 81
 PG# : 76 (92,108,124)

1	B62 : Big n Beefy
2	B59 : JP — 8 Pad
3	B23 : GlassVoices
4	A62 : Rubber Bs 1
5	B64 : Analog Seq
6	B62 : Big n Beefy
7	B09 : Slow Strings
8	PRB : PR — B RHYTHM

B — 16 NewListening
 CC0 : 81
 PG# : 80 (96,112,128)

1	B39 : Alto Sax
2	A53 : Analog Bs 1
3	B13 : Orch Stab 1
4	A05 : Pop Piano 2
5	B60 : Puff.
6	A44 : Pop Strat
7	B30 : Brass Sect 1
8	PRA : PR — A RHYTHM

Performance(Internal)

I — 01 Syn Lead
 CC0:80
 PG# : 1 (17,33,49)

1	I22 : SAW Lead
2	I22 : SAW Lead
3	I22 : SAW Lead
4	I22 : SAW Lead
5	I22 : SAW Lead
6	I22 : SAW Lead
7	I07 : Slap !!!
8	INT : INT RHYTHM

I — 05 A.Piano+STR
 CC0 : 80
 PG# : 5 (21,37,53)

1	I09 : A.Piano 3
2	I01 : JV Strings
3	I04 : Brass Sect.
4	I04 : Brass Sect.
5	I05 : SA Rhodes !!
6	I06 : Pan Pipe
7	I07 : Slap !!!
8	INT : INT RHYTHM

I — 09 HauntedHouse
 CC0 : 80
 PG# : 9 (25,41,57)

1	I38 : Hammer Bell
2	I23 : Ice Hall
3	I47 : Wave Bells 2
4	I62 : Arctic Winds
5	I63 : DistanceCall
6	I23 : Ice Hall
7	I23 : Ice Hall
8	INT : INT RHYTHM

I — 13 Ice Church
 CC0 : 80
 PG# : 13 (29,45,61)

1	I63 : DistanceCall
2	I23 : Ice Hall
3	I13 : Great Church
4	I16 : X/Y/Z
5	I05 : SA Rhodes !!
6	I06 : Pan Pipe
7	I07 : Slap !!!
8	INT : INT RHYTHM

I — 02 Encounter X
 CC0 : 80
 PG# : 2 (18,34,50)

1	I34 JV Heaven
2	I50 Analog Pad 2
3	I62 Arctic Winds
4	I60 WhistlinAtom
5	I16 X/Y/Z
6	I23 Ice Hall
7	I63 DistanceCall
8	INT : INT RHYTHM

I — 06 Analog Brass
 CC0 : 80
 PG# : 6 (22,38,54)

1	I15 : Analog Brass
2	I55 : Black Brass
3	I49 : UTAKATA
4	I04 : Brass Sect.
5	I05 : SA Rhodes !!
6	I06 : Pan Pipe
7	I07 : Slap !!!
8	INT : INT RHYTHM

I — 10 Jazz Combo
 CC0 : 80
 PG# : 10 (26,42,58)

1	A21 : Warm Vibe
2	A52 : Woody Bass 2
3	B40 : Tenor Sax 1
4	B25 : Trumpet
5	B39 : Alto Sax
6	A01 : A.Piano 1
7	A45 : Clean Strat
8	PRA : PR — A RHYTHM

I — 14 Diamond Dust
 CC0 : 80
 PG# : 14 (30,46,62)

1	I62 : Arctic Winds
2	I34 : JV Heaven
3	B47 : OverblownPan
4	I16 : X/Y/Z
5	I05 : SA Rhodes !!
6	I06 : Pan Pipe
7	I07 : Slap !!!
8	INT : INT RHYTHM

I — 03 Analog Pad
 CC0 : 80
 PG# : 3 (19,35,51)

1	I63 : DistanceCall
2	I12 : Analog Pad 1
3	I03 : Von Greece
4	I50 : Analog Pad 2
5	I05 : SA Rhodes !!
6	I06 : Pan Pipe
7	I07 : Slap !!!
8	INT : INT RHYTHM

I — 07 Steel Pad
 CC0 : 80
 PG# : 7 (23,39,55)

1	I02 : BrightGuitar
2	I27 : P — P — P — Puff
3	I04 : Brass Sect.
4	I04 : Brass Sect.
5	I05 : SA Rhodes !!
6	I06 : Pan Pipe
7	I07 : Slap !!!
8	INT : INT RHYTHM

I — 11 Strat Pad
 CC0 : 80
 PG# : 11 (27,43,59)

1	A41 : JC Strat
2	I27 : P — P — P — Puff
3	I04 : Brass Sect.
4	I04 : Brass Sect.
5	I05 : SA Rhodes !!
6	I06 : Pan Pipe
7	I07 : Slap !!!
8	INT : INT RHYTHM

I — 15 House Hammer
 CC0 : 80
 PG# : 15 (31,47,63)

1	I20 : House Hunter
2	I38 : Hammer Bell
3	I30 : El.Piano
4	I11 : Orch Stab 2
5	I34 : JV Heaven
6	I23 : Ice Hall
7	I58 : Hardy Winery
8	INT : INT RHYTHM

I — 04 Stab Stab !!
 CC0 : 80
 PG# : 4 (20,36,52)

1	I11 : Orch Stab 2
2	I32 : 5 — Strng Bass
3	B13 : Orch Stab 1
4	I45 : Orch Stab 3
5	I55 : Black Brass
6	I14 : Rubber Bs 3
7	I07 : Slap !!!
8	INT : INT RHYTHM

I — 08 Brass ComeOn
 CC0 : 80
 PG# : 8 (24,40,56)

1	I15 : Analog Brass
2	I04 : Brass Sect.
3	I49 : UTAKATA
4	I04 : Brass Sect.
5	I05 : SA Rhodes !!
6	I06 : Pan Pipe
7	I07 : Slap !!!
8	INT : INT RHYTHM

I — 12 Movie Stab
 CC0 : 80
 PG# : 12 (28,44,60)

1	I11 : Orch Stab 2
2	I11 : Orch Stab 2
3	I11 : Orch Stab 2
4	I11 : Orch Stab 2
5	I34 : JV Heaven
6	I23 : Ice Hall
7	I58 : Hardy Winery
8	INT : INT RHYTHM

I — 16 TUTORIAL
 CC0 : 80
 PG# : 16 (32,48,64)

1	B08 : Orch Strings
2	A01 : A.Piano 1
3	A52 : Woody Bass 2
4	A28 : E.Organ 1
5	A39 : Nylon+Steel
6	B03 : Harp
7	B44 : FlutePiccolo
8	INT : INT RHYTHM

Rhythm Set

Preset A

CC0 : 81
PG# : 1—64

		Tone Name	Wave No.
C2	36	Bright Kick	90
	37	Cross Stick 1	102
38	90's Snare	85	
C3	39	808 Claps	103
	40	90's Snare	85
41	Power Tom Lo	101	
C4	42	Closed HAT 1	94
	43	Power Tom Lo	101
C5	44	Closed HAT 2	95
	45	Power Tom Hi	100
C6	46	Open HAT 1	96
	47	Power Tom Hi	100
C7	48	Power Tom Hi	100
	49	Crash 1	97
C8	50	Power Tom Hi	100
	51	Ride 1	98
C9	52	Tin Wave	82
	53	Ride Bell 1	99
C10	54	Tambourine	105
	55	Spectrum 1	83
C11	56	Cowbell 1	104
	57	Crash 1	97
C12	58	Crash 1	97
	59	Piccolo SN	86
C13	60	CGA Mute Hi	107
	61	CGA Mute Lo	108
C14	62	CGA Slap	109
	63	Conga Hi	110
C15	64	Conga Lo	111
	65	Timbale	106
C16	66	Timbale	106
	67	Power Tom Lo	101
C17	68	LA Snare	87
	69	Cabasa Up	114
C18	70	Maracas	112
	71	Cabasa Down	115
C19	72	Maracas Cut	113
	73	Whack Snare	88
C20	74	Verb Kick	91
	75	Rim Shot	89
C21	76	Round Kick	92
	77	808 Kick	93
C22	78	Cabasa Down	115
	79	REV Steel DR	116
C23	80	REV Tin Wave	117
	81	REV SN 1	118
C24	82	REV SN 2	119
	83	REV SN 3	120
C25	84	Wind Chimes	80
	85	REV Kick	122
C26	86	Anklungs	79
	87	Rattles	81
C27	88	REV Cow Bell	125
	89	REV TAMB	126
C28	90	REV Conga	127
	91	REV Maracas	128
C29	92	REV Crash	129
	93	Steel Drum	60
C30	94	Wind Agogo	76
	95	Wind Agogo	76
C31	96	808 SNR 1	84

Preset B

CC0 : 81
PG# : 65—128

	Tone Name	Wave No.
Bright Kick	90	
Cross Stick 1	102	
Piccolo SN	86	
808 Claps	103	
LA Snare	87	
Power Tom Lo	101	
Closed HAT 1	94	
Power Tom Lo	101	
Closed HAT 2	95	
Power Tom Lo	101	
Open HAT 1	96	
Power Tom Lo	101	
Power Tom Hi	100	
Crash 1	97	
Power Tom Hi	100	
Ride 1	98	
Crash 1	97	
Ride Bell 1	99	
Crash 1	97	
Crash 1	97	
Cowbell 1	104	
Crash 1	97	
Cowbell 1	104	
Crash 1	97	
CGA Mute Hi	107	
Conga Hi	110	
CGA Slap	109	
Conga Lo	111	
CGA Mute Lo	108	
Timbale	106	
Timbale	106	
Timbale	106	
Timbale	106	
Timbale	106	
Agogo	53	
Agogo	53	
Cabasa Up	114	
Cabasa Down	115	
Cabasa Cut	113	
Maracas	112	
Maracas Cut	113	
Maracas	112	
Maracas Cut	113	
Tambourine	105	
Log Drum	57	
DIGI Bell 1	58	
DIGI Chime	59	
Steel Drums	60	
Ankiungs	79	
Wind Chimes	80	
Rattles	81	
Ronund Kick	92	
808 Kick	93	
808 Kick	93	
808 SNR 1	84	
REV TAMB	126	
90's Snare	85	
Closed HAT 1	94	
Tin Wave	82	
Spectrum 1	83	
REV Steel DR	116	
REV Tin Wave	117	
REV SN 1	118	
REV Crash 1	129	
REV Cow Bell	125	

Internal

CC0 : 80
PG# : 1—64

	Tone Name	Wave No.
Bright Kick	90	
Cross Stick 1	102	
90's Snare	85	
808 Claps	103	
LA Snare	87	
Power Tom Lo	101	
Closed HAT 1	94	
Power Tom Lo	101	
Closed HAT 2	95	
Power Tom Hi	100	
Open HAT 1	96	
Power Tom Hi	100	
Power Tom Hi	100	
Crash 1	97	
Power Tom Hi	100	
Ride 1	98	
Ride Bell	99	
REV SN 1	118	
Tambourine	105	
REV SN 2	119	
Cowbell 1	104	
REV SN 3	120	
Cowbell 1	104	
REV SN 4	121	
CGA Mute Hi	107	
CGA Mute Lo	108	
CGA Slap	109	
Conga Hi	110	
Conga Lo	111	
Timbale	106	
Timbale	106	
Agogo	53	
Agogo	53	
Cabasa Up	114	
Cabasa Down	115	
Maracas Cut	113	
808 Kick	93	
808 SNR 1	84	
DIGI Bell 1	58	
808 SNR 1	84	
808 Kick	93	
Spectrum 1	83	
808 Kick	93	
Spectrum 1	83	
808 Kick	93	
808 Kick	93	
Feedbackwave	78	
808 Kick	93	
Feedbackwave	78	
Pop Voice	48	
Pop Voice	48	
Wind Agogo	76	
Pop Voice	48	
Wind Agogo	76	
Open HAT 1	96	
Anklungs	79	
Open HAT 1	96	
Open HAT 1	96	

BLANK CHART

● System Common

Master tune			MIDI	Rx channel (Patch mode)	
Output mode		2OUT · 4OUT		Control ch (Performance mode)	
Chorus switch		ON · OFF		Unit number	
Reverb switch		ON · OFF		Rx switch Program change	ON · OFF
Rhythm edit key		INT & MIDI · INT		Rx switch Program bank select	ON · OFF
Display contrast				Rx switch Control change	ON · OFF
Power up		DEFAULT · LAST SET		Rx switch Volume	ON · OFF
Preview	1 (Note, Velocity)			Rx switch pitch bend	ON · OFF
	2 (Note, Velocity)			Rx switch Modulation	ON · OFF
	3 (Note, Velocity)			Rx switch Aftertouch	ON · OFF
	4 (Note, Velocity)		Rx switch Exclusive	ON · OFF	
Scale tune switch		ON · OFF			

Scale tune (Performance mode)

	Part 1	Part 2	Part 3	Part 4	Part 5	Part 6	Part 7	Part 8 (R)
Scale tune C								
Scale tune C#								
Scale tune D								
Scale tune D#								
Scale tune E								
Scale tune F								
Scale tune F#								
Scale tune G								
Scale tune G#								
Scale tune A								
Scale tune A#								
Scale tune B								

Scale tune (Patch mode)

Scale tune C	
Scale tune C#	
Scale tune D	
Scale tune D#	
Scale tune E	
Scale tune F	
Scale tune F#	
Scale tune G	
Scale tune G#	
Scale tune A	
Scale tune A#	
Scale tune B	

● Patch

Patch number		Patch name	
--------------	--	------------	--

Common

Level			Chorus	type	
Pan				level	
Velocity switch		ON · OFF		rate	
Analog feel				depth	
Key assign		POLY · SOLO		feedback	
Legato		ON · OFF		output	MIX · REVERB
Bend range Up				type	
Bend range Down			level		
Portamento	switch	ON · OFF	Reverb	time	
	mode	LEGATO · NORMAL		feedback	
	type	TIME · RATE			
	time				

Tone

		TONE 1	TONE 2	TONE 3	TONE 4
TONE SWITCH		ON · OFF	ON · OFF	ON · OFF	ON · OFF
Volume switch		ON · OFF	ON · OFF	ON · OFF	ON · OFF
Hold — 1 switch		ON · OFF	ON · OFF	ON · OFF	ON · OFF
Velocity range (Low — UP)		—	—	—	—
Modulation	destination				
	depth				
Aftertouch	destination				
	depth				
Expression	destination				
	depth				
LFO 1	waveform				
	synchro	ON · OFF	ON · OFF	ON · OFF	ON · OFF
	rate				
	offset				
	delay				
	fade	IN · OUT	IN · OUT	IN · OUT	IN · OUT
	fade time				
	pitch depth				
	TVF depth				
	TVA depth				
LFO 2	waveform				
	synchro	ON · OFF	ON · OFF	ON · OFF	ON · OFF
	rate				
	offset				
	delay				
	fade	IN · OUT	IN · OUT	IN · OUT	IN · OUT
	fade time				
	pitch depth				
	TVF depth				
	TVA depth				

		TONE 1	TONE 2	TONE 3	TONE 4
WG	wave group	INT • EXP • CARD	INT • EXP • CARD	INT • EXP • CARD	INT • EXP • CARD
	wave number (Name)				
	FXM switch	ON • OFF	ON • OFF	ON • OFF	ON • OFF
	FXM depth				
	pitch coarse				
	pitch fine				
	random pitch				
	pitch keyfollow				
	ENV depth				
Pitch—ENV	pitch velocity				
	T1 velocity				
	T4 velocity				
	time keyfollow				
	time 1—4				
TVF	level 1—4				
	type	OFF • LPF • LPF	OFF • LPF • LPF	OFF • LPF • LPF	OFF • LPF • LPF
	cutoff frequency				
	resonance				
	resonance mode	SOFT • HARD	SOFT • HARD	SOFT • HARD	SOFT • HARD
	keyfollow				
TVF—ENV	ENV depth				
	velocity curve	1 • 2 • 3 • 4 • 5 • 6 • 7	1 • 2 • 3 • 4 • 5 • 6 • 7	1 • 2 • 3 • 4 • 5 • 6 • 7	1 • 2 • 3 • 4 • 5 • 6 • 7
	velocity				
	T1 velocity				
	T4 velocity				
	time keyfollow				
	time 1—4				
TVA	level 1—4				
	level				
	keyfollow				
	velocity curve	1 • 2 • 3 • 4 • 5 • 6 • 7	1 • 2 • 3 • 4 • 5 • 6 • 7	1 • 2 • 3 • 4 • 5 • 6 • 7	1 • 2 • 3 • 4 • 5 • 6 • 7
	velocity				
	pan				
	panning keyfollow				
	delay mode	NORMAL • HOLD • PLAYMATE	NORMAL • HOLD • PLAYMATE	NORMAL • HOLD • PLAYMATE	NORMAL • HOLD • PLAYMATE
TVA—ENV	delay time				
	T1 velocity				
	T4 velocity				
	time keyfollow				
	time 1—4				
Output	level 1—3				
	dri level				
	chorus send				
	reverb send				
	output select	MAIN • SUB	MAIN • SUB	MAIN • SUB	MAIN • SUB

● Performance

Performance number	—	Performance name	
---------------------------	---	-------------------------	--

Common

Chorus	type		Reverb	type		
	level			level		
	rate			time		
	depth			feedback		
	feedback					
	output	MIX · REVERB				

Part

	Part 1	Part 2	Part 3	Part 4	Part 5	Part 6	Part 7	Part 8 (R)
Rx switch	ON · OFF	ON · OFF	ON · OFF	ON · OFF	ON · OFF	ON · OFF	ON · OFF	ON · OFF
Rx channel								
Patch select								
Level								
Pan								
Tune								
Fine tune								
Voice reserve								
Chorus switch	ON · OFF	ON · OFF	ON · OFF	ON · OFF	ON · OFF	ON · OFF	ON · OFF	ON · OFF
Reverb switch	ON · OFF	ON · OFF	ON · OFF	ON · OFF	ON · OFF	ON · OFF	ON · OFF	ON · OFF
Rx program change	ON · OFF	ON · OFF	ON · OFF	ON · OFF	ON · OFF	ON · OFF	ON · OFF	ON · OFF
Rx volume	ON · OFF	ON · OFF	ON · OFF	ON · OFF	ON · OFF	ON · OFF	ON · OFF	ON · OFF
Rx Hold — 1	ON · OFF	ON · OFF	ON · OFF	ON · OFF	ON · OFF	ON · OFF	ON · OFF	ON · OFF
Output select	MN · SB · PAT	MN · SB · PAT	MN · SB · PAT	MN · SB · PAT	MN · SB · PAT	MN · SB · PAT	MN · SB · PAT	MN · SB · PAT

● Rhythm Tone

Assign note	
-------------	--

Assign note	
-------------	--

Bender range		
ENV mode		
Mute group		
Tone switch		ON • OFF
WG	wave group	INT • EXP • CARD
	wave number (Name)	
	pitch coarse	
	pitch fine	
	random pitch	
	ENV depth	
	pitch velocity	
	pitch time velocity	
	P-ENV	time 1—4
level 1—4		
TVF	type	OFF • LPF • HPF
	cutoff frequency	
	resonance	
	resonance mode	SOFT • HARD
	ENV depth	
	velocity	
	time velocity	
F-ENV	time 1—4	
	level 1—4	
TVA	level	
	velocity	
	time velocity	
	pan	
A-ENV	time 1—4	
	level 1—3	
Output	dry level	
	chorus send	
	reverb send	
	output select	MAIN • SUB

Bender range		
ENV mode		
Mute group		
Tone switch		ON • OFF
WG	wave group	INT • EXP • CARD
	wave number (Name)	
	pitch coarse	
	pitch fine	
	random pitch	
	ENV depth	
	pitch velocity	
	pitch time velocity	
	P-ENV	time 1—4
level 1—4		
TVF	type	OFF • LPF • HPF
	cutoff frequency	
	resonance	
	resonance mode	SOFT • HARD
	ENV depth	
	velocity	
	time velocity	
F-ENV	time 1—4	
	level 1—4	
TVA	level	
	velocity	
	time velocity	
	pan	
A-ENV	time 1—4	
	level 1—3	
Output	dry level	
	chorus send	
	reverb send	
	output select	MAIN • SUB

Roland Exclusive Messages

1. Data Format for Exclusive Messages

Roland's MIDI implementation uses the following data format for all exclusive messages (type IV):

Byte	Description
F0H	Exclusive status
41H	Manufacturer ID (Roland)
DEV	Device ID
MDL	Model ID
CMD	Command ID
[BODY]	Main data
F7H	End of exclusive

#MIDI status: F0H, F7H

An exclusive message must be flanked by a pair of status codes, starting with a Manufacturer-ID immediately after F0H (MIDI version 1.0).

#Manufacturer-ID: 41H

The Manufacturer-ID identifies the manufacturer of a MIDI instrument that triggers an exclusive message. Value 41H represents Roland's Manufacturer-ID.

#Device-ID: DEV

The Device-ID contains a unique value that identifies the individual device in the multiple implementation of MIDI instruments. It is usually set to 00H - 0FH, a value smaller by one than that of a basic channel, but value 00H - 1FH may be used for a device with multiple basic channels.

#Model-ID: MDL

The Model-ID contains a value that uniquely identifies one model from another. Different models, however, may share an identical Model-ID if they handle similar data.

The Model-ID format may contain 00H in one or more places to provide an extended data field. The following are examples of valid Model-IDs, each representing a unique model:

01H
02H
03H
00H, 01H
00H, 02H
00H, 00H, 01H

#Command-ID: CMD

The Command-ID indicates the function of an exclusive message. The Command-ID format may contain 00H in one or more places to provide an extended data field. The following are examples of valid Command-IDs, each representing a unique function:

01H
02H
03H
00H, 01H
00H, 02H
00H, 00H, 01H

#Main data: BODY

This field contains a message to be exchanged across an interface. The exact data size and contents will vary with the Model-ID and Command-ID.

2. Address-mapped Data Transfer

Address mapping is a technique for transferring messages conforming to the data format given in Section 1. It assigns a series of memory-resident records--waveform and tone data, switch status, and parameters, for example--to specific locations in a machine-dependent address space, thereby allowing access to data residing at the address a message specifies.

Address-mapped data transfer is therefore independent of models and data categories. This technique allows use of two different transfer procedures: one-way transfer and handshake transfer.

One-way transfer procedure (See Section 3 for details.)

This procedure is suited for the transfer of a small amount of data. It sends out an exclusive message completely independent of a receiving device status.

Connection Diagram

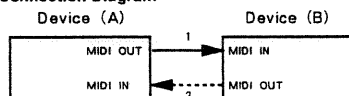

Connection at point 2 is essential for "Request data" procedures. (See Section 3.)

#Handshake-transfer procedure (This device does not cover this procedure)

This procedure initiates a predetermined transfer sequence (handshaking) across the interface before data transfer takes place. Handshaking ensures that reliability and transfer speed are high enough to handle a large amount of data.

Connection Diagram

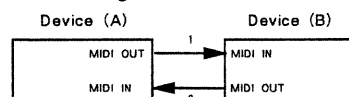

Connection at points 1 and 2 is essential.

Notes on the above two procedures

- * There are separate Command-IDs for different transfer procedures.
- * Devices A and B cannot exchange data unless they use the same transfer procedure, share identical Device-ID and Model ID, and are ready for communication.

3. One-way Transfer Procedure

This procedure sends out data all the way until it stops and is used when the messages are so short that answerbacks need not be checked.

For long messages, however, the receiving device must acquire each message in time with the transfer sequence, which inserts intervals of at least 20 milliseconds in between.

Types of Messages

Message	Command ID
Request data 1	RQ1 (11H)
Data set 1	DT1 (12H)

#Request data #1: RQ1 (11H)

This message is sent out when there is a need to acquire data from a device at the other end of the interface. It contains data for the address and size that specify designation and length, respectively, of data required.

On receiving an RQ1 message, the remote device checks its memory for the data address and size that satisfy the request.

If it finds them and is ready for communication, the device will transmit a "Data set 1 (DT1)" message, which contains the requested data. Otherwise, the device will send out nothing.

Byte	Description
F0H	Exclusive status
41H	Manufacturer ID (Roland)
DEV	Device ID
MDL	Model ID
11H	Command ID
aaH	Address MSB
⋮	⋮
⋮	⋮
⋮	⋮
ssH	Size MSB
⋮	⋮
⋮	⋮
⋮	⋮
sum	Check sum
F7H	End of exclusive

- * The size of the requested data does not indicate the number of bytes that will make up a DT1 message, but represents the address fields where the requested data resides.
- * Some models are subject to limitations in data format used for a single transaction. Requested data, for example, may have a limit in length or must be divided into predetermined address fields before it is exchanged across the interface.
- * The same number of bytes comprises address and size data, which, however, vary with the Model-ID.
- * The error checking process uses a checksum that provides a bit pattern where the least significant 7 bits are zero when values for an address, size, and that checksum are summed.

#Data set 1: DT1 (12H)

This message corresponds to the actual data transfer process. Because every byte in the data is assigned a unique address, a DT1 message can convey the starting address of one or more data as well as a series of data formatted in an address-dependent order.

The MIDI standards inhibit non-real time messages from interrupting an exclusive one. This fact is inconvenient for the devices that support a "soft-through" mechanism. To maintain compatibility with such devices, Roland has limited the DT1 to 256 bytes so that an excessively long message is sent out in separate segments.

Byte	Description
F0H	Exclusive
41H	Manufacturer ID (Roland)
DEV	Device ID
MDL	Model ID
12H	Command ID
aaH	Address MSB
⋮	⋮
	LSB
ddH	Data
⋮	⋮
sum	Check sum
F7H	End of exclusive

- * A DT1 message is capable of providing only the valid data among those specified by an RQ1 message.
- * Some models are subject to limitations in data format used for a single transaction. Requested data, for example, may have a limit in length or must be divided into predetermined address fields before it is exchanged across the interface.
- * The number of bytes comprising address data varies from one Model-ID to another.
- * The error checking process uses a checksum that provides a bit pattern where the least significant 7 bits are zero when values for an address, size, and that checksum are summed.

#Example of Message Transactions

● Device A sending data to Device B

Transfer of a DT1 message is all that takes place.

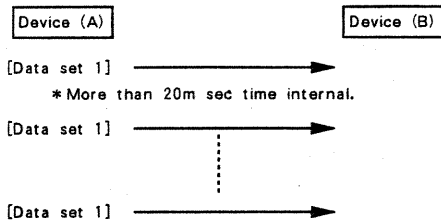

● Device B requesting data from Device A

Device B sends an RQ1 message to Device A. Checking the message, Device A sends a DT1 message back to Device B.

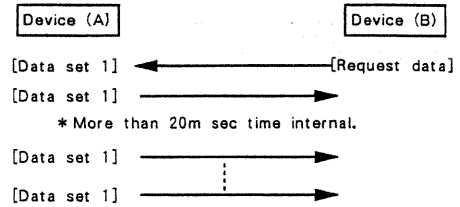

1. RECEIVE DATA**■ Channel Voice Message****● Note off**

Status	Second	Third
8nH	kkH	vvH
9nH	kkH	00H

n = MIDI channel number : 0H - FH (ch.1 - ch.16)
 kk = Note number : 00H - 7FH (0 - 127)
 vv = Velocity : 00H - 7FH (0 - 127)

- * In the performance mode, ignored when the MIDI receive switch is OFF at each part.
- * In the rhythm part (part8), ignored when "ENV mode" is "NO - SUSTAIN" at each rhythm tone.

● Note on

Status	Second	Third
9nH	kkH	vvH

n = MIDI channel number : 0H - FH (ch.1 - ch.16)
 kk = Note number : 00H - 7FH (0 - 127)
 vv = Velocity : 01H - 7FH (1 - 127)

- * In the performance mode, ignored when the MIDI receive switch is OFF at each part.

● Control change**○ Bank select (MSB only)**

Status	Second	Third
BnH	00H	vvH

n = MIDI channel number : 0H - FH (ch.1 - ch.16)
 vv = Bank number : 50H, 51H (80, 81)

- * Recognized the bank select MSB only. Ignored the LSB.
- * The bank select is suspended until receiving a program change.
- * The bank number of user's memory is 80, The bank number of preset memory is 81.
- * Ignored when "Program bank sel" of the system common is OFF.
- * In the patch mode, selected a bank of the patch memory. In the performance mode, selected a bank of the performance part memory. And specified the control channel, selected a bank of the performance itself.

○ Modulation

Status	Second	Third
BnH	01H	vvH

n = MIDI channel number : 0H - FH (ch.1 - ch.16)
 vv = Modulation depth : 00H - 7FH (0 - 127)

- * The effect of the modulation depends on the value of "Mod1-4" of the patch tone.
- * Ignored when "Modulation" of the system common is OFF.

○ Portamento time

Status	Second	Third
BnH	05H	vvH

n = MIDI channel number : 0H - FH (ch.1 - ch.16)
 vv = Portamento time : 00H - 7FH (0 - 127)

- * You can adjust the portamento time of the patch common.
- * Ignored when "Control change" of the system common is OFF.

○ Volume

Status	Second	Third
BnH	07H	vvH

n = MIDI channel number : 0H - FH (ch.1 - ch.16)
 vv = Volume : 00H - 7FH (0 - 127)

- * You can adjust the volume of specified channel.
- * Ignored when "Volume" of the system common is OFF.
- * In the performance mode, ignored when the volume receive switch is OFF at each part.
- * Ignored when "Volume switch" of the patch tone is OFF.

○ Pan

Status	Second	Third
BnH	0AH	vvH

n = MIDI channel number : 0H - FH (ch.1 - ch.16)
 vv = PanB : 00H - 7FH (0 - 127)

- * "0" represents left end, "64" represents the center, and "127" represents right end.
- * Ignored when "Control change" of the system common is OFF.

○ Expression

Status	Second	Third
BnH	0BH	vvH

n = MIDI channel number : 0H - FH (ch.1 - ch.16)
 vv = Expression : 00H - 7FH (0 - 127)

- * The effect of the expression depends on the value of "Exp1-4" of the patch tone.
- * Ignored when "Control change" of the system common is OFF.

○ Hold1

Status	Second	Third
BnH	40H	vvH

n = MIDI channel number : 0H - FH (ch.1 - ch.16)
 vv = Control value : 00H - 7FH (0 - 127) 0-63 = OFF 64-127 = ON

- * Notes played can be sustained for as long as the time that elapses between turning hold on and turning hold off.
- * Ignored when "Control change" of the system common is OFF.
- * In the performance mode, ignored when the hold1 receive switch is OFF at each part.
- * In the rhythm part (part8), ignored when "ENV mode" is "NO - SUSTAIN" at each rhythm tone.
- * Ignored when "Hold-1 switch" of patch tone is OFF.

○ Portamento

Status	Second	Third
BnH	41H	vvH

n = MIDI channel number : 0H - FH (ch.1 - ch.16)
 vv = Control value : 00H - 7FH (0 - 127) 0-63 = OFF 64-127 = ON

- * Switched over "Porta sw" of patch common.
- * Ignore when "Control change" of the system common is OFF.

○ Effect1 depth(Reverb send level)

Status Second Third
BnH 5BH vvH

n = MIDI channel number : 0H - FH (ch.1 - ch.16)
vv = Control value : 00H - 7FH (0 - 127) 0 - 63 = OFF 64 - 127 = ON

* In the patch mode, switched over the reverb switch of the system common.
* In the performance mode, switched over the reverb switch of the performance part.

And specified the control channel, switched over the reverb switch of the system common.

* Ignored when "Control change" of the system common is OFF.

○ Effect3 depth(Chorus send level)

Status Second Third
BnH 5DH vvH

n = MIDI channel number : 0H - FH (0 - 15) 0 = ch.1 15 = ch.16
vv = Control value : 00H - 7FH (0 - 127) 0 - 63 = OFF 64 - 127 = ON

* In the patch mode, switched over the chorus switch of the system common.
* In the performance mode, switched over the chorus switch of the performance part.

And specified the control channel, switched over the chorus switch of the system common.

* Ignored when "Control change" of the system common is OFF.

○ RPN LSB

Status Second Third
BnH 64H llH

n = MIDI channel number : 0H - FH (ch.1 - ch.16)
ll = LSB of the specified parameter by RPN

○ RPN MSB

Status Second Third
BnH 65H mmH

n = MIDI channel number : 0H - FH (ch.1 - ch.16)
mm = MSB of the specified parameter by RPN

○ Data entry LSB

Status Second Third
BnH 26H llH

n = MIDI channel number : 0H - FH (ch.1 - ch.16)
ll = Value of the parameter specified with RPN

* Ignored when "Control change" of the system common is OFF.

○ Data entry MSB

Status Second Third
BnH 06H mmH

n = MIDI channel number : 0H - FH (ch.1 - ch.16)
mm = Value of the parameter specified with RPN

* Ignored when "Control change" of the system common is OFF.

** RPN **

RPN (registered parameter number) is a parameter number of tone color or musical expression defined in MIDI specification.

With the JV-880 as the receiver, RPN # 0 (pitch bend sensitivity), RPN # 1 (fine tuning) and RPN # 2 (coarse tuning) are effective. When sending an RPN to the JV-880, first specify the MSB and LSB of the RPN to be used to control a parameter and then set the value in the data entry field.

BnH 65H mmH BnH 64H llH BnH 06H xxH BnH 26H yyH
(RPN MSB) (RPN LSB) (Data Entry MSB) (Data Entry LSB)

n = MIDI channel number : 0H - FH (ch.1 - ch.16)

RPN	Data entry	Description
MSB LSB mm ll	MSB LSB xx yy	

00H 00H xxH ---
Pitch bend sensitivity
xx : 00H - 0CH (0 - 12 semitone)
yy : Ignored
(Up to 1 octave)

*You can adjust "Bend range up" and "Bend range down" at same time.

*In the rhythm part(part8), this message is not recognized.

00H 01H xxH yyH
Fine tuning
xx, yy : 20H, 00H - 40H, 00H - 60H, 00H
(-50 - 0 - +50 cent)

*In the patch mode, adjusted the master tune.

*In the performance mode, adjusted fine tune at each part.

*In the performance mode, specified control channel, changed the master tune.

00H 02H xxH ---
Coarse tuning
xx : 10H - 40H - 70H
(-48 - 0 - +48 semitone)

yy : Ignored
*In the patch mode, this message is not recognized.

*In the performance mode, adjusted coarse tune at each part.

7FH 7FH --- ---
RPN reset
xx, yy : Ignored
*Return to no specified parameter of RPN.
Current setting value is no change.

* Either MSB or LSB of the RPN can be sent first: no problem with the JV-880.

* In contrast, data must be entered MSB first followed by the LSB.

(The JV-880 clears the existing LSB to "0" as it receives the MSB.)

● Program change

Status Second
CnH ppH

n = MIDI channel number : 0H - FH (ch.1 - ch.16)
pp = Program number : 00H - 7FH (0 - 127)

* Ignored when "Program change" of the system common is OFF.

* When the JV-880 receives a program change on a part receive channel while in the performance mode, it changes the patches of that part: the new patch value being the program number plus 1. If the JV-880 receives the program change on the control channel, it changes the performance according to the table below.

CnH	ppH	Performance (Bank select = 80[Bank select = 81])
00H	I01	[A01]
01H	I02	[A02]
:	:	:
0FH	I16	[A16]
10H	I01	[A01]
:	:	:
:	:	:
:	:	:
3FH	I16	[A16]
40H	C01	[B01]
41H	C02	[B02]
:	:	:
:	:	:
4FH	C16	[B16]
50H	C01	[B01]
:	:	:
:	:	:
:	:	:
7FH	C16	[B16]

*Even if program changes cover from 10H to 3FH,
the JV-880 only repeats I01(A01)-I16(A16).

*Even if program changes cover from 50H to 7FH,
the JV-880 only repeats C01(B01)-C16(B16).

● Channel pressure

Status	Second
DnH	vvH

n = MIDI channel number : 0H - FH (ch.1 - ch.16)
 vv = Pressure value : 00H - 7FH (0 - 127)

* The effect of the Channel pressure depends on the value of "After1-4" of the patch tone.
 * Ignored when "Aftertouch" of the system common is OFF.

● Pitch bend change

Status	Second	Third
EnH	llH	mmH

n = MIDI channel number : 0H - FH (ch.1 - ch.16)
 mm, ll = Pitch bend change : 00H, 00H - 40H, 00H - 7FH, 7FH
 (-8192 - 0 - +8191)

* Ignored when "Pitch bend" of the system common is OFF.

■ Channel Mode Message

● Reset All Controllers

Status	Second	Third
BnH	79H	00H

n = MIDI channel number : 0H - FH (ch.1 - ch.16)

* Received this message, The controllers is set the following.

Controller	Value
Modulation	0(off)
Volume	127(maximum)
Pan	64(center)
Expression	0(off)
Hold1	0(off)
Channel pressure	0(off)
Pitch bend change	±0(center)
RPN	No specified parameter, value is no change.

● All notes off

Status	Second	Third
BnH	7BH	00H

n = MIDI channel number : 0H - FH (ch.1 - ch.16)

* When this message is recognized, all the notes which have been turned on by MIDI note on message are turned off.

● OMNI OFF

Status	Second	Third
BnH	7CH	00H

n = MIDI channel number : 0H - FH (ch.1 - ch.16)

* Recognized as all notes off.

● OMNI ON

Status	Second	Third
BnH	7DH	00H

n = MIDI channel number : 0H - FH (ch.1 - ch.16)

* Recognized as all notes off. (JV880 doesn't recognize OMNI ON.)

● MONO

Status	Second	Third
BnH	7EH	mmH

n = MIDI channel number : 0H - FH (ch.1 - ch.16)
 mm = Number of mono : 0H - FH (0 - 16)

* Recognized as all notes off, and set MODE4 (M=1) at each part.

● POLY

Status	Second	Third
BnH	7FH	00H

n = MIDI channel number : 0H - FH (ch.1 - ch.16)

* Recognized all notes off, and set MODE3 at each part.

■ System Realtime message

● Active sensing

Status
FEH

* When JV-880 receive "active sensing", it measures time intervals between incoming messages. If the subsequent message will not come within about 400 ms after previous one, JV-880 turn off all MIDI-on notes as if it receive "reset all controllers", and stop measuring message interval.

■ System Exclusive Message

Status	Data
FOH	iiH ddHeeH
F7H	

FOH : System exclusive
 ii = Manufacturer ID : 41H (65)
 ddee = Data : 00H - 7FH (0 - 127)
 F7H : EOX(End of exclusive)

Ignored when "Exclusive" of the system common is OFF.

Refer to section 3, 4.

2. Transmit Data

■ System Exclusive Message

Status	Data
FOH	iiH ddHeeH
F7H	

FOH : System exclusive
 ii = Manufacturer ID : 41H (65)
 ddee = Data : 00H - 7FH (0 - 127)
 F7H : EOX(End of exclusive)

Refer to section 3, 4.

3. Exclusive communications

The JV-880 can send and receive patch parameter, etc using the system exclusive message.

The model ID code of the JV-880 is 46H. The device ID code is to be determined by the unit number setting of MIDI function.

The JV-880 ignores GS exclusive messages other than scale tune parameter.

The model ID of the GS is 42H.

■ One way communication

● Request data 1 RQ1(11H)

Byte	Description
FOH	Exclusive status
41H	Manufacturer ID (Roland)
Dev	Device ID (Dev = UNIT# - 1)
46H	Model ID (JV-880)
11H	Command ID (RQ1)
aaH	Address MSB
bbH	Address
ccH	Address
ddH	Address LSB
ssH	Size MSB
ttH	Size
uuH	Size
vvH	Size LSB
sum	Check sum
F7H	EOX (End of exclusive)

* Receive only: the JV-880 does not send this message.

● Data set 1 DT1(12H)

1. JV-880 (MODEL ID = 46H)

Byte	Description
FOH	Exclusive status
41H	Manufacturer ID (Roland)
Dev	Device ID (Dev = UNIT# - 1)
46H	Model ID (JV-880)
12H	Command ID (DT1)
aaH	Address MSB
bbH	Address
ccH	Address
ddH	Address LSB
eeH	Data
:	:
ffH	Data
sum	Check sum
F7H	EOX (End of exclusive)

2. GS (MODEL ID = 42H)

Byte	Description
FOH	Exclusive status
41H	Manufacturer ID (Roland)
Dev	Device ID (Dev = UNIT# - 1)
42H	Model ID (GS)
12H	Command ID (DT1)
aaH	Address MSB
bbH	Address
ccH	Address LSB
eeH	Data
:	:
ffH	Data
sum	Check sum
F7H	EOX (End of Exclusive)

Note: When the device ID is 7FH, JV-880 can receive the GS exclusive message even if the unit number is anything.

4. Parameter address map

Address and size are configured in 7 bits, and expressed in hexadecimal.

Address	MSB			LSB				
Binary	0aaa	aaaa	0bbb	bbbb	0ccc	cccc	0ddd	dddd
7-bit hex	AA		BB		CC		DD	

Size	MSB			LSB				
Binary	0sss	ssss	0ttt	tttt	0uuu	uuuu	0vvv	vvvv
7-bit hex	SS		TT		UU		VV	

■ Parameter base address

All data sent in exclusive message are given particular addresses to identify parameters. These addresses are the sum of the base address and offset address. Some parameters are defined using multiple offsets.

The address included in the message of a data set or a data request must be within the value shown in the table below.

Note: A pair of two addresses preceded by the symbol # represents a divided-by-two data. e.g. the data ABH (hex) is divided into 0AH and 0BH and sent in that order.

Note: Parameters associated with address following the symbol % are for JV-80 and invalid with the JV-880.

Example of exclusive data

To set the reverb type of the temporary performance common to "DELAY", send the following data to the JV-880.

FOH	41H	10H	46H	12H	00H	00H	10H	0DH	06H	5DH	F7H
1	2	3	4	5			6		7	8	9

1. Exclusive status
2. Manufacturer ID: Roland = 41H.
3. Device ID: the unit number of the system common parameter minus 1. In this example, the unit number is 17: 17 - 1 = 16 which is expressed as 10H in hexadecimal notation.
4. Model ID of the JV-880 is 46H.
5. Command ID: data set 1 = 12H.
6. Addresses: by referring to Table 1, the start address of the temporary performance = 00H 00H 10H 00H; from Table 1-2, offset address of performance common = 00H 00H; from Table 1-2-1, offset address of reverb type = 0DH. These addresses are added together:

$$\begin{array}{r}
 00H\ 00H\ 10H\ 00H \\
 \quad\quad\quad 00H\ 00H \\
 +) \quad\quad\quad 0DH \\
 \hline
 00H\ 00H\ 10H\ 0DH = \text{target address}
 \end{array}$$

7. The number of "DELAY" is 6: 06H in hexadecimal.
8. Check sum
9. End of exclusive

< MODEL ID = 46H >

Start address	Description	
00 00 00 00	System Common	1-1
00 00 10 00	Temporary Performance	1-2
00 00 20 00	Performance Mode Temporary Patch (Part 1)	1-3
00 01 20 00	Performance Mode Temporary Patch (Part 2)	
00 06 20 00	Performance Mode Temporary Patch (Part 7)	
00 07 40 00	Temporary Rhythm Setup	1-4
00 08 20 00	Patch Mode Temporary Patch	1-3
01 00 10 00	Internal Performance I01	1-2
01 01 10 00	Internal Performance I02	
01 0F 10 00	Internal Performance I16	
01 40 20 00	Internal Patch I01	1-3
01 41 20 00	Internal Patch I02	
01 7F 20 00	Internal Patch I64	
01 7F 40 00	Internal Rhythm Setup	1-4
02 00 10 00	Card Performance C01	1-2
02 01 10 00	Card Performance C02	
02 0F 10 00	Card Performance C16	
02 40 20 00	Card Patch C01	1-3
02 41 20 00	Card Patch C02	
02 7F 20 00	Card Patch C64	
02 7F 40 00	Card Rhythm Setup	1-4

1 - 1 System Common

Offset address	Description	
00 0000 000a	Panel Mode	0 - 1 (PERFORMANSE. PATCH)
01 0aaa aaaa	Master Tune	1 - 127 (427.4 - 452.6)
% 02 0aaa aaaa	Key Transpose	28 - 100
% 03 0000 000a	Transpose Switch	0 - 1
04 0000 000a	Reverb Switch	0 - 1 (OFF, ON)
05 0000 000a	Chorus Switch	0 - 1 (OFF, ON)
% 06 0000 000a	Hold Polarity	0 - 1
% 07 0000 000a	Pedal 1 Polarity	0 - 1
% 08 0000 00aa	Pedal 1 Mode	0 - 3
% 09 0aaa aaaa	Pedal 1 Assign	0 - 100
% 0A 0000 000a	Pedal 2 Polarity	0 - 1
% 0B 0000 00aa	Pedal 2 Mode	0 - 3
% 0C 0aaa aaaa	Pedal 2 Assign	0 - 100
% 0D 0000 00aa	C1 Mode	0 - 3
% 0E 0aaa aaaa	C1 Assign	0 - 100
% 0F 0aaa aaaa	Aftertouch Threshold	0 - 127
MIDI Receive Switch		
10 0000 000a	Volume	0 - 1 (OFF, ON)
11 0000 000a	Control Change	0 - 1 (OFF, ON)
12 0000 000a	Channel Pressure	0 - 1 (OFF, ON)
13 0000 000a	Modulation	0 - 1 (OFF, ON)
14 0000 000a	Pitch Bend	0 - 1 (OFF, ON)
15 0000 000a	Program Change	0 - 1 (OFF, ON)
16 0000 000a	Bank Select	0 - 1 (OFF, ON)
MIDI Transmit Switch		
% 17 0000 000a	Volume	0 - 1
% 18 0000 000a	Control Change	0 - 1
% 19 0000 000a	Channel Pressure	0 - 1
% 1A 0000 000a	Modulation	0 - 1
% 1B 0000 000a	Bender	0 - 1

% 1C 0000 000a	Program Change	0 - 1
% 1D 0000 000a	Bank Select	0 - 1
1E 0000 aaaa	Patch Receive Channel	0 - 15 (1 - 16)
% 1F 000a aaaa	Patch Transmit Channel	0 - 17
20 000a aaaa	Control Channel	0 - 16 (1 - 16, OFF)
21 0000 000a	Output Mode	0 - 1 (OUT2, OUT4)
22 0000 000a	Rhythm Edit Key	0 - 1 (MIDI&INT, INT)
23 0000 0000	Scale Tune Switch	0 - 1 (OFF, ON)
24 0aaa aaaa	Scale Tune Part1 C	0 - 127 (-64 - +63)
25 : :	C#	
26 : :	D	
27 : :	D#	
28 : :	E	
29 : :	F	
2A : :	F#	
2B : :	G	
2C : :	G#	
2D : :	A	
2E : :	A#	
2F : :	B	
30 0aaa aaaa	Scale Tune Part2 C	0 - 127 (-64 - +63)
31 : :	C#	
32 : :	D	
33 : :	D#	
34 : :	E	
35 : :	F	
36 : :	F#	
37 : :	G	
38 : :	G#	
39 : :	A	
3A : :	A#	
3B : :	B	
3C 0aaa aaaa	Scale Tune Part3 C	0 - 127 (-64 - +63)
3D : :	C#	
3E : :	D	
3F : :	D#	
40 : :	E	
41 : :	F	
42 : :	F#	
43 : :	G	
44 : :	G#	
45 : :	A	
46 : :	A#	
47 : :	B	
48 0aaa aaaa	Scale Tune Part4 C	0 - 127 (-64 - +63)
49 : :	C#	
4A : :	D	
4B : :	D#	
4C : :	E	
4D : :	F	
4E : :	F#	
4F : :	G	
50 : :	G#	
51 : :	A	
52 : :	A#	
53 : :	B	
54 0aaa aaaa	Scale Tune Part5 C	0 - 127 (-64 - +63)
55 : :	C#	
56 : :	D	
57 : :	D#	
58 : :	E	
59 : :	F	
5A : :	F#	
5B : :	G	
5C : :	G#	
5D : :	A	
5E : :	A#	
5F : :	B	
60 0aaa aaaa	Scale Tune Part6 C	0 - 127 (-64 - +63)
61 : :	C#	
62 : :	D	
63 : :	D#	
64 : :	E	
65 : :	F	
66 : :	F#	

67	:	:	:	G	
68	:	:	:	G#	
69	:	:	:	A	
6A	:	:	:	A#	
6B	:	:	:	B	
6C	0aaa	aaaa	Scale Tune Part7 C	0 - 127	
				(-64 - +63)	
6D	:	:	:	C#	
6E	:	:	:	D	
6F	:	:	:	D#	
70	:	:	:	E	
71	:	:	:	F	
72	:	:	:	F#	
73	:	:	:	G	
74	:	:	:	G#	
75	:	:	:	A	
76	:	:	:	A#	
77	:	:	:	B	
78	0aaa	aaaa	Scale Tune Part8 C	0 - 127	
				(-64 - +63)	
79	:	:	:	C#	
7A	:	:	:	D	
7B	:	:	:	D#	
7C	:	:	:	E	
7D	:	:	:	F	
7E	:	:	:	F#	
7F	:	:	:	G	
01 00	:	:	:	G#	
01 01	:	:	:	A	
01 02	:	:	:	A#	
01 03	:	:	:	B	
01 04	0aaa	aaaa	Scale Tune Patch C	0 - 127	
				(-64 - +63)	
01 05	:	:	:	C#	
01 06	:	:	:	D	
01 07	:	:	:	D#	
01 08	:	:	:	E	
01 09	:	:	:	F	
01 0A	:	:	:	F#	
01 0B	:	:	:	G	
01 0C	:	:	:	G#	
01 0D	:	:	:	A	
01 0E	:	:	:	A#	
01 0F	:	:	:	B	
Total Size					00 00 01 10

/Example of RQ1 application /

To get the all data of the system common, send the following data to the JV - 880. (The JV - 880 ignores parameters associated with address following the symbol %.)

F0H 41H 10H 46H 11H 00H 00H 00H 00H 00H 01H 10H 6FH F7H

/Example of DT1 application /

To set the control channel of system common to 1, send following data to the JV - 880.

F0H 41H 10H 46H 12H 00H 00H 00H 20H 00H 60H F7H

1 - 2 Performance

Offset	address	Description	
00 00		Performance Common	1-2-1
08 00		Performance Part 1	1-2-2
09 00		Performance Part 2	
0A 00		Performance Part 3	
0B 00		Performance Part 4	
0C 00		Performance Part 5	
0D 00		Performance Part 6	
0E 00		Performance Part 7	
0F 00		Performance Part 8	

1 - 2 - 1 Performance Common

Offset	address	Description	
00	0aaa	aaaa	Performance Name 1 32 - 127
01	0aaa	aaaa	Performance Name 2 32 - 127
:	:	:	:
0B	0aaa	aaaa	Performance Name 12 32 - 127
%	0C	0000 00aa	Key Mode 0 - 2
0D	0000	0aaa	Reverb Type 0 - 7
			(ROOM1, ROOM2, STAGE1, STAGE2, HALL1, HALL2, DELAY, PAN-DLY)
0E	0aaa	aaaa	Reverb Level 0 - 127
0F	0aaa	aaaa	Reverb Time 0 - 127
10	0aaa	aaaa	Reverb Feedback 0 - 127
11	0000	00aa	Chorus Type 0 - 2
			(CHORUS1, CHORUS2, CHORUS3)
12	0aaa	aaaa	Chorus Level 0 - 127
13	0aaa	aaaa	Chorus Depth 0 - 127
14	0aaa	aaaa	Chorus Rate 0 - 127
15	0aaa	aaaa	Chorus Feedback 0 - 127
16	0000	000a	Chorus Output 0 - 1
			(MIX, REV)
17	000a	aaaa	Part 1 Voice Reserve 0 - 28
18	000a	aaaa	Part 2 Voice Reserve 0 - 28
:	:	:	:
1E	000a	aaaa	Part 8 Voice Reserve 0 - 28
Total Size 00 00 00 1F			

Note: The sum of voice receives must be less than or equal 28.

/Example of RQ1 application /

To get the performance name data of performance I-01, send the following data to the JV - 880.

F0H 41H 10H 46H 11H 01H 00H 10H 00H 00H 00H 00H 0CH 63H F7H

The performance name data returned in response to this request are expressed in ASCII characters of hexadecimal.

/Example of DT1 application /

To set the reverb type of Performance I-08 to "HALL2", send the following data to the JV - 880.

F0H 41H 10H 46H 12H 01H 07H 10H 0DH 05H 56H F7H

1 - 2 - 2 Performance Part

Offset	address	Description	
%	00	0000 000a	Transmit Switch 0 - 1
%	01	0000 aaaa	Transmit Channel 0 - 15
##	02	0000 aaaa	Transmit Program Change 0 - 128
		0000 bbbb	
##	04	0000 aaaa	Transmit Volume 0 - 128
		0000 bbbb	
##	06	0000 aaaa	Transmit Pan 0 - 128
		0000 bbbb	
%	08	0aaa aaaa	Transmit Key Range Lower 0 - 127
%	09	0aaa aaaa	Transmit Key Range Upper 0 - 127
%	0A	0aaa aaaa	Transmit Key Transpose 28 - 100
%	0B	0aaa aaaa	Transmit Velocity Sense 1 - 127
%	0C	0aaa aaaa	Transmit Velocity Max 0 - 127
%	0D	0000 0aaa	Transmit Velocity Curve 0 - 6
%	0E	0000 000a	Internal Switch 0 - 1
%	0F	0aaa aaaa	Internal Key Range Lower 0 - 127
%	10	0aaa aaaa	Internal Key Range Upper 0 - 127
%	11	0aaa aaaa	Internal Key Transpose 28 - 100
%	12	0aaa aaaa	Internal Velocity Sense 1 - 127
%	13	0aaa aaaa	Internal Velocity Max 0 - 127
%	14	0000 0aaa	Internal Velocity Curve 0 - 6
	15	0000 000a	Receive Switch 0 - 1
			(OFF, ON)
	16	0000 aaaa	Receive Channel 0 - 15
			(1 - 16)
##	17	0000 aaaa	Patch Number 0 - 255
		0000 bbbb	(I01 - I64, C01 - C64, A01 - A64, B01 - B64)
	19	0aaa aaaa	Part Level 0 - 127

1A	0aaa aaaa	Part Pan	0 - 127 (L64 - 63R)
1B	0aaa aaaa	Part Coarse Tune	16 - 112 (-48 - +48)
1C	0aaa aaaa	Part Fine Tune	14 - 114 (-50 - +50)
1D	0000 000a	Reverb Switch	0 - 1 (OFF, ON)
1E	0000 000a	Chorus Switch	0 - 1 (OFF, ON)
1F	0000 000a	Receive Program Change	0 - 1 (OFF, ON)
20	0000 000a	Receive Volume	0 - 1 (OFF, ON)
21	0000 000a	Receive Hold-1	0 - 1 (OFF, ON)
22	0000 00aa	Output Select	0 - 2 (MN, SB, PAT)

Total Size	00 00 00 23		

/Example of RQ1 application /

To get the all data of the performance I-03 part3, send the following data to the JV-880.
FOH 41H 10H 46H 11H 01H 02H 1AH 00H 00H 00H 00H 23H 40H F7H

/Example of DT1 application /

To mute (receive switch = off) the part 1 of the temporary performance, send the following data to the JV-880.
FOH 41H 10H 46H 12H 00H 00H 18H 15H 00H 53H F7H

1 - 3 Patch

Offset	address	Description	
00 00	Patch Common		1-3-1
08 00	Patch Tone 1		1-3-2
09 00	Patch Tone 2		
0A 00	Patch Tone 3		
0B 00	Patch Tone 4		

1 - 3 - 1 Patch Common

Offset	address	Description	
00	0aaa aaaa	Patch Name 1	32 - 127
01	0aaa aaaa	Patch Name 2	32 - 127
:	:	:	:
0B	0aaa aaaa	Patch Name 12	32 - 127
0C	0000 000a	Velocity Switch	0 - 1 (OFF, ON)

0D	0000 0aaa	Reverb Type	0 - 7 (ROOM1, ROOM2, STAGE1, STAGE2, HALL1, HALL2, DELAY, PAN-DLY)
0E	0aaa aaaa	Reverb Level	0 - 127
0F	0aaa aaaa	Reverb Time	0 - 127
10	0aaa aaaa	Delay Feedback	0 - 127

11	0000 00aa	Chorus Type	0 - 2 (CHORUS1, CHORUS2, CHORUS3)
12	0aaa aaaa	Chorus Level	0 - 127
13	0aaa aaaa	Chorus Depth	0 - 127
14	0aaa aaaa	Chorus Rate	0 - 127
15	0aaa aaaa	Chorus Feedback	0 - 127
16	0000 000a	Chorus Output	0 - 1 (MIX, REV)

17	0aaa aaaa	Analog Feel	0 - 127
18	0aaa aaaa	Patch Level	0 - 127
19	0aaa aaaa	Patch Pan	0 - 127

1A	0aaa aaaa	Bend Range Down	16 - 64 (-48 - 0)
1B	0000 aaaa	Bend Range Up	0 - 12
1C	0000 000a	Key Assign	0 - 1 (POLY, SOLO)
1D	0000 000a	Solo Legato	0 - 1 (OFF, ON)
1E	0000 000a	Portamento Switch	0 - 1 (OFF, ON)

1F	0000 000a	Portamento Mode	0 - 1 (LEGATO, NORMAL)
20	0000 000a	Portamento Type	0 - 1 (TIME, RATE)
21	0aaa aaaa	Portamento Time	0 - 127

Total Size	00 00 00 22		

/Example of RQ1 application /

To get the value of the portamento time of the patch temporary, send the following data to the JV-880.
FOH 41H 10H 46H 11H 00H 08H 20H 21H 00H 00H 00H 01H 36H F7H

/Example of DT1 application /

To set the chorus type of Patch I48 to "CHORUS3", send the following data to the JV-880.
FOH 41H 10H 46H 12H 01H 6FH 20H 11H 02H 5DH F7H

1 - 3 - 2 Patch Tone

Offset	address	Description	
00	0000 00aa	Wave Group	0 - 2 (INT, EXP, PCM)
01	0000 aaaa	Wave Number	0 - 254 (1 - 255)
03	0000 000a	Tone Switch	0 - 1 (OFF, ON)
04	0000 000a	FXM Switch	0 - 1 (OFF, ON)
05	0000 aaaa	FXM Depth	0 - 15 (1 - 16)

06	0aaa aaaa	Velocity Range Lower	0 - 127
07	0aaa aaaa	Velocity Range Upper	0 - 127

08	0000 000a	Volume Switch	0 - 1 (OFF, ON)
09	0000 000a	Hold-1 Switch	0 - 1 (OFF, ON)
0A	0000 aaaa	Modulation Destination 1	0 - 12 (OFF, PITCH, CUTOFF, RESONANCE, LEVEL, PITCH LFO1, PITCH LFO2, TVF LFO1, TVF LFO2, TVA LFO1, TVA LFO2, LFO1 RATE, LFO2 RATE)
0B	0aaa aaaa	Modulation Sense 1	1 - 127 (-63 - +63)
0C	0000 aaaa	Modulation Destination 2	0 - 12 (OFF, PITCH, CUTOFF, RESONANCE, LEVEL, PITCH LFO1, PITCH LFO2, TVF LFO1, TVF LFO2, TVA LFO1, TVA LFO2, LFO1 RATE, LFO2 RATE)
0D	0aaa aaaa	Modulation Sense 2	1 - 127 (-63 - +63)
0E	0000 aaaa	Modulation Destination 3	0 - 12 (OFF, PITCH, CUTOFF, RESONANCE, LEVEL, PITCH LFO1, PITCH LFO2, TVF LFO1, TVF LFO2, TVA LFO1, TVA LFO2, LFO1 RATE, LFO2 RATE)
0F	0aaa aaaa	Modulation Sense 3	1 - 127 (-63 - +63)
10	0000 aaaa	Modulation Destination 4	0 - 12 (OFF, PITCH, CUTOFF, RESONANCE, LEVEL, PITCH LFO1, PITCH LFO2, TVF LFO1, TVF LFO2, TVA LFO1, TVA LFO2, LFO1 RATE, LFO2 RATE)
11	0aaa aaaa	Modulation Sense 4	1 - 127 (-63 - +63)
12	0000 aaaa	Aftertouch Destination 1	0 - 12 (OFF, PITCH, CUTOFF, RESONANCE, LEVEL, PITCH LFO1, PITCH LFO2, TVF LFO1, TVF LFO2, TVA LFO1, TVA LFO2, LFO1 RATE, LFO2 RATE)
13	0aaa aaaa	Aftertouch Sense 1	1 - 127 (-63 - +63)
14	0000 aaaa	Aftertouch Destination 2	0 - 12 (OFF, PITCH, CUTOFF, RESONANCE, LEVEL, PITCH LFO1, PITCH LFO2, TVF LFO1, TVF LFO2, TVA LFO1, TVA LFO2, LFO1 RATE, LFO2 RATE)
15	0aaa aaaa	Aftertouch Sense 2	1 - 127 (-63 - +63)

16	0000	aaaa	Aftertouch Destination 3	0 - 12	(OFF, PITCH, CUTOFF, RESONANCE, LEVEL, PITCH LFO1, PITCH LFO2, TVF LFO1, TVF LFO2, TVA LFO1, TVA LFO2, LFO1 RATE, LFO2 RATE)
17	0aaa	aaaa	Aftertouch Sense 3	1 - 127	(-63 - +63)
18	0000	aaaa	Aftertouch Destination 4	0 - 12	(OFF, PITCH, CUTOFF, RESONANCE, LEVEL, PITCH LFO1, PITCH LFO2, TVF LFO1, TVF LFO2, TVA LFO1, TVA LFO2, LFO1 RATE, LFO2 RATE)
19	0aaa	aaaa	Aftertouch Sense 4	1 - 127	(-63 - +63)
1A	0000	aaaa	Expression Destination 1	0 - 12	(OFF, PITCH, CUTOFF, RESONANCE, LEVEL, PITCH LFO1, PITCH LFO2, TVF LFO1, TVF LFO2, TVA LFO1, TVA LFO2, LFO1 RATE, LFO2 RATE)
1B	0aaa	aaaa	Expression Sense 1	1 - 127	(-63 - +63)
1C	0000	aaaa	Expression Destination 2	0 - 12	(OFF, PITCH, CUTOFF, RESONANCE, LEVEL, PITCH LFO1, PITCH LFO2, TVF LFO1, TVF LFO2, TVA LFO1, TVA LFO2, LFO1 RATE, LFO2 RATE)
1D	0aaa	aaaa	Expression Sense 2	1 - 127	(-63 - +63)
1E	0000	aaaa	Expression Destination 3	0 - 12	(OFF, PITCH, CUTOFF, RESONANCE, LEVEL, PITCH LFO1, PITCH LFO2, TVF LFO1, TVF LFO2, TVA LFO1, TVA LFO2, LFO1 RATE, LFO2 RATE)
1F	0aaa	aaaa	Expression Sense 3	1 - 127	(-63 - +63)
20	0000	aaaa	Expression Destination 4	0 - 12	(OFF, PITCH, CUTOFF, RESONANCE, LEVEL, PITCH LFO1, PITCH LFO2, TVF LFO1, TVF LFO2, TVA LFO1, TVA LFO2, LFO1 RATE, LFO2 RATE)
21	0aaa	aaaa	Expression Sense 4	1 - 127	(-63 - +63)
22	0000	0aaa	LFO-1 Form	0 - 5	(TRI, SIN, SAW, SQR, RND1, RND2)
23	0000	0aaa	LFO-1 Offset	0 - 4	(-100, -50, 0, +50, +100)
24	0000	000a	LFO-1 Synchro	0 - 1	(OFF, ON)
25	0aaa	aaaa	LFO-1 Rate	0 - 127	
26	0000	aaaa	LFO-1 Delay	0 - 128	(0 - 127, KEY-OFF)
28	0000	000a	LFO-1 Fade Polarity	0 - 1	(IN, OUT)
29	0aaa	aaaa	LFO-1 Fade Time	0 - 127	
2A	0aaa	aaaa	LFO-1 Pitch Depth	4 - 124	(-600 - +600)
2B	0aaa	aaaa	LFO-1 TVF Depth	1 - 127	(-63 - +63)
2C	0aaa	aaaa	LFO-1 TVA Depth	1 - 127	(-63 - +63)
2D	0000	0aaa	LFO-2 Form	0 - 5	(TRI, SIN, SAW, SQR, RND1, RND2)
2E	0000	0aaa	LFO-2 Offset	0 - 4	(-100, -50, 0, +50, +100)
2F	0000	000a	LFO-2 Synchro	0 - 1	(OFF, ON)
30	0aaa	aaaa	LFO-2 Rate	0 - 127	
31	0000	aaaa	LFO-2 Delay	0 - 128	(0 - 127, KEY-OFF)
33	0000	000a	LFO-2 Fade Polarity	0 - 1	(IN, OUT)
34	0aaa	aaaa	LFO-2 Fade Time	0 - 127	
35	0aaa	aaaa	LFO-2 Pitch Depth	4 - 124	(-600 - +600)
36	0aaa	aaaa	LFO-2 TVF Depth	1 - 127	(-63 - +63)
37	0aaa	aaaa	LFO-2 TVA Depth	1 - 127	(-63 - +63)
38	0aaa	aaaa	Pitch Coarse	16 - 112	(-48 - +48)
39	0aaa	aaaa	Pitch Fine	14 - 114	(-50 - +50)
3A	0000	aaaa	Random Pitch Depth	0 - 15	(0, 5, 10, 20, 30, 40, 50, 70, 100)

				200, 300, 400, 500, 600, 800, 1200)	
3B	0000	aaaa	Pitch Key Follow	0 - 15	(-100, -70, -50, -30, -10, 0, +10, +20, +30, +40, +50, +70, +100, +120, +150, +200)
3C	0aaa	aaaa	P-ENV Velocity Level Sense	1 - 127	(-63 - +63)
3D	0000	aaaa	P-ENV Velocity On Time Sense	0 - 14	(-100, -70, -50, -40, -30, -20, -10, 0, +10, +20, +30, +40, +50, +70, +100)
3E	0000	aaaa	P-ENV Velocity Off Time Sense	0 - 14	(-100, -70, -50, -40, -30, -20, -10, 0, +10, +20, +30, +40, +50, +70, +100)
3F	0000	aaaa	P-ENV Time Key Follow	0 - 14	(-100, -70, -50, -40, -30, -20, -10, 0, +10, +20, +30, +40, +50, +70, +100)
40	0aaa	aaaa	P-ENV Depth	52 - 76	(-12 - +12)
41	0aaa	aaaa	P-ENV Time 1	0 - 127	
42	0aaa	aaaa	P-ENV Level 1	1 - 127	(-63 - +63)
43	0aaa	aaaa	P-ENV Time 2	0 - 127	
44	0aaa	aaaa	P-ENV Level 2	1 - 127	(-63 - +63)
45	0aaa	aaaa	P-ENV Time 3	0 - 127	
46	0aaa	aaaa	P-ENV Level 3	1 - 127	(-63 - +63)
47	0aaa	aaaa	P-ENV Time 4	0 - 127	
48	0aaa	aaaa	P-ENV Level 4	1 - 127	(-63 - +63)
49	0000	00aa	Filter Mode	0 - 2	(OFF, LPF, HPF)
4A	0aaa	aaaa	Cutoff Frequency	0 - 127	
4B	0aaa	aaaa	Resonance	0 - 127	
4C	0000	000a	Resonance Mode	0 - 1	(SOFT, HARD)
4D	0000	aaaa	Cutoff Key Follow	0 - 15	(-100, -70, -50, -30, -10, 0, +10, +20, +30, +40, +50, +70, +100, +120, +150, +200)
4E	0000	0aaa	TVF-ENV Velocity Curve	0 - 6	(1 - 7)
4F	0aaa	aaaa	TVF-ENV Velocity Level Sense	1 - 127	(-63 - +63)
50	0000	aaaa	TVF-ENV Velocity On Time Sense	0 - 14	(-100, -70, -50, -40, -30, -20, -10, 0, +10, +20, +30, +40, +50, +70, +100)
51	0000	aaaa	TVF-ENV Velocity Off Time Sense	0 - 14	(-100, -70, -50, -40, -30, -20, -10, 0, +10, +20, +30, +40, +50, +70, +100)
52	0000	aaaa	TVF-ENV Time Key Follow	0 - 14	(-100, -70, -50, -40, -30, -20, -10, 0, +10, +20, +30, +40, +50, +70, +100)
53	0aaa	aaaa	TVF-ENV Depth	1 - 127	(-63 - +63)
54	0aaa	aaaa	TVF-ENV Time 1	0 - 127	
55	0aaa	aaaa	TVF-ENV Level 1	0 - 127	
56	0aaa	aaaa	TVF-ENV Time 2	0 - 127	
57	0aaa	aaaa	TVF-ENV Level 2	0 - 127	
58	0aaa	aaaa	TVF-ENV Time 3	0 - 127	
59	0aaa	aaaa	TVF-ENV Level 3	0 - 127	
5A	0aaa	aaaa	TVF-ENV Time 4	0 - 127	
5B	0aaa	aaaa	TVF-ENV Level 4	0 - 127	
5C	0aaa	aaaa	Level	0 - 127	
5D	0000	aaaa	Level Key Follow	0 - 14	(-100, -70, -50, -40, -30, -20, -10, 0, +10, +20, +30, +40, +50, +70, +100)
5E	0000	aaaa	Pan	0 - 128	(L64 - 63R, RND)
60	0000	aaaa	Panning Key Follow	0 - 14	(-100, -70, -50, -40, -30, -20, -10, 0, +10, +20, +30, +40, +50, +70, +100)
61	0000	00aa	Tone Delay Mode	0 - 2	(NORMAL, HOLD, PLAY-MATE)
62	0000	aaaa	Tone Delay Time	0 - 128	(0 - 127, KEY-OFF)
64	0000	0aaa	TVA-ENV Velocity Curve	0 - 6	(1 - 7)
65	0aaa	aaaa	TVA-ENV Velocity Level Sense	1 - 127	(-63 - +63)
66	0000	aaaa	TVA-ENV Velocity On Time Sense	0 - 14	(-100, -70, -50, -40, -30, -20, -10, 0, +10, +20, +30, +40, +50, +70, +100)
67	0000	aaaa	TVA-ENV Velocity Off Time Sense	0 - 14	(-100, -70, -50, -40, -30, -20, -10, 0, +10, +20, +30, +40, +50, +70, +100)

68	0000 aaaa	TVA-ENV Time Key Follow	0 - 14	-1
			(-100, -70, -50, -40, -30, -20, -10, 0, +10, +20, +30, +40, +50, +70, +100)	
69	Oaaa aaaa	TVA-ENV Time 1	0 - 127	
6A	Oaaa aaaa	TVA-ENV Level 1	0 - 127	
6B	Oaaa aaaa	TVA-ENV Time 2	0 - 127	
6C	Oaaa aaaa	TVA-ENV Level 2	0 - 127	
6D	Oaaa aaaa	TVA-ENV Time 3	0 - 127	
6E	Oaaa aaaa	TVA-ENV Level 3	0 - 127	
6F	Oaaa aaaa	TVA-ENV Time 4	0 - 127	

70	Oaaa aaaa	Dry Level	0 - 127	
71	Oaaa aaaa	Reverb Send Level	0 - 127	
72	Oaaa aaaa	Chorus Send Level	0 - 127	
73	0000 000a	Output Select	0 - 1	
			(MAIN, SUB)	

Total Size | 00 00 00 74

Note : If the value of the wave number surpasses the number of waves contained in the corresponding wave group, this message will be ignore.

Note : If the value of the velocity range lower is greater than that of the velocity range upper, this message will be ignore.

/ Example of RQ1 application /

To get the all tone data of the Patch I09, send the following data to the JV-880.
FOH 41H 10H 46H 11H 01H 48H 28H 00H 00H 00H 03H 53H 39H F7H

/ Example of DT1 application /

To set the WG wave number of the temporary patch tone2 to "128 REV Maracas", send the following data to the JV-880.
FOH 41H 10H 46H 12H 00H 08H 29H 00H 00H 07H 0FH 39H F7H

1 - 4 Rhythm Setup

Offset	address	Description	
00 00		Rhythm Note for Key# 36 (C 2)	1-4-1
01 00		37 (C#2)	
02 00		38 (D 2)	
03 00		39 (D#2)	
04 00		40 (E 2)	
05 00		41 (F 2)	
06 00		42 (F#2)	
07 00		43 (G 2)	
08 00		44 (G#2)	
09 00		45 (A 2)	
0A 00		46 (A#2)	
0B 00		47 (B 2)	
0C 00		48 (C 3)	
0D 00		49 (C#3)	
0E 00		50 (D 3)	
0F 00		51 (D#3)	
10 00		52 (E 3)	
11 00		53 (F 3)	
12 00		54 (F#3)	
13 00		55 (G 3)	
14 00		56 (G#3)	
15 00		57 (A 3)	
16 00		58 (A#3)	
17 00		59 (B 3)	
18 00		60 (C 4)	
19 00		61 (C#4)	
1A 00		62 (D 4)	
1B 00		63 (D#4)	
1C 00		64 (E 4)	
1D 00		65 (F 4)	
1E 00		66 (F#4)	
1F 00		67 (G 4)	
20 00		68 (G#4)	
21 00		69 (A 4)	
22 00		70 (A#4)	
23 00		71 (B 4)	
24 00		72 (C 5)	
25 00		73 (C#5)	
26 00		74 (D 5)	
27 00		75 (D#5)	
28 00		76 (E 5)	
29 00		77 (F 5)	
2A 00		78 (F#5)	
2B 00		79 (G 5)	
2C 00		80 (G#5)	
2D 00		81 (A 5)	
2E 00		82 (A#5)	

2F 00			83 (B 5)
30 00			84 (C 6)
31 00			85 (C#6)
32 00			86 (D 6)
33 00			87 (D#6)
34 00			88 (E 6)
35 00			89 (F 6)
36 00			90 (F#6)
37 00			91 (G 6)
38 00			92 (G#6)
39 00			93 (A 6)
3A 00			94 (A#6)
3B 00			95 (B 6)
3C 00			96 (C 7)

1 - 4 - 1 Rhythm Note

Offset	address	Description	
00	0000 00aa	Wave Group	0 - 2 (INT, EXP, PCM)
01	0000 aaaa	Wave Number	0 - 254
	0000 bbbb		(1 - 255)
03	0000 000a	Tone Switch	0 - 1 (OFF, ON)
04	Oaaa aaaa	Coarse Tune	0 - 127 (C-1 - G9)
05	000a aaaa	Mute Group	0 - 31 (OFF, 1 - 31)
06	0000 000a	Envelope Mode	0 - 1 (NO-SUSTAIN, SUSTAIN)

07	Oaaa aaaa	Pitch Fine	14 - 114 (-50 - +50)
08	0000 aaaa	Random Pitch Depth	0 - 15 (0, 5, 10, 20, 30, 40, 50, 70, 100, 200, 300, 400, 500, 600, 800, 1200)
09	0000 aaaa	Pitch Bend Range	0 - 12
0A	Oaaa aaaa	P-ENV Velocity Level Sense	1 - 127 (-63 - +63)
0B	0000 aaaa	P-ENV Velocity Time Sense	0 - 14 (-100, -70, -50, -40, -30, -20, -10, 0, +10, +20, +30, +40, +50, +70, +100)
0C	Oaaa aaaa	P-ENV Depth	52 - 76 (-12 - +12)
0D	Oaaa aaaa	P-ENV Time 1	0 - 127
0E	Oaaa aaaa	P-ENV Level 1	1 - 127 (-63 - +63)
0F	Oaaa aaaa	P-ENV Time 2	0 - 127
10	Oaaa aaaa	P-ENV Level 2	1 - 127 (-63 - +63)
11	Oaaa aaaa	P-ENV Time 3	0 - 127
12	Oaaa aaaa	P-ENV Level 3	1 - 127 (-63 - +63)
13	Oaaa aaaa	P-ENV Time 4	0 - 127
14	Oaaa aaaa	P-ENV Level 4	1 - 127 (-63 - +63)

15	0000 00aa	Filter Mode	0 - 2 (OFF, LPF, HPF)
16	Oaaa aaaa	Cutoff	0 - 127
17	Oaaa aaaa	Resonance	0 - 127
18	0000 000a	Resonance Mode	0 - 1 (SOFT, HARD)
19	Oaaa aaaa	TVF-ENV Velocity Level Sense	1 - 127 (-63 - +63)
1A	0000 aaaa	TVF-ENV Velocity Time Sense	0 - 14 (-100, -70, -50, -40, -30, -20, -10, 0, +10, +20, +30, +40, +50, +70, +100)
1B	Oaaa aaaa	TVF-ENV Depth	1 - 127 (-63 - +63)
1C	Oaaa aaaa	TVF-ENV Time 1	0 - 127
1D	Oaaa aaaa	TVF-ENV Level 1	0 - 127
1E	Oaaa aaaa	TVF-ENV Time 2	0 - 127
1F	Oaaa aaaa	TVF-ENV Level 2	0 - 127
20	Oaaa aaaa	TVF-ENV Time 3	0 - 127
21	Oaaa aaaa	TVF-ENV Level 3	0 - 127
22	Oaaa aaaa	TVF-ENV Time 4	0 - 127
23	Oaaa aaaa	TVF-ENV Level 4	0 - 127

24	Oaaa aaaa	Level	0 - 127
#	0000 aaaa	Pan	0 - 128
	0000 bbbb		(L64 - 63R, RND)
27	Oaaa aaaa	TVA-ENV Velocity Level Sense	1 - 127

				(-63 - +63)
28	0000	aaaa	TVA-ENV Velocity Time Sense	0 - 14 (-100, -70, -50, -40, -30, -20, -10, 0, +10, +20, +30, +40, +50, +70, +100)
29	0aaa	aaaa	TVA-ENV Time 1	0 - 127
2A	0aaa	aaaa	TVA-ENV Level 1	0 - 127
2B	0aaa	aaaa	TVA-ENV Time 2	0 - 127
2C	0aaa	aaaa	TVA-ENV Level 2	0 - 127
2D	0aaa	aaaa	TVA-ENV Time 3	0 - 127
2E	0aaa	aaaa	TVA-ENV Level 3	0 - 127
2F	0aaa	aaaa	TVA-ENV Time 4	0 - 127

30	0aaa	aaaa	Dry Level	0 - 127
31	0aaa	aaaa	Reverb Send Level	0 - 127
32	0aaa	aaaa	Chorus Send Level	0 - 127
33	0000	000a	Output Select	0 - 1 (MAIN, SUB)

Total Size	00	00	00	34

Note: If the value of the Wave Number surpasses the number of waves contained in the corresponding Wave Group, this message will be ignore.

/ Example of RQ1 application /

To get the C4 note data of the temporary rhythm setup, send the following data to the JV-880.

FOH 41H 10H 46H 11H 00H 07H 58H 00H 00H 00H 00H 34H 6DH F7H

/ Example of DT1 application /

To turn off (WG tone switch = off) the key note D2 of the rhythm set up (part 8) of the temporary selected performance, send the following data to the JV-880.

FOH 41H 10H 46H 12H 00H 07H 42H 03H 00H 34H F7H

----- Address Map -----				
Address	Block	Sub Block	Reference	
00 00 00 00	System Common			1-1
00 00 10 00	Temporary Performance	Common		1-2-1
		Part 1		1-2-2
		:		
		Part 8		
00 00 20 00	Performance Mode Temporary Patch	Part 1	Common	1-3-1
		:		
		Tone 1		1-3-2
		:		
		Part 7		
		:		
		Tone 4		
00 07 40 00	Temporary Rhythm Setup	Note# 36		1-4-1
		:		
		Note# 96		
00 08 20 00	Patch Mode Temporary Patch	Common		1-3-1
		Tone 1		1-3-2
		:		
		Tone 4		
01 00 10 00	Internal Memory Performance	I01	Common	1-2-1
		:		
		I16	Part 1	1-2-2
		:		
		Part 8		
01 40 20 00	Internal Memory Patch	I11	Common	1-3-1
		:		
		I88	Tone 1	1-3-2
		:		
		Tone 4		
01 7F 40 00	Internal Memory Rhythm Setup	Note# 36		1-4-1
		:		
		Note# 96		
02 00 10 00	Card Memory Performance	C01	Common	1-2-1
		:		
		C16	Part 1	1-2-2
		:		
		Part 8		
02 40 20 00	Card Memory Patch	C11	Common	1-3-1
		:		
		C88	Tone 1	1-3-1
		:		
		Tone 4		
02 7F 40 00	Card Memory Rhythm Setup	Note# 36		1-4-1
		:		
		Note# 96		

< MODEL ID = 42H >

Start address	Description
40 10 40	Scale Tune Part8 2-1
40 11 40	: Part1
40 12 40	: Part2
40 13 40	: Part3
40 14 40	: Part4
40 15 40	: Part5
40 16 40	: Part6
40 17 40	: Part7

2 - 1 Scale Tune

Offset address	Description
00 0aaa aaaa	Scale Tune C 00 - 127 (-64 - +63)
01 :	C#
02 :	D
03 :	D#
04 :	E
05 :	F
06 :	F#
07 :	G
08 :	G#
09 :	A
0A :	A#
0B :	B
Total Size 00 00 00 0C	

Note: If you send the scale tune data, must send from "C" to "B" (1 oct) per packet.

/Example of DT1 application /

To set the scale tune (C-B) of the performance part 1 Arabian, send the data as follows:

FOH 41H 10H 42H 12H 40H 11H 40H 3AH 13H 3EH 34H 0DH 38H 6BH 3CH 6FH 40H 36H 0FH 50H F7H

● Table A - 1 : Decimal to Hexadecimal

The MIDI messages are expressed in hexadecimal configured in 7 bits. This table is useful when you read or write MIDI messages.

(D) = decimal

(H) = hexadecimal

(D)	(H)	(D)	(H)	(D)	(H)	(D)	(H)
0	00H	32	20H	64	40H	96	60H
1	01H	33	21H	65	41H	97	61H
2	02H	34	22H	66	42H	98	62H
3	03H	35	23H	67	43H	99	63H
4	04H	36	24H	68	44H	100	64H
5	05H	37	25H	69	45H	101	65H
6	06H	38	26H	70	46H	102	66H
7	07H	39	27H	71	47H	103	67H
8	08H	40	28H	72	48H	104	68H
9	09H	41	29H	73	49H	105	69H
10	0AH	42	2AH	74	4AH	106	6AH
11	0BH	43	2BH	75	4BH	107	6BH
12	0CH	44	2CH	76	4CH	108	6CH
13	0DH	45	2DH	77	4DH	109	6DH
14	0EH	46	2EH	78	4EH	110	6EH
15	0FH	47	2FH	79	4FH	111	6FH
16	10H	48	30H	80	50H	112	70H
17	11H	49	31H	81	51H	113	71H
18	12H	50	32H	82	52H	114	72H
19	13H	51	33H	83	53H	115	73H
20	14H	52	34H	84	54H	116	74H
21	15H	53	35H	85	55H	117	75H
22	16H	54	36H	86	56H	118	76H
23	17H	55	37H	87	57H	119	77H
24	18H	56	38H	88	58H	120	78H
25	19H	57	39H	89	59H	121	79H
26	1AH	58	3AH	90	5AH	122	7AH
27	1BH	59	3BH	91	5BH	123	7BH
28	1CH	60	3CH	92	5CH	124	7CH
29	1DH	61	3DH	93	5DH	125	7DH
30	1EH	62	3EH	94	5EH	126	7EH
31	1FH	63	3FH	95	5FH	127	7FH

* The decimal value of MIDI channel, bank select, program change, etc is the decimal number in the table plus 1.

* In the hexadecimal notation in configured 7 bits, the maximum data of 1 byte is 128. If the data is more than 128, used plural bytes.

* The signed value is 00H = -64, 40H ± 0, 7FH = +63. In decimal notation, the value is the decimal number in the table minus 64.

The signed value of dual bytes is 00 00H = -8192, 40 00H = ±0, 7F 7FH = +8191. For example, converted aa bbH (hex) to decimal to the following: aa bbH - 40 00H = aa x 128 + bb - 64 x 128.

● Table A - 2 : ASCII code

Patch Name and Performance Name of MIDI data are described the ASCII code in the table below.

(H) = hexadecimal

Character (H)	Character (H)	Character (H)
SP	20H	
A	41H	a
B	42H	b
C	43H	c
D	44H	d
E	45H	e
F	46H	f
G	47H	g
H	48H	h
I	49H	i
J	4AH	j
K	4BH	k
L	4CH	l
M	4DH	m
N	4EH	n
O	4FH	o
P	50H	p
Q	51H	q
R	52H	r
S	53H	s
T	54H	t
U	55H	u
V	56H	v
W	57H	w
X	58H	x
Y	59H	y
Z	5AH	z
1	61H	
2	62H	
3	63H	
4	64H	
5	65H	
6	66H	
7	67H	
8	68H	
9	69H	
0	6AH	
+	6BH	
-	6CH	
*	6DH	
/	6EH	
#	6FH	
!	70H	
.	71H	
,	72H	
	73H	
	74H	
	75H	
	76H	
	77H	
	78H	
	79H	
	7AH	

Note: "SP" is space.

MIDI Implementation Chart

Function ...		Transmitted	Recognized	Remarks
Basic Channel	Default	×	1-16	Stored
	Changed	×	1-16	
Mode	Default	×	Mode 3	* 2
	Messages	×	Mode 3, 4 (M=1)	
	Altered	*****		
Note Number	True Voice	×	0-127	
		*****	0-127	
Velocity	Note ON	×	○	
	Note OFF	×	○	
After Touch	Key's	×	×	
	Ch's	×	○ * 1	
Pitch Bend		×	○	9 bit resolution
Control Change	0, 32	×	○ (MSB only) * 1	Bank Select
	1	×	○ * 1	Modulation
	5	×	○ * 1	Portamento Time
	6, 38	×	○ * 1	Data entry (MSB LSB)
	7	×	○ * 1	Volume
	10	×	○○ * 1	Pan
	11	×	○○○ * 1	Expression
	64	×	○○○ * 1	Hold 1
	65	×	○○○ * 1	Portamento
	91	×	○ * 1	Effect 1 Depth (Reverb)
	93	×	○ * 1	Effect 3 Depth (Chorus)
	100, 101	×	○	RPN LSB, MSB
	121	×	○	Reset All Controllers
Prog Change	True #	×	○ * 1	
		*****	0-127	Program Number 1-128
System Exclusive		○	○ * 1	
System Common	Song Pos	×	×	
	Song Sel	×	×	
	Tune	×	×	
System Real Time	Clock	×	×	
	Commands	×	×	
Aux Messages	Local ON/OFF	×	×	
	All Notes OFF	×	○ (123-127)	
	Active Sense	×	○	
	Reset	×	×	

Notes

- * 1 ○, × is selectable.
- * 2 Recognize as M=1 even if M≠1.

SPECIFICATIONS

JV-880 : Multi timbral synthesizer module

● Part

Part1 - 7, Rhythm part

● Maximum Polyphony

28 Voice

● Effects

Reverb/Delay, Chorus

● Memory

Preset A : Patch 64
Performance 16
Rhythm set 1

Preset B : Patch 64
Performance 16
Rhythm set 1

Internal : Patch 64
Performance 16
Rhythm set 1

DATA card : Patch 64
Performance 16
Rhythm set 1

Waveform : 129

● Display

24 characters, 2 lines (backlit LCD)

● Connectors

MAIN OUTPUT jack (L / R)

SUB OUTPUT jack (L / R)

MIDI connector (IN / OUT / THRU)

Card slot (PCM / DATA)

Phones jack

● Power Supply

AC117V / 220V / 240V

● Power Consumption

AC117V : 16W

AC220V/240V : 20W

● Dimensions

482 (W) × 358 (D) × 45 (H) mm

19 (W) × 14-1/8 (D) × 1-13/16 (H) inches

EIA-1U rack mount type

● Weight

4.2kg / 9 lbs 4 oz

● Accessories

Owner's Manual

MIDI cable (1m)

● Options

PCM Card : SO-PCM1 series

DATA card : PN-JV80 series

EXPANSION BOARD : SR-JV80 series

Memory (DATA)card : M-256E

Stereo headphone : RH-20/80/120

System rack : SYR series

* The specifications for this product are subject to change without prior notice.

INDEX OF FUNCTIONS AND OPERATIONS

● In order to change channels:

- Change the control channel
 - System Edit mode Control channel (P.5-6)
- Change the Patch receiving channel
 - System Edit mode Patch receiving channel (P.5-5)
 - Patch Play mode Patch receiving channel (P.3-6)
- Change the receiving channel of each Part
 - Performance Edit mode Part receiving channel (P.7-12)

● In order to change pan settings:

- Change the Patch pan
 - Patch Edit mode Patch pan (P.6-8)
 - Patch Play mode Patch pan (P.3-6)
- Change the Tone pan
 - Patch Edit mode TVA pan (P.6-45)
- Change the pan of each Part
 - Performance Edit mode Part pan (P.7-11)
- Change the pan of a Rhythm Tone
 - Rhythm Edit mode TVA pan (P.8-19)
- Change the stereo position of the sound by note number
 - Patch Edit mode Panning keyfollow (P.6-46)

● In order to control parameters by an external device:

- Control by modulation data
 - Patch Edit mode Modulation 1—4 (P.6-18)
- Control by aftertouch data
 - Patch Edit mode After touch 1—4 (P.6-18)
- Control by expression data
 - Patch Edit mode Expression 1—4 (P.6-18)

● In order to change the destination of the audio output (output jack):

- Change the output mode
 - System Edit mode Output mode (P.5-4)
- Change the destination output of each Part
 - Performance Edit mode Output select (P.7-15)
- Change the destination output of each Tone
 - Patch Edit mode Output select (P.6-53)
- Change the destination output of each Rhythm Tone
 - Rhythm Edit mode Output select (P.8-22)

● In order to change the pitch:

- Change the entire pitch of the instrument
 - System Edit mode Master tune (P.5-4)
 - Change the basic pitch of each Tone
 - Patch Edit mode Coarse tune (P.6-27); fine tune (P.6-28)
- SECTION 9
- Change the basic pitch of each Part
 - Performance Edit mode Coarse tune (P.7-11); fine tune (P.7-11)
 - Change the pitch of the Rhythm Tone
 - Rhythm Edit mode Coarse tune (P.8-9); fine tune (P.8-9)
 - Use the bender lever
 - Patch Edit mode Bender range (P.6-14)
 - Change the pitch by the modulation data
 - Patch Edit mode Modulation 1—4 (P.6-18)
 - Change the pitch by the after touch data
 - Patch Edit mode Aftertouch 1—4 (P.6-18)
 - Change the pitch by the expression data
 - Patch Edit mode Expression 1—4 (P.6-18)
 - Change the tuning for every note
 - System Edit mode Scale tune (P.5-10)
 - Change the pitch envelope
 - Patch Edit mode Pitch envelope (P.6-31—33)
 - Change the pitch envelope of the Rhythm Tone
 - Rhythm Edit mode Pitch envelope (P.8-11)
 - Change the pitch by applying the LFO
 - Patch Edit mode LFO pitch depth (P.6-24)

● In order to change the sound level:

- Change the sound level of whole JV-880 VOLUME knob (P.1-2)
- Change the Patch level
 - Patch Edit mode Patch level (P.6-8)
 - Patch Play mode Patch level (P.3-6)
- Change the Part level
 - Performance Edit mode Part level (P.7-10)
- Change the TVA level
 - Patch Edit mode TVA level (P.6-43)
- Change the sound level by velocity
 - Patch Edit mode A-ENV velocity (P.6-48, 6-49)
- Change the TVA level by the modulation data
 - Patch Edit mode Modulation 1—4 (P.6-18)
- Change the TVA level by the aftertouch data
 - Patch Edit mode After touch 1—4 (P.6-18)
- Change the TVA level by the expression data
 - Patch Edit mode Expression 1—4 (P.6-18)
- Change the TVA level by applying the LFO
 - Patch Edit mode LFO TVA depth (P.6-24)

● In order to change the sound program:

- Turn ON/OFF the sounding of the Tone..... Tone switch (P.3-4)
- Change the original waveform
 - Patch Edit mode WG (P.6-26)
 - Patch Edit mode FXM (P.6-27)
- Change the filter setting
 - Patch Edit mode TVF (P.6-34—38)
- Change the TVF envelope
 - Patch Edit mode TVF envelope (P.39—42)
- Change the depth of the TVF envelope
 - Patch Edit mode Envelope depth (P.6-38)
- Change the sound program by modulation data
 - Patch Edit mode Modulation 1—4 (P.6-18)
- Change the sound program by after touch data
 - Patch Edit mode Aftertouch 1—4 (P.6-18)
- Change the sound program by expression data
 - Patch Edit mode Expression 1—4 (P.6-18)
- Apply LFO
 - Patch Edit mode LFO TVF depth (P.6-24)

● In order to change Patches:

- Change from the JV-880 (P.3-2)
- Change from an external MIDI device..... (P.2-10)

● In order to change Performances:

- Change from the JV-880 (P.4-2)
- Change from an external MIDI device..... (P.2-10)

● In order to change Rhythm Sets:

- Change from the JV-880 (P.8-2)
- Change from an external MIDI device..... (P.2-10)

● In order to use the Patches of the expansion board or PCM card

- Load one Patch
 - Utility mode..... Load patch single (P.9-19)
- Load in groups (of 64 Patches)
 - Utility mode..... Load patch group (P.9-20)

● In order to use effects (reverb/chorus):

- Turn the effect switch ON/OFF
 - System Edit mode..... Chorus switch (P.5-5); reverb switch (P.5-5)
 - Patch Play mode Chorus switch (P.3-6); reverb switch (P.3-6)
- Set the Patch effect
 - System Edit mode..... Output mode (P.5-4)
 - Patch Edit mode Chorus (P.6-9, 10); reverb (P.6-11, 6-12)
- Set the Performance effect
 - System Edit mode..... Output mode (P.5-4)
 - Performance Edit mode Chorus (P.7-7, 8); reverb (P.7-8, 7-9)
- Set the Rhythm Set effect
 - System Edit mode..... Output mode (P.5-4)

● In order to initialize the data:

- Initialize the data in the temporary area
 - Utility mode..... Initialize (P.9-11, 9-12)
- Initialize the data in the DATA card
 - Utility mode..... DATA card (P.9-13)

● In order to use the DATA card:

- Use the Patch of the DATA card..... (P.3-2)
- Use the Performance of the DATA card..... (P.4-2)
- Use the Rhythm Set of the DATA card..... (P.8-2)
- Save the data to the DATA card
 - Utility mode..... Write operation (P.9-14)
- Transfer data between DATA card and internal memory
 - Utility mode..... DATA card (P.9-14)

● In order to receive exclusive data:

- Match the unit numbers
 - System Edit mode..... Unit number (P.5-6)
- Turn on the exclusive receiving switch
 - System Edit mode..... Exclusive receiving switch (P.5-9)

● In order to transmit data to an external MIDI device:

- Transmit the data to the temporary area
 - Utility mode..... Temporary dump (P.9-18)
- Store the internal/DATA card data to a sequencer
 - Utility mode..... Bulk dump (P.9-16)

● In order to change the volume/pan of each Part from an external MIDI device:

- Match the MIDI channels
 - Performance Edit mode..... Part receiving channel (P.7-12)
- Turn on the MIDI data receiving switch
 - System Edit mode..... Volume receiving switch (P.5-8)
Control change receiving switch (P.5—7)
- Turn on the volume receiving switch
 - Performance Edit mode..... Volume receiving switch (P.7-14)

A

Aftertouch 1—4 6-18
Aftertouch message 2-13
Aftertouch receive switch 5-9
Analog feel depth 6-13

B

Bank select 2-11
Bank select receive switch 5-7
Bender range
 Patch 6-14
 Rhythm 8-6
Bulk dump 9-16

C

Channel 2-2
Channel mode message 2-13
Channel voice message 2-11
Chorus depth
 Patch 6-10
 Performance 7-7
Chorus feedback
 Patch 6-10
 Performance 7-7
Chorus level
 Patch 6-9
 Performance 7-7
Chorus output
 Patch 6-10
 Performance 7-8
Chorus rate
 Patch 6-9
 Performance 7-7
Chorus send level
 Patch 6-52
 Rhythm 8-21
Chorus switch 5-5
Chorus type
 Patch 6-9
 Performance 7-7
Coarse tune 7-11
Compare 9-3
Control change message 2-11
Control change number 2-11
Control change receive switch 5-7
Control channel 5-6
Copy 9-6
Cursor 1-3

D

Display contrast 1-3
Dry level
 Patch 6-52
 Rhythm 8-21

E

Envelope generator 2-1
Envelope mode 8-6
Exclusive message 2-13
Exclusive receive switch 5-9
Expression 2-12
Expression 1—4 6-18

F

Factory preset 9-23
Fine tune 7-11

H

High pass filter 6-34
Hold — 1 2-12
Hold — 1 receive switch
 Patch 6-16
 Performance 7-14

I

Initialize
 Patch / Performance / Rhythm 9-11 — 9-12
 Card 9-14
Initialize data 10-19
Internal 2-4

K

Key assign 6-13

L

LFO
 delay 6-22
 fade 6-23
 fade time 6-23
 offset 6-22
 pitch depth 6-24
 rate 6-21
 synchro 6-21
 TVA depth 6-24

LFO	
TVF depth	6-24
waveform	6-20
Low pass filter	6-34

M

Master tune	5-4
Memory	2-4
Memory protect	9-22
MIDI	2-11
Modulation	2-12
Modulation 1—4	6-18
Modulation receive switch	5-8
Mono message	2-13
Mute group	8-7

N

Note message	2-11
Note number	8-2

O

Output jack	2-7
Output mode	5-4
Output select	
Patch	6-53
Performance	7-15
Rhythm	8-22

P

Panpot	2-12
Part information	4-6
Part level	6-8
Part monitor	4-5
Part mute	4-4
Part pan	7-11
Part receive channel	7-12
Part receive switch	7-15
Patch	2-1
Patch level	6-8
Patch select	7-10
Patch common parameter	6-7
Patch edit mode	2-14
Patch name	3-2
Patch number	3-2
Patch pan	6-7
Patch play mode	2-14
Patch receive channel	5-5

Performance	4-1
Performance common parameter	7-1
Performance edit mode	2-14
Performance name	4-2
Performance play mode	2-14
Pitch bend change message	2-13
Pitch bend receive switch	5-9
Pitch envelope	
T1 velocity	6-31
T4 velocity	6-32
Time keyfollow	6-32
T1—T4	
Patch	6-33
Rhythm	8-11
L1—L4	
Patch	6-33
Rhythm	8-11
Poly message	2-13
Portamento	2-12
Portamento mode	6-14
Portamento switch	6-14
Portamento time	6-15
Portamento type	6-15
Power up mode	5-12
Preset A	2-4
Preset B	2-4
Preview note	5-13
Preview velocity	5-13
Program change receive switch	
Performance	7-14
System	5-7
Program change message	2-11
Program change number	2-10

R

ROM play	1-4
RPN	5-7
Reset all controllers	2-13
Reverb feedback	
Patch	6-12
Performance	7-7
Reverb level	
Patch	6-11
Performance	7-7
Reverb send level	
Patch	6-52
Rhythm	8-22
Reverb switch	5-5

Reverb time	
Patch	6-12
Performance	7-7
Reverb type	
Patch	6-11
Performance	7-7
Rhythm edit key	5-12
Rhythm edit mode	2-14
Rhythm set	2-3
Rhythm tone	2-3
Road patch group	9-19
Road patch single	9-20

S

Scale tune	5-10
Scale tune switch	5-9
System common parameter	5-1
System edit mode	2-14

T

Temporary dump	9-18
Time variant amplifier	6-48
Time variant filter	6-34
Tone	2-1
Tone switch	3-4, 6-6
TVA	
delay mode	6-46
delay time	6-47
keyfollow	6-43
level	
Patch	6-43
Rhythm	8-18
pan	
Patch	6-45
Rhythm	8-18
panning keyfollow	6-46
velocity	
Patch	6-45
Rhythm	8-18
velocity curve	6-44
TVA envelope	
T1 velocity	6-48
T4 velocity	6-48
Time keyfollow	6-49
T1—T4	
Patch	6-50
Rhythm	8-20

L1—L4(3)	
Patch	6-50
Rhythm	8-20
TVA time velocity	8-19
TVF	
cutoff frequency	
Patch	6-35
Rhythm	8-13
envelope depth	
Patch	6-38
Rhythm	8-15
filter type	
Patch	6-34
Rhythm	8-12
resonance	
Patch	6-36
Rhythm	8-14
resonance mode	
Patch	6-36
Rhythm	8-14
TVF envelope	
T1 velocity	6-40
T4 velocity	6-41
Time keyfollow	6-41
Velocity	6-40
T1—T4	
Patch	6-42
Rhythm	8-17
L1—L4	
Patch	6-42
Rhythm	8-17
Velocity	6-40
Velocity curve	6-39
TVF time velocity	8-16
TVF velocity	8-15

U

Unit number	5-6
User memory	2-4
Utility mode	2-14

V

Velocity range	6-16
Voice reserve	7-12
Volume	2-12
Volume receive switch	
Performance	5-8
System	7-14

W**WG**

envelope depth	
Patch	6-29
Rhythm	8-10
FXM	
switch	6-27
depth	6-27
pitch coarse	
Patch	6-27
Rhythm	8-9
pitch fine	
Patch	6-28
Rhythm	8-9
pitch keyfollow	6-29
pitch velocity	
Patch	6-30
Rhythm	8-10
Random pitch	
Patch	6-28
Rhythm	8-9
wave group	
Patch	6-26
Rhythm	8-8
Wave generator	2-1
WG pitch time velocity	8-10
Write	9-2

INSTALLING THE EXPANSION BOARD

1

Remove the cover on the top part of JV-880 (four screws).

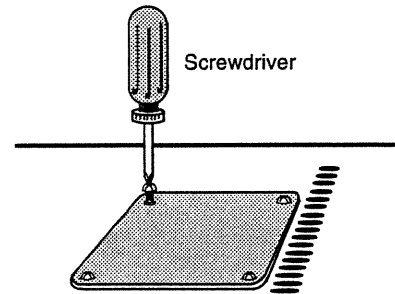

2

Place the plate holder as shown in the illustration.

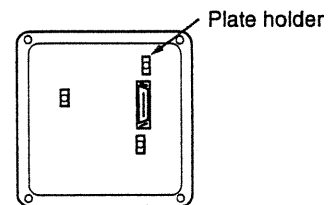

3

Firmly insert the connector of the expansion board into the connector of JV-880.

Make sure that the three plate holders stick out of the expansion board.

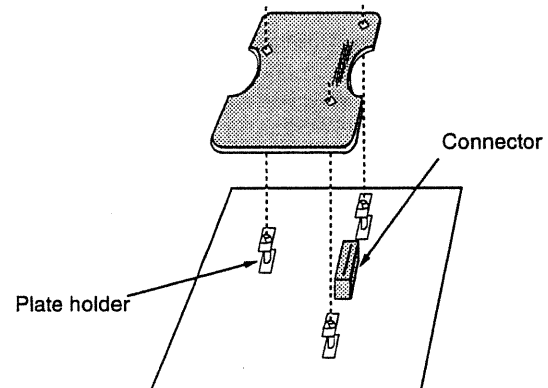

4

Using the included locking tool, rotate the plate holder toward the LOCK direction in order to fix the expansion board.

In order to remove the expansion board, rotate the plate holder toward the UNLOCK direction, then remove the board by pulling the locking tool up.

Finally, use the four screws to fasten the cover.

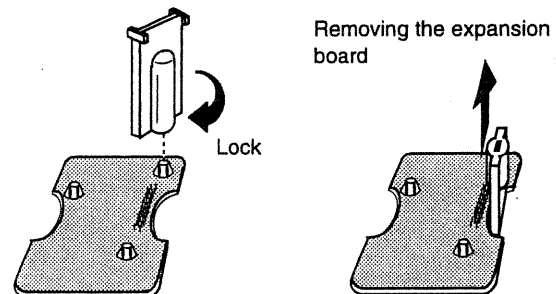

5

Check that the expansion board has been installed correctly.

When "EXP" cannot be selected (is not displayed) on the Waveform selecting page (**WG wave Group**: P.6-26, 8-8), try installing the expansion board again.

For Nordic Countries

Apparatus containing Lithium batteries

ADVARSEL!

Lithiumbatteri – Eksplosionsfare ved fejlagtig håndtering.
Udskiftning må kun ske med batteri af samme fabrikat og type.
Levér det brugte batteri tilbage til leverandøren.

VARNING!

Explosionsfara vid felaktigt batteribyte.
Använd samma batterityp eller en ekvivalent typ som rekommenderas av apparattillverkaren.
Kassera använt batteri enligt fabrikantens instruktion.

ADVARSEL!

Lithiumbatteri – Eksplosjonsfare.
Ved utskifting benyttes kun batteri som anbefalt av apparatfabrikanten.
Brukt batteri returneres apparatleverandøren.

VAROITUS!

Paristo voi räjähtää, jos se on virheellisesti asennettu.
Vaihda paristo ainoastaan laitevalmistajan suosittelemaan tyyppiin. Hävitä käytetty paristo valmistajan ohjeiden mukaisesti.

For Germany

Bescheinigung des Herstellers/Importeurs

Hiermit wird bescheinigt, daß der/die/das

Roland Multi Timbral Synthesizer Module JV-880

(Gerät. Typ. Bezeichnung)

in Übereinstimmung mit den Bestimmungen der

Amtsbl. Vfg 1046/1984

(Amtsblattverfügung)

funk-entstört ist.

Der Deutschen Bundespost wurde das Inverkehrbringen dieses Gerätes angezeigt und die Berechtigung zur Überprüfung der Serie auf Einhaltung der Bestimmungen eingeräumt.

Roland Corporation Osaka/Japan

Name des Herstellers/Importeurs

For the USA

RADIO AND TELEVISION INTERFERENCE

WARNING — This equipment has been verified to comply with the limits for a Class B computing device, pursuant to Subpart J, of Part 15, of FCC rules. Operation with non-certified or non-verified equipment is likely to result in interference to radio and TV reception.

The equipment described in this manual generates and uses radio frequency energy. If it is not installed and used properly, that is, in strict accordance with our instructions, it may cause interference with radio and television reception. This equipment has been tested and found to comply with the limits for a Class B computing device in accordance with the specifications in Subpart J, of Part 15, of FCC Rules. These rules are designed to provide reasonable protection against such an interference in a residential installation. However, there is no guarantee that the interference will not occur in a particular installation. If this equipment does cause interference to radio or television reception, which can be determined by turning the equipment on and off, the user is encouraged to try to correct the interference by the following measure:

- Disconnect other devices and their input/output cables one at a time. If the interference stops, it is caused by either the other device or its I/O cable. These devices usually require Roland designated shielded I/O cables. For Roland devices, you can obtain the proper shielded cable from your dealer. For non Roland devices, contact the manufacturer or dealer for assistance.
- If your equipment does cause interference to radio or television reception, you can try to correct the interference by using one or more of the following measures.
 - Turn the TV or radio antenna until the interference stops.
 - Move the equipment to one side or the other of the TV or radio.
 - Move the equipment farther away from the TV or radio.
 - Plug the equipment into an outlet that is on a different circuit than the TV or radio. (That is, make certain the equipment and the radio or television set are on circuits controlled by different circuit breakers or fuses.)
 - Consider installing a rooftop television antenna with coaxial cable lead-in between the antenna and TV. If necessary, you should consult your dealer or an experienced radio/television technician for additional suggestions. You may find helpful the following booklet prepared by the Federal Communications Commission: "How to Identify and Resolve Radio — TV Interference Problems"

This booklet is available from the U.S. Government Printing Office, Washington, D.C., 20402, Stock No. 004-000-00345-4.

For Canada

CLASS B

NOTICE

This digital apparatus does not exceed the Class B limits for radio noise emissions set out in the Radio Interference Regulations of the Canadian Department of Communications.

CLASSE B

AVIS

Cet appareil numérique ne dépasse pas les limites de la classe B au niveau des émissions de bruits radioélectriques fixés dans le Règlement des signaux parasites par le ministère canadien des Communications.

JV-880

OWNER'S MANUAL

