

 **Roland**[®]

JP-8

Owner's Manual

Introduction

The Roland Jupiter-8 is an eight voice sixteen oscillator polyphonic synthesizer, specifically designed to offer an exceptional variety of rich sounds and to greatly expand the performance capabilities to working musicians. The JP-8's top quality, full function synthesizers, extensive programming section, and advanced keyboard control options, can either form the nucleus of any multi-keyboard set-up, or perform as a solo instrument to duplicate music in live performance that normally could not be produced without many instruments or multi track recording facilities.

The Jupiter-8 has the DCB connector so that it can be controlled by an external device such as the MC-4 microcomposer.

*You need to set up the interface OP-8 in this case.

Table of Contents

| | |
|-----------------------------------|----|
| Introductions | 1 |
| Front and Back Panel Layout | 2 |
| Control Descriptions | 3 |
| Basic Connections | 4 |
| Operation | 9 |
| Patching | 25 |
| Specifications | 29 |

Front and Back Panel Layout

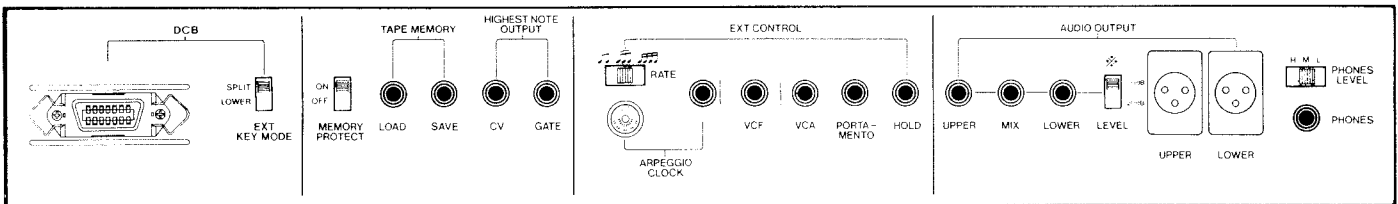
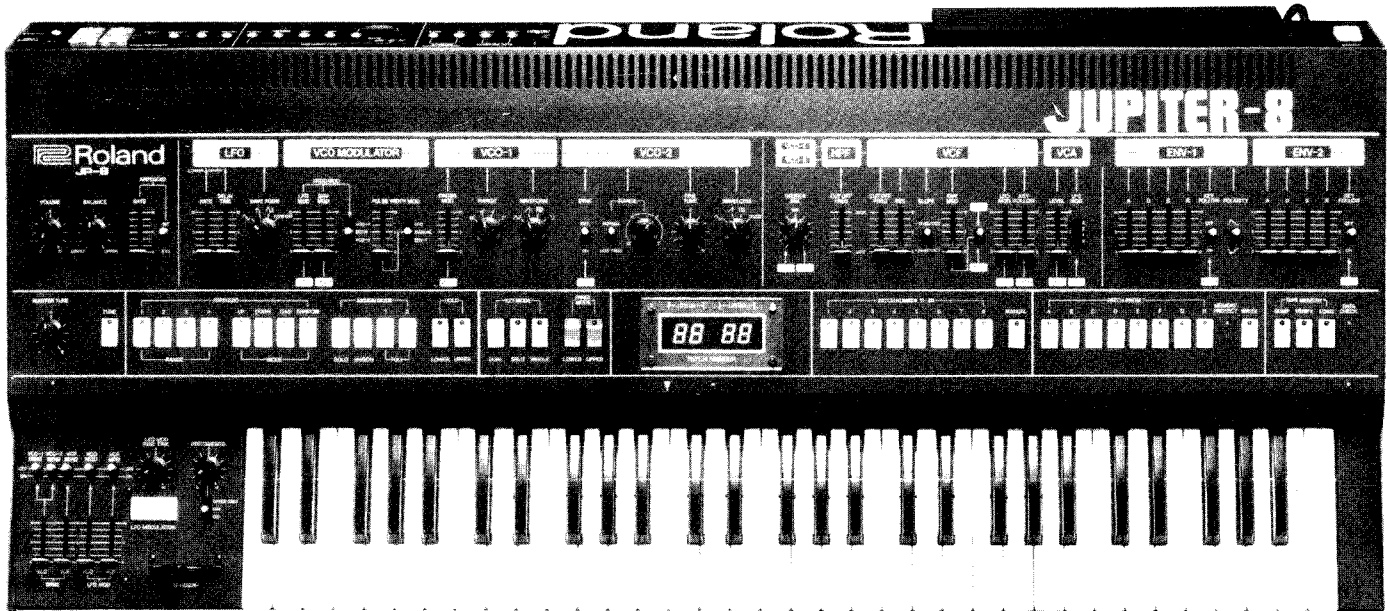

Synthesizer Function

The Jupiter-8's impressive sounds are created by its eight two oscillator synthesizer systems. These synthesizers are controlled by single bank of controls that feature a logical left to right flow and mix sliders with rotary controls to provide the most readily available information and control. Highlights of each JP-8 synthesizers voice include:

Two separate VCOs providing four waveform options each including precise sine, triangle, sawtooth, square, variable pulse, and noise waveforms. All sixteen oscillators are easily tuned in approximately three seconds and feature high stability to remain in tune even during long sessions under difficult conditions. A wide variety of modulation options include syncing and cross modulation between VCOs for control over an exceptionally wide variety of sound and tone color.

Output of the VCOs passes through an infinitely variable source mixer and then on the the Filter sections. A separate Hi Pass Filter can be combined with a voltage controlled Low Pass Filter that is selectable between a rich -24dB/octave or a more acoustic -12dB/octave cutoff slope. These choices combine with a wide variety of control options that give musicians maximum creative control over the tone color of their sound.

Two complete four stage ADSR Envelope Generators feature slider controls for accurate visual information and control during programming and editing. Each envelope includes an exclusive Key Follow option allowing the Attack, Decay, and Release length to be shortened in proportion to the height of any pitch as they naturally do on many acoustic instruments including the piano. Envelope-1 also includes a switch for inverting its effect before being sent to the sections it will control.

The VCA may be both Envelope and LFO controlled and terminates on the JP-8 back panel in a Stereo Headphone output, two balanced outputs, and three unbalanced outputs suitable for a wide variety of amplification applications.

The Jupiter-8's powerful programmer has the capacity to store and recall the exact synthesizer settings for up to sixty-four different patch programs. Patches may be stored virtually permanently using the JP-8's Lithium battery back-up system. Writing into any patch position from the Manual control or another patch position requires only pressing two switches and the patch number desired. Patch selection simply requires punching in the actual two digit number needed which is then displayed in a large LED display window.

NOTE: Be sure to replace every 3 years.

Editing

Any program in memory can be edited even during live performance by moving the desired control, simultaneously activating the Edit Indicators in the display window. Editing may be used as a sophisticated real time performance control since it does not automatically rewrite the existing program. An Edit may also be written into memory either as a modification of the old program or as a new program by pressing one button and the patch number desired.

The Jupiter-8's five octave keyboard can be grouped into three different Key Modes: Whole, Dual, and Split.

The Whole Mode operates as one eight voice polyphonic instrument, while Dual and Split Modes divide the JP-8 into two four-voice instruments that may even be assigned different patches. Split Mode divides the keyboard into Lower and Upper sections while Dual Mode layers two patches from each keypress. Both modes offer multi keyboard capability from one instrument. The two patches required for the Split and Dual Modes may both be manually called to the display window using the numbered Patch Selectors or by using one of the eight Patch Preset switches that can be programmed to recall any pair of sixty-four available patches with one motion.

Tape Memory

If more memory capacity is needed, the JP-8's Tape Memory section allows its Patch Programs to be saved into an ordinary tape recorder for storage and later retrieval. The entire section of sixty-four Programs and eight Patch Preset pairs may be saved and later re-loaded or portions of the memory may be

saved and re-loaded into any position needed. A Verify function is provided to verify taped programs as being correct before the JP-8's internal memories are altered, an important safety feature to protect your hours of programming effort.

Arpeggio Section

The Jupiter-8's keyboard computer also provides a unique Arpeggio section allowing the sequencing of automatic arpeggios live off notes played on the keyboard, shifting harmony as the keys are changed in a way no preset sequencer ever will. The JP-8 will arpeggiate off the entire keyboard or off the bottom of

a split keyboard, leaving the top end free for polyphonic chord, solo or effect work. The Arpeggio section combines with the four Assign Modes and the JP-8's internal and external performance controls to offer an exceptional amount of performance flexibility.

The Roland Jupiter-8 polyphonic synthesizer is an exceptionally flexible musical instrument capable of producing solo and polyphonic sounds that vary from gentle to brutally savage in character, spanning a wide pitch range. The Jupiter-8 can be monitored through any conventional amplification but individual musician's needs and the JP-8's needs and various output options should be considered in choosing an ideal amplification setup.

To maximize the Jupiter-8's ultimate sound flexibility, ideal amplification will reproduce all of the synthesizer's sounds faithfully with a minimum of added distortion and coloration. A variety of quality P.A.'s, combo amps and component amplification systems will fill this need, but there are several special items to consider.

Avoid Specialized Amplification

Avoid equipment or speakers chosen to color sound to suit a particular instrument such as the electric guitar or bass guitar. These items may well support certain specific sounds you wish from your JP-8, but would severely limit most others. P.A.'s may be perfectly suited to stereo polyphonic keyboard work, but

may also be restricted to a narrow frequency band or range of dynamics. Check them with the Jupiter-8 for true compatibility. Remember the broad range of applications that the JP-8 may be called upon to fill and plan your amplification accordingly.

Consider the Entire Chain

Consider your entire amplification chain to be sure that each part, including built-in and out-board effects, performs well in your particular setup without adding distortion or large amounts of noise. Give special consideration to the use of Reverb. Sounds such as orchestral string or brass sections are usually associated with the sound of a large hall (with a lot of reverb). Adding reverb to the Jupiter-8 output can duplicate that effect while subtly softening the sound and effect-

ing the perception of tone color. Reverb units built into your amplification may serve the purpose for your JP-8 so long as they can cope with the rich signal without distortion. Otherwise, external reverb is easily available with units such as the BOSS RX-100 Reverb Box which may be used either Mono-In/Mono-Out or Stereo-In/Stereo-Out in your amplification chain.

Avoid Distortion

The Jupiter-8 is fully polyphonic and when playing deep, full chords can produce a sudden, high level output signal which may cause distortion in the pre-amplifier section of amps not built to handle it. Amplification for your JP-8 should accept the output signal without breaking up or distorting and still provide sufficient final volume levels. The unbalanced outputs on the rear panel of the JP-8 include an Output Level Switch that provides a choice of either 0 or -20 dB

output levels to assist in matching the Jupiter-8 unbalanced outputs to external amplification. Choose the position which gives the best signal-to-noise ratio without distortion while playing a full chord from a rich patch with the front panel Volume control set at '10'. Once this is determined, lower the Volume control to between '5' and '7' to allow room to adjust levels during performance.

Five Audio Outputs

The Audio Output section on the back panel of the Jupiter-8 includes three 1/4 inch phone jack unbalanced outputs. All three are controlled simultaneously by the Output Level Switch mentioned above. The Upper and Lower outputs provide separate access to the corresponding section of the

keyboard when in the Split Key Mode, or layers of the two patches per key when in the Dual Key Mode. They present the same output when in the Whole Key Mode. The third, Mix, output presents a summed mix of the Upper and Lower outputs for strictly mono amplification or monitoring.

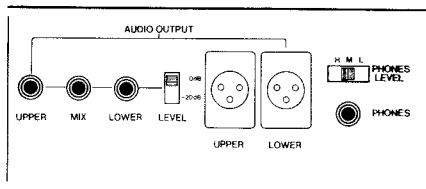

The Audio Output section also includes a separate pair of balanced 3-pin male XLR connections. These Upper and Lower outputs may be used simultaneously with the unbalanced outputs and reference to a constant 0 dB (they do not respond to the Level Switch). The balanced outputs are specially suited to drive professional studio consoles and tape recorders or top quality P.A. amplification or mixing equipment.

Balanced lines may be run as long as 100 feet without any noticeable signal degradation, a clear advantage over unbalanced lines which are susceptible to hum and noise over long distances. The balanced outputs can be plugged directly into a studio console to eliminate the need for a trouble-prone "direct box" normally used for most direct-injection recording applications.

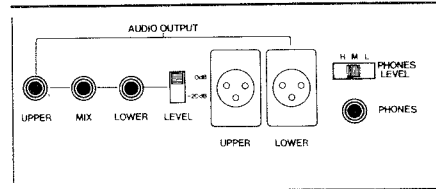

Stereo Applications

The separate Upper and Lower outputs from the Jupiter-8 allow its Dual and Split functions to appear at two different points of the stereo field, greatly increasing the illusion of complex layered orchestration and of a large multi-keyboard stack. The simplest way to achieve this stereo spread is to use stereo amplification with the two mixer input channels assigned to the JP-8 panned left and right. One effective option

would send the mix output to primary mono keyboard amplification while sending separate Upper and Lower outputs to the P.A. to add a stereo effect. If no conventional stereo amplification is available it may be possible to turn one stereo output to the mono keyboard amplification and the other stereo output to other available amplification, paying careful attention to the relative tone and volume of the two sounds.

Headphone Amplification

The Jupiter-8 provides self-contained headphone amplification for any conventional stereo headphones through a 1/4 inch phone jack sockets allow remote panel. A 3 position Level switch offers a choice between Low, Medium and High output levels.

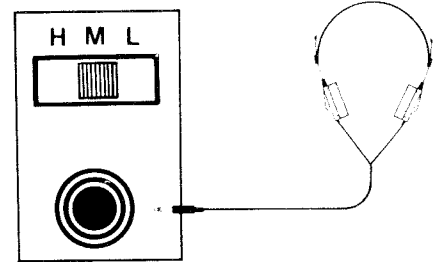

External Control Connections

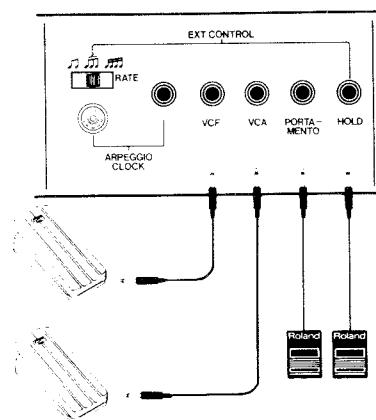

The Jupiter-8 includes five different external control options for expanded performance capability. Two separate 1/4 inch phone jack sockets allow remote control of the Portamento and Hold functions with optional Roland DP-2 Damper Pedals.

When the DP-2 is connected to the Portamento jack, the corresponding functions in the Performance Control section will be defeated when the DP-2 is pressed. A DP-2 connected to the Hold jack will initiate that function for the entire keyboard when the

Whole or Dual Key Modes are used, and only effect the Lower end of the keyboard when the Split Key Mode is used.

Two additional 1/4 inch phone jack sockets allow separate remote control of the VCF (tone color control) and VCA (volume for all outputs) with optional volume pedals such as the Roland FV-20. Also VCF or VCA cont. can be inputed CV (0 ~ 5V). Connect the

Output of a volume pedal to either the VCF or VCA External Control Input. Sweeping the pedal will effect the tone color (VCF connection) or volume level (VCA connection) upward from the normal point set by whatever patch is being used.

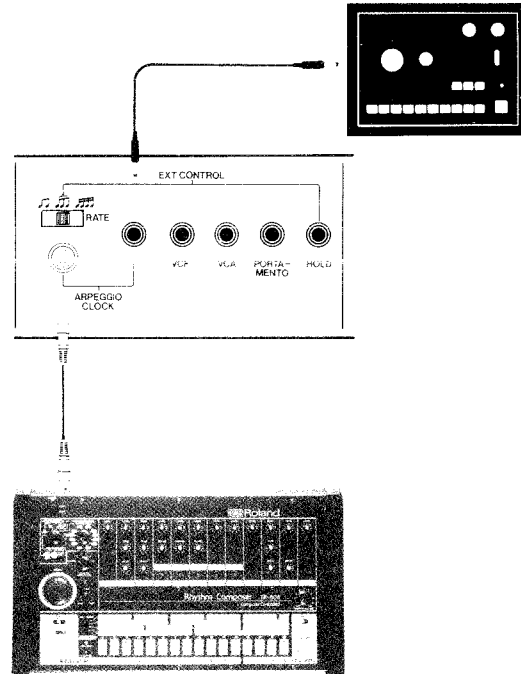

External control of the Arpeggio Clock allows the timing of the Jupiter-8 Arpeggio section rhythm to be in perfect synchronization with an external unit such as a Roland CSQ Digital Sequencer, BOSS DR-55 programmable rhythm unit, Roland CompuRhythm units, or the Roland TR-808 Rhythm Composer. Triggers injected into the 1/4 inch jack connection will step

the Arpeggio once each time a trigger is received. The DIN connection allows units with this facility to actually link their internal clocks to the Jupiter-8. When this connection is used, and associated 3 position switch allows the JP-8 Arpeggio section to respond with straight eighth notes, eighth note triplets, or sixteenth notes.

Highest Note Outputs

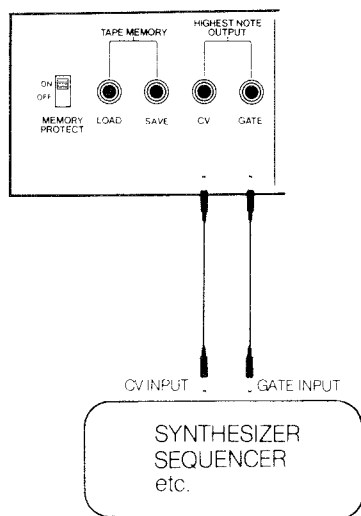

The Jupiter-8 is provided with a single pair of Control Voltage and Gate Outputs to allow interfacing with external synthesizers and equipment. These 1/4 inch phone jack connections are derived from the top note played on the JP-8 keyboard. They follow the industry standard one volt per octave Keyboard Control Voltage and positive voltage Keyboard Gate to allow maximum flexibility. Direct interfacing examples include solo synthesizers such as the Roland SH-09 or digital sequencers such as the Roland CSQ's, which in turn would drive a solo synthesizer such as the SH-09.

Tape Memory Connections

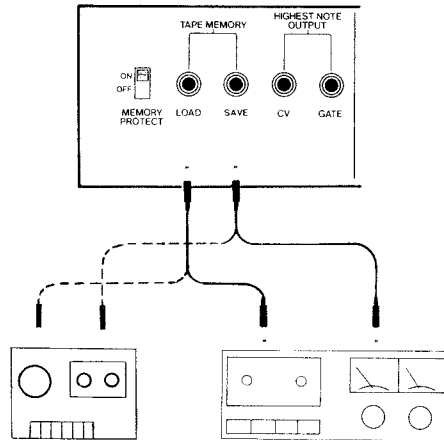

These two 1/4 inch phone jack connections provide access to the Jupiter-8's self contained Tape Memory interface. Connect the JP-8 Save jack to the Record input (LINE IN, MIC etc.) of a tape recorder to make a digital tape memory of a set of Jupiter-8 programs. Connect the JP-8 Load jack to the Playback output (LINE OUT, PHONE etc.) of a tape recorder to load a similar digital tape memory of Jupiter-8 programs into the instrument. Details on this procedure and it's various options are given later in this manual.

Memory Protect Switch

The Memory Protect Switch on the back panel of the Jupiter-8 allows both the normal Patch Programming functions and the Tape Memory interface functions to be disabled to protect all internal memories from accidental erasure or modification. Always leave the Memory Protect switch in it's 'On' (protecting memory) position unless you are actually writing a new program (or edit) into memory or are loading a new set of memories using the Tape Memory interface. A Memory Protect LED indicator located directly to the left of the Write switch on the front panel provides visual confirmation that the Memory Protect function is 'On'.

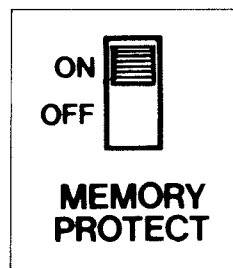

The best way to gain a firm, comfortable command of your Jupiter-8 is through a systematic study of each control and function. Twin advantages of JP-8 are it's unprecedented depth of performance flexibility and the ease with which it's flexibility can be applied in performance with an absolute minimum of initial orientation. Keeping these points in mind, begin here to form an understanding of the performance options offered by the Jupiter-8, then proceed through a detailed, practical exploration of it's synthesizers and remaining control functions.

Connect the Jupiter-8 to suitable amplification and set it's controls to the settings shown in Figure 1.

(Figure 1 showing basic tuning patch)

NOTE: In this manual, most control references will be made to a scale of Zero to Ten. Any of the rectangular switches not marked 'On' in the diagrams should be in the 'Off' (LED extinguished) position. To change the 'On'/'Off' status of any switch, merely press that switch lightly.

DCB

The DCB (Digital Communication Bus) is the interface system that converts the CV or the GATE signal into a digital signal for the communication between the Jupiter-8 and the external device (which also includes the DCB system). This also enables the JP-8 to accept the analogue signal.

By using the CV interface OP-8, you can control the JP-8 with the MC-4 microcomposer.

*If the DCB cable is not connected to the JP-8, the EXT KEY MODE switch does not function.

Note

Please do not connect the JP-8 to the device other than OP-8.

Figure 1

JUPITER-8

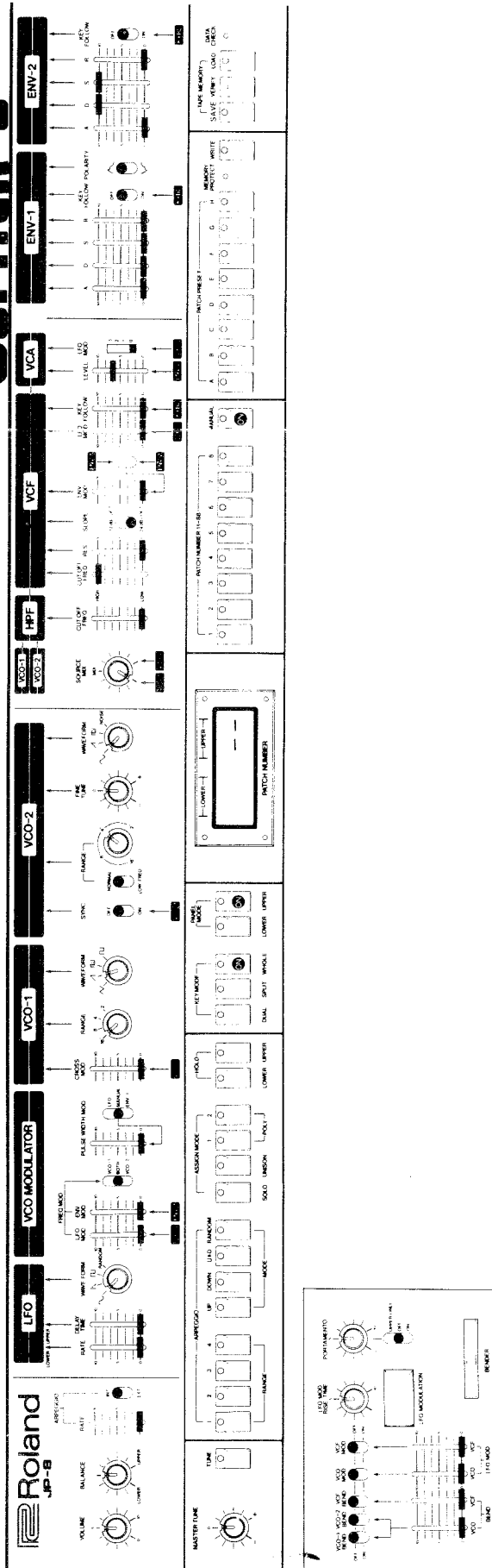

Switching 'On' and Tuning

Connect the Jupiter-8 to AC power and switch 'On' by rocking the Power switch on the back panel to it's lighted position. The JP-8 will automatically set it's push button switches to the positions shown in Figure 1 and will temporarily enter the Tune Mode as shown by the flashing of the red Tune button's integral LED. This flashing will continue and all other functions will be suspended for about three seconds, until the tuning procedure is completed. For best results press the red Tune button to final tune the Jupiter-8 approx. 'four' minutes after it is switched 'On' — once warmed up and tuned, the high stability oscillators should remain in tune even during extended sessions under difficult conditions.

Once the Jupiter-8 is computer tuned it will be in perfect tune with itself and reference very near to A-442 if the Master Tune knob on the left of the control panel is in the 12 o'clock position. The Master Tune knob can alter the overall pitch of the Jupiter-8 ± 50 cents (a range of a minor second) so that it may be tuned to other instruments or tuning references.

To tune the JP-8 to another reference use a patch which will produce a long, steady note such as the patch you have set on the manual controls (following Figure 1). Press the key of any note you wish to match to another instrument or to a tuner, then match pitches by adjusting the Master Tune knob clockwise (sharp) or counterclockwise (flat).

Master Volume

To complete your initial adjustments, play any chord near the bass end of the keyboard and adjust the master Volume control to a pleasing level. All programs within the Jupiter-8 can be programmed to a suitable volume level, making further adjustment of the master Volume during performance usually unnecessary.

Patch Selection

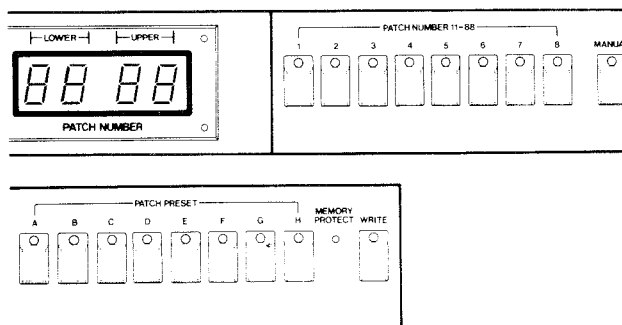

You are now ready to play. The Jupiter-8 includes enough memory capacity to retain all of the particulars of up to 64 different synthesizer patches. All 64 are user-programmable, but for your convenience many come pre-programmed from the manufacturer to provide you with examples and programs which may be used immediately in performance.

Selecting a patch from memory is quite simple. Eight white Patch Number switches numbered 1 to 8 offer you a selection of patch positions numbering 11-18, 21-28, 31-38, 41-48, 51-58, 61-68, 71-78 and 81-88. These may be thought of as positions 1 to 8 in banks of the 'teens, twenties, and so on. To select any one of these patches, merely use the associated white Patch switches as you would a calculator keyboard. For example, to select Patch 14 merely press '1' then '4'. Simple, direct and quick. The number of the Patch you have selected will appear in the LED Patch Number display window. A special safety feature has been included: if the first digit of a new Patch number is entered and another does not follow within several seconds, the Jupiter-8's display will revert to the number previously shown and there will be no interruption of performance. This automatically corrects any switches pressed accidentally.

As you explore the pre-programmed patches, and later begin to enter your own, remember that most patches are specifically designed for lead, bass, effects, or different styles of chordal work and will sound best when played accordingly. Figure 2 provides a blank grid which you may photocopy and use to record Jupiter-8 program positions. It will be helpful if you provide a descriptive name for each patch and include a short note that will indicate it's original intentions and any special instructions.

Figure 2

| | | | | | | | |
|----|----|----|----|----|----|----|----|
| 81 | 82 | 83 | 84 | 85 | 86 | 87 | 88 |
| 71 | 72 | 73 | 74 | 75 | 76 | 77 | 78 |
| 61 | 62 | 63 | 64 | 65 | 66 | 67 | 68 |
| 51 | 52 | 53 | 54 | 55 | 56 | 57 | 58 |
| 41 | 42 | 43 | 44 | 45 | 46 | 47 | 48 |
| 31 | 32 | 33 | 34 | 35 | 36 | 37 | 38 |
| 21 | 22 | 23 | 24 | 25 | 26 | 27 | 28 |
| 11 | 12 | 13 | 14 | 15 | 16 | 17 | 18 |

| | | | | | | | |
|---|---|---|---|---|---|---|---|
| A | B | C | D | E | F | G | H |
| , | , | , | , | , | , | , | , |

Roland Patch Presets
JUPITER-8

File Number _____ Date _____

Key Modes

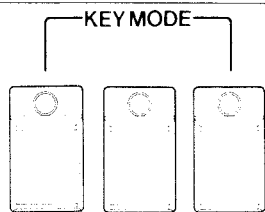

DUAL SPLIT WHOLE

The Jupiter-8's five octave keyboard has 61 keys, C to C, that can be grouped three different ways using the Dual, Split and Whole Key Modes. These Modes are selected by pressing one of the three bright blue Key Mode switches located to the left of the LED display window. When the Jupiter-8' power is first switched 'On' it will automatically set itself in the Whole Key Mode you have already been using. In the Whole Mode, the entire keyboard will react to one patch as a single, eight voice polyphonic instrument. While in the Whole Mode, the Balance control is inoperative and the Hold, Portamento, and Arpeggio functions must be applied to the entire keyboard at once. If the Lower and Upper Outputs on the back panel are being used they will present the same signal in equal amounts.

The Split Key Mode splits the keyboard into Lower and Upper sections and assigns an independent four voice synthesizer to each. The keyboard is split into two octaves for the Lower section and three octaves for the Upper, marked by an arrow on the panel immediately above the keyboard. Different patches may be assigned to the Lower and Upper ends or both ends may be assigned the same patch. Once patches have been assigned to both ends of the Split keyboard the Balance control can effect the relative Balance between them and the Portamento, Hold and Arpeggio functions may be assigned to one end without effecting the other.

To use the Split Key Mode, begin by pressing the Split switch. Until you also enter instructions for the assignment of a second program for the split keyboard the Jupiter-8 will continue to react precisely as it did for the Whole Mode it has just left. NOTE: You may freely alternate between the Dual and Split Modes without any additional steps since each uses two programs.

There are two ways to determine the Jupiter-8 patches for two ends of the Split keyboard. You may use one of the 8 programmed Patch Preset pairs or enter the desired patch numbers using the Panel Mode selectors and Patch Number switches. Once you have pressed the Split Key Mode switch, pressing any of the eight Patch Preset buttons lettered A to H will recall two patches and key mode at one, displaying both in the Patch Number display window with Lower and Upper designations. Eight pairs of patches

chosen from the 64 Patch memories and key mode may be stored in the Patch Preset memories. Specifics for writing into, saving and loading the Patch Preset memories are given later in this Operation section. NOTE: If you select the whole Mode, only the Upper program of the pair will be displayed and played. This provides a handy shortcut, choosing specific individual patches for the Whole keyboard by pressing only one button rather than the two digits normally required.

When you enter the Split Mode from the Whole Key Mode, the patch previously used for the Whole keyboard will automatically be assigned to the Upper end of the keyboard. To assign a patch to the Lower end of the keyboard, press the dark blue Lower Panel Mode button to the immediate left of the Patch Number display window and select any patch you wish using the white Patch Number selectors. To Change either Patch number, merely select the appropriate Lower or Upper Panel Mode and Patch number.

Whichever method you use to assign two patches to the Upper and Lower ends of the Split keyboard, each end will now act freely as an independent four voice polyphonic synthesizer. The Split keyboard applications of the Hold, Portamento and Arpeggio functions will be addressed later.

The Dual Key Mode uses the entire Jupiter-8 keyboard at once to play two independent four voice synthesizers from the same keys, vertically layering the two for orchestration style playing or the building of complex patches. Selecting the two patches to be used follows the same procedures used for the Split keyboard, this time assigning the Lower and Upper designations to the Lower and Upper patch layers of the sound rather than to ends of the keyboard. In this Mode the Lower and Upper patches will appear at the appropriate Output jacks and the balance between those two and within the Mix Output will be effected by the Balance control. The Hold, Portamento and Arpeggio functions apply to the entire instrument at once.

Return the Jupiter-8 to the Whole Key Mode and select any patch before proceeding.

You can set a Split Point (the border between the UPPER and the LOWER sections) as you like when the KEY MODE is set to the SPLIT. Press any key you like while holding the SPLIT KEY MODE switch down (the LED of the SPLIT will light up), and the key will become the lowest note of the UPPER section. Once you set the Split Point, the effect lasts unless you turn the Power switch off or set a new Split Point. If you do not set a Split Point at all, the point marked on the panel automatically becomes the Split Point.

Assign Modes

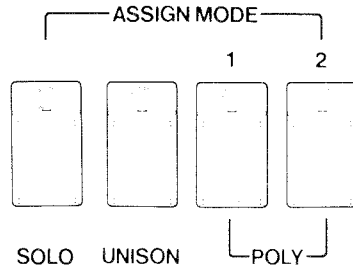

The four white Assign Mode selectors determine how the 8 voices (separate two oscillator synthesizers) available within the Jupiter-8 will be applied to the keys played and allow a scope of performance applications that would otherwise be impossible. Solo, Unison, Poly-1 and Poly-2 Assign Modes are available.

The Poly-1 Assign Mode is automatically selected when the instrument is switched 'On' and could be considered the normal position, producing the most natural sound from most patches. In Poly-1, each key pressed is assigned one voice (two VCO's) and will reach it's full natural release length.

Poly-1, Poly-2 and Unison Modes all follow the same basic keyboard logic, following first note priority. When eight notes are played and held, no new notes can be sounded until one of the original eight is released. When eight notes have been played and released (even if their Release time is incomplete), new notes will take over the voices of the previous notes in the order originally played. This basic logic allows the most natural, fluid playing from nearly all synthesizer patches.

Poly-2 is very similar to Poly-1, again assigning only one synthesizer voice to each key played. The primary advantage of Poly-2 is that only the last note or notes played together receive their natural Release length. Any notes played previously will have instantaneous Releases regardless of the patch programs. The difference between Poly-1 and Poly-2, then, is very similar to a Piano with the damper pedal held down or left up, respectively. Poly-1 is again the best for

most patches, but Poly-2 has the distinct advantage of reducing muddiness in musical passages played with patches having long Release lengths.

The Solo Assign Mode effectively turns the Jupiter-8 into a single voice synthesizer, using only one voice in Whole Mode or one voice for each section of the Split or Dual Modes. This Mode allows solo playing using special solo synthesizer techniques such as holding one key while alternating another to get tight, fast trills. Music learned on solo synthesizers may be freely transferred to the Jupiter-8 with no alteration in technique or extra practice. The Solo Mode uses Low Note priority.

Unison Mode assigns the maximum number of synthesizers available to each key played. All 8 synthesizers will be assigned to any one key pressed, dividing to four each for two keys, and so on until eight notes are played with one synthesizer each. The Unison Mode enjoys two clear advantages. First, single notes or chords with only a few notes will have the same thickness and impact as full chords to provide maximum strength that is especially useful for synthesizer-style sounds. Second, the total output level will remain the same regardless of the number of notes played a useful point to remember when recording.

All four Assign Modes may be used in any three of the available Key Modes. Poly-2 is automatically selected for the Arpeggio function, but may be overridden.

Arpeggio Section

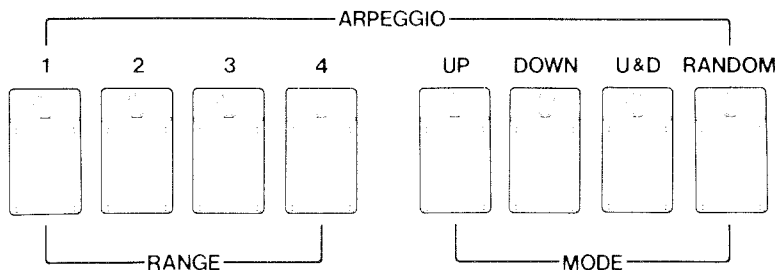

The Arpeggio Section of the Jupiter-8 allows a performer to sequence automatic Arpeggios from the keys played on the keyboard, shifting harmony freely as needed. Select any patch and press the U & D (Up and Down) Arpeggio Mode. When first selected, any Arpeggio Mode will automatically assign an Arpeggio Range of 4 Octaves and the Poly-2 Assign Mode. (NOTE: The JP-8 will memorize the last Arpeggio Range selected and return to that selection the next time an Arpeggio Mode is used. When the instru-

ment is switched 'Off', it will automatically return it's choice to Range 4.)

The Jupiter-8 will sequence any notes played on the keyboard, in the order that they are played, for the distance and in the direction set by the Arpeggio Section controls. Play one note and notice that it will Arpeggio Up and Down over a 4 Octave range, with a straight rhythm. Add more notes and the Jupiter-8 will add those to the Arpeggio sequence. If you use a

slow Arpeggio Rate and add new notes one at a time just before they enter, you can see that the Jupiter-8 will memorize and reproduce the actual order in which those notes were entered and will reproduce any sequence up to eight notes in length before repeating the pattern.

The four Arpeggio Modes determine its direction. The Up Mode will Arpeggio a given pattern in an upward direction for the distance selected by the Range selectors, and when the top note is reached return to begin again at the bottom of the sequence. The Down Mode follows the same procedure in a downward direction. The Up and Down Mode will Arpeggiate continually in a smooth Up the Down pattern.

The Random Mode will select notes at random from among those played and play them over the distance selected by the Range selectors. This results in an effect similar to Sample and Hold, but without the same destructive effect on harmony since the random Arpeggio is still within a controlled set of notes.

The Arpeggio Range selectors determine the maximum number of octaves that an Arpeggio will be transposed at it repeats. Range 1 limits Arpeggios to repeat the actual notes originally played. Range 2 allows consecutive repeats of the Arpeggio pattern to transpose one octave each time it is repeated, for a total transposing Range of 2 Octaves. The direction of transposition is determined by the Mode selectors. Ranges 3 and 4 increase this transposition Range to 3 and 4 Octaves respectively.

By combining the Arpeggio Mode and Range

selectors creatively, a wide variety of complex or simple patterns may be produced and controlled. The notes within the Arpeggio may be instantly changed by playing different notes on the keyboard, providing a clear advantage over sequencers which lock into specific harmonies.

By switching the Internal/External Arpeggio control switch to the External position, the rhythm of the Arpeggios can be determined by Triggers injected into the 1/4 inch Arpeggio Clock External Control socket. The BOSS DR-55 Programmable Rhythm Unit, the Roland CR-68 and CR-78 CompuRhythm units, TR-808 Rhythm Composer and CSQ Digital Sequencers will all interface with this connection.

A standard DIN connection is also provided for External Control of the Arpeggio Clock by actually linking to the clock output of units such as the Roland CSQ-600 Digital Sequencer or TR 808 Rhythm Composer. When the DIN connection is used, an associated 3 position switch allows the JP-8 Arpeggio section to respond with straight eighth notes, eighth note triplets, or sixteenth notes.

The Arpeggio section is most effective when used in conjunction with other Jupiter-8 features. By splitting the keyboard, you can achieve complex backing tracks from the Lower end while playing an independent four voice synth with the Upper end. When any Arpeggio Mode is selected while using the Split mode, the Arpeggio is automatically assigned to Lower end alone. In Whole and Dual Modes, the Arpeggio will accept notes played over the entire keyboard length.

Hold Selectors

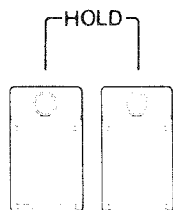

LOWER UPPER

The Hold selectors allow notes played to carry on indefinitely at their programmed Sustain levels. Either the Lower or Upper green Hold selectors will Hold any notes played while in the Whole or Dual Key Modes. The Lower and Upper selectors only achieve separate functions when used to Hold different ends of the Split Key Mode.

Any notes played after the Hold function is turned on will sustain until that Hold function is removed or until more notes are played than there are voices available. In this case, voices will be taken in the order that they were originally used so long as their keys are not physically held on the keyboard.

The Hold External Control jack on the back panel may

be used to activate the Hold function with an optional Roland DP-2 pedal. In either the Whole or Dual Key Modes, the DP-2 will activate the Hold function for the entire keyboard until it is released. Any Hold function switched 'On' manually will remain 'On' when the DP-2 is pressed, but will be switched 'Off' when the DP-2 is released. When used with the Split Key Mode, the DP-2 will activate the Hold function on the Lower end of the keyboard only, a significant convenience when using the Arpeggio function. In Split Mode, Hold may still be applied to the Upper end manually. DP-2 control over the Hold function is commonly used in a similar fashion to the damper pedal on a piano.

Performance Control Section

A Performance Control Section to the left of the Jupiter-8 keyboard includes three distinct sections, the Portamento controls, Auxiliary LFO controls, and Bender controls.

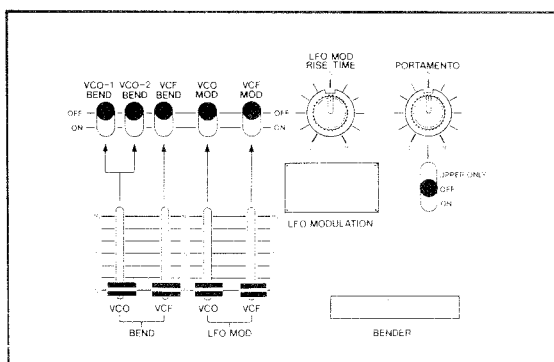

Portamento is a slide from one pitch to another, as notes on a Trombone might. The rotary Portamento control determines the time required to change pitches when different keys are pressed. The Jupiter-8 features polyphonic portamento that may be assigned to the entire keyboard, to the Upper end of a split keyboard, or switched 'Off' entirely using the associated three position switch. Once Portamento is assigned, notes will slide from the last pitch for any voice to the next new position for that voice. Pitch changes are instantaneous with the Portamento control set at '0', increasing in the time needed between notes as the control is turned clockwise. An External Portamento Control socket on the back of the Jupiter-8 allows an optional Roland DP-2 pedal to be used to remote control the Portamento function between 'Off' and the settings in the Performance Control Section.

The various Auxiliary LFO controls allow creative real-time control of LFO Modulation. Rather than programming a set depth of LFO Modulation with or without delay (options also included in the JP-8), these controls allow any LFO shape and rate set in a Patch program to be applied as needed during performance. Two silver 'On'/'Off' selector switches determine whether Auxiliary LFO Modulation will be applied to the VCO (for Pitch control), to the VCF (Tone Color control), or to both. Slider controls beneath each selector determine the actual depth of modulation (change) to be applied to the VCO and/or the VCF. The slider controls may be pre-set to desired depths of modulation, then selected as needed without altering their settings. This allows both accurate modulation depths and instant access to a variety of effects.

Any LFO Modulation set by these controls is then applied with a special 'On'/'Off' LFO Modulation touch pad located conveniently to the upper left of the Bender lever. This positioning allows separate, completely controllable Modulation and Bending effects simply and easily. A rotary LFO Modulation Rise Time control directly above the touch pad allows

LFO Modulation to be introduced gradually after the pad is pressed. LFO Modulation begins immediately with this control set at '0', introducing the lengthening it to its maximum as the control is raised to '10'.

The Bender controls allow you to change pitch and/or tone freely as you perform to add expression and spontaneity. The Bender lever itself is center-sprung to return to its original setting reliably after each bend for great speed and accuracy. The center position has no effect on the Jupiter-8's sound or settings, while the left and right extremes of movement achieve the same amount of bend in opposite directions.

The effect of the Bender is determined by the VCO and VCF selectors and Bend sensitivity slider controls. Separate silver 'On'/'Off' selectors are provided for Bender control of VCO-1 (the pitch of VCO-1 alone), VCO-2 (the pitch of VCO-2 alone), and VCF (Tone Color). These may be switched 'On' in various combinations allowing such sophisticated control as driving VCO-2 alone while it is Synced to VCO-1, achieving a tone color sweep that is very rich in harmonics. A good combination is a blend of VCO and VCF control for more dynamic pitch bending.

The associated Bend sensitivity slider controls allow the extreme limits of Bender control to be set in advance to the most useful musical interval or depth of effect.

The VCA and the tone color of the VCF may both be altered using volume pedals such as the optional Roland FV-2 in the appropriate EXternal Control input jacks on the back panel of the Jupiter-8.

The final Jupiter-8 performance control option is its complete, simple editing facility for every synthesizer function. Any synthesizer control can be altered during performance without changing the program, then that edit may be written into memory if desired. Details on this procedure will be covered later.

Synthesizer Voice

Each voice within the Jupiter-8 is a separate, complete synthesizer. Those synthesizers are all controlled from the upper portion of the Jupiter-8 control panel and include all controls to the right of the Arpeggio rate controls and above the row of switches. Every one of these controls and functions is programmable and may be edited during performance.

Voltage Controlled Oscillators

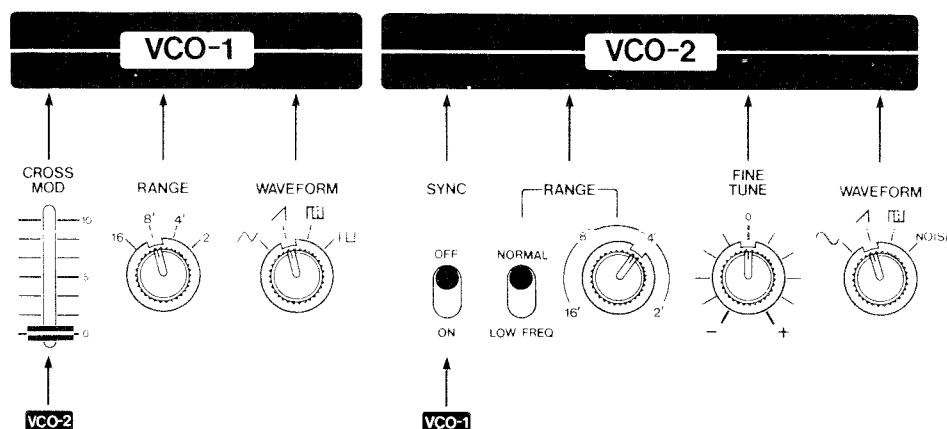

The Voltage Controlled Oscillators (VCO's) are the primary sound sources of your synthesizer. The Jupiter-8 contains two independent VCO's per voice to add extra thickness and flexibility to your sound. These oscillators, VCO-1 and VCO-2, are located to the left of center of the JP-8 synthesizer section.

Press the green Manual button located to the right of the Patch Number selectors to gain Manual control over the synthesizer and experiment as we proceed. Begin with the settings from Figure-1, using only VCO-1.

VCO-1 Pitch Control

The pitch produced by VCO-1 may be switched up or down manually in single octave increments by using the VCO-1 Range selector. Four different octaves are available: 16' (pronounced 'sixteen foot'), 8', 4' and 2'. These footages are standard pitch designations borrowed from organ technology, indicating specific pitches placed one octave apart.

The pitch of VCO-1 is also, automatically, controlled by the keyboard. Pressing keys at each extreme of

the keyboard while selecting each of the various Range selections will provide an aural picture of the pitches available from the Jupiter-8.

The general Tuning procedure for the Jupiter-8 has already been described. VCO-1 will always be in tune with the Master Tune knob and accurately represent keys pressed on the keyboard, ensuring that each of the 64 available patches you base on VCO-1 will be in perfect tune with one another.

Cross Modulation

The Cross Modulation slider located within VCO-1 allows the pitch of that oscillator to be changed with the output of VCO-2. With the slider at its lowest position, there is no pitch change. As the slider is raised, the pitch begins to change until it reaches the maximum effect at a setting of "10". If VCO-2 is in its

Normal, Audio range, Cross Modulation of VCO-1 will produce side bands for ring modulation style effects such as metallic sounds. If VCO-2 is set to function in its Low Frequency range, Cross Modulation of VCO-1 will produce a variety of LFO modulation effects.

VCO-1 Basic Tone Selection

Part of the VCO's role as a sound source gives you control over both the pitch of a note and its basic tone color, a tone that may be later modified in other sections. The Waveform selector within each VCO provides us with a variety of very distinct, precise tone colors from which to choose.

VCO-1 provides either Triangle, Sawtooth, variable Pulse, or Square waves. The Triangle wave (∇) is a very pure tone color that is particularly useful when VCO-1 is being Cross Modulated by the Normal, Audio, output of VCO-2, or when mixed with VCO-2 for additive synthesis. The second waveform/tone color option is the Sawtooth wave (\sloperight), commonly used for string, brass and rich synthesizer sounds.

The third option is a variable Pulse wave () which actually provides a variety of different tone colors. It can sound anywhere from hollow and wooden to nasal in quality, or actually change with a continuous sweeping motion or a single, shaped motion for a more dynamic sound. The controls for the variable Pulse wave for both VCO's are found in the Pulse Width Modulation section of the VCO Modulator and

will be described with that section.

The fourth and final VCO-1 waveform/tone color option is the Square wave (), a very distinctive sound similar to that of a clarinet or xylophone. This waveform can stand alone for many different patches, but also lends itself well to mixing with other waveforms from VCO-2.

VCO-2

Voltage Controlled Oscillator-2 is a second, independent sound source. It's controls are specifically designed to suit its intended uses and differ slightly from those of VCO-1.

VCO-2 Pitch Control

The VCO-2 Range Control covers the same pitch range as VCO-1, from 16' to 2'. This Range control, however, is quantized so that the pitch will change in half steps as the rotary control is swept through its range. Footage markings for 16', 8', 4', and 2' are provided to indicate the points at which VCO-2 will be in tune with VCO-1 in those relative octaves. Regardless of the tuning of VCO-2, both VCO's will travel in parallel motion unless one of them is interfered with through other controls.

This manual control of VCO-2's pitch is complemented with the Fine Tune knob which allows adjustment between the discreet half steps selected by the VCO-2 Range control. The Fine Tune knob has a

variable Range of ± 50 cent from 12 o'clock position.

The final manual control of the pitch of VCO-2 is the Normal/Low Frequency Range switch located to the left of the VCO-2 Range control. With this switch in the Normal position, VCO-2 will function in the same pitch/frequency range as VCO-1, producing only audio frequencies that will follow the keyboard normally. When switched into Low Frequency range, VCO-2 will produce only low frequency signals which cannot be heard but which can be used as a control signal for manipulating VCO-1 through Cross Modulation. The frequencies produced in this range are not effected by the keyboard.

Sync Switch

The Sync switch within VCO-2 forces the pitch of that oscillator to synchronize itself to that of VCO-1. This may be used to provide simple beat-free tuning between the two oscillators. The most common use of Syncing, however, modulates the intended pitch of

VCO-2 sharp of VCO-1, resulting in a wide variety of tone colors and effects which are very rich in harmonics. VCO-2 may be modulated by the LFO Modulator, Envelope-1 or the Bender section to produce these results.

VCO-2 Tone Color Selection

The Waveform selector for VCO-2 is very similar to that of VCO-1. It's first three Waveform options are sine (a perfectly pure tone color with no overtones), Sawtooth and variable Pulse waves. The fourth option offered by VCO-2 is a Noise source, producing a random mixture of all frequencies resulting in a hiss that may then be processed to produce a wide variety of effects or mixed with VCO-1.

VCO Modulator Section

VCO MODULATOR

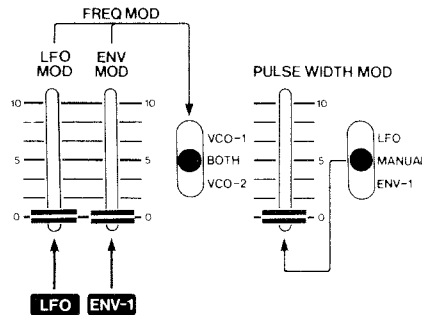

The Frequency Modulation section of the VCO Modulator applies the outputs of the LFO and Envelope-1 to control either or both VCO's. The LFO slider introduces regular, recurring fluctuations in pitch relating to the shape, speed and any delay set in the LFO section. With the slider set at '0' there is no modulation, which begins and increases to maximum as the slider is raised to '10'.

The Envelope Modulation slider introduces a single, shaped pitch change relating to the output of Envelope-1. Again, the slider control is variable from no modulation at '0' to maximum modulation at '10'.

The combined output of these two sliders may be applied to VCO-1, VCO-2, or Both. This is determined by a three position silver switch located directly to the right of the frequency Modulation sliders.

The Pulse Width Modulation section of the VCO Modulator controls the variable Pulse waveforms of both VCO-1 and VCO-2. With its silver three position selector in the Manual position, and the accompanying slider set at '0', it begins with a Square wave. Raising that slider gradually to '10' takes the waveform through a continuously narrowing Pulse wave, sounding progressively more nasal. Moving the three position selector to either its LFO or Envelope-1 position obtains a tone which is actually in motion within the spectrum of change available by moving the slider while in Manual Mode. Here is a voltage con-

trolled waveform, beginning with a Square wave and moving automatically through a narrower, more nasal Pulse wave, and back again.

The LFO position gives a continuously sweeping, smooth tone change pivoting from the basic Square wave. With the Pulse Width Mod. slider at '0' there is no Pulse Width Modulation, no tone change. As the slider is raised, the tone varies correspondingly further away as it swings away from the Square wave to the extreme limit set by the slider and back again in a repeating pattern. The speed and shape of modulation are set within the LFO section itself. One common application applies an LFO sine wave at a suitable speed and depth to produce an effect similar to having a phase effect unit within the synthesizer.

The Envelope-1 position gives a single, shaped change in tone moving away from and returning to the Square wave position once each time the pressing of a key activates the Envelope. The shape and length of this change is determined by the Envelope settings and how the Envelope itself is manipulated by the keyboard. The slider within the Pulse Width Modulation section determines only how far the Envelope voltage will change the tone color from its basic Square wave position. The Pulse Width Modulation controls apply in an identical fashion to either VCO-1 or VCO-2 or both, whenever their waveform selectors are in the variable Pulse wave position.

LFO Section

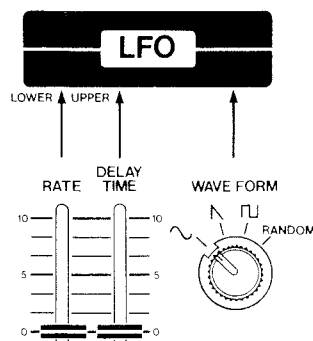

The Low Frequency Oscillator (LFO) section is used for producing regular changes in pitch and tone color such as vibrato, tremolo, trills and various effects. The LFO also includes a Sample & Hold circuit. The output of the LFO may be applied to modulate the pitch of the VCO's, the tone of the variable Pulse waveforms, and tone and/or pitch within the VCF.

The rotary Waveform selector determines which waveform will be used for VCO and/or VCF modulation. The four options include a Sine Wave (\sim), inverted Sawtooth wave (\sloperightarrow), Square wave (\square) and a Random output from the Sample & Hold circuit.

The Rate slider controls the frequency (speed of change) for the LFO output. Raising the control increases the frequency, which may be monitored with the associated flashing LED indicators. Two LED indicators are used. They will flash together when in the Manual patch mode or when the Whole Key Mode. The two LED's will flash independently to indicate the LFO speed of the Lower and Upper sections

whenever the Jupiter-8 is in Dual or Split Key Mode.

When the Delay Time slider is raised, pressing a key on the keyboard will delay the introduction of the LFO output to the VCO and VCF. Raising the slider increases the delay time, lowering it fully results in a continuous output with no delay. The Delay Time control effects all waveform outputs of the LFO section.

Source Mixer

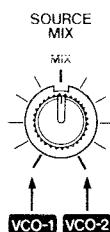
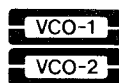

The Audio Outputs of VCO-1 and VCO-2 are routed through a Source Mixer on their way to the Jupiter-8's filter sections. The rotary Source Mixer control provides an infinitely variable mix between the two VCO's. In it's fully counter-clockwise position only

VCO-1 is heard. As the control is rotated clockwise, VCO-1 decreases and VCO-2 increases level in direct proportion to each other, through an equal mix at the 12 o'clock position, until only VCO-2 is heard in the fully clockwise position.

High Pass Filter

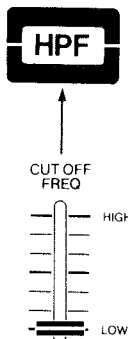

The output of the Source Mixer is routed directly through the High Pass Filter section, which may be used to alter the tone color by removing portions of the lower harmonics of that sound. The Source Mixer output is unchanged with the HPF Cutoff Frequency

set at 'Low', becoming progressively less full in body of tone color as the HPF slider is raised. This control is especially effective in making fine adjustments to patches and in pursuing imitations of acoustic instruments. The cutoff slope of the HPF is -6dB/octave .

Voltage Controlled Filter Section

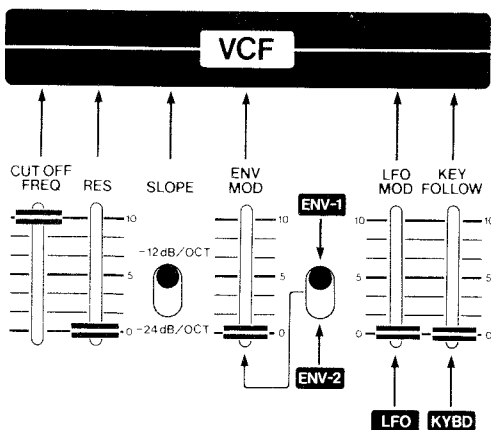

The VCF section is also used to alter the tone color of the Source Mixer output by cutting and boosting harmonics in that sound. The tone color may be altered manually or automatically through voltage control as notes are played. The VCF is a selectable slope low Pass Filter which passes low frequencies and blocks high frequencies.

The Cutoff Frequency determines how much of any tone color will be filtered away by the VCF, and is effected by a manual Cutoff Frequency control slider and various automatic controls. With the manual Cutoff slider in its highest position the sound will pass unchanged through the VCF. As the Cutoff Frequency point is lowered by lowering the slider control the sound will become progressively more mellow in tone color until it is filtered away to silence at the lowest position. This control function acts as a starting position for all other control functions within the VCF section.

The VCF Resonance control emphasises the frequencies at the point where the Cutoff Frequency begins to filter a sound. It has a subtle effect on tone colors that are not modulated within the VCF, but is most often used to emphasise motion within the filter. Set at '0' the Resonance will have no effect.

The two position VCF Slope selector offers a choice between a rich -24dB/octave cutoff slope and a more acoustic -12dB/octave cutoff slope to provide increased control over the tone colors of the Jupiter-8. The -12dB position permits more high frequencies to pass at any given Cutoff point, creating a brighter tone which is helpful in creating authentic acoustic-style and string ensemble sounds. The -24dB position produces a strong, distinctive tone with more bass frequencies and fewer highs at the same Cutoff points and is normally used for solid, classic synthesizer sounds.

Modulation of the VCF, changing the tone color during musical notes, is critical to many synthesizer sounds. Some synthesized sounds are based on a 'passive' filter, a fixed Cutoff Frequency setting with no modulation or change in tone. Others depend on the tone changing 'actively' during the length of each note, either a repeating change controlled by the output of the LFO section, or a single sweep initiated by the output of an Envelope section. The most basic demonstration would be to compare basic string and brass patches. The prime difference between these two sounds is the 'passive' filter of the string patch as contrasted to the 'active' filter of the brass patch.

The VCF Envelope Modulation control determine the depth to which either the output of Envelope-1 or Envelope-2 will modulate the VCF Cutoff point. With the slider control at '0' there is no modulation, which enters and increases gradually as the control raised to full depth at '10'. The associated two position Envelope Selector determines whether Envelope-1 or Envelope-2 will be used to modulate the VCF. It is helpful to think of these controls in terms of the Cutoff Frequency settings - the Cutoff cannot be modulated positively if already fully raised, nor negatively if fully lowered.

The LFO Modulation slider control within the VCF section allows the Cutoff Frequency/tone color to be modulated with the output of the LFO section. It determines the depth of modulation whose shape, rate and delay were selected in the LFO section. Modulation increased as the slider is raised, with no modulation when set at '0'. The most common application of LFO modulation of the VCF would be to apply a delayed LFO sine wave to produce tremolo effects. Again remember to 'leave room' - if the Cutoff Frequency slider is in either extreme position, any tremolo would lose its smoothness as only half of its cycle (which alternates between positive and negative modulation) could have any influence on what is heard.

The Key Follow VCF control applies the Keyboard Control Voltage normally used to control the pitch of the VCO's to control the VCF Cutoff point. This allows the tone color to subtly follow pitch, the way acoustic instruments do. With the Key Follow slider at '0', the Cutoff point will not move in relation to pitches played, allowing higher pitched notes to actually sound more mellow than notes pitched lower with the same patch. Key Follow will begin to effect the Cutoff point as the slider is raised, passing through a point where all pitches will have the same tone color, and finally arriving at '10' where the tone color actually brightens as higher pitches are played.

Also Key Follow's center point is center C of keyboard. Otherwise, when Key Follow slide is raised, Upper end from center C will become more brighten and Lower end will become more mellow.

Remember that the VCF Cutoff point may also be effected by the Bender and LFO Modulation controls within the Performance Controls section previously described.

Voltage Controlled Amplifier

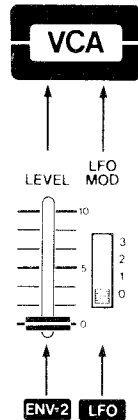

The output of the VCF section now passes through the VCA on its way to the various outputs on the Jupiter-8 back panel. The VCA does not actually amplify the sound, but controls the shape of its volume. Level and LFO Modulation controls are both provided.

The VCA Level control slider allows the loudness contour of sounds passing through the VCA to be controlled by the output of Envelope-2. The slider determines the depth of modulation whose shape has been determined by the Envelope-2 controls and activated from the keyboard. Loudness increases as the slider control is raised, with silence when the control is

lowered to '0'. This control allows each patch to be programmed at a suitable volume level so that distortion can be avoided and so that programs may be selected and played without the need to hastily adjust the volume levels during performance.

The VCA LFO Modulation control is a four position switch which applies the output of the LFO section to modulate the output level to produce tremolo and other effects. There is no effect with the selector set at '0', with three progressively deeper Levels of modulation appearing at switch positions '1', '2' and '3' respectively.

Envelope Generators

The two Envelope Generators each produce a shaped control voltage that may be used to manipulate various Voltage Controlled functions within the Jupiter-8. They are activated simultaneously by 'On'/'Off' Gate switching signals from either the keyboard, the Arpeggio section, or an external Arpeggio control source, depending upon the mode of operation. Each envelope is a complete four segment ADSR, a term made from the initial letters of the words Attack, Decay, Sustain and Release — the four slider functions within the Envelope Generators.

The Attack slider controls the amount of time required for the Envelope voltage to reach its maximum level after a Gate signal is received. This Attack time is virtually instantaneous with the slider set at '0', lengthening as the slider is raised.

The Decay slider controls the amount of time required for the voltage to fall from its level at the end of the Attack time to the level set by the Sustain control.

Again, Decay time is virtually instantaneous with the slider set at '0'. Lengthening as the slider is raised. The Sustain control determines the level to which the voltage will fall at the end of the Decay time. Once this level is reached it will be held until the Gate Signal is removed. A Sustain level of '0' will Decay to and hold at silence, effectively cancelling Sustain. A Sustain level of '10' will not Decay, but will remain at '10', effectively cancelling Decay. Sustain levels between these extremes combine with the various Decay times available to subtly shape the internal contour of notes as they are held.

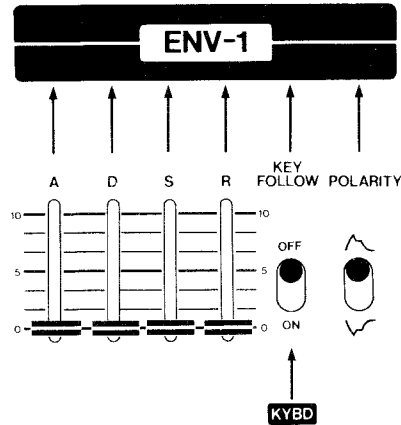

The Release slider determines the amount of time required for the voltage to fall to its minimum level after the release of the Gate signal. The Release will begin at any time within the Attack, Decay or Sustain portions of the Envelope as instructed by the release of the Gate signal.

Envelope-1



Envelope-1 includes two extra controls in addition to its ADSR sliders. Switching the exclusive Key Follow 'On' allows the Attack, Decay and Release lengths to shorten in direct relation to the height of pitches played in a similar manner to most acoustic instruments.

The two position Polarity switch allows the output of

Envelope-1 to travel in its normal positive direction (), or to be inverted to follow its own mirror image () providing a sophisticated control option. Envelope-1 may be assigned to control the Pulse Width of either or both VCO's, the pitch of either or both VCO's or the VCF Cutoff point.

Envelope-2

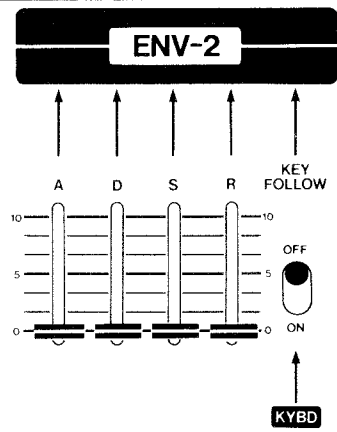

Envelope-2 includes a Key Follow option in addition to its ADSR slider controls. Envelope-2 may be assigned

to control the VCF Cutoff point and the loudness contour of the VCA.

Writing Patches into Memory

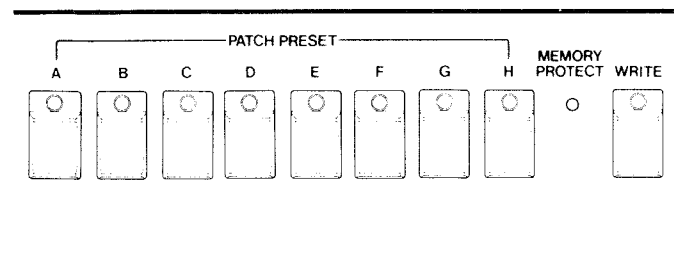
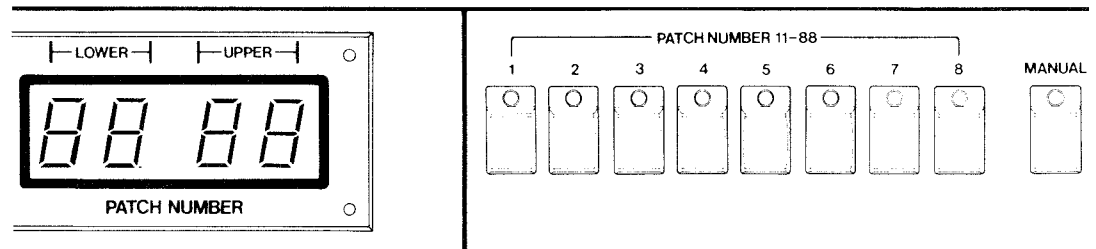

Every one of the synthesizer controls just described can be written into the Jupiter-8's Patch memories. Prepare to Write by switching the Memory Protect on the back panel to the 'Off' position, so that the Memory Protect LED on the front panel is extinguished. If you wish the Manual patch settings to be memorized be sure that the green Manual patch selector is lit before proceeding.

To write that manual patch into memory, first of all, depress "Manual" button and then produce your favorite sound with JP-8's panel controls. After the end of this operation, depress "Write" button. LED's of Patch Number and Patch Preset will begin to flash intermittently, which display "Input condition". Then set the two digits of Patch Number position you wish to fill. Your Manual Patch is now in memory! Moreover, in "Write" operation, by setting the patch Number while keeping to depress "Write" button, its Patch Number can be protected individually.

When you want to cancel "Write" mode, push again "Write" button. So LED's will stop to flash intermittently and "Write" mode will be canceled. Also when

you want to cancel each Patch Number Protect, push two times its Patch Number after depressing "Write" button. In this operation, its Patch Number can be memorized.

Data of Protect On/Off in each Patch Number can be saved on ordinary cassette tape.

The procedure for writing any patch already in the Patch memories into another position is the same. Select the Patch number you wish to copy so that it appears in the Upper part of the Patch Number display window. Press Write and the new Patch number. Using this simple procedure you can move you patches to different positions within the 64 programs until you find the placement that suits you best.

To write a pair of programmed patches and key mode into the Patch Preset memories, select either the Dual, Split or Whole Key Mode and enter the two patch numbers so that they appear in the proper positions in the Patch Number display window. Follow the same procedure by pressing Write and then the Patch Preset letter desired.

Editing Programs

Any program in use can be Edited as you play by merely moving the control you desire to change. As the control passes the position originally programmed, in either direction, that particular function will leave the control of the program and enter manual control. The moment that the control function switches from program to manual control it has entered the Edit mode, indicated by two LED indicators below the Patch number in the display window. At this point the

Edit function does not rewrite the memory — it merely alters the Patch being used as a form of sophisticated real time performance control.

To write and Edit into memory, press the Write switch and then the Patch number desired. An Edit may be written over the original Patch position or written as a complete new program in a new position without effecting the original program.

Tape Memory

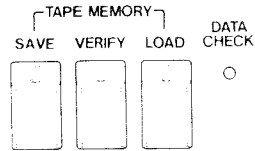

The Jupiter-8 Tape Memory section allows the 64 Patch Programs and 8 pairs of Patch Preset memories to be Saved into an ordinary tape recorder for storage and later retrieval. This is to protect your memories - the Jupiter-8's automatic recharging battery backup system will retain its memories virtually permanently until they are rewritten. The advantage of the Tape Memory section is the ability to build up a library of Jupiter-8 memories with specific sets of patches organized to suit different applications.

Connect the Jupiter-8's Tape Memory Save jack to the Record In of your tape recorder (use a Line if one is available). Connect the JP-8's Load jack to the Play Out of your tape recorder, making sure you are using the same channel connected Record the Save output. The Jupiter-8 will produce a complex series of pitched pulses that must be recorded and played back accurately for reliable results. It pays to clean your record heads, use a high quality tape, use any available noise reduction, and use relatively high input and output levels.

To Save a complete set of 64 Patches and 8 Patch Preset pairs,

- A) Press the JP-8 Save button. The JP-8 will send a Pilot tone to your tape recorder, indicated by a double dash (— —) in the Patch Number display window. If possible, adjust your tape recorder so that the Pilot tone registers near 0dB.
- B) Begin Recording with your tape recorder, beginning with a clear portion of the Pilot tone. The JP-8 will soon produce a modulated tone and indicate which Patch numbers are being saved at any given moment by displaying those numbers in the Lower portion of the display window.
- C) When the Jupiter-8 has saved its entire memory (ending with the number 88), the Pilot tone will appear again then drop to silence and the display window will become blank to indicate the end of the Save sequence. Record enough of the silence to separate different JP-8 program memories on the same tape.

The Jupiter-8 includes the special ability to assign a File number to each set of programs saved, to make later identification easier. Merely select one of the 64 available Patch numbers and place it in the Upper section of the Patch Number display window before the Save procedure is begun. This number will be memorized along with the rest of the JP-8 memories and will be displayed in that position whenever that tape memory is played back into the Jupiter-8.

The Jupiter-8 includes a special Verify function to allow you to check the accuracy of your tape recorded memories before you change any memories in the JP-8, providing extra securing against accidental loss of your precious programs. To Verify a complete set of 64 Patches and 8 Patch Preset Pairs,

- A) Play back the recorded set of JP-8 programs at a relatively high level, adjusting the tape recorder output until you obtain the brightest and most continuous signal from the JP-8's Data Check LED. Once you

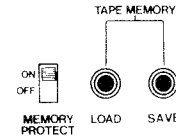

have made your adjustments, begin tape playback with the Pilot tone and press the JP-8 Verify switch. B) If your recorded memory is accurate and is being played back clearly and at the correct level, the JP-8 will now proceed to display all 64 Patch numbers in sequence as it did in the Save mode. If the entire sequence is completed, the tape memory is accurate and secure.

C) If there is an error in your recorded memory or its playback, Patch Number of Upper section of the Display window will begin to flash intermittently. Return to the beginning of the Verify procedure, check your tape recorder's heads, levels and connections, and try again. If an Error is again indicated, repeat the Save procedure again carefully, preferably on a different portion of the tape. Continue until your tape memory passes the Verify test.

To Load a complete set of 64 Patches and 8 Patch Preset pairs,

- A) Adjust the tape output level according to the JP-8 Data Check indicator. Once this adjustment has been made, begin tape playback with the Pilot tone and press the JP-8 Load switch.
- B) The JP-8 will indicate the File number of the program being loaded in the Upper portion of the display window, and the Patch numbers being loaded at any given moment in the Lower portion of the display window. When the entire sequence has ended and the display window becomes blank, the Load procedure is complete and the Jupiter-8 may be played normally using the new set of programs.

Strike Save (Verify, Load) key to quit Save (Verify, Load) operation.

If errors have been detected, the display window keeps the flashing patch number until you hit any key.

The Jupiter-8 Tape Memory section includes some very special features which make Tape Memories more useful. Any Bank of patches (such as the 'teens, twenties, etc.) may be Saved, Verified and Loaded by itself or in combination with any other banks. This allows specific parts of any Jupiter-8 program to be stored or recalled without effecting the rest of a program. The procedure is exactly the same as Saving, Loading and Verifying with one simple addition. Immediately after pressing the Save, Load or Verify switch, press the white Patch Number switches for the bank or banks you wish to include in your procedure. This will limit the process to the banks you have chosen.

If you wish to Load specific parts of entire programs you have saved onto tape, it is even possible to drop into that program and load that information into any new banks you wish. To accomplish this, begin the Verify procedure. The instant before you reach the specific patch number you wish to begin loading, press the Load button and then the bank or banks you wish to Load. The Jupiter-8 begins Loading at that point.

The Patch Preset memories are dealt with as a group and are the first items loaded, saved or Verified in any of those procedures. Remember that these memories are pairs of numbers referring to patches within the 64 available Patch memories, not a separate set of patches.

When you are completely finished with the Tape Memory section of the Jupiter-8, always return the Memory Protect switch on the back panel to the 'On' position so that the LED indicator on the front panel is lit.

JUPITER-8

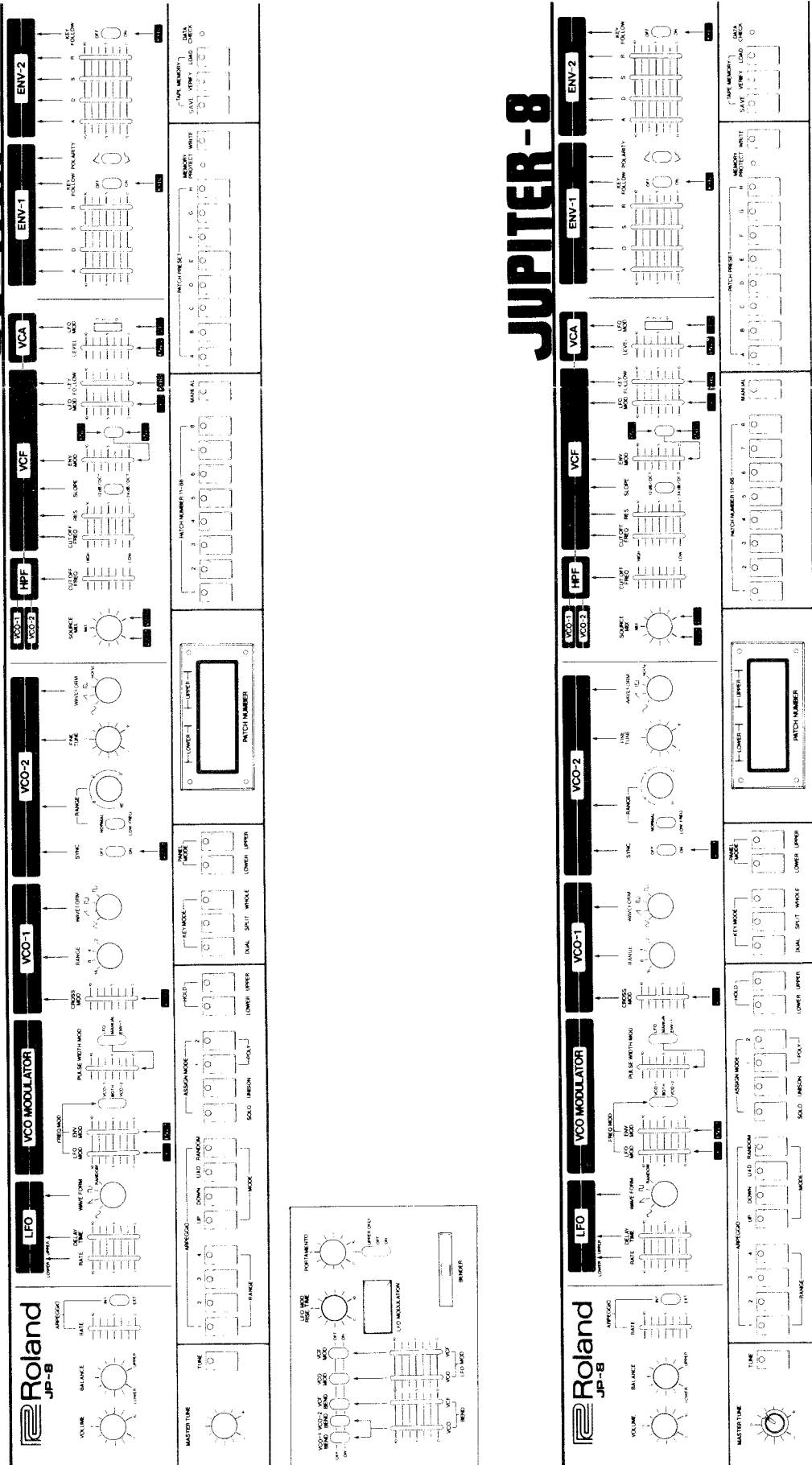

JUPITER-8

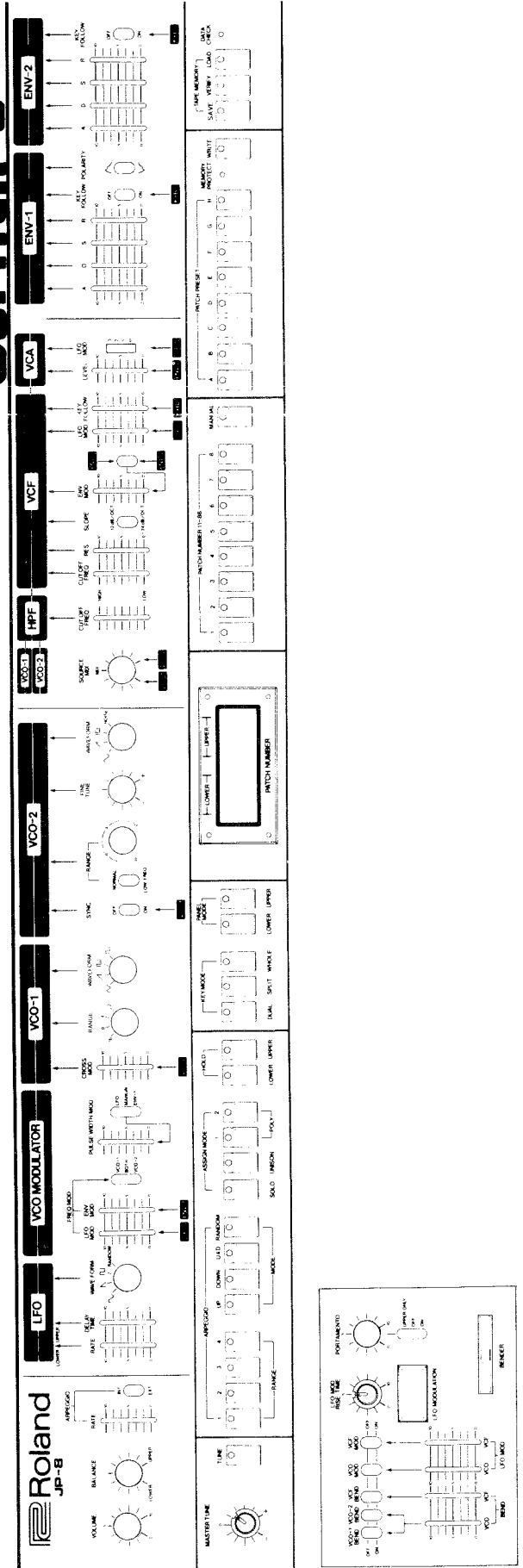

JUPITER-8

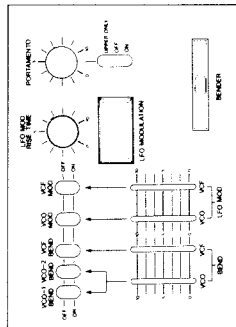
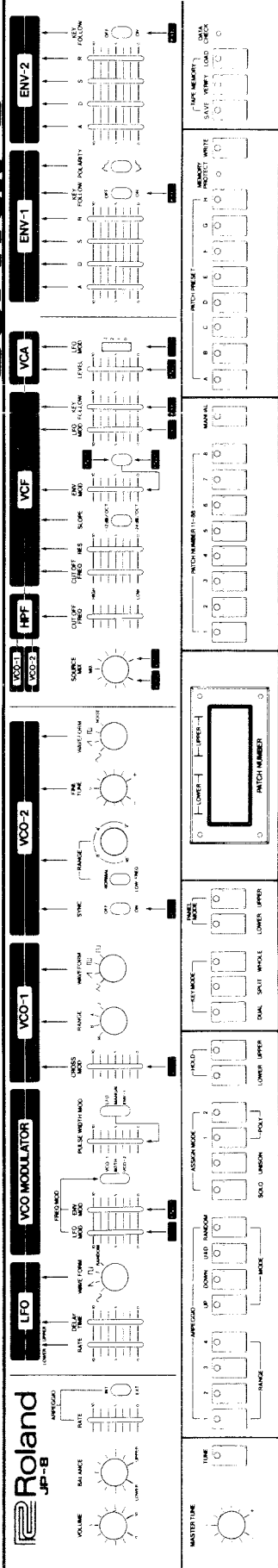

JUPITER-8

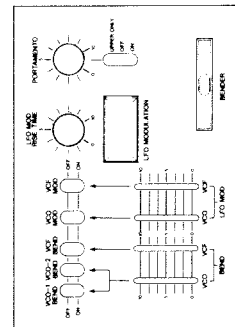
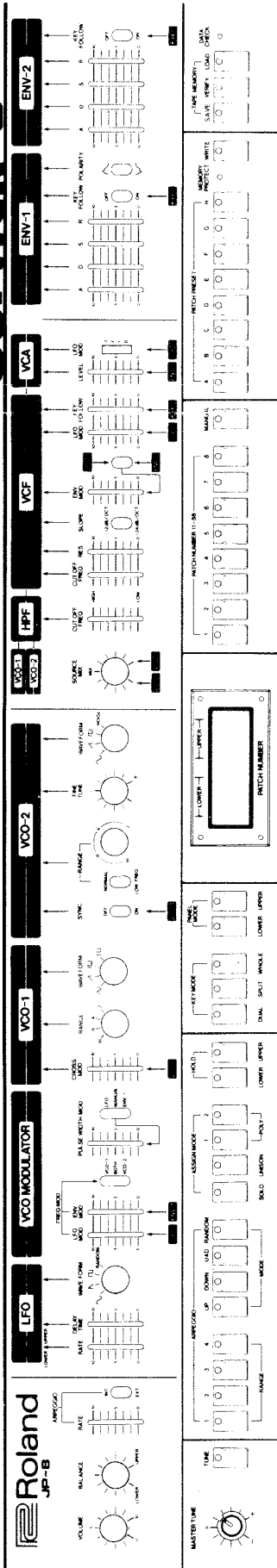

JUPITER-8

Roland JP-8

VOLUME **BALANCE** **MASTER TIME**

LFO **AMP/EGG** **RATE** **PORTAMENTO**

VCO MODULATOR **TRIG. MOD.** **WAVEFORM** **WAVEFORM** **WAVEFORM**

VCO-1 **RANGE** **SYNC** **KEY MODE** **DUAL SPLIT WHOLE** **LOWER UPPER**

VCO-2 **RANGE** **SYNC** **KEY MODE** **DUAL SPLIT WHOLE** **LOWER UPPER**

HPF **OUT/IN** **SELECT** **RES.** **SLOPE** **MANUAL**

VCF **LEVEL** **LOAD** **AT 20K** **MANUAL**

VCA **LEVEL** **LOAD** **AT 20K** **MANUAL**

ENV-1 **ENV-2** **TIME MEMORY** **DATA** **SLAVE** **WRITE** **LOAD** **CHECK**

TIME **AMP/EGG** **UP** **DOWN** **LFO** **RANDOM** **ASSIGN MODE** **SOLE** **UNISON** **LOCK** **LOWER** **UPPER**

1 **2** **3** **4** **5** **6** **7** **8** **9** **10** **11** **12** **13** **14** **15** **16** **17** **18** **19** **20** **21** **22** **23** **24** **25** **26** **27** **28** **29** **30** **31** **32** **33** **34** **35** **36** **37** **38** **39** **40** **41** **42** **43** **44** **45** **46** **47** **48** **49** **50** **51** **52** **53** **54** **55** **56** **57** **58** **59** **60** **61** **62** **63** **64** **65** **66** **67** **68** **69** **70** **71** **72** **73** **74** **75** **76** **77** **78** **79** **80** **81** **82** **83** **84** **85** **86** **87** **88** **89** **90** **91** **92** **93** **94** **95** **96** **97** **98** **99** **100**

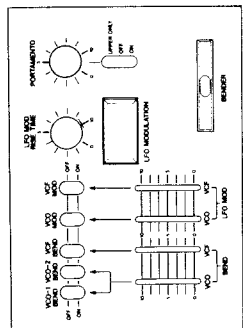

JUPITER-8

Roland JP-8

VOLUME **BALANCE** **MASTER TIME**

LFO **AMP/EGG** **RATE** **PORTAMENTO**

VCO MODULATOR **TRIG. MOD.** **WAVEFORM** **WAVEFORM** **WAVEFORM**

VCO-1 **RANGE** **SYNC** **KEY MODE** **DUAL SPLIT WHOLE** **LOWER UPPER**

VCO-2 **RANGE** **SYNC** **KEY MODE** **DUAL SPLIT WHOLE** **LOWER UPPER**

HPF **OUT/IN** **SELECT** **RES.** **SLOPE** **MANUAL**

VCF **LEVEL** **LOAD** **AT 20K** **MANUAL**









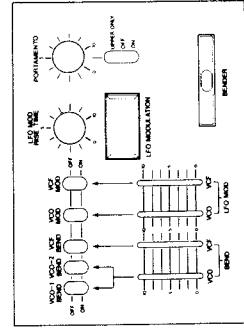

VCA **LEVEL** **LOAD** **AT 20K** **MANUAL**

ENV-1 **ENV-2** **TIME MEMORY** **DATA** **SLAVE** **WRITE** **LOAD** **CHECK**

TIME **AMP/EGG** **UP** **DOWN** **LFO** **RANDOM** **ASSIGN MODE** **SOLE** **UNISON** **LOCK** **LOWER** **UPPER**

1 **2** **3** **4** **5** **6** **7** **8** **9** **10** **11** **12** **13** **14** **15** **16** **17** **18** **19** **20** **21** **22** **23** **24** **25** **26** **27** **28** **29** **30** **31** **32** **33** **34** **35** **36** **37** **38** **39** **40** **41** **42** **43** **44** **45** **46** **47** **48** **49** **50** **51** **52** **53** **54** **55** **56** **57** **58** **59** **60** **61** **62** **63** **64** **65** **66** **67** **68** **69** **70** **71** **72** **73** **74** **75** **76** **77** **78** **79** **80** **81** **82** **83** **84** **85** **86** **87** **88** **89** **90** **91** **92** **93** **94** **95** **96** **97** **98** **99** **100**



| | |
|----------------------------|--|
| Keyboard | 61 Key (5 octave) |
| VCO Modulator | LFO Mod ENV Mod Mod Switch (VCO-1/Both/VCO-2) Pulse Width Mod PWM Mode Switch (LFO/Manual/ENV-1) |
| VCO-1 | Waveform (   ) Range (16'8'/4'/2') Cross Mod |
| VCO-2 | Waveform (   Noise) Range (16'—2') Range (Normal/Low Freq) Fine tune (± 50 cent) Sync (On/Off) |
| Mixer | Source Mix (VCO-1, VCO-2) |
| HPF | Cutoff Frequency |
| VCF | Cutoff Frequency Resonance Slope Selector (-12 dB/oct/ -24 dB/oct) ENV Mod ENV Selector (ENV-1/ENV-2) LFO Mod Key Follow (0—120%) |
| VCA | Level LFO Mod (0, 1, 2, 3) |
| ENV-1 | Attack time (1mS—5S) Decay time (1mS—10S) Sustain level (0—100%) Release time (1mS—10S) Key follow (On/Off) Polarity (Normal/Inverse) |
| ENV-2 | Attack time (1mS—5S) Decay time (1mS—10S) Sustain level (0—100%) Release time (1mS—10S) Key follow (On/Off) |
| LFO | Waveform (   Random) Rate (0.05Hz—40Hz) Delay time (0—4S) |
| Volume Balance | (Upper, Lower) |
| Master tune Tune button | (± 50 cent) (Compu tune) |
| Arpeggio | Rate (1Hz—20Hz) Clock selector (Int/Ext) Range (1, 2, 3, 4) Mode (Up, Down, U & D, Random) |
| Assigner | Mode (Solo, Unison, Poly-1, Poly-2) |
| Hold | Lower Hold Upper Hold |

| | |
|--------------------|--|
| Key mode | Dual, Split, Whole |
| Panel mode | Lower, Upper |
| Patch number | display (7 Segment LED x 4) |
| Patch memory | Patch number button (64 memory) Manual button Patch preset button (8 preset) Write button Memory protect indicator |
| Tape memory | Save button Verify button Load button Data check indicator |
| Portamento | Time Mode (Upper only/Off/On) |
| Bender | Bender lever VCO bend sensitivity VCO-1 bend SW VCO-2 bend SW VCF bend sensitivity VCF bend SW |
| LFO Mod | On/Off button Rise time VCO Mod sensitivity VCO Mod SW VCF Mod sensitivity VCF Mod SW |
| REAR PANEL | |
| Audio Out | Upper (Balanced, Imp = 600ohm, 0dBm) Lower (Balanced, Imp = 600ohm, 0dBm) Upper (Unbalanced, Imp = 1 kohm, 0dBm/ -20dBm) Mix (Unbalanced, Imp = 1 kohm, 0dBm/ -20dBm) Lower (Unbalanced, Imp = 1 kohm, 0dBm/ -20dBm) Level (0dB/ -20dB) Phones Jack (8 ohm Stereo) Phones level (L/M/H) |
| Ext control | Hold Portamento VCF VCA |
| Arpeggio clock | Input Jack (1step/1pulse) DIN Beat selector |
| Highest note | CV Out (0—5V) Gate Out (Off:OV, On: 15V) |
| Tape memory | Load Save |
| Memory protect | (On/Off) |
| DCB | Ext. Key Mode Switch |
| Dimension / Weight | 1063(W) x 485(D) x 120(H)mm / 22kg. 41 ⁷ / ₈ (W) x 19 ¹ / ₈ (D) x 4 ³ / ₄ (H)in. / 48 lb. 8 oz. |
| Power | 90W |

note : Lithium battery needs replacement every 3years.

Specification are subject to change without notice.

Roland®

10173

UPC 10173



10961

Roland®