

Roland®

HPi-5 Roland Digital Piano

Owner's Manual

Congratulations on your choice of the Roland Digital Piano HPi-5.

Before using this unit, carefully read the sections entitled: "USING THE UNIT SAFELY" and "IMPORTANT NOTES" (p. 2; p. 4). These sections provide important information concerning the proper operation of the unit. Additionally, in order to feel assured that you have gained a good grasp of every feature provided by your new unit, Owner's manual should be read in its entirety. The manual should be saved and kept on hand as a convenient reference.

Musical Score Shown In A Large LCD Screen

The musical score can be displayed not only for the internal songs, but also for commercially available song files.

Lyrics and fingering numbers can also be displayed.

* The fingering numbers are displayed only for some of the internal songs.

Authentic Piano Performance

High-quality concert grand piano tones, along with the Progressive Hammer Action Keyboard, which gives more realistic piano touch let you enjoy truly authentic piano performances.

Easy Game-like Operation

After pressing the button for the desired function, operation consists basically of pressing the cursor buttons and [O] [X] buttons located in the center of the panel. You can enjoy versatile performance with easy operation.

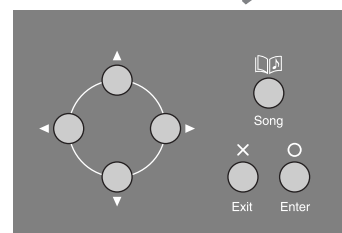
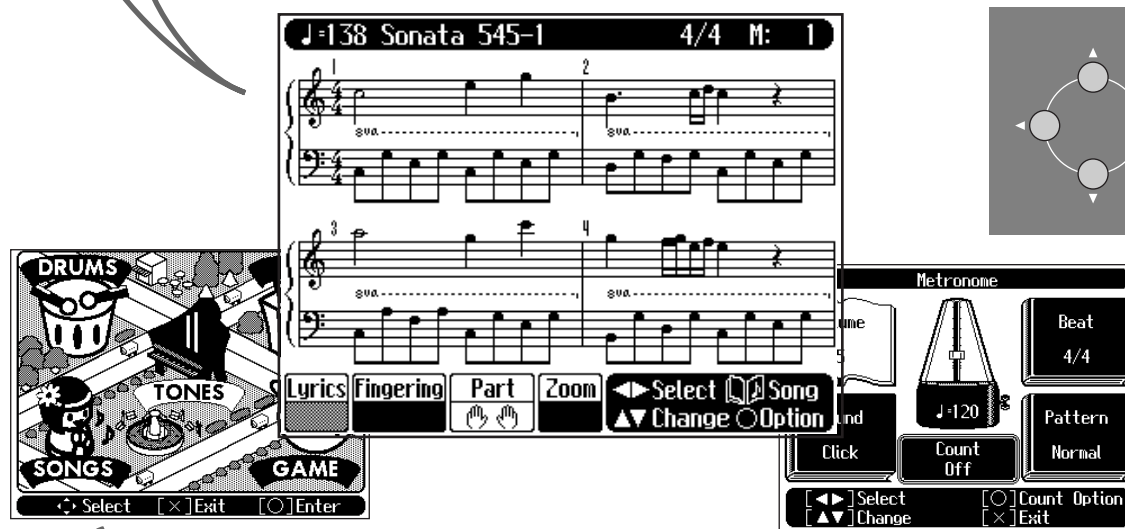

A "Wonderland" Sure To Please Children

"Wonderland" is a world of sound which children can enjoy, with a "DRUM," a "SFX" of sounds, and more. A note-guessing game is also included.

A Wealth Of Onboard Songs

The instrument comes with 168 piano songs, all carefully selected so almost every genre is represented—whether it be piano etudes, or popular tunes. Of course, all internal songs can be viewed in the score screen.



Convenient Functions For Practicing

Song data can be played back one hand (part) at a time, and you can use the internal metronome and other convenient functions for practicing.

Copyright © 2001 ROLAND CORPORATION

All rights reserved. No part of this publication may be reproduced in any form without the written permission of ROLAND CORPORATION.

WARNING: To reduce the risk of fire or electric shock, do not expose this apparatus to rain or moisture.

   ATTENTION: RISQUE DE CHOC ELECTRIQUE NE PAS OUVRIR
CAUTION: TO REDUCE THE RISK OF ELECTRIC SHOCK, DO NOT REMOVE COVER (OR BACK). NO USER-SERVICEABLE PARTS INSIDE. REFER SERVICING TO QUALIFIED SERVICE PERSONNEL.



The lightning flash with arrowhead symbol, within an equilateral triangle, is intended to alert the user to the presence of uninsulated "dangerous voltage" within the product's enclosure that may be of sufficient magnitude to constitute a risk of electric shock to persons.



The exclamation point within an equilateral triangle is intended to alert the user to the presence of important operating and maintenance (servicing) instructions in the literature accompanying the product.

INSTRUCTIONS PERTAINING TO A RISK OF FIRE, ELECTRIC SHOCK, OR INJURY TO PERSONS.

IMPORTANT SAFETY INSTRUCTIONS SAVE THESE INSTRUCTIONS

WARNING - When using electric products, basic precautions should always be followed, including the following:

1. Read these instructions.
2. Keep these instructions.
3. Heed all warnings.
4. Follow all instructions.
5. Do not use this apparatus near water.
6. Clean only with a dry cloth.
7. Do not block any of the ventilation openings. Install in accordance with the manufacturers instructions.
8. Do not install near any heat sources such as radiators, heat registers, stoves, or other apparatus (including amplifiers) that produce heat.
9. Do not defeat the safety purpose of the polarized or grounding-type plug. A polarized plug has two blades with one wider than the other. A grounding type plug has two blades and a third grounding prong. The wide blade or the third prong are provided for your safety. If the provided plug does not fit into your outlet, consult an electrician for replacement of the obsolete outlet.
10. Protect the power cord from being walked on or pinched particularly at plugs, convenience receptacles, and the point where they exit from the apparatus.
11. Only use attachments/accessories specified by the manufacturer.
12. Use only with the cart, stand, tripod, bracket, or table specified by the manufacturer, or sold with the apparatus. When a cart is used, use caution when moving the cart/apparatus combination to avoid injury from tip-over.
13. Unplug this apparatus during lightning storms or when unused for long periods of time.
14. Refer all servicing to qualified service personnel. Servicing is required when the apparatus has been damaged in any way, such as power-supply cord or plug is damaged, liquid has been spilled or objects have fallen into the apparatus, the apparatus has been exposed to rain or moisture, does not operate normally, or has been dropped.



For the U.K.

IMPORTANT: THE WIRES IN THIS MAINS LEAD ARE COLOURED IN ACCORDANCE WITH THE FOLLOWING CODE.

BLUE: NEUTRAL
BROWN: LIVE

As the colours of the wires in the mains lead of this apparatus may not correspond with the coloured markings identifying the terminals in your plug, proceed as follows:

The wire which is coloured BLUE must be connected to the terminal which is marked with the letter N or coloured BLACK.
The wire which is coloured BROWN must be connected to the terminal which is marked with the letter L or coloured RED.
Under no circumstances must either of the above wires be connected to the earth terminal of a three pin plug.

USING THE UNIT SAFELY

INSTRUCTIONS FOR THE PREVENTION OF FIRE, ELECTRIC SHOCK, OR INJURY TO PERSONS

About ⚠ WARNING and ⚠ CAUTION Notices

⚠ WARNING	Used for instructions intended to alert the user to the risk of death or severe injury should the unit be used improperly.
⚠ CAUTION	Used for instructions intended to alert the user to the risk of injury or material damage should the unit be used improperly. * Material damage refers to damage or other adverse effects caused with respect to the home and all its furnishings, as well to domestic animals or pets.

About the Symbols

	The ⚠ symbol alerts the user to important instructions or warnings. The specific meaning of the symbol is determined by the design contained within the triangle. In the case of the symbol at left, it is used for general cautions, warnings, or alerts to danger.
	The ⓧ symbol alerts the user to items that must never be carried out (are forbidden). The specific thing that must not be done is indicated by the design contained within the circle. In the case of the symbol at left, it means that the unit must never be disassembled.
	The ⚡ symbol alerts the user to things that must be carried out. The specific thing that must be done is indicated by the design contained within the circle. In the case of the symbol at left, it means that the power-cord plug must be unplugged from the outlet.

ALWAYS OBSERVE THE FOLLOWING

⚠ WARNING

- Before using this unit, make sure to read the instructions below, and the Owner's Manual.

- Do not open or perform any internal modifications on the unit.

- Do not attempt to repair the unit, or replace parts within it (except when this manual provides specific instructions directing you to do so). Refer all servicing to your retailer, the nearest Roland Service Center, or an authorized Roland distributor, as listed on the "Information" page.

- Never use or store the unit in places that are:
 - Subject to temperature extremes (e.g., direct sunlight in an enclosed vehicle, near a heating duct, on top of heat-generating equipment); or are
 - Damp (e.g., baths, washrooms, on wet floors); or are
 - Humid; or are
 - Exposed to rain; or are
 - Dusty; or are
 - Subject to high levels of vibration.

- Make sure you always have the unit placed so it is level and sure to remain stable. Never place it on stands that could wobble, or on inclined surfaces.

- The unit should be connected to a power supply only of the type described in the operating instructions, or as marked on the unit.

- Do not excessively twist or bend the power cord, nor place heavy objects on it. Doing so can damage the cord, producing severed elements and short circuits. Damaged cords are fire and shock hazards!

⚠ WARNING

- This unit, either alone or in combination with an amplifier and headphones or speakers, may be capable of producing sound levels that could cause permanent hearing loss. Do not operate for a long period of time at a high volume level, or at a level that is uncomfortable. If you experience any hearing loss or ringing in the ears, you should immediately stop using the unit, and consult an audiologist.

- Do not allow any objects (e.g., flammable material, coins, pins); or liquids of any kind (water, soft drinks, etc.) to penetrate the unit.



- In households with small children, an adult should provide supervision until the child is capable of following all the rules essential for the safe operation of the unit.

- Protect the unit from strong impact. (Do not drop it!)







- Do not force the unit's power-supply cord to share an outlet with an unreasonable number of other devices. Be especially careful when using extension cords—the total power used by all devices you have connected to the extension cord's outlet must never exceed the power rating (watts/amperes) for the extension cord. Excessive loads can cause the insulation on the cord to heat up and eventually melt through.

- Before using the unit in a foreign country, consult with your retailer, the nearest Roland Service Center, or an authorized Roland distributor, as listed on the "Information" page.





⚠ WARNING

- Do not put anything that contains water (e.g., flower vases) on this unit. Also, avoid the use of insecticides, perfumes, alcohol, nail polish, spray cans, etc., near the unit. Swiftly wipe away any liquid that spills on the unit using a dry, soft cloth. 
- Use only the attached power-supply cord. Also, the supplied power cord must not be used with any other device. 

⚠ CAUTION

- The unit should be located so that its location or position does not interfere with its proper ventilation. 
- Always grasp only the plug on the power-supply cord when plugging into, or unplugging from, an outlet or this unit. 
- At regular intervals, you should unplug the power plug and clean it by using a dry cloth to wipe all dust and other accumulations away from its prongs. Also, disconnect the power plug from the power outlet whenever the unit is to remain unused for an extended period of time. Any accumulation of dust between the power plug and the power outlet can result in poor insulation and lead to fire. 
- Try to prevent cords and cables from becoming entangled. Also, all cords and cables should be placed so they are out of the reach of children. 
- Never climb on top of, nor place heavy objects on the unit. 
- Never handle the power cord or its plugs with wet hands when plugging into, or unplugging from, an outlet or this unit. 
- If you need to move the instrument, take note of the precautions listed below. At least two persons are required to safely lift and move the unit. It should be handled carefully, all the while keeping it level. Make sure to have a firm grip, to protect yourself from injury and the instrument from damage. 
 - Check to make sure the knob bolts securing the unit to the stand have not become loose. Fasten them again securely whenever you notice any loosening.
 - Disconnect the power cord.
 - Disconnect all cords coming from external devices.
 - Raise the adjuster on the stand (p. 11).
 - Close the lid.
 - Remove the music stand.

⚠ CAUTION

- Before cleaning the unit, turn off the power and unplug the power cord from the outlet (p. 9). 
- Whenever you suspect the possibility of lightning in your area, pull the plug on the power cord out of the outlet. 
- Be careful when opening/closing the lid so you do not get your fingers pinched (p. 9). Adult supervision is recommended whenever small children use the unit. 
- Should you remove the screws fastening the stand, make sure to put them in a safe place out of children's reach, so there is no chance of them being swallowed accidentally. 

IMPORTANT NOTES

In addition to the items listed under “IMPORTANT SAFETY INSTRUCTIONS” and “USING THE UNIT SAFELY” on pages 2, 3 and 4, please read and observe the following:

Power Supply

- Do not connect this unit to same electrical outlet that is being used by an electrical appliance that is controlled by an inverter (such as a refrigerator, washing machine, microwave oven, or air conditioner), or that contains a motor. Depending on the way in which the electrical appliance is used, power supply noise may cause this unit to malfunction or may produce audible noise. If it is not practical to use a separate electrical outlet, connect a power supply noise filter between this unit and the electrical outlet.
- Before connecting this unit to other devices, turn off the power to all units. This will help prevent malfunctions and/or damage to speakers or other devices.
- Although the LCD and LEDs are switched off when the POWER switch is switched off, this does not mean that the unit has been completely disconnected from the source of power. If you need to turn off the power completely, first turn off the POWER switch, then unplug the power cord from the power outlet. For this reason, the outlet into which you choose to connect the power cord's plug should be one that is within easy reach and readily accessible.

Placement

- Using the unit near power amplifiers (or other equipment containing large power transformers) may induce hum. To alleviate the problem, change the orientation of this unit; or move it farther away from the source of interference.
- This device may interfere with radio and television reception. Do not use this device in the vicinity of such receivers.
- Observe the following when using the unit's floppy disk drive. For further details, refer to “Before Using Floppy Disks” (p. 6).
 - Do not place the unit near devices that produce a strong magnetic field (e.g., loudspeakers).
 - Install the unit on a solid, level surface.
 - Do not move the unit or subject it to vibration while the drive is operating.
- Do not expose the unit to direct sunlight, place it near devices that radiate heat, leave it inside an enclosed vehicle, or otherwise subject it to temperature extremes. Also, do not allow lighting devices that normally are used while their light source is very close to the unit (such as a piano light), or powerful spotlights to shine upon the same area of the unit for extended periods of time. Excessive heat can deform or discolor the unit.
- To avoid possible breakdown, do not use the unit in a wet area, such as an area exposed to rain or other moisture.
- Do not allow rubber, vinyl, or similar materials to remain on the piano for long periods of time. Such objects can discolor or otherwise harmfully affect the finish.
- Do not allow objects to remain on top of the keyboard. This can be the cause of malfunction, such as keys ceasing to produce sound.

- Do not paste stickers, decals, or the like to this instrument. Peeling such matter off the instrument may damage the exterior finish.

Maintenance

- To clean the unit, use a dry, soft cloth; or one that is slightly dampened. Try to wipe the entire surface using an equal amount of strength, moving the cloth along with the grain of the wood. Rubbing too hard in the same area can damage the finish.
- Never use benzine, thinners, alcohol or solvents of any kind, to avoid the possibility of discoloration and/or deformation.
- The pedals of the HPi-5 are made of brass. Brass eventually darkens as the result of the natural oxidization process. If the brass becomes tarnished, polish it using commercially available metal polisher.

Additional Precautions

- Please be aware that the contents of memory can be irretrievably lost as a result of a malfunction, or the improper operation of the unit. To protect yourself against the risk of losing important data, we recommend that you periodically save a backup copy of important data you have stored in the unit's memory on a floppy disk.
- Unfortunately, it may be impossible to restore the contents of data that was stored on a floppy disk, once it has been lost. Roland Corporation assumes no liability concerning such loss of data.
- Use a reasonable amount of care when using the unit's buttons, sliders, or other controls; and when using its jacks and connectors. Rough handling can lead to malfunctions.
- Never strike or apply strong pressure to the display.
- A small amount of noise may be heard from the display during normal operation.
- When connecting / disconnecting all cables, grasp the connector itself—never pull on the cable. This way you will avoid causing shorts, or damage to the cable's internal elements.
- A small amount of heat will radiate from the unit during normal operation.
- To avoid disturbing your neighbors, try to keep the unit's volume at reasonable levels. You may prefer to use headphones, so you do not need to be concerned about those around you (especially when it is late at night).
- When you need to transport the unit, pack it in shock-absorbent material. Transporting the unit without doing so can cause it to become scratched or damaged, and could lead to malfunction.
- Do not apply undue force to the music stand while it is in use.

IMPORTANT NOTES

- Use a cable from Roland to make the connection. If using some other make of connection cable, please note the following precautions.
 - Some connection cables contain resistors. Do not use cables that incorporate resistors for connecting to this unit. The use of such cables can cause the sound level to be extremely low, or impossible to hear. For information on cable specifications, contact the manufacturer of the cable.
- Before opening or closing the keyboard lid, always make sure that no pets or other small animals are located on top of the instrument (in particular, they should be kept away from the keyboard and its lid). Otherwise, due to the structural design of this instrument, small pets or other animals could end up getting trapped inside it. If such a situation is encountered, you must immediately switch off the power and disconnect the power cord from the outlet. You should then consult with the retailer from whom the instrument was purchased, or contact the nearest Roland Service Center.

Before Using Floppy Disks

Handling the Floppy Disk Drive

- Install the unit on a solid, level surface in an area free from vibration.
- Avoid using the unit immediately after it has been moved to a location with a level of humidity that is greatly different than its former location. Rapid changes in the environment can cause condensation to form inside the drive, which will adversely affect the operation of the drive and/or damage floppy disks. When the unit has been moved, allow it to become accustomed to the new environment (allow a few hours) before operating it.
- To insert a disk, push it gently but firmly into the drive—it will click into place. To remove a disk, press the EJECT button firmly. Do not use excessive force to remove a disk which is lodged in the drive.
- Never eject a disk while reading or writing is in progress, since that can damage the magnetic surface of the disk, rendering it unusable. (The disk drive's indicator will light up at full brightness when the drive is busy reading or writing data. Ordinarily, the indicator will be less brightly lit, or be extinguished.)
- Remove any disk from the drive before powering up or down.
- To prevent damage to the disk drive's heads, always try to hold the floppy disk in a level position (not tilted in any direction) while inserting it into the drive. Push it in firmly, but gently. Never use excessive force.
- To avoid the risk of malfunction and/or damage, insert only floppy disks into the disk drive. Never insert any other type of disk. Avoid getting paper clips, coins, or any other foreign objects inside the drive.

Handling Floppy Disks

- Floppy disks contain a plastic disk with a thin coating of magnetic storage medium. Microscopic precision is required to enable storage of large amounts of data on such a small surface area. To preserve their integrity, please observe the following when handling floppy disks:
 - Never touch the magnetic medium inside the disk.
 - Do not use or store floppy disks in dirty or dusty areas.
 - Do not subject floppy disks to temperature extremes (e.g., direct sunlight in an enclosed vehicle). Recommended temperature range: 10 to 50° C (50 to 122° F).
 - Do not expose floppy disks to strong magnetic fields, such as those generated by loudspeakers.
- Floppy disks have a "write protect" tab which can protect the disk from accidental erasure. It is recommended that the tab be kept in the PROTECT position, and moved to the WRITE position only when you wish to write new data onto the disk.

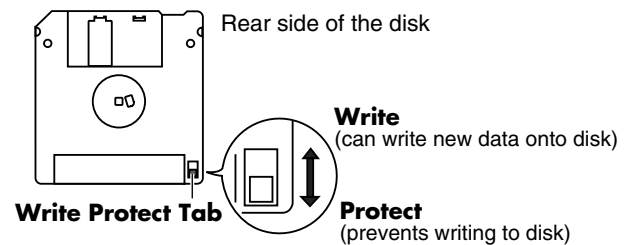

- The identification label should be firmly affixed to the disk. Should the label come loose while the disk is in the drive, it may be difficult to remove the disk.
- Store all disks in a safe place to avoid damaging them, and to protect them from dust, dirt, and other hazards. By using a dirty or dust-ridden disk, you risk damaging the disk, as well as causing the disk drive to malfunction.
- Disks containing performance data for this unit should always be locked (have their write protect tab slid to the "Protect" position) before you insert them into the drive on some other unit (except the PR-300, or a product in the HP-G/R, MT, KR, or Atelier families), or into a computer's drive. Otherwise (if the write protect tab remains in the "Write" position), when you perform any disk operations using the other device's disk drive (such as checking the contents of the disk, or loading data), you risk rendering the disk unreadable by this unit's disk drive.

* GS () is a registered trademark of Roland Corporation.

* XG lite () is a registered trademark of Yamaha Corporation.

* All product names mentioned in this document are trademarks or registered trademarks of their respective owners.

Contents

USING THE UNIT SAFELY	3
IMPORTANT NOTES	5
Before You Begin Playing	9
Making the Connections	9
Connecting the pedal cable.....	9
Attach the music stand.....	9
Connect the power cable.....	9
Connect headphones	9
Opening and Closing the Lid	9
Turning the Power On/Off	10
Adjusting the Volume or Brightness of the Sound	10
Switching the Display On/Off.....	10
Adjusting the brightness of the screen.....	10
About the pedals	11
Disabling Functions Other Than Piano Performance (Panel Lock)	11
Panel Descriptions.....	12
Basic Operation and the Main Screen.....	14
Playing Along With A Song.....	15
Score Screen	15
Button Operations.....	16
Playing a Song	16
Playing songs consecutively (Demo/All Song Play).....	18
Playing back at a fixed tempo	18
Using the Metronome.....	19
Adding a Count to Assist Your Timing.....	20
Assigning Markers to a Song for Repeated Practice	20
Changing the Pitch of the Keyboard or Song Playback (Transpose).....	22
Adjusting the Keyboard Touch (Key Touch)	23
Adding Variety to Your Performances	24
Selecting the Sound to Play	24
Playing percussion instruments or sound effects.....	24
Applying Effects to the Sound	24
Adding reverberation to the sound (Reverb).....	25
Adding richness to the sound (Chorus).....	25
Playing Two Sounds Layered Together (Dual)	25
Playing Different Sounds in the Right and Left Hand (Split).....	26
Changing from dual performance to split performance	27
To switch from split to dual performance	27
Adding an Accompaniment to Your Performance (Pianist Function).....	28
Playing in a Wonderland of Sound.....	29
Recording Your Performance	30
Recording Along with a Song	30
Recording a New Song.....	31
Re-recording	33
Erasing a Recorded Song	34
Other Recording Methods	34
Recording with an accompaniment (the Pianist function).....	34
Multitrack recording on five tracks.....	35
Saving Your Performance	36
Saving a Song on a Floppy Disk	36
Inserting/removing a floppy disk.....	36
Formatting a floppy disk.....	36
Saving to a floppy disk.....	37
Erasing a Song from Floppy Disk.....	39
Playing Back Music Files or a Song that was Saved on Floppy Disk	40
Convenient Functions	41
Changing the Score Screen Settings	41
Changing the Count Settings.....	42
Functions that Can be Selected Using the [Function] Button.....	43
Adjusting the volume balance between accompaniment and keyboard (Balance).....	43
Adjusting the depth of the effects (Effects)	43
Assigning a marker in the middle of a measure (Marker setting/Resolution)	43
Setting the standard pitch and temperament (Tuning).....	44
Playing back the performance of a specific instrument (16 Track).....	44
Changing the function of the pedals (Pedal).....	45
Changing the language displayed in the screen (Language)	45
Remembering the settings even when the power is turned off (Memory Backup).....	45
Changing the parts assigned to the track buttons during SMF playback (Track Assign)	45
Restoring the factory settings (Factory Reset).....	45
Connecting External Devices.....	46
Connecting Audio Devices	46
Connections with MIDI Devices	46
What is MIDI?.....	46
Connections to a Computer	47
Making MIDI-Related Settings.....	47
MIDI settings	47
Program Change setting.....	48
Appendices.....	49
Trouble Shooting.....	49
If this Message Appears on Screen	51
Tone/Drum Set List.....	52
Pianist Style List	56
Chord List.....	57
Internal Song List	58
Music Files That the HPi-5 Can Use.....	60
MIDI Implementation Chart.....	61
Main Specifications	62
Index.....	63

MEMO

Before You Begin Playing

Making the Connections

Connecting the pedal cable

Insert the pedal cable into the Pedal connector on the rear panel of the HPi-5.

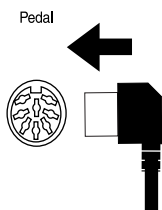

Attach the music stand

The music stand of the HPi-5 contains a liquid crystal display screen. Use the following procedure, and handle the music stand with care.

- 1 Insert the music stand as shown in the diagram.

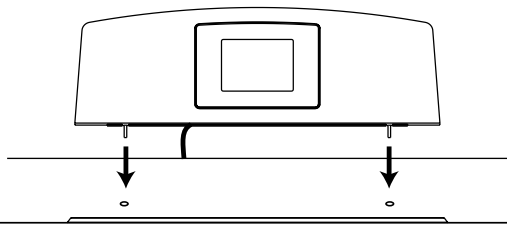

- 2 Connect the music stand cable to the LCD Out connector of the HPi-5.

- * The power must be off when connecting the cable of the music stand.

Connecting

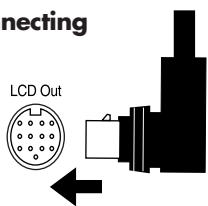

Insert the plug into the connector so that it is securely fastened

Disconnecting

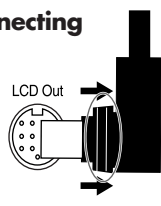

Grasp the plug to pull it out

Connect the power cable

Insert the included power cable into the AC inlet on the bottom panel of the HPi-5, and then plug it into an AC power outlet.

- * Use only the included power cable.

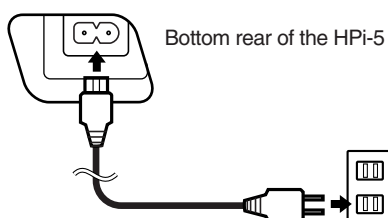

Connect headphones

Plug the headphones into the Phones jack on the bottom panel of the HPi-5.

When you connect headphones, no sound will be output from the internal speakers.

The headphone volume is adjusted by the [Volume] knob (→ p. 10) of the HPi-5.

- * Please use stereo headphones.

Phones plug x 2

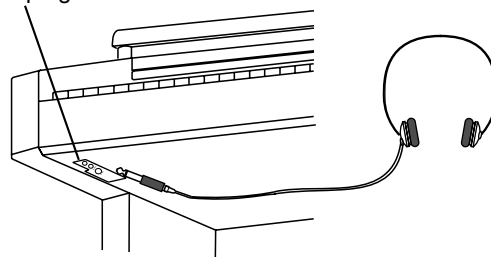

Some Notes on Using Headphones

- To avoid damaging or severing the headphone cord, be sure to handle the headphones by holding the phones themselves, and grasping the plug and not the cord when pulling the headphone plug.
- The headphones may be damaged if the volume is too high when they are plugged in. Connect the headphones only after turning the volume down completely.
- To prevent possible auditory damage, loss of hearing, or damage to the headphones, the headphones should not be used at an excessively high volume. Listen at appropriate levels.

Opening and Closing the Lid

To open the lid, use both hands to lift it lightly, and slide it away from yourself.

To close the lid, pull it gently toward yourself, and lower it softly after it has been fully extended.

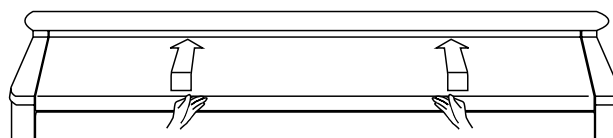

- * Be careful not to get your fingers pinched when opening or closing the lid. If small children will be using the HPi-5, adult supervision should be provided.

- * To prevent accidents, the lid must be closed when transporting the piano.

Before You Begin Playing

Turning the Power On/Off

- * Turn on power to your various devices in the order specified. By turning on devices in the wrong order, you risk causing malfunction and/or damage to speakers and other devices.

To turn the power on, turn the [Volume] knob all the way down, and then press the [Power] switch.

The power will turn on, and the Power indicator at the left front of the HPi-5 will light.

After a few seconds, you will be able to play the keyboard to produce sound. Use the [Volume] knob to adjust the volume.

- * This unit is equipped with a protection circuit. A brief interval (a few seconds) after power up is required before the unit will operate normally.

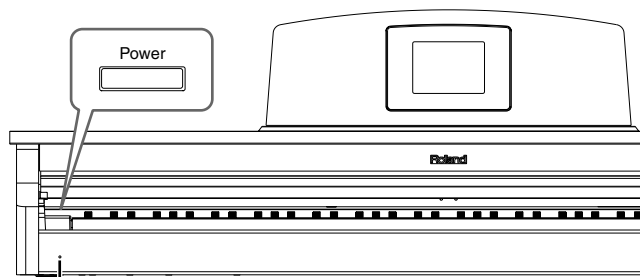

Power Indicator

To turn the power off, turn the [Volume] knob all the way to the left, and press the [Power] switch.

The Power indicator at the left front of the HPi-5 will go dark, and the power will be turned off.

- * If you need to turn off the power completely, first turn off the POWER switch, then unplug the power cord from the power outlet. Refer to **Power Supply** (p. 5).

Adjusting the Volume or Brightness of the Sound

Turn the [Volume] knob to adjust the overall volume.

Turn the [Brilliance] knob to adjust the brightness of the sound.

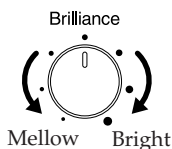
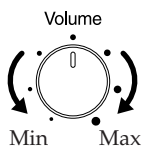

Switching the Display On/Off

When you turn on the power, the screen in the center of the music stand will be on.

Press the Display [On/Off] button to turn the display off.

Press the Display [On/Off] button once again to turn the display on.

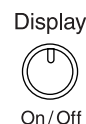

- * If you turn on the power while activating Panel Lock (→ p. 11), the screen will not appear.
- * Even if you leave the screen turned off, some functions will cause the screen to turn on automatically.

Adjusting the brightness of the screen

To adjust the brightness of the screen, turn the [Contrast] knob located at the back of the music stand.

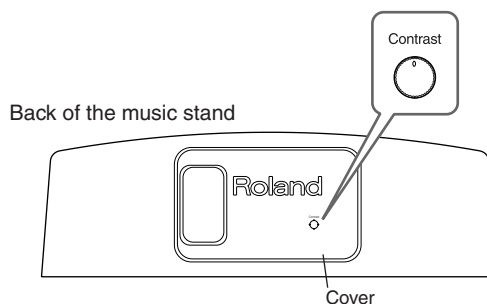

Some Notes on Using the LCD screen

- Never remove the liquid crystal display cover at the back of the music stand. By removing it you risk electrical shock and/or malfunction.
- You may see vertical lines in the screen, but this is due to the structure of a liquid crystal display, and does not indicate a malfunction. By using the [Contrast] knob to adjust the brightness of the screen, you can minimize these lines.
- The brightness of the screen may be affected by the temperature.

About the Pedals

The pedals have the following functions, and are used mainly for piano performance.

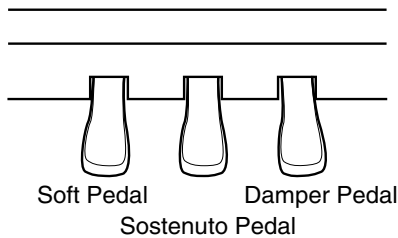

Damper pedal (right pedal)

While this pedal is pressed, notes will be sustained even after you take your fingers off the keys. The depth to which you press the pedal will subtly affect the duration of the sustain. On an acoustic piano, holding down the damper pedal will allow the remaining strings to resonate in sympathy with the sounds that you played from the keyboard, adding a rich resonance. The HPi-5 simulates this sympathetic resonance.

- * You can adjust the amount of sympathetic resonance that occurs when you press the damper pedal. Refer to “Adjusting the depth of the effects (Effects)” (p. 43).

Sostenuto pedal (center pedal)

This pedal sustains only the sounds of the keys that were already played when you pressed the pedal.

Soft pedal (left pedal)

When you hold down this pedal and play the keyboard, the sound will have a softer tone. The softness of the tone can be varied subtly by the depth to which you press the pedal.

- * The Sostenuto pedal and Soft pedal can be given functions other than these. Refer to “Changing the function of the pedals (Pedal)” (p. 45).

About the adjuster

When you move the HPi-5 or if you feel that the pedals are unstable, adjust the adjuster located below the pedals as follows.

- Rotate the adjuster to lower it so that it is in firm contact with the floor. If there is a gap between the pedals and the floor, the pedals may be damaged. In particular when placing the instrument on carpet, adjust this so that the pedals firmly contact the floor.

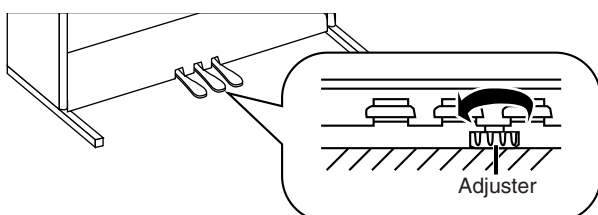

Disabling Functions Other Than Piano Performance (Panel Lock)

The “Panel Lock” function locks the HPi-5 in a state where only piano performance can be used, and all buttons will be disabled. This prevents the settings from being inadvertently modified even if children press the buttons accidentally.

- * In the Panel Lock state, only the grand piano sound can be played. Also, nothing will be displayed in the screen.

1 Turn the volume to the minimum, and press the [Power] switch to turn off the power.

2 Hold down the [Function] button, and press the [Power] switch to turn on the power.

Continue holding down the button for one or two seconds. Adjust the volume. When you play the keyboard, the grand piano sound will be heard.

To defeat the Panel Lock function, turn the volume down to the minimum, and turn on the power once again.

Panel Descriptions

Front Panel

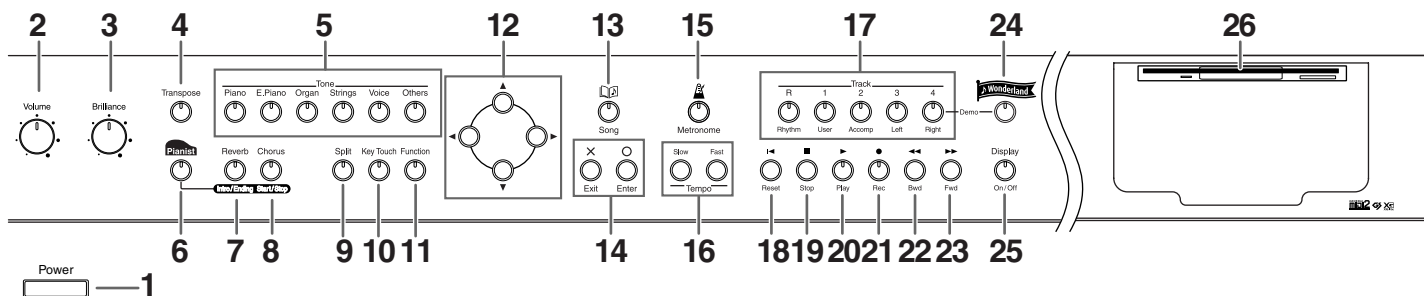

1 [Power] switch

Pressed to switch the power on and off. (p. 10)

2 [Volume] knob

Adjusts the overall volume. (p. 10)

3 [Brilliance] knob

Adjusts the brightness of the sound. (p. 10)

4 [Transpose] button

Transposes the pitch of the keyboard or the song being played. (p. 22)

5 [Tone] buttons

Select the type of sound (the tone group) that will be played from the keyboard. (p. 24)

6 [Pianist] button

You can use the Pianist function to add an accompaniment to your playing. (p. 28)

7 [Reverb]/[Intro/Ending] button

Adds reverberation to the sound. (p. 25)
When you are using the Pianist function, this starts/stops the accompaniment with an intro or ending. (p. 28)

8 [Chorus]/[Start/Stop] button

Adds spaciousness to the sound. (p. 25)
When you are using the Pianist function, this starts/stops the accompaniment. (p. 28)

9 [Split] button

Lets you play different sounds in the left and right-hand areas of the keyboard. (p. 26)

10 [Key Touch] button

Adjusts the touch of the keyboard. (p. 23)

11 [Function] button

Selects various performance-related functions. (p. 20, p. 36–p. 39, p. 43–p. 45)

12 [◀][▶][▲][▼] buttons (Cursor buttons)

Used to select the item or value that you want to set. (p. 14)
Depending on the screen, other functions may be assigned.

13 [Song] button

Use this button to select internal songs or songs from floppy disk. (p. 16, p. 40)

14 [X][O] buttons

The [O] button finalizes the value that was selected by the cursor buttons (12). (p. 14)

The [X] cancels the operation, or displays the musical score screen.

Depending on the screen, other functions may be assigned.

15 [M] (Metronome) button

Sounds the internal metronome. (p. 19)

This button specifies the count. (p. 20)

16 Tempo [Slow] [Fast] buttons

Adjust the tempo. (p. 16, p. 28)

Simultaneously pressing the [Slow] and [Fast] buttons will restore the basic tempo.

17 Track buttons

Used to play back or record each track of a song (p. 16, p. 33, p. 35).

18 [◀] (Reset) button

Resets the song playback-start location to the beginning of the song.

19 [■] (Stop) button

Stops song playback or recording.

20 [▶] (Play) button

Starts song playback or recording.

21 [●] (Rec) button

When pressed, this button places the instrument in recording standby. (p. 30–p. 35)

22 [◀◀] (Bwd) button

Rewinds the song.

23 [▶▶] (Fwd) button

Fast-forwards the song.

24 [Wonderland] button

Here you can enjoy the “DRUM,” “SFX,” and “GAME,” and learn about instruments while having fun. (p. 29)

25 Display [On/Off]

Turns the music-stand screen on/off. (p. 10)

26 Disk Drive

You can insert a floppy disk for playing back or saving songs. (p. 40, p. 36)

Rear Panel

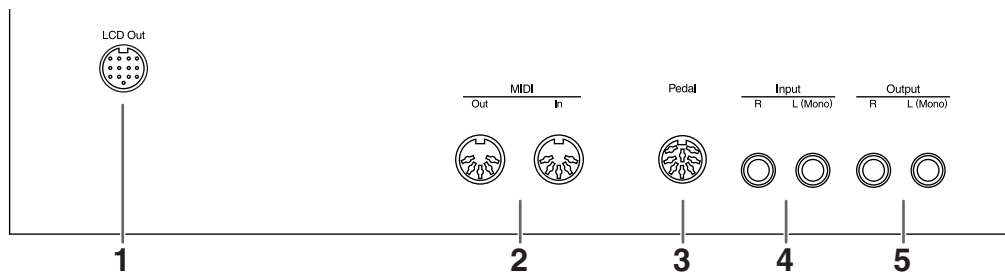

1 LCD Out Connector

Connect the cable of the music stand to this connector. (p. 9)

2 MIDI Out/In connectors

These can be connected to an external MIDI device to exchange performance data. (p. 46)

- * There is also a MIDI In connector on the bottom panel. The two MIDI In connectors cannot be used simultaneously.

3 Pedal connector

Connect the pedal cable of the stand to this connector. (p. 9)

4 Input jacks

These jacks can be connected to another sound generating device or an audio device, so that the sound of that device will be output from the HPi-5's speakers. (p. 46)

5 Output jacks

These jacks can be connected to your audio system to enjoy more powerful sound. They can also be connected to a tape recorder or similar device in order to record your performance on a cassette tape. (p. 46)

Bottom Panel

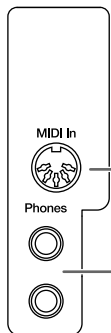

1 MIDI In connector

An external MIDI device can be connected here to receive performance data. (p. 46)

- * There is also a MIDI In connector on the rear panel of the HPi-5. The two MIDI In connectors cannot be used simultaneously.

2 Phones jacks

A set of headphones can be connected here. (p. 9)

Music Stand

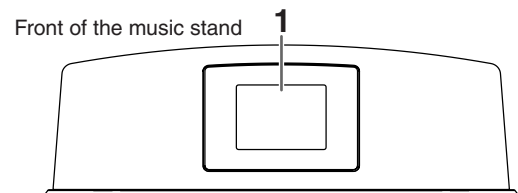

1 Display

This screen displays the musical score of an internal song or disk song, and also displays various settings.

- * The explanations in this manual include illustrations that depict what should typically be shown by the display. Note, however, that your unit may incorporate a newer, enhanced version of the system (e.g., includes newer sounds), so what you actually see in the display may not always match what appears in the manual.

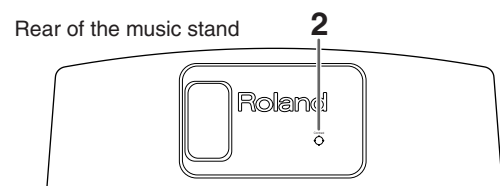

2 [Contrast] knob

This knob adjusts the brightness of the screen. (p. 10)

Basic Operation and the Main Screen

Basic operation

The HPi-5 is operated mainly by using the cursor buttons and [O] [X] buttons while viewing the screen.

The lower part of every screen shows the functions of the cursor

buttons and the [O] [X] buttons.

The main functions are as follows.

Cursor [▲] [▼] [◀] [▶] buttons:

Move to an item to select it, switch pages

[O] button: Finalize the selected value

[X] button: Display the score screen, or return to the previous screen

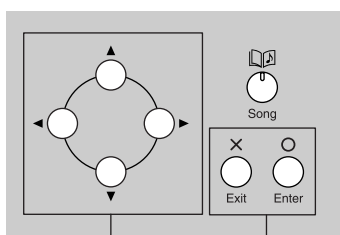

Cursor buttons [O][X] buttons

The main screens include the following.

1. Score screen (basic screen)

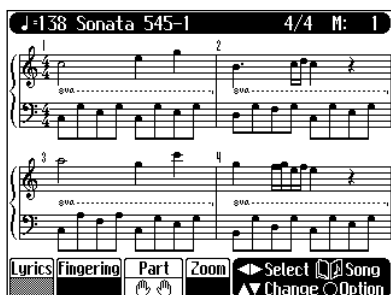

This is the first screen that will be displayed when you turn on the power.

If some other screen is displayed, you can press the [X] button several times to access this screen.

For details on the score screen display, refer to p. 15.

2. List screen



This type of list screen will appear when you select songs, tones, or accompaniment styles.

In this screen, use the cursor buttons to select the desired item. The selected item will be highlighted in white.

When the upper part of the screen shows the [Page] [Page] symbols, this means that items exist on the next or previous page as well.

3. Detailed settings screen

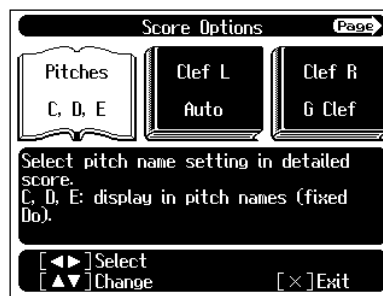

Detailed settings for functions are made in a screen similar to this.

The currently selected item will be highlighted in white, and you can use the [▲] [▼] buttons to edit the value. An explanation of the selected item is shown below the item. For some items, an explanation of the values will also be displayed.

If you simultaneously press the [▲] and [▼] buttons, the value will revert to the basic setting.

When the upper part of the screen shows the [Page] [Page] symbols, this means that items exist on the next or previous page as well.

When you press the [X] button the selected value will be finalized, and you'll then be returned to the screen that was displayed prior to the current screen.

Navigating among selections

In most cases, you will press a cursor button to select the item to the left or right (depending on the arrow's direction) of the currently selected item (the item highlighted in white).

However, in some screens, the [◀] [▶] buttons can be used to select items above and below, as well as those to the left and right.

Example:

Dual Screen (P. 25)

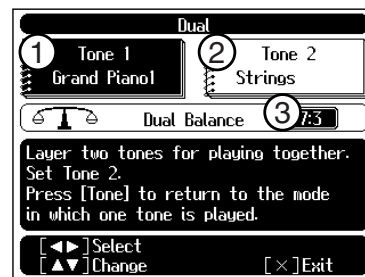

When you press the [▶] button, the selected item will move in the order of ①→②→③.

When you are to use only the [◀] [▶] buttons to select an item, the lower part of the display will indicate "[◀] [▶] Select."

Messages

Various messages will sometimes be displayed during operation.

These messages ask you to confirm an operation, inform you of the results of an operation, or indicate an error when an operation could not be performed.

For details on error messages that begin with "Error," refer to p. 51.

When a message like the following is displayed, use the [◀] [▶] buttons to select your response, and press the [O] button to finalize it. Pressing the [X] button returns you to the previous screen.

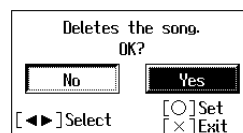

Playing Along With A Song

Score Screen

When the power of the HPi-5 is turned on, a musical score screen like the following will appear in the display.

This can display not only the onboard songs, but also the musical score for SMF music files or a performance that you've recorded on the HPi-5.

Part
Select the part(s) for which the score will be displayed.

- : Score for both hands
- : Left-hand score only
- : Right-hand score only
- : Score of the specified part
(→ to change the part, see p. 41)

Fingering
When playing back song data that includes fingering numbers, the fingering numbers will be displayed if you check this. This is convenient when you want to practice the correct fingering. The fingers are numbered as follows: 1: thumb, 2: index finger, 3: middle finger, 4: ring finger, 5: little finger. This item cannot be selected if there is no fingering data.

Lyrics
When playing back song data that contains lyric data, the lyrics will be displayed if you check this. This item cannot be selected if there is no lyric data.

Zoom
If this is checked, the score will be displayed at a higher magnification, one measure at a time. You can also have the note names be displayed.

Add/remove check mark, change parts
Select the item to set
Depending on the song data, it may not be possible to select some items.

Make detailed settings for the count
For details refer to p. 41.

- * If you have selected a part that contains no performance data, the score will not show any notes. To change the part that is displayed, refer to "Changing the Score Screen Settings" (p. 41).
- * The fingering numbers shown in the screen indicate one possible fingering.
- * The fingering numbers can be displayed only when playing some internal song.

Some notes on the score screen

- When you begin song playback, the score screen will show . While this symbol is displayed, performance data is being loaded from floppy disk or internal memory. It may take thirty seconds to a minute or more to read the data. Please wait.
- The displayed score is generated from the music files, and priority is given to making the display easy to read rather than reproducing a complicated or difficult performance accurately. For this reason, you may notice differences when compared with commercially available sheet music. In particular, this is not suitable for display of sophisticated or complex songs that require detailed scores. Ornamentals or notes shorter than a sixteenth note cannot be displayed.
- In the score screen, lyrics or notes may fall outside the display range of the screen, and fail to be shown.
- If you display the score or change the displayed part during song playback, the song may sometimes play back from the beginning.

Playing Along With A Song

Button Operations

The following buttons are used to play back a song.

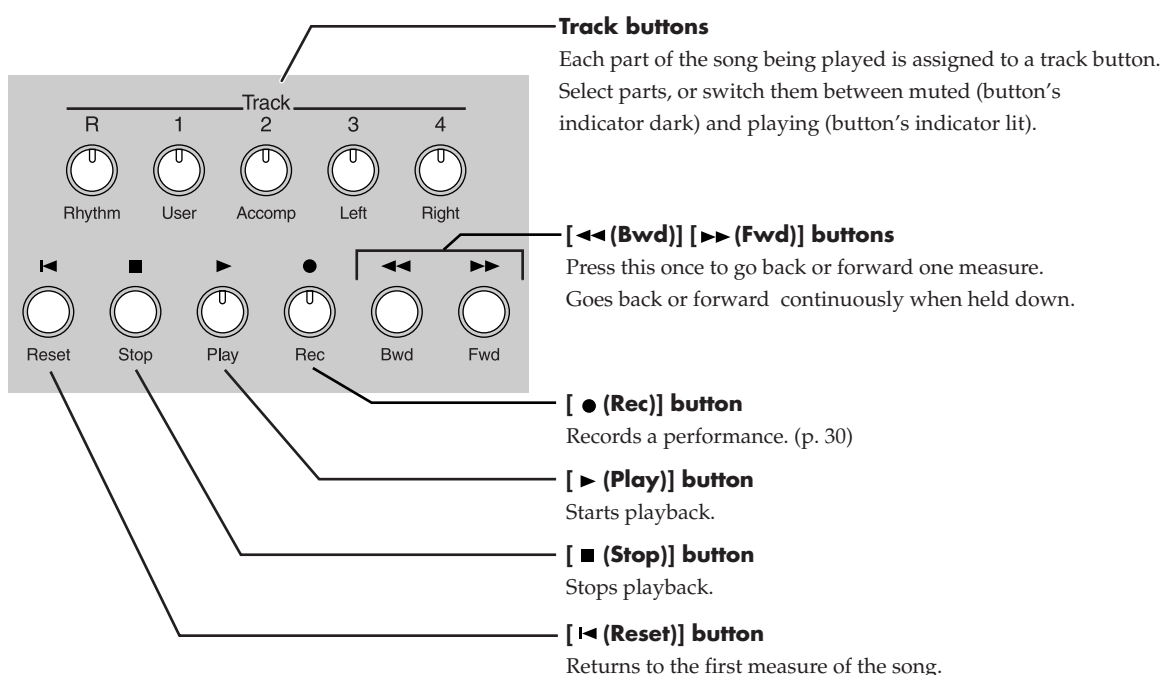
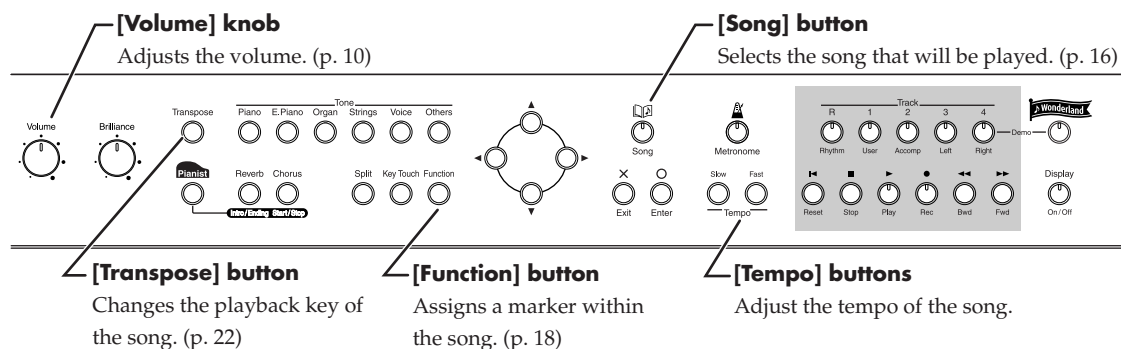

* If you hold down the [■ (Stop)] button and press the [▶ (Fwd)] button, you will move to the end of the song.

Playing a Song

The HPi-5 comes with 168 piano songs onboard. All of these can be viewed in the score screen.

They also have orchestral accompaniments, so you can play along with the accompaniment, or adjust the tempo to the desired speed for easier practice.

→ "Internal Song List" (p. 58)

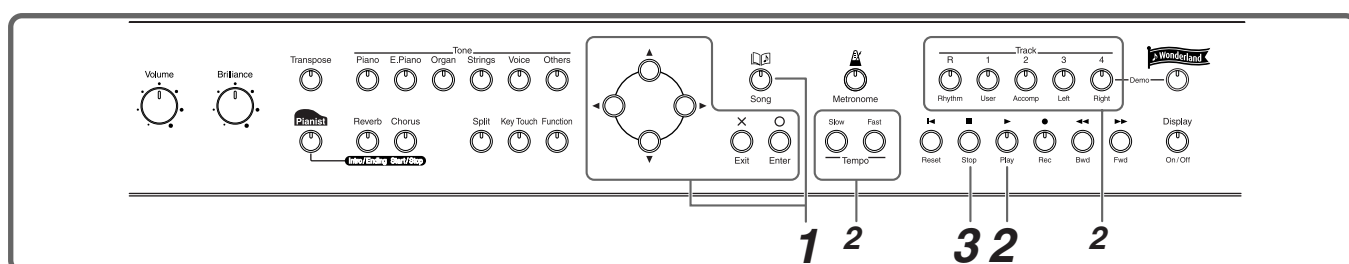

Select a song

1 Press the [Song] button. In the screen, select the song that you want to play.

Genre
Press to select the genre. Selectable songs differ for each genre.

Song list
The selection will be highlighted in white.

0: (Song name)
The name of the currently selected song.

Disk
Select songs from disk. For details refer to p. 40.

Select a song

Back to Score screen

Audition the selected song

Play back

2 Press the [▶ (Play)] button.

The button's indicator will light.

The screen will appear, and the song will begin playing.

While the screen shows the symbol, the song data is being loaded.

To adjust the tempo

Use the Tempo [Slow] [Fast] buttons to adjust the tempo.

The tempo is adjusted in terms of the value of a quarter note, with 20-250 being the permissible range.

If you press the Tempo [Slow] [Fast] buttons simultaneously, you will return to the basic tempo of the song (the tempo before it was modified).

Muting (silencing) parts of the playback

You can mute the sound of specific playback parts, and play them yourself.

Press a track button to mute a specific track.

The indicator of the button you pressed will go dark, and the selected track will not be heard.

To cancel muting, press the same track button once again to make the indicator light.

- * When playing back SMF files for Roland Piano Digital series instruments, and the [3/Left hand] button and [4/Right hand] button do not correctly control the left/right-hand performances, please change the "Track Assign" settings. Please refer to "Changing the parts assigned to the track buttons during SMF playback (Track Assign)" (p. 45).

Stop the song

3 Press the [■ (Stop)] button.

Playback will stop automatically when it reaches the end of the song.

Press the [◀ (Reset)] button to return to the beginning of the song.

If a screen like the following is displayed

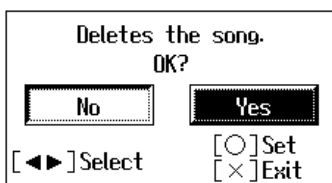

If a song has already been selected in the storage area (internal memory), it will not be possible to choose another song or record a new performance.

If it is OK to erase the existing song, select "Yes," and press the [○] button. If you do not want to erase the song, select "No" and save the song on a floppy disk (→ p. 36).

Playing Along With A Song

Playing songs consecutively (Demo/All Song Play)

The internal songs can be played back consecutively.

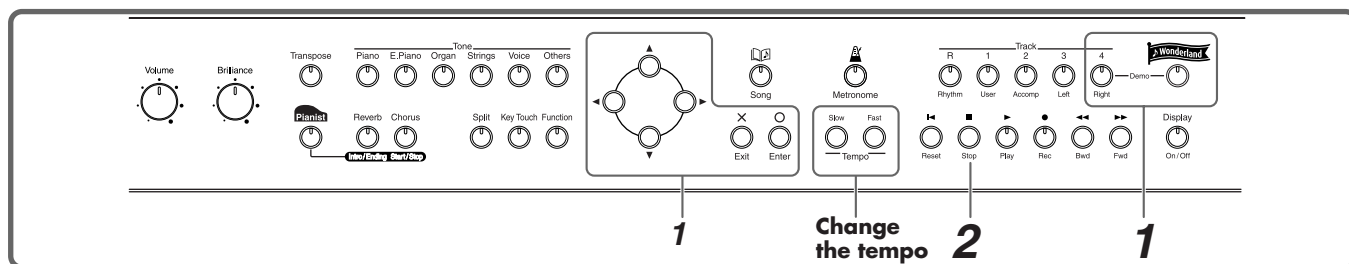

- 1 Hold down the track [4/Right] button and press the [Wonderland] button.

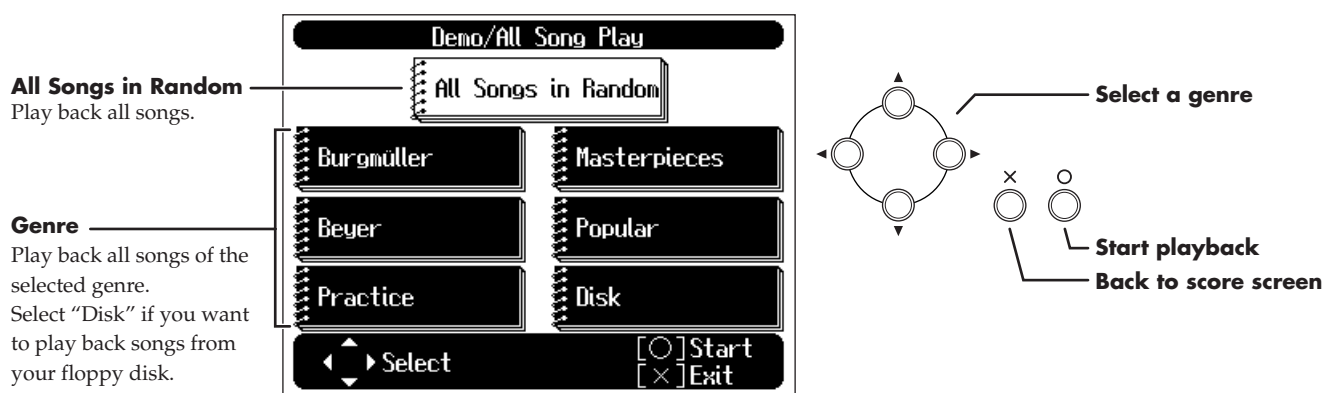

If no operations are performed for several seconds, "All Songs in Random" will start automatically. Songs will be played consecutively.

When all selected songs have been played, playback will return to the first song and resume.

Stop playback

- 2 Press the [■ (Stop)] button.

Playback will stop.

Playing back at a fixed tempo

In the case of a song with difficult tempo changes, it is effective to practice initially with a fixed tempo. Playing back at a fixed tempo without allowing tempo changes is called "Tempo Mute."

- 1 Hold down the [■ (Stop)] button and press either the Tempo [Slow] or [Fast] button.

While Tempo Mute is enabled, the indication of the tempo in the screen will be highlighted.



When you play back the song, it will play at a constant tempo.

To defeat Tempo Mute, hold down the [■ (Stop)] button and press either the Tempo [Slow] or [Fast] button.

Tempo Mute will also be cancelled when you select a different song.

Using the Metronome

The HPi-5 contains a versatile metronome function. While a song or accompaniment (→Pianist function, p. 28) is playing, the metronome will sound at the corresponding tempo and time signature (Beat).

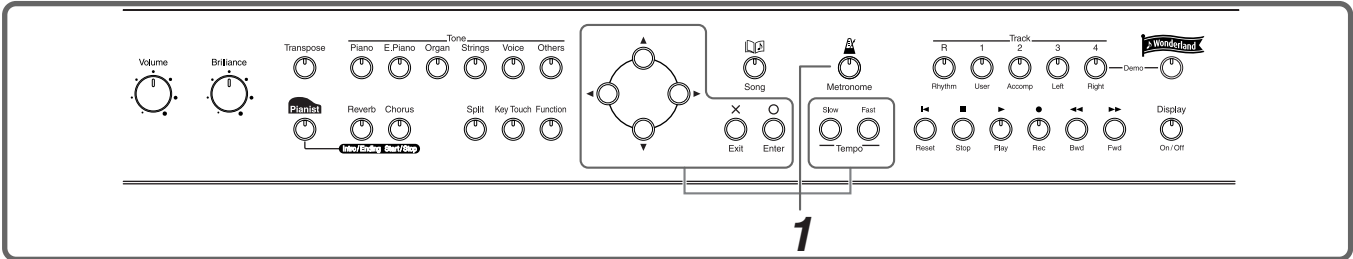

1 Press the [Metronome] button.

The button’s indicator will blink according to the time signature (Beat), and the metronome will sound. To stop the metronome, press the [Metronome] button, getting its indicator to go dark.

Volume
Set the metronome

Sound
Specify the metronome sound.

Tempo
Use the Tempo [Fast] or [Slow] button to set the tempo.

Beat
Set the beat.

Pattern
Specify the timing interval of the metronome’s weak beats.

Count
Displays the state of the Count setting (p. 42).

Select the item to set

Change the setting

Make detailed settings for the count
For details refer to p. 42.

Return to the previous screen

In this screen you can make the following settings.

Item	Setting
Volume	0 (no sound)–10
Beat	2/2, 0/4, 2/4, 3/4, 4/4, 5/4, 6/4, 7/4, 3/8, 6/8, 9/8, 12/8 * It is not possible to change the “Beat” setting while a song is playing.
Sound	Click, Electronic, Voice (Japanese) (“1,” “2,” “3” in Japanese), Voice (English) (“1,” “2,” “3” in English), Animal, Wood Block, Triangle & Castanets
Pattern	Normal, ♩ (dotted half note), ♪ (half note), ♪. (dotted quarter note), ♩ (quarter note), ♪. (dotted eighth note), ♪ (eighth note), ♪ (sixteenth note), Double (note added to back beat of the first beat), Triple (added notes sound the first beat as a triplet), Shuffle (notes added to create a shuffle)

Adding a Count to Assist Your Timing

“Count-in” means to sound a count before song playback begins.

“Countdown” means to sound a count after the end of the song introduction (before you begin playing the keyboard).

If you will be playing along with a song, sounding a count will make it easier to match the timing of your performance to the song.

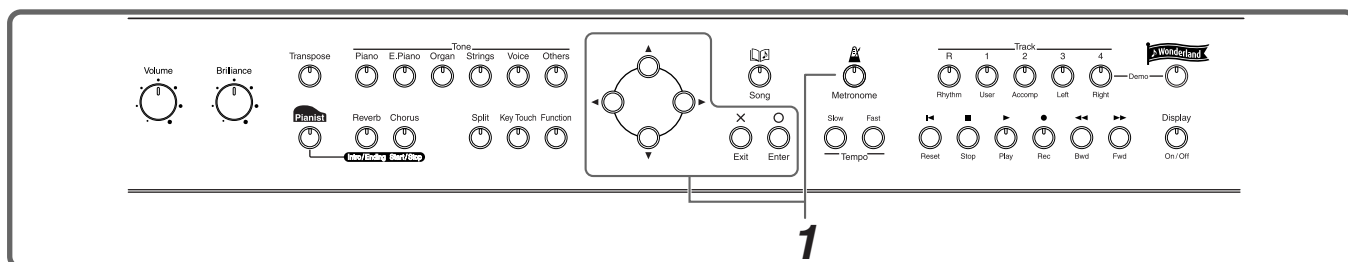

1 Press the [Metronome] button. In the Metronome screen press the [O] button.

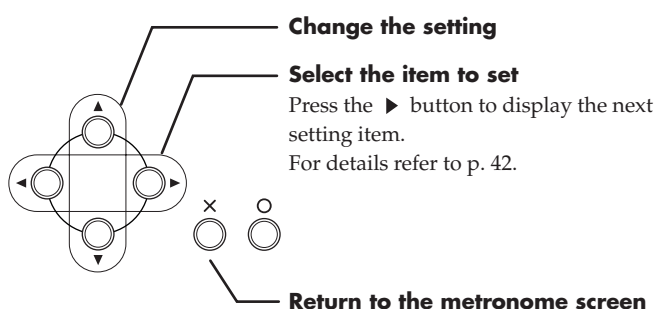

Item	Setting
Count	Specify what type of count will be added. Off (no count), Count In (add a count before the performance), Countdown (add a count only before you begin playing), Count In/down (add both a count-in and a countdown)

→ For details on other settings in the Count Options screen, refer to “Changing the Count Settings” (p. 42).

Assigning Markers to a Song for Repeated Practice

You can add markers within a song so that you can move to a marked measure, or play back repeatedly between two markers.

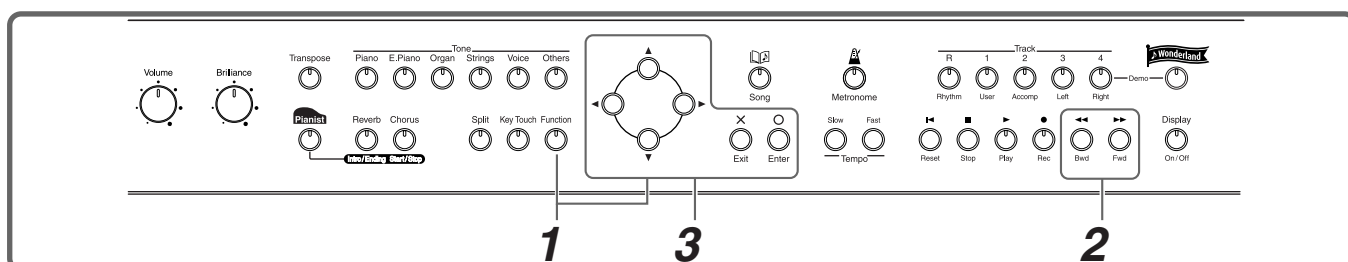

Before you begin, select the song in which you want to assign markers. (→ p. 16)

Access the Marker screen

- 1 Press the [Function] button. In the Functions screen, select "Marker" and press the [O] button.

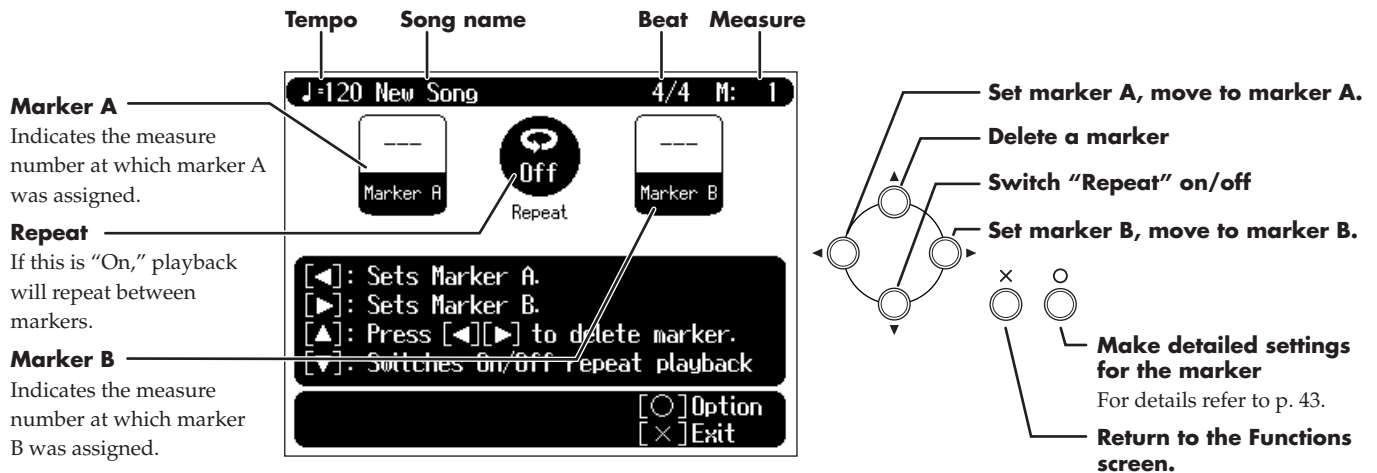

Move to the location at which you want to assign a marker.

- 2 Use the [◀◀ (Bwd)][▶▶ (Fwd)] buttons to move to the measure at which you want to assign a marker.

Assign a marker

- 3 Press the [◀] or [▶] button to assign marker A or B.

The screen will indicate the number of the measure at which the marker was assigned. It is not possible to assign marker B at the same location or earlier than marker A.

→ Markers can also be assigned in units of beats rather than measures. Refer to "Assigning a marker in the middle of a measure (Marker Option/Resolution)" (p. 43).

Moving an assigned marker

After assigning a marker in the song, you can hold down the [◀] button and press the [◀◀ (Bwd)] or [▶▶ (Fwd)] button to adjust the location at which marker A was assigned. To adjust the location of marker B, hold down the [▶] button and press the [◀◀ (Bwd)] or [▶▶ (Fwd)] button.

Moving to the location of an assigned marker

After assigning a marker in the song, press either the [◀] or [▶] buttons to move (jump) to the location of the marker.

Playing repeatedly between markers.

After assigning both markers A and B, press the [▼] button. In the screen, turn "Repeat" to "On." When you press the [▶ (Play)] button, playback will repeat between the markers.

If you use Repeat Playback without assigning marker A or B

The entire selected song will be played back repeatedly.

If you use Repeat Playback when only marker A is assigned

The song will play back repeatedly from marker A to the end of the song.

If you use Repeat Playback when only marker B is assigned

The song will play back repeated from the beginning of the song to marker B.

Playing Along With A Song

Deleting a marker you've assigned

Hold down the [▲] button, and press the [◀] to delete marker A, or press the [▶] button to delete marker B.

- * If "Repeat" in the Marker screen is turned "On," you can press the [X] button to display the Score screen and play back repeatedly.

Anything you want to do that involves markers, including moving to a particular marker, is accomplished within the Marker screen.

Changing the Pitch of the Keyboard or Song Playback (Transpose)

By using the "Transpose" function, you can transpose your performance without changing the notes you play. For example, if a song is in a difficult key with numerous sharps (#) or flats (♭), you can use this function to play it in an easier key.

You can also use this function to play back a song in a different key.

When accompanying a vocalist, you can easily transpose the pitch to a range that is comfortable for the singer, while still playing the notes as written (i.e., with the same fingering positions).

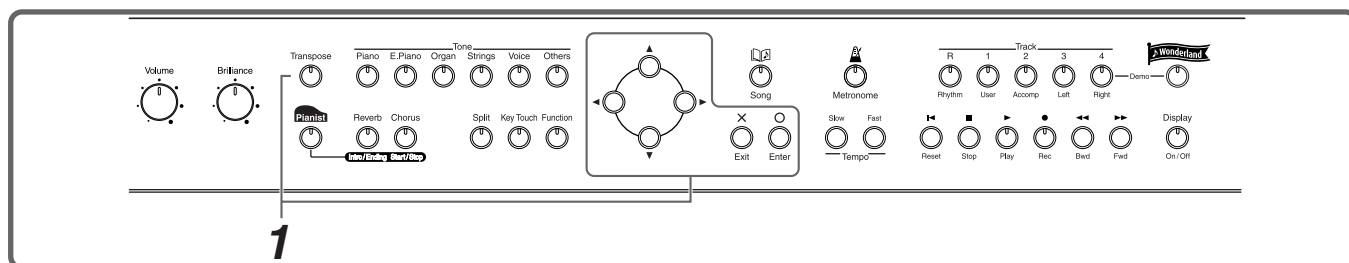

1 Press the [Transpose] button.

For example, if you want the E pitch to sound when you press the C key, set the "Keyboard" transpose setting to "4."

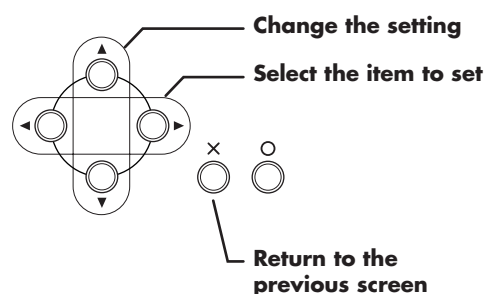
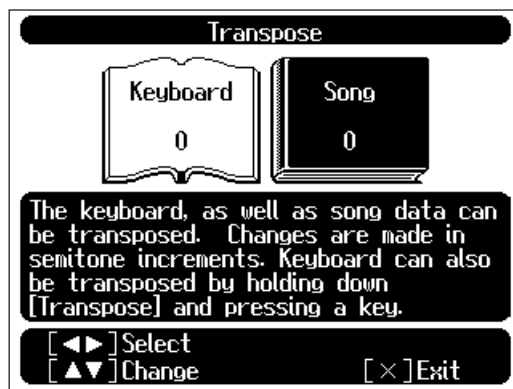
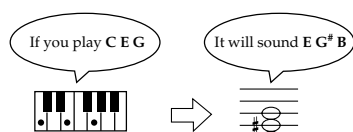

Item		Setting
Keyboard	Transpose the pitches played by the keyboard. This setting can be set by holding down the [Transpose] button and pressing the key to which you want to transpose.	-6-0-5
Song	Transpose the song playback.	-24-0-24

When you transpose the keyboard, the [Transpose] button's indicator will light. If the transpose setting is "0," the button's indicator will be dark.

To cancel transposition, press the [Transpose] button, getting its indicator to go dark.

The transposition setting returns to "0", when you choose another song.

Adjusting the Keyboard Touch (Key Touch)

You can adjust the touch (playing feel) of the keyboard.

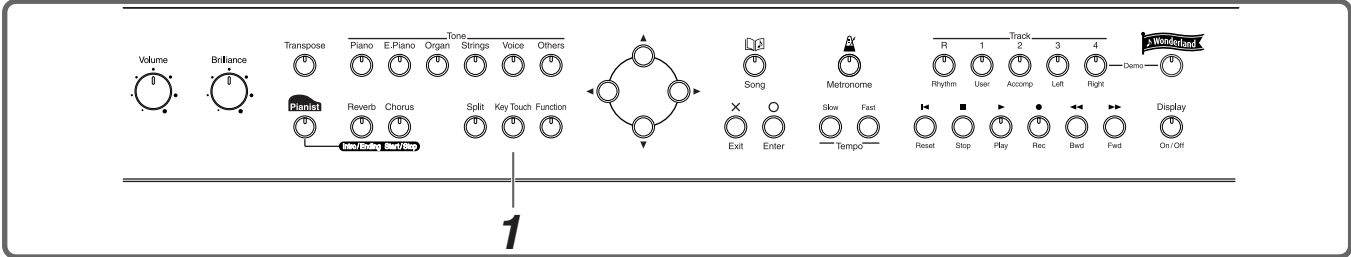

1 Press the [Key Touch] button.

Key Touch

Key Touch

Heavy

The touch sensitivity is adjustable.
 Heavy: Red
 You have to finger the keyboard more forcefully to play ff. This setting is suited to a dynamic fingering.

[Key Touch] Change [X]Exit

Key Touch
Key Touch
 Press to change the setting.

Return to the previous screen

Item	Indicator	Setting	
Key Touch	Dark	Medium	This allows you to play using the most natural touch. This setting is closest to the response of an acoustic piano.
	Red	Heavy	Fortissimo (ff) cannot be produced unless you play more strongly than usual, making the keyboard feel heavier. This setting allows you to add more expression when playing dynamically.
	Green	Light	Fortissimo (ff) can be produced by playing less strongly than usual, making the keyboard feel lighter. This setting makes it easier for children, whose hands have less strength.
	Orange	Fixed	Sounds at a fixed volume, regardless of your keyboard playing strength.

The [Key Touch] button can be pressed to change the keyboard touch even if the Display [On/Off] button has been used to turn off the screen. The color of the [Key Touch] button's indicator will show the selected setting.

Adding Variety to Your Performances

Selecting the Sound to Play

The HPi-5 contains 420 and more different tones.

The tones are organized into six tone groups, which are assigned to the [Tone] buttons.

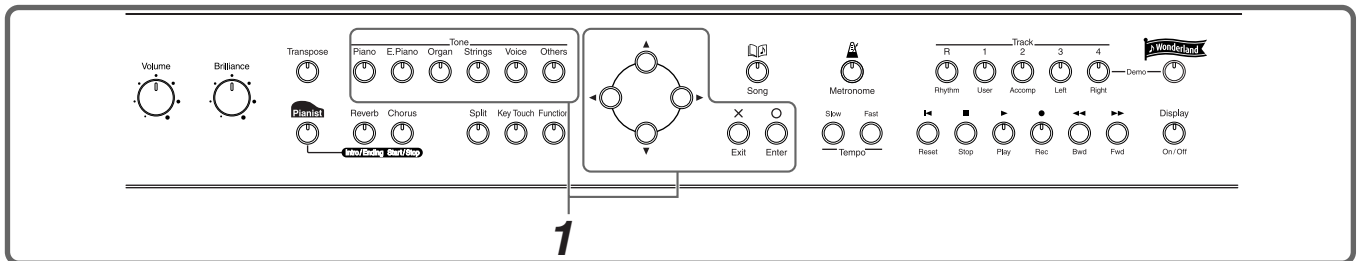

1 Press one of the [Tone] buttons, and select the desired tone in the screen.

When you press a [Tone] button, the button's indicator will light.

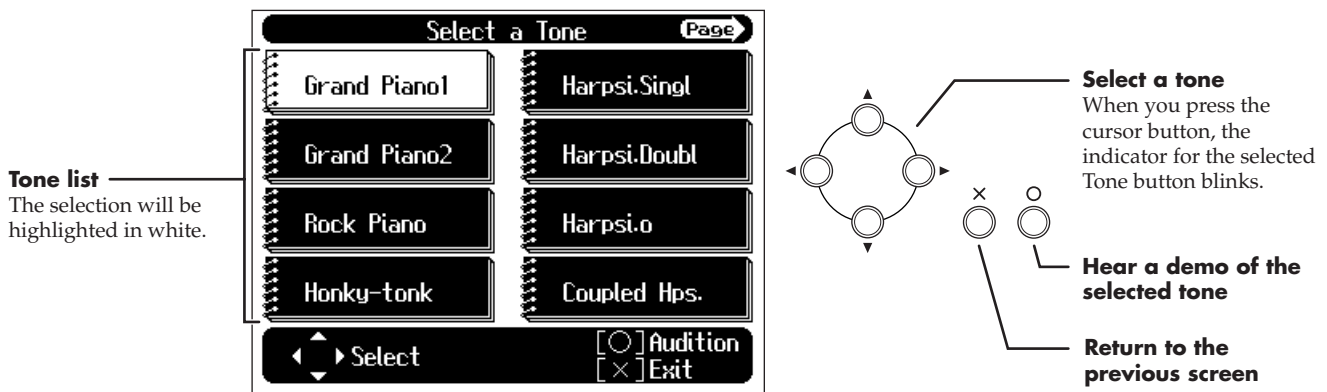

The selected tone will be finalized when you play the keyboard, or press the [Tone] button whose indicator is blinking. When your selection has been finalized, the button's indicator will change from blinking to lit.

The next time you press this [Tone] button, the tone you finalized here will be heard.

→ "Tone/Drum Set List" (p. 52)

Playing percussion instruments or sound effects

Press the Tone [Others] button.

Use the cursor buttons to select a rhythm set such as "DR Standard" or SFX set.

Drum set names are indicated by initial "DR."

Each note of the keyboard will play a different sound.

→ For the sounds that are assigned to each key of a drum set or sound effect set, refer to "Drum Set List" (p. 54).

Applying Effects to the Sound

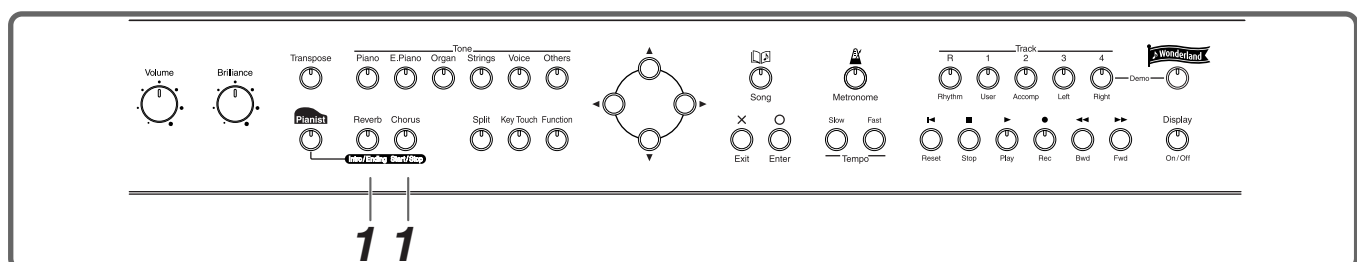

Adding reverberation to the sound (Reverb)

By applying the reverb effect you can produce a pleasant reverberation, making it sound as though you were performing in a concert hall.

1 Press the [Reverb] button.

The button's indicator will light, and a reverb effect will be applied to the sound. To cancel the reverb effect, press the [Reverb] button, getting its indicator to go dark.

* It is not possible to memorize the reverb effect setting for each sound.

Adding richness to the sound (Chorus)

By applying the chorus effect you can make the sound richer and more spacious.

1 Press the [Chorus] button.

The button's indicator will light, and a chorus effect will be applied to the sound. To cancel the chorus effect, press the [Chorus] button, getting its indicator to go dark.

* The chorus setting can be memorized for each sound.

→ The depth of the reverb effect and chorus effect can be adjusted. Refer to "Adjusting the depth of the effects (Effects)" (p. 43).

Playing Two Sounds Layered Together (Dual)

Simultaneously playing two sounds when one key is pressed is called "dual performance."

1 Simultaneously press two of the [Tone] buttons.

Both of the button indicators will light. Of the two buttons, the sound of the left button will be "Tone 1," and the sound of the right button will be "Tone 2."

Tone 1
Displays the tone name for the left Tone button that is selected.

Tone 2
Displays the tone name for the right Tone button that is selected.

Dual Balance
Displays the volume ratio of the two selected tones.

Change the tone, change the Dual Balance

Select the item to set
The selected item will be highlighted in white.

Return to the previous screen

When the tone names of "Tone 1" or "Tone 2" are highlighted, you can press the [▲] or [▼] button to select tones within the same tone group (→ p. 24).

When "Dual Balance" is highlighted, you can press the [▲] or [▼] button to adjust the volume balance between the two selected tones.

To cancel dual performance, press any [Tone] button.

Playing Different Sounds in the Right and Left Hand (Split)

Dividing the keyboard into right-hand and left-hand areas, then playing different sounds in each is called “split performance.” The boundary key is called the “split point.”

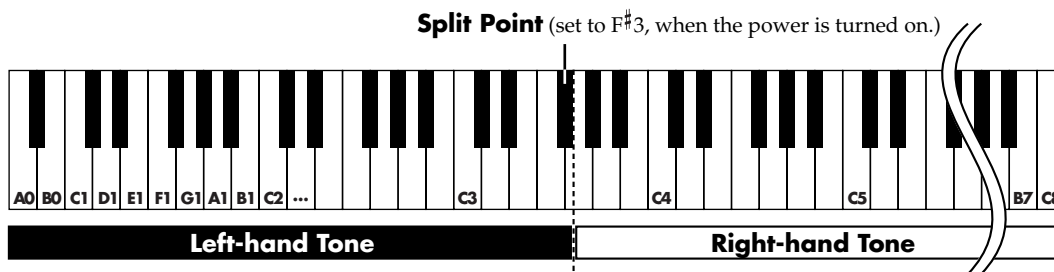

* The split point key is included in the left-hand keyboard area.

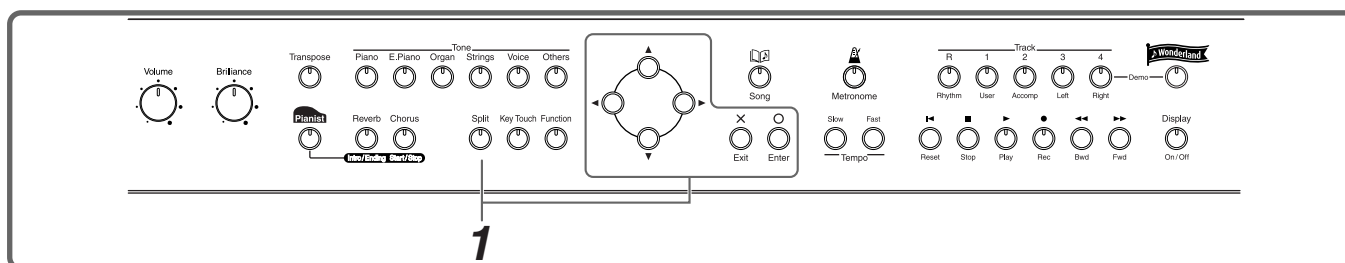

1 Press the [Split] button.

The button's indicator will light.

The tone on the right will be the “Right-hand Tone,” and the tone on the left will be the “Left-hand Tone.”

Left-hand Tone
Displays the name of the tone selected for the left-hand keyboard area.

Right-hand Tone
Displays the name of the tone selected for the right-hand keyboard area.

Split Point
Displays the key between the right-hand and left-hand keyboard areas.

Change the tone, change the Split Point

Select the item to set
The selected item will be highlighted in white.

Return to the previous screen

When the “Right-hand Tone” or “Left-hand Tone” are highlighted, you can use the [Tone] buttons and the [▲] or [▼] button to select tones.

When the “Split Point” is selected, you can press the [▲] or [▼] button to change the split point. The split point can also be set by holding down the [Split] button and pressing the key for the desired split point.

To cancel split performance, press the [Split] button, getting its indicator to go dark.

Changing from dual performance to split performance

By changing from dual performance to split performance, you can divide the keyboard into right-hand and left-hand areas, and layer two tones in the right-hand area.

- 1 When using Dual performance, press the [Split] button.

The [Split] button's indicator will light.

Left-hand Tone
Displays the name of the tone selected for the left-hand keyboard area.

Tone 1
Displays the name of Tone 1 of the Dual performance in the right-hand area.

Split Point
Displays the key between the right-hand and left-hand keyboard areas.

Tone 2
Displays the name of Tone 2 of the Dual performance in the right-hand area.

Dual Balance
Displays the volume ratio of the two tones selected for the right-hand area.

Change the tone, change the Split Point, change the Dual Balance
Change the tone, change the Split Point, change the Dual Balance

Select the item to set
The selected item will be highlighted in white.

Return to the previous screen

The screenshot shows a menu titled "Dual/Split" with the following fields: "Left-hand Tone" (Acoustic Bs.), "Tone 1" (Grand Piano), "Split Point" (F#3), "Tone 2" (Strings), and "Dual Balance" (7:3). At the bottom are buttons for "[Select] Change" and "[Exit]". To the right is a directional pad with a selected item (white circle) and a return button (circle with an 'x').

To switch from split to dual performance

- 1 When using split performance (p. 26), highlight the "Right-hand Tone."
- 2 Simultaneously press the two [Tone] buttons that you want to layer.

Adding an Accompaniment to Your Performance (Pianist Function)

The Pianist function automatically adds a suitable accompaniment to your piano performance. You can choose one of 30 different accompaniment styles as suitable for the song that you want to play. You can specify the accompaniment chord in the left-hand keyboard area, or press a single button to play an intro or ending.

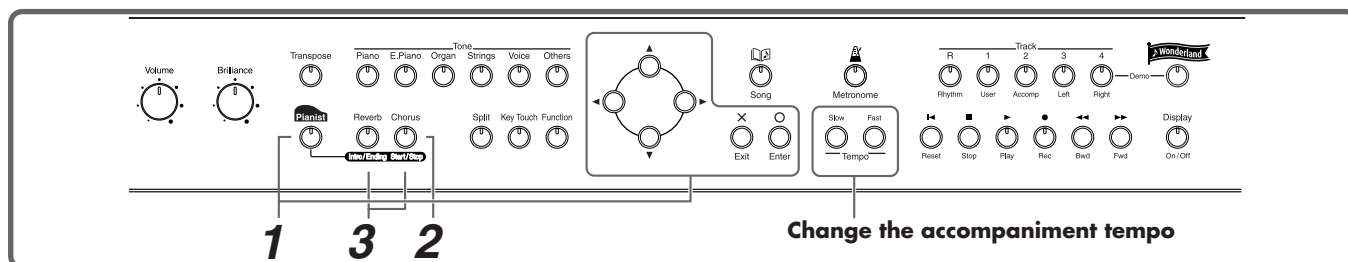

→ “Pianist Style List” (p. 56)

→ “Chord List” (p. 57)

1 Press the [Pianist] button to access the Style Select screen, and select an accompaniment style.

The [Pianist] button’s indicator will light, and the [Intro/Ending] button’s indicator will blink.

The keyboard will be divided at the Split Point (→ p. 26) into right-hand and left-hand areas.

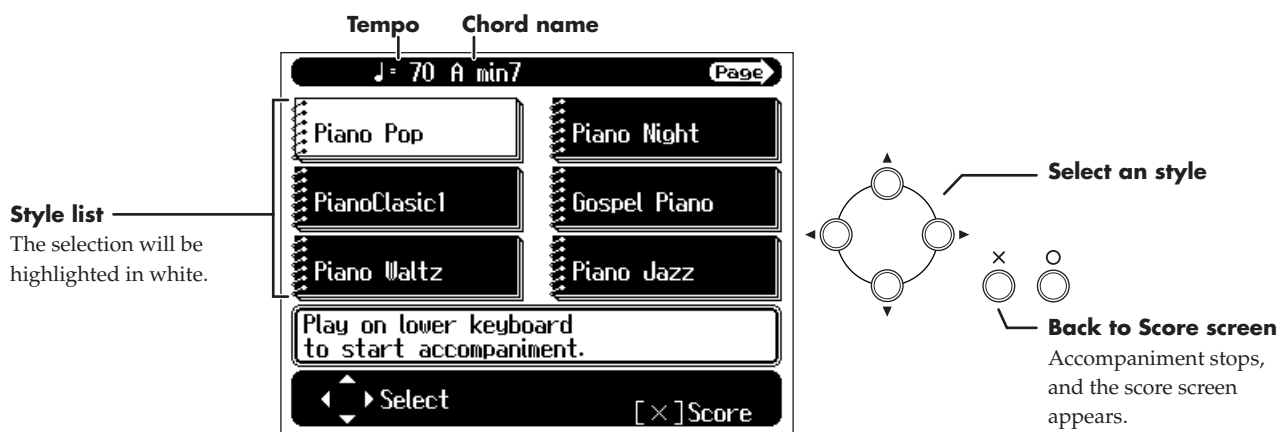

Starting the accompaniment

2 Either press the [Start/Stop] button, or play a chord in the left-hand keyboard area.

The accompaniment will begin with an intro.

If you do not want to add an intro, press the [Intro/Ending] button so its indicator goes dark, then perform step 2.

In the left-hand keyboard area, specify the accompaniment chord. Play freely in the right-hand keyboard area.

Stopping the accompaniment

3 Press the [Intro/Ending] button or the [Start/Stop] button.

If you press the [Intro/Ending] button, the accompaniment will stop after an ending. If you press the [Start/Stop] button, the accompaniment will stop immediately.

To cancel the Pianist function, press the [Pianist] button, getting its indicator to go dark.

* When using the Pianist function, you cannot select and play a sound in the left-hand keyboard area.

* You can change the split point by holding down the [Split] button and pressing a key (p. 26).

→ You can change the volume balance between the keyboard playing and the accompaniment. Refer to “Adjusting the volume balance between accompaniment and keyboard (Balance)” (p. 43).

* The accompaniment data produced by the Pianist function will not be output from the MIDI Out connector.

Playing in a Wonderland of Sound

“Wonderland” allows children to experience a variety of sounds and onboard songs with easy operation and enjoyable animation.

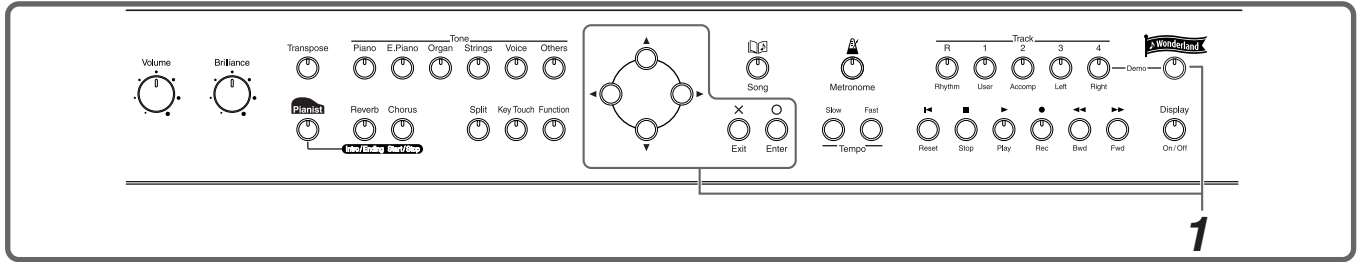

1 Press the [Wonderland] button, and select the desired item in the screen.

After the opening screen is displayed, a screen like the following will appear.

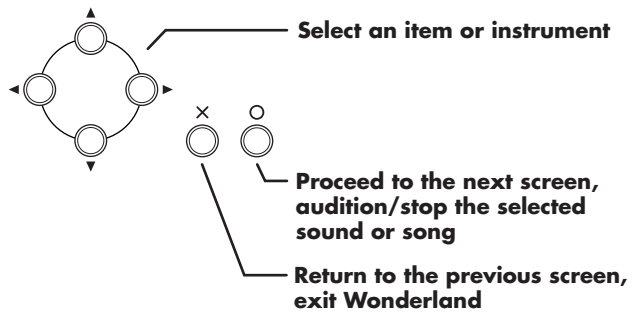
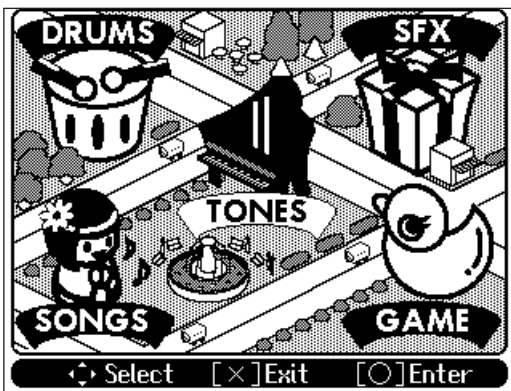

Explanation of each selection

Item	Content
DRUMS	Select a picture of a percussion instrument to hear the sound of that instrument. Play the keyboard to play the selected percussion instrument.
SFX	Listen to a wide variety of sound effects.
TONES	Select a picture of an instrument to hear the sound of that instrument. Play the keyboard to play the selected instrument.
SONGS	Listen to the onboard songs.
GAME	A note-guessing game.

To exit Wonderland, press the [X] button several times, or press the [Wonderland] button, getting its indicator to go dark.

* When using the Wonderland function, you can use the [Reverb] button and [Chorus] button to apply effects to the sound. (p. 24)

However, buttons other than the buttons used in step 1 above, and the [Reverb] and [Chorus] buttons will not be operable.

Recording Your Performance

The HPi-5 lets you record your own performances.

A recorded performance can be played back to hear your own playing, or to add additional parts.

The following types of recording can be done using the HPi-5.

- Record along with an internal song or disk song (→ “Recording Along with a Song”)
- Recording just your own keyboard performance (→ “Recording a New Song” (p. 31))
- Re-recording (→ p. 33)
- Using the Pianist function to record (→ “Recording with an accompaniment (the Pianist function)” (p. 34))
- Multitrack recording on five tracks (→ “Multitrack recording on five tracks” (p. 35))

* Songs you record are discarded as soon as you select another song, or turn off the power of the HPi-5. Be sure to save important performances on a floppy disk. Refer to “Saving a Song on a Floppy Disk” (p. 36).

Recording Along with a Song

You can record a performance that you play along with an internal song or disk song.

Here we will explain how you can listen to the accompaniment for an internal song while recording your right-hand performance.

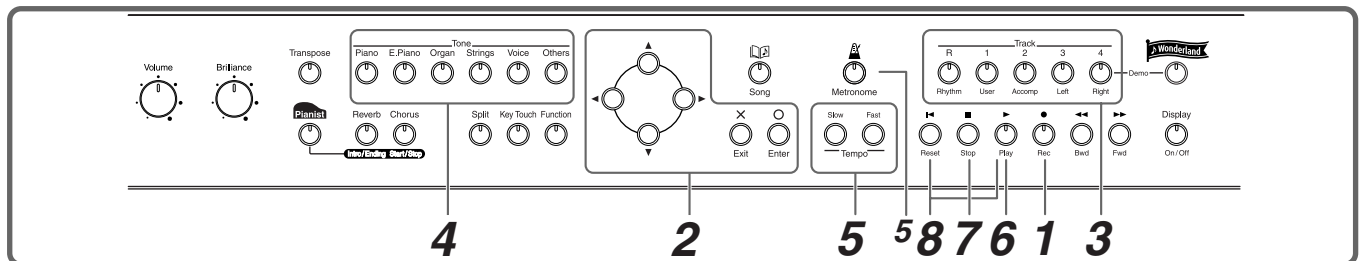

Before you record, first select a song, and press the [X] button to display the Score screen.

Refer to p. 16 for details on how to select an internal song, or to p. 40 for how to select a disk song.

Make recording settings

1 Press the [●] (Rec) button.

* While the measure number is highlighted in white, the score screen is being generated. When the highlighted number returns to normal, please try the operation again.

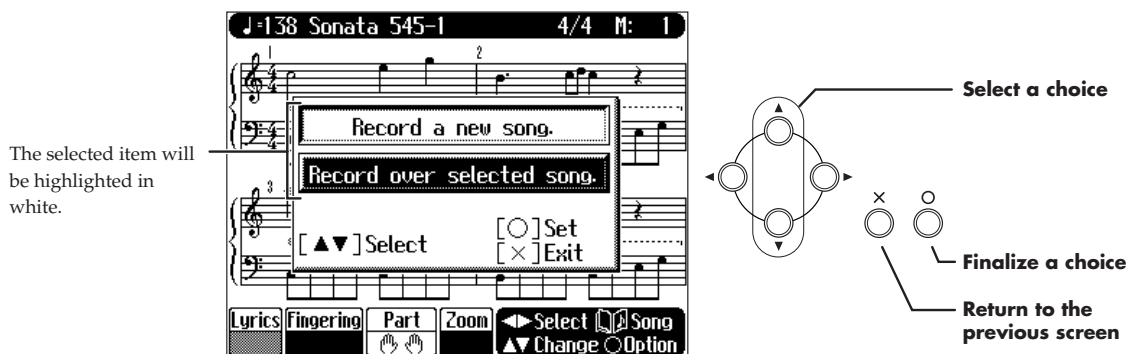

The selected item will be highlighted in white.

2 Choose “Record over selected song.”

With this setting, you can record while listening to the selected song.

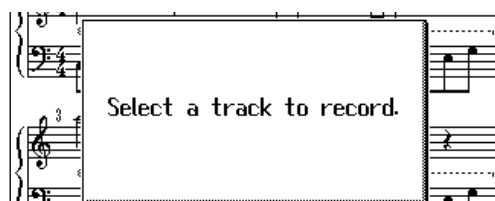

Select the track that you want to record

- 3** Press the track button for the track that you want to record (i.e., the track that you want to play yourself).

The indicator of the button you pressed will blink, and the HP1-5 enters recording-standby mode. Since in this example we will record the right-hand performance, press the [4/Right] button to make the button's indicator blink.

* Only the sounds of a drum set or SFX set can be recorded in the [R/Rhythm] button.

Select the tone that will be recorded

- 4** Use the [Tone] buttons to select the tone that you want to record.

After selecting the Tone, press the [X] button to display the Score screen.

Set the tempo

- 5** Use the [Tempo] buttons to set the recording tempo.

* The song tempo is stored within the song you selected. Although you can slow down the tempo for recording, the song will play back at the original tempo when your performance is played back.

* You can also record using the metronome. In this case, the sound of the metronome will not be recorded.

Start recording

- 6** Press the [▶ (Play)] button.

After a two-measure count, recording will begin.

Note that recording will also begin as soon as you play anything on the keyboard, even if you do not press the [▶ (Play)] button. In this case, no count will be heard.

When recording begins, the [▶ (Play)] button and [● (Rec)] button indicators will light.

Go ahead and perform on the keyboard.

Stop recording

- 7** Press the [■ (Stop)] button.

Play back the recorded performance

- 8** Press the [◀ (Reset)] button, and then press the [▶ (Play)] button.

You will hear the recorded performance.

To stop the playback, press the [■ (Stop)] button.

Recording a New Song

Here's how to record your own keyboard performance without using an internal song.

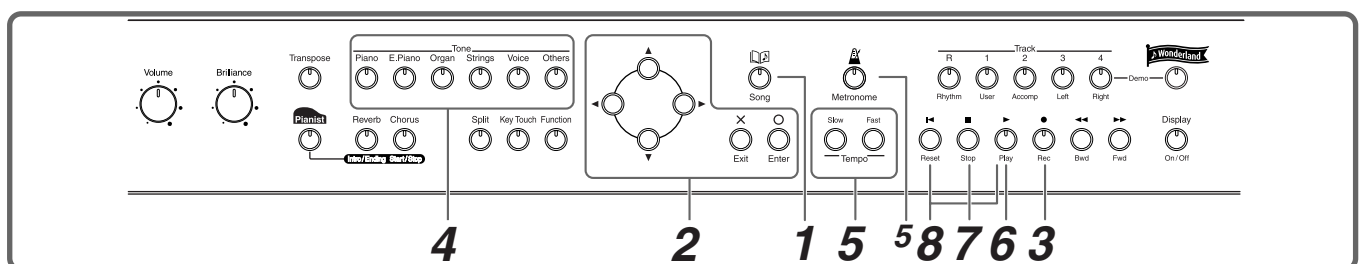

Make recording settings (choose "New Song")

- 1** Press the [Song] button.

Recording Your Performance

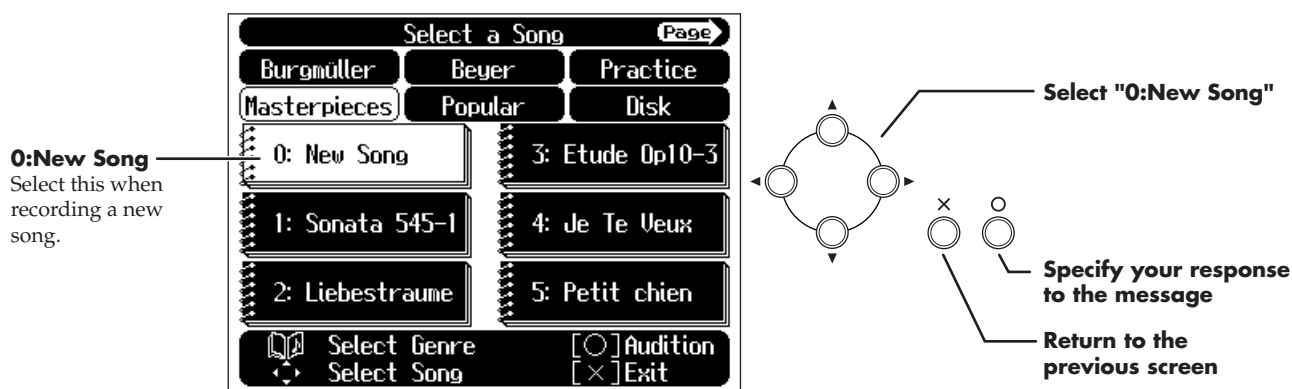

2 Select "0: New Song."

If the display does not indicate "New Song"

When you press a cursor button in the song select screen, the display will ask "Delete the selected song. OK?" (→ p. 17). When you delete the song, the "0: New Song" is displayed.

The score screen will appear when you press the [X] button several times.

3 Press the [● (Rec)] button.

The indicators of all Track buttons will blink, and the HPi-5 enters recording-standby mode.

- * If the display indicates "Record a new song/Record over selected song," select "Record a new song." In this case, steps 1–2 will be omitted.
- * Be aware that if you select "Record a new song," the currently selected song will disappear.

Select the tone that will be recorded

4 Use the [Tone] buttons to select the tone that you want to use for recording.

After selecting the Tone, press the [X] button to display the Score screen.

5 Use the [Tempo] buttons to set the recording tempo.

If you want to change the time signature (beat) of the song, press the [Metronome] button and make settings in the Metronome screen.

After setting the tempo, press the [X] button to display the Score screen.

- * You can use the metronome while recording. In this case, the metronome sound will not be recorded.

Start recording

6 Press the [▶ (Play)] button.

After a two-measure count, recording will begin.

Note that recording will also begin as soon as you play anything on the keyboard, even if you do not press the [▶ (Play)] button. In this case, no count will be heard.

Once recording begins, the [▶ (Play)] button and [● (Rec)] button indicators will light.

Go ahead and perform on the keyboard.

Stop recording

7 Press the [■ (Stop)] button.

The recorded performance will be recorded on the [1/User] button.

Play back the recorded performance

8 Press the [◀ (Reset)] button, and then press the [▶ (Play)] button.

You will hear the recorded performance.

To stop the playback, press the [■ (Stop)] button.

Track button assignments for the recorded performance

When you record only a keyboard performance, the performance will be assigned to the track buttons as follows.

- **Normal performance (playing a single sound from the entire keyboard)**
The performance is recorded to the [1/User] button.
- **Dual performance**
The performance is recorded to the [1/User] button.
- **Split performance**
The left-hand performance is recorded to the [3/Left] button, and the right-hand performance to the [4/Right] button.
- **Dual performance and Split performance**
The left-hand performance is recorded to the [3/Left] button, and the right-hand dual performance to the [4/Right] button.
- **Drum set or sound effect performance**
The performance is recorded to the [R/Rhythm] button.

Re-recording

When you want to re-record, specify the track button whose performance you want to re-record, and then record again.

When you select a previously recorded track button and re-record, the performance from the location at which you begin recording up to the location at which you stop recording will be replaced by the newly re-recorded performance.

- * The tempo of the song is stored within the song that was selected. You can slow down the tempo for recording, but when you play back the performance it will play back at the original tempo.

- 1** Use the [◀ (Bwd)] or [▶ (Fwd)] button to move to the measure that you want to re-record.
- 2** Press the [● (Rec)] button.

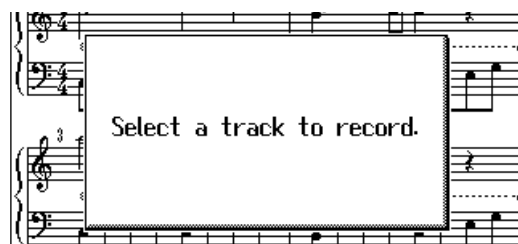

- 3** Press the track button for the track that you want to re-record.

The indicators of the button you pressed and of the [▶ (Play)] button will blink, and the HPi-5 enters recording-standby mode.

- 4** Press the [▶ (Play)] button to start recording.

After a two-measure count, recording will begin.

When recording begins, the [▶ (Play)] button and [● (Rec)] button indicators will light. Go ahead and perform on the keyboard.

- 5** Press the [■ (Stop)] button to stop recording.

Erasing a Recorded Song

A recorded song can be erased in the following two ways:

- 1 After recording a song, press the [Song] button and select another song in the song-select screen.
- 2 Hold down the [Song] button and press the [● (Rec)] button.

When either of these operations are performed, a display like the following will appear.

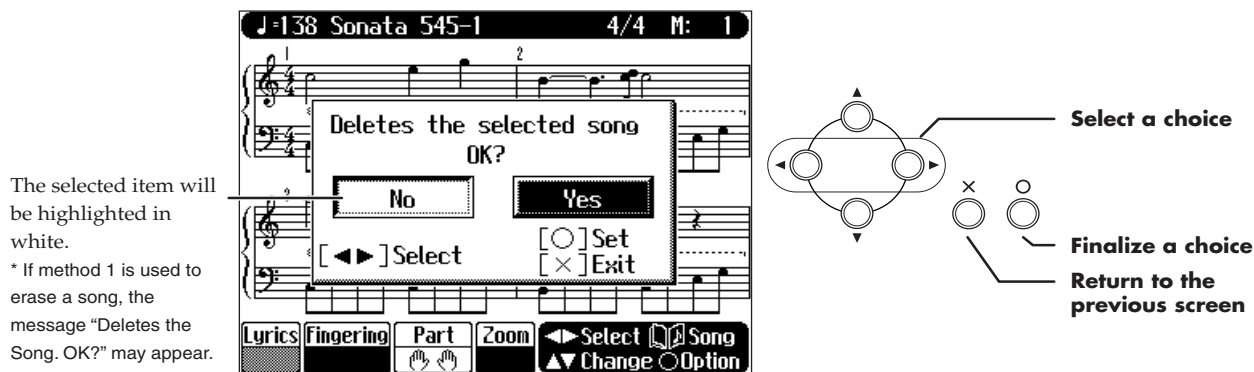

If you select "Yes," the song will be deleted.

If you do not want to erase the song, save it on a floppy disk. (→ p. 36)

Other Recording Methods

Recording with an accompaniment (the Pianist function)

You can use the Pianist function to record while adding an accompaniment.

→ For details on the Pianist function, refer to "Adding an Accompaniment to Your Performance (Pianist Function)" (p. 28).

1 As described in steps 1 and 2 of "Recording a New Song" (p. 31), select "New Song."

2 Press the [● (Rec)] button.

The indicators of all Track buttons will blink, and the HPi-5 enters recording-standby mode.

3 Press the [Pianist] button and select the desired accompaniment style.

Adjust the tempo as necessary.

4 Recording will begin at the moment you either press the [Start/Stop] button or begin playing in the left-hand keyboard area.

If you press the [▶ (Play)] button, the accompaniment will begin with an intro after a two-measure count, and recording will begin simultaneously.

5 When you press either the [Intro/Ending] or [Start/Stop] button to stop the accompaniment, recording will also stop simultaneously.

You can also press the [■ (Stop)] button to stop recording even in the middle of the accompaniment. The right-hand performance will be recorded on the [4/Right] track, the accompaniment drum sounds will be recorded on the [R/Rhythm] track, and the non-drum accompaniment sounds will be recorded on the [2/Accomp] track.

* If you want to re-record only your own performance after using the Pianist function to record, you must turn off the Pianist function before you record. If you fail to turn off the Pianist function, the Pianist accompaniment will be added to the previously recorded accompaniment.

* If you want to re-record the accompaniment of the Pianist function, select the [2/Accomp] track and re-record.

Multitrack recording on five tracks

Multitrack recording is a method by which you can record additional tracks while listening to the previously recorded tracks.

The HPI-5 provides five tracks, so you can record different sounds on each track to create an ensemble song.

Record the first track

1 Record your performance as described in “Recording a New Song” (p. 31).

* The song tempo will be remembered as the tempo at which you recorded the first track.

Record the second and subsequent tracks

2 Select and record additional tracks one at a time as described in “Re-recording” (p. 33).

For the second and subsequent recordings, you can listen to the previously recorded performances while you record.

Record additional tracks as desired to complete the song.

* Only drum set or SFX set sounds can be recorded in the [R/Rhythm] button.

The five track buttons and 16 parts

Many songs in commercially available SMF music files consist of 16 parts. The 16 parts are divided among the five track buttons.

The track buttons and the 16 parts correspond as follows.

Track button	Part
[R/Rhythm]	10 (D), 11 (S)
[1/User]	1
[2/Accomp]	2, 5–9, 12–16
[3/Left]	3
[4/Right]	4

Saving Your Performance

The performance data you record on the HPi-5 will be lost when you select another song or turn off the power of the HPi-5. If you want to keep important performance data, you must save it on a floppy disk.

→ If you will be using a disk drive for the first time, please be sure to read “Before Using Floppy Disks” (p. 6).

Saving a Song on a Floppy Disk

Inserting/removing a floppy disk

Inserting a floppy disk

With the label of the floppy disk facing upward, insert it into the disk drive until it clicks into place.

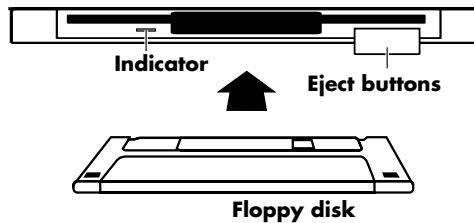

Removing a floppy disk

Press the eject button.

The floppy disk will protrude from the disk drive. Grasp the edge of the floppy disk and gently pull it out.

- * Don't try to eject the disk while reading or writing is in progress. Attempting to do so may damage the magnetic surface of the disk, rendering it unusable. (The indicator light for the disk drive lights up at full brightness when reading or writing data. Ordinarily, the indicator will be less brightly lit, or be extinguished.)

Formatting a floppy disk

A newly purchased floppy disk, or a floppy disk that has been used by another device cannot be used as is. Such floppy disks must be “formatted” for use with the HPi-5.

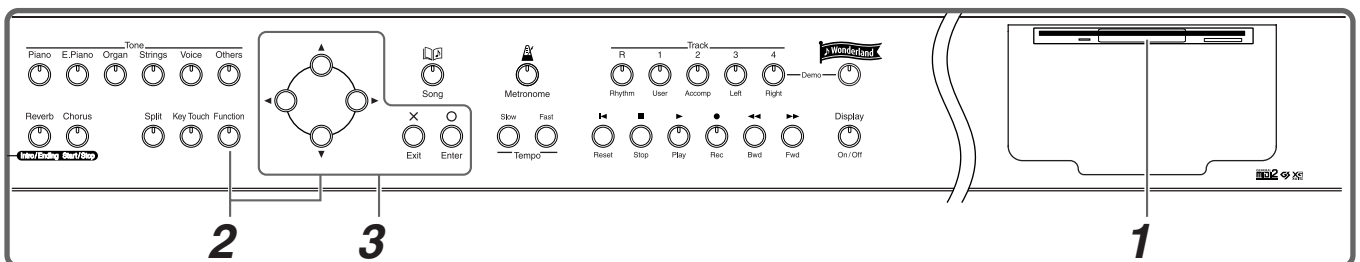

First make sure that the protect tab of the floppy disk is in the “Write (write enable)” position.

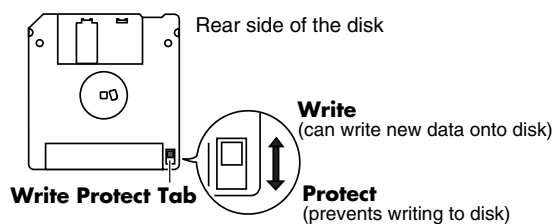

- 1** Insert the floppy disk into the disk drive.
- 2** Press the [Function] button, and select "Disk" in the screen, and press the [O] button.
- 3** Use the [◀][▶] buttons to select "Format," and press the [O] button.

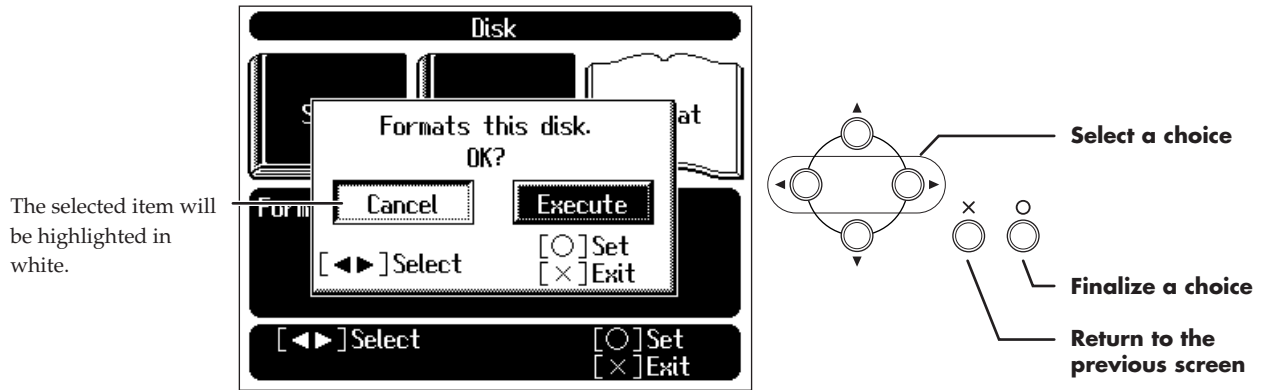

* Do not remove the floppy disk from the disk drive until formatting is complete.

Saving to a floppy disk

First make sure that the protect tab of the floppy disk is in the "Write (write enable)" position (p. 36).

- 1** Insert the floppy disk into the disk drive.
- 2** Press the [Function] button, and select "Disk" in the screen, and press the [O] button.
- 3** Use the [◀][▶] buttons to select "Save," and press the [O] button.

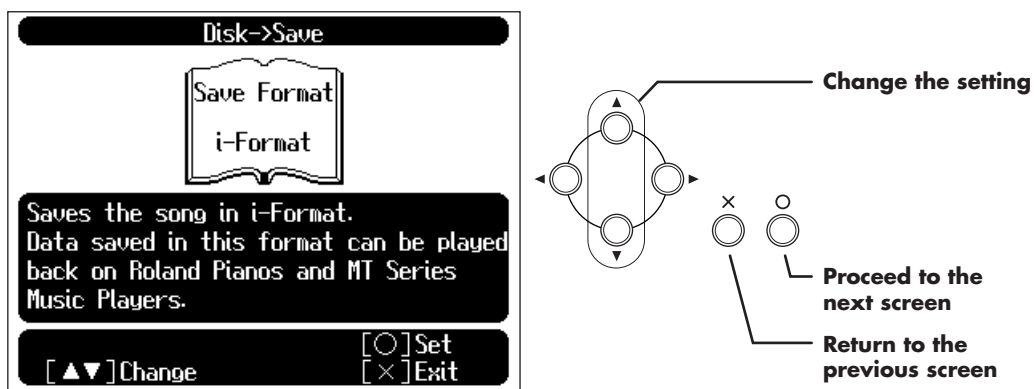

- 4** Select the format in which to save.

Value	Explanation
i-format	The song will be saved in i-format. A song saved in i-format can be listened to on Roland digital pianos (such as those from the HP-G/R and KR series), and on units from the MT series.
SMF	The song will be saved in SMF (Standard MIDI File) format. A song saved in SMF format can be played on the many devices that are able to play back SMF music files (→ p. 60).

* Songs can be saved in only one format on a single floppy disk. To protect the rights of the copyright owner, songs that were recorded using commercially available music files cannot be saved in SMF format.

Saving Your Performance

5 Specify the song name and the save-destination song number.

Song name
Displays the name of the song to save.

Characters that can be input:
ABCDEFGHIJKLMN
OPQRSTUVWXYZ
abcdefghijklmnopqrstuvwxyz
opqrstuvwxyz
0123456789!#\$%&'
()*+/-,:;<=>@[N^_`{|}
Space

Save Destination
Displays the save-destination song number.
If you select a song number that displays a song name, and save a new song, the previous song will be erased.

Change the character, change the song number
When the cursor is located at the song name item, change the character at the cursor location.
When the save-destination item is highlighted in white, change the save-destination song number.

Move the cursor, select an item to set

Finalize the setting and proceed to the next screen

Return to the previous screen

Disk->Save

New Song → **Save Destination**

Save the song under a new name. If song name appears in save dest. column, song has been saved already. After song name and save destination are determined, press [O].

[◀▶] Select [O] Set
[▲▼] Change [X] Exit

6 Follow the on-screen directions to begin saving the data.

The time required for saving will range from several seconds to half a minute or more.

* Never remove the floppy disk from the disk drive until saving is complete.

● Some notes on saving a song

- Due to certain types of handling, the data on a floppy disk can be damaged and become unplayable. We recommend that important song data be saved on two floppy disks.
- When a song is played back on some other devices, notes may drop out or may be played differently.
- When you are finished saving, set the protect tab of the floppy disk to the “protect” position (p. 6). This will prevent the song from being accidentally erased.

Erasing a Song from Floppy Disk

Here's how to erase a song that was saved on a floppy disk.

First make sure that the protect tab of the floppy disk is in the "write (write enable)" position (p. 36).

- 1** Insert the floppy disk into the disk drive.
- 2** Press the [Function] button, and select "Disk" in the screen, and press the [O] button.
- 3** Use [◀][▶] to select "Delete," and press the [O] button.

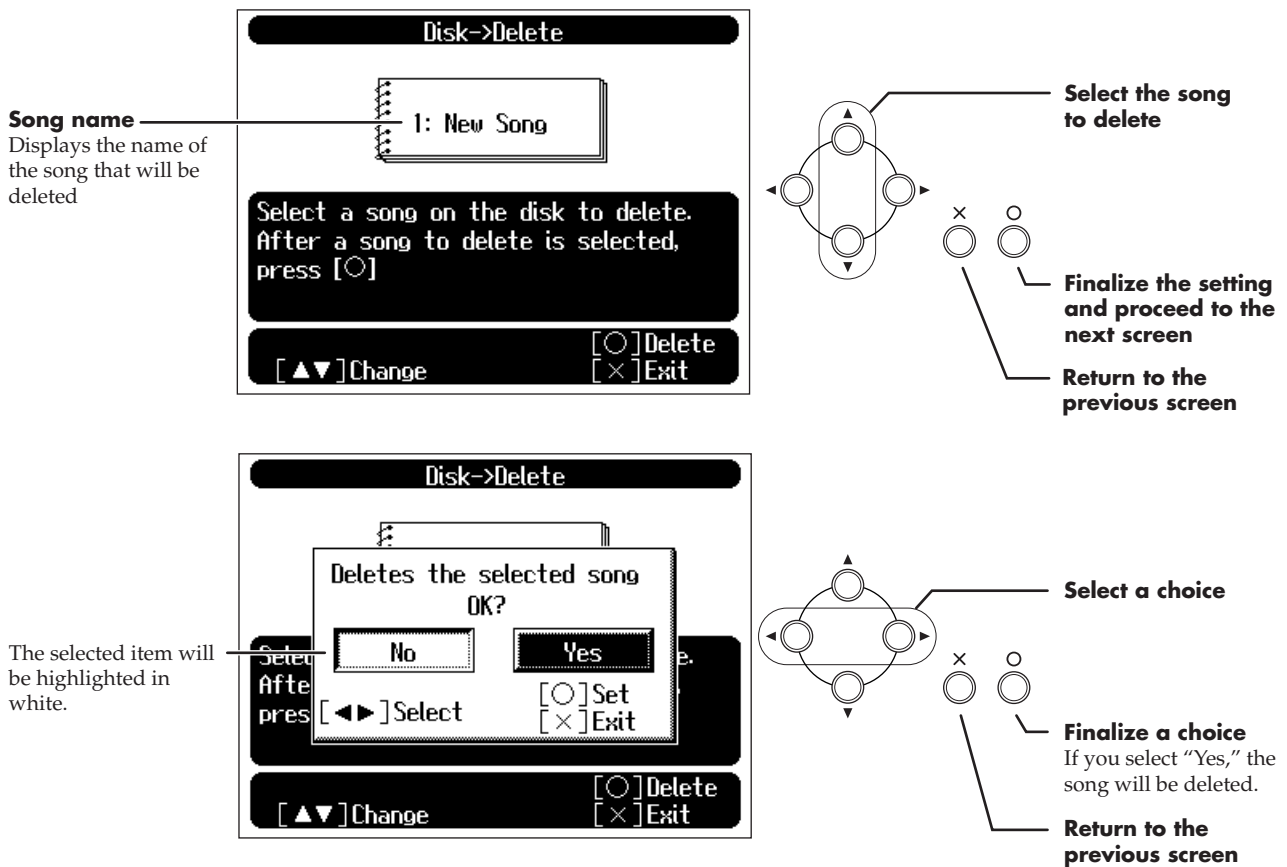

* Do not remove the floppy disk from the disk drive until deleting is complete.

Playing Back Music Files or a Song that was Saved on Floppy Disk

Here's how you can play back commercially available music files, or a song that was saved on a floppy disk. You can also play the keyboard along with the song playback.

- For details on using the score screen, refer to p. 15.
- If you will be using a disk drive for the first time, please be sure to read "Before Using Floppy Disks" (p. 6).

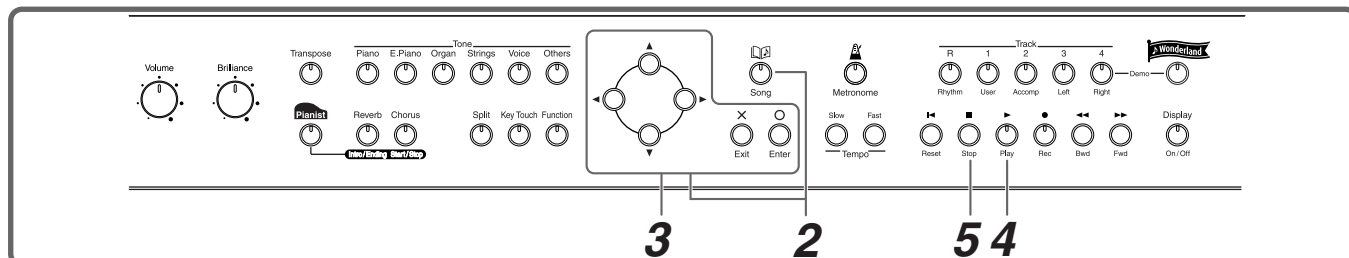

1 Insert the floppy disk into the disk drive.

Select a song

2 Press the [Song] button, and select "Disk" as the genre in the screen.



3 Select the song that you want to play back.

If a screen like the following is displayed

If a song has already been selected in the storage area (internal memory), it will not be possible to select another song or record a new performance.

If it is OK to erase the existing song, select "Yes." If you do not want to erase the song, select "No" and save the song on a floppy disk (→ p. 36).

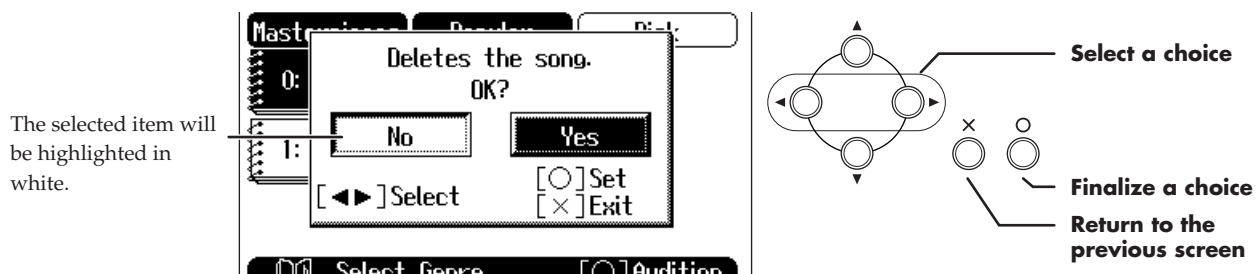

Play back the song

4 Press the [▶ (Play)] button.

The score screen will appear, and the song will begin playing.

The measure number in the screen will blink while the music file is being loaded. Please wait.

Stop playback

5 Press the [■ (Stop)] button.

Convenient Functions

Changing the Score Screen Settings

You can change the parts shown in the score screen, and how the score is displayed.

1 Access the score screen (→ p. 15), and press the [O] button.



The score screen will appear when you press the [X] button several times.



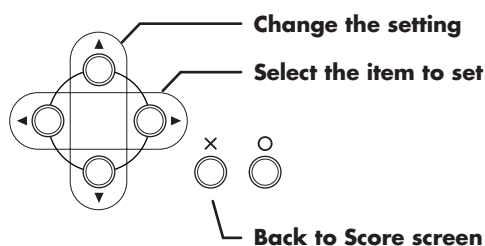

There are a total of three pages of "Score Options."





Item	Setting	
Pitches Specify how note names are displayed when the score screen is expanded.	Off	Not displayed.
	C, D, E	The note name (fixed doh) will be displayed.
	Do, Re, Mi	The scale degree (movable doh) will be displayed.

Item	Setting
 Select the part that will be displayed when you select  for "Part" in the score screen.	User Track, Parts 1-16

Item	Setting	
Clef L, Clef R Specify whether the score will be displayed as a G-clef or F-clef.	Auto	The display will be switched automatically.
	G clef	Select a G-clef score.
	F clef	Select a F-clef score.

Item	Setting
 Select the part that will be displayed when you select  for "Part" in the score screen.	Left Track, Parts 1-16

Item	Setting	
Key Display the score in the specified key.	Auto	The key will be set automatically according to the song file.
	b x 5-0-# x 6	The score will be displayed in the specified key.

Item	Setting
 Select the part that will be displayed when you select  for "Part" in the score screen.	Right Track, Part 1-16

Changing the Count Settings

You can change the number of measures in the count and the sound that will be used when a count has been specified.

- 1 Press the [Metronome] button to access the Metronome screen (→ p. 19).
If you do not want the metronome to sound, press the [Metronome] button once again.
- 2 Press the [O] button.

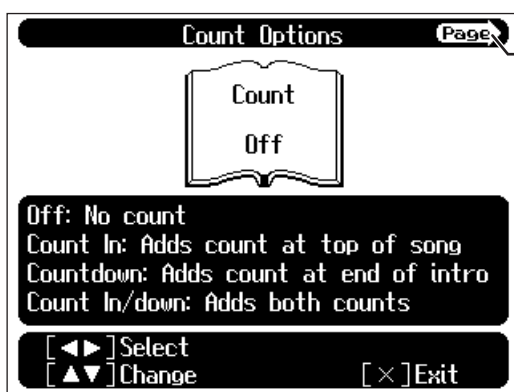

There are a total of three pages of "Count Options."

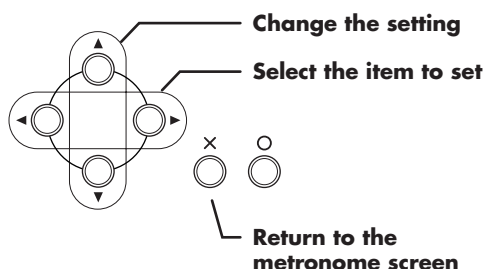

Item	Setting	
Count Specify which count will be added.	Off	No count will be added.
	Count In	A count will be added before the performance.
	Countdown	A count will be added only before you begin playing.
	Count In/down	Both a count-in and countdown will be added.

Item	Setting
Count In Sound Specify the count-in sound.	Stick, Click, Electronic, Voice (Japanese), Voice (English), Wood Block, Triangle & Castanets, Animal

Item	Setting
Countdown Sound Specify the count-down sound.	Voice (Japanese), Voice (English)

Item	Setting
Count In Measure Specify the length (number of measures) of the count-in.	1, 2

Item	Setting	
Countdown Track Specify the track or part that will determine the beginning of the performance when adding a countdown.	Left & Right Track	Right-hand and left-hand parts of a piano song
	Left Track	Left-hand part of a piano song
	Right Track	Right-hand part of a piano song
	Part 1-16	

Item	Setting
Count In Repeat When "Repeat" is turned on in the Marker setting screen (p. 21), this specifies whether the count-in will sound each time the range between the markers is repeated, or only the first time.	First time, Each time

Functions that Can be Selected Using the [Function] Button

Here's how you can easily make changes such as tuning the HPi-5 or changing the function of the pedals.

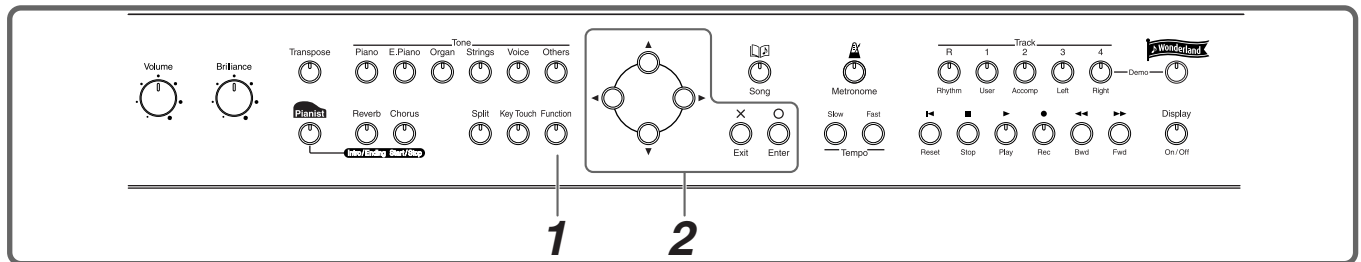

1 Press the [Function] button.

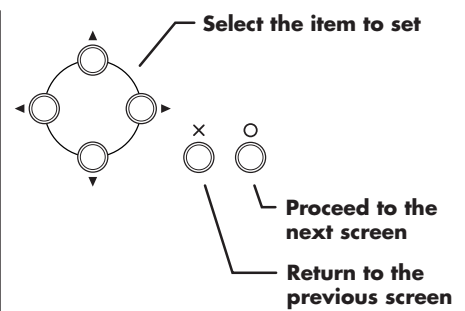
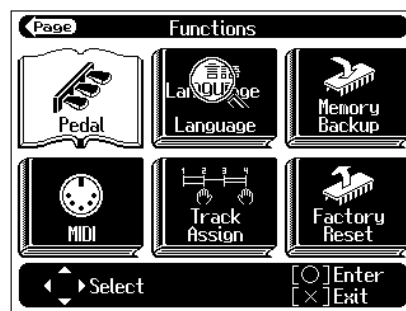

2 Use the cursor buttons to select the item that you want to set, and then press the [○] button.

Follow the directions shown in the screen.

For details on the contents and settings of each item, refer to p. 43–p. 45.

Refer to p. 47 on “MIDI,” and refer to p. 36 on “Disk.”

Adjusting the volume balance between accompaniment and keyboard (Balance)

You can adjust the balance between the volume of the sound played from the keyboard and the volume of the song playback or Pianist function (→ p. 28) accompaniment.

Setting

Press [▶] to change the setting toward “Keyboard”
Decreases the volume of the song or accompaniment

Press [◀] to change the setting toward “Accompaniment”
Decreases the volume of the keyboard sound

Adjusting the depth of the effects (Effects)

You can adjust the depth of the reverb (→ p. 25), chorus (→ p. 25), and sympathetic resonance.

→ Holding down the [Reverb] or [Chorus] button, press the [▲] or [▼] button to adjust the depth of each effect.

Holding down the [Reverb] and [Chorus] buttons, press the [▲] or [▼] button to adjust the depth of the sympathetic resonance.

Reverb, Chorus

Setting

1–10 Increasing the value will increase the amount of effect.

* This setting is valid when the [Chorus] button or [Reverb] button is turned on to apply an effect to the sound.

Sympathetic Resonance

On an acoustic piano, holding down the damper pedal will allow the remaining strings to resonate in sympathy with the sounds that you played from the keyboard, adding a rich resonance. The resonance is called “sympathetic resonance.”

Setting

0–10 Increasing the value will increase the amount of effect.

* This setting is valid when some piano sounds are selected and the damper pedal is pressed.

Assigning a marker in the middle of a measure (Marker Option/Resolution)

A marker can be assigned in the middle (at the beginning of a beat) of a measure.

→ For details on the marker screen, refer to “Assigning Markers to a Song for Repeated Practice” (p. 20).

In step 2 above, select “Marker” to access the Marker screen. Press the [○] button to access the Marker setting screen.

Setting

Measure Markers will be assigned to the beginning of a measure.

Beat Markers will be assigned to the beginning of a beat.

If you want to assign a marker to the beginning of a beat, assign the marker while playing back the song.

Convenient Functions

Setting the reference pitch and temperament (Tuning)

Refer to p. 43 for the procedure.

Tuning

In situations such as when playing in ensemble with other instruments, you can adjust the HPi-5's reference pitch to that of another instrument. Middle A is used as the reference pitch for tuning instruments.

The process of adjusting the reference pitch to match another instrument is called "Tuning."

Setting

415.3 Hz—440.0 Hz—466.2 Hz

Stretch Tuning

Pianos are generally tuned so that the low range is flatter and the high range is sharper than equal tempered pitches. This method of tuning is unique to the piano, and is known as "stretched tuning."

Setting

- On** This tuning curve expands the low range and high range. It is suitable for piano solos. This setting is selected when the power is turned on.
- Off** This is the standard tuning curve. It is suitable when playing in an ensemble with other instruments.

Temperament

You can play classical styles such as Baroque using historic temperaments (tuning methods).

Today, compositions are generally created with equal temperament in mind and are played using equal temperament. However in past ages of classical music, a variety of temperaments were used. By playing in the temperament that was in use when a composition was created, you can experience the sonorities of chords originally intended for that song.

Setting

Equal

This temperament divides the octave into 12 equal parts. All intervals will be slightly out of tune by the same amount.

Just Major

This temperament makes the 5th and 3rd intervals pure. It is unsuitable for playing melodies and modulation is not possible, but it produces beautifully harmonious chords.

Just Minor

Just intonation differs between major and minor keys. The same results as major can be obtained in a minor key.

Arabic

This tuning is suitable for the music of Arabia.

Kirnberger

This temperament is a modification of meantone temperament and just intonation, allowing more freedom of modulation. It allows you to play in all keys (third method).

Meantone

This temperament is a partial compromise of just intonation in order to allow modulation.

Pythagorean

This temperament is based on the theories of the Greek philosopher Pythagoras, and has pure fourths and fifths. Chords containing a third will sound impure, but melodies will sound good.

Werkmeister

This temperament is a combination of meantone and Pythagorean temperaments. It allows you to play in all keys. (First method, number three.)

Key

When playing in a temperament other than equal temperament, you must specify the tonic (the note corresponding to C for a major key, or to A for a minor key) of the key in which you will play.

If you have selected equal temperament, it is not necessary to select the tonic.

Setting

C, C#, D, Eb, E, F, F#, G, G#, A, Bb, B

Playing back the performance of a specific instrument (16 Track)

Commercially available SMF music files normally consists of 16 parts, and the performance of a different instrument is recorded on each part.

Of these 16 parts, you can select and play (solo) a specific part, or mute (silence) a selected part. (Muting just one specific part of the playback is referred to as "minus-one.")

Select a song before you begin the procedure.

Solo and mute can also be specified while playing back the song.

- 1 Press the [Function] button, and select "16 Track" in the screen.

16 parts

Indicates the status of each part.

The selected part is highlighted in white.

1-16 : Part number

Parts whose number is displayed will play.

- : Parts with no performance data

M : Muted parts

If muted, there will be no sound.



- 2 Use the [◀] or [▶] button to select the part that you want to solo or mute.

- 3 Use the [▲] or [▼] button to solo or mute the part.

Pressing the [◀] or [▶] button will move the soloed part.

When you once again press the [▲] or [▼] button, solo or mute will be defeated.

Changing the function of the pedals (Pedal)

You can change the function of the left pedal and center pedal. Refer to p. 43 for the procedure.

Left Pedal, Center Pedal

Setting

- Tap Tempo** The tempo of the song, accompaniment, or metronome will be set by the interval at which you press the pedal. When the pedal to which this function is assigned is pressed several times at the desired rate, the tempo will be set accordingly.
- Soft** When you hold down the pedal and play the keyboard, the sound will have a softer tone.
- Sostenuto** Only the notes that were played while the pedal was held down will be sustained.
- Lower Damper** When using Split performance, the same effect as the damper pedal will be applied to the left-hand keyboard area.

Changing the language displayed in the screen (Language)

You can change the language that is displayed in the screen. Refer to p. 43 for the procedure.

- * When you select this item, a message of "Deletes the selected song. OK?" may appear. For details, refer to "Erasing a Recorded Song" (p. 34).

Setting

English, Japanese, German, French, Spanish

- * German, French, and Spanish are displayed for some functions. Other screens will be displayed in English.

Remembering the settings even when the power is turned off (Memory Backup)

Normally, the settings of the various variations will revert to their default values when the power is turned off. However, you can specify that the various settings will be remembered even when the power is turned off.

This function is called "Memory Backup."

In step 2 on p. 43, select "Memory Backup" and press the [O] button, and a message will be displayed.

Use the [◀] or [▶] buttons to select "Execute," then press the [O] button to carry out the Memory Backup procedure.

Stored contents

- Stretch Tuning, Temperament, Key (p. 44)
 - The depth of the Sympathetic Resonance (p. 43)
 - Key Touch (p. 23)
 - Metronome Sound (p. 19)
 - Count In Sound, Countdown Sound (p. 42)
 - Language (p. 45)
- * Never turn off the power while the display indicates <Writing...>. Doing so will damage the HPI-5's internal memory, making it unusable.

Changing the parts assigned to the track buttons during SMF playback (Track Assign)

Ordinarily, when playing back SMF files for Roland Piano Digital instruments (→ p. 60), the left-hand part is assigned to the Track [3/Left] button, and the right-hand part is assigned to the Track [4/Right] button.

However, right-hand and left-hand part assignments in certain SMF files may differ. If these are set to "Auto," and as a result you are unable to use the track buttons to control the left- and right-hand parts properly, change the setting to "2/1 Part" or "3/4 Part." Refer to p. 43 for the procedure.

- * When you select this item, a message of "Deletes the selected song. OK?" may appear. For details, refer to "Erasing a Recorded Song" (p. 34).

Type

Setting

- Auto** The part assigned to each track will be determined automatically, depending on the song file.
- 2/1 Part** Part 1 will be assigned to the right-hand track, part 2 to the left-hand track, and part 3 to the user track.
- 3/4 Part** Part 4 will be assigned to the right-hand track, part 3 to the left-hand track, and part 1 to the user track.
- * After changing this setting, try selecting the song once again.

Restoring the factory settings (Factory Reset)

The memory backup settings can be restored to the factory-set condition. This operation is referred to as "Factory Reset."

In step 2 on p. 43, select "Factory Reset" and press the [O] button, and a message will be displayed.

Use the [◀] or [▶] buttons to select "Execute," then press the [O] button to carry out the Factory Reset procedure.

Once the Factory Reset has been completed, switch the power off, then on again.

- * Never turn off the power while the display indicates <Executing...>. Doing so will damage the HPI-5's internal memory, making it unusable.

Connecting External Devices

Connecting Audio Devices

You can connect audio devices to play the sound of the HPi-5 through the speakers of your audio system, or to record your performance on a tape recorder or other recording device. Use phone plug audio cables (sold separately) to make connections.

Example connections

- * To prevent malfunction and/or damage to speakers or other devices, always turn down the volume, and turn off the power on all devices before making any connections.
- Playing the sound of the HPi-5 through the speakers of an audio system/Recording the performance of the HPi-5 on a recording device

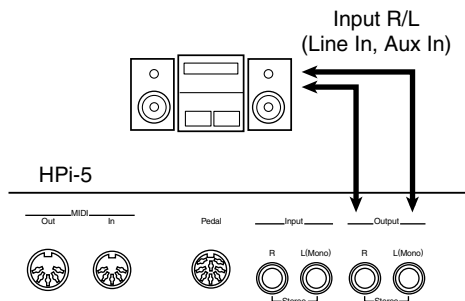

- Use the following procedure when turning on the power.

- 1 Turn on the power of the HPi-5.
- 2 Turn on the power of the connected device.
- 3 Adjust the volume of each device.

- Playing the sound of an audio device through the speakers of the HPi-5

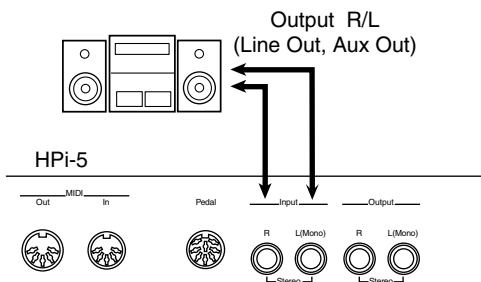

- Use the following procedure when turning on the power.

- 1 Turn on the power of the connected device.
- 2 Turn on the power of the HPi-5.
- 3 Adjust the volume of each device.

Connections with MIDI Devices

By connecting external MIDI devices and exchanging performance data, a device can control the performance of another device. For example, you can play sounds from another device, or select sounds remotely.

What is MIDI?

“MIDI” stands for “Musical Instrument Digital Interface,” and is a universal standard created to allow for the exchange of performance data among electronic musical instruments and computers. The HPi-5 provides MIDI connectors, which allow performance data to be exchanged with an external device. When these connectors are used to connect the HPi-5 to external devices, an even wider range of possibilities becomes available.

- * A separate publication titled “MIDI Implementation” is also available. It provides complete details concerning the way MIDI has been implemented on this unit. If you should require this publication (such as when you intend to carry out byte-level programming), please contact the nearest Roland Service Center or authorized Roland distributor.

Example connections

- * To prevent malfunction and/or damage to speakers or other devices, always turn down the volume, and turn off the power on all devices before making any connections.
- * The HPi-5 has one MIDI In connector on the rear panel and another on the bottom panel. It is not possible to use these two MIDI In connectors at the same time.
- Playing the HPi-5 from a MIDI sequencer/Recording an HPi-5 performance on a MIDI sequencer

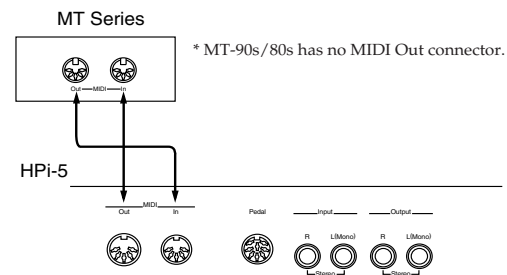

- * If you are connecting a MIDI sequencer, set “Local Off.” For details refer to “Local Control setting” (p. 48).
- Perform on the HPi-5 to play a MIDI sound generator

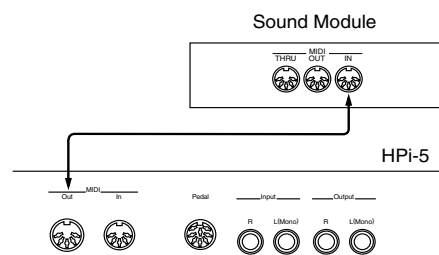

- For details on MIDI settings, refer to “Making MIDI-Related Settings” (p. 47).

Connections to a Computer

You can use a USB MIDI interface cable such as the Roland UM-1 (sold separately) to connect the HPi-5 to your computer.

If you connect a computer in which sequencer software such as Roland's "Visual MT" is installed, you will be able to play the sound of the software sound generator from the HPi-5's speakers, or save a recorded HPi-5 song on your computer.

Example connections

- * To prevent malfunction and/or damage to speakers or other devices, always turn down the volume, and turn off the power on all devices before making any connections.
- * In order to make connections to your computer, you must install "MIDI driver" software on your computer. For details refer to the owner's manual for your external MIDI device.

Use a USB MIDI interface cable to connect the USB connector of your computer to the MIDI connectors of the HPi-5.

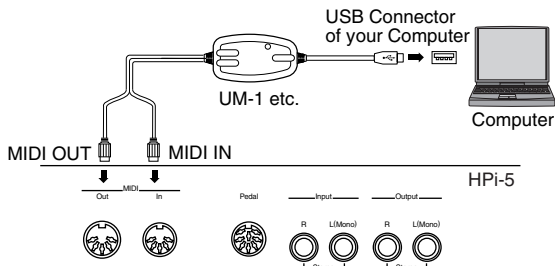

Making MIDI-Related Settings

Here's how you can set the transmit channel and other MIDI-related settings.

1 Press the [Function] button.

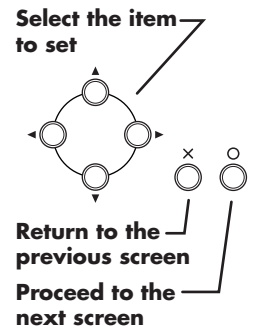
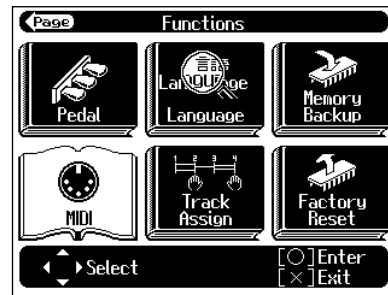

2 Select "MIDI," and press the [O] button.

There are a total of two pages of "MIDI Settings."

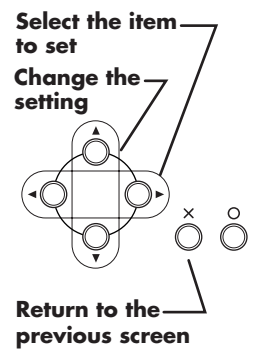
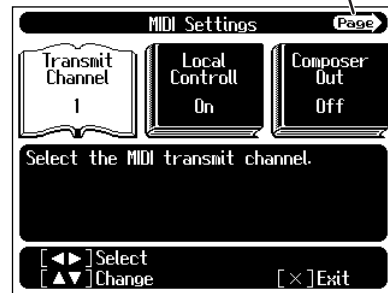

Follow the directions that appear in the screen.

MIDI settings

MIDI transmit channel setting

MIDI has sixteen "MIDI channels," numbered 1–16. Even if a MIDI device is connected, it will not be possible to play or select sounds unless the MIDI channels of the two devices match.

- * When Split performance (→ p. 26) is being used on the HPi-5, the left-hand keyboard area will not be transmitted.
- * When Dual performance (→ p. 25) is being used on the HPi-5, only the channel you specify here will be transmitted.
- * The HPi-5 receives all channels 1–16.

Item	Explanation	Setting
Transmit Channel	Select the MIDI transmit channel.	1–16

Connecting External Devices

Local Control setting

If the data that is produced when you play the keyboard is sent to the sound generation section via both routes (1) and (2) as shown in the diagram, notes will be doubled or may be interrupted. To prevent this, use the "Local Off" setting to disconnect route (1). Set Local Off if you have connected the HPi-5 to a MIDI sequencer.

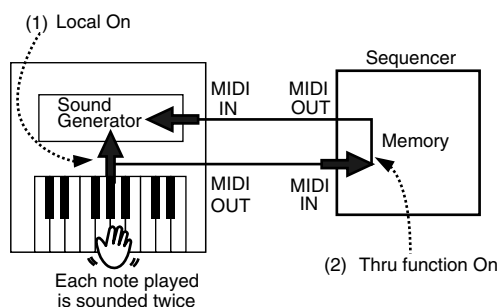

- * When a Roland MT series instrument is connected, it is not necessary to make the Local Off setting. The MT transmits a Local Off message when the power is turned on. If you turn on the power in the order of the HPi-5 → MT series, Local Off will be set automatically.

Item	Explanation	Setting
Local Control	Switch the Local Control setting on/off.	On, Off

Composer Out setting

If you want a performance recorded on the HPi-5 to be transmitted to an external MIDI device or computer, turn the "Composer Out" setting "On."

Item	Explanation	Setting
Composer Out	Specify whether a recorded performance will be transmitted to a MIDI device.	On, Off

Program Change setting

Program changes are a type of message that tell a device to "switch to sound number 'x'." A device that receives this message will select the sound of the corresponding number.

When you use this setting to specify a program change (program number), that program number will be transmitted to a MIDI device connected to the HPi-5. A MIDI device that receives the program number will switch to the sound corresponding to that program number.

Normally, program changes select from 128 different sounds. However, some MIDI devices have more than 128 sounds. For such devices, Bank Select messages are combined with Program Change messages to select sounds. Bank Select consists of two messages: MSB (controller number 0; value: 0–127), and LSB (controller number 32; value: 0–127).

- * Some MIDI devices cannot use bank select messages. Alternatively, some devices may use bank select messages, but ignore the LSB message.

Item	Explanation	Setting
Bank Select MSB	Transmit the bank select MSB.	0 (00h)–127 (7FH)
Bank Select LSB	Transmit the bank select LSB.	0 (00h)–127 (7FH)
Program Change	Transmit the program number.	1 (00h)–128 (7FH)

Trouble Shooting

If you think there's a problem, read this first.

Case	Cause/Remedy
The power doesn't come on.	Is the power cord connected and plugged in correctly? (p. 9)
The button doesn't work.	Is the panel locked? (p. 11) Turn the power off, then back on.
Nothing appears on screen.	The HPi-5 uses a liquid-crystal screen, so text may not be displayed when the ambient temperature is below freezing.
	Is the music stand (screen) connection cable connected correctly? (p. 9)
	Has the screen been turned off by the Display [On/Off] button? (p. 10) If the button's indicator is dark, the screen will be turned off.
Vertical lines appear in the screen/Color is "washed out" at the edges of the screen	These occur due to the nature of a liquid crystal display, and do not indicate a malfunction. They can be minimized by adjusting the brightness of the screen. (p. 10)
No sound is heard.	Is the volume level of the HPi-5 (p. 10) or connected device turned all the way down?
	Are headphones plugged in? (p. 9)
	Could the "Balance" setting be set all the way toward "Accomp" or "Keyboard"? (p. 43)
No sound is heard (when a MIDI instrument is connected).	Have all devices been switched on? (p. 46)
	Are the MIDI cables connected correctly? (p. 46)
	Does the MIDI channel match the connected instrument? (p. 47)
No sound is heard when the keyboard is played.	Has Local Control been set to "Off"? When Local Control is set to Off, no sound is produced by playing the keyboard, Set Local Control to On. (p. 48)
Volume of keyboard is too low	Could the "Balance" setting be set all the way toward "Accomp"? (p. 43)
No sound from left-hand section of keyboard	Is the [Pianist] button's indicator lit? (p. 28) If the [Pianist] button's indicator is lit, there will be no sound from the left-hand section of the keyboard.
Sounds are heard twice (doubled) when the keyboard is played.	Is the HPi-5 in Dual play? (p. 25)
	When the HPi-5 is connected to an external sequencer, set it to the Local OFF mode (p. 48). Alternatively, the sequencer could be set so its Soft Thru feature is OFF.

Case	Cause/Remedy
Not all played notes are sounded.	The maximum number of notes that the HPi-5 can play simultaneously is 64. Frequent use of the damper pedal during automatic accompaniment or when playing along with a song on floppy disk may result in performance data with too many notes, causing some notes to drop out.
Can't select a tone	Press the [X] button several times to return to the score screen (p. 14), and then select a tone.
The tuning or pitch of the keyboard or song is off.	Have you set Transpose? (p. 22)
	Are the settings for the "Temperament" and "Stretch Tuning" correct? (p. 44)
	Is the setting for the "Tuning" correct? (p. 44)
Volume of accompaniment or internal song is too low	Could the "Balance" setting be set all the way toward "Keyboard"? (p. 43)
Song doesn't play back	Does the screen indicate message, like "Deletes the selected song. OK?" (p. 17) The internal songs cannot be played back while recorded performance data remains in the HPi-5's memory. Try playing back the song after deleting the performance data.
Only the sound of a particular instrument in a song does not play	Is the light for the Track button extinguished? (p. 16) If the button light is out, the music on that track is not heard. Press the track button so the light is illuminated.
Pressing the [Reset] button doesn't return to the beginning of the song.	Some music files may contain settings that stop play at a point partway through the song. Press the [Reset] button several times more to return to the beginning of the tune.
The [Fwd] and [Bwd] buttons don't work.	The fast-forward and reverse buttons are ignored while music files is being read in. Wait until processing finishes.
There is a slight delay before playback of a song on floppy disk starts.	There are two types of SMF music files: format 0 and format 1. If the song uses SMF format 1 data, there will be a slight delay until playback starts. Refer to the booklet that came with the music files you're using to determine the format type.
Can't record	Has one of the track buttons for recording been selected? (p. 33)
	It is not possible to record while the score is being generated. Once the unit has finished generating the score (i.e., when the measure number in the screen is no longer highlighted), try the operation once again.

Trouble Shooting

Case	Cause/Remedy
Tempo of recorded song or metronome is off	If you select an internal song in which the tempo changes during the song, and then record, the tempo will change in the same way for the performances that are recorded on the other tracks. The tempo of the metronome will also change in the same way.
	If you record additional material without erasing the previously recorded song, the song will be recorded at the first-recorded tempo. Please erase the previously recorded song before you re-record. (p. 34)
The Tone has changed.	When a performance made along with a Music Files tune has been recorded, recording the performance to button [1/User] may make the Tones for buttons [3/Left] and [4/Right] change as well.
The recorded performance has disappeared.	Any performance that has been recorded is deleted when the power to the HPi-5 is turned off or a song is selected. A performance cannot be restored once it's been deleted.
Lyrics are not indicated properly in the display.	With some music files, the lyrics cannot be displayed correctly.
	In the score screen, some lyrics or notes could extend beyond the edges of the screen, and not be displayed.
Score is not indicated properly in the display.	If you select a part that does not contain performance data, notes will not be displayed in the score. Change the part that is displayed (p. 41).
	The score screen feature is particularly unsuitable for the display of difficult, complex musical works that demand accurate notation. Refer to "Some notes on the score screen" (p. 15).
	In the score screen, some lyrics or notes could extend beyond the edges of the screen, and not be displayed.
Depressing a pedal has no effect, or the pedal effect doesn't stop.	Is the pedal connected correctly? Make sure the pedal cord extending from the stand is securely connected to the pedal jack on the rear of the unit (p. 9).
	Has a different function been assigned to the pedal? See "Changing the function of the pedals (Pedal)" (p. 45).
The pedal rattles	Adjust the adjuster underneath the pedal so that the pedal presses firmly against the floor surface. (p. 11)

Case	Cause/Remedy
Reverberation still audible even with Reverb turned off	Since the HPi-5's piano sounds faithfully reproduce the sense of spaciousness and reverberation of an actual acoustic piano's sound, a certain amount of reverberation is still perceptible, even with the reverb effect deactivated.
In the upper range, the sound changes abruptly beyond a certain key	On an acoustic piano, notes in the upper one and a half octaves of the keyboard continue to sound until they decay naturally, regardless of the damper pedal. There is a difference in the timbre as well. Roland pianos faithfully simulate such characteristics of the acoustic piano. On the HPi-5, the range that is unaffected by the damper pedal will change depending on the Key Transpose setting.
A High-pitched whine is produced	When listening through headphones: Some of the more flamboyant and effervescent piano tones feature an ample high-end component, which may make the sound appear to have metallic reverberation added. Since this reverberation becomes particularly audible when supplemented by heavy reverb, you may be able to diminish the problem by reducing the amount of reverb applied to the sound.
	When listening through speakers: Here, a different cause (such as resonance produced by the HPi-5) would be suspect. Consult your Roland dealer or nearest Roland Service Center.
The bass range sounds odd, or there is a vibrating resonance	When listening through speakers: Playing at loud volumes may cause instruments near the HPi-5 to resonate. Resonance can also occur with fluorescent light tubes, glass doors, and other objects. In particular, this problem occurs more easily when the bass component is increased, and when the sound is played at higher volumes. Use the following measures to suppress such resonance.
	<ul style="list-style-type: none"> • Place speakers so they are 10–15 cm from walls and other surfaces. • Reduce the volume. • Move the speakers away from any resonating objects. When listening through headphones: Here, a different cause (such as resonance produced by the HPi-5) would be suspect. Consult your Roland dealer or nearest Roland Service Center.
The volume level of the instrument connected to Input jacks is too low.	Could you be using a connection cable that contains a resistor? Use a connection cable that does not contain a resistor.

If this Message Appears on Screen

Indication	Meaning
PU	When a song with a pickup (a song that does not start on the first beat) is played back, the measure numbers will be indicated in the display as PU, 1, 2, and so forth.
00: This data cannot be saved in SMF format. You cannot save on this floppy.	To protect the copyright, this music file cannot be saved as an SMF. Also, the music file can not be saved. If you want to save it, please save on the same floppy disk.
01: You cannot save this data.	You can only read the music file. It can not be saved on a floppy disk.
02: Write protected.	The protect tab on the floppy disk is set to the Protect position (p. 6). Change it to the Write position. Repeat the procedure.
03: This is a master disk.	This floppy disk cannot store the format or save any data. Insert a different disk and repeat the procedure.
04: Can't save to this disk.	The data cannot be saved onto this floppy disk because the format is different. Use the floppy disk in the same format.
05: You can't overwrite this file.	A new song cannot be written on this song. Select a different song number or use a different floppy disk, and repeat the procedure.
10: No disk.	No floppy disk is connected to the disk drive. Insert the disk correctly, and repeat the procedure.
11: Disk or memory full.	There is not sufficient space left on the floppy disk for the data to be saved. Save the data onto a different floppy disk.
12: Disk is not formatted.	The floppy disk inserted into the disk drive can't be read. Be sure you're using Roland SMF Music Files or other music files compatible with Roland digital pianos (p. 60). Also, if you want to save your work on floppy disk, you need to format the floppy disk first (p. 36).
13: Disk ejected while it was being accessed.	The floppy disk was removed from the disk drive while reading or writing was in progress. Insert the floppy disk and repeat the procedure.
14: Corrupt sector found on disk or in memory.	This floppy disk is damaged and cannot be used. Insert a different disk and repeat the procedure.

Indication	Meaning
15: Can't read this data.	Be sure you're using Roland SMF Music Files or other music files compatible with Roland digital pianos (p. 60).
16: Playback is aborted.	The HPI-5 cannot read the floppy disk quickly enough. Press the [■ (Stop)] button, then press the [◀ (Reset)] button and [▶ (Play)] button to play the song.
30: Can't do this function. Memory full.	Save the song on a floppy disk (p. 37) to delete the song data stored on the HPI-5 memory.
40: Buffer full.	The HPI-5 cannot deal with the excessive MIDI data sent from the external MIDI device. Reduce the amount of MIDI data sent to the HPI-5.
41: MIDI cable disconnected.	A MIDI cable has been disconnected. Connect it properly and securely.
42: Can't record.	An excessive amount of performance data has been sent to HPI-5 in one time and therefore could not be recorded.
51: Memory error.	There is something wrong with the system. Repeat the procedure from the beginning. If it is not solved after you have tried several times, contact the Roland service center.

Tone/Drum Set List

[Piano]

Grand Piano1
Grand Piano2
Rock Piano
Honky-tonk
Harpsi.Singl
Harpsi.Doubl
Harpsi.o
Coupled Hps.
UprightPiano
Piano 1
Piano 2
Piano 3
MIDI Piano1
MIDI Piano2

[E.Piano]

Stage Rhodes
E.Piano 1
E.Piano 2
E.Piano 3
Vibraphone
Marimba
Xylophone
Glockenspiel
EG+Rhodes 1
EG+Rhodes 2
Soft Clav.
Analog Clav.
FM+SA EP
St.FM EP
Hard FM EP
Soft E.Piano
Hard Rhodes
Hard E.Piano
Celesta
Vibra Bells
Music Box
Tubular-bell
Santur
Steel Drums

[Organ]

Church Organ
Pipe Organ 1
Pipe Organ 2
Organ Flute
Full Organ 1
Jazz Organ
Rock Organ1
Rock Organ2
Pop Organ
Lower Organ
Organ Bass
Trem.Flute
Accordion Fr
Accordion It
Harmonica

[Strings]

Strings
Slow Strings
Violin
Harp
Flute
Blow Sax
Soprano Sax
Oboe
PizzicatoStr
Syn.Strings1
Orchestra
OrchestraHit
Trumpet
Clarinet
Alto Sax
Tenor Sax
French Horn
MutedTrumpet
Pan Flute
Synth Brass1
Synth Brass2

[Voice]

Jazz Scat
Dat & Bop
Doos Voice
Pop Voice
Boys Choir
Choir Oohs
Choir
Fantasia
Dat Accent
Bop Accent
SynVox
Harpvox
Brightness
Crystal
Warm Pad
CC Solo
FM Lead
Cheese Saw

[Others]

Nylon Guitar
Steel Guitar
Overdrive Gt
12-str.Gt
Acoustic Bs.
A.Bass+Cymb1
DR STANDARD
SOUND EFFECT
Nylon+Steel
Jazz Guitar
Fingered Bs.
Fretless Bs.
Slap Bass
SynthBass101
DR ROOM
DR POWER
DR ELECTRO
DR TR-808
DR JAZZ
DR BRUSH
DR ORCHESTRA
DR GS STAND
DR GS ROOM
DR GS BRUSH

Piano 1
Piano 2
Piano 3
Piano 1w
Grand Piano2
UprightPiano
Rock Piano
Honky-tonk
Honky-tonk w
GS E.Piano1
GS E.Piano2
60's E.Piano
E.Piano 1v
E.Piano 2v
Detuned EP 1
Detuned EP 2
GS Harpsi.
Coupled Hps.
Harpsi.w
Harpsi.o
Soft Clav.
Celesta
Glockenspiel
Music Box
GS Vibe
Vibe.w
GS Marimba
Marimba
Xylophone
Tubular-bell
Church Bell
Carillon
Santur
Organ 1
Organ 2
Pop Organ
Detuned Or.1
Detuned Or.2
Church Org.1
Church Org.2
Church Org.3
Full Organ 2
Jazz Organ
Rock Organ2
Reed Organ
Accordion Fr
Accordion It
Harmonica
Bandoneon
GS Nylon Gt.
Nylon Guitar
Nylon Gt.o
Ukulele
Steel-str.Gt
12-str.Gt
Mandolin
Jazz Guitar
Hawaiian
Clean Gt.
Chorus Gt.
Muted Gt.
Funk Gt.
Funk Gt.2
Overdrive Gt
DistortionGt
Feedback Gt.
Gt.Harmonics
Gt. Feedback
GS Ac.Bass
GS Fing.Bass
Picked Bs

Fretless Bs.
Slap Bass
Slap Bass 2
SynthBass101
Synth Bass 1
Synth Bass 2
Synth Bass 3
Synth Bass 4
Rubber Bass
Violin
Slow Violin
Viola
Cello
Contrabass
Trem.Str
PizzicatoStr
Harp
Timpani
GS Strings
Orchestra
GS Sl.Str
Syn.Strings1
Syn.Strings2
Syn.Strings3
Choir Aahs
Choir
Pop Voice
SynVox
OrchestraHit
GS Trumpet
Trombone
Trombone 2
Tuba
MutedTrumpet
French Horn
Fr.Horn 2
Brass 1
Brass 2
Synth Brass1
Synth Brass2
Synth Brass3
Synth Brass4
AnalogBrass1
AnalogBrass2
Soprano Sax
Alto Sax
Tenor Sax
Baritone Sax
GS Oboe
English Horn
Bassoon
Clarinet
Piccolo
Flute
Recorder
Pan Flute
Bottle Blow
Shakuhachi
Whistle
Ocarina
Square Wave
Square
Sine Wave
Saw Wave
Saw
Doctor Solo
Syn.Calliope
Chiffer Lead
Charang
Solo Vox
5th Saw Wave

Bass & Lead
Fantasia
Warm Pad
Polysynth
Space Voice
Bowed Glass
Metal Pad
Halo Pad
Sweep Pad
Ice Rain
Soundtrack
Crystal
Syn Mallet
Atmosphere
Brightness
Goblin
Echo Drops
Echo Bell
Echo Pan
Star Theme
Sitar
Sitar 2
Banjo
Shamisen
Koto
Taisho Koto
Kalimba
Bagpipe
Fiddle
Shanai
Tinkle Bell
Agogo
Steel Drums
Woodblock
Castanets
Taiko
Concert BD
Melo. Tom 1
Melo. Tom 2
Synth Drum
808 Tom
Elec Perc.
Reverse Cym.
Gt.FretNoise
Gt.Cut Noise
String Slap
Breath Noise
Fl.Key Click
Seashore
Rain
Thunder
Wind
Stream
Bubble
Bird
Dog
Horse-Gallop
Bird 2
Telephone 1
Telephone 2
DoorCreaking
Door
Scratch
Windchime
Helicopter
Car-Engine
Car-Stop
Car-Pass
Car-Crash
Siren
Train

Jetplane
Starship
Burst Noise
Applause
Laughing
Screaming
Punch
Heart Beat
Footsteps
Gun Shot
Machine Gun
Lasergun
Explosion

GrandPiano1*
Honky-tonk*
E.Piano 1*
E.Piano 2*
Harpsichord*
Clav.*
Celesta*
Glocken*
Music Box*
Vibraphone*
Marimba*
Xylophone*
Tubularbell*
Santur*
Organ 1*
Organ 2*
Pop Organ 1*
Rock Organ2*
ChurchOrg.1*
Reed Organ*
AccordionFr*
Harmonica*
Bandoneon*
Nylon-strGt*
Steel-strGt*
Jazz Guitar*
Clean Gt.*
Muted Gt.*
Funk Gt.*
OverdriveGt*
Dist. Guitar*
Gt.Harmo*
Acoustic Bs*
Fingered Bs*
Picked Bs.*
Fretless Bs*
Slap Bass 1*
Slap Bass 2*
Synth Bass1*
Synth Bass2*
Rubber Bass*
Violin*
Viola*
Cello*
Contrabass*
Tremolo Str*
Pizzicato*
Harp*
Timpani*
Strings*
SlowStrings*
Syn.Str 1*
Syn.Str 2*
Choir Aahs*
Pop Voice*
SynVox*
Orche.Hit*

Trumpet*
Trombone*
Tuba*
M.Trumpet*
FrenchHorns*
Brass 1*
SynthBrass1*
SynthBrass2*
A.Brass 1*
Soprano Sax*
Alto Sax*
Tenor Sax*
BaritoneSax*
Oboe*
EnglishHorn*
Bassoon*
Clarinet*
Piccolo*
Flute*
Recorder*
Pan Flute*
Bottle Blow*
Shakuhachi*
Whistle*
Ocarina*
Square Wave*
Saw Wave*
Doctor Solo*
SynCalliope*
ChifferLead*
Charang*
Solo Vox*
5th SawWave*
Bass & Lead*
Fantasia*
Warm Pad*
Polysynth*
Space Voice*
Bowed Glass*
Metal Pad*
Halo Pad*
Sweep Pad*
Ice Rain*
Soundtrack*
Crystal*
Syn Mallet*
Atmosphere*
Brightness*
Goblin*
Echo Drops*
Star Theme*
Sitar*
Banjo*
Shamisen*
Koto*
Kalimba*
Bagpipe*
Fiddle*
Shanai*
Tinkle Bell*
Agogo*
Steel Drums*
Woodblock*
Taiko*
Melo.Tom 1*
Synth Drum*
ReverseCym.*
Fret Noise*
BreathNoise*
Seashore*
Bird*

Telephone 1*
Helicopter*
Applause*
Gun Shot*

* Tone with a "*" symbol appended to their name may not play back satisfactorily on other GS sound generating devices.

SFX Set

* -----: No sound.

* [EXC]: will not sound simultaneously with other percussion instruments of the same number.

SOUND EFFECT	
C2	36 -----
	37 -----
	38 -----
	39 High Q
	40 Slap
	41 Scratch Push [EXC7]
	42 Scratch Pull [EXC7]
	43 Sticks
	44 Square Click
	45 Metronome Click
	46 Metronome Bell
	47 Guitar sliding Finger
C3	48 Guitar cutting noise (up)
	49 Guitar cutting noise (down)
	50 String slap of double bass
	51 Fl.Key Click
	52 Laughing
	53 Screaming
	54 Punch
	55 Heart Beat
	56 Footsteps1
	57 Footsteps2
	58 Applause
	59 Door Creaking
C4	60 Door
	61 Scratch
	62 Wind Chimes
	63 Car-Engine
	64 Car-Stop
	65 Car-Pass
	66 Car-Crash
	67 Siren
	68 Train
	69 Jetplane
	70 Helicopter
	71 Starship
C5	72 Gun Shot
	73 Machine Gun
	74 Lasergun
	75 Explosion
	76 Dog
	77 Horse-Gallop
	78 Birds
	79 Rain
	80 Thunder
	81 Wind
	82 Seashore
	83 Stream
C6	84 Bubble
	85 Cat
	86 Bird
	87 BabyLaughing
	88 Boeeeen
	89 Glass & Glam
	90 Ice Ring
	91 Crack Bottle
	92 Pour Bottle
	93 Car Horn
	94 R.Crossing
	95 SL 1
	96 SL 2
C7	97 Seal
	98 Fancy Animal
	99 -----
	100 -----

Tone/Drum Set List

Drum Set List

* -----: No sound.

* [EXC]: will not sound simultaneously with other percussion instruments of the same number.

	DR STANDARD	DR ROOM	DR POWER	DR ELECTRO	DR TR-808
24	Bar Chime	Bar Chime	Bar Chime	Bar Chime	Bar Chime
25	Snare Roll	Snare Roll	Snare Roll	Snare Roll	Snare Roll
26	Finger Snap	Finger Snap	Finger Snap	Finger Snap	Finger Snap
27	High Q	High Q	High Q	High Q	High Q
28	Slap	Slap	Slap	Slap	Slap
29	Scratch Push [EXC7]	Scratch Push [EXC7]	Scratch Push [EXC7]	Scratch Push [EXC7]	Scratch Push [EXC7]
30	Scratch Pull [EXC7]	Scratch Pull [EXC7]	Scratch Pull [EXC7]	Scratch Pull [EXC7]	Scratch Pull [EXC7]
31	Sticks	Sticks	Sticks	Sticks	Sticks
32	Square Click	Square Click	Square Click	Square Click	Square Click
33	Metronome Click	Metronome Click	Metronome Click	Metronome Click	Metronome Click
34	Metronome Bell	Metronome Bell	Metronome Bell	Metronome Bell	Metronome Bell
35	Std Kick 2'	Kick1	Std Kick 2	Std Kick 2	Std Kick 2
36	Kick 1	Room Kick	MONDO Kick	Elec BD	808 Bass Drum 1
37	Side Stick	Side Stick	Side Stick	Side Stick	808 Rim Shot
38	Std Snr 1	Room Snr 1	Gated SD	Elec SD	808 Snare Drum
39	Hand Clap	Hand Clap	Hand Clap	Hand Clap	Hand Clap
40	Std Snr 2	Std Snr 1	Snare Drum 2	Gated SD	Snare Drum 2
41	Low Tom 2	Room Low Tom 2'	Room Low Tom 2	Elec Low Tom 2	808 Low Tom 2
42	Closed Hi-hat 1' [EXC1]	Closed Hi-hat 1' [EXC1]	Closed Hi-hat 1 [EXC1]	Closed Hi-hat 1 [EXC1]	808 CHH [EXC1]
43	Low Tom 1	Room Low Tom 1'	Room Low Tom 1	Elec Low Tom 1	808 Low Tom 1
44	Pedal Hi-hat 1' [EXC1]	Pedal Hi-hat 1' [EXC1]	Pedal Hi-hat 1 [EXC1]	Pedal Hi-hat 1 [EXC1]	808 CHH [EXC1]
45	Mid Tom 2	Room Mid Tom 2'	Room Mid Tom 2	Elec Mid Tom 2	808 Mid Tom 2
46	Open Hi-hat 1' [EXC1]	Open Hi-hat 1' [EXC1]	Open Hi-hat 1 [EXC1]	Open Hi-hat 1 [EXC1]	808 OHH [EXC1]
47	Mid Tom 1	Room Mid Tom 1'	Room Mid Tom 1	Elec Mid Tom 1	808 Mid Tom 1
48	High Tom 2	Room Hi Tom 2'	Room Hi Tom 2	Elec Hi Tom 2	808 Hi Tom 2
49	Crash Cymbal 1	Crash Cymbal 1	Crash Cymbal 1	Crash Cymbal 1	808 Cymbal
50	High Tom 1	Room Hi Tom 1'	Room Hi Tom 1	Elec Hi Tom 1	808 Hi Tom 1
51	Ride Cymbal 1	Ride Cymbal 1	Ride Cymbal 1	Ride Cymbal 1	Ride Cymbal 1
52	Chinese Cymbal	Chinese Cymbal	Chinese Cymbal	Reverse Cymbal	Chinese Cymbal
53	Ride Bell	Ride Bell	Ride Bell	Ride Bell	Ride Bell
54	Tambourine	Tambourine	Tambourine	Tambourine	Tambourine
55	Splash Cymbal	Splash Cymbal	Splash Cymbal	Splash Cymbal	Splash Cymbal
56	Cowbell	Cowbell	Cowbell	Cowbell	808 Cowbell
57	Crash Cymbal 2	Crash Cymbal 2	Crash Cymbal 2	Crash Cymbal 2	Crash Cymbal 2
58	Vibra-slap	Vibra-slap	Vibra-slap	Vibra-slap	Vibra-slap
59	Ride Cymbal 2	Ride Cymbal 2	Ride Cymbal 2	Ride Cymbal 2	Ride Cymbal 2
60	High Bongo	High Bongo	High Bongo	High Bongo	High Bongo
61	Low Bongo	Low Bongo	Low Bongo	Low Bongo	Low Bongo
62	Mute High Conga	Mute High Conga	Mute High Conga	Mute High Conga	808 High Conga
63	Open High Conga	Open High Conga	Open High Conga	Open High Conga	808 Mid Conga
64	Low Conga	Low Conga	Low Conga	Low Conga	808 Low Conga
65	High Timbale	High Timbale	High Timbale	High Timbale	High Timbale
66	Low Timbale	Low Timbale	Low Timbale	Low Timbale	Low Timbale
67	High Agogo	High Agogo	High Agogo	High Agogo	High Agogo
68	Low Agogo	Low Agogo	Low Agogo	Low Agogo	Low Agogo
69	Cabasa	Cabasa	Cabasa	Cabasa	Cabasa
70	Maracas	Maracas	Maracas	Maracas	808 Maracas
71	Short Hi Whistle [EXC2]	Short Hi Whistle [EXC2]	Short Hi Whistle [EXC2]	Short Hi Whistle [EXC2]	Short Hi Whistle [EXC2]
72	Long Low Whistle [EXC2]	Long Low Whistle [EXC2]	Long Low Whistle [EXC2]	Long Low Whistle [EXC2]	Long Low Whistle [EXC2]
73	Short Guiro [EXC3]	Short Guiro [EXC3]	Short Guiro [EXC3]	Short Guiro [EXC3]	Short Guiro [EXC3]
74	Long Guiro [EXC3]	Long Guiro [EXC3]	Long Guiro [EXC3]	Long Guiro [EXC3]	Long Guiro [EXC3]
75	Claves	Claves	Claves	Claves	808 Claves
76	High Wood Block	High Wood Block	High Wood Block	High Wood Block	High Wood Block
77	Low Wood Block	Low Wood Block	Low Wood Block	Low Wood Block	Low Wood Block
78	Mute Cuica [EXC4]	Mute Cuica [EXC4]	Mute Cuica [EXC4]	Mute Cuica [EXC4]	Mute Cuica [EXC4]
79	Open Cuica [EXC4]	Open Cuica [EXC4]	Open Cuica [EXC4]	Open Cuica [EXC4]	Open Cuica [EXC4]
80	Mute Triangle [EXC5]	Mute Triangle [EXC5]	Mute Triangle [EXC5]	Mute Triangle [EXC5]	Mute Triangle [EXC5]
81	Open Triangle [EXC5]	Open Triangle [EXC5]	Open Triangle [EXC5]	Open Triangle [EXC5]	Open Triangle [EXC5]
82	Shaker	Shaker	Shaker	Shaker	Shaker
83	Jingle Bell	Jingle Bell	Jingle Bell	Jingle Bell	Jingle Bell
84	Bell Tree	Bell Tree	Bell Tree	Bell Tree	Bell Tree
85	Castanets	Castanets	Castanets	Castanets	Castanets
86	Mute Surdo [EXC6]	Mute Surdo [EXC6]	Mute Surdo [EXC6]	Mute Surdo [EXC6]	Mute Surdo [EXC6]
87	Open Surdo [EXC6]	Open Surdo [EXC6]	Open Surdo [EXC6]	Open Surdo [EXC6]	Open Surdo [EXC6]
88	-----	-----	-----	-----	-----

Tone/Drum Set List

* -----: No sound.

* [EXC]: will not sound simultaneously with other percussion instruments of the same number.

	DR JAZZ DR GS STAND	DR BRUSH	DR ORCHESTRA	DR GS ROOM	DR GS BRUSH
	24 Bar Chime	Bar Chime	Bar Chime	Bar Chime	Bar Chime
	25 Snare Roll	Snare Roll	Snare Roll	Snare Roll	Snare Roll
	26 Finger Snap	Finger Snap	Finger Snap	Finger Snap	Finger Snap
	27 High Q	High Q	Close Hi-hat [EXC1]	High Q	High Q
	28 Slap	Slap	Pedal Hi-hat [EXC1]	Slap	Slap
	29 Scratch Push [EXC7]	Scratch Push [EXC7]	Open Hi-hat [EXC1]	Scratch Push [EXC7]	Scratch Push [EXC7]
	30 Scratch Pull [EXC7]	Scratch Pull [EXC7]	Ride Cymbal	Scratch Pull [EXC7]	Scratch Pull [EXC7]
	31 Sticks	Sticks	Sticks	Sticks	Sticks
	32 Square Click	Square Click	Square Click	Square Click	Square Click
	33 Metronome Click	Metronome Click	Metronome Click	Metronome Click	Metronome Click
	34 Metronome Bell	Metronome Bell	Metronome Bell	Metronome Bell	Metronome Bell
	35 Std Kick 2	Kick 2	Concert BD 2	Std Kick 2	Std Kick 2
C2	36 Std Kick 1	Kick 1	Concert BD 1	Std Kick 1	Std Kick 1
	37 Side Stick	Side Stick	Side Stick	Side Stick	Side Stick
	38 Snare Drum 1	Brush Tap	Concert SD	Snare Drum 1	Brush Tap
	39 Hand Clap	Brush Slap	Castanets	Hand Clap	Brush Slap
	40 Snare Drum 2	Brush Swirl	Concert SD	Snare Drum 2	Brush Swirl
	41 Low Tom 2	Brush Low Tom 2	Timpani F	Room Low Tom 2	Low Tom 2
	42 Closed Hi-hat 1 [EXC1]	Closed Hi-hat 2 [EXC1]	Timpani F#	Closed Hi-hat 1 [EXC1]	Closed Hi-hat 1 [EXC1]
	43 Low Tom 1	Brush Low Tom 1	Timpani G	Room Low Tom 1	Low Tom 1
	44 Pedal Hi-hat 1 [EXC1]	Pedal Hi-hat 2 [EXC1]	Timpani G#	Pedal Hi-hat 1 [EXC1]	Pedal Hi-hat 1 [EXC1]
	45 Mid Tom 2	Brush Mid Tom 2	Timpani A	Room Mid Tom 2	Mid Tom 2
	46 Open Hi-hat 1 [EXC1]	Open Hi-hat 2 [EXC1]	Timpani A#	Open Hi-hat 1 [EXC1]	Open Hi-hat 1 [EXC1]
	47 Mid Tom 1	Brush Mid Tom 1	Timpani B	Room Mid Tom 1	Mid Tom 1
C3	48 High Tom 2	Brush Hi Tom 2	Timpani c	Room Hi Tom 2	High Tom 2
	49 Crash Cymbal 1	Crash Cymbal 1	Timpani c#	Crash Cymbal 1	Crash Cymbal 1
	50 High Tom 1	Brush Hi Tom 1	Timpani d	Room Hi Tom 1	High Tom 1
	51 Ride Cymbal 1	Ride Cymbal 1	Timpani d#	Ride Cymbal 1	Ride Cymbal 1
	52 Chinese Cymbal	Chinese Cymbal	Timpani e	Chinese Cymbal	Chinese Cymbal
	53 Ride Bell	Ride Bell	Timpani f	Ride Bell	Ride Bell
	54 Tambourine	Tambourine	Tambourine	Tambourine	Tambourine
	55 Splash Cymbal	Splash Cymbal	Splash Cymbal	Splash Cymbal	Splash Cymbal
	56 Cowbell	Cowbell	Cowbell	Cowbell	Cowbell
	57 Crash Cymbal 2	Crash Cymbal 2	Concert Cymbal 2	Crash Cymbal 2	Crash Cymbal 2
	58 Vibra-slap	Vibra-slap	Vibra-slap	Vibra-slap	Vibra-slap
	59 Ride Cymbal 2	Ride Cymbal 2	Concert Cymbal 1	Ride Cymbal 2	Ride Cymbal 2
C4	60 High Bongo	High Bongo	High Bongo	High Bongo	High Bongo
	61 Low Bongo	Low Bongo	Low Bongo	Low Bongo	Low Bongo
	62 Mute High Conga	Mute High Conga	Mute High Conga	Mute High Conga	Mute High Conga
	63 Open High Conga	Open High Conga	Open High Conga	Open High Conga	Open High Conga
	64 Low Conga	Low Conga	Low Conga	Low Conga	Low Conga
	65 High Timbale	High Timbale	High Timbale	High Timbale	High Timbale
	66 Low Timbale	Low Timbale	Low Timbale	Low Timbale	Low Timbale
	67 High Agogo	High Agogo	High Agogo	High Agogo	High Agogo
	68 Low Agogo	Low Agogo	Low Agogo	Low Agogo	Low Agogo
	69 Cabasa	Cabasa	Cabasa	Cabasa	Cabasa
	70 Maracas	Maracas	Maracas	Maracas	Maracas
	71 Short Hi Whistle [EXC2]	Short Hi Whistle [EXC2]	Short Hi Whistle [EXC2]	Short Hi Whistle [EXC2]	Short Hi Whistle [EXC2]
C5	72 Long Low Whistle [EXC2]	Long Low Whistle [EXC2]	Long Low Whistle [EXC2]	Long Low Whistle [EXC2]	Long Low Whistle [EXC2]
	73 Short Guiro [EXC3]	Short Guiro [EXC3]	Short Guiro [EXC3]	Short Guiro [EXC3]	Short Guiro [EXC3]
	74 Long Guiro [EXC3]	Long Guiro [EXC3]	Long Guiro [EXC3]	Long Guiro [EXC3]	Long Guiro [EXC3]
	75 Claves	Claves	Claves	Claves	Claves
	76 High Wood Block	High Wood Block	High Wood Block	High Wood Block	High Wood Block
	77 Low Wood Block	Low Wood Block	Low Wood Block	Low Wood Block	Low Wood Block
	78 Mute Cuica [EXC4]	Mute Cuica [EXC4]	Mute Cuica [EXC4]	Mute Cuica [EXC4]	Mute Cuica [EXC4]
	79 Open Cuica [EXC4]	Open Cuica [EXC4]	Open Cuica [EXC4]	Open Cuica [EXC4]	Open Cuica [EXC4]
	80 Mute Triangle [EXC5]	Mute Triangle [EXC5]	Mute Triangle [EXC5]	Mute Triangle [EXC5]	Mute Triangle [EXC5]
	81 Open Triangle [EXC5]	Open Triangle [EXC5]	Open Triangle [EXC5]	Open Triangle [EXC5]	Open Triangle [EXC5]
	82 Shaker	Shaker	Shaker	Shaker	Shaker
	83 Jingle Bell	Jingle Bell	Jingle Bell	Jingle Bell	Jingle Bell
C6	84 Bell Tree	Bell Tree	Bell Tree	Bell Tree	Bell Tree
	85 Castanets	Castanets	Castanets	Castanets	Castanets
	86 Mute Surdo [EXC6]	Mute Surdo [EXC6]	Mute Surdo [EXC6]	Mute Surdo [EXC6]	Mute Surdo [EXC6]
	87 Open Surdo [EXC6]	Open Surdo [EXC6]	Open Surdo [EXC6]	Open Surdo [EXC6]	Open Surdo [EXC6]
	88 -----	-----	Applause	-----	-----

Pianist Style List

Style Name

Piano Pop

Piano Classic 1

Piano Waltz

Piano Night

Gospel Piano

Piano Jazz

Pf Concerto

Stride Piano

Piano Slow

Piano Classic 2

Piano Ragtime

Piano Shuffle

Piano Latin

Piano Boogie

Classic Polka

Piano Ballad

P. Pop

P. Slow Waltz

P. Country

P. Bossa Nova

P. Stride

P. Concerto1

P. Ballad 1

P. Ballad 2

P. Swing Pop

P. Rock'n Roll

P. Concerto 2

P. Swing

P. Slow Swing













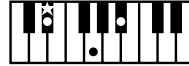

























































P. Slow Rock

P. 50's Rock

Chord List

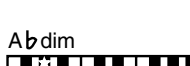
* ● symbol : Indicates the constituent note of chords.

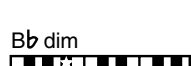
* ★ symbol : Chord shown with an "★" can be played by pressing just the key marked with the "★" (p. 28).

C 	C# 	D 	E^b 	E 	F 
CM7 	C#M7 	DM7 	E^bM7 	EM7 	FM7 
C7 	C#7 	D7 	E^b7 	E7 	F7 
Cm 	C#m 	Dm 	E^bm 	Em 	Fm 
Cm7 	C#m7 	Dm7 	E^bm7 	Em7 	Fm7 
Cdim 	C#dim 	Ddim 	E^bdim 	Edim 	Fdim 
F# 	G 	A^b 	A 	B^b 	B 
F#M7 	GM7 	A^bM7 	AM7 	B^bM7 	BM7 
F#7 	G7 	A^b7 	A7 	B^b7 	B7 
F#m 	Gm 	A^bm 	Am 	B^bm 	Bm 
F#m7 	Gm7 	A^bm7 	Am7 	B^bm7 	Bm7 
F#dim 	Gdim 	A^bdim 	Adim 	B^bdim 	Bdim 

Internal Song List

* All rights reserved. Unauthorized use of this material for purposes other than private, personal enjoyment is a violation of applicable laws.

Burgmüller	
Openness	©1999 Roland Corporation
Arabesque	©1999 Roland Corporation
Pastoral	©1999 Roland Corporation
SmallGathering	©1999 Roland Corporation
Innocence	©1999 Roland Corporation
Progress	©1999 Roland Corporation
Clear Stream	©1999 Roland Corporation
Gracefulness	©1999 Roland Corporation
The Hunt	©1999 Roland Corporation
TenderFlower	©1999 Roland Corporation
Shepherdess	©1999 Roland Corporation
Farewell	©1999 Roland Corporation
Consolation	©1999 Roland Corporation
AustrianDance	©1999 Roland Corporation
Ballad	©1999 Roland Corporation
Sighing	©1999 Roland Corporation
Chatterbox	©1999 Roland Corporation
Restlessness	©1999 Roland Corporation
Ave Maria	©1999 Roland Corporation
Tarantella	©1999 Roland Corporation
AngelHarmony	©1999 Roland Corporation
Gondola Song	©1999 Roland Corporation
The Return	©1999 Roland Corporation
The Swallow	©1999 Roland Corporation
KnightErrant	©1999 Roland Corporation

Invention	
Invention 1	©2000 Roland Corporation
Invention 2	©2000 Roland Corporation
Invention 3	©2000 Roland Corporation
Invention 4	©2000 Roland Corporation
Invention 5	©2000 Roland Corporation
Invention 6	©2000 Roland Corporation
Invention 7	©2000 Roland Corporation
Invention 8	©2000 Roland Corporation
Invention 9	©2000 Roland Corporation
Invention 10	©2000 Roland Corporation
Invention 11	©2000 Roland Corporation
Invention 12	©2000 Roland Corporation
Invention 13	©2000 Roland Corporation
Invention 14	©2000 Roland Corporation
Invention 15	©2000 Roland Corporation

Practice	
Beyer 15	©1996 Roland Corporation
Beyer 21	©1996 Roland Corporation
Beyer 25	©1996 Roland Corporation
Beyer 29	©1996 Roland Corporation
Beyer 34	©1996 Roland Corporation
Beyer 38	©1996 Roland Corporation
Beyer 42	©1996 Roland Corporation
Beyer 46	©1996 Roland Corporation
Beyer 51	©1996 Roland Corporation
Beyer 55	©1996 Roland Corporation
Beyer 60	©1996 Roland Corporation
Beyer 64	©1996 Roland Corporation
Beyer 67	©1996 Roland Corporation
Beyer 73	©1996 Roland Corporation
Beyer 78	©1996 Roland Corporation
Beyer 81	©1996 Roland Corporation
Beyer 90	©1996 Roland Corporation
Beyer 93	©1996 Roland Corporation
Beyer 98	©1996 Roland Corporation
Beyer 103	©1996 Roland Corporation
Czerny100- 1	©1995 Roland Corporation
Czerny100-10	©1995 Roland Corporation
Czerny100-20	©1995 Roland Corporation
Czerny100-30	©1995 Roland Corporation
Czerny100-38	©1995 Roland Corporation
Czerny100-43	©1995 Roland Corporation
Czerny100-60	©1995 Roland Corporation
Czerny100-75	©1995 Roland Corporation
Czerny100-86	©1995 Roland Corporation
Czerny100-96	©1995 Roland Corporation
OldMacDonald	©1999 Roland Corporation
HoneybeeMarch	©1999 Roland Corporation
Twinkle	©1999 Roland Corporation
Frog Song	©1999 Roland Corporation
Little Fox	©1999 Roland Corporation
Jingle Bell	©1999 Roland Corporation
The Cuckoo	©1999 Roland Corporation
Mary Lamb	©1999 Roland Corporation
LondonBridge	©1999 Roland Corporation
Little Row	©2001 Roland Corporation

Masterpieces	
→ Song files of this genre corresponds to the included collection of printed music entitled "Roland 60 Classical Piano Masterpieces."	
Sonata 545-1	©1996 Roland Corporation
Liebestraume 3	©2001 Roland Corporation
Etude Op10-3	©2001 Roland Corporation
Je Te Veux	©1997 Roland Corporation
Petit chien	©2001 Roland Corporation
Golliwog's Cakewalk	©1995 Roland Corporation
Fantasia-Impromptu	©2001 Roland Corporation
Arabesque 1	©1995 Roland Corporation
Blue Danube	©1996 Roland Corporation
Auf Flugeln des Gesanges	©1996 Roland Corporation
MazurkaOp7-1	©1995 Roland Corporation
Gymnopedie 1	©1997 Roland Corporation
Etude Op25-1	©1995 Roland Corporation
ClairDeLune	©1998 Roland Corporation
Etude Op10-5	©2001 Roland Corporation
Dr.Gradusad Parnassum	©1995 Roland Corporation
GrandeValseOp18	©1995 Roland Corporation
MaidenPrayer	©1996 Roland Corporation
Troika-Fahrt	©1996 Roland Corporation
ToThe Spring	©1996 Roland Corporation
Valse Op64-2	©1996 Roland Corporation
RadetzkyMarch	©1996 Roland Corporation
Traumerei	©1996 Roland Corporation
Moment Musical	©1996 Roland Corporation
Raindrop	©1996 Roland Corporation
Harmonious Blacksmith	©1996 Roland Corporation
HungarianDance5	©1996 Roland Corporation
Alla Turca	©1996 Roland Corporation
Nocturne 9-2	©1996 Roland Corporation
Fruhlingslied	©1996 Roland Corporation
Prelude 1-1	©1996 Roland Corporation
Jagerlied	©1996 Roland Corporation
MenuetAntique	©1996 Roland Corporation
Fur Elise	©1996 Roland Corporation
TurkishMarch	©1996 Roland Corporation
Standchen	©1996 Roland Corporation

Humoresque	©1996 Roland Corporation
Blumenlied	©1996 Roland Corporation
Alpenglockchen	©1996 Roland Corporation
Minuet in G	©1996 Roland Corporation
Gondola Song	©1996 Roland Corporation
Alpine Glow	©1996 Roland Corporation
AdieuToPiano	©1996 Roland Corporation
Bridal March Wagner	©1996 Roland Corporation
Waterloo	©1996 Roland Corporation
Winner March	©1996 Roland Corporation
Le Coucou	©1996 Roland Corporation
Menuet in G	©1992 Roland Corporation
Spinnerlied	©1996 Roland Corporation
Gavotte	©1996 Roland Corporation
Heather Rose	©1996 Roland Corporation
Gypsy Dance	©1996 Roland Corporation
Cinquantaine	©1996 Roland Corporation
Csikos Post	©1996 Roland Corporation
Dolly's Dreaming and awakening	©1996 Roland Corporation
La Violette	©1996 Roland Corporation
Merry Farmer	©1996 Roland Corporation
Clementi 1-1	©1996 Roland Corporation
Kuhlau 1-1	©1996 Roland Corporation
Beethoven5-1	©1996 Roland Corporation

Popular	
Annie Laurie	©1993 Roland Corporation
Amapola	©1993 Roland Corporation
Amazing Grace	©1993 Roland Corporation
Stagecoach	©1994 Roland Corporation
Entertainer	©1994 Roland Corporation
Clock	©1998 Roland Corporation
Ave Maria	©1993 Roland Corporation
Greensleeves	©1993 Roland Corporation
Jingle Bells	©1998 Roland Corporation
Hallelujah!	©1993 Roland Corporation
Marchin' In	©1992 Roland Corporation
Silent Night, Holy Night	©1998 Roland Corporation
Little Brown Jug	©1998 Roland Corporation
Londonderry Air	©1993 Roland Corporation
Les patineurs, Valse	©1998 Roland Corporation
Sun Daze	©1992 Roland Corporation
Keepers Tale	©1992 Roland Corporation
Secret Agent	©1992 Roland Corporation
KismetSalsa	©1996 Roland Corporation
RollOverLudwig	©1996 Roland Corporation
A PreludeTo:	©1996 Roland Corporation
CountOnBlues	©1992 Roland Corporation
OneDown&Easy	©1994 Roland Corporation
BachsBoppin'	©1996 Roland Corporation
Matthew	©1998 Roland Corporation
HungarianRag	©1996 Roland Corporation
Paganooogie	©1998 Roland Corporation
Fly Free	©1992 Roland Corporation

Music Files That the HPi-5 Can Use

What Are Music Files?

Music Files contain information describing the details of a musical performance, such as “the C3 key on a keyboard was pressed for this amount of time, using this amount of force.” By inserting the floppy disk into the disk drive on the HPi-5, the performance information is sent from the floppy disk to the piano, and played faithfully by the piano. This is different than a CD, since the music file does not contain a recording of the sound itself. This makes it possible to erase certain parts, or to change instruments, tempos and keys freely, allowing you to use it in many different ways.

Regarding Copyright

Use of the song data supplied with the Data Disk attached to this product for any purpose other than private, personal enjoyment without the permission of the copyright holder is prohibited by law. Additionally, this data must not be copied, nor used in a secondary copyrighted work without the permission of the copyright holder.

■ The HPi-5 allows you to use the following music files

- Floppy disks saved on a Roland MT Series, or Roland Piano Digital HP-G/R and KR Series instrument
 - Roland Digital Piano Compatible Music Files
Roland’s original music file is made specifically for practicing the piano. Some follow an instructional curriculum, allowing for a complete range of lessons, such as “practicing each hand separately” or “listening to only the accompaniment.”
 - SMF Music Files (720KB/1.44MB format)
SMFs (Standard MIDI Files) use a standard format for music file that was formulated so that files containing music file could be widely compatible, regardless of the manufacturer of the listening device. An enormous variety of music is available, whether it be for listening, for practicing musical instruments, for Karaoke, etc.
- * If you wish to purchase SMF Music Files, please consult the retailer where you purchased your HPi-5.

SMF with Lyrics

“SMF with Lyrics” refers to SMF (Standard MIDI File) that contains the lyrics. When Music Files carrying the “SMF with Lyrics” logo are played back on a compatible device (one bearing the same logo), the lyrics will appear in its display.

■ About the HPi-5 Sound Generator

The HPi-5 come equipped with GM 2/GS sound generators.

General MIDI

The General MIDI is a set of recommendations which seeks to provide a way to go beyond the limitations of proprietary designs, and standardize the MIDI capabilities of sound generating devices. Sound generating devices and music files that meets the General MIDI standard bears the General MIDI logo. Music files bearing the General MIDI logo can be played back using any General MIDI sound generating unit to produce essentially the same musical performance.

General MIDI 2

The upwardly compatible General MIDI 2 recommendations pick up where the original General MIDI left off, offering enhanced expressive capabilities, and even greater compatibility. Issues that were not covered by the original General MIDI recommendations, such as how sounds are to be edited, and how effects should be handled, have now been precisely defined. Moreover, the available sounds have been expanded. General MIDI 2 compliant sound generators are capable of reliably playing back music files that carry either the General MIDI or General MIDI 2 logo. In some cases, the conventional form of General MIDI, which does not include the new enhancements, is referred to as “General MIDI 1” as a way of distinguishing it from General MIDI 2.

GS Format

The GS Format is Roland’s set of specifications for standardizing the performance of sound generating devices. In addition to including support for everything defined by the General MIDI, the highly compatible GS Format additionally offers an expanded number of sounds, provides for the editing of sounds, and spells out many details for a wide range of extra features, including effects such as reverb and chorus. Designed with the future in mind, the GS Format can readily include new sounds and support new hardware features when they arrive. Since it is upwardly compatible with the General MIDI, Roland’s GS Format is capable of reliably playing back GM Scores equally as well as it performs GS music files (music files that have been created with the GS Format in mind). This product supports both the General MIDI 2 and the GS Format, and can be used to play back music data carrying either of these logos.

XG lite

XG is a tone generator format of YAMAHA Corporation, that defines the ways in which voices are expanded or edited and the structure and type of effects, in addition to the General MIDI 1 specification. XGlite is a simplified version of XG tone generation format. You can play back any XG music files using an XGlite tone generator. However, keep in mind that some music files may play back differently compared to the original files, due to the reduced set of control parameters and effects.

MIDI Implementation Chart

DIGITAL PIANO

Date : Sep. 1, 2001

Model HPi-5

MIDI Implementation Chart

Version : 1.00

Function...	Transmitted	Recognized	Remarks
Basic Channel Default Changed	1 1-16	1-16 1-16	
Mode Default Messages Altered	Mode 3 x *****	Mode 3 Mode 3, 4(M=1)	* 2
Note Number : True Voice	15-113 *****	0-127 0-127	
Velocity Note ON Note OFF	O x 8n v=64	O x	
After Touch Key's Ch's	x x	O *1 O *1	
Pitch Bend	O	O	
Control Change 0, 32 1 5 6, 38 7 10 11 64 65 66 67 84 91 93 98, 99 100, 101	O O *3 O *3 O *3 O O *3 O O *3 O O O *3 O O O O O O *3 O *3	O *1 O *1 O *1 O *1 O *1 O *1 O *1 O *1 O O O *1 O *1 O *1 O (Reverb) O (Chorus) O O *1 O *1	Bank select Modulation Portamento time Data entry Volume Panpot Expression Hold 1 Portamento Sostenuto Soft Portamento control Effect1 depth Effect3 depth NRPN LSB, MSB RPN LSB, MSB
Prog Change : True #	O 0-127 *****	O 0-127	Program number 1-128
System Exclusive	O	O	
System Common : Song Pos : Song Sel : Tune	x x x	x x x	
System Real Time : Clock : Commands	O x	x x	
Aux Message : All sound off : Reset all controllers : Local Control : All Notes OFF : Active Sense : Reset	x x x x O x	O (120, 126, 127) O O O (123-125) O O x	
Notes	* 1 O x is selectable by Sys Ex. * 2 Recognized as M=1 even if M≠1. * 3 O x is selectable by Composer Out setting (P. 48).		

Mode 1 : OMNI ON, POLY

Mode 2 : OMNI ON, MONO

O : Yes

Mode 3 : OMNI OFF, POLY

Mode 4 : OMNI OFF, MONO

X : No

Main Specifications

<Keyboard>	
Keyboard	88 keys (Progressive Hammer Action Keyboard)
Touch Sensitivity	Light, Medium, Heavy, Fixed
Keyboard Mode	Whole, Split (adjustable split point), Dual, Pianist, Manual Drums/SFX
<Sound Source> Conforms to GM2/GS	
Maximum Polyphony	64 Voices
Tones	6 groups 421 variations, (including 11 drum sets, 1 SFX set)
Temperament	8 types, selectable tonic
Stretched Tuning	2 types
Master Tuning	415.3 Hz-466.2 Hz (0.1Hz Steps)
Transpose	Key Transpose (-6+5 Half-steps), Playback Transpose (-24+24 Half-steps)
Effects	Reverb (10 levels), Chorus (10 levels), Sympathetic Resonance (10 levels, for some Piano tones only)
<Arranger>	
Pianist Styles	30
Control	Start/Stop, Intro/Ending
<Composer>	
Metronome	Beat: 2/2, 0/4, 2/4, 3/4, 4/4, 5/4, 6/4, 7/4, 3/8, 6/8, 9/8, 12/8
	Volume: 10 levels
	Pattern: 11 types
	Sounds: 7 types
Tracks	5 tracks, 16 tracks
Song	1 song
Note Storage	Approx. 30,000 notes
Tempo	Quarter note = 20 to 250
Resolution	120 ticks per quarter note
Control	Reset, Stop, Play, Rec, Bwd, Fwd, Track Select
<Disk Drive/Disk Storage> 3.5 inch Micro Floppy Disk Drive	
Disk Format	720 K bytes (2DD) / 1.44 M bytes (2HD)
Songs	Max. 99 songs
Note Storage	Approx. 120,000 notes (2DD), Approx. 240,000 notes (2HD)
Playable Software	Standard MIDI Files (Format 0/1), Roland Original Format (i-format)
Save	Standard MIDI Files (Format 0), Roland Original Format (i-format)
<Others>	
Internal Songs	168 songs
Rated Power Output	30 W x 2
Speakers	16 cm x 2
Display	320 x 240 dots Graphic LCD (with backlit)
Language	English/Japanese/German/French/Spanish
Lyric	Yes (Built-in Display, MIDI Out)
Control	Volume, Brilliance
Pedals	Damper (half-pedal recognition), Soft (half-pedal recognition, function assignable), Sostenuato (function assignable)
Other Function	Panel Lock
Connectors	Output jacks (L/Mono, R), Input jacks (L/Mono, R), Headphone jack (Stereo) x 2, MIDI In connector x 2, MIDI Out connector, Pedal connector (8-pin DIN type), LCD connector (13-pin DIN type)
Power Supply	AC 117 V / AC 230 V / AC 240 V
Power Consumption	82 W (117 V) / 80 W (230 V) / 80 W (240 V)
Dimensions (Including the piano stand)	1445(W) x 524 (D) x 872 (H) mm / 56-15/16 (W) x 20-11/16 (D) x 34-3/8 (H) inches Including the music stand: 1445(W) x 524 (D) x 1067 (H) mm / 56-15/16 (W) x 20-11/16 (D) x 42-1/16 (H) inches
Weights (Including the stand)	67 kg / 147 lbs 12 oz
Accessories	Owner's Manual, Power Cord, Roland 60 Classical Piano Masterpieces

* In the interest of product improvement, the specifications and/or appearance of this unit are subject to change without prior notice.

Index

Numerics

0: New Song	32
16 Track	44
Mute	44
Solo	44

A

AC inlet	9
Accompaniment	28
Adjuster	11
All song play	18
All Songs in Random	18
Audio device	46

B

Balance	43
Bank Select LSB	48
Bank Select MSB	48
Basic operation	14
Beat	
Metronome	19
[Brilliance] knob	10

C

Center Pedal	45
Chord	28
Chord List	57
Chorus	25
Adjusting the depth	43
[Chorus] button	25
Clef L	41
Clef R	41
Composer Out	48
Computer	47
Connecting	46
[Contrast] knob	10
Count	20
Count Options	42
Count	42
Count In Measure	42
Count In Repeat	42
Count In Sound	42
Countdown Sound	42
Countdown Track	42
Countdown	20
Count-in	20

D

Damper pedal	11
Delete	
A recorded song	34
A song from floppy disk	39
Demo	18
Disk drive	36
Display	
Brightness	10
Language	45
Display [On/Off] button	10
Drum set	24
Drum Set List	54

DRUMS (Wonderland)	29
Dual	25
Dual Balance	25
Dual/Split	27

E

Effects	24
Adjusting the depth	43
Error Message	51

F

Factory Reset	45
Fingering	15
Floppy disk	36
Format	36
[Function] Button	43

G

GAME (Wonderland)	29
General MIDI	60
General MIDI 2	60
GS	60
GS Format	60

H

Headphones	9
------------------	---

I

i-format	37
Internal Song List	58
[Intro/Ending] button	28

K

Key (Score Option)	41
Key (Tuning)	44
Key Touch	23
[Key Touch] button	23

L

Language	45
LCD Out connector	9
Left Pedal	45
Left-hand Tone	26
Lid	9
Local Control	48
Lower Damper	45
Lyrics	15

M

Marker	20
Assign a marker	21
Deleting a marker	22
Moving an marker	21
Moving to the location of an marker	21
Playing repeatedly	21
Memory Backup	45
Metronome	19
Beat	19
Pattern	19
Sound	19
Volume	19
[Metronome] button	19

Index

MIDI	46
MIDI Device	46
MIDI settings	47
Music stand	9
Mute (16 Track)	44
Muting	
Track button	17
P	
Panel Lock	11
Part	15
Part (Score Option)	41
Pedal	11, 45
Pedal cable	9
Pedal connector	9
Percussion	24
Phones jack	9
[Pianist] button	28
Pianist Function	28, 34
Pianist Style List	56
Pitches	41
[Play] button	17
Playing	
At a fixed tempo (Tempo mute)	18
Internal song	16
Internal songs consecutively (All Song Play)	18
Music files or songs on Floppy Disk	40
Repeatedly	21
Power	10
Power cable	9
[Power] switch	10
Program Change	48
Protect tab	36
R	
[Rec] button	30
Record over selected song	30
Recording	30
A New Song	31
Along with a song	30
Multitrack	35
Re-recording	33
With an accompaniment	34
Refernece pitch	44
Repeat	21
[Reset] button	17
Resolution (Marker Option)	43
Reverb	25
Adjusting the depth	43
[Reverb] button	25
Right-hand Tone	26
S	
Save	37
Save Destination	38
Saving on a floppy disk	36
Score Screen	
Option	41
Score screen	15
SFX	24
SFX (Wonderland)	29
SFX Set	53
SMF	37, 60
SMF Music files	60
Soft pedal	11
Solo (16 Track)	44
[Song] button	17
SONGS (Wonderland)	29
Sostenuto pedal	11
Sound Generato	60
Split	26
Split point	26
[Start/Stop] button	28
[Stop] button	17
Stretch Tuning	44
Style	28
Sympathetic Resonance	
Adjusting the depth	43
T	
Tap Tempo	45
Temperament	44
Tempo	17
Tempo [Slow][Fast] buttons	17
Tempo Mute	18
Tone	24
Tone 1	25
Tone 2	25
[Tone] button	24
Tone List	52
TONES (Wonderland)	29
Touch	23
Track Assign	45
Track button	17, 33, 35
Transmit Channel	47
Transpose	22
Keyboard	22
Song	22
[Transpose] button	22
Trouble Shooting	49
Tuning	44
U	
USB	47
V	
Volume	
Metronome	19
Overall	10
Volume balance	43
[Volume] knob	10
W	
Wonderland	29
[Wonderland] button	29
X	
XG lite	60
Z	
Zoom	15

MEMO

For EU Countries



This product complies with the requirements of European Directives EMC 89/336/EEC and LVD 73/23/EEC.

For the USA

FEDERAL COMMUNICATIONS COMMISSION RADIO FREQUENCY INTERFERENCE STATEMENT

This equipment has been tested and found to comply with the limits for a Class B digital device, pursuant to Part 15 of the FCC Rules. These limits are designed to provide reasonable protection against harmful interference in a residential installation. This equipment generates, uses, and can radiate radio frequency energy and, if not installed and used in accordance with the instructions, may cause harmful interference to radio communications. However, there is no guarantee that interference will not occur in a particular installation. If this equipment does cause harmful interference to radio or television reception, which can be determined by turning the equipment off and on, the user is encouraged to try to correct the interference by one or more of the following measures:

- Reorient or relocate the receiving antenna.
- Increase the separation between the equipment and receiver.
- Connect the equipment into an outlet on a circuit different from that to which the receiver is connected.
- Consult the dealer or an experienced radio/TV technician for help.

This device complies with Part 15 of the FCC Rules. Operation is subject to the following two conditions:

- (1) This device may not cause harmful interference, and
- (2) This device must accept any interference received, including interference that may cause undesired operation.

Unauthorized changes or modification to this system can void the users authority to operate this equipment.
This equipment requires shielded interface cables in order to meet FCC class B Limit.

For Canada

NOTICE

This Class B digital apparatus meets all requirements of the Canadian Interference-Causing Equipment Regulations.

AVIS

Cet appareil numérique de la classe B respecte toutes les exigences du Règlement sur le matériel brouilleur du Canada.

Contents		
No.	Name	Qty.
1	HPi-5 Instrument	1
2	HPi-5 Music Rest	1
3	Manual Set	1
4	AC Cord Set	1
5	Collection of Printed Music	1

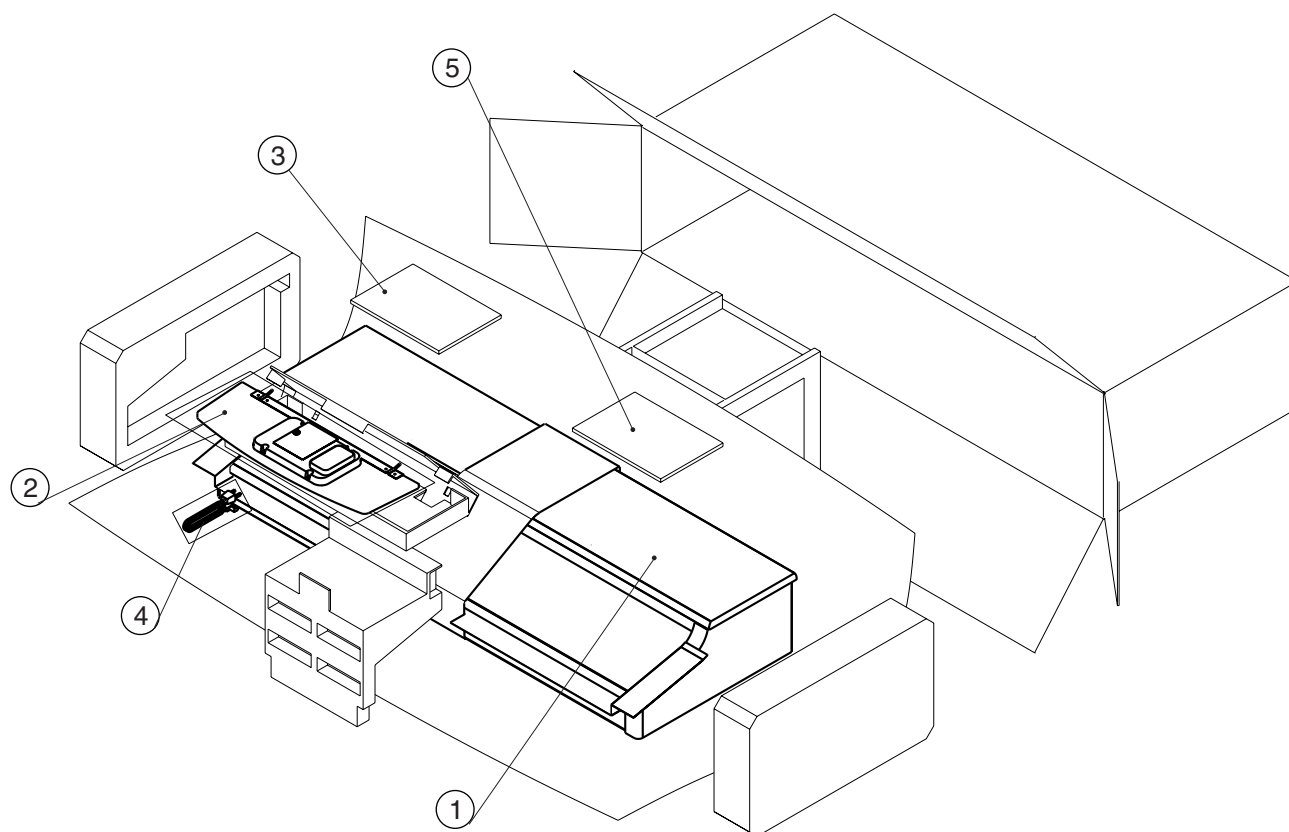

This owner's manual is printed on recycled paper.