

Roland



Roland Digital Piano

HP 530 / 330

Owner's Manual

Thank you, and congratulations on your choice of the Roland HP 530/330. The HP 530/330 features high-quality grand piano sounds and hammer-action keyboard, allowing you to enjoy extremely realistic piano performances. Moreover, it is stocked with many other sounds that can be effectively used for various different types of music. You also can conveniently use it for piano lessons, thanks to its wealth of 23 demonstration songs and a built-in two-track sequencer (which is as handy to use as a tape recorder).

IMPORTANT NOTES.....	3	OTHER USEFUL FUNCTIONS	28
INTRODUCTION	4	Playing in the Tuning of Classical Music	28
Using the Music Rest	4	Adjusting the Pitch of the Sound (Master Tuning)	30
How to Open and Close the Piano Lid	4	Setting the Tuning Curve (Stretch Tuning)	31
Powering Up	4	Changing the Volume Balance for Dual Play	32
Using Headphones(HP-530)	5	Changing the Demo Song/Keyboard Balance.....	33
Using a Microphone.....	5	Changing the Assignment to the Pedals.....	34
Panel Descriptions.....	6	Changing the Amount of Resonance for the Damper Pedal	35
Rear Panel.....	9	USING MIDI.....	36
Connecting to External Devices	9	Connecting with MIDI Devices.....	36
Pedal Functions	10	Setting the MIDI Transmit and Receive Channels.....	36
PLAYING THE HP 530/330.....	11	How to Set the MIDI Transmit and Receive Channel.....	37
Adjusting the Volume and Brightness of the Sound	11	Setting the Local Control.....	37
Listening to the Demonstration Songs		Setting the Transmit Mode	38
(All Song Play)	11	Transmitting and Receiving Program Changes.....	38
Playing with Various Sounds	12	Connecting with a Computer	39
Mixing Two Sounds (Dual Play).....	13	MIDI Implementation Chart	40
Changing the Keyboard Touch	13	TROUBLESHOOTING.....	41
Adding Chorus.....	14	SPECIFICATIONS	41
Adding Reverb	14	Service Information	42
Using Two Different Sounds for Right		DEMO SONG LIST	44
And Left Hands (Split Function).....	15		
Playing Any Song in C Major Key Transpose Function	16		
Playing to the Metronome	18		
PRACTICING ON THE HP-530/330	19		
Listening to a Demo Performance	19		
Practicing Right And Left Hands Separately	21		
Recording	24		

	CAUTION RISK OF ELECTRIC SHOCK DO NOT OPEN	
ATTENTION: RISQUE DE CHOC ELECTRIQUE NE PAS OUVRIIR		
<p>CAUTION: TO REDUCE THE RISK OF ELECTRIC SHOCK, DO NOT REMOVE COVER (OR BACK). NO USER-SERVICEABLE PARTS INSIDE. REFER SERVICING TO QUALIFIED SERVICE PERSONNEL.</p>		



The lightning flash with arrowhead symbol, within an equilateral triangle, is intended to alert the user to the presence of uninsulated "dangerous voltage" within the product's enclosure that may be of sufficient magnitude to constitute a risk of electric shock to persons.



The exclamation point within an equilateral triangle is intended to alert the user to the presence of important operating and maintenance (servicing) instructions in the literature accompanying the product.

INSTRUCTIONS PERTAINING TO A RISK OF FIRE, ELECTRIC SHOCK, OR INJURY TO PERSONS.

IMPORTANT SAFETY INSTRUCTIONS

SAVE THESE INSTRUCTIONS

WARNING - When using electric products, basic precautions should always be followed, including the following:

1. Read all the instructions before using the product.
2. Do not use this product near water — for example, near a bathtub, washbowl, kitchen sink, in a wet basement, or near a swimming pool, or the like.
3. This product should be used only with a cart or stand that is recommended by the manufacturer.
4. This product, either alone or in combination with an amplifier and headphones or speakers, may be capable of producing sound levels that could cause permanent hearing loss. Do not operate for a long period of time at a high volume level or at a level that is uncomfortable. If you experience any hearing loss or ringing in the ears, you should consult an audiologist.
5. The product should be located so that its location or position does not interfere with its proper ventilation.
6. The product should be located away from heat sources such as radiators, heat registers, or other products that produce heat.
7. The product should be connected to a power supply only of the type described in the operating instructions or as marked on the product.
8. The power-supply cord of the product should be unplugged from the outlet when left unused for a long period of time.
9. Care should be taken so that objects do not fall and liquids are not spilled into the enclosure through openings.
10. The product should be serviced by qualified service personnel when:
 - A. The power-supply cord or the plug has been damaged; or
 - B. Objects have fallen, or liquid has been spilled onto the product; or
 - C. The product has been exposed to rain; or
 - D. The product does not appear to operate normally or exhibits a marked change in performance; or
 - E. The product has been dropped, or the enclosure damaged.
11. Do not attempt to service the product beyond that described in the user-maintenance instructions. All other servicing should be referred to qualified service personnel.

For the USA

This product may be equipped with a polarized line plug (one blade wider than the other) . This is a safety feature. If you are unable to insert the plug into the outlet, contact an electrician to replace your obsolete outlet. Do not defeat the safety purpose of the plug.

For Canada

For Polarized Line Plug

CAUTION: TO PREVENT ELECTRIC SHOCK, MATCH WIDE BLADE OF PLUG TO WIDE SLOT, FULLY INSERT.

ATTENTION: POUR ÉVITER LES CHOCs ÉLECTRIQUES, INTRODUIRE LA LAME LA PLUS LARGE DE LA FICHE DANS LA BORNE CORRESPONDANTE DE LA PRISE ET POUSSER JUSQU' AU FOND.

For the U.K.

IMPORTANT: THE WIRES IN THIS MAINS LEAD ARE COLOURED IN ACCORDANCE WITH THE FOLLOWING CODE.

BLUE: NEUTRAL
BROWN: LIVE

As the colours of the wires in the mains lead of this apparatus may not correspond with the coloured markings identifying the terminals in your plug, proceed as follows:
The wire which is coloured BLUE must be connected to the terminal which is marked with the letter N or coloured BLACK.
The wire which is coloured BROWN must be connected to the terminal which is marked with the letter L or coloured RED.
Under no circumstances must either of the above wires be connected to the earth terminal of a three pin plug.

IMPORTANT NOTES

In addition to the items listed under Safety Precautions inside the front cover, please read and observe the following:

Power Supply

Before connecting this unit to other devices, turn off the power to all units; this will help prevent damage or malfunction.

Do not use this unit on the same power circuit with any device that will generate line noise; an electric motor or variable lighting system for example.

Placement

Using the unit near power amplifiers (or other equipment containing large power transformers) may induce hum.

This device may interfere with radio and television reception. Do not use this device in the vicinity of such receivers.

Do not expose the unit to temperature extremes or install it near devices that radiate heat. Direct sunlight in an enclosed vehicle can deform or discolor the unit.

Make sure you always have the instrument placed so it is level and sure to remain stable. Otherwise, if played while tilted, you risk causing damage to the keyboard as a result of the unnatural degree of force that might be applied to certain parts of it.

Maintenance

For everyday cleaning wipe the unit with a soft, dry cloth or one that has been slightly dampened with water. To remove stubborn dirt, use a mild, non-abrasive detergent. Afterwards, be sure to wipe the unit thoroughly with a soft, dry cloth.

Never use benzene, thinners, alcohol or solvents of any kind, to avoid the possibility of discoloration or deformation.

Additional Precautions

Protect the unit from strong impact.

Never strike or apply strong pressure to the display.

Before using the unit in a foreign country, consult with qualified service personnel.

INTRODUCTION

Using the Music Rest

Gently lift the music rest and fix it in place as shown below.

To lower it, hold the music rest with your hand, fold the metal latches with another hand, then slowly lower it.

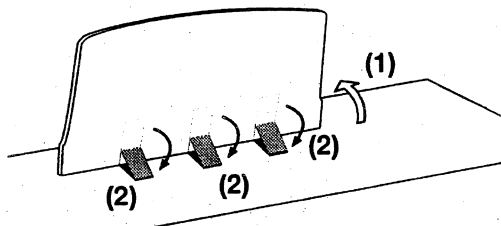

How to Open and Close the Piano Lid

To open the lid, hold the lid with both hands and lift it slightly, then slide it in.

To close it, pull it slowly forward, then gently lower it.

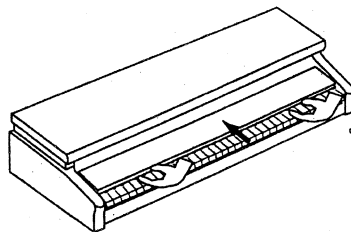

- * Be careful that your fingers do not get caught under the lid when opening or closing it. Adult supervision is recommended in households with small children.
- * If you need to move the piano, make sure the lid is closed first to prevent accidents.

Powering Up

1. Connect the power cord to the piano, and plug the other end to the power outlet.

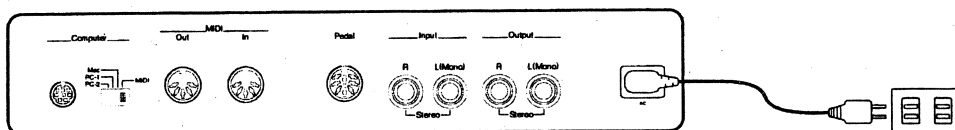

2. Press the Power button, located at the far left of the keyboard.



- * The piano requires several seconds after being switched on before it is ready for operation. This is a circuitry protection feature.
- * Be sure to use the supplied power cord.
- * If you do not use the piano for a long period of time, disconnect the power cord from the socket.

Using Headphones

The HP 530/330 provides two headphones jacks, thus allowing two persons to use headphones at the same time. This is useful when giving piano lessons, or playing a piece for four hands.

The Headphones jack is located beneath the keyboard, at the far left. Connecting headphones will automatically mute the sound from the internal speakers. As a result, you can play the piano without worrying about the neighbors.

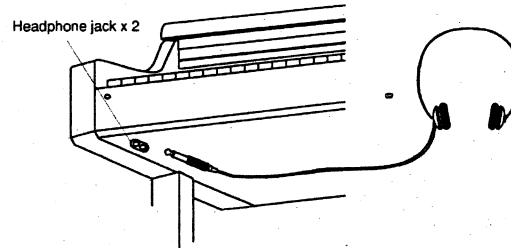

To adjust the volume of the headphones, use the Volume slider on the piano.
Please use stereo headphones, such as Roland RH-20/80/120 stereo headphones.

Using a Microphone

The HP 530 provides for the connection and use of a microphone. This convenient feature allows you to, for example, talk during a presentation, or have someone sing while you play.

* The HP 330 does not feature a Mic jack.

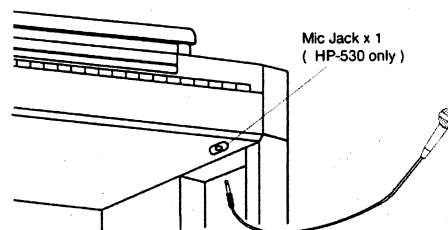

The Mic jack is located beneath the keyboard, at the far right. Connect a microphone to it, then you can hear the sound from the internal speakers. With headphones connected to the Headphones jack, the sound will be heard only through the headphones, and no sound is heard from the speakers.

To adjust the volume of the microphone, use the Microphone Volume knob.

To adjust the depth of the Echo effect, use the Microphone Echo knob.

* Be sure that the volume is not too loud for the neighbors.

* You can use a microphone that an optionally available Roland DR-15/25 microphone. When you purchase a new microphone for the HP 530, please consult the retailer shop where you have purchased the HP 530.

Notes on Using a Microphone

Before you connect the microphone to the piano, be sure to lower the volume. If the volume is too high, noise may be heard from the speakers. If the microphone is pointed toward the speakers, or is too close to them, howling may occur. Should this happen, change the position of the microphone or lower the volume.

INTRODUCTION

Panel Descriptions

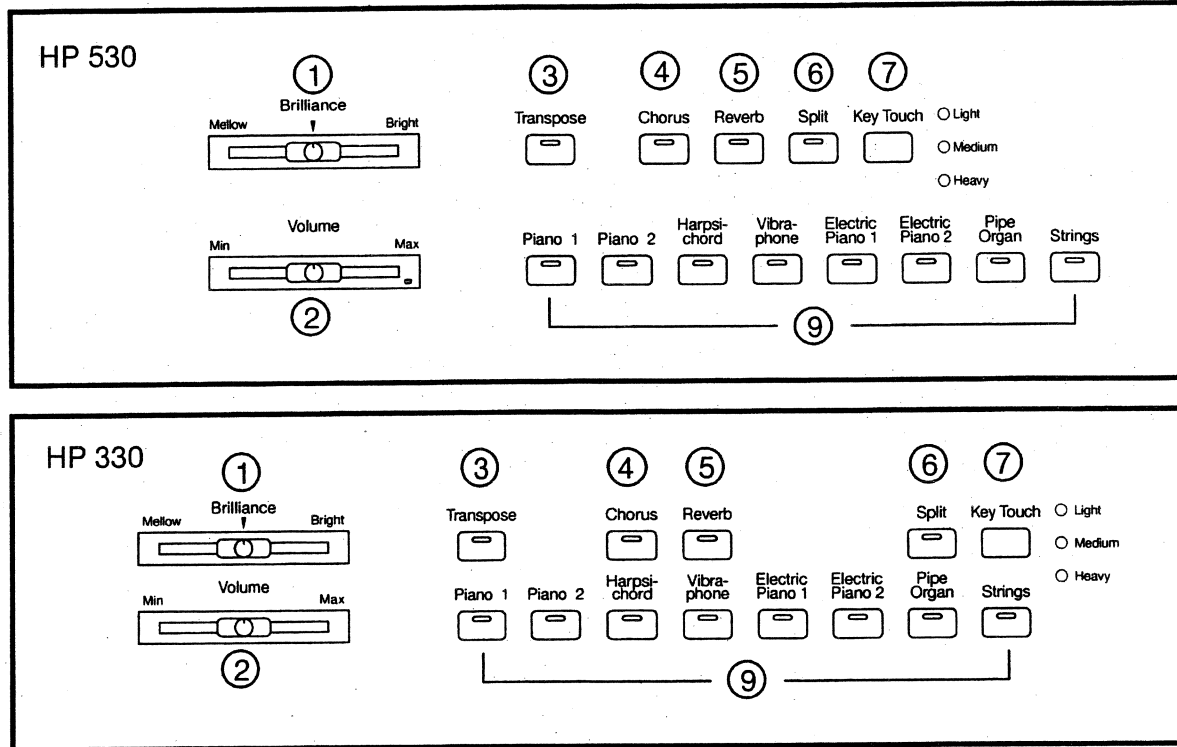

1. Brilliance Slider
Adjusts the brightness of the sound. (p.11)
2. Volume Slider
Adjusts the volume of the sound. (p. 11)
3. Transpose Button
Allows you to transpose keys and play with the set key. (p. 16,17)
4. Chorus Button
Turns on the Chorus effect. (p. 14)
5. Reverb Button
Turns on the Reverb effect. (p. 14)
6. Split Button
Allows you to divide the keyboard into two sections. (p. 15)
7. Key touch Button
Provides selection of three levels for the keyboard touch. (p. 13)

8. Display
This shows the Song Number, value of settings, etc.
9. Tone Buttons
Press one of these to select from the 8 different sounds. (p. 12)
Pianos 1 and 2
Harpsichord
Vibraphone
Electric Pianos 1 and 2
Pipe Organ
Strings
10. Metronome Button
This turns on the metronome. (p.18, 23)

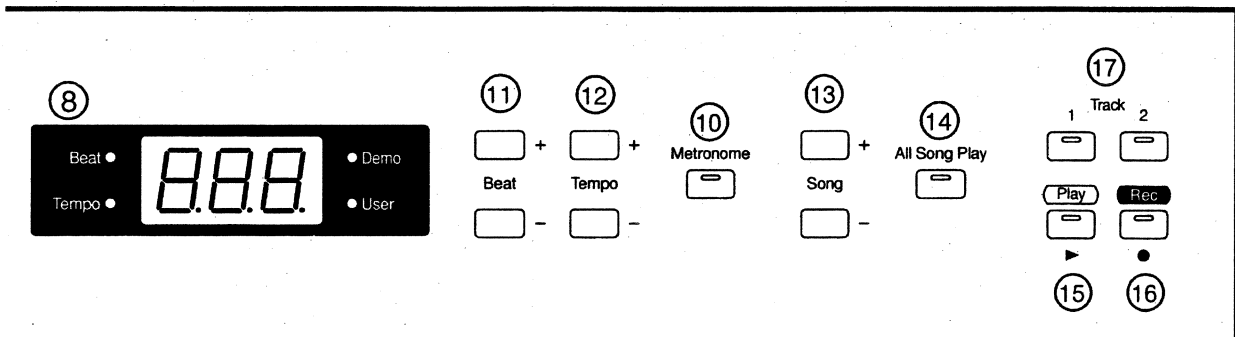
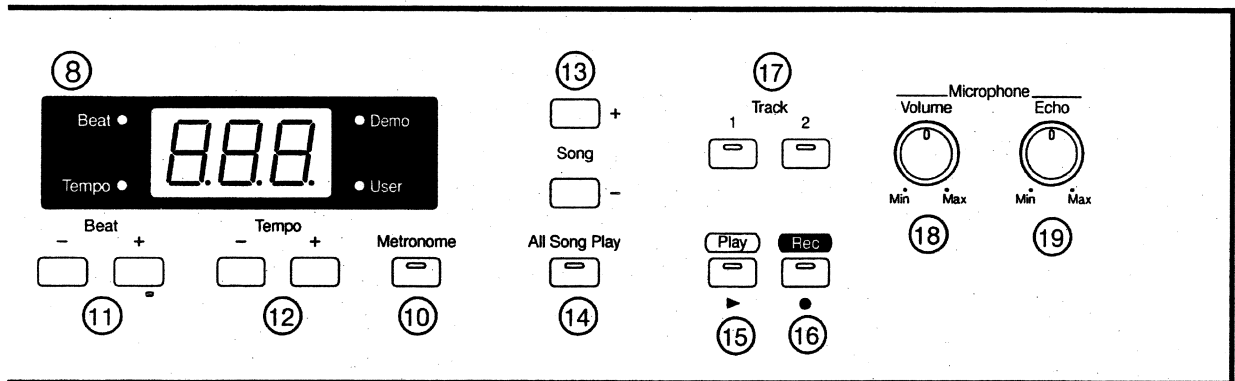

- 11. Beat [+/-] Buttons
Allow you to adjust the timing of the metronome. (p. 18)
- 12. Tempo [+/-] Buttons
Allow you to adjust the timing of demo songs and the metronome. (p. 18,20)
- 13. Song [+/-] Buttons
Allow you to select a demo song. (p.19)
- 14. All Song Play Button
Pressed to play the demo songs as a continuing series. (p. 11)
- 15. Play Button
Press to play demo songs, or music you have recorded. (p. 19,25)
- 16. Rec (Recording) Button
Press to record what you play on the piano. (p. 24,26)

- 17. Track Buttons
Allow you to select a track for recording performance data. (p. 26)
- 18. Microphone Volume Knob (HP 530 only)
Adjusts the volume produced by the microphone. (p. 5)
- 19. Microphone Echo Knob (HP 530 only)
Adjusts the amount of echo to apply to the microphone's signal. (p. 5)

Alternate Button Functions

Each button also offers another function if you hold down the Transpose button while you press it. These alternate functions are explained below.

After the desired value for one of these functions has been set using the [+/-] buttons, press the Transpose button (the indicator goes out). This causes the new setting to be activated.

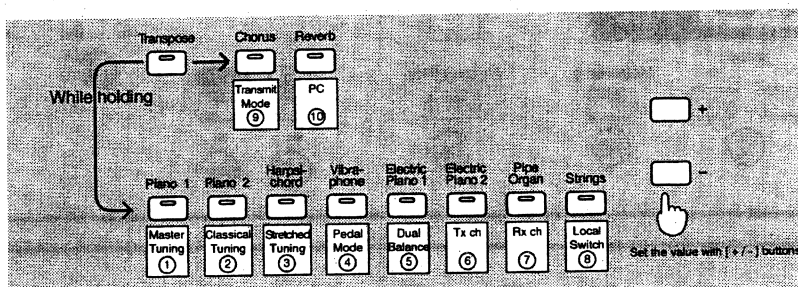

1. Piano 1 Button (Master Tuning)
Allows you to adjust the tuning. (p. 30)
2. Piano 2 Button (Classical Tuning)
Allows you to set the tuning method. (p. 28,29)
3. Harpsichord Button (Stretch Tuning)
Allows you to set the tuning curve. (p. 31)
4. Vibraphone Button (Pedal Mode)
Allows you to select Pedal modes. (p. 34)
5. Electric Piano 1 Button (Dual Balance)
Allows you to adjust the volume balance for Dual playing. (p.32)
6. Electric Piano 2 Button (Tx ch)
Allows you to set the MIDI transmit channel. (p. 36)
7. Pipe Organ Button (Rx ch)
Allows you to set the MIDI receive channel. (p. 37)
8. Strings Button (Local Switch)
Allows you to select Local On or Off.(p. 37)
9. Chorus Button (Transmit Mode)
Allows you to select the MIDI transmit mode. (p. 38)
10. Receive Button (PC)
Used to enable transmission/reception of Program Change messages. (p. 38)

About the [+/-] Buttons

Basically, any of the [+/-] buttons can be used to select values for most of the parameters. However, the beat can be set only with the Beat

[+/-] buttons, the Tempo can be set only with the Tempo [+/-] buttons, and Demo Song settings can be altered only with the Song [+/-] buttons.

Rear Panel

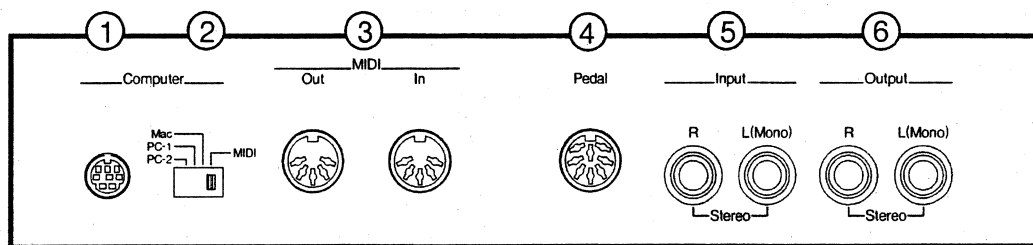

The jacks/connectors on the rear of the unit function as follows:

1. Computer Connector

Connect to a computer through this jack, and you can exchange performance information between the computer and the piano. (p. 39)

2. Computer Switch

Switch for selecting the correct configuration when connecting with the MIDI or Computer connectors. (p. 36,39)

3. MIDI Connectors

Connect a MIDI device to these jacks, and you then can exchange performance information between the external MIDI device and the piano. (p. 36)

4. Pedal Jack

Accepts connection of the cable coming from the Pedal jack on the piano's stand.

5. Input Jacks

Connect a sound generating device to these jacks, and you can hear the sound from that unit through the HP's speakers. (p. 36)

6. Output Jacks

Allow you to output the piano's sound to sound reinforcement equipment to obtain a more powerful sound. Also, by connecting a recording device such as a radio-cassette player, you can record your performances onto cassette tape.

Connecting to External Devices

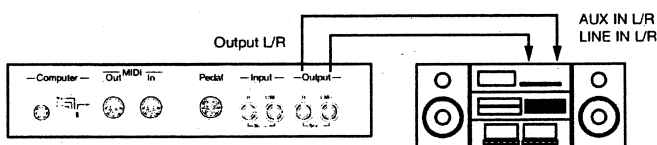

To connect a sound module and hear the sound from the HP's speakers:

Connect the Output jacks on the external sound module (e.g., MT-120) to the Input jacks on the HP using audio cable. For details, read the owner's manual for the sound module you use.

To connect an audio device and record the performance onto a tape recorder:

Connect the Input jacks on the audio set, amplifier or mixer to the Output jacks on the HP using an audio cable.

1. Lower the volume on the HP and the device to be connected.
2. Switch off the HP and the device to be connected.
3. Connect the HP to the device.
4. Switch on the HP and the external device.
5. Adjust the volume of the HP and the external device.

Pedal Functions

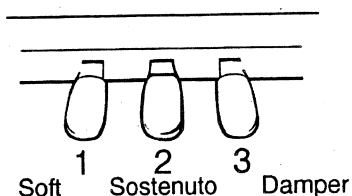

- 1. Soft Pedal**
Use this pedal to soften the sound.
If you play the keyboard while pressing the Soft pedal, the obtained sound will be softer than normal. The softness can be altered subtly by changing the depth the pedal is depressed.
- 2. Sostenuto Pedal**
Pressing this pedal will sustain only the notes that were already playing when the pedal was depressed.
- 3. Damper Pedal**
Use this pedal to sustain the sound.
While pressing the Damper pedal, the sound will be sustained even after you release the key. By changing the depth the pedal is depressed, the length of the sustain can be subtly altered.
 - * The amount of the resonance obtained with the Damper pedal can be changed. See page 35.
 - * The Soft pedal and Sostenuto pedal can also be assigned different functions. See page 34.

PLAYING THE HP 530/330

Adjusting the Volume and Brightness of the Sound

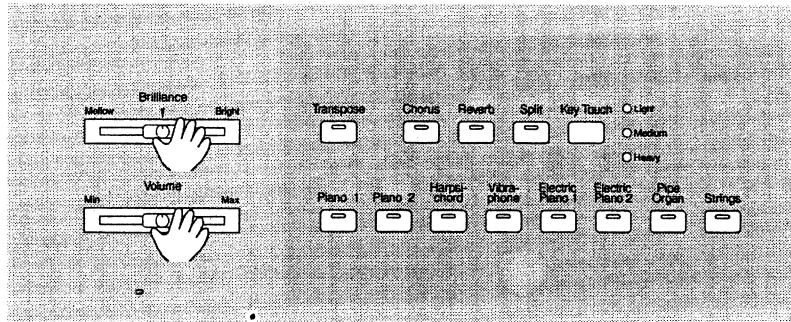

1. Adjust the overall volume using the Volume slider.
At the "Max" position, you obtain the highest volume, and at "Min," it is at the lowest volume.
2. Adjust the overall tone with the Brightness slider.
At the "Bright" position, a bright tone is obtained, while a mellower tone is obtained at "Mellow".

Listening to the Demonstration Songs (All Song Play)

The HP-530/330 contains a great number of demonstration songs. You can listen to them as follows.

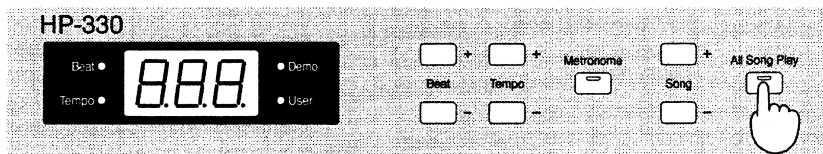
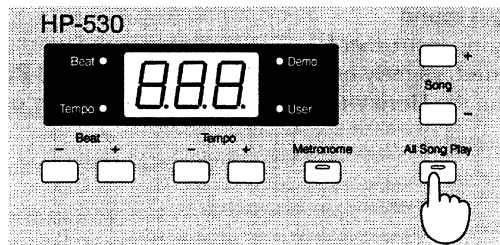

1. Press the All Song Play button
The Demo Songs will start playing from the currently selected one.
2. Press the All Song Play button again (the indicator goes out) to stop play.
While the indicator is lit (the All Song Play button is on), all the Demo Songs will be played repeatedly. This is called "All Song Play".
 - * If you wish to listen to only one specific song, see page 19.
 - * If you wish to know the Song Number, Song Name or Name of the Composer, see the Demo Song List inside the back cover.

Playing with Various Sounds

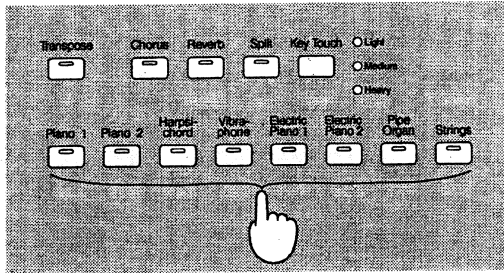

1. Press any Tone button you like.
The indicator on that button will light, and you can play with the selected sound. Play the keyboard to see how each of them sounds.

Tone Name	Description
Piano 1	Full-sized Concert Grand Piano Rich stereo sound, providing 32 polyphonic notes.
Piano 2	Full-sized Concert Grand Piano 64 polyphonic notes
Harpsichord	Delicate and elegant harpsichord sound
Vibraphone	The sound of a resonant vibraphone
Electric Piano 1	Sound of a Rhodes piano
Electric Piano 2	A synthesizer's electric piano
Pipe Organ	A stately pipe organ sound
Strings	An ensemble of string instruments
Honky-tonk piano	Cheerful piano sound, slightly out of tune. Press Piano 1 and Piano 2 at the same time to obtain the Honky-tonk piano sound. (Dual Play on p.13)

Mixing Two Sounds (Dual Play)

The piano allows you to use two sounds from the keyboard at the same time. For example, you can mix Piano with Strings. This is called Dual Play.

Example: Dual Play with Piano 1 and Strings

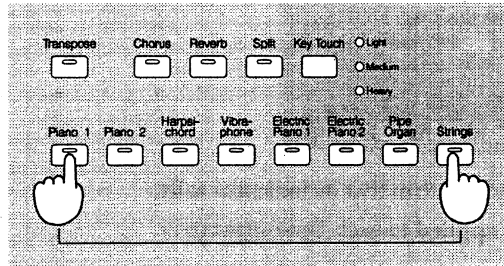

1. Together press both the Strings and the Piano 1 buttons. The indicators on the two Tone buttons you have pressed will light, and both of the Tones will be heard when you play the keyboard.

* You can adjust the volume balance of the two Tones used with Dual Play. See page 32.

Changing the Keyboard Touch

The HP piano allows you to change the sensitivity of the keyboard touch. This is a feature unique to digital pianos, one which you cannot obtain with an acoustic piano.

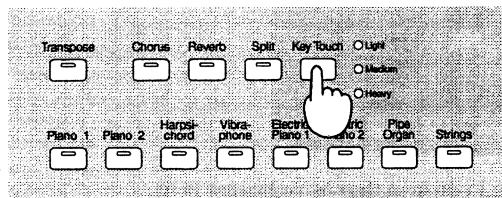

1. Press the Key Touch button to select a key touch you like. Pressing the button allows you to select from the three different Key Touches in order, as follows:
 - Light** : Fortissimo (ff) can be obtained with weaker touch than usual, so, you will feel that the keyboard is lighter. This allows even a small child to play the piano easily.
 - Medium** : This is the most natural touch for the keyboard, and is closest to that of an acoustic piano. This is automatically selected when the piano is switched on.
 - Heavy** : Fortissimo can be obtained only with forceful playing, so you will feel that the keyboard is heavier. When this is selected, you can express feelings even more strongly by playing the piano dynamically. This can be selected by a player with strong finger touch, or one who wishes to strengthen their fingers.

Adding Chorus

The Chorus effect creates an effect that sounds like several instruments are being played at the same time. As a result, the sound will be fatter and have more presence. Seven levels of depth for the Chorus effect are available for selection.

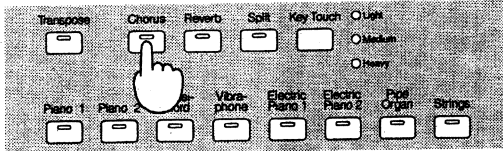

1. Press the Chorus button and confirm that its indicator is lit.
- * The Chorus effect can be applied to each Tone separately.

Changing the Depth of the Chorus

1. Select the depth you like with the [+/-] buttons while holding the Chorus button down. 1 - 7 can be selected for the Chorus Depth.

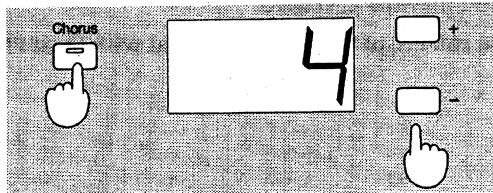

* 4 is automatically selected when the piano is switched on.

Adding Reverb

By using the Reverb Effect, you can obtain pleasant reverberations like those in a concert hall. Seven levels of depth for the Reverb effect are available for selection.

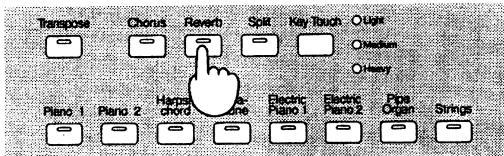

1. Press the Reverb button and confirm that its indicator is lit.
- ### Changing the Depth of the Reverb

1. Select the depth you like with the [+/-] buttons while holding the Reverb button down. 1-7 can be selected for the Reverb Depth.

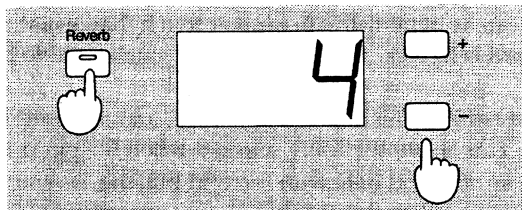

* 4 is automatically selected when the piano is switched on.

Using Two Different Sounds for Right And Left Hands (Split Function)

The piano allows you to divide the keyboard into two sections, upper and lower, and to play two different Tones. Dividing the keyboard is called "Split" and the key where the keyboard is split is called "Split Point".

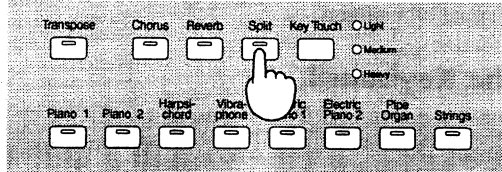

1. Select two Tones by pressing the relevant Tone buttons.
2. Press the Split button, and the keyboard is split. Play the keyboard and hear that two different sounds are played in the upper and lower sections.

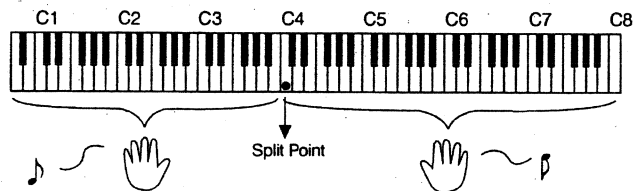

3. Press the Split button to cancel the Split Mode.

Split Tone List

Tone	Upper Tone	Lower Tone
Piano 1	Acoustic Bass	Piano 1
Piano 2	Acoustic Bass	Piano 2
Harpsichord	Strings	Harpsichord
Vibraphone	Acoustic Bass	Vibraphone
Electric Piano 1	Acoustic Bass	Electric Piano 1
Electric Piano 2	Acoustic Bass	Electric Piano 2
Pipe Organ	Pipe Organ	Harpsichord
Strings	Strings	Piano 1

* Chorus cannot be applied to the Tones with Acoustic Bass.

Changing the Split Point

1. Press a key on the keyboard while holding the Split button down.

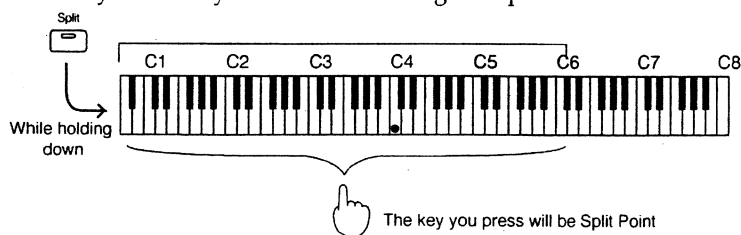

The Split Point can be set from A1 - C6.

The Split Point you set will be retained until the piano is switched off.

- * When the piano is switched on, C4 will be automatically selected.
- * If you split the keyboard during Dual Play, the Tone of the Upper section will be automatically selected and the corresponding Split Tone will be played.

Playing Any Song in C Major (Key Transpose Function)

Using the Key Transpose function, you can transpose the entire keyboard without changing the position of the keys to play. Even a difficult song with many sharps and flats can be changed to a key that is easier for you to play; or you can transpose up or down to accommodate the voice of a singer.

Key-Transposition Using the Keyboard

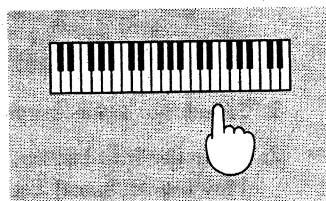
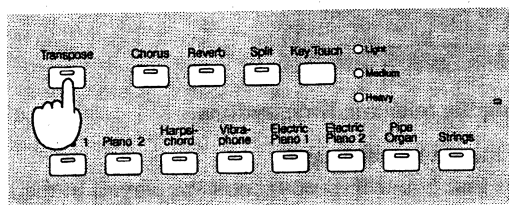

1. While holding the Transpose button down, press the key that corresponds to the main note of the pitch you wish to transpose to. The indicator of the Transpose button is lit and you can play in the transposed key.
 - * The Key you have set will be retained until the piano is switched off. When the indicator is lit the Key Transposition is on. When it is dark, it is in the normal condition without Key Transposition.
 - * When the display shows 0, the indicator for the Transpose button does not light up.

Example: To play an E major music in the key of C major.

1. Press the E key while holding the Transpose button down, so that E will sound by playing C.

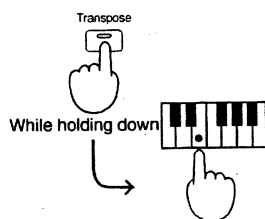
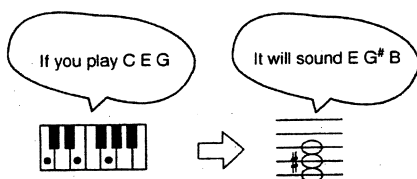

Key Transposition with the [+/-] Button

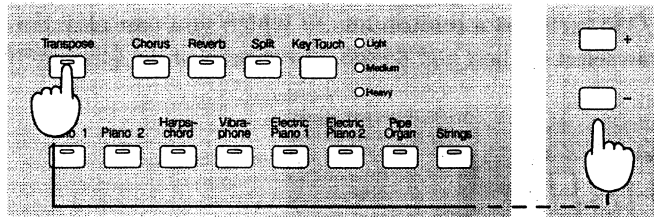

1. Set the amount of the key shift with the [+/-] buttons while holding the Transpose button down.

Each time you press the [+/-] buttons, the key is shifted by one semitone. Pressing both [+/-] buttons simultaneously will set it to C major(C).

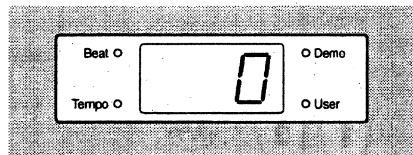

-6 - 0 - 5 can be set for the Key Transposition.

* The Key you have set will be retained until the piano is switched off. When the indicator is lit, Key Transposition is on. When it is dark, it is in the normal condition, without any Key Transposition.

* When the display shows "0," the indicator on the Transpose button does not light up.

Example: To play an E major piece in the key of C major.

If you consider C major as the basic key, there are 4 keys up to "E" that corresponds to the E. So, select 4 in the display.

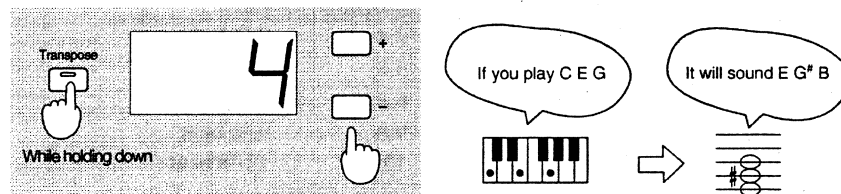

* 0 is automatically selected when the piano is switched on.

* The Key Transpose function applies to only the Tone you are currently playing.

* The Demonstration Songs cannot be transposed.

Playing to the Metronome

The HP 530/330 includes a metronome to which you can play the keyboard. The Metronome can select the beat and tempo. The volume of the Metronome can be set in 7 levels.

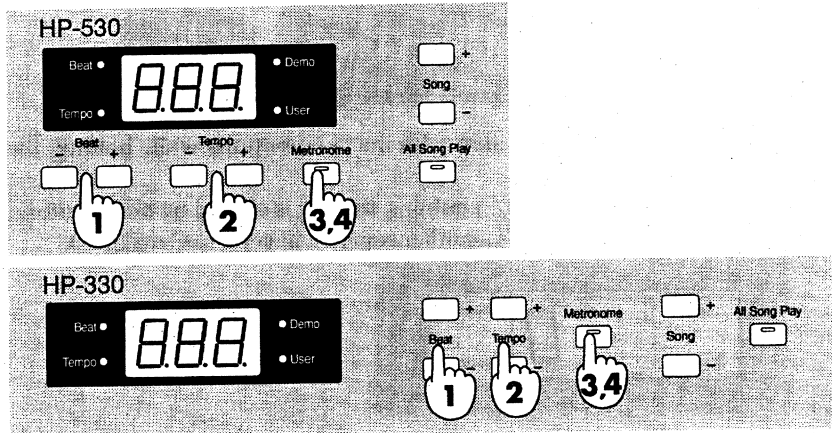

1. Select a desired beat by pressing the Beat [+/-] buttons.
* Pressing two Beat [+/-] buttons simultaneously will set 4/4 beat.



The figures shown in the display represent the beats as follows:

Display	Beat	Display	Beat
0.4	Only upbeat sounds	7.4	7/4 beat
2.4	2/4 beat	3.8	3/8 beat
3.4	3/4 beat	6.8	6/8 beat
4.4	4/4 beat	9.8	9/8 beat
5.4	5/4 beat	12.8	12/8 beat
6.4	6/4 beat		

2. Press the Tempo [+/-] buttons to select the desired tempo.
Tempo can be set from $\text{♩} = 20 - 250$. Check the tempo in the display.

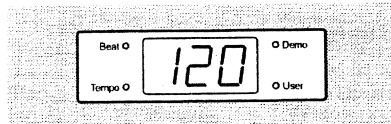

3. Press the Metronome button (the indicator is lit), and the Metronome will play.
4. To stop the Metronome, press the Metronome button again and confirm the indicator goes out.

To change the volume of the Metronome ...

While holding the Metronome button down, set the volume with the [+/-] buttons. The volume of the Metronome can be set in seven levels, 1 - 7.

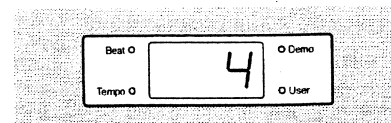

- * 4 is automatically selected when the piano is switched on.

PRACTICING ON THE HP-530/330

Listening to a Demo Performance

Before practicing piano, you must listen to the music thoroughly. The HP piano includes many demonstration songs. Listen to those Demo Songs before actually playing the piano.

Listening to the Demo Performance

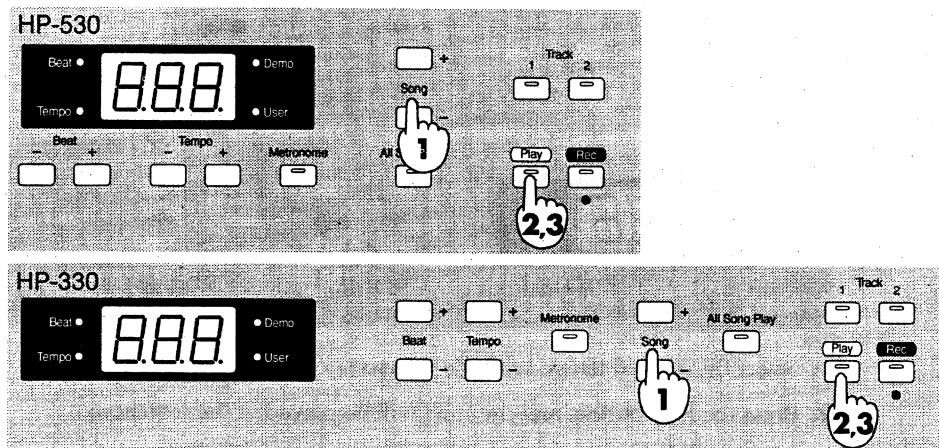

1. Select the Song Number with the Song [+/-] buttons.
2. Press the Play button to play the selected song.
3. Press the Play button again to stop playing.

* The Demo Song List shows the Song Names and Song Numbers.(see back cover)

Changing the Tempo of the Song

The HP piano allows you to change the tempo of the song. Changing the tempo, however, does not affect the pitch.

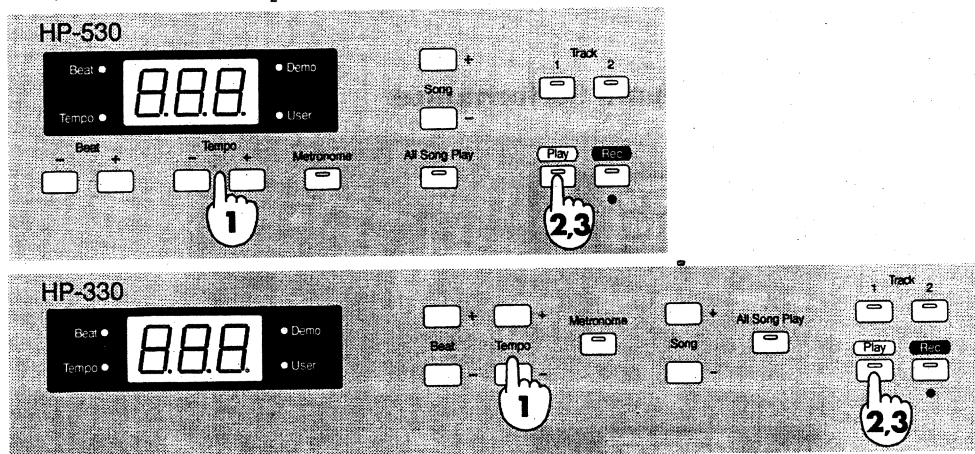

1. Select the desired tempo with the Tempo [+/-] buttons.
2. Press the Play button, and the song will be played at the set tempo.
 - * You can change the tempo even while the song is playing.
3. Press the Play button again to stop playing.
4. Press the two Tempo [+/-] buttons at the same time, and the original tempo will be retrieved.
 - * The tempo or beat may change in the middle of the song. Even so, the display shows the tempo and beat at the head of the song. Therefore, if you change the tempo in the middle of the song, the tempo shown in the display may differ from the tempo currently being used.
 - * You cannot change the beat while a song is being played.

Practicing Right And Left Hands Separately

Listening to the right and left parts separately

A tape recorder records two channels separately; the sound played by the right speaker and that by the left speaker. The place where each sound is recorded is called a track. Regarding Demo Songs in the HP-530/330, what is played with the right hand is stored in Track 1, while what is played with the left hand is recorded in Track 2. This is very convenient for piano lessons, since you can play each hand separately.

The Demo Songs include pieces for four-hand performances. In a four-handed piece, each Track has a different player, and therefore, you can enjoy four-handed performance by yourself.

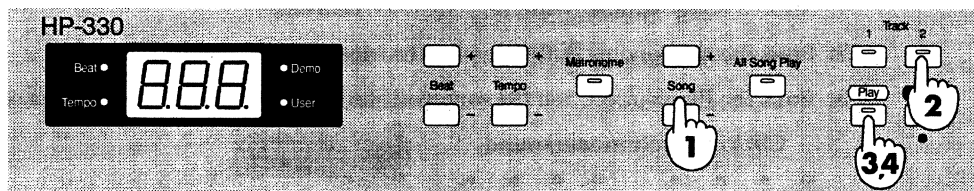
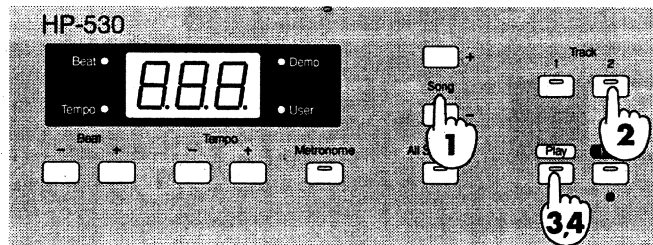

1. Select a Song Number using the Song [+/-] buttons.
2. Press the Track 2 button and confirm that the indicator goes out.

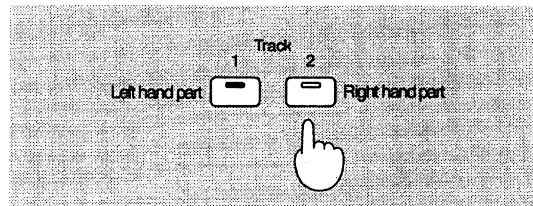

3. Press the Play button, and the song stops playing.
 4. Press the Play button again to stop playing.
- * When Track 2 is lit and Track 1 is dark, only the right-hand part will be played.

Count-In Play

When you play the piano along with a Demo Song, it will be difficult for you to start at the right timing if the song begins suddenly. The count-in can be effectively used to make it easier for you to start playing. This is called Count-in Play.

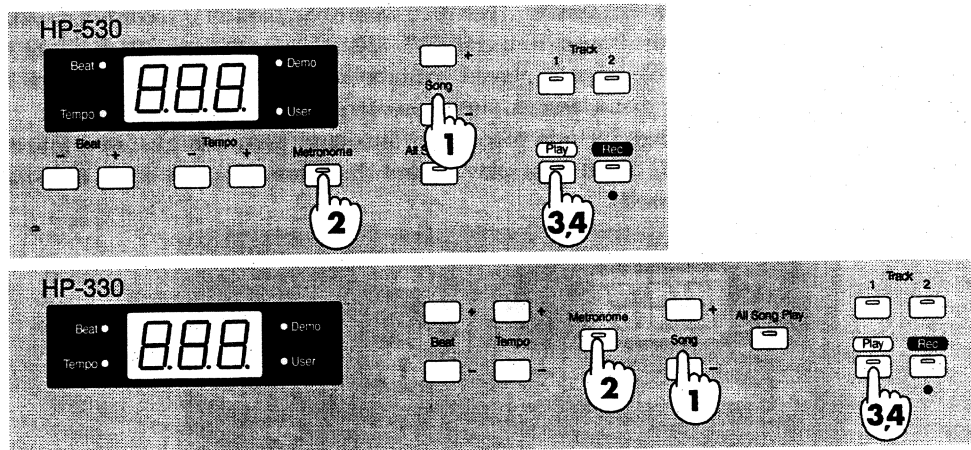

1. Select a Song Number with the Song [+/-] buttons.
2. Press the Metronome button to play the Metronome.
3. Press the Play button, and the song will start playing after a two-measure count-in.

Clicking metronome sound

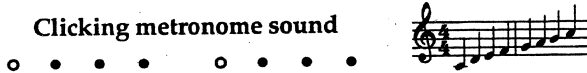

4. Press the Play button again to stop playing.

Playing to the Metronome

The HP-530/330 is equipped with a metronome. You can practice playing at the proper timing using the metronome.

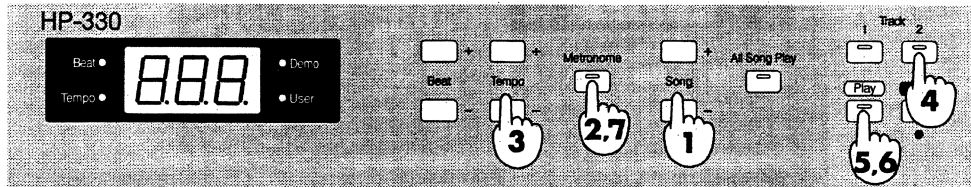
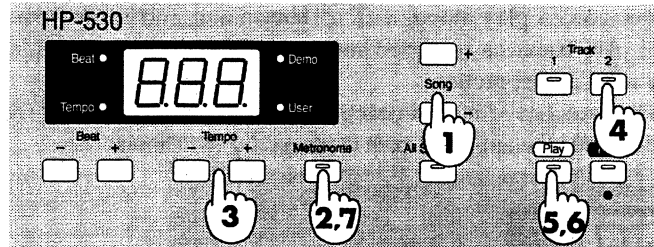

1. Select a Song Number with the Song [+/-] buttons.
2. Press the Metronome button to play the metronome.
3. Select a desired tempo by pressing the Tempo [+/-] buttons. Select a slow tempo to start with.

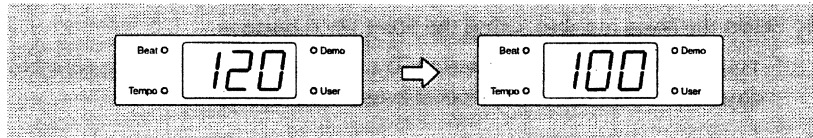

- * If you press the both the Tempo [+/-] buttons at the same time, the original tempo will be restored.
4. Press the Track 2 button, and confirm that the indicator goes out. Practice the right-hand part by playing along with the left hand part of the Demo Performance.
 5. Press the Play button. After a two-measure count-in, the song will start playing at the selected tempo.
 6. Press the Play button again to stop playing.
 7. Press the Metronome button to stop the metronome.
- * For information on the proper way of using the metronome, see page 18.

Recording

Playing Along with the Demo and Recording

The piano allows you to play along with a Demo Song and record the performance. When you later play back the recorded music, it can be quite helpful in determining where you may need more practice.

For example, when you have finished practicing the right-hand part, try recording to see how well you do, while the left-hand part is played by the Demo.

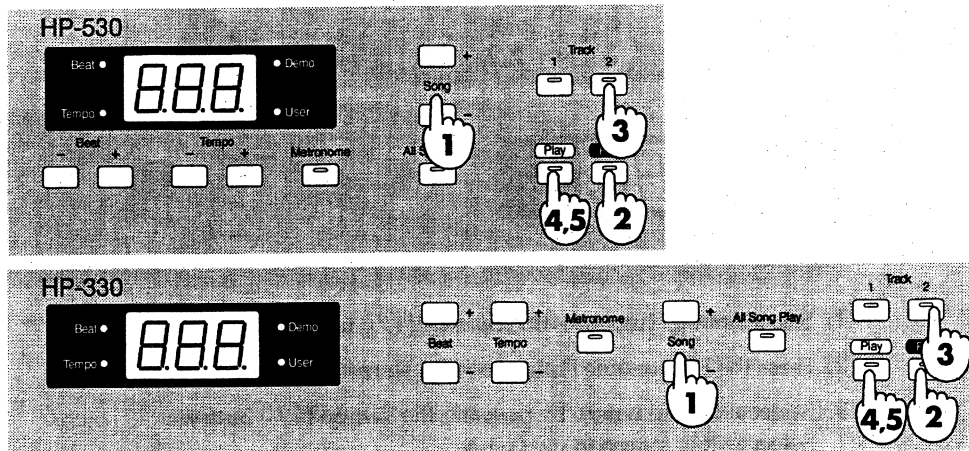

1. Select the Song number, using the Song [+/-] buttons.
 - * Your performance is recorded in Track 1 and Track 2 in Song Number 0. Any existing data will be automatically erased when new data is recorded.
2. Press the Rec button and confirm that the indicator is lit. Now, the HP is ready to record your performance. Press the Rec button again to stop recording.
3. Press Track 2 button and confirm that the indicator is lit.
4. Press the Play button, and it starts recording after a two-measure count-in. You can play the right-hand part along with the left hand part of the Demo Performance.
 - * If you play the piano without pressing the Play button, the HP will start recording it right away without any count-in.
5. Press the Play button to stop recording. The display shows Song Number "0."

Listening to the Recorded Performance

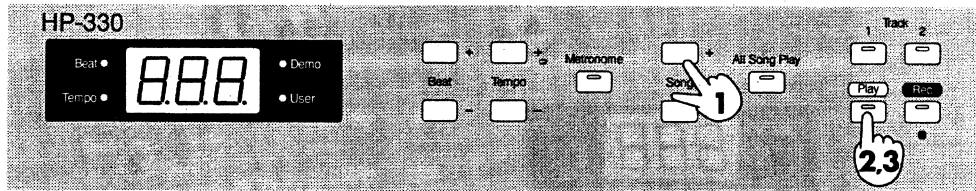
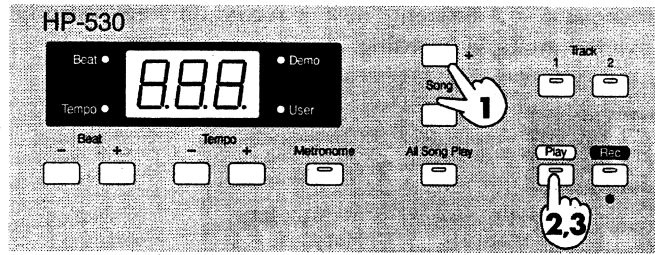

1. Select Song Number "0" with the Song [+/-] buttons.
 * Pressing the two Song buttons [+/-] at the same time will select 0.

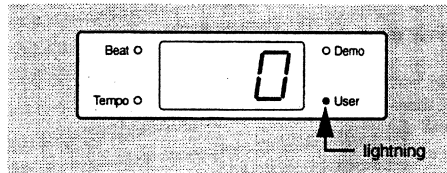

2. Press the Play button, and the recorded data will be played back.
 The right-hand part you played and the left hand part of the Demo Performance are played back.
 If the indicator of Track 2 is lit and that of Track 1 is dark, only the right-hand part of your performance will be played.

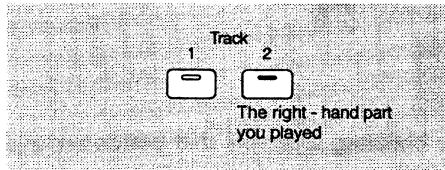

If the indicator of Track 1 is lit and that of Track 2 is dark, only the left-hand part of the Demo Performance will be played.

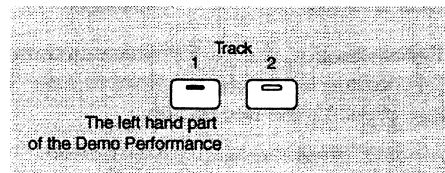

3. Press the Play button to stop playing.

Recording Your Performance

You can record each hand in a different Track or record different instrument sounds in different Tracks to enjoy multiple recording.

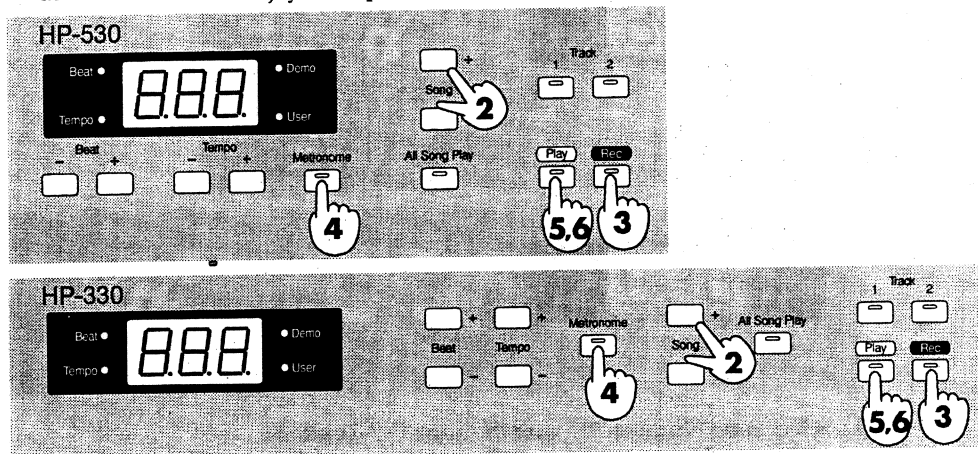

1. Select an instrument you wish to record, then set the Chorus, Reverb, Tempo, etc.
* You cannot change the Tempo or Beat during recording.
2. Select Song Number "0" with the Song [+/-] buttons.

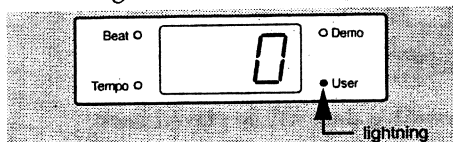

The performance data is recorded in Song Number 0.

3. Press the Rec button, and the indicator(s) for the track(s) where no data is recorded begin blinking. This is the Recording Standby mode.
Press the Rec button again to stop recording.

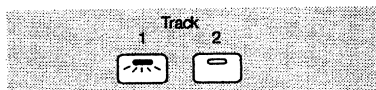

If neither Track indicator starts blinking, it means that performance data has already been recorded in both Tracks.

Press either Track button to cause the corresponding indicator to begin blinking. Now, when the unit starts recording, any existing data in the Track will be erased, and new data will be recorded. Once the data is erased, it cannot be restored.

When the indicator for a Track lights steadily, the performance data recorded there will be played back when you begin recording. If you do not want to hear this playback, get the Track indicator to go out before pressing the Rec button.

4. If you wish to record to the metronome, press the Metronome button.
5. Press the Play button, and the HP starts recording after a two-measure count-in. Now you can start playing the piano.
* If you play the piano without pressing the Play button, the HP will start recording right away without any count-in.
6. Press the Play button to stop recording.

Erasing the Recorded Performance Data

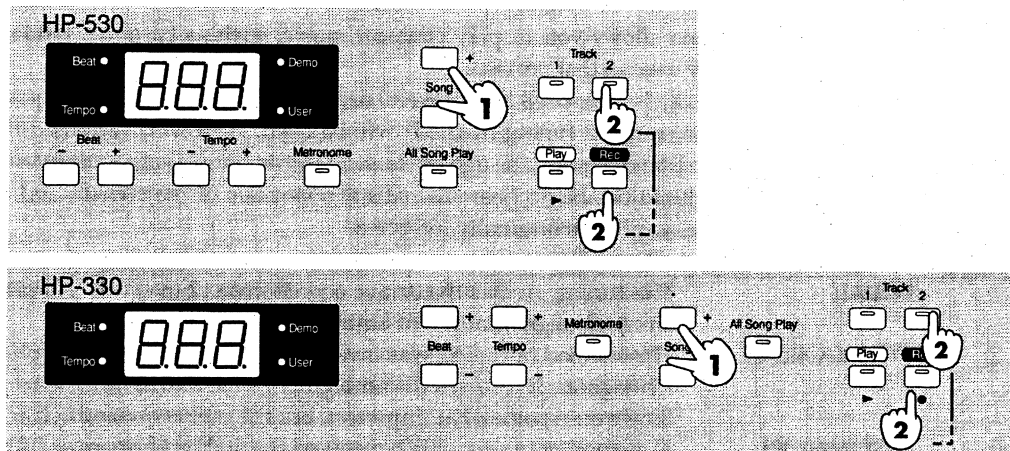

1. Select Song Number "0" with the Song [+/-] buttons.
 2. Press the Rec button while holding down the Track button where the performance data is recorded.
- * Once the data is erased, it cannot be restored.

Note About Recording

When in the recording standby mode, if you press the button for a track where performance data has been recorded (causing the indicator to begin blinking), recording will start, and the newly recorded data will replace any previously recorded data. Once the data is erased, it can never be restored.

There is a limit on the number of notes that can be recorded in the unit. If a pedal is used, the pedal messages are recorded, thereby reducing the number of recordable notes. When the space for recording performance data gets nearly full during recording, the indicator for the Track button starts to flash quicker. When no more data can be recorded, the indicator for the Rec button will go out, and recording stops automatically. The recorded data will be erased in 8 hours after the HP is switched off. If you wish to retain the data, connect an external sequencer and record it. (p. 36)

OTHER USEFUL FUNCTIONS

Playing in the Tuning of Classical Music

Your new piano allows you to play classical music, such as baroque, while using the tuning actually used in that period.

Most music today is composed and played based on the assumption that equal temperament (the most common tuning method) will be used. However, various different tunings were in existence during the age of classical music. By playing a piece using the old tuning, you should be able to hear the natural sonorities of the chords, and appreciate the piece in the way it was originally intended.

Display	Tuning	Descriptions
1	EQUAL	This tuning divides the octave equally into 12 intervals. All pitches have an equal, slight amount of ambiguity.
2	PYTHAGOREAN	This method of tuning was invented by the famous philosopher Pythagoras. It resolves the ambiguity of the fourths and fifths. The third, however, is somewhat imperfect, but the melody sounds clear.
3	JUST (MAJOR)	A method of tuning which resolved the ambiguousness of fifths and thirds. Quite beautiful sonorities are produced with chords, but the scale is unbalanced, so it is not well-suited for melodies.
4	JUST (MINOR)	With Just tuning, the tuning for major is different from that for minor. The same effect as the major version can be obtained with the minor one.
5	MEAN TONE	A temperament which adds some compromises to Just temperament, and facilitates transposition.
6	WERCKMEISTER	Through combining the Mean Tone and Pythagorean temperaments, it allows for playing in any key.
7	KIRNBERGER	As a result of improvements made to the Mean Tone and Just temperaments, it is relatively tolerant towards transposition, and can be used to play in all keys.

When you play using a tuning other than the equal temperament, you need to assign the keynote ("C" for major and "A" for minor) according to the key of the song to be played. For ensemble with a different musical instrument, pitches will differ depending on the key. Therefore, you should set the HP piano to the same basic pitch as the other instrument.

The display represents the following notes:

Display	C	C.	d	d.	E	F	F.	G	G.	A	A.	b
Basic Note	C	C#	D	D#	E	F	F#	G	G#	A	A#	B

Setting the Tuning Method

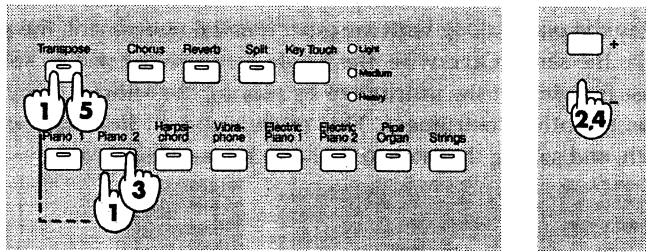

1. Press the Piano 2 button while holding the Transpose button down.
The display shows the Tuning Method currently selected and the Basic Note.
The Basic Note is shown at the right and the Tuning at the left.

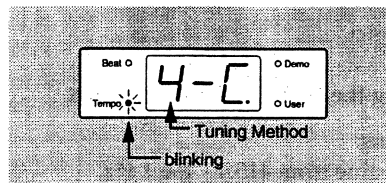

2. Select the desired Tuning Method with the [+/-] buttons.
3. Press the Piano 2 button again.

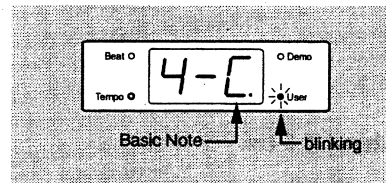

4. Select the Basic Note with the [+/-] buttons.
 5. Press the Transpose button and confirm that the indicator goes out.
Now, the Tuning Method is selected. The Tuning Method you have selected is retained until the HP piano is switched off.
- * When the HP piano is switched on, the Equal Temperament is automatically selected.

Adjusting the Pitch of the Sound (Master Tuning)

When you play the piano along with the other musical instrument, the pitch of the basic note should be the same. Otherwise, the whole performance will be spoiled. Generally, you can adjust the pitch of the instrument by playing the Middle A key and set it to the same pitch as the other instrument. This pitch is shown in Hertz, and is called the Standard Pitch, and setting the pitch to the same Hz is called Tuning.

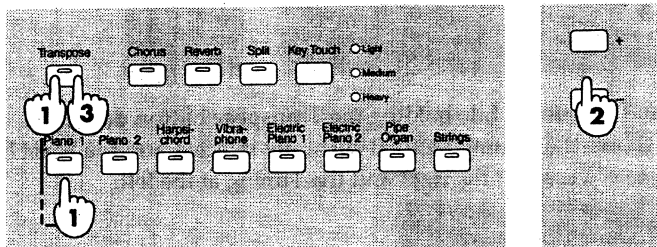

1. Press the Piano 1 button while holding the Transpose button down.
2. Adjust the pitch using the [+/-] buttons.
The standard pitch can be set to any value from 415.4 - 466.1 Hz.
The display shows the three figures from the right to left; the first decimal place, number of units and tens.

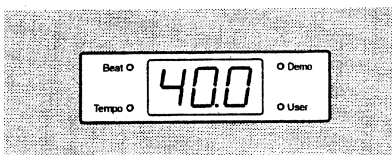

The above display shows that the pitch is 440.0 Hz.

3. Press the Transpose button and confirm that the indicator goes out.
The pitch you have set as above will be retained until the HP is switched off.
- * When the HP is switched on, a standard pitch of 440.0 Hz will be automatically selected.

Setting the Tuning Curve (Stretch Tuning)

Stretch Tuning is a unique method of tuning specific to pianos. The pitch of a piano is generally tuned lower in the bass, and higher in the treble compared with equal temperament. The Tuning Curve shows the actual pitch change of the tuning compared to the pitch change in the treble of the equal temperament. By changing the tuning curve, the chords will sound subtly different.

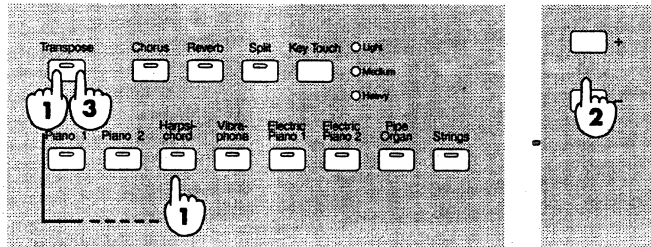

Display	Description
1	This is a standard tuning curve which is suitable for the Dual Play or ensemble with the other musical instrument.
2	This is the tuning curve that stretches the bass and treble. This is suitable for piano solo.

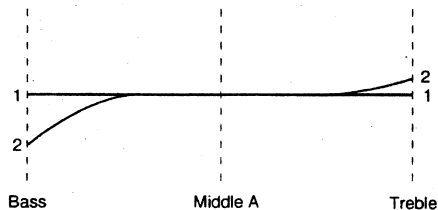

1. Press the Harpsichord button while holding the Transpose button down.
2. Select the Tuning Curve 1 or 2 with the [+/-] buttons.
3. Press the Transpose button and confirm that the indicator goes out.
The Tuning Curve you have selected here will be retained until the HP is switched off.
 - * When the HP is switched on, 2 will be automatically selected.
 - * Even when using a tuning method other than Equal Temperament (p. 28,29), the Tuning Curve can be set.
 - * This Stretch Tuning is effective for Piano 1 and Piano 2.

Changing the Volume Balance for Dual Play

You can change the volume balance of the two Tones used for Dual Play. Higher values increase the volume.

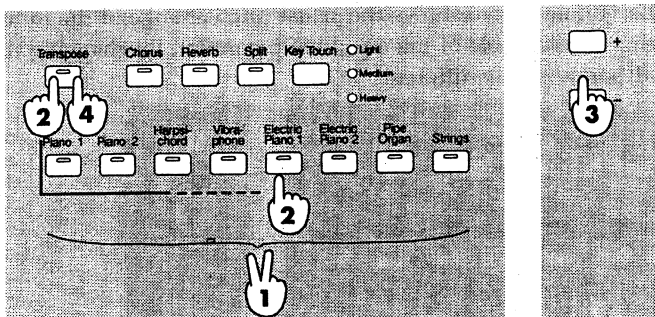

1. Press two Tone buttons at the same time to turn to the Dual Play mode.
2. Press the Electric Piano 1 button while holding the Transpose button.
3. Adjust the volume balance with the [+/-] buttons.
+ increases the volume of the right Tone.

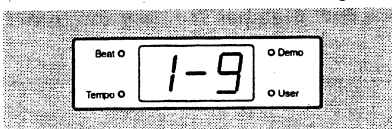

- increases the volume of the left Tone.

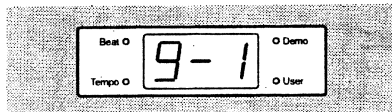

Monitor the volume balance by actually listening to the sound.

4. Press the Transpose button and confirm that the indicator goes out.
The Volume Balance you have set here will be retained until the HP is switched off.
- * When the HP is switched on, 5 - 5 will be automatically selected.

Changing the Demo Song/Keyboard Balance

Without changing the volume of the keyboard, you can alter the volume of Demo Songs or recorded performance data in 7 levels. A higher number results in a higher volume.

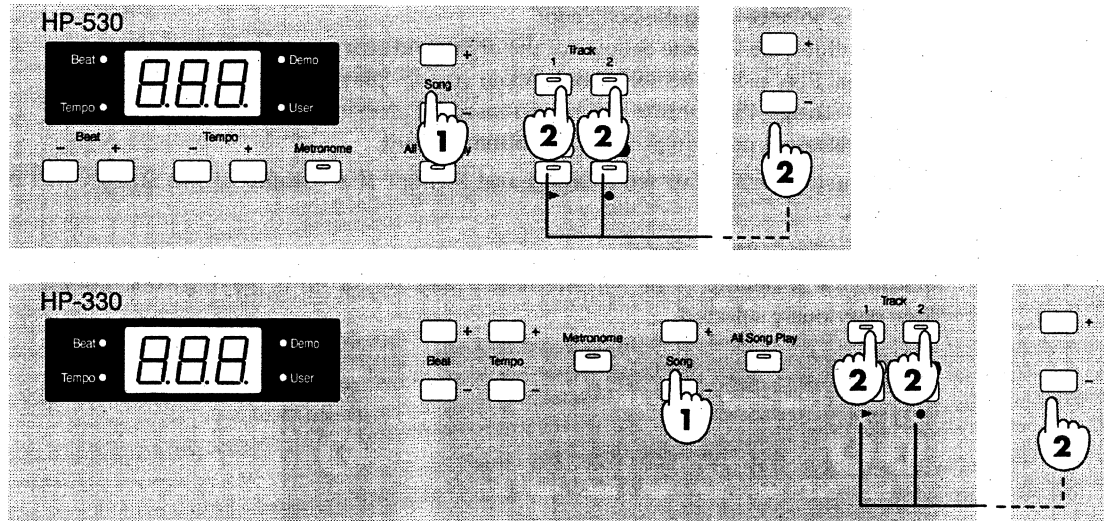

1. Select a Song Number with the Song [+/-] buttons.
2. Set the volume by using the [+/-] buttons while holding Track button 1 or 2 down.

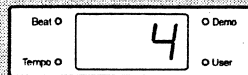

1 - 7 are available as settings for the volume.

Monitor the volume difference by actually listening to the sound.

- * When the HP is switched on, 4 will be automatically selected.
- * It is not possible to change the volume of only one of the two Tracks.

Changing the Assignment to the Pedals

The Soft Pedal and the Sostenuto Pedal can be assigned to a different functions as follows:

Changing the volume balance using the Soft Pedal

You can adjust the volume balance of the organ and strings in the Dual Play using the Soft Pedal. When you are playing using Dual Play with Organ or Strings, the volume will be increased by pressing the Soft Pedal. While the Pedal is released, no Strings or Organ sound is heard.

* While using Dual Play with Organ and Strings, the volume of the Strings will be altered.

Selecting Tones using the Sostenuto Pedal

Pressing the Sostenuto Pedal will alternately play the currently playing Tone and the Tone previously selected.

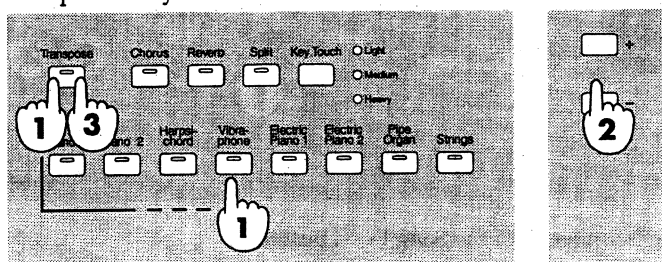

1. Press the Vibraphone button while holding the Transpose button down.

2. Set the pedal function using the [+/-] buttons.

Display	Pedal Function
1	Normal pedal function
2	The function of the Soft Pedal changes
3	The function of the Sostenuto Pedal changes
4	The functions of both the Soft and Sostenuto Pedals change

Monitor the effect by actually listening to the sound.

3. Press the Transpose button and confirm that the indicator goes out.

The function you have set here will be retained until the HP is switched off.

* When the HP is switched on, 1 will be automatically selected.

Changing the Amount of Resonance for the Damper Pedal

On an acoustic piano, pressing the damper pedal will create resonance effect as the other strings resonate the played key, adding rich vibration and spaciousness. The HP-530/330 reproduce the resonance.

The amount of the resonance can be changed in 7 levels. A higher value produces a deeper effect.

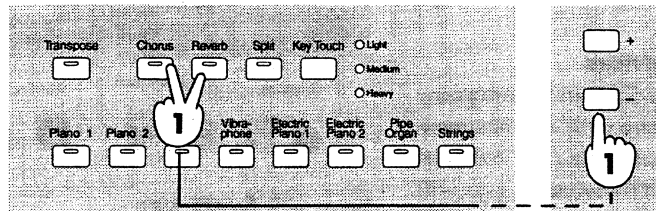

1. While holding down the Chorus and Reverb buttons at the same time, set the amount of the resonance with the [+/-] buttons.

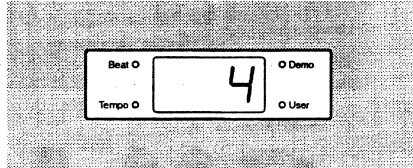

1 - 7 are available for the Resonance effect.

The Resonance you have set is retained until the HP is switched off.

- * When the HP is switched on, 4 will be automatically selected.
- * This setting is effective for Piano1 and Piano2.

USING MIDI

If you do not intend to connect a MIDI device to the piano, you do not need to read this chapter.

MIDI

MIDI stands for Musical Instrument Digital Interface, an international standard which allows performance information to be communicated among electronic musical instruments and computers.

Connecting with MIDI Devices

The HP-530/330 features MIDI and Computer connectors to send and receive performance messages to and from an external device. By connecting external devices through these jacks, you will benefit more integrated ways of using the HP piano.

MIDI Connectors

The HP-530/330 features two types of MIDI connectors; MIDI OUT and MIDI IN jacks. By connecting the piano to an external MIDI device through these jacks, they can control each other. For instance, you can play an external device or change sounds on the external device from the piano.

MIDI Out Jack

This sends out messages describing actions (such as playing the keyboard) to the MIDI jack on the external device.

MIDI In Jack

This receives the MIDI messages sent by an external MIDI device.

The receiving MIDI device will act according to the MIDI messages received; such as produce sounds, change sounds, etc.

Connecting a MIDI Device to the HP-530/330

1. Switch off the piano.
2. Set the Computer switch on the rear of the piano to the MIDI position.

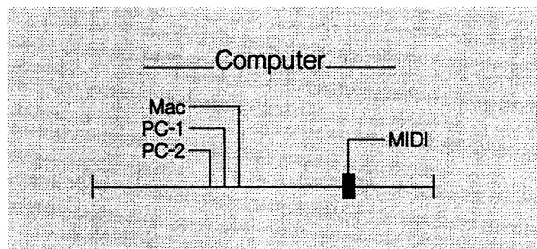

3. Connect the MIDI jack on the external device that on the piano using the MIDI cable (option: MSC-15/25/50).

Setup Example Setup with a Sound Module

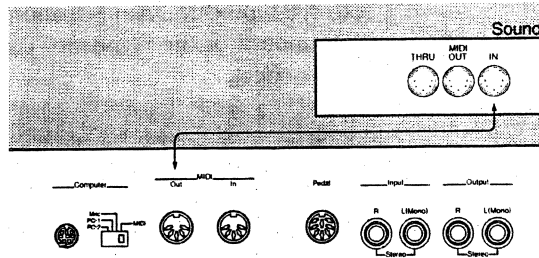

Setup with the MT-120

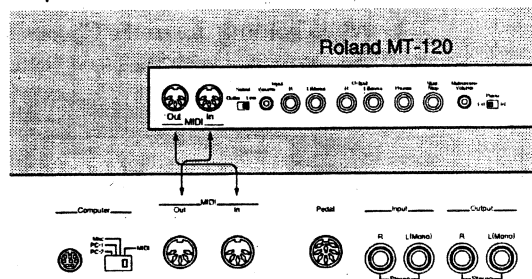

Setup with a MIDI Sequencer, MIDI Sound Module

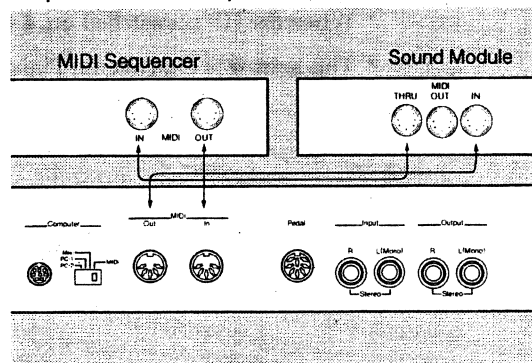

If necessary, read p. 37 and set the MIDI Transmit Channel, Local Control ON/OFF, etc.

Setting the MIDI Transmit and Receive Channels

MIDI provides 16 channels. MIDI messages are communicated between two devices over a MIDI channel. Even if the two devices are connected properly with a MIDI cable, messages cannot be sent or received properly if the MIDI channels are not set correctly.

How to Set the MIDI Transmit and Receive Channel

1. Press the Electric Piano 2 button while holding the Transpose button down.
2. Set the MIDI transmit channel (on the transmit device) with the [+/-] buttons.

3. Press the Transpose button and confirm that the indicator goes out.
4. Press the Pipe Organ button while holding the Transpose button down.
5. Set the receive MIDI channel (on the receiver device) with the [+/-] buttons.
6. Press the Transpose button and confirm that the indicator goes out.

The MIDI channel you have set is retained until the piano is switched off.

* If ALL is selected for the receive channel, the HP-530/330's sound will always play no matter what channels performance messages are received.

* The Tone to be played is determined by the Program Change received on that channel. The Program Change Numbers and the corresponding Tones are shown on page 39.

Setting the Local Control

Local Control On/Off

When the piano is connected to a MIDI sequencer, the performance is recorded into the sequencer, then the recorded data can be played back by the sequencer.

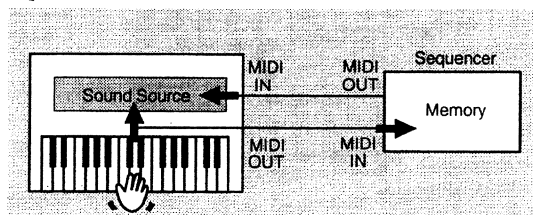

If the sequencer's THRU function is turned on, the same notes will be combined and played. This happens because the keyboard information reaches the sound generator via two different routes (1) and (2). This makes the performance sound strange, and greatly reduces the number of available voices. To resolve this, we can disable route (1) by setting the unit to LOCAL OFF.

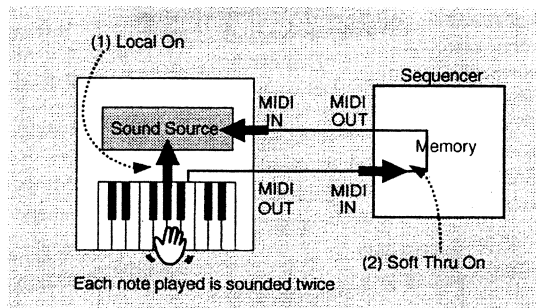

Local ON: In this mode, the keyboard and the internal sound module are connected.

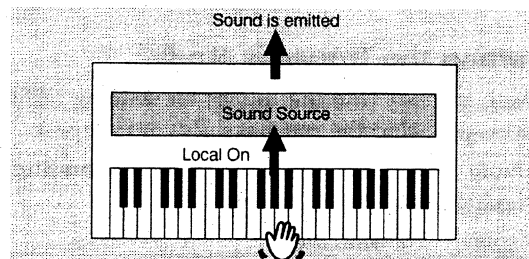

Local Off: The keyboard and the internal sound module are disconnected. No sound will be heard by playing the keyboard.

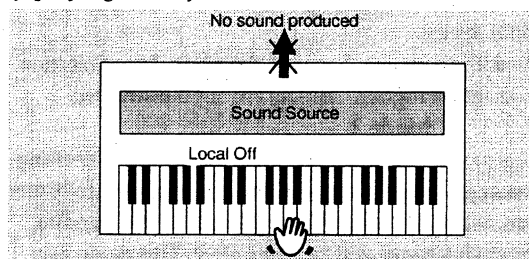

1. Press the Strings button while holding the Transpose button down. Now it is Local On mode.
2. Local can be toggled On/Off by pressing the [+/-] buttons.

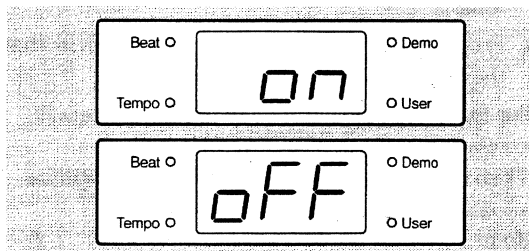

3. Press the Transpose button and confirm that the indicator goes out. The Local On or Off setting you make here is retained until the piano is switched off.

* When the MIDI Connector on the piano is not connected to a MIDI cable, it is always set to Local On.

* A MIDI sequencer is a device that records performance data in the form of MIDI messages, then plays it back. Roland offers the MC-50mk II and MT-120, which combine both a sequencer and sound module.

The Local On or Off is selected by receiving the MIDI Local Control messages. When the piano is set up with the MT-120, Local Off messages are transmitted when the MT-120 is switched on. By

switching on the piano, then the MT-120, the piano automatically selects Local Off.

Setting the Transmit Mode

There are two Transmit modes for sending MIDI messages. Select the one that suits your purpose.

* Note and Pedal messages can be transmitted and received in any mode.

Display Transmit Mode

1 Mode 1

- This mode allows the piano to transmit only the performance messages (information concerned with playing the keyboard or pressing the pedals) to the external MIDI device.

Even if you change Tones on the piano, Tone Selection messages (Program Change) are not transmitted.

2 Mode 2

This mode allows the piano to transmit various setting messages, along with the normal performance information. When you select a new Tone, the corresponding Program Change will be transmitted. This mode may be convenient when recording performances into a sequencer.

1. Press the Chorus button while holding the Transpose button down.
2. Select the Transmit Mode with the [+/-] buttons.
3. Press the Transpose button and confirm that the indicator goes out.

The Transmit Mode you have selected here will be retained until the piano is switched off.

When the piano is switched on, MODE 1 will be automatically selected.

Mode	1	2
MIDI Messages	Transmit	Transmit
Note Message	o	o
Program Change Message	*1	o
Control Change Message		
Volume (7)	x	x
Damper (64)	o	o
Sostenuto (66)	o	o
Soft (67)	o	o
Expression (11)	o	o
Chorus On/Off (93)	x	o
Reverb On/Off (91)	x	o
Master Tune (RPN)	x	o
Roland Exclusive Message		
Temperament Selection	x	o
Stretch Tuning Selection	x	o
Dual Balance Selection	x	o
Chorus Depth Selection	x	o

Reverb Depth Selection x o
Pedal Resonance Amount Selection x o

* *1 : No message will be transmitted by selecting a new Tone on the piano. (See Transmitting and Receiving Program Changes)

Transmitting and Receiving Program Changes

Transmitting

Program Changes can be transmitted as follows:

1. Press the Reverb button while holding the Transpose button down.
2. Press the Reverb button again, and the display shows the Group, Bank, and Number.
3. Set the Program Change Number with the [+/-] buttons.
4. Press the Transpose button and confirm that the indicator goes out.

The Program Change you have set will be retained until the piano is switched off.

Group A

		Number							
		1	2	3	4	5	6	7	8
Bank	1	1	2	3	4	5	6	7	8
	2	9	10	11	12	13	14	15	16
	3	17	18	19	20	21	22	23	24
	4	25	26	27	28	29	30	31	32
	5	33	34	35	36	37	38	39	40
	6	41	42	43	44	45	46	47	48
	7	49	50	51	52	53	54	55	56
	8	57	58	59	60	61	62	63	64

Group B

		Number							
		1	2	3	4	5	6	7	8
Bank	1	65	66	67	68	69	70	71	72
	2	73	74	75	76	77	78	79	80
	3	81	82	83	84	85	86	87	88
	4	89	90	91	92	93	94	95	96
	5	97	98	99	100	101	102	103	104
	6	105	106	107	108	109	110	111	112
	7	113	114	115	116	117	118	119	120
	8	121	122	123	124	125	126	127	128

Receiving

When the piano receives a Program Change Number, the corresponding Tone will be selected as shown in the following list. When the Transmit Mode 2 is selected, the Program Change that corresponds to the Tone will be transmitted.

Program Change	Tone
1	Piano1
2	Piano2
4	Harpsichord
5	Vibraphone
6	Electric Piano1
7	Electric Piano2
8	PipeOrgan
9	Strings
10	Piano1+Piano2
11	Piano1+Harpsichord
12	Piano1+Vibraphone
13	Piano1+Electric Piano1
14	Piano1+Electric Piano2
15	Piano1+PipeOrgan
16	Piano1+Strings
17	Piano2+Harpsichord
18	Piano2+Vibraphone
19	Piano2+Electric Piano1
20	Piano2+Electric Piano2
21	Piano2+PipeOrgan
22	Piano2+Strings
23	Harpsichord+Vibraphone
24	Harpsichord+Electric Piano1
25	Harpsichord+Electric Piano2
26	Harpsichord+PipeOrgan
27	Harpsichord+Strings
28	Vibraphone+Electric Piano1
29	Vibraphone+Electric Piano2
30	Vibraphone+PipeOrgan
31	Vibraphone+Strings
32	Electric Piano1+Electric Piano2
33	Electric Piano1+PipeOrgan
34	Electric Piano1+Strings
35	Electric Piano2+PipeOrgan
36	Electric Piano2+Strings
37	PipeOrgan+Strings
38	Acoustic Bass/Piano1
39	Acoustic Bass/Piano2
40	Strings/Harpsichord
41	Acoustic Bass/Vibraphone
42	Acoustic Bass/Electric Piano1
43	Acoustic Bass/Electric Piano2
44	PipeOrgan/Harpsichord
45	Strings/Piano1

* 10 - 37 are for Dual Play, while 38 - 45 are for the Split mode.

* 3, and 46 - 128 will be ignored.

Connecting with a Computer

The HP 530/330 is equipped with a Computer connector. By connecting a cable between this connector and the serial port on a computer, performance information can be communicated between the piano and the computer.

1. Switch off the piano.
2. Connect a computer cable (RSC-15APL/RSC-15AT/RSC-15N: optionally available) between the serial port on the computer and the Computer connector on the piano.
3. Set the Computer switch on the piano to Mac, PC-1, or PC-2.
4. Match the baud rate (data transmission speed used by the computer and the HP-530/330) of the computer and the software.

Setup Examples

Setup for the Apple Macintosh Series

Connect the Modem Port (or Printer Port) on the Apple Macintosh Series to the Computer connector on the piano using the computer cable (RSC-15APL: optionally available), then set the Computer switch to Mac.

Use Patch Bay on the Apple Macintosh to set the Interface Type (clock of the MIDI Interface) to 1 MHz.

Setup for the IBM PC

Connect the serial port (such as COM1 or COM2) on the IBM PC with the Computer connector on the piano using a computer cable (RSC-15AT: optionally available), then set the Computer switch to PC-2.

Then, set the Computer switch so it matches the Baud Rate of the software to be used.

When the baud rate is 31.25 kHz, set it to PC-1, and when it is 38.4 kHz, set it to PC-2.

* For further information about the baud rate setting, refer to the owner's manual for the software you use.

If necessary, modify the MIDI Transmit Channel (p. 36) or Local On/Off (p. 37).

MIDI Implementation Chart

Function...		Transmitted	Recognized	Remarks
Basic Channel	Default Changed	1 1-16	1 1-16	
Mode	Default Messages Altered	Mode 3 x *****	Mode 3 x	
Note Number :	True Voice	x 15-113 *****	0-127 15-113	
Velocity	Note ON Note OFF	O O 8n v = 64	O x	
After Touch	Key's Ch's	x x	x x	
Pitch Bend		x	x	
Control Change	6, 38 7 11 64 66 67 91 93 100, 101	x x O O O O x x x x	*1 x O O O O O O O x	*1 Data entry Volume Expression Hold 1 Sostenuto Soft Reverb Chorus RPN LSB, MSB
Prog Change	: True #	O (0-127) *****	O 0-1, 3-44	
System Exclusive		x *1	O	
System Common	: Song Pos : Song Sel : Tune	x x x	x x x	
System Real Time	: Clock : Commands	x x	x x	
Aux Message	: All sound off : Reset all controllers : Local ON/OFF : All Notes OFF : Active Sense : System Reset	x x x x O x	x O O O (123-127) O x	
Notes		* 1 O x is selectable.		

Mode 1 : OMNI ON, POLY Mode 2 : OMNI ON, MONO
Mode 3 : OMNI OFF, POLY Mode 4 : OMNI OFF, MONO

O : Yes
X : No

TROUBLESHOOTING

When the piano does not work properly, check the following first:

The piano cannot be switched on

Check that the Power Cord is securely and correctly connected. (p. 4)

No sound is heard

Check that the Volume slider is not set to the far left position. (p. 11)

Check that headphones are not connected to the piano. (p. 5)

No sound is heard (when an external MIDI device is connected)

Check that all the relevant devices are switched on.

Check that the Computer switch on the rear of the piano is set to MIDI. (p. 36)

Check that Local Off is not selected. (p. 37)

Demo Song cannot be played

Check that the indicator of a Track button is lit. No sound is heard from a Track whose indicator is dark. Press the Track button to light it up.

During recording or playback, any other Demo Song cannot be heard. Stop recording or playback. (p.11. 19. 24 - 26)

Two Tones are played when keyboard is pressed

Check that the piano is not set to the Dual Play mode. (p. 13)

If a sequencer is connected, check that Soft THRU on the sequencer is turned off. (p. 37)

Not all sounds are played

The maximum number of voices of the HP-530/330 is 64. If you play along with a Demo Song and frequently use the Damper Pedal, and the performance data exceeds the maximum voices, some sounds may be left out.

The pitch of the keyboard or Demo Songs sounds incorrect.

Check that the Key Transpose is off. (p. 16, 17)

Check that the Tuning Method and Stretch Tuning is set correctly. (p. 28, 29, 31)

Check that the Master Tuning is set correctly (p. 30)

Pedal is not functioning properly; it does not have any effect, or it stays on.

Check that the Pedal is securely and correctly connected.

Make sure that the pedal cord from the stand is connected securely to the Pedal jack on the rear of the piano.

Recorded data is erased

Didn't you press the Rec button while holding the Track button down ? (p. 27)

About 8 hours after the piano is switched off, the data will be automatically erased.

Once data is erased, it cannot be restored.

SPECIFICATIONS

HP-530/330 Digital Piano

Keyboard	88 keys (Hammer Action Mechanism)
Sound Module	maximum voices: 64
Tones	Piano 1, Piano 2, Harpsichord, Vibraphone, Electric Piano 1, Electric Piano 2, Pipe Organ, Strings, * Honky Tonk Piano (* in the Dual Play)
Display	7-segment LED/3 characters
Effect	Chorus (7 types), Reverb (7 types)
Tuning	Equal Temperament, Pythagorean, Just (Major/Minor), Mean Tone, Werckmeister, Kirnberger.
Stretch Tuning	2 Types
Key Touch	3 Levels (Light/Medium/Heavy)
Key Transpose	-6 - +5 semitones (Keyboard Entry/Button Entry)
Sequencer	2 Tracks (with Track Muting Function) Approx. 5,000 notes
Metronome	0/4, 2/4, 3/4, 4/4, 5/4, 6/4, 7/4, 3/8, 6/8, 9/8, 12/8, 7 Level Volume Adjustment, Tempo Variable 20 - 250
Jacks	Headphone Jack x 2 (stereo), Output Jacks (stereo/mono), Input Jacks (stereo/mono),MIDI Connectors (In/Out), Pedal Jacks, Computer Connector, Microphone Jack (only on the HP-530)
Pedals	Damper, Soft, Sostenuto (supports half-pedaling)
Speakers	20 cm x 2 + 5 cm x 2 (HP-530), 20 cm x 2 (HP-330)
Output	30 W x 2
Finish	Brazilian Rosewood
Power	93W (AC 117 V), 72 W (AC 230 V), 72 W (AC 240 V)
Dimensions (including the stand)	HP-530: 1437 (W) X 525(D) X 872(H) mm / 56-9/16 (W) x 20-11/16 (D) x 34-5/16 (H) inches HP-330: 1446 (W) X 500 (D) X 834 (H) mm / 56-9/16 (W) x 19-11/16 (D) x 32-7/8(H) inches
Weight (including the stand)	HP-530: 63.6 kg/ 140 lbs 3 oz, HP-330: 59.2 kg / 130 lbs 8 oz
Accessories	Owner's Manual, Power Cord
Options	MIDI Implementation
Specifications are subject to change without notice.	

Service Information

ARGENTINA

Instrumentos Musicales
S.A.
Florida 638
(1005) Buenos Aires
ARGENTINA
TEL: (01) 394 4029

BRAZIL

Roland Brasil Ltda.
R. Coronel Octaviano da Silveira
203 05522-010
Sao Paulo BRAZIL
TEL: (011) 843 9377

CANADA

Roland Canada Music Ltd.
(Head Office)
5480 Parkwood Way Richmond
B. C., V6V 2M4 CANADA
TEL: (0604) 270 6626

Roland Canada Music Ltd.
(Toronto Office)
Unit 2, 109 Woodbine Downs
Blvd, Etobicoke, ON
M9W 6Y1 CANADA
TEL: (0416) 213 9707

MEXICO

Casa Veerkamp, s.a. de c.v.
Mesones No. 21 Col. Centro
Mexico D.F. 06080 MEXICO
TEL: (905) 709 3716

La Casa Wagner de
Guadalajara s.a. de c.v.
Av. Corona No. 202 S.J.
Guadalajara, Jalisco Mexico
C.P.44100 MEXICO
TEL: (03) 613 1414

PANAMA

Productos Superiores, S.A.
Apartado 655 - Panama 1
REP. DE PANAMA
TEL: 26 3322

U. S. A.

Roland Corporation U.S.
7200 Dominion Circle
Los Angeles, CA. 90040-3696,
U. S. A.
TEL: (0213) 685 5141

VENEZUELA

Musiland Digital C.A.
Av. Francisco de Miranda,
Centro Parque de Cristal, Nivel
C2 Local 20 Caracas
VENEZUELA
TEL: (02) 285 9218

AUSTRALIA

Roland Corporation
Australia Pty. Ltd.
38 Campbell Avenue
Dee Why West, NSW 2099
AUSTRALIA
TEL: (02) 982 8266

NEW ZEALAND

Roland Corporation (NZ)
Ltd.
97 Mt. Eden Road, Mt. Eden,
Auckland 3, NEW ZEALAND
TEL: (09) 3098 715

HONG KONG

Tom Lee Music Co., Ltd.
Service Division
22-32 Pun Shan Street, Tsuen
Wan, New Territories, HONG
KONG
TEL: 2415 0911

INDONESIA

PT CITRARAMA
BELANTIKA
Kompleks Perkantoran Duta
Merlin Blok E No.6-7
Jl. Gajah Mada No.3-5, Jakarta
10130,
INDONESIA
TEL: (021) 3850073

KOREA

Cosmos Corporation
Service Station
261 2nd Floor Nak-Won Arcade
Jong-Ro ku, Seoul, KOREA
TEL: (02) 742 8844

MALAYSIA

Bentley Music SDN BHD
No.142, Jalan Bukit Bintang 55100
Kuala Lumpur, MALAYSIA
TEL: (03) 2443333

PHILIPPINES

G.A. Yupangco & Co. Inc.
339 Gil J. Fuyat Avenue
Makati, Metro Manila 1200,
PHILIPPINES
TEL: (02) 899 9801

SINGAPORE

Swee Lee Company
BLOCK 231,
Bain Street #03-23
Bras Basah Complex,
SINGAPORE 0718
TEL: 3367886

CRISTOFORI MUSIC PTE
LTD
335, Joo Chiat Road SINGAPORE
1542
TEL: 3450435

TAIWAN

Siruba Enterprise (Taiwan)
Co., LTD.
Room. 5, 9fl. No. 112 Chung Shan
N.Road Sec.2 Taipei, TAIWAN,
R.O.C.
TEL: (02) 561 3339

THAILAND

Theera Music Co., Lt d.
330 Verng Nakorn Kasem, Soi 2,
Bangkok 10100, THAILAND
TEL: (02) 2248821

BAHRAIN

Moon Stores
Bad Al Bahrain Road,
P.O.Box 20077
State of BAHRAIN
TEL: 211 005

IRAN

TARADIS
Mir Emad Ave. No. 15, 10th street
P. O. Box 15875/4171 Teheran,
IRAN
TEL: (021) 875 6524

ISRAEL

Halilit P. Greenspoon &
Sons Ltd.
8 Retzif Ha'aliya Hashnya St.
Tel-Aviv-Yafo ISRAEL
TEL: (03) 6823666

JORDAN

AMMAN Trading Agency
Prince Mohammed St. P. O. Box
825 Amman 11118 JORDAN
TEL: (06) 641200

KUWAIT

Easa Husain Al-Yousifi
P.O. Box 126 Safat 13002
KUWAIT
TEL: 5719499

LEBANON

A. Chahine & Fils
P.O. Box 16-5857 Gergi Zeidan St.
Chahine Building, Achrafieh
Beirut, LEBANON
TEL: (01) 335799

OMAN

OHI Electronics &
Trading Co. LLC
P. O. Box 889 Muscat
Sultanate of OMAN
TEL: 706 010

QATAR

Badie Studio & Stores
P.O.Box 62,
DOHA QATAR
TEL: 423554

SAUDI ARABIA

SAF Music Center
AL-Khobar 31952, P. O. Box 1366
SAUDIARABIA
TEL: (03) 898 3311

Abdul Latif S. Al-Ghamdi
Trading Establishment
Al-Tamini Commercial And
Residential Center Al-Khobar
Dharan Highway W/Hamood St.
P. O. Box 3631 Al-Khobar
31952 SAUDI ARABIA
TEL: (03) 898 2332

SYRIA

Technical Light & Sound
Center
Khaled Ebn Al Walid St.
P.O.Box 13520
Damascus - SYRIA
TEL: (011) 2235 384

TURKEY

Barkat Sanayi ve Ticaret
Siraselvier Cad. Guney Ishani No.
86/6 Taksim, Istanbul TURKEY
TEL: (0212) 2499324

U.A.E

Zak Electronics & Musical
Instruments Co.
Zabeel Road, Al Sherooq Bldg.,
No. 14, Grand Floor DUBAI
U.A.E.
P.O. Box 8050 DUBAI, U.A.E
TEL: (04) 360715

EGYPT

A1 Fanny Trading Office
9, Ebn Hagar Ai Askalany Street,
Ard El Golf, Heliopolis, Cairo,
11341 EGYPT
TEL: (02) 4171828
(02) 4185531

MAURITIUS

Philanne Music Center
4th, Floor Noll, Happy World
House Sir William Newton Street
Port Luis MAURITIUS
TEL: 242 2986

REUNION

FO - YAM Marcel
25 Rue Jules MermanZL
Chaudron - BP79 97491
Ste Clotilde REUNION
TEL: 28 29 16

SOUTH AFRICA

That Other Music Shop
(PTY) Ltd.
11 Melle Street (Cnr Melle and
Juta Street)
Braamfontein 2001
Republic of SOUTH AFRICA
TEL: (011) 403 4105

Paul Bothner (PTY) Ltd.
17 Werdmuller Centre Claremont
7700
Republic of SOUTH AFRICA
TEL: (021) 64 4030

AUSTRIA

E. Dematte & Co.
Neu-Rum Siemens-Strasse 4
A-6040 Innsbruck P.O.Box 83
AUSTRIA
TEL: (0512) 26 44 260

BELGIUM/HOLLAND/ LUXEMBOURG

Roland Benelux N. V.
Houtstraat 1 B-2260 Oevel-
Westerlo BELGIUM
TEL: (014) 575811

CYPRUS

Radex Sound Equipment
Ltd.
17 Diagorou St., P.O.Box 2046,
Nicosia CYPRUS
TEL: (02) 453 426
(02) 466 423

DENMARK

Roland Scandinavia A/S
Langebrogade 6 Post Box 1937
DK-1023 Copenhagen K.
DENMARK
TEL: 32 95 3111

FRANCE

Guillard Musiques Roland
ZAC de Rosarge Les Echets 01700
MIRIBEL FRANCE
TEL: 7226 5060

Guillard Musiques Roland
(Paris Office)
1923 rue Léon Geoffroy 94400
VITRY-SUR-SEINE FRANCE
TEL: (1) 4680 86 62

FINLAND

Roland Scandinavia As,
Filial Finland
Lauttasaarentie 54 B
Fin-00201 Helsinki, FINLAND
P. O. Box No. 109
TEL: (0) 682 4020

GERMANY

Roland Elektronische
Musikinstrumente
Handelsgesellschaft mbH.
Oststrasse 96, 22844 Norderstedt,
GERMANY
TEL: (040) 52 60090

GREECE

V. Dimitriadis & Co. Ltd.
20, Alexandras St. & Bouboulinas
54 St. 106 82 Athens, GREECE
TEL: (01) 8232415

HUNGARY

Intermusica Ltd.
Warehouse Area 'DEPO' Pf.83
H-2046 Torokbalint, HUNGARY
TEL: (01) 1868905

IRELAND

The Dublin Service Centre
Audio Maintenance
Limited
11 Brunswick Place Dublin 2
Republic of IRELAND
TEL: (01) 677322

ITALY

Roland Italy S. p. A.
Viale delle Industrie, 8
20020 Aresse Milano, ITALY
TEL: (02) 93581311

NORWAY

Roland Scandinavia Adv.
Kontor Norge
Lillekerveien 2 Postboks 95
Lilleaker N-0216 Oslo
NORWAY
TEL: 273 0074

POLAND

P. P. H. Brzostowicz Marian
61-502 Poznan, ul. Filarecka 11,
TEL: (061) 332 665
03-624 Warszawa, ul. Blokowa32,
TEL: (02) 679 44 19

PORTUGAL

Caius - Tecnologias Audio e
Musica, Lda.
Rue de Catarina 131
4000 Porto, PORTUGAL
TEL: (02) 38 4456

RUSSIA

PETROSHOP
Vershavskoe, Shosse, 27-1
Moscow, RUSSIA
TEL: 095 901 0892

INVASK Limited

Lenina Str. 13-342
Krasnogorsk 143400
Moscow Region, RUSSIA
TEL: 095 564 61 44

SPAIN

Roland Electronics
de España, S. A.
Calle Bolivia 239 08020 Barcelona,
SPAIN
TEL: (93) 308 1000

SWEDEN

Roland Scandinavia A/S
Danvik Center 28 A, 2 tr.
S-131 30 Nacka SWEDEN
TEL: (08) 702 0020

SWITZERLAND

Roland (Switzerland) AG
Musitronic AG
Gerberstrasse 5, CH-4410 Liestal,
SWITZERLAND
TEL: (061) 921 1615

UNITED KINGDOM

Roland (U.K.) Ltd., Swansea
Office
Atlantic Close, Swansea
Enterprise Park SWANSEA
West Glamorgan SA7 9FJ,
UNITED KINGDOM
TEL: (01792) 702701

As of September, 4, 1995



For Europe

This product complies with the requirements of European Directive 89/336/EEC.

For the USA

FEDERAL COMMUNICATIONS COMMISSION RADIO FREQUENCY INTERFERENCE STATEMENT

This equipment has been tested and found to comply with the limits for a Class B digital device, pursuant to Part 15 of the FCC Rules. These limits are designed to provide reasonable protection against harmful interference in a residential installation. This equipment generates, uses, and can radiate radio frequency energy and, if not installed and used in accordance with the instructions, may cause harmful interference to radio communications. However, there is no guarantee that interference will not occur in a particular installation. If this equipment does cause harmful interference to radio or television reception, which can be determined by turning the equipment off and on, the user is encouraged to try to correct the interference by one or more of the following measures:

- Reorient or relocate the receiving antenna.
- Increase the separation between the equipment and receiver.
- Connect the equipment into an outlet on a circuit different from that to which the receiver is connected.
- Consult the dealer or an experienced radio/TV technician for help.

Unauthorized changes or modification to this system can void the users authority to operate this equipment.
This equipment requires shielded interface cables in order to meet FCC class B Limit.

For Canada

CLASS B NOTICE

This digital apparatus does not exceed the Class B limits for radio noise emissions set out in the Radio Interference Regulations of the Canadian Department of Communications.

CLASSE B AVIS

Cet appareil numérique ne dépasse pas les limites de la classe B au niveau des émissions de bruits radioélectriques fixés dans le Règlement des signaux parasites par le ministère canadien des Communications.

DEMO SONG LIST



No.	Composer	Song Title
1.	Frédéric Chopin	Valse No.1 "Grande valse brillante" op.18
2.	Frédéric Chopin	Valse No.7 op.64-2
3.	Frédéric Chopin	12 Etudes op.25-1 The shepherd boy
4.	Frédéric Chopin	Mazurka No.5 op.7-1
5.	Modest Petrovich Musorgsky	Tableaux d'une exposition-promenade
6.	Claude Achille Debussy	Children's corner-Doctor Gradus ad Parnassum
7.	Claude Achille Debussy	2 Arabesques No.1 E-dur
8.	Ludwig van Beethoven	Bagatelle "Für Elise" WoO.59
9.	Frédéric Chopin	Nocturne in E-flat Major op.9-2
10.	Wolfgang Amadeus Mozart	Sonate für Klavier No.11 K.331,"Turkischer Marsch"
11.	Frédéric Chopin	Valse No.6 "Petit chien" op.64-1
12.	Frédéric Chopin	Polonaise No.6 "Héroïque" op.53
13.	Frédéric Chopin	12 Etudes "Black keys" op.10-5
14.	Carl Czerny	Vienner Marsch
15.	Gabriel-Urbain Fauré	Dolly op.56-Berceuse
16.	Theodor Oesten	Dolly's Dreaming Awakening op.202-4
17.	Albert Ellmenreich	Spinnerlied op.14-4
18.	Johann Sebastian Bach	Aus dem zweiten Notenbuch der Anna Magdalena Bach,Menuett BWV.Anh.114
19.	Francois Joseph Gossec	Gavotte
20.	Wilma Anderson-Gilman	Battle of Waterloo
21.	Hermann Necke	Csikos post
22.	Ludwig van Beethoven	6 Menuette WoO.10 No.2 G-dur
23.	Robert Schumann	Album für die Jugend op.68 No.10 "Fröhlicher Landmann"

Roland®

70678590

UPC

70678590



1898

Roland®