

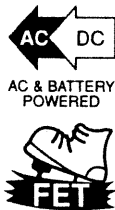

GEB-7 Bass Equalizer

Owner's Manual

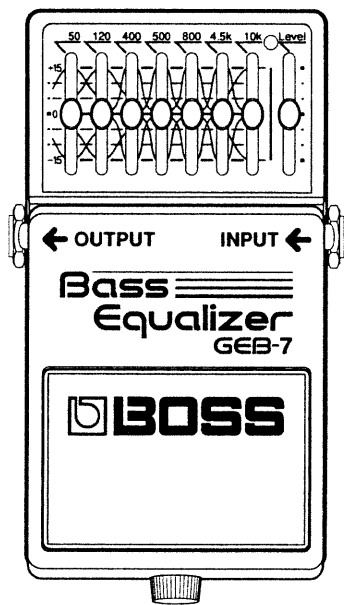

 **BOSS**

Thank you, and congratulations on your choice of BOSS GEB-7 Bass Equalizer. To ensure proper operation, and years of trouble-free service, please take the time to read through this Owner's Manual before starting out.

FEATURES

- The BOSS GEB-7 is a 7-band equalizer designed specifically for electric bass.
- Since it allows for a broad range of frequency settings, even five string basses can be accommodated.
- The unit is designed to provide the optimum Q (equalizer's bandwidth) for bass for each center frequency. While making it easy to obtain the most delicate of nuances, it also allows for radically unique settings as well.
- The GEB-7 allows you to adjust the output level of the equalized sound so it matches the level of the input sound.

©1995 BOSS Corporation

All right reserved. No part of this publication may be reproduced in any form without the written permission of BOSS Corporation.

2

IMPORTANT NOTES

When using an AC adaptor, use only the specified device (PSA Series). Use of any other AC adaptor could result in damage, malfunction or electric shock.

POWER SUPPLY

The power requirement for this unit is indicated on its nameplate (rear panel). Ensure that the voltage in your installation meets this requirement.

If the unit is to remain unused for an extended period of time, unplug the power cord.

PLACEMENT

Do not subject the unit to temperature extremes (eg., direct sunlight in an enclosed vehicle). Avoid using or storing the unit in dusty or humid areas, or areas that are subject to high levels of vibration.

ADDITIONAL PRECAUTIONS

Protect the unit from strong impact.

Should a malfunction occur, or if you suspect there is a problem, discontinue use immediately. Contact qualified service personnel as soon as possible.

To avoid the risk of electric shock, do not open the unit.

CHANGING BATTERY

Remove the battery whenever the unit is to remain unused for an extended period of time.

3

PANEL DESCRIPTIONS

1

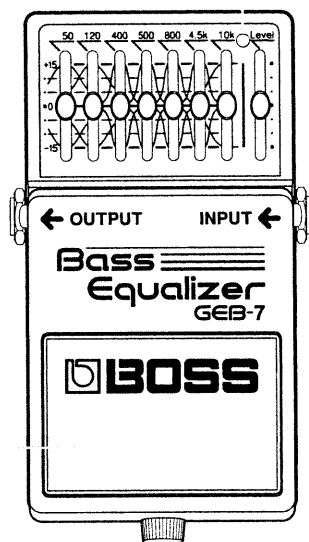

3

4

5

4

2

1. AC Adaptor Jack

Accepts connection of an AC Adaptor (optionally available BOSS PSA-Series). By using an AC Adaptor, you can play without being concerned about how much battery power you have left.

** You may find that it is a good idea to keep a battery installed in the unit even while using an adaptor. That way your playing won't be disrupted even if the adaptor is accidentally disconnected.*

** If you are going to use an AC adaptor, be sure to use the specified unit (BOSS PSA-Series). Use of any other adaptor may result in damage, malfunction or electric shock. Also, if you are not going to be using it for an extended period of time, disconnect the AC adaptor from the AC outlet.*

6

2. CHECK Indicator

This indicator shows whether an effect is ON/OFF, and also doubles as the Battery Check indicator.

The indicator lights when an effect is ON. If this indicator goes dim or no longer lights while an effect is ON, the battery is near exhaustion and should be replaced immediately.

3. OUTPUT Jack

The output jacks are used to connect the unit to amplifiers or other devices.

4. Pedal Switch

This switch turns the effects ON/OFF.

5. Thumbscrew

This thumbscrew is loosened to open the pedal, allowing battery replacement. For instructions on how to replace the battery, please refer to "CHANGING THE BATTERY".

6. INPUT Jack

This jack accepts input signals (coming from a bass guitar, some other musical instrument, or another effects unit).

** The INPUT jack also serves as the power switch. Power is turned on whenever a plug is inserted into the INPUT jack, and is turned off when the plug is disconnected. When not using the unit, you should disconnect any cord connected to the INPUT jack.*

Equalizer Control Knobs

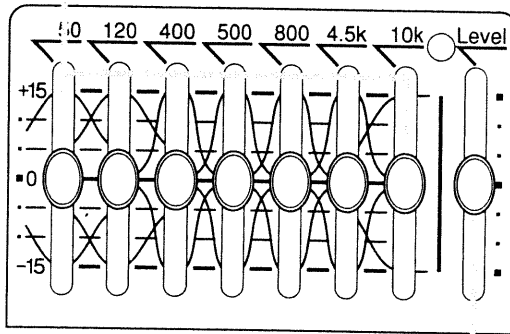

Level Control Knob

Equalizer Control knobs

These knobs allow you to boost or cut the center frequency of 50, 120, 400, 500, 800, 4.5 k or 10 kHz within +/-15 dB.

Level Control Knob

This knob allows you to adjust the output level of the effect sound to minimize the level difference between the effect and direct sounds.

6

MAKING THE CONNECTIONS

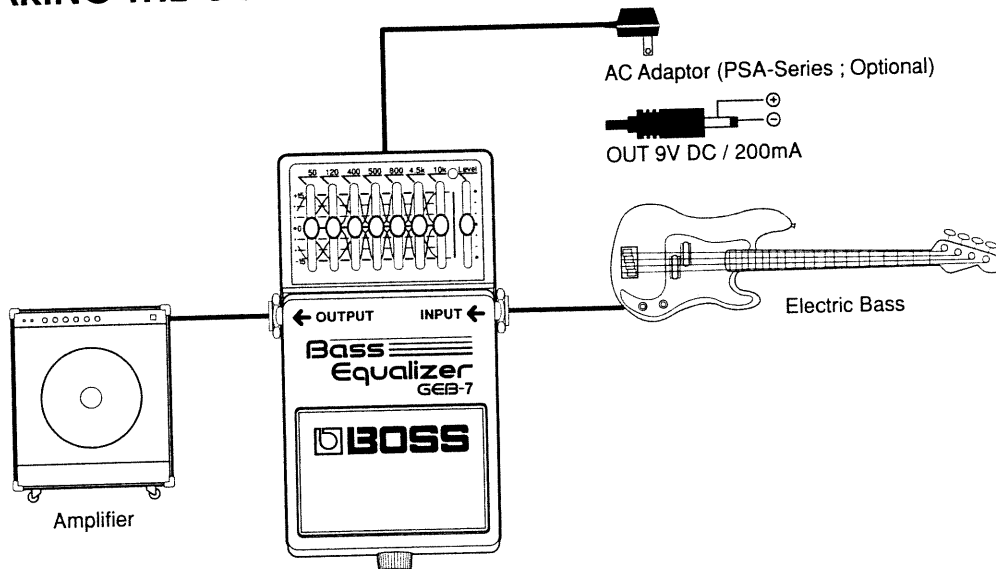

** Inserting a plug into the Input Jack will automatically switch the unit on.*

** Before connecting or disconnecting any patch cords, be sure all the volume controls in your system are set to minimum. This will help prevent any damage to system components.*

7

OPERATING THE UNIT

1. When you have made the necessary connections, set the knobs as shown in the illustration.
2. Depress the pedal switch to turn the effect on. (Make sure that the CHECK Indicator lights.)
3. Adjust the tone using the relevant Equalizer Control Knobs.

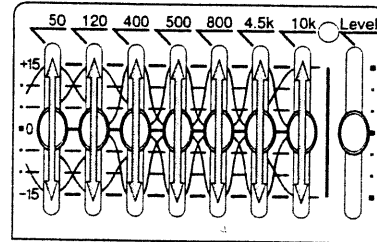
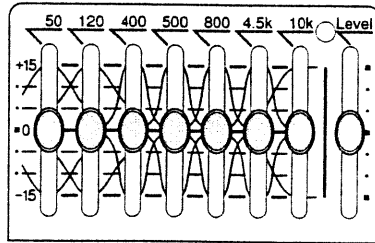

8

4. Adjust the output level using the Level Control Knob, to minimize the level difference between the effect and direct sounds.

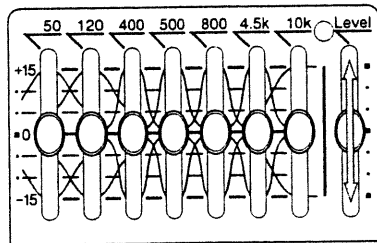

9

CHANGING THE BATTERY

When the indicator goes dim or no longer lights while an effect is on, it means that the battery is nearly dead and must be replaced. Replace the battery following the steps below.

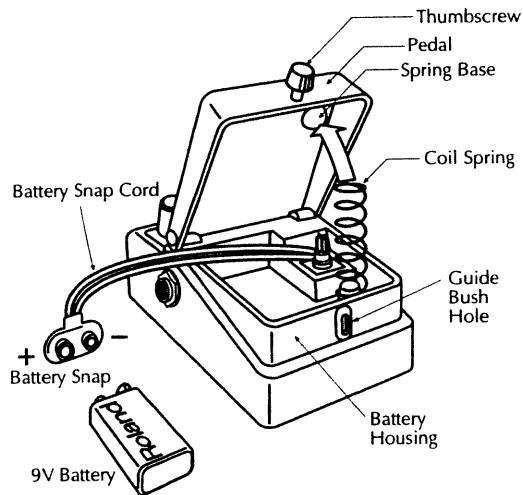

1. Loosen the thumbscrew at the front of the pedal, then lift the pedal upwards to open the unit.

** The thumbscrew can be left in the pedal while changing the battery.*

2. Remove the old battery from the battery housing, and remove the snap cord connected to it.

3. Connect the snap cord to the new battery, and place the battery inside the battery housing.

** Be sure to carefully observe the battery's polarity (+ versus -).*

4. Slip the coil spring onto the spring base on the back of the pedal, then close the pedal.

** Carefully avoid getting the snap cord caught in the coil spring.*

5. Finally, insert the thumbscrew into the guide bush hole and fasten it securely.

10

FREQUENCY RESPONSE

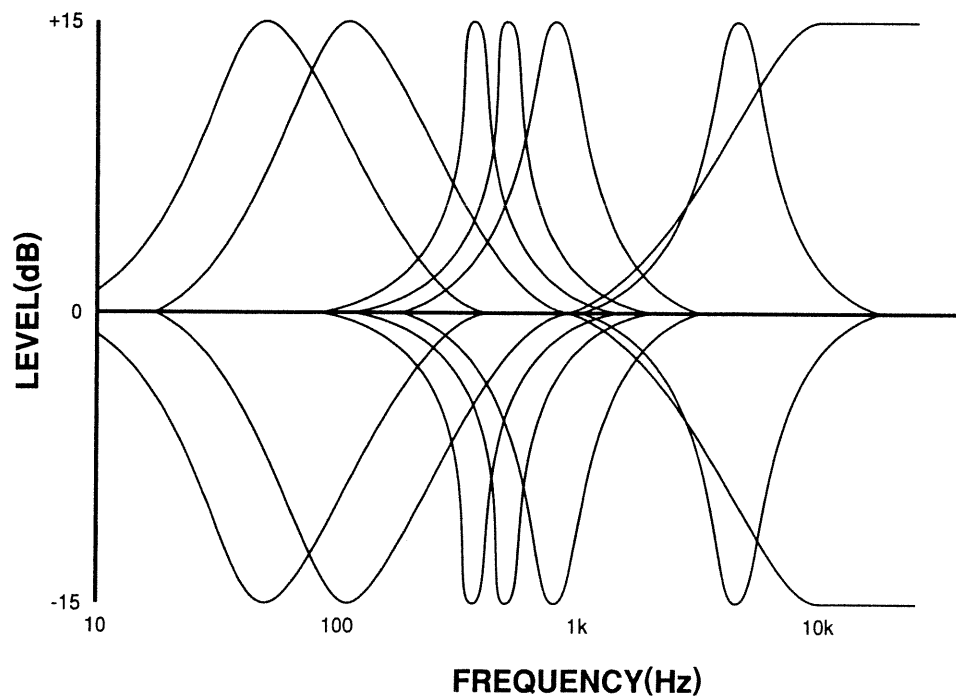

11

SAMPLE SETTING

Standard Rock

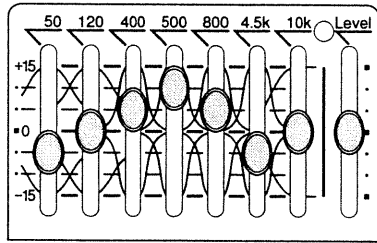

Heavy Metal

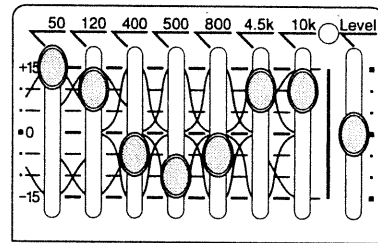

Slapping Play

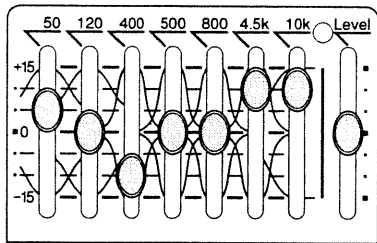

Bass Amplifier Simulation

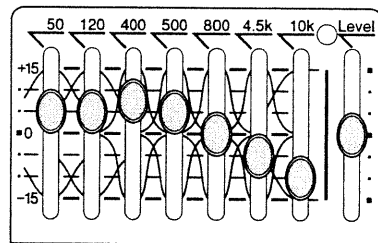

12

4

SETTING MEMO

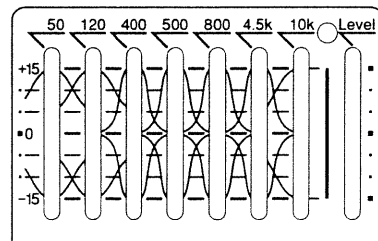
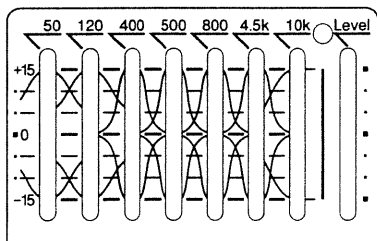
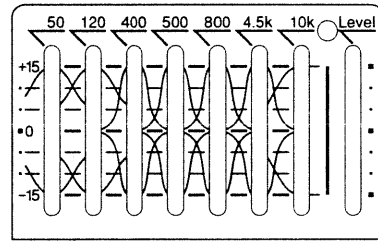
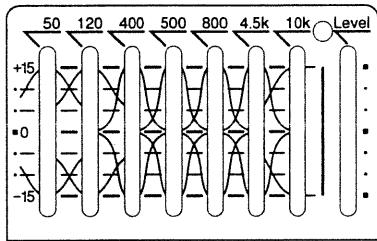

13

SPECIFICATIONS

GEB-7 : Bass Equalizer

Nominal Input Level	-20 dBm
Input Impedance	1 M Ω
Nominal Output Level	-20 dBm
Output Impedance	1 k Ω
Recommended Load Impedance ...	10 k Ω or greater
Residual Noise Level	-100 dBm (IHF-A, Typ.)
Variable Range	Equalizer Control : +/-15 dB Level Control : +/-15 dB
Controls	Pedal Switch, Equalizer Control Knobs (50, 120, 400, 500, 800, 4.5 k, 10 kHz), Level Control Knob
Indicator	CHECK Indicator (serves also as battery check indicator)
Connectors	INPUT Jack, OUTPUT Jack, AC Adaptor Jack (9 V DC)
Power Supply	9 V DC : Dry Battery 9 V type (6F22/9 V), AC Adaptor

14

Current Draw	16 mA (9 V DC) * Expected battery life under continuous use : Carbon : 12 hours These figures will vary depending on the actual conditions of use.
Dimensions	70 (W) x 125 (D) x 55 (H) mm 2-3/4 (W) x 4-15/16 (D) x 2-3/16 (H) inches
Weight	440 g / 1 lb (including battery)
Accessories	Owner's Manual, Dry Battery 9 V type (6F22/9 V)
Options	AC Adaptor PSA-Series

*** 0 dBm = 0.775 V rms**

*** In the interest of product development, the specifications and/or appearance of this unit are subject to change without prior notice.**

 **BOSS**

Printed in Taiwan '95-1-D3-11C

 Roland®

00679389

UPC

00679389

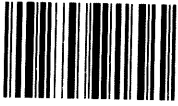

10961

 BOSS