	<b>CAUTION</b> RISK OF ELECTRIC SHOCK DO NOT OPEN	
<b>ATTENTION</b> : RISQUE DE CHOC ELECTRIQUE NE PAS OUVRIR		
<p><b>CAUTION:</b> TO REDUCE THE RISK OF ELECTRIC SHOCK, DO NOT REMOVE COVER (OR BACK). NO USER-SERVICEABLE PARTS INSIDE. REFER SERVICING TO QUALIFIED SERVICE PERSONNEL.</p>		



The lightning flash with arrowhead symbol, within an equilateral triangle, is intended to alert the user to the presence of un-insulated "dangerous voltage" within the product's enclosure that may be of sufficient magnitude to constitute a risk of electric shock to persons.



The exclamation point within an equilateral triangle is intended to alert the user to the presence of important operating and maintenance (servicing) instructions in the literature accompanying the product.

INSTRUCTIONS PERTAINING TO A RISK OF FIRE, ELECTRIC SHOCK, OR INJURY TO PERSONS.

## IMPORTANT SAFETY INSTRUCTIONS

**WARNING** — When using electric products, basic precautions should always be followed, including the following:

1. Read all the instructions before using the product.
2. Do not use this product near water — for example, near a bathtub, washbowl, kitchen sink, in a wet basement, or near a swimming pool, or the like.
3. This product should be used only with a cart or stand that is recommended by the manufacturer.
4. This product, either alone or in combination with an amplifier and headphones or speakers, may be capable of producing sound levels that could cause permanent hearing loss. Do not operate for a long period of time at a high volume level or at a level that is uncomfortable. If you experience any hearing loss or ringing in the ears, you should consult an audiologist.
5. The product should be located so that its location or position does not interfere with its proper ventilation.
6. The product should be located away from heat sources such as radiators, heat registers, or other products that produce heat.
7. Avoid using the product where it may be effected by dust.
8. The product should be connected to a power supply only of the type described in the operating instructions or as marked on the product.
9. The power-supply cord of the product should be unplugged from the outlet when left unused for a long period of time.
10. Do not tread on the power-supply cord.
11. Do not pull the cord but hold the plug when unplugging.
12. When setting up with any other instruments, the procedure should be followed in accordance with instruction manual.
13. Care should be taken so that objects do not fall and liquids are not spilled into the enclosure through openings.
14. The product should be serviced by qualified service personnel when:
  - A. The power-supply cord or the plug has been damaged; or
  - B. Objects have fallen, or liquid has been spilled into the product; or
  - C. The product has been exposed to rain; or
  - D. The product does not appear to operate normally or exhibits a marked change in performance; or
  - E. The product has been dropped, or the enclosure damaged.
15. Do not attempt to service the product beyond that described in the user-maintenance instructions. All other servicing should be referred to qualified service personnel.

## SAVE THESE INSTRUCTIONS

For the U.K.

**WARNING:** THIS APPARATUS MUST BE EARTHED

**IMPORTANT:** THE WIRES IN THIS MAINS LEAD ARE COLOURED IN ACCORDANCE WITH THE FOLLOWING CODE.  
GREEN-AND-YELLOW: EARTH, BLUE: NEUTRAL, BROWN: LIVE

As the colours of the wires in the mains lead of this apparatus may not correspond with the coloured markings identifying the terminals in your plug proceed as follows:

The wire which is coloured GREEN-AND-YELLOW must be connected to the terminal in the plug which is marked by the letter E or by the safety earth symbol  or coloured GREEN or GREEN-AND-YELLOW.

The wire which is coloured BLUE must be connected to the terminal which is marked with the letter N or coloured BLACK.

The wire which is coloured BROWN must be connected to the terminal which is marked with the letter L or coloured RED.

The product which is equipped with a THREE WIRE GROUNDING TYPE AC PLUG must be grounded.

## INTRODUCTION

Thank you for purchasing the Roland GC-8. The GC-8 has a display which helps you edit parameters and can control up to 16 R-880's. The data you have programmed can be written to the internal memory or on to a memory card. Read this owner's manual carefully to make the best use of the unit.

## CONTENTS

■ Panel Description .....	4	⑤ Editing Parameters .....	39
■ Important Notes .....	5	1. Reverb .....	43
■ Memory Card .....	7	a. Reverb (Stack Type) .....	43
■ Connections .....	8	b. Reverb (Tap Type) .....	51
■ Power-up .....	9	2. Plate .....	56
① How to Use this Owner's Manual .....	12	a. Plate (Stack Type) .....	56
② Outline of the System .....	13	b. Plate (Tap Type) .....	59
1. Overview of the R-880 .....	13	3. Non-linear .....	62
2. Overview of the GC-8 .....	15	4. Equalizer .....	66
3. Overview of the Procedures .....	17	5. Chorus .....	69
4. Outline of the Procedure .....	19	6. Delay .....	71
a. Menu Selections .....	19	7. Gate .....	72
b. Editing Procedure .....	21	8. Compressor .....	74
③ Factory Presets .....	23	⑦ Editing the Mixer .....	77
1. Before using the Presets .....	23	1. Input/Output Level .....	77
2. Calling the Presets .....	24	2. Internal Level .....	79
④ Overview of the Editing Functions .....	25	⑧ Memory .....	83
1. Displays and		1. Reading .....	85
Automatic Calculation .....	25	2. Copying .....	86
2. Help Display .....	26	3. Naming .....	86
⑤ Editing the Algorithm .....	27	4. Writing .....	88
1. R-880's Algorithm and Modes .....	27	5. Deleting .....	88
2. Mode Selection .....	28	6. Initializing a Memory Card .....	89
3. Editing Algorithm Data .....	31	7. Backup a Memory Card .....	89
a. Move (Selecting and		8. Protecting the Internal Memory .....	89
Locating the Units) .....	33	⑨ Other Useful Functions .....	90
b. Joint (Connecting the Units) .....	34	1. Program Change .....	90
		2. Controlling more than one R-880 .....	92
		3. Displaying the R-880's condition .....	94
		⑩ Error Messages .....	96
		■ GC-8 Parameter Map .....	98
		■ Specifications .....	100

Please read the separate "Guide Book for MIDI" before reading this owner's manual.

Copyright © 1988 by ROLAND CORPORATION

All rights reserved. No part of this publication may be reproduced in any form without the written permission of ROLAND CORPORATION.

# ■ PANEL DESCRIPTION

## <Front Panel>

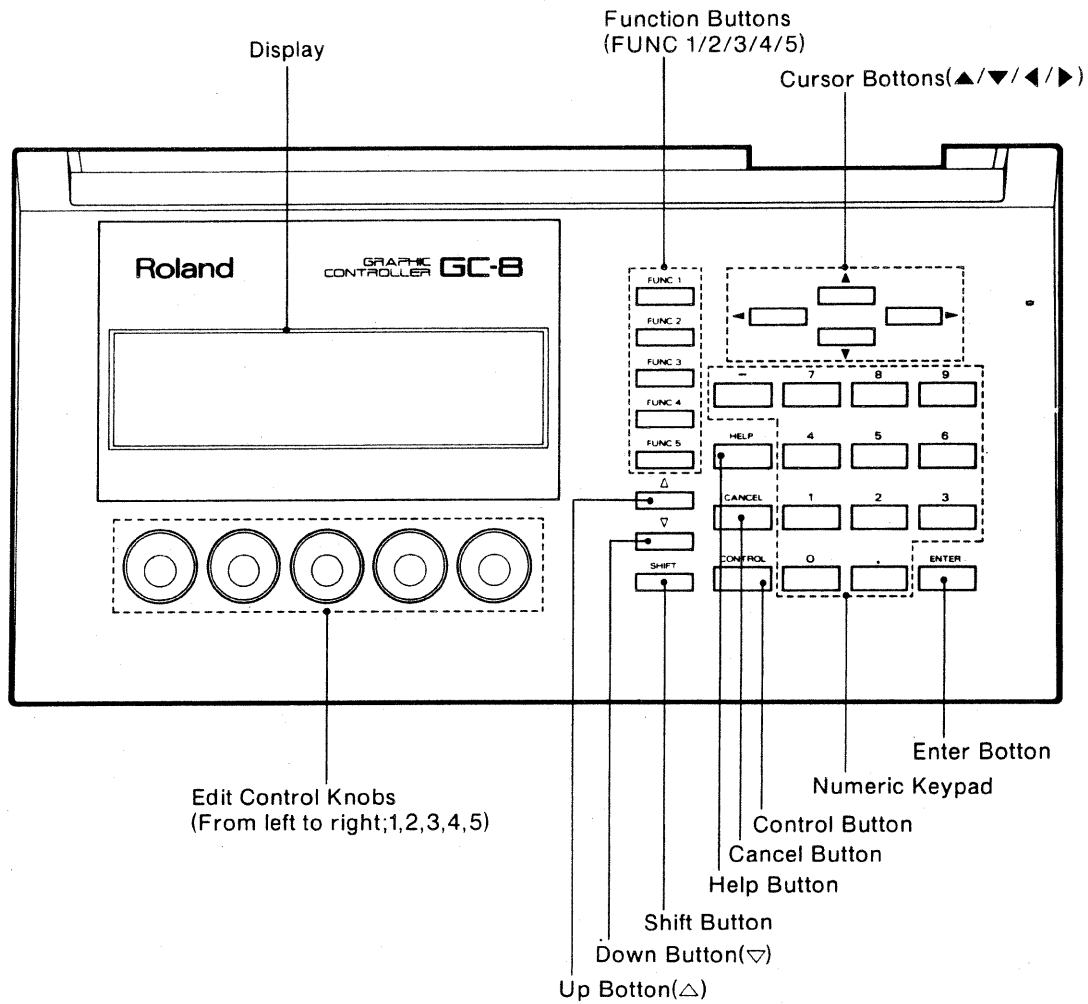

## <Rear Panel>

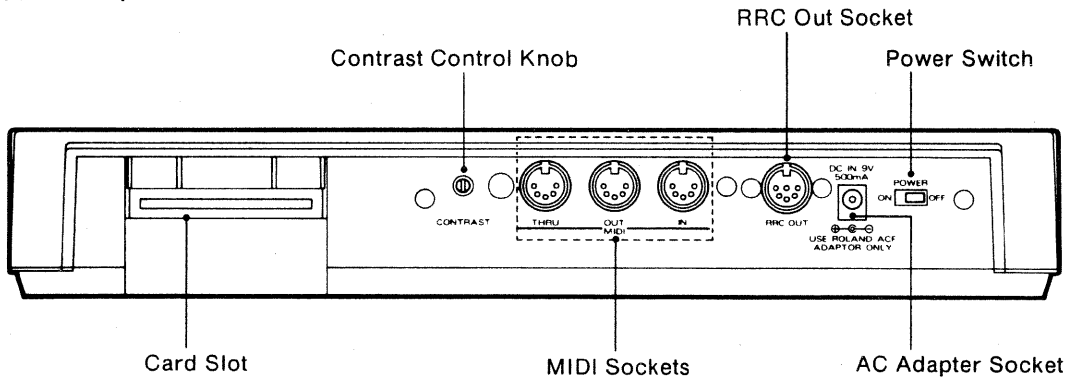



# ■ IMPORTANT NOTES

## ◇ Power Supply ◇

- Power is supplied to this unit through an RRC cable. If you do not have an RRC cable, use the AC adapter, ACF-120, 220 or 240, depending on the voltage system in your country. Using any other adaptor will cause troubles.
- Before setting up this GC-8 with other MIDI devices, turn this unit off along with all other units.

## ◇ AC Adapter ◇

- The appropriate power supply for this unit is shown on its name plate. Please make sure that the line voltage in your country meets the requirement.
- Do not use the same socket used for any noise generating device. (such as a motor or variable lighting system)
- Make sure that the unit is turned off before connecting the AC adapter to the socket.
- Connect the AC adapter to the AC adapter socket before connecting the power plug to the socket.
- When disconnecting the power plug from the socket, do not pull the cord but hold the plug to avoid damaging the cord.

- If the unit is not to be used for a long period of time, unplug the cord from the socket.

## ◇ Room Location ◇

- Avoid using this device in excessive heat or humidity conditions, or where it may be affected by direct sunlight or dust and avoid places subject to high vibration.
- Operating the unit near a neon light, fluorescent lamp, TV or CRT Display may cause noise interference. If so, change the angle or the position of the unit.

- Do not place or drop anything heavy on the main unit or its power cord.

## ◇ Cabinet Cleaning Care ◇

- For cleaning the unit, use a dry and soft cloth.
- Should the casing become dirty, use a cloth slightly dampened with water.
- To remove grime, clean the casing with a cloth moistened with a neutral detergent, then wipe it dry with a soft cloth.
- Do not use solvents such as paint thinner when cleaning.

◇ Memory Back Up System ◇

- This unit features a memory back-up system that retains the data even after switched off. The battery that supports the back-up circuit should be replaced every five years. Call the Roland service station for a battery replacement. (The first replacement may be required before five years, depending on how much time had passed before you purchased the unit.)
  
- When the battery is low, the Display defaults as shown below, and the data in the memory may be lost.  
"Change the memory backup battery"
  
- Although we do our utmost to protect your data during repairs, sometimes, especially when working on the memory itself or on a related area, some of your important data may be lost. Keep a separate record of all the data that you consider important. This can be done by saving it on to a Memory Card or by writing it down on a sheet of paper.

# ■ Memory Card

When using a memory card, securely connect it into the Card Slot in the correct direction.

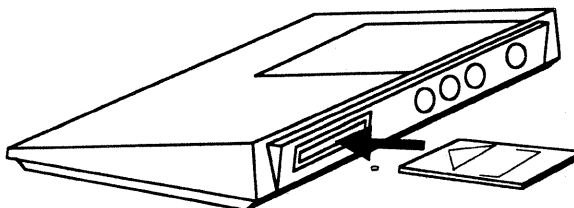

The supplied System Card contains the system program that allows the GC-8 to control the R-880, and also the factory presets.

The optional memory cards M-128D and M-256D (E) can be used for saving data.

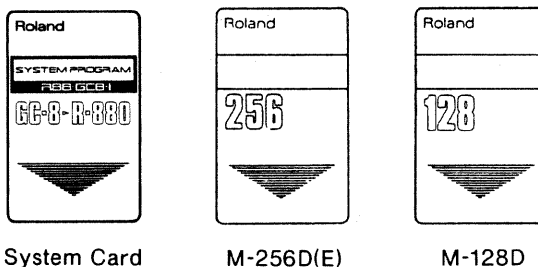

System Card

M-256D(E)

M-128D

- \* The System Card is needed every time the unit is switched on.
- \* No data can be saved onto the System Card.
- \* Use only the specified memory card, M-128D or M-256D (E).

## Protect Switch

The memory cards, M-128D and M-256D (E) have Protect Switches to protect data from accidental erasure or overwriting. When this switch is set to ON, data will not be erased by any means. Be sure to set this to ON except when you wish to write new data.

# ■ CONNECTIONS

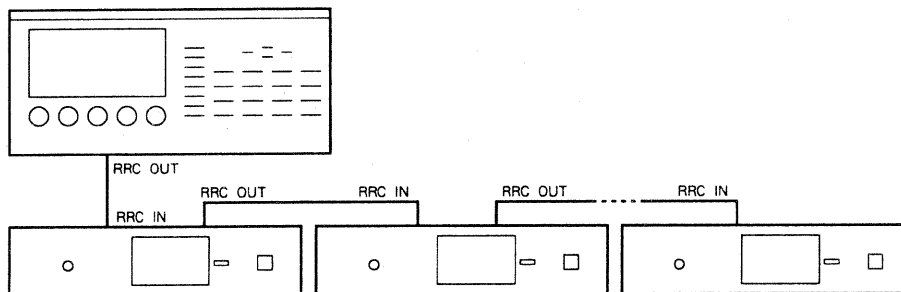
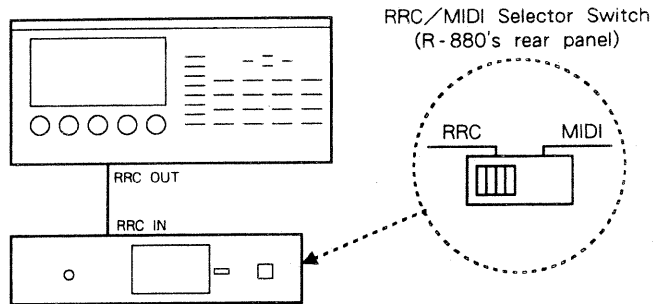

**\*When using more than one R-880, be sure to set the MIDI channel of all the R-880 to different numbers.**

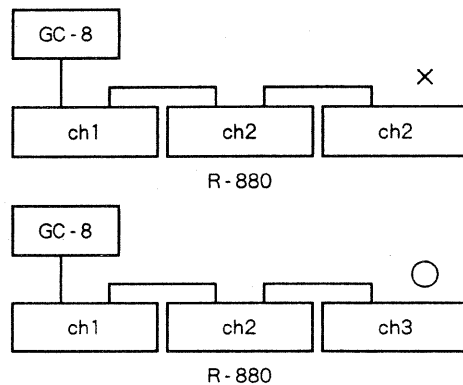

**\*When connecting the GC-8 to the R-880 using an RRC cable, you do not need to use an AC adapter with the GC-8.**

**\*When the GC-8 is connected to the R-880 with an RRC cable, set the MIDI/RRC Selector Switch (on the rear of the R-880) to the RRC position.**

**\*If you wish to know how to connect the R-880 with other devices, read the R-880's owner's manual.**

# ■ POWER - UP

To activate the GC-8 as a controller, the System Card is needed.

Make sure that the GC-8 is connected with the R-880 correctly.

**Step 1** Insert the System Card into the Card Slot.

**Step 2** Switch the R-880 on, then the GC-8.

The Display responds as shown below.

```
GC-8 Graphic controller
GC-8 version 1.01
Copyright(C) 1988 Roland Corp.

R-880 Graphic controller version 2.00
Copyright(C) 1988,1989,1990 Roland Corp.
```

Once the GC-8 has been switched on, you may remove the System Card. However, when you wish to use the Factory Presets which are stored on the System Card, you will naturally need to insert it again.

Using the Contrast Control Knob on the rear of the unit, you can adjust the contrast of the Display.

\*When more than one R-880 is being connected, switch on all the R-880's first, then the GC-8.

When the GC-8 cannot communicate with the R-880, the Display will respond with :

```
GC-8 Graphic controller

R-880 Graphic controller version 2.00
Copyright(C) 1988,1989,1990 Roland Corp.
Can not communicate with R-880
Continue ? (Yes:CONTROL)
```

■ POWER-UP

If this happens, switch all the units off, check the connections, then switch the units on.

Pressing **CONTROL** allows you to edit parameters, but does not allow control of the R-880.

- If you change MIDI channels of the R-880 while it is operating, the Display will respond with :

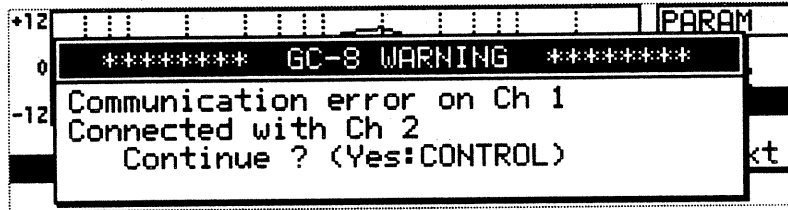

This shows that the R-880 cannot be controlled. Press **CONTROL** to resolve it.

# HOW TO USE THIS OWNER'S MANUAL

**1 How to Use this Owner's Manual P.12**

**2 Outline of the System P.13**

**3 Factory Presets P.23**

**4 Overview of the Editing Functions P.25**

**5 Editing the Algorithm P.27**

**6 Editing Parameters P.39**

**7 Editing the Mixer P.77**

**8 Memory P.83**

**9 Other Useful Functions P.90**

**10 Error Messages P.96**

# ① HOW TO USE THIS OWNER'S MANUAL

This owner's manual consists of the following explanations.

## ② Outline of the System

This chapter explains the functions and concept of the GC-8 and R-880.

## ③ Factory Presets

This chapter shows you how to call and use the Factory Presets.

## ④ Overview of the Editing Procedures

This explains each editing function and how to perform it.

## ⑤ Editing the Algorithm

This explains Algorithm data and how to set it.

## ⑥ Editing Parameters

This describes how to edit Parameters.

## ⑦ Editing the Mixer

This explains how to set the input/output level or effect balance, etc.

## ⑧ Memory

This describes about the memory function and how to use it.

## ⑨ Other Useful Functions

This explains how to control the GC-8 via MIDI, how to control more than one R-880 with the GC-8, etc.

## ⑩ Error Messages

This explains how to resolve the error messages.



# 2 OUTLINE OF THE SYSTEM

The GC-8 is a remote controller for the R-880, a digital reverb. The following is the overview of the R-880 and GC-8.

## 1. Overview of the R-880

The R-880 is a digital reverb unit featuring two inputs and four outputs. It can create various high quality effects such as reverberations, non-linear, delay, equalizer, chorus, compressor, etc.

The R-880 contains two types of Effect Blocks as shown below.

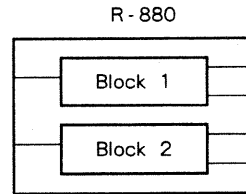

These two Effect Blocks are independent of each other, therefore, for instance, a reverb and the non-linear effects can be obtained on an R-880 at the same time.

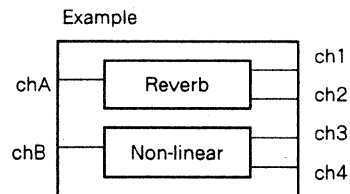

Also, by using two Units at the same time, even better-quality effect can be obtained.

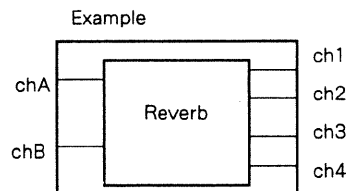

Each Effect Block consists of the Units as shown below.

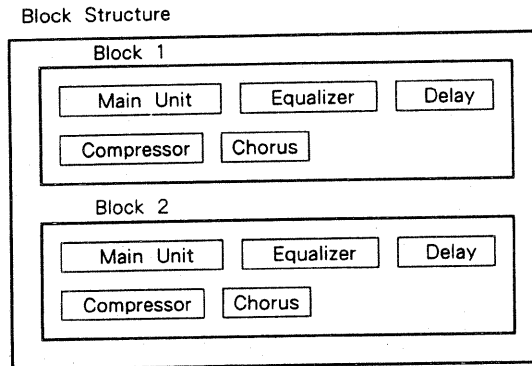

That is, one R-880 contains two sets of all the Units (e.g. equalizer, chorus).

The Main Unit is the most important unit, that creating reverb and non-linear, etc. How the Main Unit works varies depending on the current Mode setting as shown below.

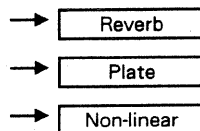

Normally, each Unit works independently in the Effect Block it belongs to, but it is also possible to arrange Units and use them in any combination you like.

The Input Sockets, ChA and ChB, and the Output Sockets, Ch1, Ch2, Ch3 and Ch4 can be connected to any Unit.

The Mode settings of the Main Unit, connections of the external effect units, etc. are called "**Algorithms**".

## 2. Overview of the GC - 8

The GC-8 allows you to perform operations visually on the Graphic Display.

### ● Menu Selection

Procedures related with the same function are arranged within a display. To call a display, simply use the buttons to make your selection from the menu.

### ● Display Access

Some procedures (such as for editing Parameters) are arranged in a tiered system of Displays. You may select the Display that suits your requirement in terms of precision.

### ● Parameter's Automatic Calculation

An effect unit with more functions uses more parameters, requiring more complicated procedures. The GC-8, to release you from the complicated work, features the Automatic Calculation system for Parameters. For instance, only five parameters need programming for reverb effects, the GC-8 automatically calculates other parameters and controls the R-880. So, you can quickly and easily proceed with editing. If you like, you can later edit the Auto-calculated parameters or set all the parameter manually from scratch.

The GC-8 has five main functions which we call "Modes" in this manual.

#### [ALG] Algorithm Mode

This mode sets the R-880's Algorithm data.

#### [PARAM] Parameter Mode

This mode edits the R-880's Parameters.

#### [MIXER] Mixer Mode

This mode sets the R-880's input/output level, etc.

#### [FUNC] Function Mode

This mode changes the GC-8's settings such as MIDI and R-880's controlling conditions.

### [MEMORY] Memory Mode

This allows you to perform procedures related with memory, such as reading/writing or naming, both into the internal memory or onto a memory card.

Each Mode has various displays :

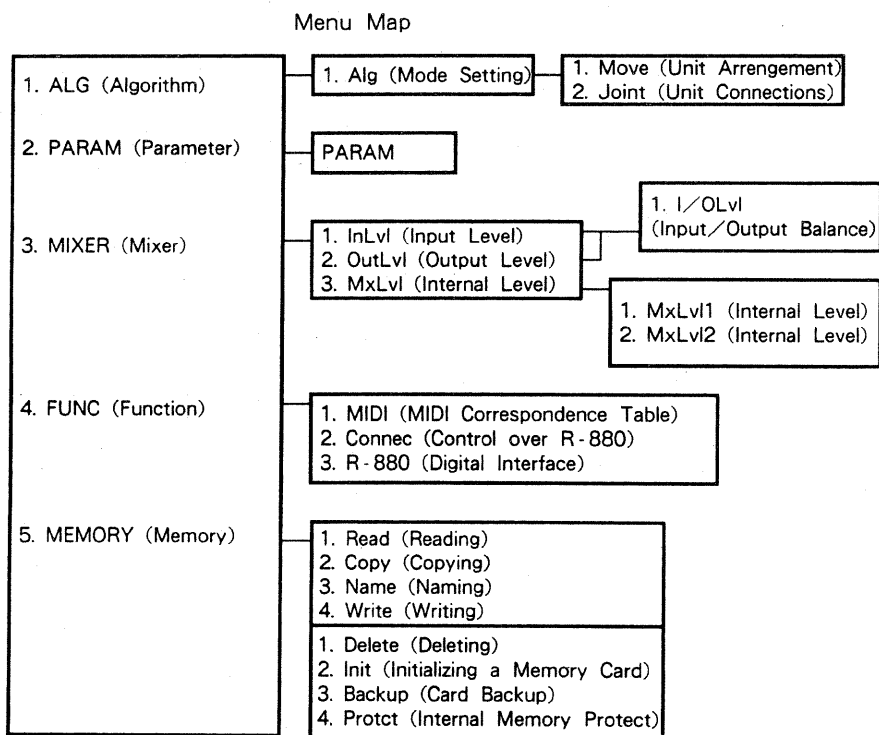

Select the relevant display and edit the parameters.

\*The Menu Map of the parameters (PARAM) changes depending on the Algorithm setting. See page 39 "[6] Editing Parameters".

### 3. Overview of the Procedures

The following picture shows the overview of the basic procedures.

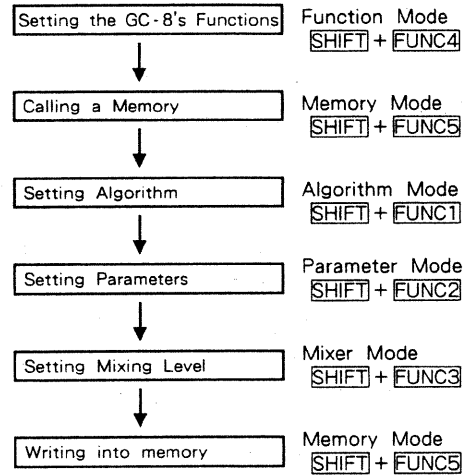

\* You can skip unnecessary procedures.

**(Ex. 1) To use a Factory Preset**

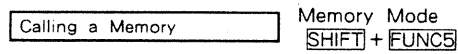

To use a Factory Preset or the program you have written in memory, simply call it from memory.

**(Ex. 2) To edit a Factory Preset**

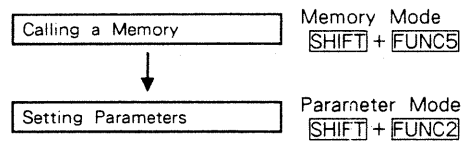

If you wish to edit a Factory Preset, call the Factory Preset you wish to edit, select the Parameter mode, then edit the relevant parameters.

(Ex. 3) To make new data from scratch

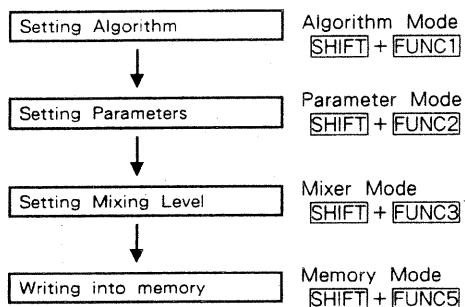

To program from scratch, you must start from Algorithm setting. This is because the structure of the displays in the Parameter mode changes if the Modes on the Main Unit are altered.

Then choose an effect to be used, and edit the relevant Parameters. Meanwhile, you can set the effect balance and the input/output level in the Mixer mode.

Finally, write the programmed data into memory.

## 4. Outline of the Procedure

### a. Menu Selections

To change Modes, first press **SHIFT**.

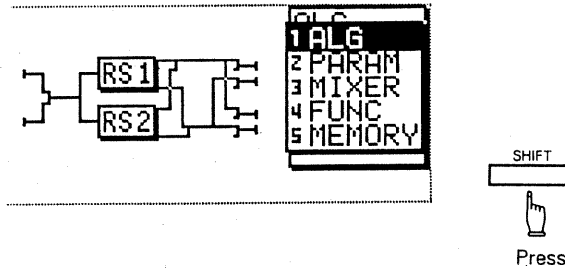

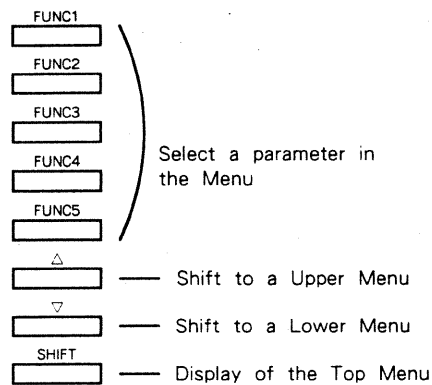

At the right of the Display, the Top Menu appears showing the Mode section. Here, press the Function button (FUNC1 – 5) while holding **SHIFT**, and you can move to the Mode that corresponds to the number.

To select or shift the display, use the eight buttons located at the right of the Display.

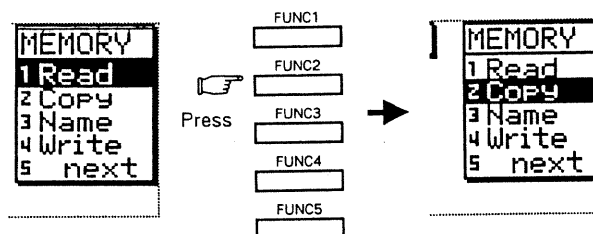

Pressing the Function button will shift to the display of the parameter that corresponds to the number shown in the menu; the selected parameter is displayed in reverse.



In the Algorithm, Parameter or Mixer mode, pressing  or  shifts to the upper (simpler) or lower (more complicated) display.

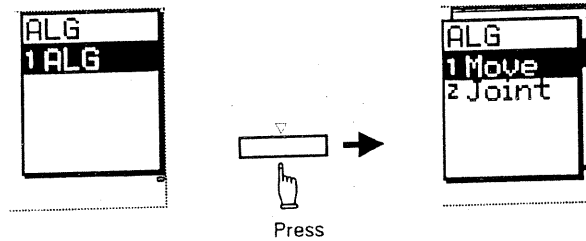

Upper displays contain less parameters, and the value settings are easier, while the lower displays contain more parameters, requiring more complicated settings.

The GC-8 has the Auto-Calculating function that automatically sets the finer parameters to standard values in upper displays. This releases you from the complicated work of setting each parameter one by one. The auto-calculated parameters can be monitored, or edited in the lower displays. So, you are able to edit parameters roughly in upper displays, then finely edit them in the lower displays.



## b. Editing Procedure

The GC-8 provides many different displays. Most often, the editing procedures are similar, though there are some exceptional cases.

- Use the five Edit Control Knobs for editing.

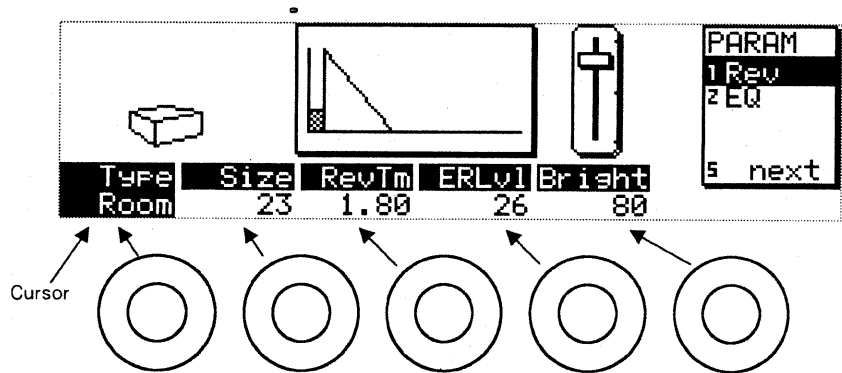



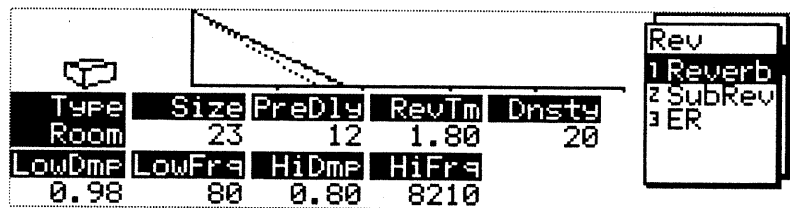

The parameters shown in the Display correspond to the Edit Control Knobs, from left to right.

- When the parameters take more than one line, the line where the cursor is positioned can be edited.



The cursor position is reversed in the Display.

- The cursor can be shifted with the Cursor buttons.  
 (     ).

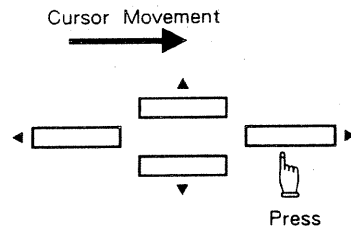
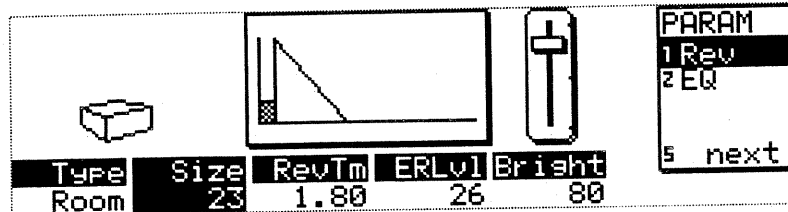

If you wish to edit the parameter in a different line, move the cursor to that line first.

- The parameter of the cursor position can be edited with the Numeric Keypad (if the value is represented with a number).

While entering a value with the Numeric Keypad, the cursor flashes. Be sure to press **ENTER** when you have entered the value.

- To quicken the changes of values, hold **SHIFT** down while using the Edit Control Knobs.

# 3 FACTORY PRESETS

## 1. Before using the Presets

The R-880 features two inputs (A, B) and four outputs (1, 2, 3, 4). How these sockets are connected to the built-in signal processors can be set in the Input/Output Mode. There are two modes for each Input and Output.

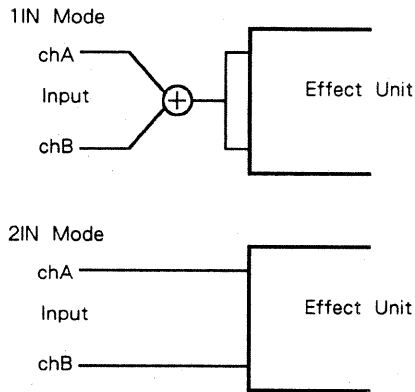

### Input Modes

- 1 IN : Inputs from Input A and B are mixed.
- 2 IN : Inputs from Input A and B are individually processed.

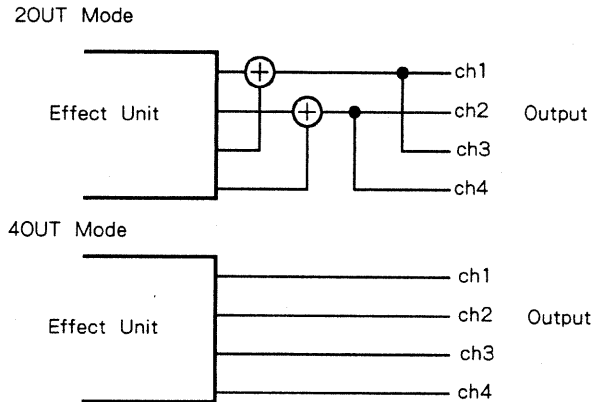

### Output Modes

- 2 OUT : Outputs from 1 and 3 are exactly the same signal, and also outputs from 2 and 4.
- 4 OUT : Outputs 1, 2, 3 and 4 send different signals.

A Factory Preset indicates the name of the Input/Output mode, such as "2-4 Large Hall". Select the mode you like. Also, any mode combination can be used for the R-880's sockets.

## 2. Calling the Presets

The supplied System Card contains the Factory Presets as well as the system program that activates the GC-8. If you wish to use a Factory Preset, do as follows.

**Step 1** Insert the System Card into the Card Slot.

**Step 2** Press **FUNC5** while holding **SHIFT** down, to call the Memory Display.

**Step 3** Press **FUNC1** to select "Read".  
(Should "Read" not appear, press **FUNC5** : (next).)

**Step 4** Rotate Edit Control Knob 1 until "Int" changes to "Card".

**Step 5** Rotate Edit Control Knob 2 to shift the cursor to the Preset you wish to call, then press **ENTER**.

\*If you know the number of the Preset, you can call it by entering the number with the Numeric Keypad then pressing **ENTER**.

# ④ OVERVIEW OF THE EDITING FUNCTIONS

## FUNCTIONS

### 1. Displays and the Automatic Calculation

The Algorithm, Parameter and Mixer Modes have displays of different levels. Upper displays contain less parameters, while lower displays contain more parameters. Using this system and the Automatic Calculating function, you can quickly make a desired setting. The following example edits the Reverb, to show you the display system and Automatic Calculating function.

The Reverb editing uses three level displays, an upper and a lower display. (Turn to Mode 2 [PARAM], then select "REV1" or "REV2".)

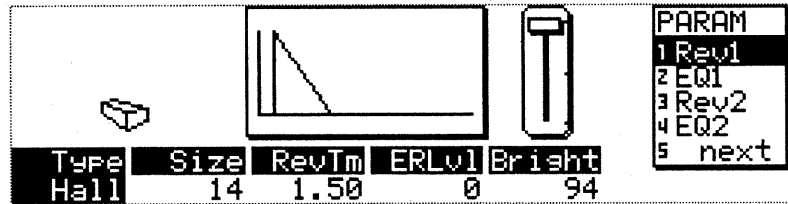

In the upper display, a standard setting is worked out with Automatic Calculating function using only five parameters ; Type, Size, RevTm, ERLvl and Bright.

Pressing  shifts to the lower display where finer parameters are shown.

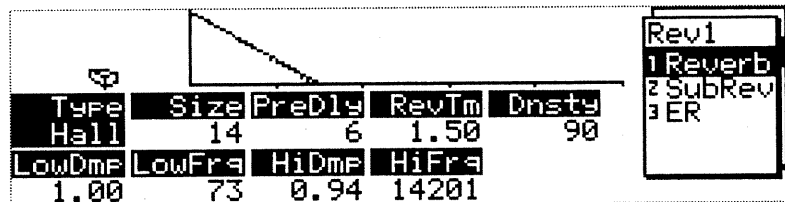

You may edit the parameters which are set to the standard values. It is also possible to set all the parameters in the lower display from scratch.

When you have edited parameters in the lower display, you should be careful not to change the parameters in the upper display. This is because the edited values in the lower display will be returned to the standard values if you make any editing in the upper display.

To check if any editing has been done in the lower display, use the Help display. (See the next chapter.)

## 2. Help Display

Press **HELP** to call the Menu Map.

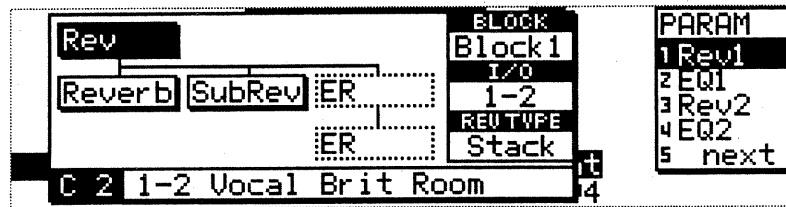

The current editing display is reversed on the map. When the editing function has upper or lower displays, an already edited display is shown with a solid line and the one not yet edited, with a dotted line.

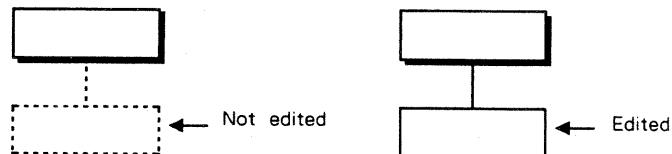

# 5 EDITING THE ALGORITHM

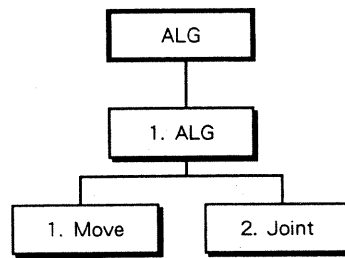

## 1. R-880's Algorithm and Modes

The Algorithm consists of

- (1) **Mode of the Main Unit**
- (2) **Connections of the Units**

The R-880 has two sets of the Main Units which feature main functions and another two sets of the Effect Units (e.g. chorus, equalizer, compressor) which feature additional functions.

The Main Units have the following Modes :

Unit 1	Unit 2
Reverb	Reverb
Plate	Plate
NLR	NLR
	sync

### sync Mode

The "sync" Algorithm of Unit 2 syncs to Unit 1. When Unit 1 is Reverb, it becomes Reverb, and if it is NLR, it becomes NLR.

However,

**Unit 1 Reverb**  
**Unit 2 Reverb**

and

**Unit 1 Reverb**  
**Unit 2 sync**

will result in different functions.

When both Units are set to "Reverb", the parameters can be edited independently of each other, while when unit 2 is set to "sync", editing either parameter will change both parameters. Also, in the sync Mode, two Units work at the same time to create one effect, increasing the quality of the effect.

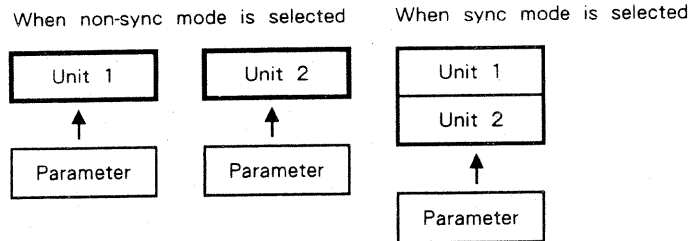

## 2. Mode Selection

Set the basic Mode of the R-880

Step 1 While holding **SHIFT**, press **FUNC1** to select the Algorithm Mode.

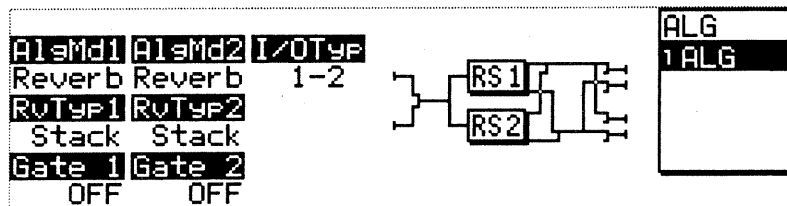

\* If the Display does not respond as above, press **△**.

Step 2 Using the Cursor buttons, move the cursor to the line which contains the parameter to be edited, then adjust the value with Edit Control Knobs 1 to 3.

Step 3 Press **CONTROL** to activate the edited value. The R-880 is not affected by the new setting unless **CONTROL** is pressed.

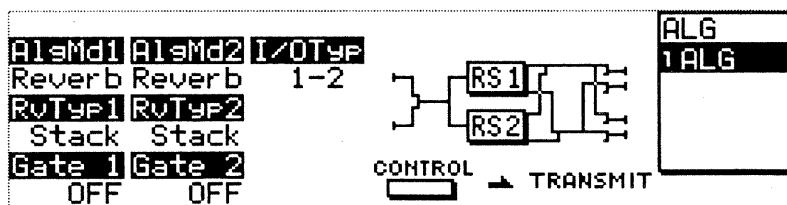



● **Algorithm Mode**  
(AlgMd1, AlgMd2)

This sets the basic Mode of the R-880. Select Rev, Plate or NLR. Only AlgMd2 contains and allows you to select "sync" which makes Unit 2 sync to Unit 1.

● **Reverb Type**  
(RvTyp1, RvTyp2)

When the Algorithm Mode is set to Rev or Plate, this selects the type of the reverb effect, Stack or Tap.

○ **Stack Type**

Realistic reverberation of a hall or room is obtained.

○ **Tap Type**

Reverberation deeper than the stack type is obtained. The reverb lasts longer.

● **Gate Mode**  
(Gate1, Gate2)

When the Algorithm Mode is set to Rev or Plate, Gate effect A or B can be added.

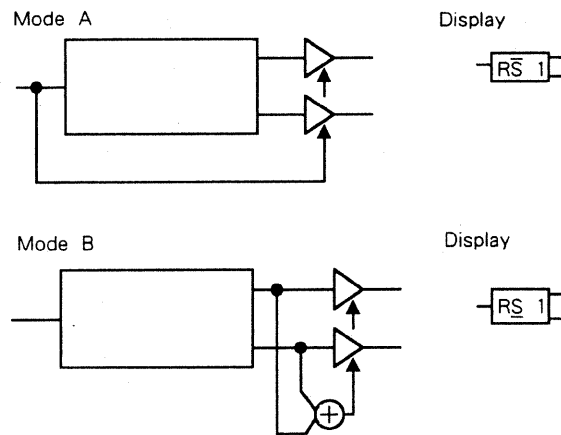

\*In this display, setting the Mode will automatically return the connections between the input/output sockets and units to the standard setting, and therefore will erase the edited data in the lower displays.

5 EDITING THE ALGORITHM

If the Algorithm data has been edited in the lower displays, "modify" will appear in the Display as shown below.

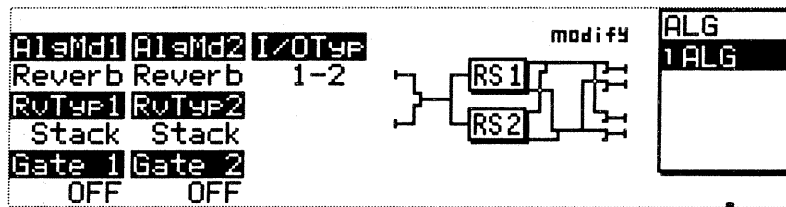

In the case, the unit stops by moving a knob, displaying the following message.

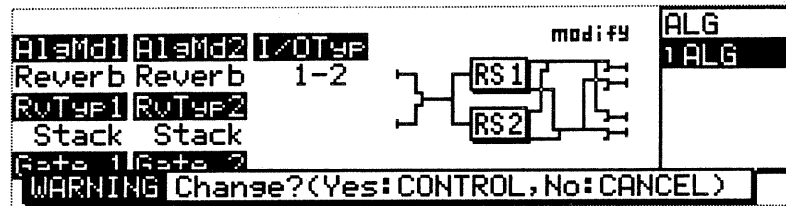

This is for preventing accidental erasure of the algorithm set in a lower display.

To rewrite it, press **CONTROL** .

To retain it, press **CANCEL** .

### 3. Editing the Algorithm Data

The Algorithm mode consists of three displays (of upper and lower levels).

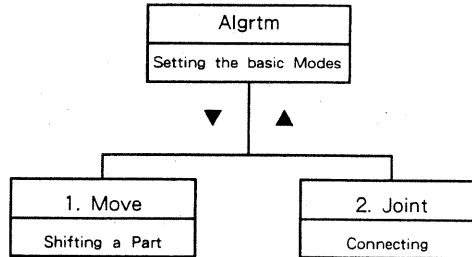

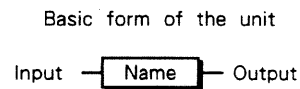

In the lower two displays, the Algorithm data set in the upper display can be edited in detail. Completely new Algorithm data which cannot be set in the upper display can be created as well.

In the lower display, you select, locate and connect the Units (the basic elements of effects), to determine how the signals should flow.

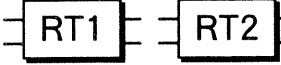
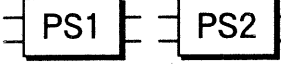
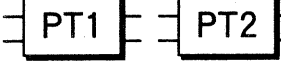
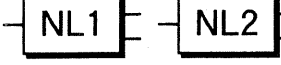
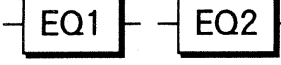
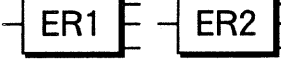
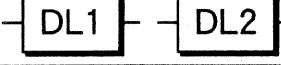
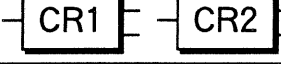
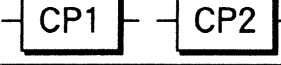
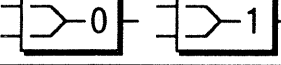

Each Unit is provided with 1 to 3 input/output sockets and named to show its function.

Unit Table

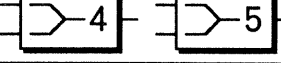
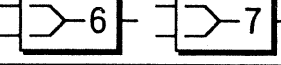
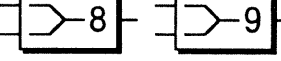
Display	Description
	Reverb Unit (Stack Type)
	Reverb Unit (Tap Type)
	Plate Unit (Stack Type)
	Plate Unit (Tap Type)
	Non-linear Unit
	3-band Equalizer
	Early Reflection Unit
	Delay Unit
	Chorus Unit
	Compressor Unit
	Mixer Unit
	
	
	
	

\*The Units shown here cannot always be used. They may not be valid depending on the Mode selected.

a. Move (Selecting and Locating the Units)

Step 1 Press **FUNC1** while holding **SHIFT** down, to select the Algorithm Mode.

Step 2 Press **▽** to shift to the lower display.

Step 3 Press **FUNC1** to select "Move".

Selector Display (example)

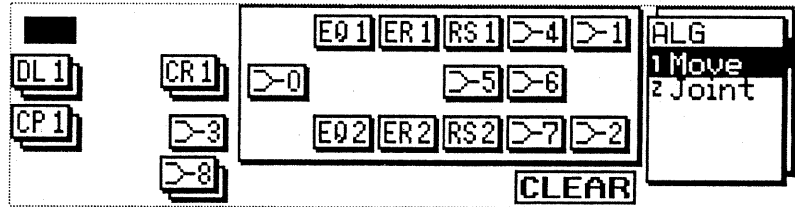

Step 4 Move the cursor to the Unit which you wish to relocate, then press **ENTER**.

The cursor will change as shown below :

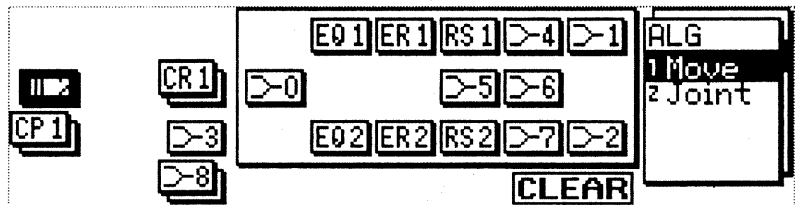

Step 5 Move the cursor to the destination position, then press **ENTER**.

The cursor will return to its original shape, and the Unit is relocated.

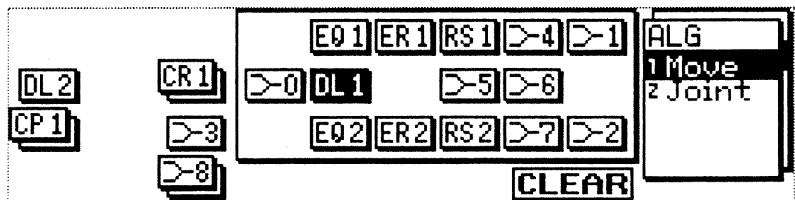

\*To set all the Units to the unused condition, move the cursor to "CLEAR", then press **ENTER**.

### b. Joint (Connecting the Units)

In the Joint display, you can connect the Units you have located in the Move display to each other and to the Input/Output Sockets. This them froms an "Algorithm".

Step 1 Press **FUNC1** while holding **SHIFT** down, to select the Algorithm Mode.

Step 2 Press **▽** to shift to the lower display.

Step 3 Press **FUNC2** to select "Joint".

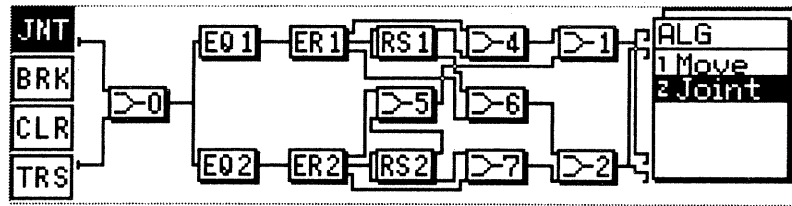

Step 4 Move the cursor to any of the Menus at the left of the Display, then press **CONTROL**. Then take the following procedure :

**JNT** Connect the Units with each other.

Small flashing cursor appears.

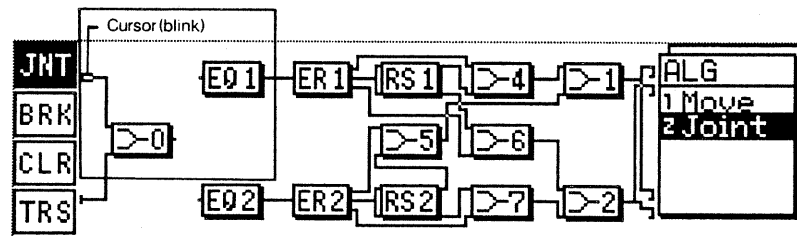

Move this flashing cursor to one of the points to be connected.

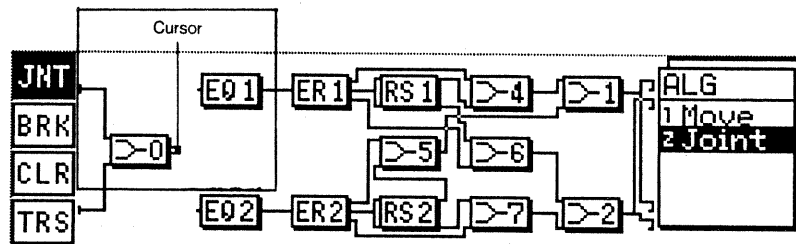

Press **ENTER**.

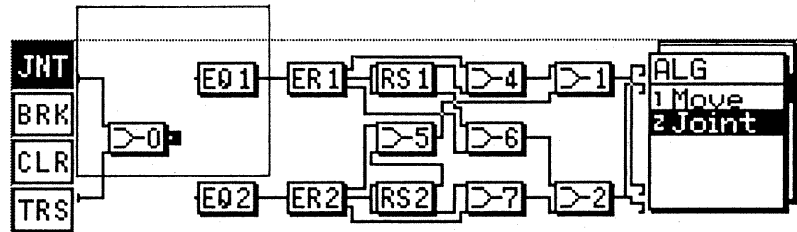

Move the cursor to another point.

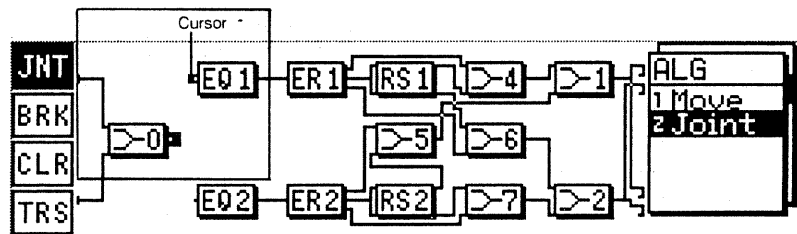

Press **ENTER** again, and the two points are connected.

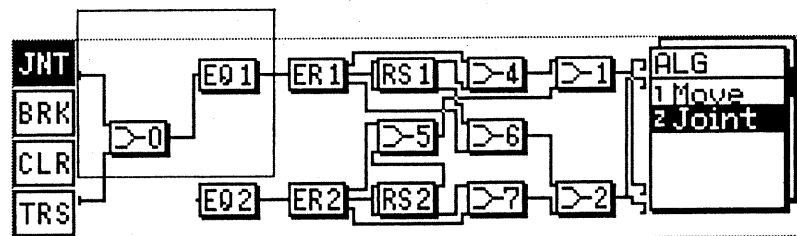

\*The connection can only be made between an input and output. It is not possible to connect an input to another input or an output to another output.

The Input and Output Sockets of the R-880 are shown as follows :

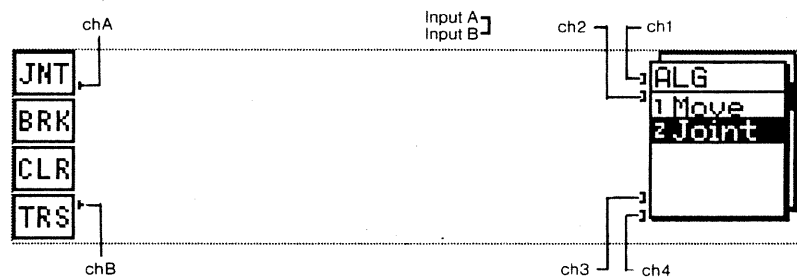

Each of the Output sockets (CH1 to CH4) has two inputs, A and B which are mixed and output.

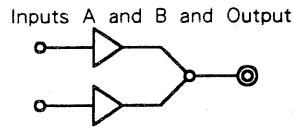

To leave the Joint Mode, press **CONTROL**.

\*When the Algorithm data is too complicated to be shown with full lines, lighter lines will be used for new data. In this case, however, two lines may be overlapped. Be careful.

**BRK** Cancel each connection.  
Each connection can be cleared using the same method as **JOINT**.

**CLR** Cancels all connections.  
All connections between Units can be cancelled.

Operation Example

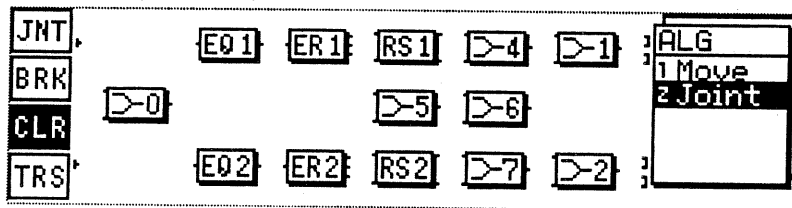

**TRS** The Joint data is transferred to the R-880.  
The R-880 is not affected by the edited data until the data is transferred to the R-880 with the TRS procedure. Be sure to take the TRS procedure when you have completed the Joint setting.



If you try to move to a different display without taking the transfer procedure, the unit stops immediately and display the following message.

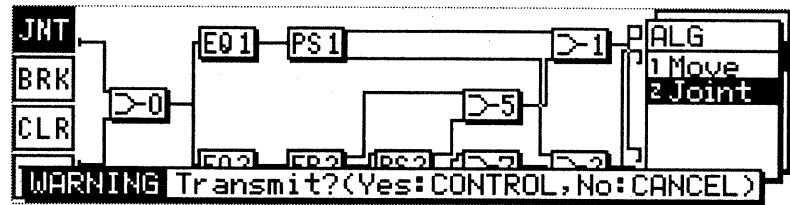

Here, pressing **CONTROL** will transfer the data to the R-880 then shift the display.

Pressing **CANCEL** will shift the display without transfer.

**(NOTE)**

When you have changed the connections and transferred the data of the changed connections to the R-880, all the output levels will be set to zero.

After editing the Algorithm data, select the Mixer display and adjust the output levels. (See page 77 "7 Editing the Mixer".)

**NOTES ON USING THE COMPRESSOR/GATE**

● **Compressor and Gate**

The Compressor and Gate use the same unit, therefore, when the Gate is being used (Mode A or B), the Compressor unit cannot be used. (The Compressor unit disappears from the Move Display.)

With Gates 1 and 2 OFF, their respective Compressors 1 and 2 become activated.

● **Compressor and Mixer**

If you use a Compressor unit (CP1 or CP2) in the Move Display, a Mixer unit (8 or 9) will also disappear, and therefore can no longer be used as a separate mixer unit. (Mixer unit disappears from the display.)

This is because a Compressor requires its own mixer unit.

● **Gate and Mixer**

In the Gate operating mode (Mode A or B), Gate 1 automatically controls the output from Mixers 4 and 6, and Gate 2 controls the Mixers 5 and 7. This fact means you cannot set the output levels of those Mixers.

● **Control Input of the Gate (Mode A)**

When the Gate is operating in Mode A, the input point of an Early Reflection Unit (ER1 or ER2) is used for control input.

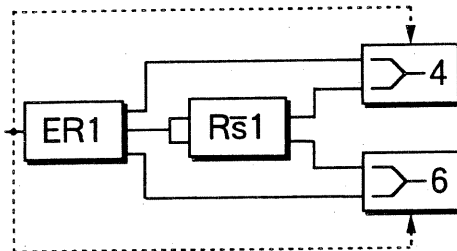

When the algorithm Mode is set to "Plate", the input point of the Main Unit (Plate) is used for a control input.

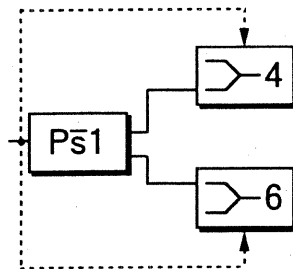

● **Gate (Mode B) and Mixer**

When the Gate is operating in Mode B, Mixer Unit 8 (for Gate 1) and Mixer Unit 9 (for Gate 2) cannot be used as independent mixer units. (The Mixer Unit disappears from the Display.)

This is because a Gate requires its own mixer unit to function in Mode B.

● **Control Input of Gate (Mode B)**

When the Gate is operating in Mode B, the output point of the Main Unit is used for control input.

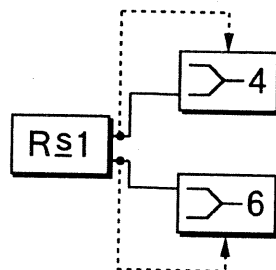

# 6 EDITING PARAMETERS

To edit Parameters, press **FUNC2** while holding **SHIFT** down, to select the Parameter Mode.

At the right of the Display, a menu of the available effects appears.

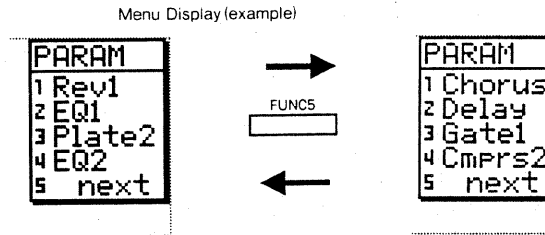

\* You can call the next menu using "next".

The contents of a menu change depending on the Algorithm setting.

(Ex. 1)

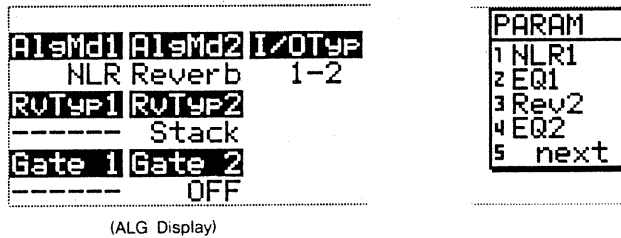

(Ex. 2)

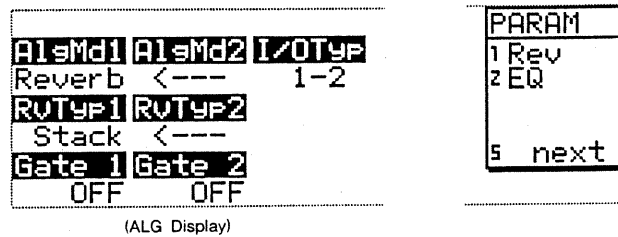

6 EDITING PARAMETERS

There are several levels of displays for the reverb, non-linear and equalizer.

To shift to upper displays, press  $\Delta$ . To shift to lower displays, press  $\nabla$ . In the upper displays, there are fewer parameters and most of them are Auto-calculated.

Lower displays show the parameters which have been Auto-calculated in the upper display, allowing you to change the set values as you desire.

The following is the layout of the uppermost display for the reverb parameters.

1

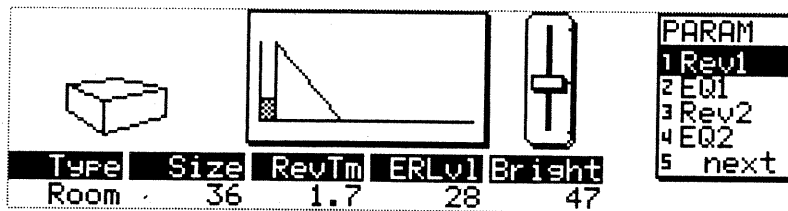

In this display, the reverb is controlled with five parameters; Type (tone), Size (the size of the room), RevTm (reverb time), ERLvl (early reflection level) and Bright (brightness). Other parameters will be set to average values depending on how those five parameters are set. If you are not content with these standard settings, you can edit them. Press  $\nabla$ , then select any of the three lower displays.

2

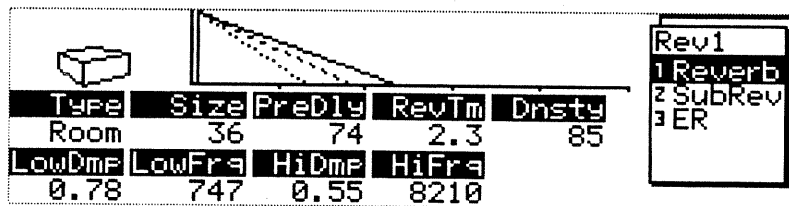

3

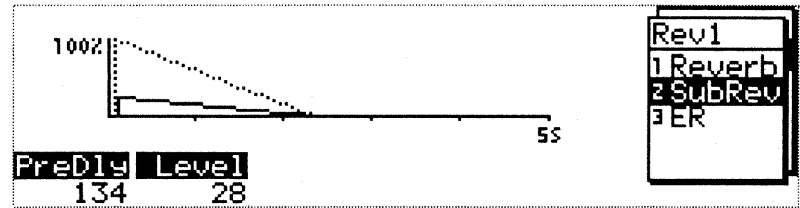

4

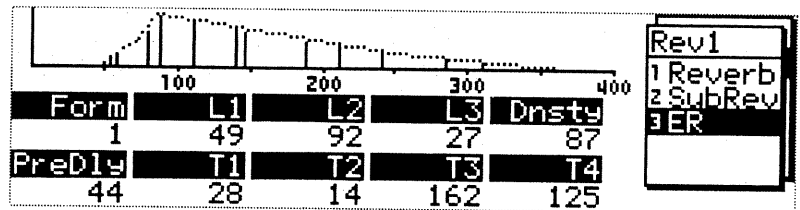

Display 2 shows general reverb parameters such as pre-delay and high-damp which can be individually edited.

Display 3 allows you to create more sophisticated reverberations by adding sub-reverb.

Display 4 shows the early reflection pattern which is auto-calculated. In this display, you can edit the attack of the early reflection by changing the envelope curve or editing the presence of the room by changing the density.

Displays 2 and 3 do not have any lower displays, while display 4 (early reflections) can be shifted to a lower display.

5

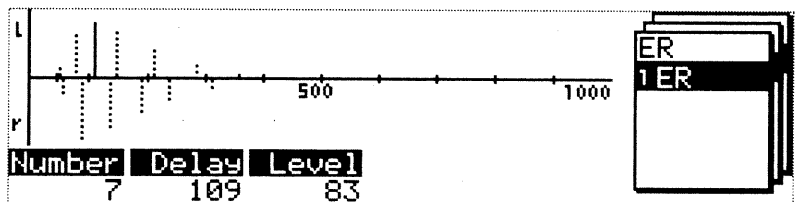

## ⑥ EDITING PARAMETERS

In display 4, the early reflection sound can be easily edited by using the envelope curve. In display 5, you can edit the delay time and level of each early reflection.

Depending on the reverberation parameter you wish to edit, the number of displays to be used varies.

If you move to a higher display and move a knob lower display being edited, the unit stops immediately and displays the following message.

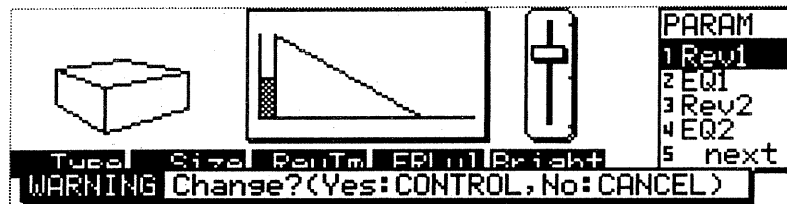

This is for preventing the parameter set in a lower display from accidental erasure caused by the automatic calculation function.

To rewrite it, press **CONTROL** .

To retain it, press **CANCEL** .

The most efficient way for editing parameters is to start from the upper display. Then shifting to the lower ones, make the effect closer and closer to what it should be.

# 1. Reverb

## a. Reverb (stack type)

Algorithm Setting

AlgMd	Reverb
RvTyp	Stack

Structure of Parameter Displays

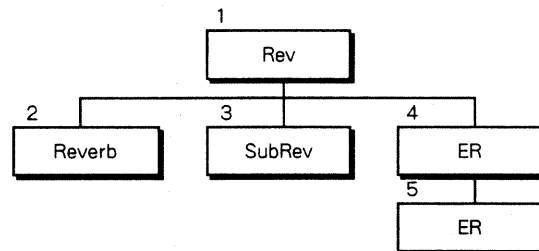

1

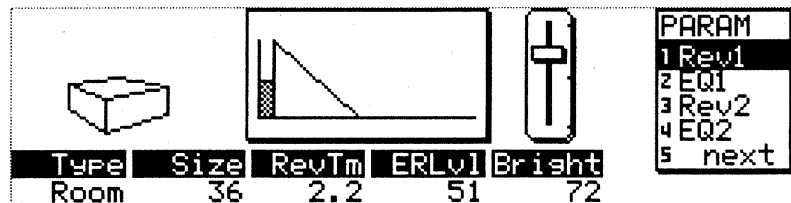

● **Type**  
(Reverb Type)

The Reverb Type, Room or Hall, can be selected.

● **Size**  
(Reverb Size)

One of the 16 types of the room size from 0.2 to 80m can be selected.  
(The length represents one side of a cube.)

● **RevTm**  
(Reverb Time)

This parameter allows you to set the reverberation time (time needed for a reverb sound to decay by 60dB) from 0.1 to 99.9 seconds.

● **ERLvl**  
(Early Reflection Level)

This sets the level of the early reflection sound from 0 to 100.

● **Bright**  
(Brightness)

This sets the brightness of the reverb sound from 0 to 100. Higher values give brighter sound and lower values mellower sound.

2

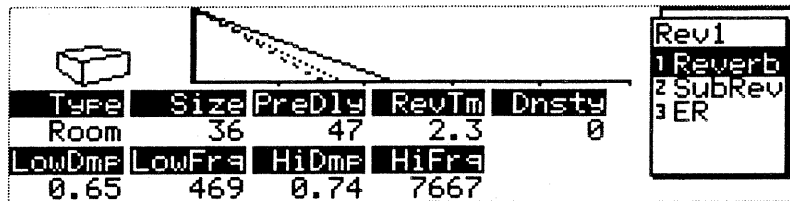

Type	Size	PreDly	RevTm	Dnsty
Room	36	47	2.3	0
LowDmf	LowFrg	HiDmf	HiFrg	
0.65	469	0.74	7667	

Rev1

1 Reverb

2 SubRev

3 ER

● **Type**  
(Reverb Type)

The Reverb Type, Room or Hall, can be selected.

● **Size**  
(Reverb Size)

One of the 16 types of room size, from 0.2 to 80m can be selected. (The length represents one side of a cube.)

● **PreDly**  
(Pre-delay)

This parameter allows you to set the delay time (time gap between the direct and reverb sounds) from 0 to 800 ms.

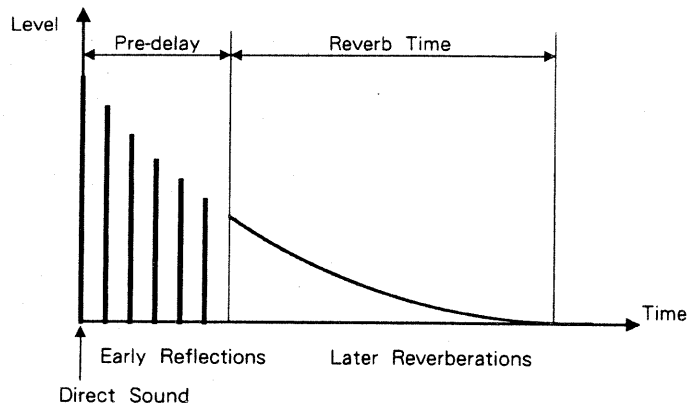

● **RevTm**  
(Reverb Time)

This parameter allows you to set the reverberation time from 0.1 to 99.9 seconds.

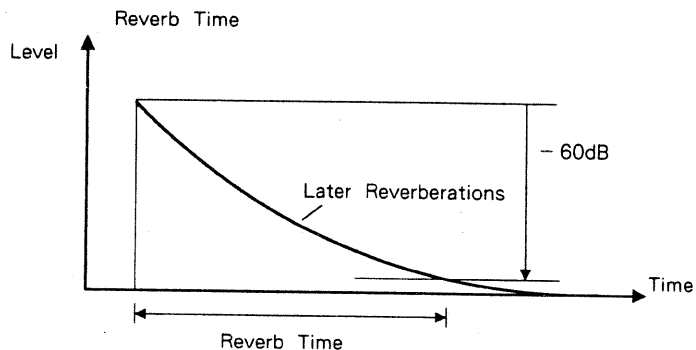



**\* Maximum Value for Reverb Time**

The longest reverb time of a Stack type reverb will vary depending on the size, as follows.

Reverb Size	Reverb Time
0.2	4.00
0.6	8.00
1.8	14.00
3.6	30.00
6.2	80.00
9.4	99.90
14	99.90
18	99.90
23	99.90
29	99.90
36	99.90
43	99.90
51	99.90
60	99.90
70	99.90
80	99.90

● **Dnsty**  
(Density)

This sets the density of reverberation sound from 0 to 100. Higher values make thicker sound.

● **LowDmp**  
(Damp level of lower sounds)

This sets the damp level of lower sounds from 0.05 to 1.00. The product of the low damp value and reverb time is the reverb time of the lower frequencies. Lower values make quicker damping.

● **LowFrq**  
(Lower Damp  
Frequencies)

This sets the frequencies of the lower damp from 50 to 4000Hz. Higher values will widen the frequency range to be damped.

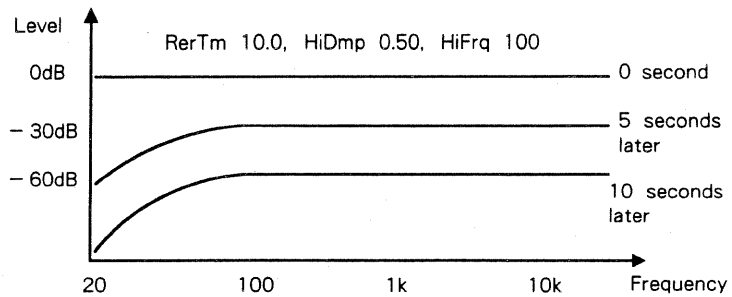
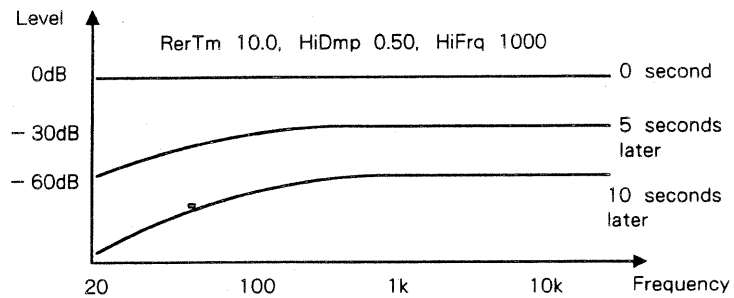

● **HiDmp**  
(Damp level of  
higher sounds)

This sets the damp level of higher sounds from 0.05 to 1.00. The product of the Hi damp value and reverb time is the reverb time of the higher frequencies. Lower values make quicker damping.

● **HiFrq**  
(Higher Damp  
Frequencies)

This sets the frequencies of the higher damp from 4000 to 20000Hz. Lower values will widen the frequency range to be damped.

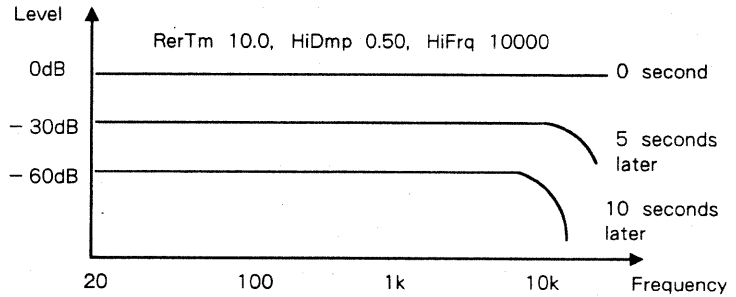
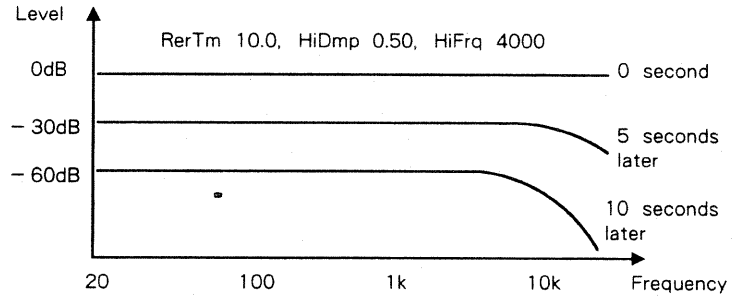

3

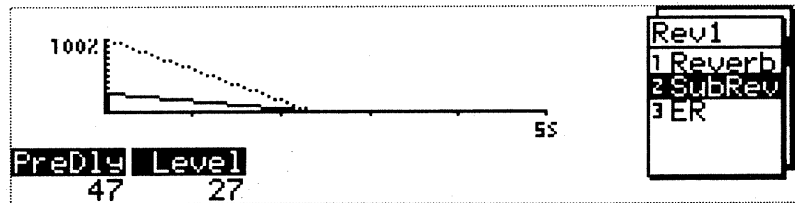

A **Sub reverb** is made by adding a sound that has a different pre-delay time to the input of a reverb unit.

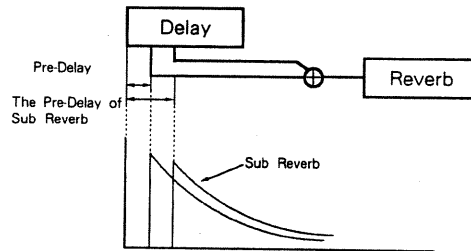

● **PreDly**  
(Pre-delay)

This parameter allows you to set the delay time of the sub-reverb from 0 to 800ms.

● **Level**

This sets the level of the sub-reverb from 0 to  $\pm 100$ .

4

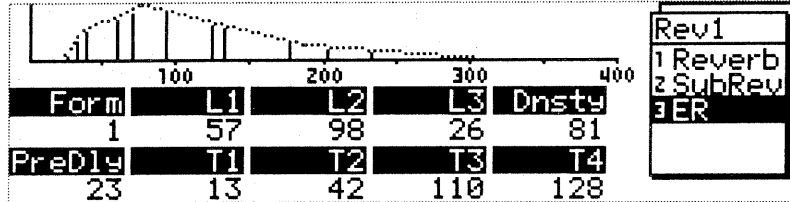

● **Form**

(Early Reflection Pattern)

This allows you to select one of the four early reflection patterns.

Pattern 1

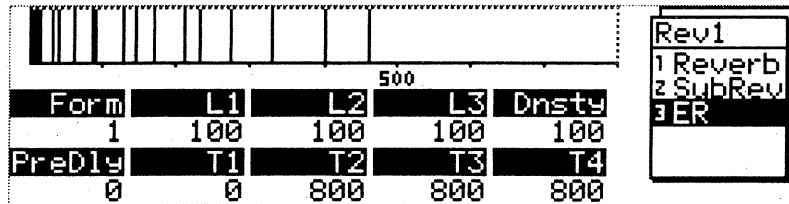

Pattern 2

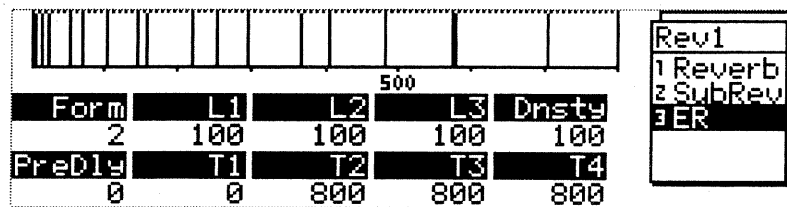

Pattern 3

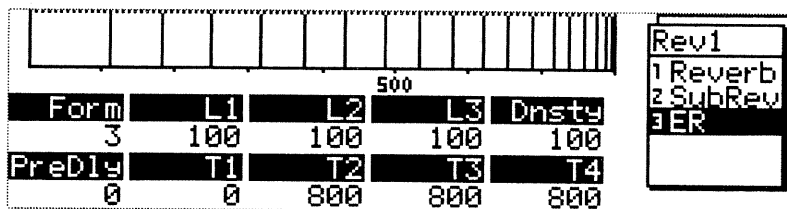

Pattern 4

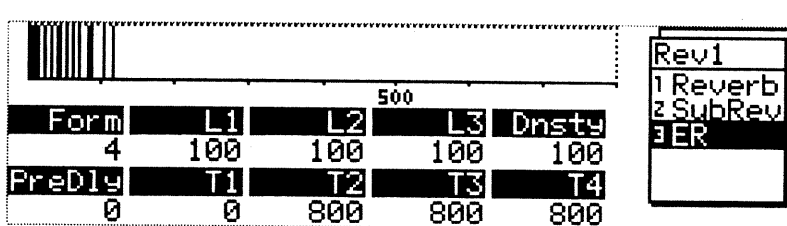

Early reflection sound can be edited with the envelope consisting of time and level.

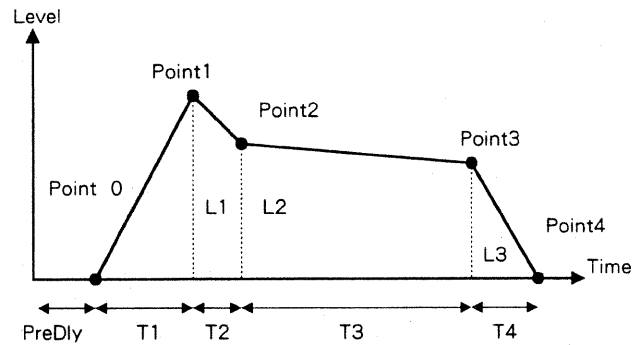

● **L1 (Level 1)**

This sets the level of Point 1 from 0 to 100.

● **L2 (Level 2)**

This sets the level of Point 2 from 0 to 100.

● **L3 (Level 3)**

This sets the level of Point 3 from 0 to 100.

● **PreDly**  
(Pre-delay)

This sets the time needed from the direct sound to the first early reflection sound (Point 0) from 0 to 800ms.

● **T1 (Time 1)**

This sets the time needed from Point 0 (the first early reflection sound) to Point 1 within the range of 0 to 800ms.

● **T2 (Time 2)**

This sets the time needed from Point 1 to Point 2 within the range of 0 to 800ms.

● **T3 (Time 3)**

This sets the time needed from Point 2 to Point 3 within the range of 0 to 800ms.

● **T4 (Time 4)**

This sets the time needed from Point 3 to Point 4 within the range of 0 to 800ms.

● **Dnsty**  
(Density of the  
Early Reflection)

The density of the early reflection sound can be set from 0 to 100.

\* The early reflection cannot be set longer than 800ms.

5

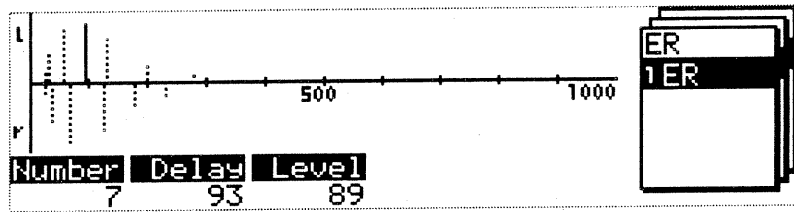

In this display, time and level can be set for each early reflection sound.

● **Number**

This allows you to select one of the 20 early reflection sounds to be edited. The early reflection currently edited is shown as a full line, while others are shown with dotted lines.

● **Delay (Time)**

This set the time needed from the direct sound to the early reflection within the range of 0 to 800ms.

● **Level**

This sets the level of the early reflection sound from 0 to  $\pm 100$ .  
“-” values indicate inverted phase.

b. Reverb (tap type)

Algorithm Setting

AlgMd	Reverb
RvTyp	Tap

Structure of Parameter Displays

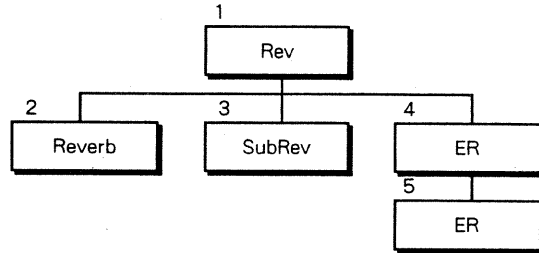

1

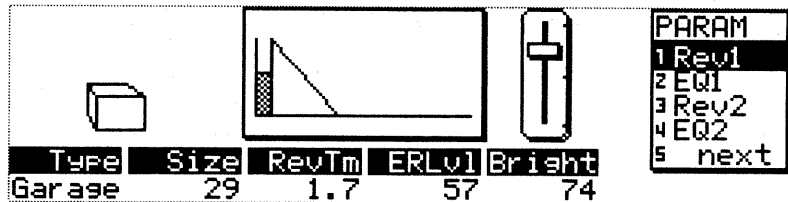

● **Type**  
(Reverb Type)

The Reverb Type, Room, Hall or Garage, can be selected.

● **Size**  
(Reverb Size)

One of the 10 types of the room size from 3.6 to 51m can be selected.  
(The length represents one side of a cube .)

● **RevTm**  
(Reverb Time)

This parameter allows you to set the reverberation time (time needed for a reverb sound to decay by 60dB) from 0.1 to 99.9 seconds.

● **ERLvl**  
(Early Reflection Level)

This set the level of the early reflection sound from 0 to 100.

● **Bright**  
(Brightness)

This sets the brightness of the reverb sound from 0 to 100. Higher values make brighter sound and lower values mellower sound.

2

Type	Size	PreDly	RevTm	EDnsty
Garage	29	36	2.3	39
LowDmp	LowFra	HiDmp	HiFra	RDnsty
0.72	514	0.68	6918	80

Rev1
1 Reverb
2 SubRev
3 ER

● **Type**  
(Reverb Type)

The Reverb Type, Room, Hall or Garage, can be selected.

● **Size**  
(Reverb Size)

One of the 10 types of the room size from 3.6 to 51m can be selected.  
(The length represents one side of a cube .)

● **PreDly**  
(Pre-delay)

This parameter allows you to set the delay time (time gap between the direct and reverb sounds) from 0 to 800ms.

● **RevTm**  
(Reverb Time)

This parameter allows you to set the reverberation time from 0.1 to 99.9 seconds.

● **EDensity**  
(density of the early reverberation sound)

This sets the density of the early reverberation sound from 0 to 100. Higher values make thicker sound.

● **RDensity**  
(density of the later reverberation sound)

This sets the density of the later reverberation sound from 0 to 100. Higher values make thicker sound.

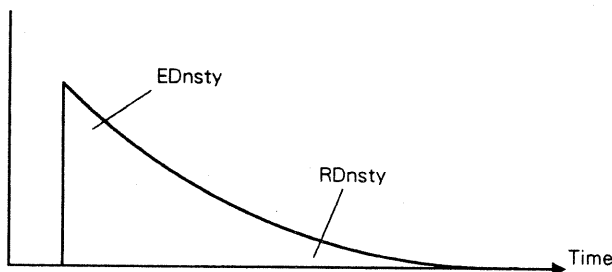

● **LowDmp**  
(Damp level of lower sounds)

This sets the damp level of lower sounds form 0.05 to 1.00. The product of the low damp value and reverb time is the reverb time of the lower frequencies. Lower values make quicker damping.



● **LowFrq**  
(Lower Damp  
Frequencies)

This sets the frequencies of the lower damp from 50 to 4000Hz. Higher values will widen the frequency range to be damped.

● **HiDmp**  
(Damp level of  
higher sounds)

This sets the damp level of higher sounds from 0.05 to 1.00. The product of the Hi damp value and reverb time is the reverb time of the higher frequencies. Lower values make quicker damping.

● **HiFrq**  
(Higher Damp  
Frequencies)

This sets the frequencies of the higher damp from 4000 to 20000Hz. Lower values will widen the frequency range to be damped.

3

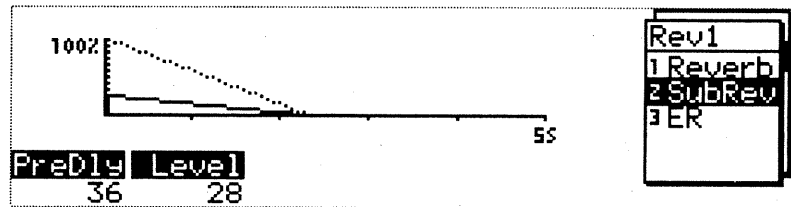

● **PreDly**  
(Pre-delay)

This parameter allows you to set the delay time of the sub-reverb from 0 to 800ms.

● **Level**

This sets the level of the sub-reverb from 0 to ±100.

4

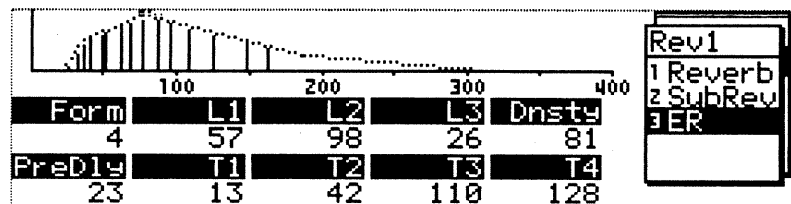

6 EDITING PARAMETERS

● **Form**  
(Early Reflection Pattern)

This allows you to select one of the four early reflection patterns.

Pattern 1

500				
Form	L1	L2	L3	Dnsty
1	100	100	100	100
PreDly	T1	T2	T3	T4
0	0	800	800	800

Rev1
1 Reverb
2 SubRev
3 ER

Pattern 2

500				
Form	L1	L2	L3	Dnsty
2	100	100	100	100
PreDly	T1	T2	T3	T4
0	0	800	800	800

Rev1
1 Reverb
2 SubRev
3 ER

Pattern 3

500				
Form	L1	L2	L3	Dnsty
3	100	100	100	100
PreDly	T1	T2	T3	T4
0	0	800	800	800

Rev1
1 Reverb
2 SubRev
3 ER

Pattern 4

500				
Form	L1	L2	L3	Dnsty
4	100	100	100	100
PreDly	T1	T2	T3	T4
0	0	800	800	800

Rev1
1 Reverb
2 SubRev
3 ER

● **L1 (Level 1)**

This sets the level of Point 1 from 0 to 100.

● **L2 (Level 2)**

This sets the level of Point 2 from 0 to 100.

● **L3 (Level 3)**

This sets the level of Point 3 from 0 to 100.



## 2. Plate

### a. Plate (stack type)

Algorithm Setting

AlgMd	Plate
RvTyp	Stack

Structure of Parameter Displays

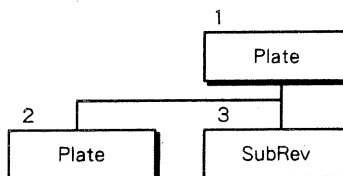

1



● **Type**

This selects the type of the reverb effect.

● **RevTm**  
(Reverb Time)

This parameter allows you to set the reverberation time (time needed for a reverb sound to decay by 60dB) from 0.1 to 99.9 seconds.

● **Bright**  
(Brightness)

This sets the brightness of the sound from 0 to 100. Higher values make brighter sound and lower values mellower sound.

2

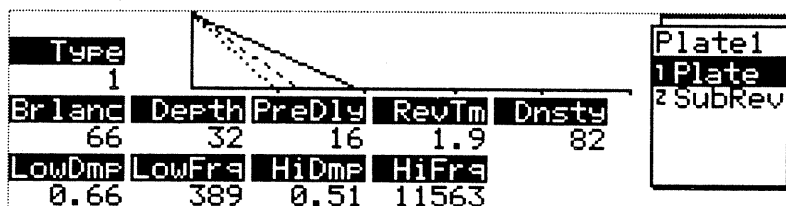

● **Type**  
(Reverb Type)

This selects the type of the reverb effect.

- **Brill**  
(Brilliance)

This can be set from 0 to 100. Higher values make brighter sound.
- **Depth**

The depth of the reverb effect can be set from 0 to 100.
- **PreDly**  
(Pre-delay)

This parameter allows you to set the delay time (time gap between the direct and reverb sounds) from 0 to 300ms.
- **RevTm**  
(Reverb Time)

This parameter allows you to set the reverberation time from 0.1 to 99.9 seconds.
- **Dnsty**  
(Density)

This sets the density of reverberation sound from 0 to 100. Higher values make thicker sound.
- **LowDmp**  
(Damp level of lower sounds)

This sets the damp level of lower sounds from 0.05 to 1.00. The product of the low damp value and reverb time is the reverb time of the lower frequencies. Lower values make quicker damping.
- **LowFrq**  
(Lower Damp Frequencies)

This sets the frequencies of the lower damp from 50 to 4000Hz. Higher values will widen the frequency range to be damped.
- **HiDmp**  
(Damp level of higher sounds)

This sets the damp level of higher sounds from 0.05 to 1.00. The product of the Hi damp value and reverb time is the reverb time of the higher frequencies. Lower values make quicker damping.
- **HiFrq**  
(Higher Damp Frequencies)

This sets the frequencies of the higher damp from 4000 to 20000Hz. Lower values will widen the frequency range to be damped.

3

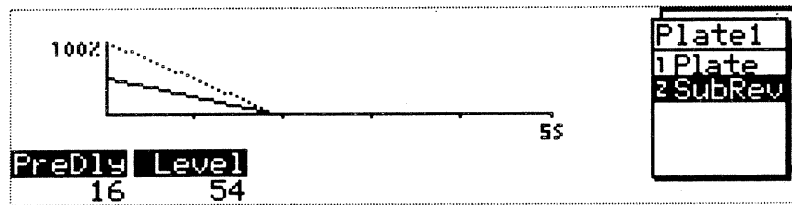

● **PreDly**  
(Pre-delay)

This parameter allows you to set the delay time of sub-reverb from 0 to 300 ms.

● **Level**

This sets the level of sub-reverb from 0 to  $\pm 100$ .

b. Plate (tap type)

Algorithm Setting

AlgMd	Plate
RvTyp	Tap

Structure of Parameter Displays

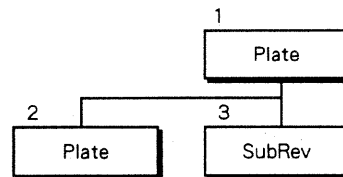

1

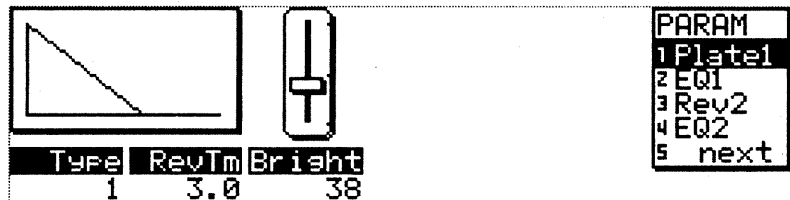

● Type

This selects the type of the reverb effect.

● RevTm  
(Reverb Time)

This parameter allows you to set the reverberation time (time needed for a reverb sound to decay by 60dB) from 0.1 to 99.9 seconds.

● Bright  
(Brightness)

This sets the brightness of the sound from 0 to 100. Higher values make brighter sound and lower values mellower sound.

2

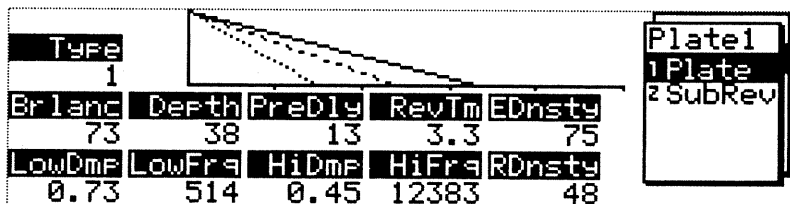

● Type

This selects the type of the reverb effect.

## ⑥ EDITING PARAMETERS

- **Brill**  
(Brilliance)  
This can be set from 0 to 100. Higher values make brighter sound.
  
- **Depth**  
The depth of the reverb effect can be set from 0 to 100.
  
- **PreDly**  
(Pre-Delay)  
This parameter allows you to set the delay time (time gap between the direct and reverb sounds) from 0 to 300ms.
  
- **RevTm**  
(Reverb Time)  
This parameter allows you to set the reverberation time from 0.1 to 99.9 seconds.
  
- **EDnsty**  
(density of the early reverberation sound)  
This sets the density of the early reverberation sound from 0 to 100.
  
- **RDnsty**  
(density of the later reverberation sound)  
This sets the density of the later reverberation sound from 0 to 100.
  
- **LowDmp**  
(Damp level of lower sounds)  
This sets the damp level of lower sounds from 0.05 to 1.00. The product of the low damp value and reverb time is the reverb time of the lower frequencies. Lower values make quicker damping.
  
- **LowFrq**  
(Lower Damp Frequencies)  
This sets the frequencies of the lower damp from 50 to 4000Hz. Higher values will widen the frequency range to be damped.
  
- **HiDmp**  
(Damp level of higher sounds)  
This sets the damp level of higher sounds from 0.05 to 1.00. The product of the Hi damp value and reverb time is the reverb time of the higher frequencies. Lower values make quicker damping.
  
- **HiFrq**  
(Higher Damp Frequencies)  
This sets the frequencies of the higher damp from 4000 to 20000Hz. Lower values will widen the frequency range to be damped.



3

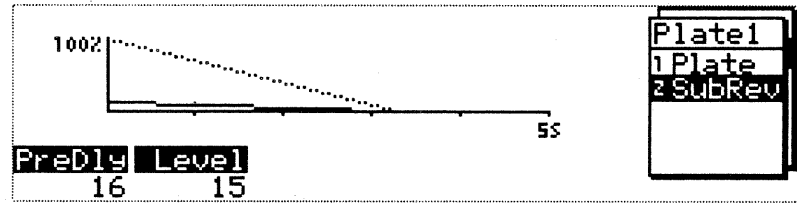

● **PreDly**  
(Pre-delay)

This parameter allows you to set the delay time of sub-reverb from 0 to 300 ms.

● **Level**

This sets the level of sub-reverb from 0 to  $\pm 100$ .

### 3. Non-linear

**Non-linear** is the effect that cuts reverb sound in the middle. It is also called Gate Reverb.

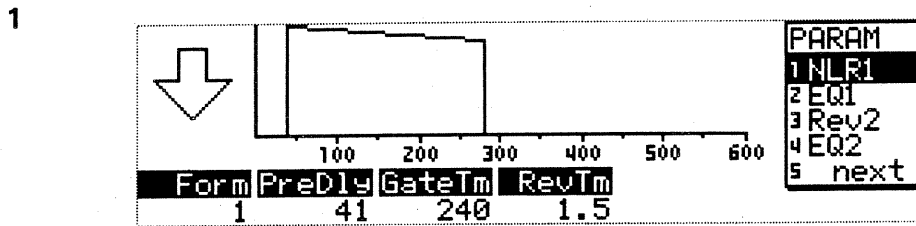
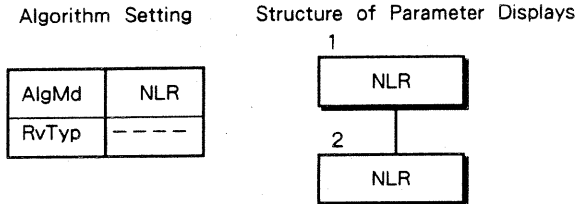

● **Form**  
(Panning Mode)

This allows you to select one of the three panning modes.

- 1 : Normal
- 2 : Panning from left to right
- 3 : Panning from right to left

\*Depending on the Algorithm setting, the panning modes and the channels shown above will differ.

● **PreDly**  
(Pre-delay)

This parameter allows you to set the delay time of sub-reverb from 0 to 800ms.

● **GateTm**  
(Gate Time)

This sets the time spent before a reverberation sound is cut, from 0 to 1200ms.

● **RevTm**  
**(Reverb Time)**

This parameter allows you to set the reverberation time from -9.9 to 9.9 seconds.

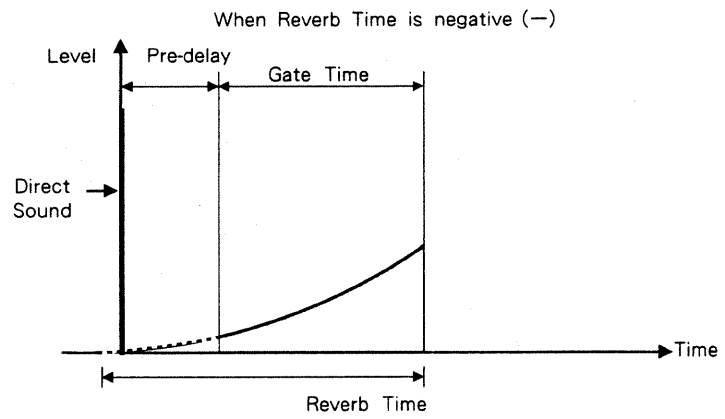
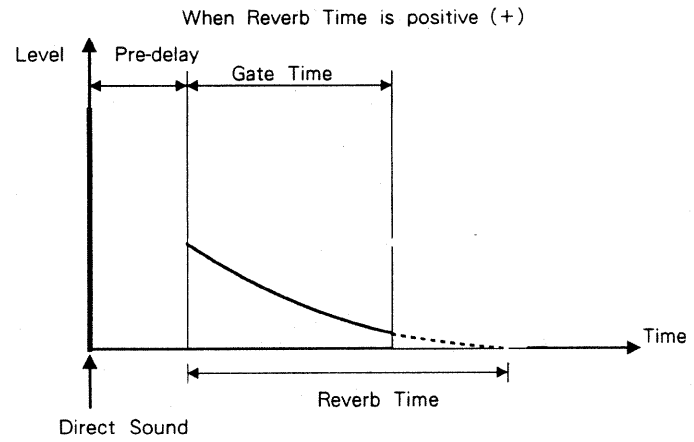

2

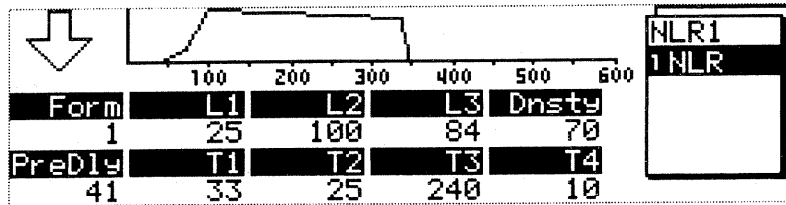

Lower displays allow finer editing of the non-linear output.

● **Form**  
(Panning Mode)

This allows you to select one of the three panning modes.

- 1 : Normal
- 2 : Panning from left to right
- 3 : Panning from right to left

● **L1 (Level 1)**

This sets the level of Point 1 from 0 to 100.

● **L2 (Level 2)**

This sets the level of Point 2 from 0 to 100.

● **L3 (Level 3)**

This sets the level of Point 3 from 0 to 100.

● **Dnsty (Density)**

This parameter sets the density of reverberation (non-linear), from 0 to 100. Higher values increase the density.

● **PreDly**  
(Pre-delay)

This sets the time gap between the direct and reverb sounds (non-linear) from 0 to 800ms.

● **T1 (Time 1)**

This sets the time needed from Point 0 (the first early reflection sound) to Point 1 within the range of 0 to 1200ms.

● **T2 (Time 2)**

This sets the time needed from Point 1 to Point 2 within the range of 0 to 1200ms.

● **T3 (Time 3)**

This sets the time needed from Point 2 to Point 3 within the range of 0 to 1200ms.

● **T4 (Time 4)**

This sets the time needed from Point 3 to Point 4 within the range of 0 to 1200ms.

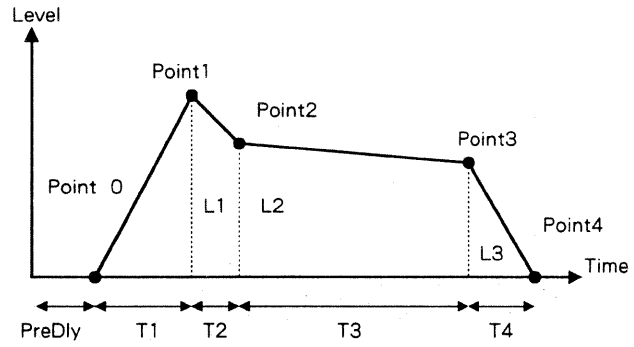

\*If the total length of non-linear ( $T1 + T2 + T3 + T4$ ) exceeds 1200ms, the exceeded portion will be cut.

## 4. Equalizer

Structure of Parameter Displays

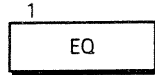

The R-880 features two equalizer units. Each of them consists of Low, Mid and Hi bands. The Mid band adopts the peaking system, and the Low and Hi bands can select the peaking or shelving system.

1

Low Q	Freq	Gain	Type
-----	210	- 7.3	Shlvng
Mid Q	Freq	Gain	
2.9	1000	10.4	
High Q	Freq	Gain	Type
1.0	7019	- 2.0	Peakng

PARAM
1 Rev1
2 EQ1
3 Rev2
4 EQ2
5 next

CONTROL  
  
 ↓  
 GRAPH

And you to set Q, frequency, gain, type (except for Mid) for all three bands.

\* The Mid band is fixed to the peaking type.

● **Low Q**

This sets the Q value of the Low band from 0.3 to 9.9 (Peaking type only).

● **Freq**  
(Low Frequency)

This sets the frequency in the Low band from 20 to 2000Hz.

● **Gain**  
(Low Gain)

This sets the gain (amount of boosting/cutting) in the Low band from - 12.0 to + 12.0dB.

● **Type (Low Type)**

This selects the type of Low band ; Shlvng (Shelving) or Peakng (Peaking).

● **Mid Q**

This sets the Q value of the Mid band from 0.3 to 9.9.

● **Freq**  
(Mid Frequency)

This sets the frequency in the Mid band from 200 to 8000Hz.

● **Gain (Mid Gain)**

This sets the gain (amount of boosting/cutting) in the Mid band from -12.0 to +12.0dB.

● **Hi Q**

This sets the Q value of the High band from 0.3 to 9.9 (Peaking type only).

● **Freq**  
(High Frequency)

This sets the frequency in the High band from 1500 to 20000Hz.

● **Gain (High Gain)**

This sets the gain (amount of boosting/cutting) in the High band from -12.0 to +12.0dB.

● **Type (High Type)**

This selects the type of High band ; Shlving (Shelving) or Peakng (Peaking).

\* Pressing **CONTROL** causes the Display to show the characteristic curve of the equalizer.

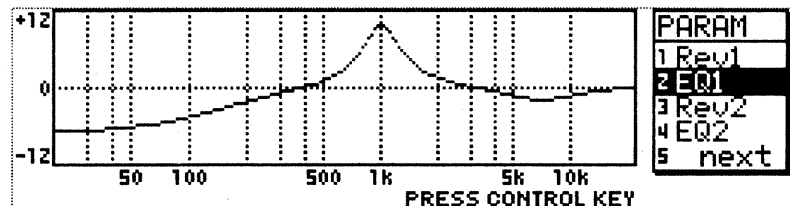

To return to the parameter display, press **CONTROL** again.

6 EDITING PARAMETERS

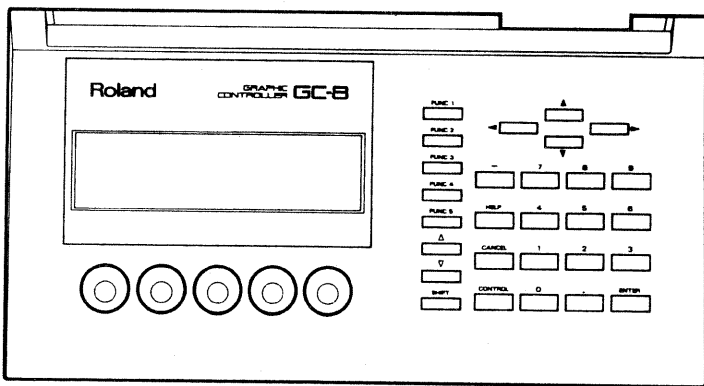



## 5. Chorus

Structure of Parameter Displays

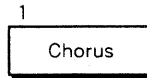

1

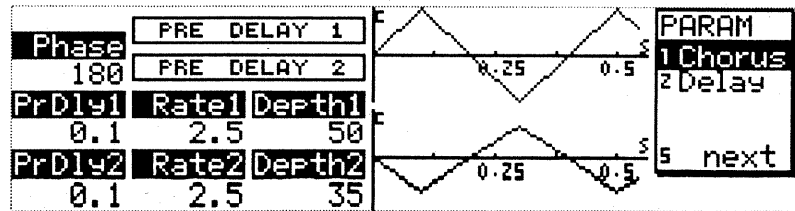

There are two chorus units in the R-880. Both units can be edited in the same display.

### ● Phase

This sets the phase of the chorus unit 1 and 2 from 0 to 360°.

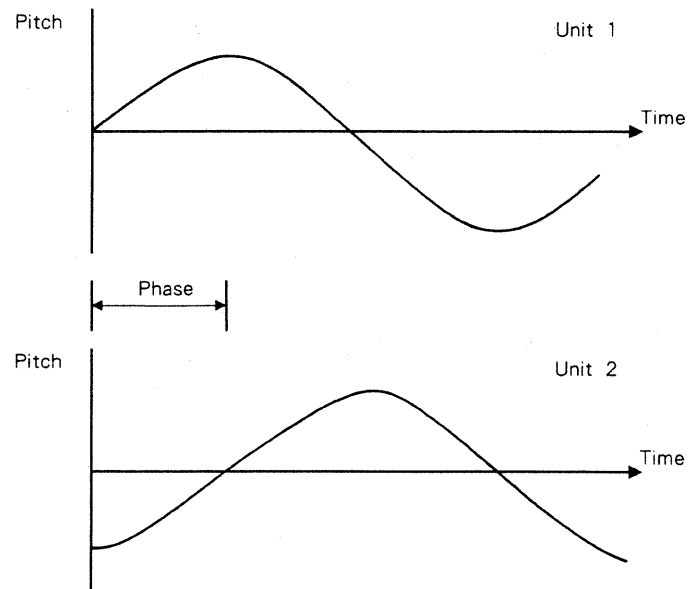

\* 360° represents a full cycle of the chorus unit 1's pitch travel.

⑤ EDITING PARAMETERS

- **PrDly1**  
(Unit 1 Pre-delay) This sets the delay time between the input and output of the chorus unit 1, from 0.1 to 40.0ms.
  
- **Rate1**  
(Unit 1 Rate) This sets the rate of the pitch changes from 0.3 to 10.0Hz.
  
- **Depth1**  
(Unit 1 Depth) This sets the depth of the pitch changes from 0 to 50 cents.
  
- **PrDly2**  
(Unit 2 Pre-delay) This sets the delay time between the input and output of the chorus unit 2, from 0.1 to 40.0ms.
  
- **Rate2**  
(Unit 2 Rate) This sets the rate of the pitch changes from 0.3 to 10.0Hz.
  
- **Depth2**  
(Unit 2 Depth) This sets the depth of the pitch changes from 0 to 50 cents.

## 6. Delay

Structure of Parameter Displays

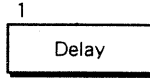

1

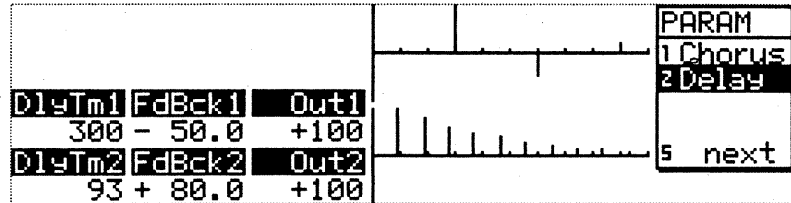

● **DlyTm1**  
(Unit 1  
Delay Time)

This sets the delay time of the delay unit 1 from 0 to 400ms.

● **FdBck1**  
(Unit 1  
Feedback)

This sets the feedback level from -100.0 to 100.0.

“-” values mean feedback in inverted phase.

\* If it is set to -100.0 or 100.0, oscillation may occur.

● **Out1**  
(Unit 1  
Output Level)

This sets the output level of the delay unit 1 from -100 to 100.

“-” values are output in inverted phase.

● **DlyTm2**  
(Unit 2  
Delay Time)

This sets the delay time of the delay unit 2 from 0 to 400ms.

● **FdBck2**  
(Unit 2  
Feedback)

This sets the feedback level from -100.0 to 100.0.

“-” values mean feedback in inverted phase.

\* If it is set to -100.0 or 100.0, oscillation may occur.

● **Out2**  
(Unit 2  
Output Level)

This sets the output level of the delay unit 2 from -100 to 100.

“-” values are output in inverted phase.

## 7. Gate

**Gate** is the effect that sets the gain level to zero (cuts the output) when the level of the input signal is lower than a certain level (threshold level). This effect may be useful for removing noise or cutting reverberation sound, to obtain an effect similar to non-linear. The difference is that non-linear cuts the output a predetermined time after the signal is input, while the gate cuts the output when it detects the level is lowered.

Structure of Parameter Displays

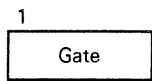

1

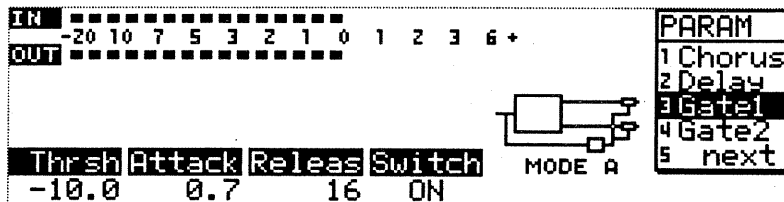

● **Thrsh**  
(Threshold)

This sets the level of the input at which the gate is released, from -34.5 to 7.5 (dB).

● **Attack**

This sets the speed of the gain changes when the gate is released, from 0.7 to 75 (mS). Lower values make the changes slower.

● **Releas**  
(Release)

This sets the speed of the gain changes when the gate is being engaged, from 12 to 1200 (mS).

● **Switch**

This switches on or off the Gate function. When it is set to OFF, the gate function is canceled regardless of the input level, and the indication of the Level Meter goes out.

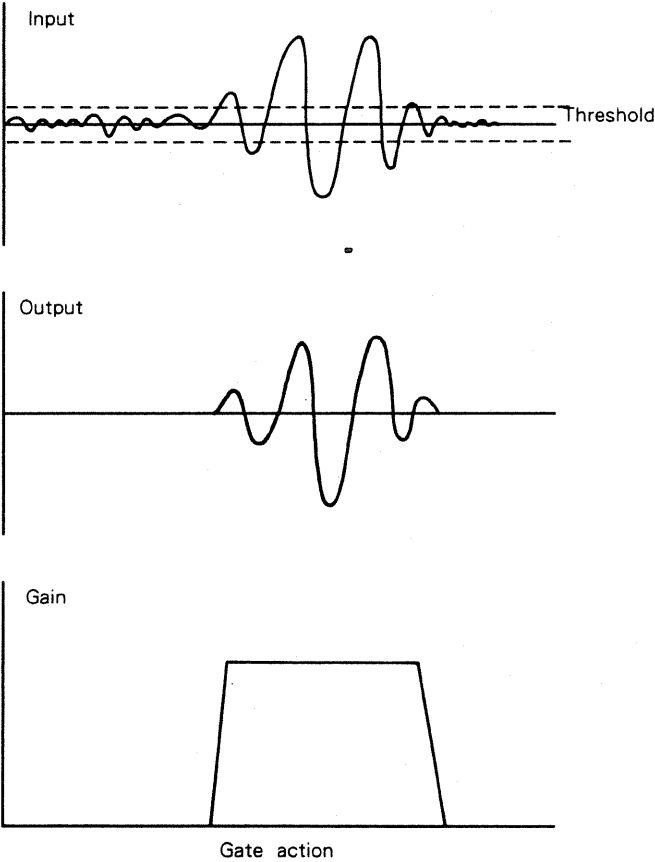

## 8. Compressor

The **compressor** is the unit that compresses the dynamic range of input signals.

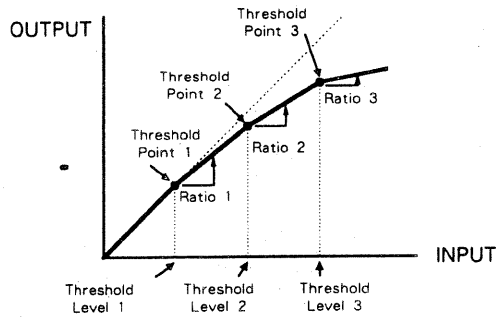

The above shows the relation between the input and output levels of the compressor unit. The peak level of the signal is suppressed at the compressor.

The compressor unit of the R-880 allows you to set three threshold points.

Input signals exceeding the threshold levels 1, 2 and 3 will be compressed in the ratio of 1, 2 and 3 respectively, then output. Limit level represents the strength of the input level when the output level is the highest.

There are two parameters which adjust the response speed of the compressor to the changes in the input level, Attack and Release.

Attack represents the speed of gain changes for the compression to start on the input that exceeds the threshold level. Release represents the speed for the input gain to be recovered to the original level from the level lower than the threshold.

Structure of Parameter Displays

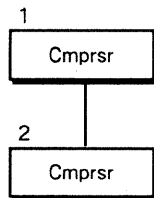

1



Upper displays allow you to set the compressor's parameters roughly.

- **Ratio** This sets the ratio of the output change to the input, from 1.0 : 1 to 33.0 : 1.
- **Thresh (Threshold)** This sets the level of the input when the compressor starts to work, from -39.0 to 6.0 (dB).
- **Attack** This sets the response speed of the compressor when the input exceeds the threshold point, from 75 to 0.7 (mS).
- **Releas (Release)** This sets the response speed of the compressor when the input level becomes lower than the threshold point, from 1200 to 12 (mS).
- **Switch** This switches on or off the compressor function. When it is OFF, the compressor function is canceled regardless of the input level and the indication of the Level Meter goes out.

2

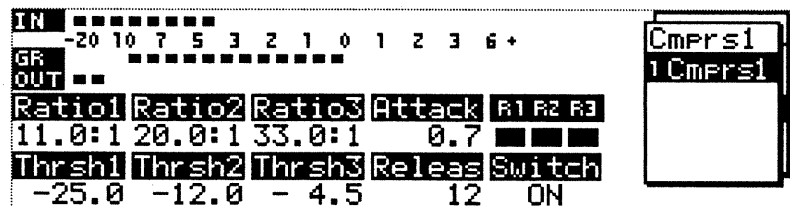

Lower displays allow you to set all the parameters of the compressor.

- **Ratio1**  
This sets the ratio of the output change to the input change from threshold point 1 to 2. 1.0 : 1 to 33.0 : 1 are valid.
- **Thrsh1**  
(Threshold 1)  
This sets the level of the threshold point 1 from -39.0 to 6.5 (dB).
- **Ratio2**  
This sets the ratio of the output change to the input change from threshold point 2 to 3. 1.0 : 1 to 33.0 : 1 are valid.
- **Thrsh2**  
(Threshold 2)  
This sets the level of the threshold point 2 from -30.0 to 7.0 (dB).
- **Ratio3**  
This sets the ratio of the output change to the input change at threshold point 3 from 1.0 : 1 to 33.0 : 1.
- **Thrsh3**  
(Threshold 3)  
This sets the level of the threshold point 3 from -25.0 to 7.5 (dB).
- **Attack**  
This sets the response speed of the compressor when the input exceeds the threshold point, from 75 to 0.7 (mS).
- **Releas**  
(Release)  
This sets the response speed of the compressor when the input level becomes lower than the threshold point, from 1200 to 12 (mS).
- **Switch**  
This switches on or off the compressor function. When it is OFF, the compressor function is canceled regardless of the input level and the indication of the Level Meter goes out.
- **About the GR Meter**  
The GR (Gain Reduction) meter indicates how much the input is compressed by the compressor. the following shows how to work it out.  
  
$$\text{GR (the indicated value)} = \text{IN (the indicated value)} - \text{OUT (the indicated value)}$$
- **R1R2R3 Indicators**  
The indicator lights up when the input exceeds the corresponding threshold point.

\*The values of the level parameters should be set as  $\text{ThLvl1} < \text{ThLvl2} < \text{ThLvl3}$  .





The input level can be set from 0 to  $\pm 100$ . “-” values indicate an inverted phase.

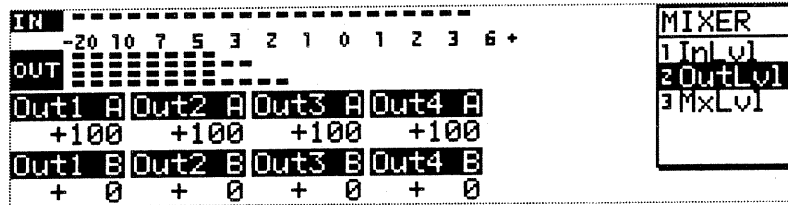

- Out1A Channel 1 Output A
- Out1B Channel 1 Output B
- Out2A Channel 2 Output A
- Out2B Channel 2 Output B
- Out3A Channel 3 Output A
- Out3B Channel 3 Output B
- Out4A Channel 4 Output A
- Out4B Channel 4 Output B

The output level can be set from 0 to  $\pm 100$ . “-” values indicate an inverted phase.

When more than one R-880 is used, you can select the level meter of any MIDI channel. (The current MIDI channel is shown in the Display of the GC-8.)

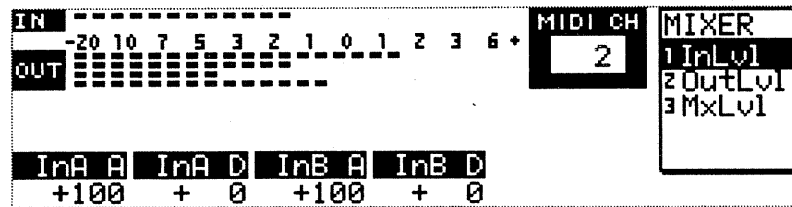

**Procedure**

Change the MIDI channel with **CONTROL**.

In a lower display (press ), the level can be set in 1/10 steps.

InA A	InA D	InB A	InB D
+100.0	+ 0.0	+100.0	+ 0.0
Out1 A	Out2 A	Out3 A	Out4 A
+100.0	+100.0	+100.0	+100.0
Out1 B	Out2 B	Out3 B	Out4 B
+ 0.0	+ 0.0	+ 0.0	+ 0.0

InLvl
11/0Lvl

## 2. Internal Level

In the "MxLvl" display, you can adjust the level of each effect unit using the mixer unit connected to the output on the effect unit. Press **FUNC3** to select the "MxLvl" display, and the Algorithm settings appear as shown below.

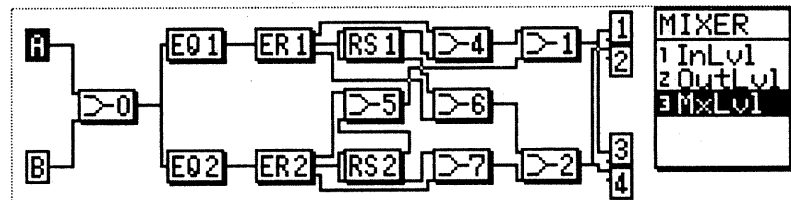

Step 1 Move the cursor to the Mixer or Input / Output Unit using

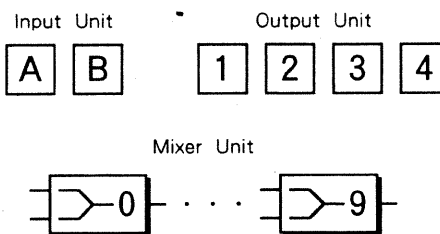
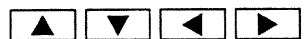

**7** EDITING THE MIXER

The mixer unit mixes the outputs from two units, controlling the signal level with the three parameters.

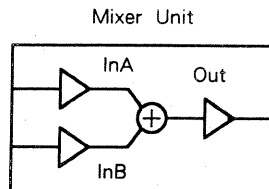

The input unit adjusts the level for analog and digital inputs.

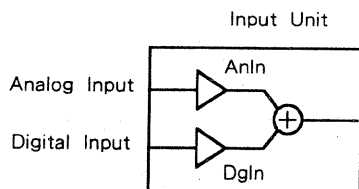

The output unit mixes the outputs from the two units, then sends it to the analog/digital output socket.

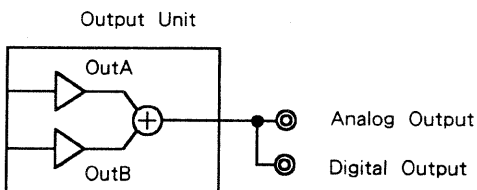

Step 2 Press **CONTROL** to open the Window.

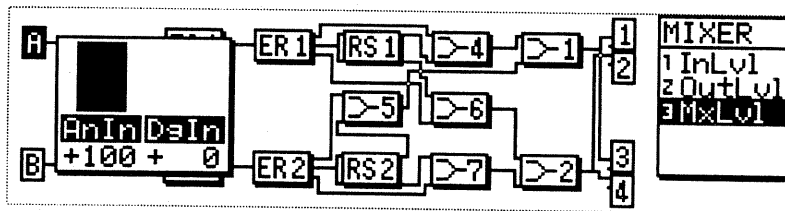

**Step 3 Using the Edit Control Knobs 1 to 3, adjust the level from 0 to ±100.**

Mixer Setting Example

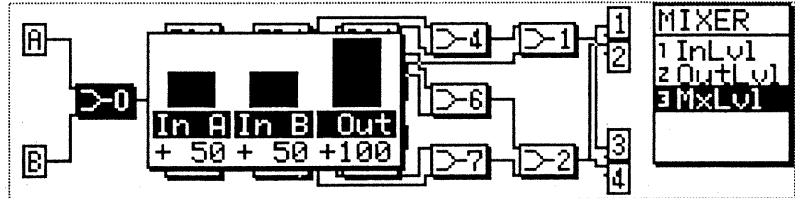

Example for Output Level Setting

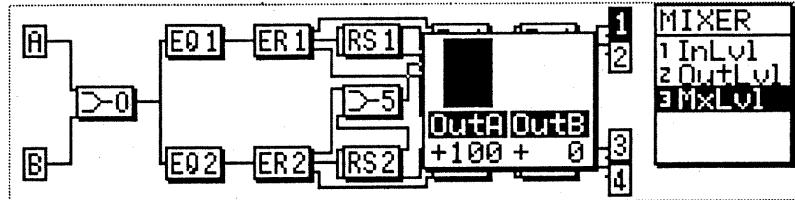

In the lower display (press ), the level can be controlled in 1/10 steps.

Mix0IA	Mix1IA	Mix2IA	Mix3IA	Mix4IA		MxLvl
+ 50.0	+ 50.0	+ 50.0	-----	+ 50.0		1 MxLvl1
Mix0IB	Mix1IB	Mix2IB	Mix3IB	Mix4IB		2 MxLvl2
+ 50.0	+ 50.0	+ 50.0	-----	+ 50.0		
Mix0 0	Mix1 0	Mix2 0	Mix3 0	Mix4 0		
+100.0	+100.0	+100.0	-----	+100.0		

Mix5IA	Mix6IA	Mix7IA	Mix8IA	Mix9IA		MxLvl
+ 50.0	+ 50.0	+ 50.0	-----			1 MxLvl1
Mix5IB	Mix6IB	Mix7IB	Mix8IB	Mix9IB		2 MxLvl2
+ 50.0	+ 50.0	+ 50.0	-----			
Mix5 0	Mix6 0	Mix7 0	Mix8 0	Mix9 0		
+100.0	+100.0	+100.0	-----			

\* Unused mixer units are shown as "-----" and cannot be edited.

7 EDITING THE MIXER

\*When "Gate" is shown in the display, the level is automatically controlled to create the gate effect. No editing is possible at such times.

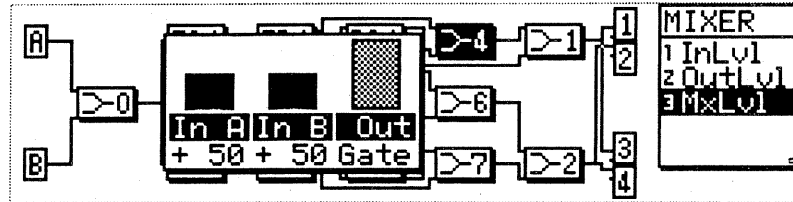

Mix0IA	Mix1IA	Mix2IA	Mix3IA	Mix4IA	MxLvl
+ 50.0	+ 50.0	+ 50.0	-----	+ 50.0	1 MxLvl1
Mix0IB	Mix1IB	Mix2IB	Mix3IB	Mix4IB	2 MxLvl2
+ 50.0	+ 50.0	+ 50.0	-----	+ 50.0	
Mix0 0	Mix1 0	Mix2 0	Mix3 0	Mix4 0	
+100.0	+100.0	+100.0	-----	-Gate-	

## 8 MEMORY

Up to 99 different programs can be written into the GC-8's internal memory, and another 99 onto a memory card. Each program can be named using up to 20 letters.

The GC-8 has the following Memory Functions :

- |  |  |
|--|--|
| <b>1. Reading</b>                            | This function reads the data from memory.  |
| <b>2. Copying</b>                            | This function copies a program to a different location.  |
| <b>3. Naming</b>                             | This function can name a program.  |
| <b>4. Writing</b>                            | This writes the data into memory.  |
| <b>5. Deleting</b>                           | This deletes unneeded data.  |
| <b>6. Initializing</b>                       | This initializes a brand new memory card so that it can be used with the GC-8  |
| <b>7. Backup a<br/>Memory Card</b>           | <p>This makes a backup.</p> <p><b>*This function cannot make a backup of the system card, but it can copy the Factory Presets.</b></p> |
| <b>8. Protecting the<br/>Internal Memory</b> | This determines whether to protect the internal memory or to make it overwritten.  |

To turn to the Memory Mode (Memory Display), press the **FUNC5** while holding **SHIFT** down.

**\*Depending on the Algorithm setting, the amount of memory required for a program varies drastically. If you write many programs that require a large amount of memory, the internal memory may not be able to store 99 programs.**

8 MEMORY

The amount of memory consumed so far is shown in the Write display.

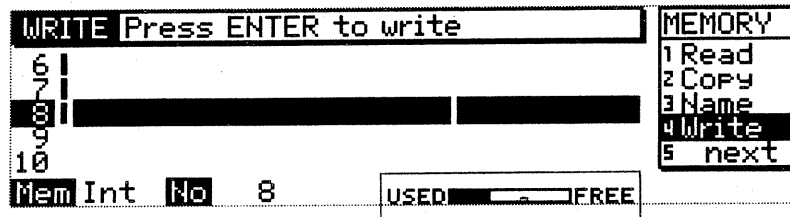

\*When the message "Card is not initialized" appears, initialize your memory card. (see page 89.)



# 1. Reading

Step 1 Press **FUNC1** to select "Read".(Should "Read" not be displayed, press **FUNC5** (next) first.)

Step 2 Select the internal memory (Int) or memory card (Card) by rotating Edit Control Knob 1.

Step 3 Move the cursor to the program you wish to call with the Edit Control Knob 2, then press **ENTER** .

\*If you know the program number, you can call it by entering the number with the Numeric Keypad (then press **ENTER** .)

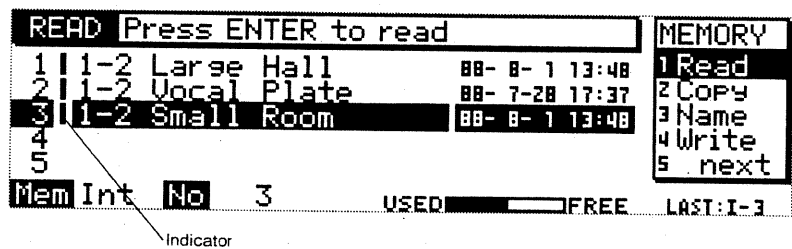

The number where any program is stored is indicated as shown below. Numbers with no indication are empty, and therefore cannot be called.

\* Reading a program will erase any current parameter settings.

\* Pressing **CANCEL** will cancel the Reading procedure you have just taken.

\* In the Read display, the last memory number called is shown under the menu.

<Ex> "LAST : I - 3" (Internal 3)

## 2. Copying

Step 1 Press **FUNC2** to select "Copy". (Should "Copy" not be displayed, press **FUNC5** (next) first.)

Step 2 Select the source program (memory number) with Edit Control Knobs 1 and 2, then select the destination memory number with Edit Control Knobs 3 and 4.

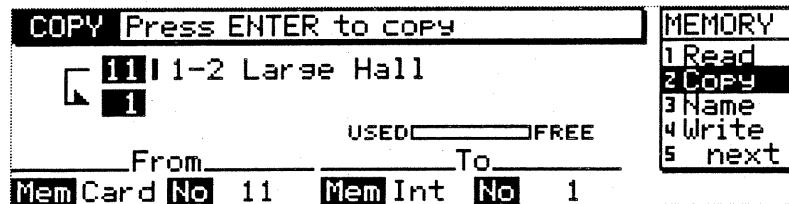

Step 3 Press **ENTER**.

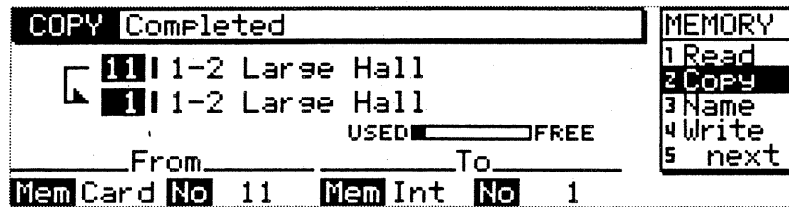

\* Pressing **CANCEL** will cancel the Copying procedure you have just taken.

## 3. Naming

Step 1 Press **FUNC3** to select "Name". (Should "Name" not be displayed, press **FUNC5** (next) first.)

Step 2 Select the internal memory (Int) or memory card (Card) by rotating Edit Control Knob 1.

Step 3 Using the Edit Control Knob 2, move the cursor to the memory number which you wish to name, and a flashing cursor appears.

\* memory Numbers with no data cannot be named.

Step 4 Using the Numeric Keypad, enter a name. The palette shows the characters that correspond to the Numeric Keypad..

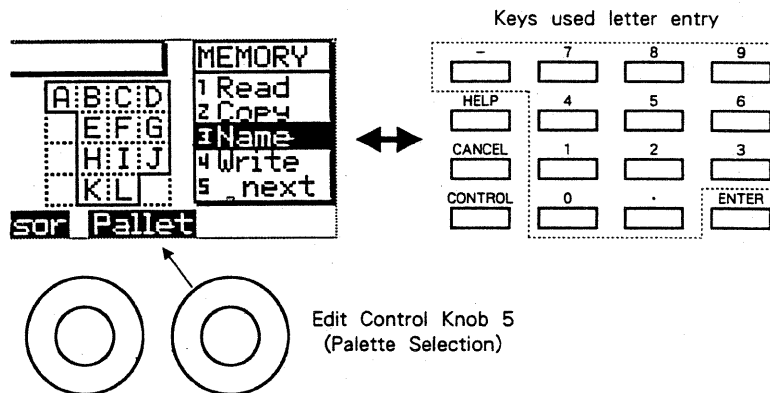

You can use capital and small letters, number and signs by changing the palette with Edit Control Knob 5.

Step 5 Press **ENTER** .

\*The letter cursor (flashing) can be moved with **◀** **▶** and Edit Control Knob 4. Rotating Edit Control Knob 3 (Space) will erase a letter, moving the cursor.

\*Pressing **CANCEL** will cancel the Naming procedure you have just taken.

## 4. Writing

Step 1 Press **FUNC4** to select "Write". (If "Write" has not been displayed, press **FUNC5** (next) first).

Step 2 Select the internal memory (Int) or memory card (Card) by rotating Edit Control Knob 1.

Step 3 Using Edit Control Knob 2, move the cursor to the memory number which you wish to write, then press **ENTER**.

\*If you know the number of the program, you can enter the number with the Numeric keypad (then press **ENTER**).

\* You cannot write new data onto the system card.

\*If programs that require a large amount of memory have been already written, the message "Memory full" may appear and no more data can be written. If this happens, delete some data (see the following section), then repeat the writing procedure.

\*Pressing **CANCEL** will cancel the Writing procedure you have just taken.

## 5. Deleting

Step 1 Press **FUNC1** to select "Delete". (If "Delete" has not been displayed, press **FUNC5** (next) first).

Step 2 Select either internal memory (Int) or memory card (Card) by rotating Edit Control Knob 1.

Step 3 Using Edit Control Knob 2, move the cursor to the memory number which you wish to delete, then press **ENTER**.

\*If you know the number of the program, you can enter the number with the Numeric Keypad (then press **ENTER**).

\*Pressing **CANCEL** will cancel the Deleting procedure you have just taken.

## 6. Initializing a Memory Card

To use a brand new memory card with the GC-8, you must initialize it.

- Step 1 Press **FUNC2** to select "Init". (Should "Init" not be displayed, press **FUNC5** (next) first).
- Step 2 Insert a memory card into the Card Slot, then set the protect switch to the OFF position.
- Step 3 Press **ENTER**.

## 7. Backup a Memory Card

This copies data on a memory card onto another card.

- Step 1 Press **FUNC3** to select "Backup". (If "Backup" has not been displayed, press **FUNC5** (next) first).
- Step 2 As the message on the display tells you, insert the source memory card for backup, then press **ENTER**.
- Step 3 Replace the memory card with a different card (destination), then press **ENTER**.
- Step 4 As the message on the display tells you, repeat steps 2 and 3. When the backup is completed, the message "Completed" appears.

\*If you have the system card, only the Factory Preset data will be copied.

\*To protect data from accidental erasure, be sure to set the protect switch on the source card to ON.

\*As the memory capacity of the M-128D is smaller than the M-256D (E)'s, the entire data on the M-256D (E) card may not be copied to the M-128D.

## 8. Protecting the Internal Memory

This determines whether to forbid or allow the internal memory to be overwritten.

- Step 1 Press the **FUNC4** to call "Protect". (If "Protect" does not appear, press **FUNC5** (next) first.)
- Step 2 Rotate the Edit Knob to select Protect ON or OFF.

\*When the Protect is set to ON, no data can be written into the internal memory in the "Write", "Copy", "Name" or "Delete" mode.

# 9 OTHER USEFUL FUNCTIONS

The Function Mode allows you to set MIDI settings, operational conditions, etc.

To turn to the Function Mode, press **FUNC4** while holding **SHIFT** down.

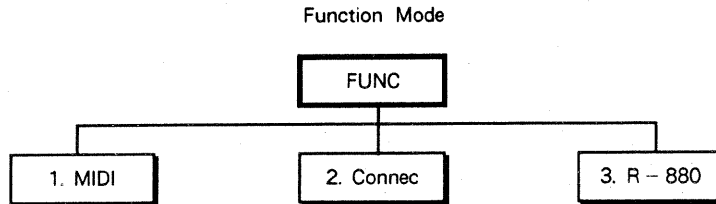

## 1. Program Change

The programs (memory numbers) on the R-880 can be selected with the Program Changes sent to the GC-8.

Consider the following example.

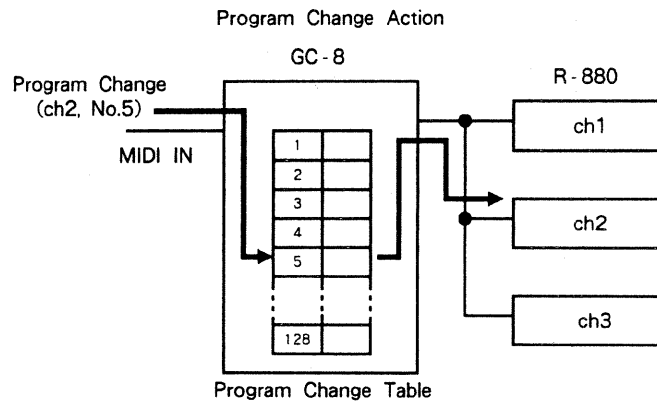

When three R-880's are setup with the GC-8 and "Channel 2, Program Change Number 5" is sent to the GC-8 :

1. Using the GC-8's program number table, find the memory number that corresponds to the Program Change number 5.
2. Read the relevant program from memory and send it to the R-880 of channel 2. (The display changes to the Read Display in the Memory mode.)

The program number table of the GC-8 shows how the 1 to 128 program changes correspond to the memory numbers. You can use any memory number in the internal or card memory. However, a memory number with no data cannot be read. If you assign a memory number on a memory card without the card connected, it will not be read either.

Set the program number table as follows :

**Step 1** Press **FUNC4** while holding **SHIFT** down to select the Function display.

**Step 2** Press **FUNC1** to select "MIDI".

**Step 3** Using Edit Control Knob 1, select a program change number, then select the memory number that is to go in tandem with the program change, with Edit Control Knobs 2 and 3.

The Program Change Table can also be set using the Exclusive messages. However, when more than one GC-8 is connected, it is necessary to set the Device ID (Code numbers to distinguish the connected devices from each other) for specifying which GC-8 should receive the Exclusive messages.

**Step 4** Set the Device ID 1 to 32, using Edit Control Knob 4.

\*The GC-8 can receive only Program Change and Exclusive messages.  
Any other message will be ignored.

\* The GC-8 is always set to OMNI OFF.

## 2. Controlling more than one R-880

Up to 16 R-880's can be connected to the GC-8. Normally, the same data is sent to all the R-880's, but it is also possible to change the settings of a particular R-880, or change all the R-880's settings.

The GC-8 can select whether or not to send data to each of the R-880's independently.

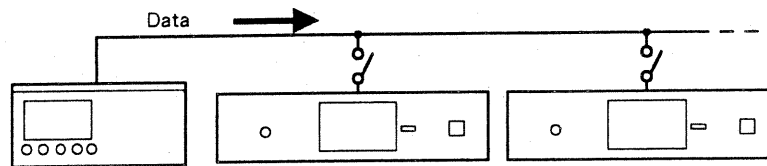

For instance, to set all the R-880's parameters to different settings :

- Connect only the R-880 of channel 1
- Read memory number 1
- Connect only the R-880 of channel 2
- Read memory number 2

### How to make connections

**Step 1** Press **FUNC4** while holding **SHIFT** down to select the Function Mode.

**Step 2** Press **FUNC2** to select "Connec".

The Display shows the current connections graphically.

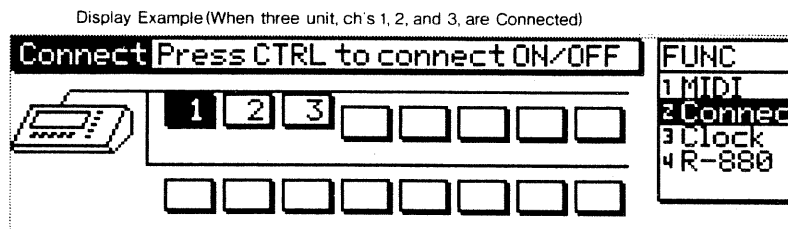



16  represent the R-880's. The R-880's that are currently connected have the actual numbers in .

Data of the MIDI channel which resides in  that touches the horizontal line will be transferred. In the above display, three R-880's are being used and data has already been transferred.

**Step 3** Using ▲▼◀▶, move the cursor to the MIDI channel you wish to change.

**Step 4** Press CONTROL to change the connections.

### 3. Displaying the R-880's condition

You can make the Display show the current condition of the R-880's digital interface and set the Emphasis.

Step 1 Press **FUNC4** while holding **SHIFT** down, to select the Function Mode.

Step 2 Press **FUNC4** to select "R-880".

Sample (When a CD player is connected to the Digital Input)

<b>R-880 Digital Interface</b>		<b>FUNC</b>
Lock :lock	Emphasis :no	1 MIDI
Channel :2 ch	Category :CD	2 Connec
Samplins:44.1kHz	DigitalCp:prohibit	3 R-880
Audio Md:audio		

Sample (When no unit is connected to the Digital Input)

<b>R-880 Digital Interface</b>		<b>FUNC</b>
Lock :unlock	Emphasis :50/15	1 MIDI
Channel :2 ch	Category :general	2 Connec
Samplins:48kHz	DigitalCp:permit	3 R-880
Audio Md:audio		
CONTROL CHANGE <input type="checkbox"/> EMPHASIS		

Step 3 When there is no digital input, the Emphasis can be switched with **CONTROL**. Each time you press **CONTROL**, ON (displayed as 50/15) and OFF (displayed as no) are alternately selected. Normally, you may set it to ON (50/15).

**\* Emphasis**

Emphasis is the element used for analog/digital signal conversion. It improves S/N ratio by controlling frequencies. When you use the Analog Input/Output Sockets, set the Emphasis to ON (50/15). However, when the Digital Input Socket is connected to a device such as a CD player, the Emphasis set in the digital signal is automatically selected. In this case, the set value cannot be changed with the **CONTROL**. Also, when the R-880 is being used for analog input and digital output, set the Emphasis according to the condition of the device connected to the Digital Output.

Parameter	Display	Description
Lock (Locked)	unlock	No Digital Input
	lock	Digital Input
Channel (Channel Mode)	2 ch	2 - ch Mode
	4 ch	4 - ch Mode
Sampling (Sampling Frequency)	44.1kHz	44.1kHz
	48kHz	48kHz
Audio Md (Audio Mode)	non - audio	Non - audio Mode
	audio	Audio Mode
Emphasis (Emphasis)	no	No Emphasis
	50/15	50/15 $\mu$ S Emphasis
Category (Category Code)	general	General Format
	CD	CD Format
	PCM	PCM Format
	DAT	DAT Format
DigitalCp (Digital Copy)	prohibit	Prohibited
	permit	Permitted

## ■ ERROR MESSAGES

### Error Messages shown at Power-up

#### **Load error**

The system program cannot be loaded. Switch the unit off, check the System Card, then switch the unit on again.

#### **No System Program**

The System Card you used is not appropriate for the GC-8.

#### **Check MIDI channel again**

Check the MIDI channel setting. When using more than one R-880's, make sure that all the units are set to different MIDI channels.

#### **Change the memory backup battery**

The battery for memory backup is exhausted. Call your local Roland service center.

### Error Messages shown during operation

#### **Cannot communicate with R-880**

The R-880 doesn't respond. Check the cables, R-880's power, etc.

#### **Turn off the R-880 and turn on again**

Switch the R-880 off, then switch it on again.

**Error Messages shown in  
the Memory Mode**

**Memory full**

There is no space left in memory.

**Card is protected**

The protect switch on the card is set to ON, set it to OFF.

**Card is not ready**

The memory card is not connected. Insert the card correctly.

**Card is not initialized**

The memory card is not initialized. Initialize the card.

**No parameter to read**

There is no data written in that memory number.

**Illegal Card ! Can't initialize**

The connected card cannot be used with the GC-8. Use the specified card.

**Warning : Insert the card again**

Follow the message shown in the display.

**INT – Memory is protected**

The internal memory is set to Protect ON. If you wish to write new data into the internal memory, release the Protect (Protect OFF).

# ■ GC-8 Parameter Map

● Reverb (Stack Type)

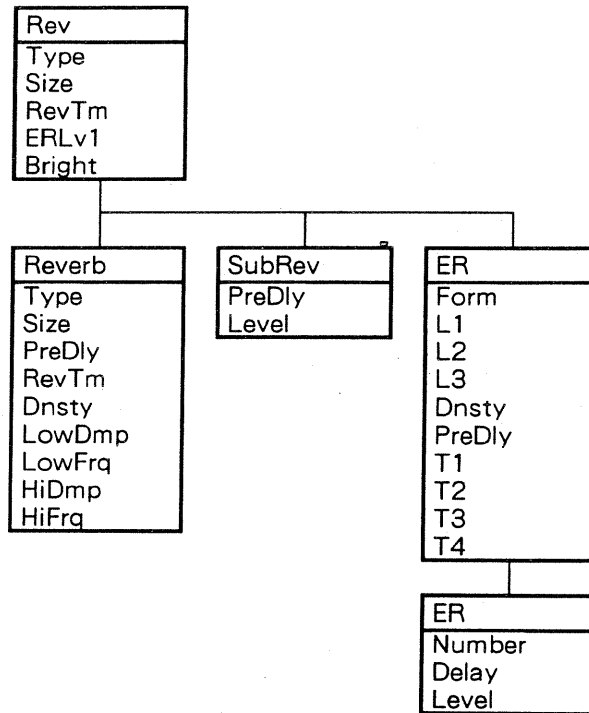

● Reverb (Tap Type)

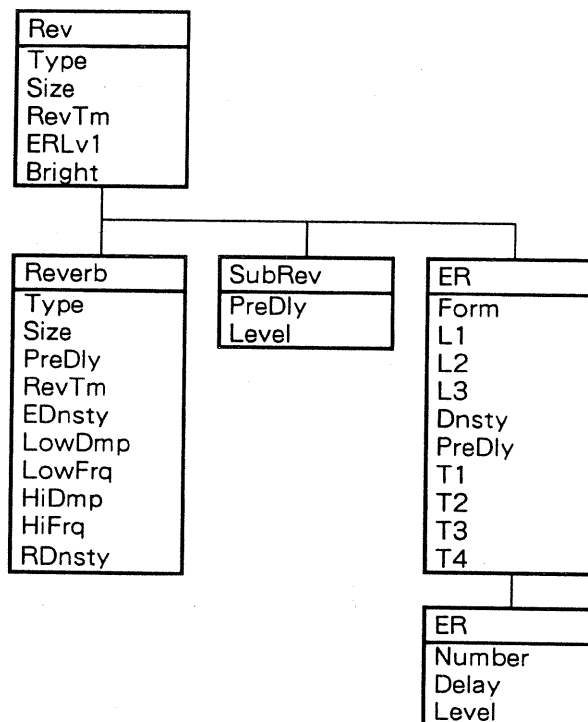

● Plate (Stack Type)

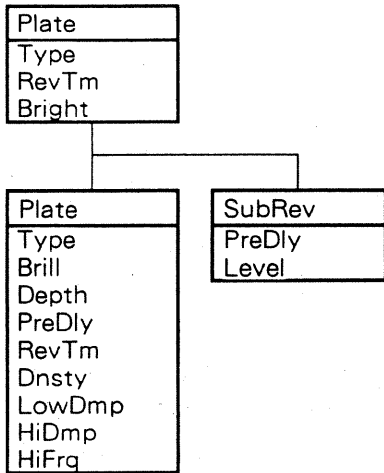

● Plate (Tap Type)

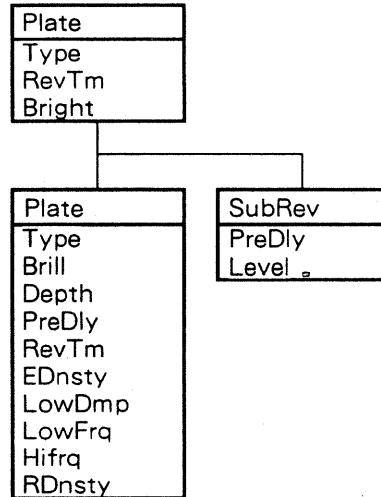

● Non-linear

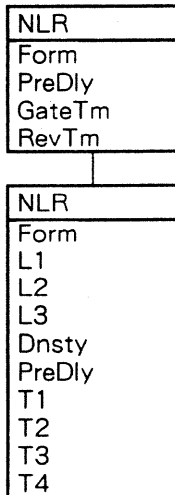

● Equalizer

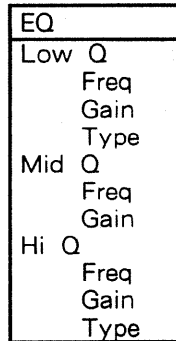

● Chorus

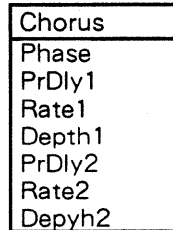

● Delay

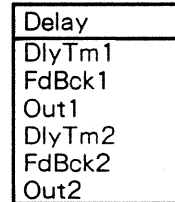

● Gate

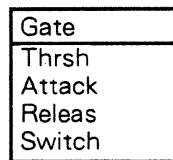

● Compressor

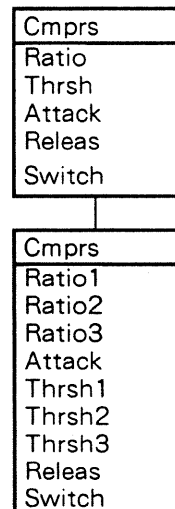

# ■ SPECIFICATIONS

- **Front Panel**
  - Edit Control Knobs × 5
  - Function Buttons (FUNC1/2/3/4/5)
  - Up Button (△)
  - Down Button (▽)
  - SHIFT Button
  - Cursor Buttons (▲/▼/◀/▶)
  - Numeric Keypad
  - ENTER Button
  - HELP Button
  - CANCEL Button
  - CONTROL Button
  
- **Rear Panel**
  - Power Switch
  - AC Adapter Socket
  - RRC Out Socket
  - MIDI IN Socket
  - MIDI OUT Socket
  - MIDI THRU Socket
  - Contrast Control Knob
  
- **Power Consumption** 90mA (9V)
  
- **Weight** 1.2kg (on its own) / 2 lb 10 oz
  
- **Dimensions** 333 (W) × 176 (D) × 51 (H) mm  
13 - 1/8" × 6 - 15/16" × 2
  
- **Accessories**
  - System Card (R88-GC8-I)
  - Owner's Manual
  - GC-8 Preset Data
  - Guide Book for MIDI
  
- **Options**
  - AC Adapter (ACF-120/220/240)
  - MIDI/SYNC Cable (MSC-07/15/25/50/100)



# Roland Exclusive Messages

## 1. Data Format for Exclusive Messages

Roland's MIDI implementation uses the following data format for all exclusive messages (type IV):

Byte	Description
F0H	Exclusive status
41H	Manufacturer ID (Roland)
DEV	Device ID
MDL	Model ID
CMD	Command ID
[BODY]	Main data
F7H	End of exclusive

### # MIDI status : F0H, F7H

An exclusive message must be flanked by a pair of status codes, starting with a Manufacturer-ID immediately after F0H (MIDI version 1.0).

### # Manufacturer-ID : 41H

The Manufacturer-ID identifies the manufacturer of a MIDI instrument that triggers an exclusive message. Value 41H represents Roland's Manufacturer-ID.

### # Device-ID : DEV

The Device-ID contains a unique value that identifies the individual device in the multiple implementation of MIDI instruments. It is usually set to 00H - 0FH, a value smaller by one than that of a basic channel, but value 0011 - 1FH may be used for a device with multiple basic channels.

### # Model-ID : MDL

The Model-ID contains a value that uniquely identifies one model from another. Different models, however, may share an identical Model-ID if they handle similar data.

The Model-ID format may contain 00H in one or more places to provide an extended data field. The following are examples of valid Model-IDs, each representing a unique model:

01H  
02H  
03H  
00H, 01H  
0011, 02H  
00H, 00H, 01H

### # Command-ID : CMD

The Command-ID indicates the function of an exclusive message. The Command-ID format may contain 00H in one or more places to provide an extended data field. The following are examples of valid Command-IDs, each representing a unique function:

01H  
0211  
03H  
00H, 01H  
00H, 02H  
00H, 00H, 01H

### # Main data : BODY

This field contains a message to be exchanged across an interface. The exact data size and contents will vary with the Model-ID and Command-ID.

## 2. Address-mapped Data Transfer

Address mapping is a technique for transferring messages conforming to the data format given in Section 1. It assigns a series of memory-resident records--waveform and tone data, switch status, and parameters, for example--to specific locations in a machine-dependent address space, thereby allowing access to data residing at the address a message specifies.

Address-mapped data transfer is therefore independent of models and data categories. This technique allows use of two different transfer procedures: one-way transfer and handshake transfer.

### # One way transfer procedure (See Section 3 for details.)

This procedure is suited for the transfer of a small amount of data. It sends out an exclusive message completely independent of a receiving device status.

#### Connection Diagram

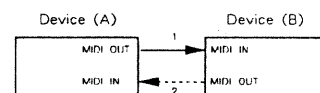

Connectional point 2 is essential for "Request data" procedures. (See Section 3.)

### # Handshake-transfer procedure (See Section 4 for details.)

This procedure initiates a predetermined transfer sequence (handshaking) across the interface before data transfer takes place. Handshaking ensures that reliability and transfer speed are high enough to handle a large amount of data.

#### Connection Diagram

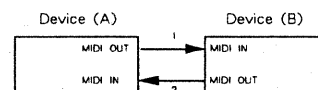

Connectional points 1 and 2 is essential.

### Notes on the above two procedures

- \*There are separate Command-IDs for different transfer procedures.
- \*Devices A and B cannot exchange data unless they use the same transfer procedure, share identical Device-ID and Model ID, and are ready for communication.

## 3. One-way Transfer Procedure

This procedure sends out data all the way until it stops when the messages are so short that answerbacks need not be checked.

For long messages, however, the receiving device must acquire each message in time with the transfer sequence, which inserts intervals of at least 20 milliseconds in between.

### Types of Messages

Message	Command ID
Request data 1	RQ1 (11H)
Data set 1	DT1 (12H)

### # Request data # 1 : RQ1 (11H)

This message is sent out when there is a need to acquire data from a device at the other end of the interface. It contains data for the address and size that specify designation and length, respectively, of data required.

On receiving an RQ1 message, the remote device checks its memory for the data address and size that satisfy the request.

If it finds them and is ready for communication, the device will transmit a "Data set 1 (DT1)" message, which contains the requested data. Otherwise, the device will send out nothing.

Byte	Description
F0H	Exclusive status
41H	Manufacturer ID (Roland)
DEV	Device ID
MDL	Model ID
11H	Command ID
aaH	Address MSB
⋮	⋮
⋮	LSB
ssH	Size MSB
⋮	⋮
⋮	LSB
sum	Check sum
F7H	End of exclusive

- \*The size of the requested data does not indicate the number of bytes that will make up a DTI message, but represents the address fields where the requested data resides.
- \*Some models are subject to limitations in data format used for a single transaction. Requested data, for example, may have a limit in length or must be divided into predetermined address fields before it is exchanged across the interface.
- \*The same number of bytes comprises address and size data, which, however, vary with the Model-ID.
- \*The error checking process uses a checksum that provides a bit pattern where the least significant 7 bits are zero when values for an address, size, and that checksum are summed.

#### # Data set 1 : DT1 (12H)

This message corresponds to the actual data transfer process. Because every byte in the data is assigned a unique address, a DTI message can convey the starting address of one or more data as well as a series of data formatted in an address-dependent order.

The MIDI standards inhibit non-real time messages from interrupting an exclusive one. This fact is inconvenient for the devices that support a "soft-through" mechanism. To maintain compatibility with such devices, Roland has limited the DTI to 256 bytes so that an excessively long message is sent out in separate segments.

Byte	Description
FOH	Exclusive
41H	Manufacturer ID (Roland)
DEV	Device ID
MDL	Model ID
12H	Command ID
aaH	Address MSB
⋮	⋮
⋮	⋮
ddH	Data
⋮	⋮
⋮	⋮
sum	Check sum
F7H	End of exclusive

- \*A DTI message is capable of providing only the valid data among those specified by an RQI message.
- \*Some models are subject to limitations in data format used for a single transaction. Requested data, for example, may have a limit in length or must be divided into predetermined address fields before it is exchanged across the interface.
- \*The number of bytes comprising address data varies from one Model-ID to another.
- \*The error checking process uses a checksum that provides a bit pattern where the least significant 7 bits are zero when values for an address, size, and that checksum are summed.

#### # Example of Message Transactions

- Device A sending data to Device B  
Transfer of a DTI message is all that takes place.

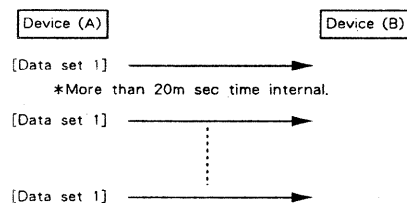

- Device B requesting data from Device A  
Device B sends an RQI message to Device A. Checking the message, Device A sends a DTI message back to Device B.

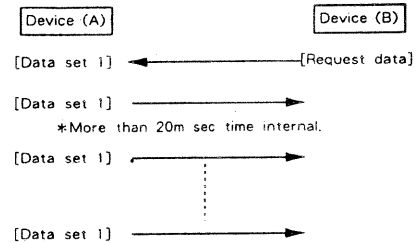

#### 4. Handshake - Transfer Procedure

Handshaking is an interactive process where two devices exchange error checking signals before a message transaction takes place, thereby increasing data reliability. Unlike one-way transfer that inserts a pause between message transactions, handshake transfer allows much speedier transactions because data transfer starts once the receiving device returns a ready signal.

When it comes to handling large amounts of data--sampler waveforms and synthesizer tones over the entire range, for example--across a MIDI interface, handshaking transfer is more efficient than one-way transfer.

#### Types of Messages

Message	Command ID
Want to send data	WSD (40H)
Request data	RQD (41H)
Data set	DAT (42H)
Acknowledge	ACK (43H)
End of data	EOD (45H)
Communication error	ERR (4EH)
Rejection	RJC (4FH)

#### # Want to send data : WSD (40H)

This message is sent out when data must be sent to a device at the other end of the interface. It contains data for the address and size that specify designation and length, respectively, of the data to be sent.

On receiving a WSD message, the remote device checks its memory for the specified data address and size which will satisfy the request. If it finds them and is ready for communication, the device will return an "Acknowledge (ACK)" message. Otherwise, it will return a "Rejection (RJC)" message.

Byte	Description
FOH	Exclusive status
41H	Manufacturer ID (Roland)
DEV	Device ID
MDL	Model ID
40H	Command ID
aaH	Address MSB
⋮	⋮
⋮	⋮
ssH	Size MSB
⋮	⋮
⋮	⋮
sum	Check sum
F7H	End of exclusive

- \*The size of the data to be sent does not indicate the number of bytes that make up a "Data set (DAT)" message, but represents the address fields where the data should reside.
- \*Some models are subject to limitations in data format used for a single transaction. Requested data, for example, may have a limit in length or must be divided into predetermined address fields before it is exchanged across the interface.
- \*The same number of bytes comprises address and size data, which, however, vary with the Model-ID.
- \*The error checking process uses a checksum that provides a bit pattern where the least significant 7 bits are zero when values for an address, size, and that checksum are summed.

# Request data : RQD (41H)

This message is sent out when there is a need to acquire data from a device at the other end of the interface. It contains data for the address and size that specify designation and length, respectively, of data required.

On receiving an RQD message, the remote device checks its memory for the data address and size which satisfy the request. If it finds them and is ready for communication, the device will transmit a "Data set (DAT)" message, which contains the requested data. Otherwise, it will return a "Rejection (RJC)" message.

Byte	Description
F0H	Exclusive status
41H	Manufacturer ID (Roland)
DEV	Device ID
MDL	Model ID
41H	Command ID
aaH	Address MSB
⋮	⋮
	LSB
ssH	Size MSB
⋮	⋮
	LSB
sum	Check sum
F7H	End of exclusive

\*The size of the requested data does not indicate the number of bytes that make up a "Data set (DAT)" message, but represents the address fields where the requested data resides.

\*Some models are subject to limitations in data format used for a single transaction. Requested data, for example, may have a limit in length or must be divided into predetermined address fields before it is exchanged across the interface.

\*The same number of bytes comprises address and size data, which, however, vary with the Model-ID.

\*The error checking process uses a checksum that provides a bit pattern where the least significant 7 bits are zero when values for an address, size, and that checksum are summed.

# Data set : DAT (42H)

This message corresponds to the actual data transfer process. Because every byte in the data is assigned a unique address, the message can convey the starting address of one or more data as well as a series of data formatted in an address-dependent order.

Although the MIDI standards inhibit non-real time messages from interrupting an exclusive one, some devices support a "soft-through" mechanism for such interrupts. To maintain compatibility with such devices, Roland has limited the DAT to 256bytes so that an excessively long message is sent out in separate segments.

Byte	Description
F0H	Exclusive status
41H	Manufacturer ID (Roland)
DEV	Device ID
MDL	Model ID
42H	Command ID
aaH	Address MSB
⋮	⋮
	LSB
ddH	Data
⋮	⋮
sum	Check sum
F7H	End of exclusive

\*A DAT message is capable of providing only the valid data among those specified by an RQD or WSD message.

\*Some models are subject to limitations in data format used for a single transaction. Requested data, for example, may have a limit in length or must be divided into predetermined address fields before it is exchanged across the interface.

\*The number of bytes comprising address data varies from one model ID to another.

\*The error checking process uses a checksum that provides a bit pattern where the least significant 7 bits are zero when values for an address, size, and that checksum are summed.

# Acknowledge : ACK (43H)

This message is sent out when no error was detected on reception of a WSD, DAT, "End of data (EOD)", or some other message and a requested setup or action is complete. Unless it receives an ACK message, the device at the other end will not proceed to the next operation.

Byte	Description
F0H	Exclusive status
41H	Manufacturer ID (Roland)
DEV	Device ID
MDL	Model ID
43H	Command ID
F7H	End of exclusive

# End of data : EOD (45H)

This message is sent out to inform a remote device of the end of a message. Communication, however, will not come to an end unless the remote device returns an ACK message even though an EOD message was transmitted.

Byte	Description
F0H	Exclusive status
41H	Manufacturer ID (Roland)
DEV	Device ID
MDL	Model ID
45H	Command ID
F7H	End of exclusive

# Communications error : ERR (4EH)

This message warns the remote device of a communications fault encountered during message transmission due, for example, to a checksum error. An ERR message may be replaced with a "Rejection (RJC)" one, which terminates the current message transaction in midstream.

When it receives an ERR message, the sending device may either attempt to send out the last message a second time or terminate communication by sending out an RJC message.

Byte	Description
F0H	Exclusive status
41H	Manufacturer ID (Roland)
DEV	Device ID
MDL	Model ID
4EH	Command ID
F7H	End of exclusive

# Rejection : RJC (4FH)

This message is sent out when there is a need to terminate communication by overriding the current message. An RJC message will be triggered when :

- a WSD or RQD message has specified an illegal data address or size.
- the device is not ready for communication.
- an illegal number of addresses or data has been detected.
- data transfer has been terminated by an operator.
- a communications error has occurred.

An ERR message may be sent out by a device on either side of the interface. Communication must be terminated immediately when either side triggers an ERR message.

Byte	Description
F0H	Exclusive status
41H	Manufacturer ID (Roland)
DEV	Device ID
MDL	Model ID
4FH	Command ID
F7H	End of exclusive

# Example of Message Transactions

● Data transfer from device (A) to device (B).

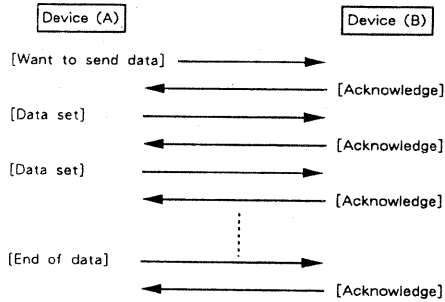

● Device (A) requests and receives data from device (B).

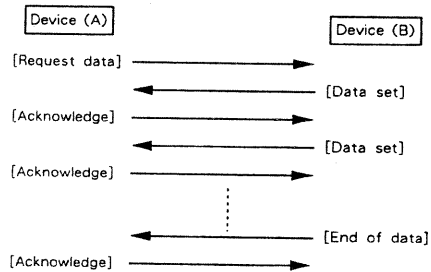

● Error occurs while device (A) is receiving data from device (B).

1) Data transfer from device (A) to device (B).

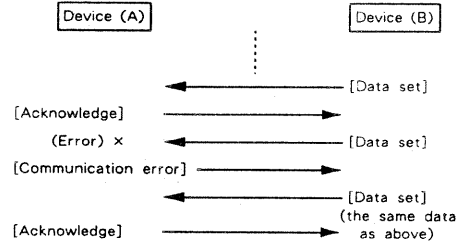

2) Device (B) rejects the data re-transmitted, and quits data transfer.

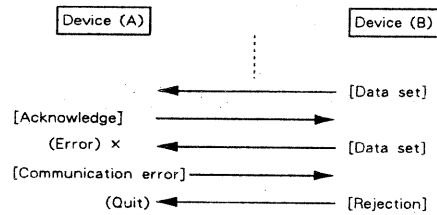

3) Device (A) immediately quits data transfer.

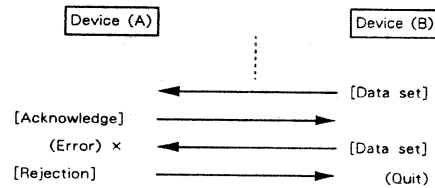

**1. RECOGNIZED DATA**

■ Program change

Status	Second
CnH	ppH
nH : MIDI channel	0H - FH (1 - 16)
ppH : Program number	0H - 7FH (1 - 128)

Parameters in the R-880 whose MIDI channel is set to "n" can be switched over. Set the memory number corresponding to the program number into the GC-8 program change table. The GC-8, upon receiving the program change, converts the program number to that memory number and sends the parameters of the memory to the R-880.

■ System exclusive

The GC-8's internal calendar clock or the program change table can be set by using the exclusive message.

Status	
FOH	: System Exclusive
F7H	: EOX (End of System Exclusive)

**2. EXCLUSIVE COMMUNICATIONS**

■ Data set

Byte	Description
FOH	Exclusive status
41H	Roland ID #
DEV	Device - ID # *2-1
1CH	Model - ID # (GC-8)
12H	Command - ID (DT1)
aaH	Address MSB *2-2
bbH	Address LSB
ddH	Data
:	:
sum	Checksum
F7H	End of System Exclusive

Notes :

\*2-1 Device ID can be set to a number anywhere from 1 to 32. Only the devices whose device ID number is the same as that of the exclusive message can recognize the message. Note that the exclusive message carries a device number with value 1 subtracted, i.e. device ID "1" is sent as "0".

\*2-2 Addresses must be within the range shown below.

MSB	LSB	Description
00	00	Calendar Clock
:	:	
00	04	
-----		
01	00	Program Change Table 1 - 64
:	:	
01	7F	
-----		
02	00	Program Change Table 65 - 128
:	:	
02	7F	

**3. ADDRESS MAPPING OF PARAMETERS**

● Calendar clock

MSB	LSB	Description	
00	00	Year (0 - 99)	*3-1
00	01	Month (0 - 11)	*3-2
00	02	Day (0 - 30)	*3-3
00	03	Hour (0 - 23)	
00	04	Minute (0 - 59)	

● Program change table

MSB	LSB	Description	
01	00	Program # 1 (Memory # 0 - 98)	*3-4
01	01	# 1 (Int./Card 0 - 1)	
:	:		
01	7F	# 64 (Int./Card 0 - 1)	
-----			
02	00	# 65 (Memory # 0 - 98)	
:	:		
02	7F	# 128 (Int./Card 0 - 1)	

Notes :

\*3-1 Read "0" as 1988, "1" as 1989, "2" as 1990, etc.

\*3-2 Read "0" as January, "1" as February, etc.

\*3-3 Read "0" as the first day of a month, "1" as the second, etc.

\*3-4 Assign a program number to a memory location with a set of 2 bytes. Even address data designates memory number (actual value less "1") and odd address data selects memory type (0 = internal, 1 = IC card).

# MIDI Implementation Chart

Function ...		Transmitted	Recognized	Remarks
Basic Channel	Default	×	1 - 16	* 1
	Changed	×	1 - 16	
Mode	Default	×	3	
	Messages	×	×	
	Altered	*****		
Note Number		×	×	
	True Voice	*****	×	
Velocity	Note ON	×	×	
	Note OFF	×	×	
After Touch	Key's	×	×	
	Ch's	×	×	
Pitch Bender		×	×	
Control Change		×	×	
Prog Change		×	○	
	True #	*****		
System Exclusive		×	○	
System Common	Song Pos	×	×	
	Song Sel	×	×	
	Tune	×	×	
System Real Time	Clock	×	×	
	Commands	×	×	
Aux Message	Local ON/OFF	×	×	
	All Notes OFF	×	×	
	Active Sense	×	×	
	Reset	×	×	
Notes		* 1 The basic channel is the MIDI channel to which the connected R-880 is being set.		

Mode 1 : OMNI ON, POLY  
 Mode 3 : OMNI OFF, POLY

Mode 2 : OMNI ON, MONO  
 Mode 4 : OMNI OFF, MONO

○ : Yes  
 × : No

## Apparatus containing Lithium batteries

### ADVARSEL!

Lithiumbatteri. Eksplosionsfare.  
Udskiftning må kun foretages af en sagkyndig,  
og som beskrevet i servicemanual.

### VARNING!

Lithiumbatteri. Explosionsrisk.  
Får endast bytas av behörig servicetekniker.  
Se instruktioner i servicemanualen.

### ADVARSEL!

Lithiumbatteri. Fare for eksplosion.  
Må bare skiftes av kvalifisert tekniker som  
beskrevet i servicemanualen.

### VAROITUS!

Lithiumparisto. Räjähdyksvaara.  
Pariston saa vaihtaa ainoastaan  
alan ammottimies.

## Bescheinigung des Herstellers/Importeurs

Hiermit wird bescheinigt, daß der/die/das  
**ROLAND GRAPHIC CONTROLLER GC-8**  
.....  
(Gerät. Typ. Bezeichnung)

in Übereinstimmung mit den Bestimmungen der  
**Amtsbl. Vfg 1046/1984**  
.....  
(Amtsblattverfügung)

funk-entstört ist.

Der Deutschen Bundespost wurde das Inverkehrbringen dieses Gerätes angezeigt und die Berechtigung zur Überprüfung der Serie auf Einhaltung der Bestimmungen eingeräumt.

.....  
**Roland Corporation Osaka/Japan**  
.....

Name des Herstellers/Importeurs

## RADIO AND TELEVISION INTERFERENCE

**WARNING —** This equipment has been verified to comply with the limits for a Class B computing device, pursuant to Subpart J, of Part 15 of FCC rules. Operation with non-certified or non-verified equipment is likely to result in interference to radio and TV reception.

The equipment described in this manual generates and uses radio frequency energy. If it is not installed and used properly, that is, in strict accordance with our instructions, it may cause interference with radio and television reception. This equipment has been tested and found to comply with the limits for a Class B computing device in accordance with the specifications in Subpart J, of Part 15, of FCC Rules. These rules are designed to provide reasonable protection against such a interference in a residential installation. However, there is no guarantee that the interference will not occur in a particular installation. If this equipment does cause interference to radio or television reception, which can be determined by turning the equipment on and off, the user is encouraged to try to correct the interference by the following measure:

- Disconnect other devices and their input/output cables one at a time. If the interference stops, it is caused by either the other device or its I/O cable. These devices usually require Roland designated shielded I/O cables. For Roland devices, you can obtain the proper shielded cable from your dealer. For non Roland devices, contact the manufacturer or dealer for assistance.

If your equipment does cause interference to radio or television reception, you can try to correct the interference by using one or more of the following measures:

- Turn the TV or radio antenna until the interference stops.
- Move the equipment to one side or the other of the TV or radio.
- Move the equipment farther away from the TV or radio.
- Plug the equipment into an outlet that is on a different circuit than the TV or radio. (That is, make certain the equipment and the radio or television set are on circuits controlled by different circuit breakers or fuses.)
- Consider installing a rooftop television antenna with coaxial cable lead-in between the antenna and TV. If necessary, you should consult your dealer or an experienced radio/television technician for additional suggestions. You may find helpful the following booklet prepared by the Federal Communications Commission: "How to Identify and Resolve Radio — TV Interference Problems".

This booklet is available from the U.S. Government Printing Office, Washington, D.C., 20402, Stock No. 004-000-00345-4.

### CLASS B

### NOTICE

This digital apparatus does not exceed the Class B limits for radio noise emissions set out in the Radio Interference Regulations of the Canadian Department of Communications.

### CLASSE B

### AVIS

Cet appareil numérique ne dépasse pas les limites de la classe B au niveau des émissions de bruits radioélectriques fixés dans le Règlement des signaux parasites par le ministère canadien des Communications.





 Roland

---

# GC-8 Preset Data

---

for R-880

---

本書は、GC-8内部と付属のシステム・カードに記憶されているファクトリー・プリセットの内容を、ディスプレイ画面を使って説明したものです。  
ファクトリー・プリセットを使用する場合や、オリジナル・データを作成する場合の参考用としてご覧ください。

---

This explains the contents of the factory presets stored on the supplied system card and in the GC-8 using displays.  
It may help you use factory presets or create original data.

## ■ CONTENTS (目次)

### ● System Card Memory ..... 3

1	1-2	Vocal Room	4
2	1-2	Vocal Brit Room	6
3	1-2	Vocal Warm Plate	8
4	1-2	Vocal Brit Plate	10
5	1-2	Vocal Hall	12
6	1-2	Brass Room	14
7	1-2	Brass Hall	16
8	1-2	Brass Plate	18
9	2-2	EP Room 1	20
10	1-2	EP Room 2	22
11	2-2	Piano Hall	24
12	1-2	Strings Room 1	26
13	1-2	Strings Room 2	28
14	1-2	Strings Hall	30
15	2-2	Drums Garage	32
16	1-2	Perc ambience	34
17	1-2	Snare Drum	36
18	1-2	Kick ambience	38
19	1-2	Kick Room	40
20	1-2	Drums Clear	42
21	1-2	RS coloration	44
22	2-2	Compression Rev	46
23	2-2	Stereo Delay	48
24	1-2	Reverse Gate	50

### ● Internal Memory ..... 53

1	1-2	Large Hall 1	54
2	1-2	Large Hall 2	56
3	1-2	Middle Hall 1	58
4	1-2	Middle Hall 2	60
5	1-2	Middle Hall 3	62
6	1-2	Middle Room 1	64
7	1-2	Middle Room 2	66
8	1-2	Small Room 1	68
9	1-2	Small Room 2	70
10	1-2	Small Room 3	72
11	1-2	Concert Hall	74
12	1-2	Garage	76
13	1-2	Warehouse	78
14	1-2	Kitchen	80
15	1-2	Cathedral	82
16	1-2	Chorus & Reverb 1	84
17	2-2	Chorus & Reverb 2	86
18	1-2	Delay & Reverb 1	88
19	2-2	Delay & Reverb 2	90
20	2-2	Independent Rev	92
21	1-2	Gated Reverb	94
22	2-2	Non Linear	96
23	1-2	INSANE	98

---

Copyright © 1988 by ROLAND CORPORATION

All rights reserved. No part of this publication may be reproduced in any form without the written permission of ROLAND CORPORATION.

本書の一部、もしくは全部を無断で複写・転載することを禁じます。

# System Card Memory

Memory No.	Card 1
Name	1 - 2 Vocal Room

## ALG (ALGORITHM)

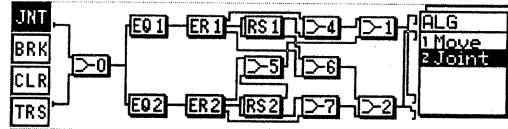
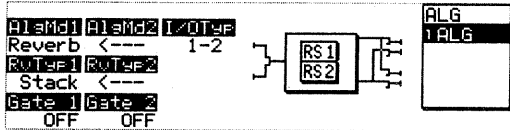

## HELP

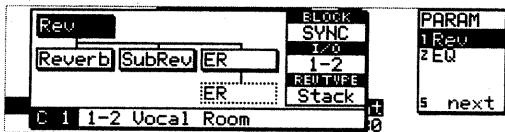

## PARAM (PARAMETER)

Rev

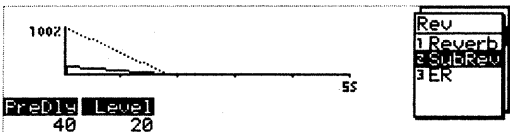
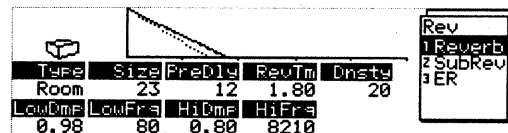
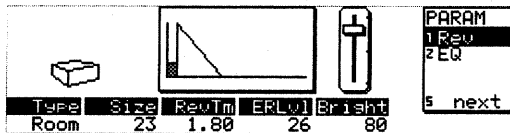

ER

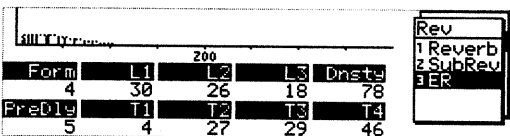

EQ

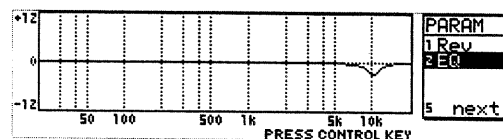
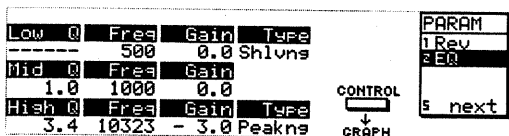

# MIXER

I/OLvl

InA A	InA 0	InB A	InB 0	InLvl
+100.0	+ 0.0	+100.0	+ 0.0	I/OLvl
Out1 A	Out2 A	Out3 A	Out4 A	
+100.0	+100.0	+100.0	+100.0	
Out1 B	Out2 B	Out3 B	Out4 B	
+ 0.0	+ 0.0	+ 0.0	+ 0.0	

MXLvl

Mix01A	Mix11A	Mix21A	Mix31A	Mix41A	MxLvl
+ 50.0	+ 70.0	+ 70.0	-----	+ 50.0	1 MxLvl1
Mix01B	Mix11B	Mix21B	Mix31B	Mix41B	2 MxLvl2
+ 50.0	+ 70.0	+ 70.0	-----	+ 50.0	
Mix0 0	Mix1 0	Mix2 0	Mix3 0	Mix4 0	
+100.0	+100.0	+100.0	-----	+100.0	

Mix51A	Mix61A	Mix71A	Mix81A	Mix91A	MxLvl
+ 50.0	+ 50.0	+ 50.0	-----	-----	1 MxLvl1
Mix51B	Mix61B	Mix71B	Mix81B	Mix91B	2 MxLvl2
+ 50.0	+ 50.0	+ 50.0	-----	-----	
Mix5 0	Mix6 0	Mix7 0	Mix8 0	Mix9 0	
+100.0	+100.0	+100.0	-----	-----	

Memory No.	Card 2
Name	1 - 2 Vocal Brit Room

## ALG (ALGORITHM)

Alamd1	Alamd2	ROUTER	1-2
Reverb	Reverb		
ROUTER1	ROUTER2		
Stack	Stack		
Gate 1	Gate 2		
OFF	OFF		

ALG  
 1 ALG

ALG  
 1 Move  
 2 Joint

## HELP

Rev	Block1	PARAM
1/0	1-2	1 Rev1
Reverb	Stack	2 EQ1
SubRev		3 Rev2
ER		4 EQ2
ER		5 next

C 2 1-2 Vocal Brit Room

Rev	Block2	PARAM
1/0	1-2	1 Rev1
Reverb	Stack	2 EQ1
SubRev		3 Rev2
ER		4 EQ2
ER		5 next

C 2 1-2 Vocal Brit Room

## PARAM (PARAMETER)

Rev1

Type	Size	RevTm	ERLvl	Bright
Hall	14	1.50	0	94

PARAM  
 1 Rev1  
 2 EQ1  
 3 Rev2  
 4 EQ2  
 5 next

Type	Size	PreDly	RevTm	Dnstr
Hall	14	6	1.50	90
LowDmp	LowFrs	HiDmp	HiFrs	
1.00	73	0.94	14201	

Rev1  
 1 Reverb  
 2 SubRev  
 3 ER

PreDly	Level
40	30

Rev1  
 1 Reverb  
 2 SubRev  
 3 ER

ER

Form	L1	L2	L3	Dnstr
2	0	0	0	49
PreDly	T1	T2	T3	T4
12	15	18	38	416

Rev1  
 1 Reverb  
 2 SubRev  
 3 ER

EQ1

Low Q	Freq	Gain	Type
-----	1111	-10.0	Shlvs
Mid Q	Freq	Gain	
-----	1.0	1000	0.0
High Q	Freq	Gain	Type
-----	2000	3.0	Shlvs

CONTROL  
↓  
GRAPH

PARAM  
 1 Rev1  
 2 EQ1  
 3 Rev2  
 4 EQ2  
 5 next

PARAM  
 1 Rev1  
 2 EQ1  
 3 Rev2  
 4 EQ2  
 5 next

PRESS CONTROL KEY

Rev2

Type	Size	Revlm	ERLvl	Bright
Room	14	1.50	0	55

PARAM  
1 Rev1  
2 EQ1  
3 Rev2  
4 EQ2  
5 next

Type	Size	Revlm	ERLvl	Dnste
Room	14	2	1.50	20

LowDmp	LowFra	HiDmp	HiFra
1.00	60	0.55	6033

Rev2  
1 Reverb  
2 SubRev  
3 ER

100%

5s

PreDly	Level
0	30

Rev2  
1 Reverb  
2 SubRev  
3 ER

ER

Form	L1	L2	L3	Dnste
1	0	0	0	49

PreDly	T1	T2	T3	T4
12	15	18	38	416

Rev2  
1 Reverb  
2 SubRev  
3 ER

EQ2

Low Q	Freq	Gain	Type
---	500	0.0	Shlvs

Mid Q	Freq	Gain	Type
---	1.0	1000	0.0

High Q	Freq	Gain	Type
---	2000	-12.0	Shlvs

CONTROL  
↓  
GRAPH

PARAM  
1 Rev1  
2 EQ1  
3 Rev2  
4 EQ2  
5 next

12  
0  
-12

50 100 500 1k 5k 10k

PRESS CONTROL KEY

PARAM  
1 Rev1  
2 EQ1  
3 Rev2  
4 EQ2  
5 next

MIXER

I/O Lvl

InA	InA 0	InB	InB 0
+100.0	+ 0.0	+100.0	+ 0.0

Out1	Out2	Out3	Out4
+100.0	+100.0	+100.0	+100.0

Out1	Out2	Out3	Out4
+ 0.0	+ 0.0	+ 0.0	+ 0.0

InLvl  
1 I/O Lvl

MX Lvl

Mix01A	Mix11A	Mix21A	Mix31A	Mix41A
+ 50.0	+ 80.0	+ 80.0	-----	+ 50.0

Mix01B	Mix11B	Mix21B	Mix31B	Mix41B
+ 50.0	+ 80.0	+ 80.0	-----	+ 50.0

Mix5 0	Mix6 0	Mix7 0	Mix8 0	Mix9 0
+100.0	+100.0	+100.0	-----	+100.0

MxLvl  
1 MxLvl1  
2 MxLvl2

Mix51A	Mix61A	Mix71A	Mix81A	Mix91A
+ 50.0	+ 50.0	+ 50.0	-----	

Mix51B	Mix61B	Mix71B	Mix81B	Mix91B
+ 50.0	+ 50.0	+ 50.0	-----	

Mix5 0	Mix6 0	Mix7 0	Mix8 0	Mix9 0
+100.0	+100.0	+100.0	-----	

MxLvl  
1 MxLvl1  
2 MxLvl2

Memory No.	Card 3
Name	1 - 2 Vocal Warm Plate

## ALG (ALGORITHM)

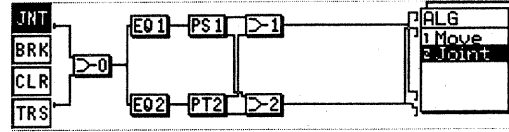
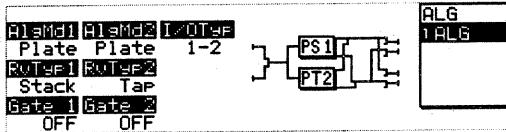

## HELP

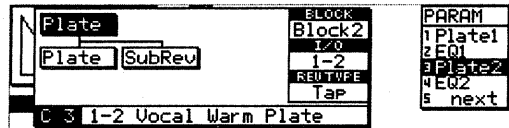
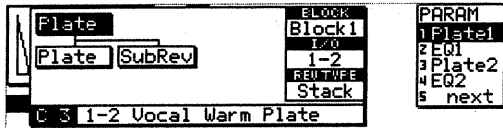

## PARM (PARAMETER)

Plate1

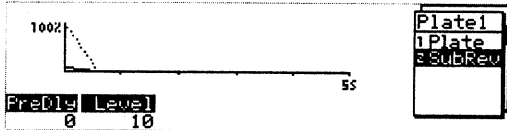
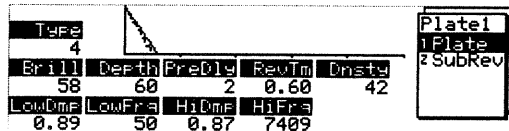

EQ1

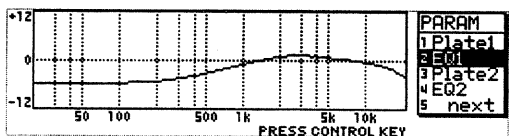
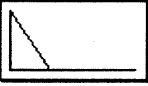





Plate2



Type	RevTm	Bright
1	1.60	3

PARAM				
1	Plat1			
2	EQ1			
3	Plate2			
4	EQ2			
5	next			



Type	Brill	Depth	PreDly	RevTm	EDnsty
1	24	87	61	1.60	43
LowDmp	LowFra	HiDmp	HiFra	RDnsty	
0.78	50	0.50	4912	80	

Plate2	
1	Plate
2	SubRev

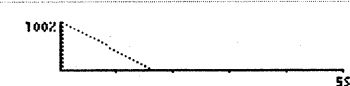

PreDly	Level
0	0

Plate2	
1	Plate
2	SubRev

EQ2

Low	Q	Freq	Gain	Type
0.8		106	2.4	Peakns
Mid	Q	Freq	Gain	
0.5		474	4.3	
High	Q	Freq	Gain	Type
-----		3245	- 6.0	Shlvs

PARAM				
1	Plat1			
2	EQ1			
3	Plate2			
4	EQ2			
5	next			

CONTROL  
↓  
GRAPH

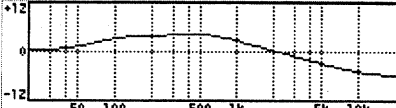

PARAM				
1	Plat1			
2	EQ1			
3	Plate2			
4	EQ2			
5	next			

PRESS CONTROL KEY

MIXER

I/O Lvl

InA	A	InB	B	InC	C	InD	D
+100.0	+	0.0	+	+100.0	+	0.0	+
Out1	A	Out2	B	Out3	C	Out4	D
+100.0	+	+100.0	+	+100.0	+	+100.0	+
Out1	B	Out2	C	Out3	D	Out4	E
+ 0.0	+	0.0	+	0.0	+	0.0	+

InLvl	
1	I/O Lvl

MIX Lvl

Mix01A	Mix11A	Mix21A	Mix31A	Mix41A
+ 50.0	+	60.0	+	60.0
Mix01B	Mix11B	Mix21B	Mix31B	Mix41B
+ 50.0	+	+100.0	+	+100.0
Mix0	Mix1	Mix2	Mix3	Mix4
+ 50.0	+	+100.0	+	+100.0

MxLvl	
1	MxLvl1
2	MxLvl2

Mix51A	Mix61A	Mix71A	Mix81A	Mix91A
Mix51B	Mix61B	Mix71B	Mix81B	Mix91B
Mix5	Mix6	Mix7	Mix8	Mix9

MxLvl	
1	MxLvl1
2	MxLvl2

Memory No.	Card 4
Name	1 - 2 Vocal Brit Plate

## ALG (ALGORITHM)

AlaMd1	AlaMd2	1/OTYP	
Reverb	Plate	1-2	
RUTyp1	RUTyp2		
Stack	Stack		
Gate 1	Gate 2		
OFF	OFF		

ALG	1 ALG
-----	-------

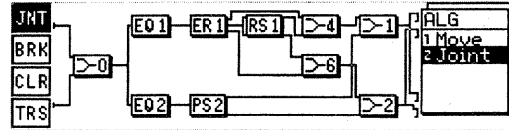

## HELP

Rev		BLOCK	Block1	PARAM	1 Rev1
Reverb	SubRev	ER	1-2	2 EQ1	3 Plate2
		ER	Stack	4 EQ2	5 next
C 4 1-2 Vocal Brit Plate					

Plate		BLOCK	Block2	PARAM	1 Rev1
Plate	SubRev	1-2	RETIME	2 EQ1	3 Plate2
C 4 1-2 Vocal Brit Plate					

## PARAM (PARAMETER)

### Rev1

Type	Size	RevTm	ERLvl	Bright
Room	23	0.50	30	80

PARAM	1 Rev1
2 EQ1	3 Plate2
4 EQ2	5 next

Type	Size	PreDly	RevTm	Dnsty
Room	23	8	0.50	0
LowDm	LowFrs	HiDm	HiFrs	
0.96	60	0.80	8792	

Rev1	1 Reverb
2 SubRev	3 ER

PreDly	Level
0	0

Rev1	1 Reverb
2 SubRev	3 ER

### ER

Form	L1	L2	L3	Dnsty
1	25	30	12	39
PreDly	T1	T2	T3	T4
15	17	22	13	240

Rev1	1 Reverb
2 SubRev	3 ER

### EQ1

Low Q	Freq	Gain	Type
-----	117	- 0.6	Shlvs
Mid Q	Freq	Gain	
-----	0.6	3119	1.8
High Q	Freq	Gain	Type
-----	15183	- 5.0	Shlvs

CONTROL  
↓  
GRAPH

PARAM	1 Rev1
2 EQ1	3 Plate2
4 EQ2	5 next

PARAM	1 Rev1
2 EQ1	3 Plate2
4 EQ2	5 next

PRESS CONTROL KEY

### Plate2



Type	RevTm	Bright
4	1.40	45

PARAM	
1 Rev1	
2 EQ1	
3 Plate2	
4 EQ2	
5 next	

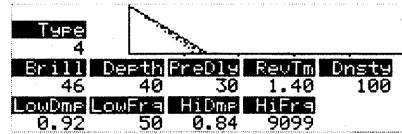

Type	Depth	PreDly	RevTm	DnStg
4	46	40	30	1.40
100				
LowDmf	LowFrs	HiDmf	HiFrs	
0.92	50	0.84	9099	

PARAM	
1 Plate2	
2 SubRev	

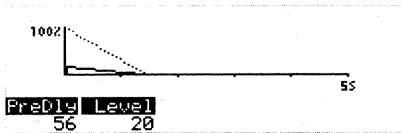

PreDly	Level
56	20

PARAM	
1 Plate2	
2 SubRev	

### EQ2

Low Q	Freq	Gain	Type
---	20	0.0	Shlvs
Mid Q	Freq	Gain	Type
0.5	1948	2.2	
High Q	Freq	Gain	Type
---	8281	-1.6	Shlvs

PARAM	
1 Rev1	
2 EQ1	
3 Plate2	
4 EQ2	
5 next	

CONTROL  
↓  
GRAPH

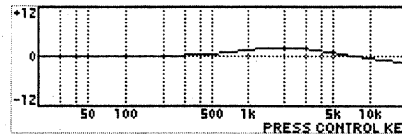

PARAM	
1 Rev1	
2 EQ1	
3 Plate2	
4 EQ2	
5 next	

PRESS CONTROL KEY

## MIXER

### I/OLvl

InA 0	InA 1	InB 0	InB 1
+100.0	+ 0.0	+100.0	+ 0.0
Out1 A	Out2 A	Out3 A	Out4 A
+100.0	+100.0	+100.0	+100.0
Out1 B	Out2 B	Out3 B	Out4 B
+ 0.0	+ 0.0	+ 0.0	+ 0.0

InLvl	
1 I/OLvl	

### MXLvl

Mix01A	Mix11A	Mix21A	Mix31A	Mix41A
+ 50.0	+ 75.0	+ 75.0	-----	+ 50.0
Mix01B	Mix11B	Mix21B	Mix31B	Mix41B
+ 50.0	+ 50.0	+ 50.0	-----	+ 50.0
Mix0 0	Mix1 0	Mix2 0	Mix3 0	Mix4 0
+100.0	+100.0	+100.0	-----	+100.0

MxLvl	
1 MxLvl1	
2 MxLvl2	

Mix51A	Mix61A	Mix71A	Mix81A	Mix91A
-----	+ 50.0	-----	-----	-----
Mix51B	Mix61B	Mix71B	Mix81B	Mix91B
-----	+ 50.0	-----	-----	-----
Mix5 0	Mix6 0	Mix7 0	Mix8 0	Mix9 0
-----	+100.0	-----	-----	-----

MxLvl	
1 MxLvl1	
2 MxLvl2	

Memory No.	Card 5
Name	1 - 2 Vocal Hall

## ALG (ALGORITHM)

AlsmD1 AlsmD2 1/0Tap  
 Reverb <--- 1-2  
 ROTyp1 ROTyp2  
 Tap <---  
 Gate 1 Gate 2  
 OFF OFF

ALG  
1 ALG

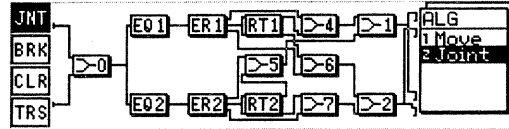

## HELP

Rev  
 Reverb SubRev ER  
 ER  
 C 5 1-2 Vocal Hall

BLOCK  
 SYNC  
 1/0  
 1-2  
 REUTYPE  
 Tap

PARAM  
 1 Rev  
 2 EQ  
 5 next

## PARAM (PARAMETER)

Rev

Type Size RevTm ERLvl Bright  
 Hall 43 1.60 38 70

PARAM  
 1 Rev  
 2 EQ  
 5 next

Type	Size	PreDly	RevTm	EDnsts
Hall	43	22	1.60	80
LowDmp	LowFrs	HiDmp	HiFrs	RDnsts
0.95	116	0.70	5083	80

Rev  
 1 Reverb  
 2 SubRev  
 3 ER

PreDly Level  
 90 40

Rev  
 1 Reverb  
 2 SubRev  
 3 ER

ER

Form	L1	L2	L3	Dnsts
4	39	38	24	64
PreDly	T1	T2	T3	T4
16	33	30	41	66

Rev  
 1 Reverb  
 2 SubRev  
 3 ER

EQ

Low	Q	Freq	Gain	Type
---	---	500	0.0	Shlvs
Mid	Q	Freq	Gain	
1.0	---	1000	0.0	
High	Q	Freq	Gain	Type
3.4	---	10323	-3.0	Peakns

CONTROL  
 ↓  
 GRAPH

PARAM  
 1 Rev  
 2 EQ  
 5 next

PARAM  
 1 Rev  
 2 EQ  
 5 next

PRESS CONTROL KEY

# MIXER

I/O Lvl

InA 0	InA 0	InB 0	InB 0	InLvl
+100.0	+ 0.0	+100.0	+ 0.0	I/O Lvl
Out1 A	Out2 A	Out3 A	Out4 A	
+100.0	+100.0	+100.0	+100.0	
Out1 B	Out2 B	Out3 B	Out4 B	
+ 0.0	+ 0.0	+ 0.0	+ 0.0	

MX Lvl

Mix01A	Mix11A	Mix21A	Mix31A	Mix41A	MxLvl
+ 50.0	+ 65.0	+ 65.0	-----	+ 50.0	1 MxLvl1
Mix01B	Mix11B	Mix21B	Mix31B	Mix41B	2 MxLvl2
+ 50.0	+ 65.0	+ 65.0	-----	+ 50.0	
Mix5 0	Mix6 0	Mix7 0	Mix8 0	Mix9 0	
+100.0	+100.0	+100.0	-----	+100.0	

Mix51A	Mix61A	Mix71A	Mix81A	Mix91A	MxLvl
+ 50.0	+ 50.0	+ 50.0	-----	-----	1 MxLvl1
Mix51B	Mix61B	Mix71B	Mix81B	Mix91B	2 MxLvl2
+ 50.0	+ 50.0	+ 50.0	-----	-----	
Mix5 0	Mix6 0	Mix7 0	Mix8 0	Mix9 0	
+100.0	+100.0	+100.0	-----	-----	

Memory No.	Card 6
Name	1 - 2 Brass Room

## ALG (ALGORITHM)

Alamd1	Alamd2	I/OType	
Reverb	Plate	1-2	
ROUTEP1	ROUTEP2		
Stack	Stack		
Gate1	Gate2		
OFF	OFF		

ALG
1 ALG

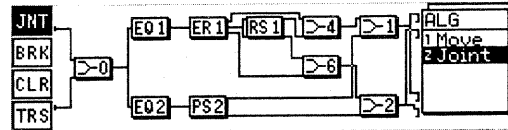

## HELP

Rev	BLOCK	PARAM
Reverb	Block1	1 Rev1
SubRev	I/O	2 EQ1
ER	1-2	3 Plate2
ER	REUTYPE	4 EQ2
ER	Stack	5 next

C 6 1-2 Brass Room

Plate	BLOCK	PARAM
Plate	Block2	1 Rev1
SubRev	I/O	2 EQ1
	1-2	3 Plate2
	REUTYPE	4 EQ2
	Stack	5 next

C 6 1-2 Brass Room

## PARAM (PARAMETER)

Rev1

Type	Size	RevTm	ERLvl	Bright
Room	14	0.90	44	90

PARAM
1 Rev1
2 EQ1
3 Plate2
4 EQ2
5 next

Type	Size	PreDly	RevTm	DnSty
Room	14	13	0.90	25
LowDm	LowFr	HiDm	HiFr	
0.95	60	0.90	9744	

Rev1
1 Reverb
2 SubRev
3 ER

PreDly	Level
19	30

Rev1
1 Reverb
2 SubRev
3 ER

ER

Form	L1	L2	L3	DnSty
1	37	44	17	49
PreDly	T1	T2	T3	T4
12	15	18	22	322

Rev1
1 Reverb
2 SubRev
3 ER

EQ1

Low Q	Freq	Gain	Type
-----	500	0.0	Shlvs
Mid Q	Freq	Gain	
-----	1.0	1000	0.0
High Q	Freq	Gain	Type
-----	2000	0.0	Shlvs

CONTROL  
↓  
GRAPH

PARAM
1 Rev1
2 EQ1
3 Plate2
4 EQ2
5 next

PARAM
1 Rev1
2 EQ1
3 Plate2
4 EQ2
5 next

PRESS CONTROL KEY

Plate2

PARAM  
 1 Rev1  
 2 EQ1  
 3 Plate2  
 4 EQ2  
 5 next

Type RevTm Bright  
 3 0.70 50

Type	3
Brill	50
Depth	50
PreDly	16
RevTm	0.70
Dnsta	100
LowDms	0.86
LowFra	50
HiDms	0.91
HiFra	7409

Plate2  
 1 Plate  
 2 SubRev

Plate2  
 1 Plate  
 2 SubRev

PreDly Level  
 0 25

EQ2

Low Q	Freq	Gain	Type
---	500	0.0	Shlvs
Mid Q	Freq	Gain	Type
---	1.0	1000	0.0
High Q	Freq	Gain	Type
---	2000	0.0	Shlvs

PARAM  
 1 Rev1  
 2 EQ1  
 3 Plate2  
 4 EQ2  
 5 next

CONTROL  
 ↓  
 GRAPH

PARAM  
 1 Rev1  
 2 EQ1  
 3 Plate2  
 4 EQ2  
 5 next

50 100 500 1k 5k 10k  
 PRESS CONTROL KEY

MIXER

I/O Lvl

InA A	InA 0	InB A	InB 0
+100.0	+ 0.0	+100.0	+ 0.0
Out1 A	Out2 A	Out3 A	Out4 A
+100.0	+100.0	+100.0	+100.0
Out1 B	Out2 B	Out3 B	Out4 B
+ 0.0	+ 0.0	+ 0.0	+ 0.0

InLvl  
 1 I/O Lvl

MX Lvl

Mix01A	Mix11A	Mix21A	Mix31A	Mix41A
+ 50.0	+ 70.0	+ 70.0	-----	+ 50.0
Mix01B	Mix11B	Mix21B	Mix31B	Mix41B
+ 50.0	+ 45.0	+ 45.0	-----	+ 50.0
Mix0 0	Mix1 0	Mix2 0	Mix3 0	Mix4 0
+100.0	+100.0	+100.0	-----	+100.0

MxLvl  
 1 MxLvl1  
 2 MxLvl2

Mix51A	Mix61A	Mix71A	Mix81A	Mix91A
+ 50.0	-----	-----	-----	-----
Mix51B	Mix61B	Mix71B	Mix81B	Mix91B
+ 50.0	-----	-----	-----	-----
Mix5 0	Mix6 0	Mix7 0	Mix8 0	Mix9 0
+100.0	-----	-----	-----	-----

MxLvl  
 1 MxLvl1  
 2 MxLvl2





Rev2

Type	Size	Revlm	ERLvl	Bright
Room	29	1.20	20	70

PARAM  
1 Rev1  
2 EQ1  
3 Rev2  
4 EQ2  
5 next

Type	Size	PreDly	Revlm	EDnsty
Room	29	26	1.20	62
LowDmp	LowFrc	HiDmp	HiFrc	RDnsty
0.95	60	0.70	6033	52

Rev2  
1 Reverb  
2 SubRev  
3 ER

100%

PreDly Level  
36 25

5s

Rev2  
1 Reverb  
2 SubRev  
3 ER

ER

Form	L1	L2	L3	Dnsty
1	17	20	9	34
PreDly	T1	T2	T3	T4
16	18	25	33	372

500

Rev2  
1 Reverb  
2 SubRev  
3 ER

EQ2

Low Q	Freq	Gain	Type
---	500	2.0	Shlvs
Mid Q	Freq	Gain	Type
---	1.0	1000	3.0
High Q	Freq	Gain	Type
---	2000	0.0	Shlvs

CONTROL  
GRAPH

PARAM  
1 Rev1  
2 EQ1  
3 Rev2  
4 EQ2  
5 next

PARAM  
1 Rev1  
2 EQ1  
3 Rev2  
4 EQ2  
5 next

12  
0  
-12

50 100 500 1k 5k 10k

PRESS CONTROL KEY

MIXER

I/OLvl

InA A	InA 0	InB A	InB 0
+100.0	+ 0.0	+100.0	+ 0.0
Out1 A	Out2 A	Out3 A	Out4 A
+100.0	+100.0	+100.0	+100.0
Out1 B	Out2 B	Out3 B	Out4 B
+ 0.0	+ 0.0	+ 0.0	+ 0.0

InLvl  
1 I/OLvl

MXLvl

Mix01A	Mix11A	Mix21A	Mix31A	Mix41A
+ 50.0	+ 65.0	+ 65.0	-----	+ 50.0
Mix01B	Mix11B	Mix21B	Mix31B	Mix41B
+ 50.0	+ 65.0	+ 65.0	-----	+ 50.0
Mix0 0	Mix1 0	Mix2 0	Mix3 0	Mix4 0
+100.0	+100.0	+100.0	-----	+100.0

MxLvl  
1 MxLvl1  
2 MxLvl2

Mix51A	Mix61A	Mix71A	Mix81A	Mix91A
+ 50.0	+ 50.0	+ 50.0	-----	-----
Mix51B	Mix61B	Mix71B	Mix81B	Mix91B
+ 50.0	+ 50.0	+ 50.0	-----	-----
Mix5 0	Mix6 0	Mix7 0	Mix8 0	Mix9 0
+100.0	+100.0	+100.0	-----	-----

MxLvl  
1 MxLvl1  
2 MxLvl2

Memory No.	Card 8
Name	1 - 2 Brass Plate

## ALG (ALGORITHM)

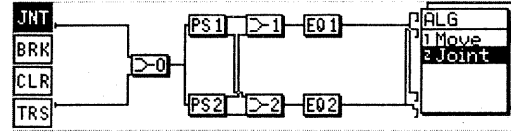
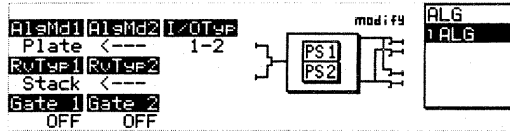

## HELP

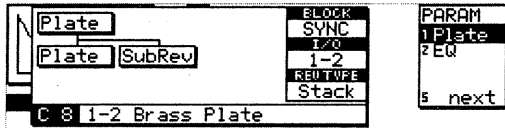

## PARAM (PARAMATER)

Plate

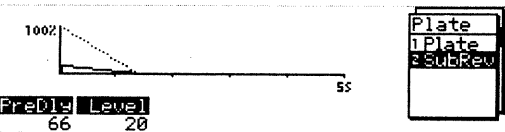

EQ

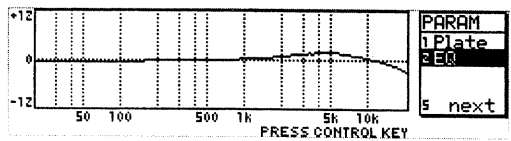
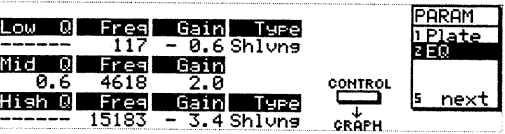

# MIXER

I/O Lvl

InA A	InA 0	InB A	InB 0	InLvl
+100.0	+ 0.0	+100.0	+ 0.0	1 I/O Lvl
Out1 A	Out2 A	Out3 A	Out4 A	
+100.0	+100.0	+100.0	+100.0	
Out1 B	Out2 B	Out3 B	Out4 B	
+ 0.0	+ 0.0	+ 0.0	+ 0.0	

MX Lvl

Mix01A	Mix11A	Mix21A	Mix31A	Mix41A	MxLvl
+ 50.0	+ 50.0	+ 50.0	-----	-----	1 MxLvl1
Mix01B	Mix11B	Mix21B	Mix31B	Mix41B	2 MxLvl2
+ 50.0	+ 50.0	+ 50.0	-----	-----	
Mix0 0	Mix1 0	Mix2 0	Mix3 0	Mix4 0	
+100.0	+100.0	+100.0	-----	-----	

Mix51A	Mix61A	Mix71A	Mix81A	Mix91A	MxLvl
-----	-----	-----	-----	-----	1 MxLvl1
Mix51B	Mix61B	Mix71B	Mix81B	Mix91B	2 MxLvl2
-----	-----	-----	-----	-----	
Mix5 0	Mix6 0	Mix7 0	Mix8 0	Mix9 0	
-----	-----	-----	-----	-----	



# MIXER

## I/OLvl

InA A	InA 0	InB A	InB 0	InLvl
+100.0	+ 0.0	+100.0	+ 0.0	1 I/OLvl
Out1 A	Out2 A	Out3 A	Out4 A	
+100.0	+100.0	+100.0	+100.0	
Out1 B	Out2 B	Out3 B	Out4 B	
+ 0.0	+ 0.0	+ 0.0	+ 0.0	

## MXLvl

Mix0IA	Mix1IA	Mix2IA	Mix3IA	Mix4IA	MxLvl
-----	+ 60.0	+ 60.0	-----	-----	1 MxLvl1
Mix0IB	Mix1IB	Mix2IB	Mix3IB	Mix4IB	2 MxLvl2
-----	+ 60.0	+ 60.0	-----	-----	
Mix0 0	Mix1 0	Mix2 0	Mix3 0	Mix4 0	
-----	+100.0	+100.0	-----	-----	

Mix5IA	Mix6IA	Mix7IA	Mix8IA	Mix9IA	MxLvl
-----	-----	-----	-----	-----	1 MxLvl1
Mix5IB	Mix6IB	Mix7IB	Mix8IB	Mix9IB	2 MxLvl2
-----	-----	-----	-----	-----	
Mix5 0	Mix6 0	Mix7 0	Mix8 0	Mix9 0	
-----	-----	-----	-----	-----	



### Rev2

Type	Size	Revlm	ERLvl	Bright
Hall	29	1.50	50	66

PARAM  
1 Plate1  
2 EQ1  
3 Rev2  
4 EQ2  
5 next

Type	Size	PreDly	Revlm	EDnste
Hall	29	40	1.50	64
LowDmp	LowFrs	HiDmp	HiFrs	RDnste
0.90	80	0.66	4433	80

Rev2  
1 Reverb  
2 SubRev  
3 ER

100%

PreDly Level  
70 38

5s

Rev2  
1 Reverb  
2 SubRev  
3 ER

### ER

Form	L1	L2	L3	Dnste
2	45	55	25	84
PreDly	T1	T2	T3	T4
16	14	18	54	80

Rev2  
1 Reverb  
2 SubRev  
3 ER

### EQ2

Low Q	Freq	Gain	Type
---	500	0.0	Shlvs
Mid Q	Freq	Gain	Type
1.0	1000	0.0	---
High Q	Freq	Gain	Type
---	2000	0.0	Shlvs

CONTROL  
↓  
GRAPH

PARAM  
1 Plate1  
2 EQ1  
3 Rev2  
4 EQ2  
5 next

PARAM  
1 Plate1  
2 EQ1  
3 Rev2  
4 EQ2  
5 next

PRESS CONTROL KEY

## MIXER

### I/OLvl

InA A	InA 0	InB A	InB 0
+100.0	+ 0.0	+100.0	+ 0.0
Out1 A	Out2 A	Out3 A	Out4 A
+100.0	+100.0	+100.0	+100.0
Out1 B	Out2 B	Out3 B	Out4 B
+ 0.0	+ 0.0	+ 0.0	+ 0.0

InLvl  
1 I/OLvl

### MXLvl

Mix01A	Mix11A	Mix21A	Mix31A	Mix41A
+ 50.0	+ 55.0	+ 55.0	-----	-----
Mix01B	Mix11B	Mix21B	Mix31B	Mix41B
+ 50.0	+ 61.0	+ 61.0	-----	-----
Mix0 0	Mix1 0	Mix2 0	Mix3 0	Mix4 0
+100.0	+100.0	+100.0	-----	-----

MxLvl  
1 MxLvl1  
2 MxLvl2

Mix51A	Mix61A	Mix71A	Mix81A	Mix91A
+ 50.0	-----	+ 50.0	-----	-----
Mix51B	Mix61B	Mix71B	Mix81B	Mix91B
+ 50.0	-----	+ 50.0	-----	-----
Mix5 0	Mix6 0	Mix7 0	Mix8 0	Mix9 0
+100.0	-----	+100.0	-----	-----

MxLvl  
1 MxLvl1  
2 MxLvl2





# MIXER

I/OLvl

InA	InA	InB	InB	InLvl
+100.0	+ 0.0	+100.0	+ 0.0	
Out1	Out2	Out3	Out4	
+100.0	+100.0	+100.0	+100.0	
Out1	Out2	Out3	Out4	
+ 0.0	+ 0.0	+ 0.0	+ 0.0	

MXLvl

Mix0A	Mix1A	Mix2A	Mix3A	Mix4A	MxLvl
-----	+ 95.0	+ 40.0	-----	+ 50.0	
Mix0B	Mix1B	Mix2B	Mix3B	Mix4B	1 MxLvl1
-----	+ 40.0	+ 95.0	-----	+ 50.0	
Mix0	Mix1	Mix2	Mix3	Mix4	2 MxLvl2
-----	+100.0	+100.0	-----	+100.0	

Mix5A	Mix6A	Mix7A	Mix8A	Mix9A	MxLvl
+ 50.0	+ 50.0	+ 50.0	-----	-----	
Mix5B	Mix6B	Mix7B	Mix8B	Mix9B	1 MxLvl1
+ 50.0	+ 50.0	+ 50.0	-----	-----	
Mix5	Mix6	Mix7	Mix8	Mix9	2 MxLvl2
+100.0	+100.0	+100.0	-----	-----	

Memory No.	Card 12
Name	1 - 2 Strings Room 1

## ALG (ALGORITHM)

AlcMdl1	AlcMdl2	1/0TAP
Reverb	Reverb	1-2
RT1	RT2	
Stack	Tap	
Gate 1	Gate 2	
OFF	OFF	

ALG
1 ALG

JRT
BRK
CLR
TRS

ALG
1 Move
2 Joint

## HELP

Rev		
Reverb	SubRev	ER
IER		
012 1-2 Strings Room 1		

BLOCK
Block1
1/0
1-2
REU TYP
Stack

PARAM
1 Rev1
2 EQ1
3 Rev2
4 EQ2
5 next

Rev		
Reverb	SubRev	ER
IER		
012 1-2 Strings Room 1		

BLOCK
Block2
1/0
1-2
REU TYP
Tap

PARAM
1 Rev1
2 EQ1
3 Rev2
4 EQ2
5 next

## PARAM (PARAMETER)

Rev1

Type	Size	RevTm	ERLvl	Bright
Room	14	0.38	30	94

PARAM
1 Rev1
2 EQ1
3 Rev2
4 EQ2
5 next

Type	Size	PreDly	RevTm	Dnstr
Room	14	44	0.38	0
LowDm	LowFq	HiDm	HiFq	
0.95	60	0.94	9416	

Rev1
1 Reverb
2 SubRev
3 ER

PreDly	Level
13	30

Rev1
1 Reverb
2 SubRev
3 ER

ER

Form	L1	L2	L3	Dnstr
4	31	29	24	9
PreDly	T1	T2	T3	T4
4	14	4	10	50

Rev1
1 Reverb
2 SubRev
3 ER

EQ1

Low Q	Freq	Gain	Type
---	500	-1.0	Shlvs
Mid Q	Freq	Gain	
---	1.0	1000	0.0
High Q	Freq	Gain	Type
---	2000	0.0	Shlvs

CONTROL  
↓  
GRAPH

PARAM
1 Rev1
2 EQ1
3 Rev2
4 EQ2
5 next

PARAM
1 Rev1
2 EQ1
3 Rev2
4 EQ2
5 next

PRESS CONTROL KEY

Rev2

Type	Size	RevTm	ERLvl	Bright
Room	29	1.00	20	70

PARAM  
1 Rev1  
2 EQ1  
3 Rev2  
4 EQ2  
5 next

Type	Size	PreDly	RevTm	ERDnste
Room	29	60	1.00	38
LowDmF	LowFrs	HiDmF	HiFrs	RDnste
0.83	60	0.70	5444	60

Rev2  
1 Reverb  
2 SubRev  
3 ER

100%

PreDly Level  
36 25

Rev2  
1 Reverb  
2 SubRev  
3 ER

ER

Form	L1	L2	L3	Dnste
1	17	30	21	34
PreDly	T1	T2	T3	T4
16	18	25	27	340

Rev2  
1 Reverb  
2 SubRev  
3 ER

EQ2

Low Q	Freq	Gain	Type
	256	1.2	Shlvs
Mid Q	Freq	Gain	
	600	-3.0	
High Q	Freq	Gain	Type
	1500	-1.0	Peakns

CONTROL  
↓  
GRAPH

PARAM  
1 Rev1  
2 EQ1  
3 Rev2  
4 EQ2  
5 next

PARAM  
1 Rev1  
2 EQ1  
3 Rev2  
4 EQ2  
5 next

PRESS CONTROL KEY

MIXER

I/OLvl

InA A	InA 0	InB A	InB 0
+100.0	+ 0.0	+100.0	+ 0.0
Out1 A	Out2 A	Out3 A	Out4 A
+100.0	+100.0	+100.0	+100.0
Out1 B	Out2 B	Out3 B	Out4 B
+ 0.0	+ 0.0	+ 0.0	+ 0.0

InLvl  
1 I/OLvl

MXLvl

Mix01A	Mix11A	Mix21A	Mix31A	Mix41A
+ 50.0	+ 40.0	+ 40.0	-----	+ 50.0
Mix01B	Mix11B	Mix21B	Mix31B	Mix41B
+ 50.0	+ 96.0	+ 96.0	-----	+ 50.0
Mix5 0	Mix6 0	Mix7 0	Mix8 0	Mix9 0
+100.0	+100.0	+100.0	-----	+100.0

MxLvl  
1 MxLvl1  
2 MxLvl2

Mix51A	Mix61A	Mix71A	Mix81A	Mix91A
+ 50.0	+ 50.0	+ 50.0	-----	-----
Mix51B	Mix61B	Mix71B	Mix81B	Mix91B
+ 50.0	+ 50.0	+ 50.0	-----	-----
Mix5 0	Mix6 0	Mix7 0	Mix8 0	Mix9 0
+100.0	+100.0	+100.0	-----	-----

MxLvl  
1 MxLvl1  
2 MxLvl2

Memory No.	Card 13
Name	1 - 2 Strings Room 2

## ALG (ALGORITHM)

1 EQ1	1 EQ2	1/2 Tap
Reverb	Reverb	1-2
Stack	Tap	
Gate 1	Gate 2	
OFF	OFF	

ALG
1 ALG

ALG
1 Move
2 Joint

## HELP

Rev	Block1	PARAM
Reverb	SubRev	ER
ER	1-2	1 EQ1
ER	REUTWPE	2 Rev2
ER	Stack	3 EQ2
C13 1-2 Strings Room 2		4 next

Rev	Block2	PARAM
Reverb	SubRev	ER
ER	1-2	1 Rev1
ER	REUTWPE	2 EQ1
ER	Tap	3 Rev2
C13 1-2 Strings Room 2		4 EQ2
		5 next

## PARAM (PARAMETER)

Rev1

Type	Size	RevTm	ERLvl	Bright
Room	14	0.44	30	94

PARAM
1 Rev1
2 EQ1
3 Rev2
4 EQ2
5 next

Type	Size	PreDly	RevTm	Dnste
Room	14	48	0.44	4
LowDly	LowFrs	HiDly	HiFrs	
0.93	66	0.90	9099	

Rev1
1 Reverb
2 SubRev
3 ER

PreDly	Level
20	30

Rev1
1 Reverb
2 SubRev
3 ER

ER

Form	L1	L2	L3	Dnste
4	30	28	24	8
PreDly	T1	T2	T3	T4
12	15	5	12	60

Rev1
1 Reverb
2 SubRev
3 ER

EQ1

Low	Q	Freq	Gain	Type
---	---	500	-1.0	Shlvs
Mid	Q	Freq	Gain	
---	---	1.0	1000	0.0
High	Q	Freq	Gain	Type
---	---	2000	0.0	Shlvs

CONTROL  
↓  
GRAPH

PARAM
1 Rev1
2 EQ1
3 Rev2
4 EQ2
5 next

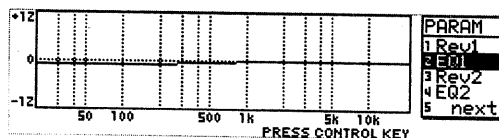

Rev2

Type	Size	RevTm	ERLvl	Bright
Room	29	2.10	20	62

PARAM  
1 Rev1  
2 EQ1  
3 Rev2  
4 EQ2  
5 next

Type	Size	PreDly	RevTm	EDnsts
Room	29	72	2.10	38
LowDmp	LowFra	HiDmp	HiFra	RDnsts
0.82	66	0.62	5261	70

Rev2  
1 Reverb  
2 SubRev  
3 ER

100%

PreDly Level

40 25

5s

Rev2  
1 Reverb  
2 SubRev  
3 ER

ER

500

Form	L1	L2	L3	Dnsts
1	16	28	20	28

PreDly	T1	T2	T3	T4
16	20	28	30	350

Rev2  
1 Reverb  
2 SubRev  
3 ER

EQ2

Low Q	Freq	Gain	Type
---	256	1.2	Shlvs
Mid Q	Freq	Gain	Type
0.8	600	-3.0	
High Q	Freq	Gain	Type
1.0	1500	-1.0	Peakns

CONTROL  
↓  
GRAPH

PARAM  
1 Rev1  
2 EQ1  
3 Rev2  
4 EQ2  
5 next

PARAM  
1 Rev1  
2 EQ1  
3 Rev2  
4 EQ2  
5 next

PRESS CONTROL KEY

MIXER

I/OLvl

InA A	InA 0	InB A	InB 0
+100.0	+ 0.0	+100.0	+ 0.0
Out1 A	Out2 A	Out3 A	Out4 A
+100.0	+100.0	+100.0	+100.0
Out1 B	Out2 B	Out3 B	Out4 B
+ 0.0	+ 0.0	+ 0.0	+ 0.0

InLvl  
1 I/OLvl

MXLvl

Mix01A	Mix11A	Mix21A	Mix31A	Mix41A
+ 50.0	+ 40.0	+ 40.0	-----	+ 50.0
Mix01B	Mix11B	Mix21B	Mix31B	Mix41B
+ 50.0	+ 88.0	+ 88.0	-----	+ 50.0
Mix0 0	Mix1 0	Mix2 0	Mix3 0	Mix4 0
+100.0	+100.0	+100.0	-----	+100.0

MxLvl  
1 MxLvl1  
2 MxLvl2

Mix51A	Mix61A	Mix71A	Mix81A	Mix91A
+ 50.0	+ 50.0	+ 50.0	-----	
Mix51B	Mix61B	Mix71B	Mix81B	Mix91B
+ 50.0	+ 50.0	+ 50.0	-----	
Mix5 0	Mix6 0	Mix7 0	Mix8 0	Mix9 0
+100.0	+100.0	+100.0	-----	

MxLvl  
1 MxLvl1  
2 MxLvl2

Memory No.	Card 14
Name	1 - 2 Strings Hall

## ALG (ALGORITHM)

AlsmD1	AlsmD2	1/0Tap
Reverb	Reverb	1-2
RT1	RT2	
Stack	Tap	
Gate 1	Gate 2	
OFF	OFF	

ALG
1 ALG

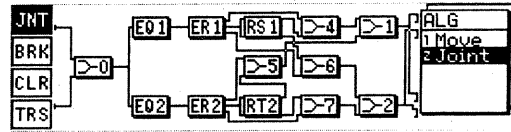

## HELP

Rev	Block1	PARAM
Reverb	SubRev	ER
1-2	REULTAPE	Stack
C14 1-2 Strins Hall		

Rev	Block2	PARAM
Reverb	SubRev	ER
1-2	REULTAPE	Tap
C14 1-2 Strins Hall		

## PARAM (PARAMETER)

### Rev1

Type	Size	RevTm	ERLvl	Bright
Room	14	0.80	0	20

PARAM
1 Rev1
2 EQ1
3 Rev2
4 EQ2
5 next

Type	Size	PreDly	RevTm	Dnsty
Room	14	48	0.80	22
LowDmp	LowFrs	HiDmp	HiFrs	
1.00	73	0.20	4433	

PARAM
1 Reverb
2 SubRev
3 ER

PreDly	Level
57	30

PARAM
1 Reverb
2 SubRev
3 ER

### ER

Form	L1	L2	L3	Dnsty
1	0	0	0	49
PreDly	T1	T2	T3	T4
12	15	18	20	304

PARAM
1 Reverb
2 SubRev
3 ER

### EQ1

Low Q	Freq	Gain	Type
	500	0.0	Shlvs
Mid Q	Freq	Gain	
	1.0	1000	0.0
High Q	Freq	Gain	Type
	2000	0.0	Shlvs

CONTROL  
↓  
GRAPH

PARAM
1 Rev1
2 EQ1
3 Rev2
4 EQ2
5 next

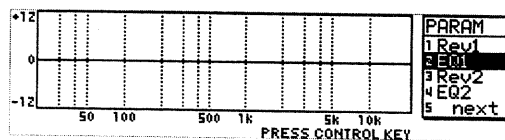



Rev2





Type	Size	RevTm	ERLvl	Bright
Room	51	4.00	0	94

PARAM	
1 Rev1	
2 EQ1	
3 Rev2	
4 EQ2	
5 next	

Type	Size	PreDly	RevTm	EDnstr
Room	51	83	4.00	20

LowDmp	LowFrs	HiDmp	HiFrs	RDnstr
1.00	50	0.94	10003	100

Rev2	
1 Reverb	
2 SubRev	
3 ER	

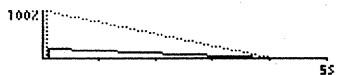

PreDly	Level
122	24

Rev2	
1 Reverb	
2 SubRev	
3 ER	

ER

Form	L1	L2	L3	Dnstr
1	0	0	0	21

PreDly	T1	T2	T3	T4
21	19	31	122	680

Rev2	
1 Reverb	
2 SubRev	
3 ER	

EQ2

Low Q	Freq	Gain	Type
---	1111	3.0	Shlvs

Mid Q	Freq	Gain
1.0	1000	0.0

High Q	Freq	Gain	Type
---	2000	0.0	Shlvs

CONTROL  
↓  
GRAPH

PARAM	
1 Rev1	
2 EQ1	
3 Rev2	
4 EQ2	
5 next	

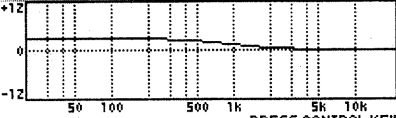

PARAM	
1 Rev1	
2 EQ1	
3 Rev2	
4 EQ2	
5 next	

PRESS CONTROL KEY

MIXER

I/OLvl

InA 0	InA 0	InB 0	InB 0
+ 50.0	+ 0.0	+ 50.0	+ 0.0

Out1 A	Out2 A	Out3 A	Out4 A
+100.0	+100.0	+100.0	+100.0

Out1 B	Out2 B	Out3 B	Out4 B
+ 0.0	+ 0.0	+ 0.0	+ 0.0

InLvl	
1 I/OLvl	

MXLvl

Mix01A	Mix11A	Mix21A	Mix31A	Mix41A
+ 50.0	+ 50.0	+ 50.0	-----	+ 70.0

Mix01B	Mix11B	Mix21B	Mix31B	Mix41B
+ 50.0	+100.0	+100.0	-----	+ 70.0

Mix0 0	Mix1 0	Mix2 0	Mix3 0	Mix4 0
+100.0	+100.0	+100.0	-----	+100.0

MXLvl	
1 MXLvl1	
2 MXLvl2	

Mix51A	Mix61A	Mix71A	Mix81A	Mix91A
+ 70.0	+ 70.0	+ 70.0	-----	-----

Mix51B	Mix61B	Mix71B	Mix81B	Mix91B
+ 70.0	+ 70.0	+ 70.0	-----	-----

Mix5 0	Mix6 0	Mix7 0	Mix8 0	Mix9 0
+100.0	+100.0	+100.0	-----	-----

MXLvl	
1 MXLvl1	
2 MXLvl2	

Memory No.	Card 15
Name	2-2 Drums Garage

## ALG (ALGORITHM)

Al1Md1 Al1Md2 I/O Tap  
 Reverb <--- 2-2  
 RvTep1 RvTep2  
 Tap <---  
 Gate 1 Gate 2  
 OFF OFF

ALG  
1 ALG

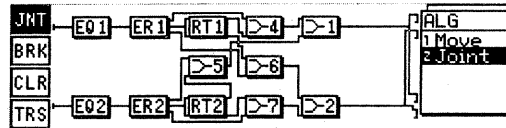

## HELP

Rev  
 Reverb [SubRev] ER  
 ER  
 Tap  
 G3 C15 2-2 Drums Garage

Block  
 SYNC  
 1-2  
 2-2  
 REVERSE  
 Tap

PARAM  
 1 Rev  
 2 EQ  
 5 next

## PARAM (PARAMETER)

### Rev

PARAM  
 1 Rev  
 2 EQ  
 5 next

Type	Size	RevTm	ERLvl	Bright
Garage	14	0.70	35	63

Rev  
 1 Reverb  
 2 SubRev  
 3 ER

Type	Size	PreDly	RevTm	EDnsty
Garage	14	6	0.70	80
LowDmp	LowFrs	HiDmp	HiFrs	RDnsty
0.98	96	0.63	6033	55

Rev  
 1 Reverb  
 2 SubRev  
 3 ER

PreDly	Level
58	22

### ER

Rev  
 1 Reverb  
 2 SubRev  
 3 ER

Form	L1	L2	L3	Dnsty
4	49	35	15	77
PreDly	T1	T2	T3	T4
6	15	32	41	34

### EQ

Low 0 Freq Gain Type  
 --- 500 0.0 Shlvs  
 Mid 0 Freq Gain  
 1.0 1000 0.0  
 High 0 Freq Gain Type  
 --- 2000 -1.0 Shlvs

CONTROL  
 ↓  
 GRAPH

PARAM  
 1 Rev  
 2 EQ  
 5 next

PARAM  
 1 Rev  
 2 EQ  
 5 next

PRESS CONTROL KEY



# MIXER

I/O Lvl

InA A	InA 0	InB A	InB 0	InLvl
+100.0	+ 0.0	+100.0	+ 0.0	1 I/O Lvl
Out1 A	Out2 A	Out3 A	Out4 A	
+100.0	+100.0	+100.0	+100.0	
Out1 B	Out2 B	Out3 B	Out4 B	
+ 0.0	+ 0.0	+ 0.0	+ 0.0	

MX Lvl

Mix01A	Mix11A	Mix21A	Mix31A	Mix41A	MxLvl
-----	+ 70.0	+ 70.0	-----	+ 50.0	1 MxLvl
Mix01B	Mix11B	Mix21B	Mix31B	Mix41B	2 MxLvl2
-----	+ 70.0	+ 70.0	-----	+ 50.0	
Mix0 0	Mix1 0	Mix2 0	Mix3 0	Mix4 0	
-----	+100.0	+100.0	-----	+100.0	

Mix51A	Mix61A	Mix71A	Mix81A	Mix91A	MxLvl
+ 50.0	+ 50.0	+ 50.0	-----	-----	1 MxLvl1
Mix51B	Mix61B	Mix71B	Mix81B	Mix91B	2 MxLvl2
+ 50.0	+ 50.0	+ 50.0	-----	-----	
Mix5 0	Mix6 0	Mix7 0	Mix8 0	Mix9 0	
+100.0	+100.0	+100.0	-----	-----	

Memory No.	Card 16
Name	1 - 2 Perc ambience

## ALG (ALGORITHM)

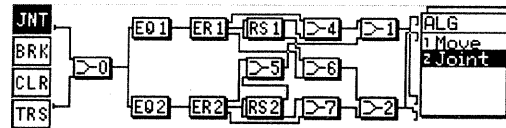
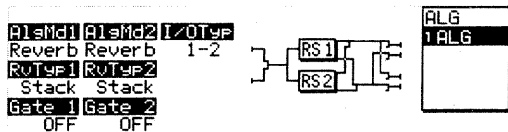

## HELP

Rev

Reverb | SubRev | ER

Block1

1-2

Stack

PARAM

1 Rev1

2 EQ1

3 Rev2

4 EQ2

5 next

D16 1-2 Perc ambience

Rev

Reverb | SubRev | ER

Block2

1-2

Stack

PARAM

1 Rev1

2 EQ1

3 Rev2

4 EQ2

5 next

D16 1-2 Perc ambience

## PARAM (PARAMETER)

Rev1

PARAM

1 Rev1

2 EQ1

3 Rev2

4 EQ2

5 next

Type	Size	RevTm	ERLvl	Bright
Room	6.2	0.60	0	51

Rev1

1 Reverb

2 SubRev

3 ER

Type	Size	PreDly	RevTm	Dnsty
Room	6.2	2	0.60	0
LowDmP	LowFrS	HiDmP	HiFrS	
1.00	244	0.51	4284	

ER

Rev1

1 Reverb

2 SubRev

3 ER

Form	L1	L2	L3	Dnsty
1	0	0	0	69
PreDly	T1	T2	T3	T4
6	12	14	13	263

EQ1

PARAM

1 Rev1

2 EQ1

3 Rev2

4 EQ2

5 next

Low Q	Freq	Gain	Type
311	3.0	Shlvs	
Mid Q	Freq	Gain	
1.0	1000	0.0	
High Q	Freq	Gain	Type
5949	-5.5	Shlvs	

CONTROL  
↓  
GRAPH

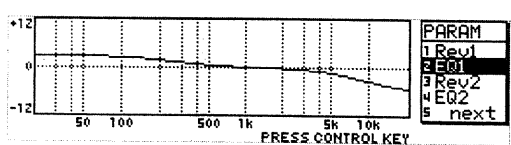

Rev2

Type	Size	RevTm	ERLvl	Bright
Room	9.4	0.50	0	55





PARAM
1 Rev1
2 EQ1
3 Rev2
4 EQ2
5 next

Type	Size	PreDly	RevTm	Dnsta
Room	9.4	63	0.50	0
LowDmp	LowFrs	HiDmp	HiFrs	
1.00	50	0.55	4747	

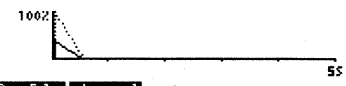

Rev2
1 Reverb
2 SubRev
3 ER



PreDly	Level
56	40

Rev2
1 Reverb
2 SubRev
3 ER

ER

Form	L1	L2	L3	Dnsta
1	0	0	0	58
PreDly	T1	T2	T3	T4
9	13	15	11	240



Rev2
1 Reverb
2 SubRev
3 ER

EQ2

Low Q	Frea	Gain	Type
---	460	5.0	Shlvs
Mid Q	Frea	Gain	
1.0	1000	0.0	
High Q	Frea	Gain	Type
---	5630	-3.8	Shlvs

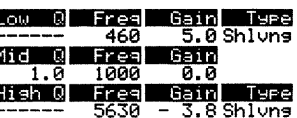

PARAM
1 Rev1
2 EQ1
3 Rev2
4 EQ2
5 next

CONTROL  
↓  
GRAPH

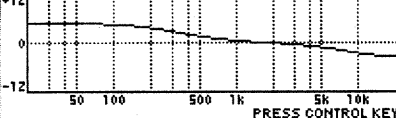

PARAM
1 Rev1
2 EQ1
3 Rev2
4 EQ2
5 next

PRESS CONTROL KEY

MIXER

I/O Lvl

InA A	InA 0	InB A	InB 0
+100.0	+ 0.0	+100.0	+ 0.0
Out1 A	Out2 A	Out3 A	Out4 A
+100.0	+100.0	+100.0	+100.0
Out1 B	Out2 B	Out3 B	Out4 B
+ 0.0	+ 0.0	+ 0.0	+ 0.0

InLvl
1 I/O Lvl

MX Lvl

Mix01A	Mix11A	Mix21A	Mix31A	Mix41A
+ 50.0	+ 80.0	+ 80.0	-----	+ 50.0
Mix01B	Mix11B	Mix21B	Mix31B	Mix41B
+ 50.0	+ 65.0	+ 65.0	-----	+ 50.0
Mix0 0	Mix1 0	Mix2 0	Mix3 0	Mix4 0
+100.0	+100.0	+100.0	-----	+100.0

MxLvl
1 MxLvl1
2 MxLvl2

Mix51A	Mix61A	Mix71A	Mix81A	Mix91A
+ 50.0	+ 50.0	+ 50.0	-----	-----
Mix51B	Mix61B	Mix71B	Mix81B	Mix91B
+ 50.0	+ 50.0	+ 50.0	-----	-----
Mix5 0	Mix6 0	Mix7 0	Mix8 0	Mix9 0
+100.0	+100.0	+100.0	-----	-----

MxLvl
1 MxLvl1
2 MxLvl2

Memory No.	Card 17
Name	1 - 2 Snare Drum

## ALG (ALGORITHM)

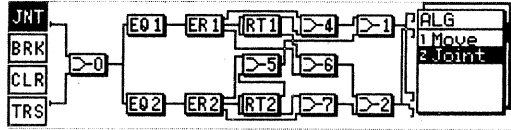
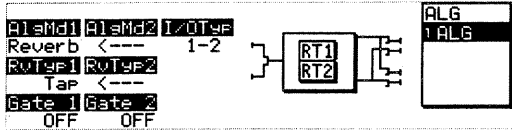

## HELP

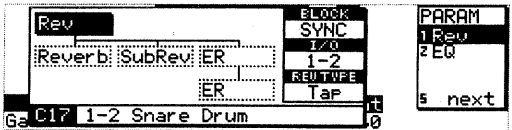

## PARAM (PARAMETER)

Rev

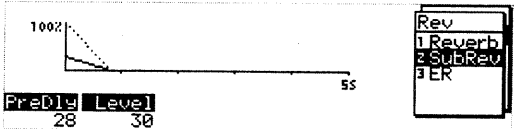
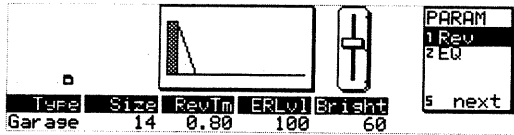

ER

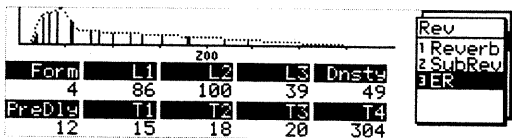

EQ

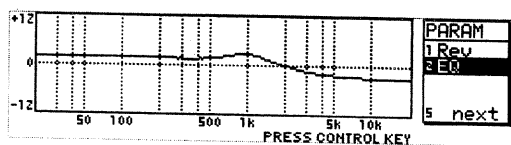
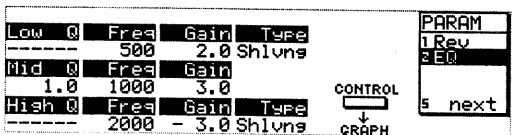

# MIXER

I/O Lvl

InA A	InA 0	InB A	InB 0	
+100.0	+ 0.0	+100.0	+ 0.0	
Out1 A	Out2 A	Out3 A	Out4 A	
+100.0	+100.0	+100.0	+100.0	
Out1 B	Out2 B	Out3 B	Out4 B	
+ 0.0	+ 0.0	+ 0.0	+ 0.0	

InLvl
1 I/O Lvl

MX Lvl

Mix01A	Mix11A	Mix21A	Mix31A	Mix41A	
+ 50.0	+ 60.0	+ 60.0	-----	+ 50.0	
Mix01B	Mix11B	Mix21B	Mix31B	Mix41B	
+ 50.0	+ 60.0	+ 60.0	-----	+ 50.0	
Mix0 0	Mix1 0	Mix2 0	Mix3 0	Mix4 0	
+100.0	+100.0	+100.0	-----	+100.0	

MxLvl
1 MxLvl1
2 MxLvl2

Mix51A	Mix61A	Mix71A	Mix81A	Mix91A	
+ 50.0	+ 50.0	+ 50.0	-----		
Mix51B	Mix61B	Mix71B	Mix81B	Mix91B	
+ 50.0	+ 50.0	+ 50.0	-----		
Mix5 0	Mix6 0	Mix7 0	Mix8 0	Mix9 0	
+100.0	+100.0	+100.0	-----		

MxLvl
1 MxLvl1
2 MxLvl2

Memory No.	Card 18
Name	1 - 2 Kick ambience

## ALG (ALGORITHM)

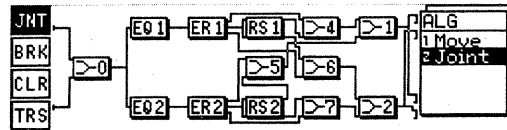
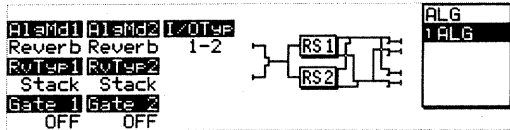

## HELP

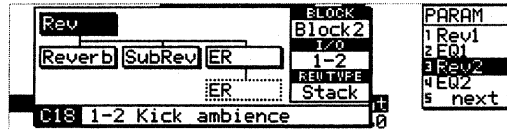
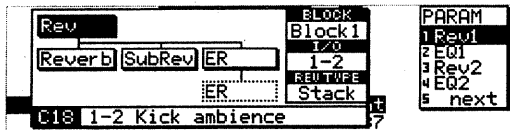

## PARAM (PARAMETER)

Rev1

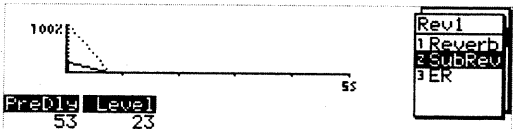
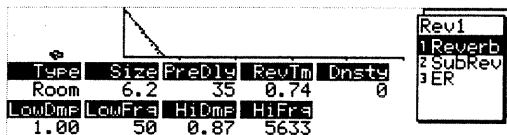
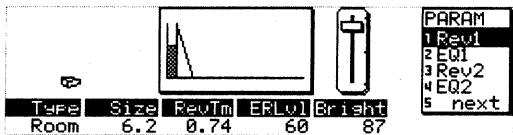

ER

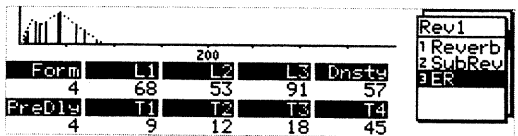

EQ1

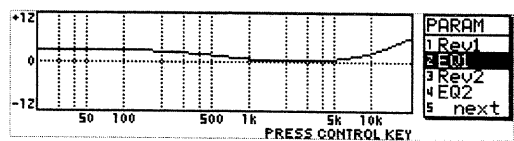
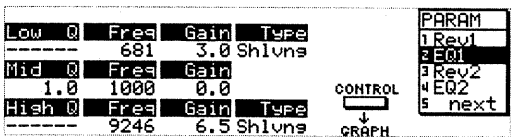

Rev2

PARAM  
1 Rev1  
2 EQ1  
3 Rev2  
4 EQ2  
5 next

Type	Size	PreDly	RevTm	Dnsta
Room	9.4	63	1.00	0
LowDmp	LowFra	HiDmp	HiFra	
1.00	50	0.60	5261	

Rev2  
1 Reverb  
2 SubRev  
3 ER

Rev2  
1 Reverb  
2 SubRev  
3 ER

PreDly Level  
68 41

ER

Rev2  
1 Reverb  
2 SubRev  
3 ER

Form	L1	L2	L3	Dnsta
4	80	7	4	100
PreDly	T1	T2	T3	T4
69	7	155	0	0

EQ2

PARAM  
1 Rev1  
2 EQ1  
3 Rev2  
4 EQ2  
5 next

Low Q	Freq	Gain	Type
---	311	4.6	Shlvs
Mid Q	Freq	Gain	Type
1.0	1000	0.0	
High Q	Freq	Gain	Type
---	7019	-3.7	Shlvs

CONTROL  
↓  
GRAPH

PARAM  
1 Rev1  
2 EQ1  
3 Rev2  
4 EQ2  
5 next

50 100 500 1k 5k 10k  
PRESS CONTROL KEY

MIXER

I/OLvl

InLvl  
1 I/OLvl

InA A	InA 0	InB A	InB 0
+100.0	+ 0.0	+100.0	+ 0.0
Out1 A	Out2 A	Out3 A	Out4 A
+100.0	+100.0	+100.0	+100.0
Out1 B	Out2 B	Out3 B	Out4 B
+ 0.0	+ 0.0	+ 0.0	+ 0.0

MXLvl

MxLvl  
1 MxLvl1  
2 MxLvl2

Mix01A	Mix11A	Mix21A	Mix31A	Mix41A
+ 50.0	+ 50.0	+ 75.0	-----	+ 40.0
Mix01B	Mix11B	Mix21B	Mix31B	Mix41B
+ 50.0	+ 75.0	+ 50.0	-----	+ 50.0
Mix0 0	Mix1 0	Mix2 0	Mix3 0	Mix4 0
+100.0	+100.0	+100.0	-----	+100.0

MxLvl  
1 MxLvl1  
2 MxLvl2

Mix51A	Mix61A	Mix71A	Mix81A	Mix91A
+ 40.0	+ 50.0	+ 50.0	-----	
Mix51B	Mix61B	Mix71B	Mix81B	Mix91B
+ 50.0	+ 40.0	+ 40.0	-----	
Mix5 0	Mix6 0	Mix7 0	Mix8 0	Mix9 0
+100.0	+100.0	+100.0	-----	

Memory No.	Card 19
Name	1 - 2 Kick Room

## ALG (ALGORITHM)

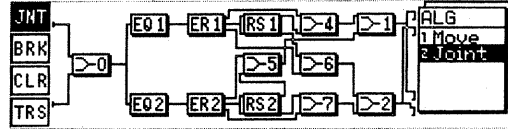
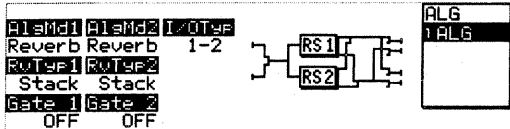

## HELP

Rev

Reverb SubRev ER

Block1

1-2

Stack

C19 1-2 Kick Room

PARAM

1 Rev1

2 EQ1

3 Rev2

4 EQ2

5 next

Rev

Reverb SubRev ER

Block2

1-2

Stack

C19 1-2 Kick Room

PARAM

1 Rev1

2 EQ1

3 Rev2

4 EQ2

5 next

## PARAM (PARAMETER)

Rev1

PARAM

1 Rev1

2 EQ1

3 Rev2

4 EQ2

5 next

Type	Size	PreDly	RevTm	Dnsty
Room	6.2	0.49	82	44

Rev1

1 Reverb

2 SubRev

3 ER

Type	Size	PreDly	RevTm	Dnsty
Room	6.2	20	0.49	0
LowDm	LowFrs	HiDm	HiFrs	
1.00	50	0.44	4000	

Rev1

1 Reverb

2 SubRev

3 ER

PreDly	Level
51	56

ER

Rev1

1 Reverb

2 SubRev

3 ER

Form	L1	L2	L3	Dnsty
4	73	64	51	16
PreDly	T1	T2	T3	T4
4	0	33	18	45

EQ1

Low	Q	Freq	Gain	Type
---	---	681	4.0	Shlvs
Mid	Q	Freq	Gain	
---	---	1.0	1000	0.0
High	Q	Freq	Gain	Type
---	---	2000	0.0	Shlvs

CONTROL

GRAPH

PARAM

1 Rev1

2 EQ1

3 Rev2

4 EQ2

5 next

PARAM

1 Rev1

2 EQ1

3 Rev2

4 EQ2

5 next

PRESS CONTROL KEY



Rev2

Type	Size	PreDly	RevTm	ERLvl	Bright
Room	9.4	0.80	80	56	

PARAM  
 1 Rev1  
 2 EQ1  
 3 Rev2  
 4 EQ2  
 5 next

Type	Size	PreDly	RevTm	Dnsty
Room	9.4	63	0.80	0
LowDmF	LowFrs	HiDmF	HiFrs	
1.00	50	0.56	7159	

Rev2  
 1 Reverb  
 2 SubRev  
 3 ER

100%

PreDly Level  
 26 72

Rev2  
 1 Reverb  
 2 SubRev  
 3 ER

ER

Form	L1	L2	L3	Dnsty
4	74	70	0	80
PreDly	T1	T2	T3	T4
0	0	46	75	0

Rev2  
 1 Reverb  
 2 SubRev  
 3 ER

EQ2

Low Q	Freq	Gain	Type
	311	6.0	Shlvs
Mid Q	Freq	Gain	Type
1.0	1000	0.0	
High Q	Freq	Gain	Type
	2000	0.0	Shlvs

CONTROL  
 GRAPH

PARAM  
 1 Rev1  
 2 EQ1  
 3 Rev2  
 4 EQ2  
 5 next

PARAM  
 1 Rev1  
 2 EQ1  
 3 Rev2  
 4 EQ2  
 5 next

50 100 500 1k 5k 10k  
 PRESS CONTROL KEY

MIXER

I/O Lvl

InA A	InA 0	InB A	InB 0
+ 40.0	+ 0.0	+ 40.0	+ 0.0
Out1 A	Out2 A	Out3 A	Out4 A
+100.0	+100.0	+100.0	+100.0
Out1 B	Out2 B	Out3 B	Out4 B
+ 0.0	+ 0.0	+ 0.0	+ 0.0

InLvl  
 1 I/O Lvl

MX Lvl

Mix01A	Mix11A	Mix21A	Mix31A	Mix41A
+ 50.0	+100.0	+100.0	-----	+ 60.0
Mix01B	Mix11B	Mix21B	Mix31B	Mix41B
+ 50.0	+100.0	+100.0	-----	+ 60.0
Mix0 0	Mix1 0	Mix2 0	Mix3 0	Mix4 0
+100.0	+100.0	+100.0	-----	+100.0

MxLvl  
 1 MxLvl1  
 2 MxLvl2

Mix51A	Mix61A	Mix71A	Mix81A	Mix91A
+ 60.0	+ 60.0	+ 60.0	-----	-----
Mix51B	Mix61B	Mix71B	Mix81B	Mix91B
+ 60.0	+ 60.0	+ 60.0	-----	-----
Mix5 0	Mix6 0	Mix7 0	Mix8 0	Mix9 0
+100.0	+100.0	+100.0	-----	-----

MxLvl  
 1 MxLvl1  
 2 MxLvl2

Memory No.	Card 20
Name	1 - 2 Drums Clear

## ALG (ALGORITHM)

```

AlsmD1 AlsmD2 1/OTOP
Reverb <--- 1-2
RT1 RT2
Gate 1 Gate 2
OFF OFF
          
```

modify

ALG  
TABLG

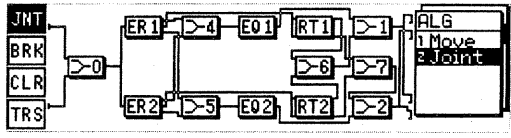

## HELP

```

Rev
Reverb SubRev ER
Gate 1 Gate 2
OFF OFF
Ga C20 1-2 Drums Clear
          
```

BLOCK

SYNC  
1/0  
1-2  
REUTYPE  
Tap

PARAM

1 Rev  
2 EQ  
5 next

## PARAM (PARAMETER)

### Rev

PARAM

1 Rev  
2 EQ  
5 next

Type	Size	PreDly	RevTm	ERLvl	Bright
Garage	14	0.80	100	70	

PARAM

1 Reverb  
2 SubRev  
3 ER

Type	Size	PreDly	RevTm	EDnsty
Garage	14	28	0.80	14
LowDmp	LowFrc	HiDmp	HiFrc	RDnsty
1.00	50	0.70	4747	40

PARAM

1 Reverb  
2 SubRev  
3 ER

PreDly	Level
60	30

### ER

PARAM

1 Reverb  
2 SubRev  
3 ER

Form	L1	L2	L3	Dnsty
4	82	90	54	68
PreDly	T1	T2	T3	T4
14	16	13	41	80

### EQ

Low	Freq	Gain	Type
---	343	1.0	Shlvs
Mid	Freq	Gain	Type
---	1000	0.0	
High	Freq	Gain	Type
---	3828	-8.0	Shlvs

CONTROL  
↓  
GRAPH

PARAM  
1 Rev  
2 EQ  
5 next

PARAM

1 Rev  
2 EQ  
5 next

PRESS CONTROL KEY

# MIXER

I/O Lvl

InA 0	InA 0	InB 0	InB 0	InLvl
+100.0	+ 0.0	+100.0	+ 0.0	1 I/O Lvl
Out1 0	Out2 0	Out3 0	Out4 0	
+100.0	+100.0	+100.0	+100.0	
Out1 0	Out2 0	Out3 0	Out4 0	
+ 0.0	+ 0.0	+ 0.0	+ 0.0	

MXLvl

Mix01A	Mix11A	Mix21A	Mix31A	Mix41A	MxLvl
+ 50.0	+ 75.0	+ 75.0	-----	+ 50.0	1 MxLvl1
Mix01B	Mix11B	Mix21B	Mix31B	Mix41B	2 MxLvl2
+ 50.0	+ 75.0	+ 75.0	-----	+ 50.0	
Mix0 0	Mix1 0	Mix2 0	Mix3 0	Mix4 0	
+100.0	+100.0	+100.0	-----	+100.0	

Mix51A	Mix61A	Mix71A	Mix81A	Mix91A	MxLvl
+ 50.0	+ 50.0	+ 50.0	-----		1 MxLvl1
Mix51B	Mix61B	Mix71B	Mix81B	Mix91B	2 MxLvl2
+ 50.0	+ 50.0	+ 50.0	-----		
Mix5 0	Mix6 0	Mix7 0	Mix8 0	Mix9 0	
+100.0	+100.0	+100.0	-----		

Memory No.	Card 21
Name	1 - 2 RS coloration

## ALG (ALGORITHM)

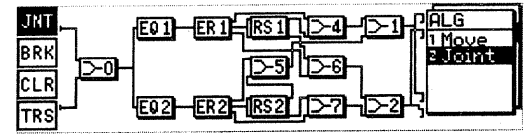
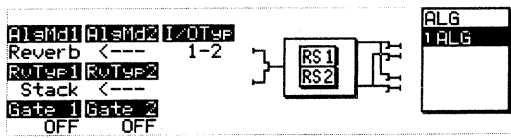

## HELP

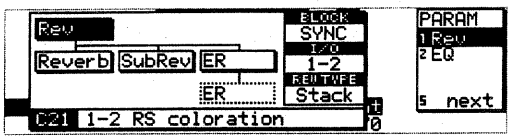

## PARAM (PARAMETER)

### Rev

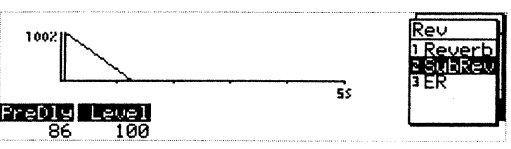
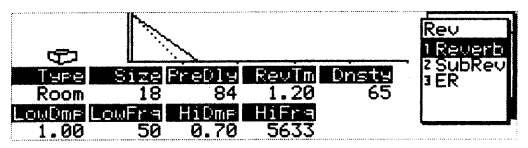
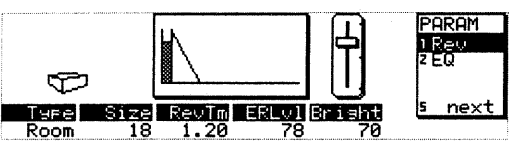

### ER

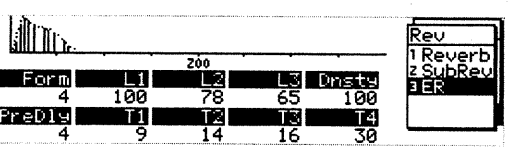

### EQ

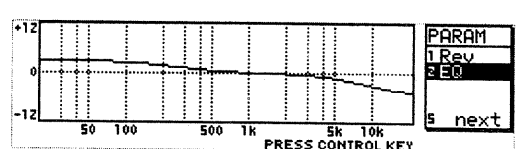
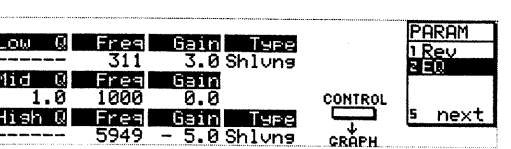

# MIXER

## I/O Lvl

InA 0	InA 0	InB 0	InB 0	
+100.0	+ 0.0	+100.0	+ 0.0	
Out1 0	Out2 0	Out3 0	Out4 0	
+100.0	+100.0	+100.0	+100.0	
Out1 0	Out2 0	Out3 0	Out4 0	
+ 0.0	+ 0.0	+ 0.0	+ 0.0	

InLvl
1 I/O Lvl

## MX Lvl

Mix01A	Mix11A	Mix21A	Mix31A	Mix41A	
+ 50.0	+ 75.0	+ 75.0	-----	+ 50.0	
Mix01B	Mix11B	Mix21B	Mix31B	Mix41B	
+ 50.0	+ 75.0	+ 75.0	-----	+ 50.0	
Mix0 0	Mix1 0	Mix2 0	Mix3 0	Mix4 0	
+100.0	+100.0	+100.0	-----	+100.0	

MxLvl
1 MxLvl1
2 MxLvl2

Mix51A	Mix61A	Mix71A	Mix81A	Mix91A	
+ 50.0	+ 50.0	+ 50.0	-----		
Mix51B	Mix61B	Mix71B	Mix81B	Mix91B	
+ 50.0	+ 50.0	+ 50.0	-----		
Mix5 0	Mix6 0	Mix7 0	Mix8 0	Mix9 0	
+100.0	+100.0	+100.0	-----		

MxLvl
1 MxLvl1
2 MxLvl2

Memory No.	Card 22
Name	2 - 2 Compression Rev

## ALG (ALGORITHM)

ALSMd1	ALSMd2	1/0Type
Reverb	<---	2-2
Router1	Router2	
Stack	<---	
Gate 1	Gate 2	
OFF	OFF	

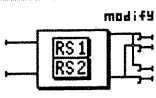

ALG
1 ALG

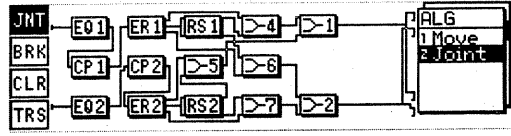



## HELP

Rev	Block	PARAM
Reverb	SVNC	1 Rev
SubRev	140	2 EQ
ER	2-2	
	REUTYPE	
	Stack	
022 2-2 Compression Rev		5 next

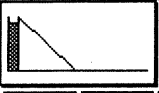

## PARAM (PARAMETER)

Rev

Type	Size	ReuTm	ERLvl	Bright
Room	14	2.30	90	80

PARAM
1 Rev
2 EQ
5 next

Type	Size	PreDly	ReuTm	Dnsty
Room	14	39	2.30	100
LowDmf	LowFrs	HiDmf	HiFrs	
0.90	60	0.80	14696	

Rev
1 Reverb
2 SubRev
3 ER



PreDly	Level
38	30

Rev
1 Reverb
2 SubRev
3 ER

ER

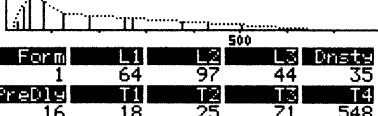

Form	L1	L2	L3	Dnsty
1	64	97	44	35
PreDly	T1	T2	T3	T4
16	18	25	71	548

Rev
1 Reverb
2 SubRev
3 ER

EQ

Low Q	Freq	Gain	Type
---	500	0.0	Shlvs
Mid Q	Freq	Gain	Type
1.0	1000	0.0	
High Q	Freq	Gain	Type
---	2000	0.0	Shlvs

CONTROL  
↓  
GRAPH

PARAM
1 Rev
2 EQ
5 next

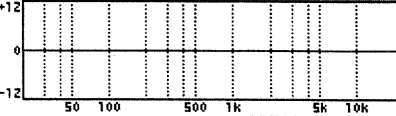

PARAM
1 Rev
2 EQ
5 next

PRESS CONTROL KEY

CmPrs1

IN	-20	10	7	5	3	2	1	0	1	2	3	6+	PARAM
GR													1 Chorus
OUT													2 Delay
													3 CmPrs1
													4 CmPrs2
													5 next
Ratio	Thresh	Attack	Release	Switch									
20.0:1	0.0	75.0	1200	ON									

CmPrs2

IN	-20	10	7	5	3	2	1	0	1	2	3	6+	PARAM
GR													1 Chorus
OUT													2 Delay
													3 CmPrs1
													4 CmPrs2
													5 next
Ratio	Thresh	Attack	Release	Switch									
20.0:1	0.0	75.0	1200	ON									

MIXER

I/OLvl

InA A	InA 0	InB A	InB 0	InLvl
+100.0	+ 0.0	+100.0	+ 0.0	1 I/OLvl
Out1 A	Out2 A	Out3 A	Out4 A	
+100.0	+100.0	+100.0	+100.0	
Out1 B	Out2 B	Out3 B	Out4 B	
+ 0.0	+ 0.0	+ 0.0	+ 0.0	

MXLvl

Mix01A	Mix11A	Mix21A	Mix31A	Mix41A	MxLvl
-----	+ 70.0	+ 70.0	-----	+ 50.0	1 MxLvl1
Mix01B	Mix11B	Mix21B	Mix31B	Mix41B	2 MxLvl2
-----	+ 70.0	+ 70.0	-----	+ 50.0	
Mix0 0	Mix1 0	Mix2 0	Mix3 0	Mix4 0	
-----	+100.0	+100.0	-----	+100.0	

Mix51A	Mix61A	Mix71A	Mix81A	Mix91A	MxLvl
+ 50.0	+ 50.0	+ 50.0	-----	-----	1 MxLvl1
Mix51B	Mix61B	Mix71B	Mix81B	Mix91B	2 MxLvl2
+ 50.0	+ 50.0	+ 50.0	-----	-----	
Mix5 0	Mix6 0	Mix7 0	Mix8 0	Mix9 0	
+100.0	+100.0	+100.0	-----	-----	

Memory No.	Card 23
Name	2 - 2 Stereo Delay

### ALG (ALGORITHM)

AlcMd1	AlcMd2	I/OType	
Reverb	<---	2-2	
RT1	RT2		
Gate1	Gate2		
OFF	OFF		

### PARAM (PARAMETER)

Delay

Dist1	FdBck1	Out1	
210	+ 40.0	+100	
Dist2	FdBck2	Out2	
250	+ 38.2	+100	

PARAM	
1 Chorus	
2 Delay	
5 next	

### MIXER

I/OLvl

InA	A	InA	0	InB	A	InB	0
+100.0	+	0.0	+100.0	+	0.0	+	0.0
Out1	A	Out2	A	Out3	A	Out4	A
+100.0	+100.0	+100.0	+100.0	+100.0	+100.0	+100.0	+100.0
Out1	B	Out2	B	Out3	B	Out4	B
+ 0.0	+ 0.0	+ 0.0	+ 0.0	+ 0.0	+ 0.0	+ 0.0	+ 0.0

MXLvl

Mix01A	Mix11A	Mix21A	Mix31A	Mix41A	
+100.0	+ 40.0				
Mix01B	Mix11B	Mix21B	Mix31B	Mix41B	
+ 40.0	+100.0				
Mix0	Mix1	Mix2	Mix3	Mix4	
+100.0	+100.0				

Mix51A	Mix61A	Mix71A	Mix81A	Mix91A	
Mix51B	Mix61B	Mix71B	Mix81B	Mix91B	
Mix5	Mix6	Mix7	Mix8	Mix9	





Memory No.	Card 24
Name	1 - 2 Reverse Gate

### ALG (ALGORITHM)

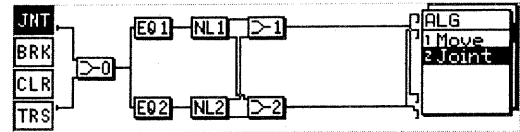
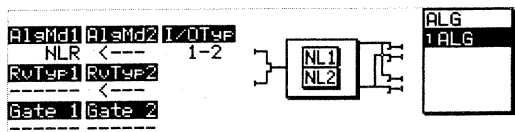

### HELP

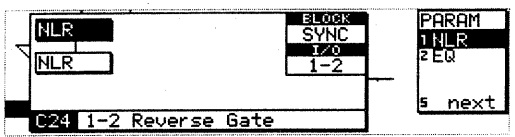

### PARAM (PARAMETER)

NLR

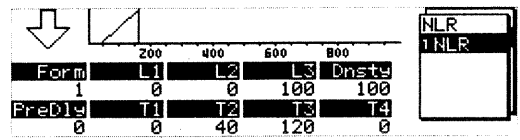
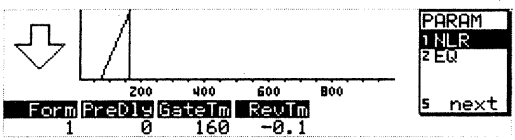

EQ

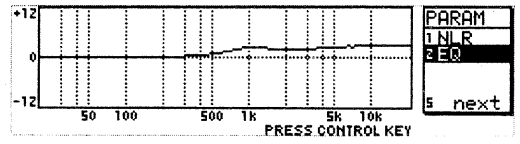
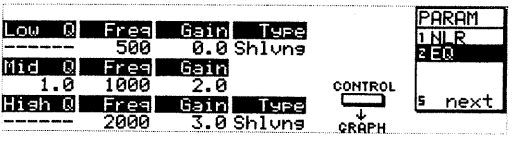

# MIXER

I/O Lvl

InA A	InA 0	InB A	InB 0	InLvl
+100.0	+ 0.0	+100.0	+ 0.0	1 I/O Lvl
Out1 A	Out2 A	Out3 A	Out4 A	
+100.0	+100.0	+100.0	+100.0	
Out1 B	Out2 B	Out3 B	Out4 B	
+ 0.0	+ 0.0	+ 0.0	+ 0.0	

MX Lvl

Mix01A	Mix11A	Mix21A	Mix31A	Mix41A	MxLvl
+ 50.0	+ 80.0	+ 80.0	-----	-----	1 MxLvl1
Mix01B	Mix11B	Mix21B	Mix31B	Mix41B	2 MxLvl2
+ 50.0	+ 80.0	+ 80.0	-----	-----	
Mix0 0	Mix1 0	Mix2 0	Mix3 0	Mix4 0	
+100.0	+100.0	+100.0	-----	-----	

Mix51A	Mix61A	Mix71A	Mix81A	Mix91A	MxLvl
Mix51B	Mix61B	Mix71B	Mix81B	Mix91B	1 MxLvl1
Mix5 0	Mix6 0	Mix7 0	Mix8 0	Mix9 0	2 MxLvl2
-----	-----	-----	-----	-----	



# Internal Memory

Memory No.	Int 1
Name	1 - 2 Large Hall 1

## ALG (ALGORITHM)

ALGMD1 ALGMD2 I/O TYP  
 Reverb <--- 1-2  
 RWTEP1 RWTEP2  
 Stack <---  
 Gate 1 Gate 2  
 OFF OFF

ALG  
1 ALG

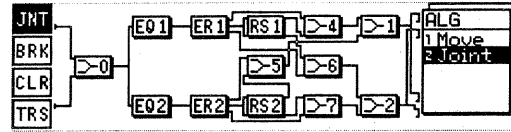

## HELP

Rev  
Reverb: SubRev: ER  
ER

BLOCK  
SYNC  
I/O  
1-2  
REALTIME  
Stack

PARAM  
1 Rev  
2 EQ  
5 next

1 1 1-2 Large Hall 1

## PARAM (PARAMETER)

Rev

PARAM  
1 Rev  
2 EQ  
5 next

Type	Size	PreDly	RevTm	ERLW	Bright
Hall	70	3.00	40	60	

Rev  
1 Reverb  
2 SubRev  
3 ER

Type	Size	PreDly	RevTm	Dnstr
Hall	70	105	3.00	100
LowDnc	LowFrc	HiDnc	HiFrc	
0.95	80	0.60	6918	

Rev  
1 Reverb  
2 SubRev  
3 ER

PreDly	Level
199	40

ER

Rev  
1 Reverb  
2 SubRev  
3 ER

Form	L1	L2	L3	Dnstr
2	34	40	28	18
PreDly	T1	T2	T3	T4
24	20	33	97	588

EQ

Low	0	Freq	Gain	Type
		500	0.0	Shlvs
Mid	0	Freq	Gain	
		1.0	1000	0.0
High	0	Freq	Gain	Type
		2000	0.0	Shlvs

CONTROL  
↓  
GRAPH

PARAM  
1 Rev  
2 EQ  
5 next

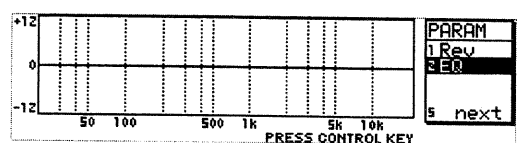

# MIXER

I/OLvl

InA 0	InA 0	InB 0	InB 0	InLv1
+100.0	+ 0.0	+100.0	+ 0.0	1 I/OLvl
Out1 0	Out2 0	Out3 0	Out4 0	
+100.0	+100.0	+100.0	+100.0	
Out1 0	Out2 0	Out3 0	Out4 0	
+ 0.0	+ 0.0	+ 0.0	+ 0.0	

MXLv1

Mix01A	Mix11A	Mix21A	Mix31A	Mix41A	MxLv1
+ 50.0	+ 60.0	+ 60.0	-----	+ 50.0	1 MxLv1
Mix01B	Mix11B	Mix21B	Mix31B	Mix41B	2 MxLv1z
+ 50.0	+ 60.0	+ 60.0	-----	+ 50.0	
Mix0 0	Mix1 0	Mix2 0	Mix3 0	Mix4 0	
+100.0	+100.0	+100.0	-----	+100.0	

Mix51A	Mix61A	Mix71A	Mix81A	Mix91A	MxLv1
+ 50.0	+ 50.0	+ 50.0	-----		1 MxLv1
Mix51B	Mix61B	Mix71B	Mix81B	Mix91B	2 MxLv1z
+ 50.0	+ 50.0	+ 50.0	-----		
Mix5 0	Mix6 0	Mix7 0	Mix8 0	Mix9 0	
+100.0	+100.0	+100.0	-----		

Memory No.	Int 2
Name	1 - 2 Large Hall 2

## ALG (ALGORITHM)

```

AlcMd1 AlcMd2 I/OType
Reverb <--- 1-2
RvTwp1 RvTwp2
Tap <---
Gate 1 Gate 2
OFF OFF

```

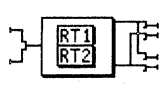

```

ALG
1ALG

```

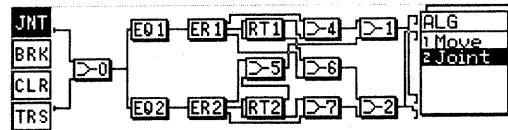

## HELP

```

Rev
Reverb: SubRev: ER
ER
I 2 1-2 Large Hall 2

```

```

BLOCK
SYNC
I/O
1-2
REUTWPE
Tap

```



```

PARAM
1 Rev
2 EQ
5 next

```

## PARAM (PARAMETER)

### Rev







```

PARAM
1 Rev
2 EQ
5 next

```

Type	Size	RevTm	ERLvl	Bright
Hall	51	3.00	40	20





```

Rev
1 Reverb
2 SubRev
3 ER

```

Type	Size	PreDly	RevTm	EDnsty
Hall	51	72	3.00	100
LowDmp	LowFrs	HiDmp	HiFrs	RDnsty
0.95	80	0.20	4000	100



```

Rev
1 Reverb
2 SubRev
3 ER

```

PreDly	Level
122	40

### ER



```

Rev
1 Reverb
2 SubRev
3 ER

```

Form	L1	L2	L3	Dnsty
2	34	40	28	21
PreDly	T1	T2	T3	T4
21	19	31	91	588

### EQ

Low Q	Freq	Gain	Type
---	500	0.0	Shlvs
Mid Q	Freq	Gain	
---	1.0	1000	0.0
High Q	Freq	Gain	Type
---	2000	0.0	Shlvs

CONTROL  
↓  
GRAPH

```

PARAM
1 Rev
2 EQ
5 next

```

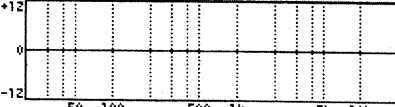

```

PARAM
1 Rev
2 EQ
5 next

```

PRESS CONTROL KEY



# MIXER

I/OLvl

InA 0	InA 0	InB 0	InB 0	InLvl 1/OLvl
+100.0	+ 0.0	+100.0	+ 0.0	
Out1 0	Out2 0	Out3 0	Out4 0	
+100.0	+100.0	+100.0	+100.0	
Out1 0	Out2 0	Out3 0	Out4 0	
+ 0.0	+ 0.0	+ 0.0	+ 0.0	

MXLvl

Mix01A	Mix11A	Mix21A	Mix31A	Mix41A	MxLvl 1 MxLvl1 2 MxLvl2
+ 50.0	+ 60.0	+ 60.0	-----	+ 50.0	
Mix01B	Mix11B	Mix21B	Mix31B	Mix41B	
+ 50.0	+ 60.0	+ 60.0	-----	+ 50.0	
Mix0 0	Mix1 0	Mix2 0	Mix3 0	Mix4 0	
+100.0	+100.0	+100.0	-----	+100.0	

Mix51A	Mix61A	Mix71A	Mix81A	Mix91A	MxLvl 1 MxLvl1 2 MxLvl2
+ 50.0	+ 50.0	+ 50.0	-----		
Mix51B	Mix61B	Mix71B	Mix81B	Mix91B	
+ 50.0	+ 50.0	+ 50.0	-----		
Mix5 0	Mix6 0	Mix7 0	Mix8 0	Mix9 0	
+100.0	+100.0	+100.0	-----		

Memory No.	Int 3
Name	1 - 2 Middle Hall 1

## ALG (ALGORITHM)

ALsMd1 ALsMd2 1/OTsp  
Reverb <--- 1-2  
RUTsp1 RUTsp2  
Stack <---  
Gate 1 Gate 2  
OFF OFF

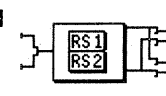

ALG  
1 ALG

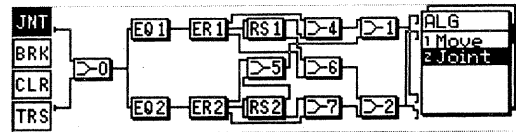

## HELP



Rev  
Reverb SubRev ER  
ER  
1 3 1-2 Middle Hall 1

BLOCK  
SYNC  
1-0  
1-2  
REVERSE  
Stack

PARAM  
1 Rev  
2 EQ  
5 next

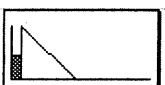

## PARAM (PARAMETER)

Rev

PARAM  
1 Rev  
2 EQ  
5 next

Type	Size	Revlm	ERLvl	Bright
Hall	29	2.20	45	60

Rev  
1 Reverb  
2 SubRev  
3 ER

Type	Size	PreDly	Revlm	Dnsts
Hall	29	43	2.20	80
LowDmf	LowFpa	HiDmf	HiFpa	
0.95	80	0.60	6918	

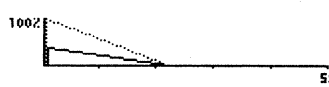

Rev  
1 Reverb  
2 SubRev  
3 ER

PreDly	Level
81	40

ER



Rev  
1 Reverb  
2 SubRev  
3 ER

Form	L1	L2	L3	Dnsts
2	38	45	20	34
PreDly	T1	T2	T3	T4
16	18	25	60	504

EQ

Low	0	Freq	Gain	Type
---	---	500	0.0	Shlvs
Mid	0	Freq	Gain	
---	---	1.0	1000	0.0
High	0	Freq	Gain	Type
---	---	2000	0.0	Shlvs

PARAM  
1 Rev  
2 EQ  
5 next

CONTROL  
↓  
GRAPH

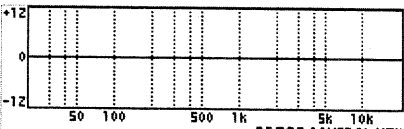

PARAM  
1 Rev  
2 EQ  
5 next

PRESS CONTROL KEY

# MIXER

I/OLvl

InA A	InA 0	InB A	InB 0	
+100.0	+ 0.0	+100.0	+ 0.0	
Out1 A	Out2 A	Out3 A	Out4 A	
+100.0	+100.0	+100.0	+100.0	
Out1 B	Out2 B	Out3 B	Out4 B	
+ 0.0	+ 0.0	+ 0.0	+ 0.0	

InLvl
1 I/OLvl

MXLvl

Mix01A	Mix11A	Mix21A	Mix31A	Mix41A	
+ 50.0	+ 60.0	+ 60.0	-----	+ 50.0	
Mix01B	Mix11B	Mix21B	Mix31B	Mix41B	
+ 50.0	+ 60.0	+ 60.0	-----	+ 50.0	
Mix0 0	Mix1 0	Mix2 0	Mix3 0	Mix4 0	
+100.0	+100.0	+100.0	-----	+100.0	

MxLvl
1 MXLvl1
2 MXLvl2

Mix51A	Mix61A	Mix71A	Mix81A	Mix91A	
+ 50.0	+ 50.0	+ 50.0	-----		
Mix51B	Mix61B	Mix71B	Mix81B	Mix91B	
+ 50.0	+ 50.0	+ 50.0	-----		
Mix5 0	Mix6 0	Mix7 0	Mix8 0	Mix9 0	
+100.0	+100.0	+100.0	-----		

MxLvl
1 MXLvl1
3 MXLvl2

Memory No.	Int 4
Name	1 - 2 Middle Hall 2

## ALG (ALGORITHM)

Alamd1	Alamd2	1-OTyp	
Reverb	<---	1-2	
RT1	RT2		
Gate 1	Gate 2		
OFF	OFF		

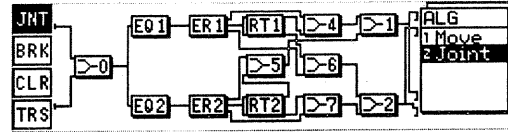

## HELP

Rev	Block	PARAM
Reverb	SYNC	1 Rev
SubRev	1-2	2 EQ
ER	RENUM	5 next
ER	Tap	
I 4	1-2 Middle Hall 2	

## PARAM (PARAMETER)

Rev

Type	Size	RevTm	ERLw1	Bright
Hall	23	2.50	40	48

Type	Size	PreDlc	RevTm	EDnsta
Hall	23	32	2.50	64
LowQmp	LowFra	HiQmp	HiFra	RDnsta
0.95	80	0.48	4284	64

PreDlc	Level
54	40

ER

Form	L1	L2	L3	Dnsta
2	34	40	16	39
PreDlc	T1	T2	T3	T4
15	17	22	67	537

EQ

Low	0	Freq	Gain	Type
---	500	0.0	Shlvs	
Mid	0	Freq	Gain	
---	1.0	1000	0.0	
High	0	Freq	Gain	Type
---	2000	0.0	Shlvs	

CONTROL  
↓  
GRAPH

PARAM
1 Rev
2 EQ
5 next

# MIXER

I/O Lvl

InA A	InA 0	InB A	InB 0	
+100.0	+ 0.0	+100.0	+ 0.0	
Out1 A	Out2 A	Out3 A	Out4 A	
+100.0	+100.0	+100.0	+100.0	
Out1 B	Out2 B	Out3 B	Out4 B	
+ 0.0	+ 0.0	+ 0.0	+ 0.0	

InLvl
1 I/O Lvl

MX Lvl

Mix01A	Mix11A	Mix21A	Mix31A	Mix41A	
+ 50.0	+ 60.0	+ 60.0	-----	+ 50.0	
Mix01B	Mix11B	Mix21B	Mix31B	Mix41B	
+ 50.0	+ 60.0	+ 60.0	-----	+ 50.0	
Mix0 0	Mix1 0	Mix2 0	Mix3 0	Mix4 0	
+100.0	+100.0	+100.0	-----	+100.0	

MxLvl
1 MxLvl1
2 MxLvl2

Mix51A	Mix61A	Mix71A	Mix81A	Mix91A	
+ 50.0	+ 50.0	+ 50.0	-----		
Mix51B	Mix61B	Mix71B	Mix81B	Mix91B	
+ 50.0	+ 50.0	+ 50.0	-----		
Mix5 0	Mix6 0	Mix7 0	Mix8 0	Mix9 0	
+100.0	+100.0	+100.0	-----		

MxLvl
1 MxLvl1
2 MxLvl2

Memory No.	Int 5
Name	1 - 2 Middle Hall 3

## ALG (ALGORITHM)

AlcMcd1	AlcMcd2	1/0Type
Reverb	Reverb	1-2
RvTsp1	RvTsp2	
Stack	Tap	
Gate 1	Gate 2	
OFF	OFF	

ALG
1 ALG

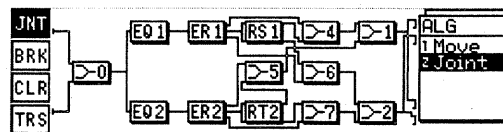

## HELP

Rev	Block1	PARAM
Reverb	SubRev	1 Rev1
ER	1-2	2 EQ1
ER	REU TYPE	3 Rev2
Stack	Tap	4 EQ2
		5 next

1 5 1-2 Middle Hall 3

Rev	Block2	PARAM
Reverb	SubRev	1 Rev1
ER	1-2	2 EQ1
ER	REU TYPE	3 Rev2
Tap		4 EQ2
		5 next

1 5 1-2 Middle Hall 3

## PARAM (PARAMETER)

Rev1

Type	Size	RevTm	ERLvl	Bright
Hall	14	1.00	31	60

PARAM
1 Rev1
2 EQ1
3 Rev2
4 EQ2
5 next

Type	Size	PreDly	RevTm	DnSty
Hall	14	22	1.00	10
LowDmp	LowFrs	HiDmp	HiFrs	
0.95	80	0.60	6918	

Rev1
1 Reverb
2 SubRev
3 ER

PreDly	Level
39	40

Rev1
1 Reverb
2 SubRev
3 ER

ER

Form	L1	L2	L3	DnSty
2	28	31	20	73
PreDly	T1	T2	T3	T4
12	64	40	77	340

Rev1
1 Reverb
2 SubRev
3 ER

EQ1

Low Q	Freq	Gain	Type
---	500	-2.0	Shlvs
Mid Q	Freq	Gain	
---	1.0	1.0	
High Q	Freq	Gain	Type
---	2000	0.0	Shlvs

CONTROL  
↓  
GRAPH

PARAM
1 Rev1
2 EQ1
3 Rev2
4 EQ2
5 next

PARAM
1 Rev1
2 EQ1
3 Rev2
4 EQ2
5 next

PRESS CONTROL KEY

Rev2

Type	Size	PreDly	RevTm	EDnste	Bright
Hall	23	47	2.40	30	50

PARAM  
1 Rev1  
2 EQ1  
3 Rev2  
4 EQ2  
5 next

Type	Size	PreDly	RevTm	EDnste
Hall	23	47	2.40	30
LowDmp	LowFra	HiDmp	HiFra	RDnste
0.95	80	0.50	5083	76

Rev2  
1 Reverb  
2 SubRev  
3 ER

100%

PreDly Level  
80 40

5s

Rev2  
1 Reverb  
2 SubRev  
3 ER

ER

500

Form	L1	L2	L3	Dnste
2	21	33	24	50
PreDly	T1	T2	T3	T4
39	53	43	52	324

Rev2  
1 Reverb  
2 SubRev  
3 ER

EQ2

Low Q	Freq	Gain	Type
---	500	-1.0	Shlvs
Mid Q	Freq	Gain	Type
1.0	1000	1.0	
High Q	Freq	Gain	Type
---	2000	1.0	Shlvs

CONTROL  
↓  
GRAPH

PARAM  
1 Rev1  
2 EQ1  
3 Rev2  
4 EQ2  
5 next

PARAM  
1 Rev1  
2 EQ1  
3 Rev2  
4 EQ2  
5 next

12  
0  
-12

50 100 500 1k 5k 10k

PRESS CONTROL KEY

MIXER

I/OLvl

InA	InA 0	InB	InB 0
+100.0	+ 0.0	+100.0	+ 0.0
Out1	Out2	Out3	Out4
+100.0	+100.0	+100.0	+100.0
Out1 B	Out2 B	Out3 B	Out4 B
+ 0.0	+ 0.0	+ 0.0	+ 0.0

InLvl  
1 I/OLvl

MXLvl

Mix01A	Mix11A	Mix21A	Mix31A	Mix41A
+ 50.0	+ 50.0	+ 50.0	-----	+ 50.0
Mix01B	Mix11B	Mix21B	Mix31B	Mix41B
+ 50.0	+ 65.0	+ 65.0	-----	+ 50.0
Mix5 0	Mix6 0	Mix7 0	Mix8 0	Mix9 0
+100.0	+100.0	+100.0	-----	+100.0

MxLvl  
1 MxLvl1  
2 MxLvl2

Mix51A	Mix61A	Mix71A	Mix81A	Mix91A
+ 50.0	+ 50.0	+ 50.0	-----	+ 50.0
Mix51B	Mix61B	Mix71B	Mix81B	Mix91B
+ 50.0	+ 50.0	+ 50.0	-----	+ 50.0
Mix5 0	Mix6 0	Mix7 0	Mix8 0	Mix9 0
+100.0	+100.0	+100.0	-----	+100.0

MxLvl  
1 MxLvl1  
2 MxLvl2

Memory No.	Int 6
Name	1 - 2 Middle Room 1

## ALG (ALGORITHM)

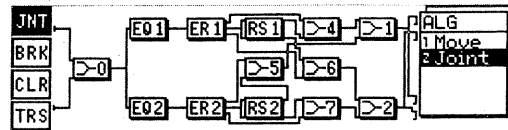
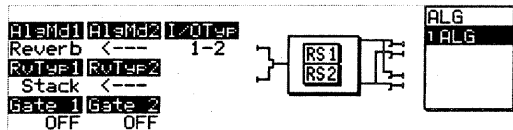

## HELP

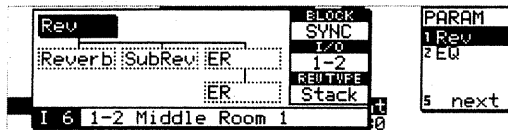

## PARAM (PARAMETER)

Rev

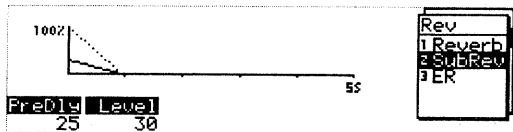
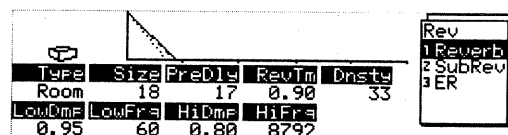
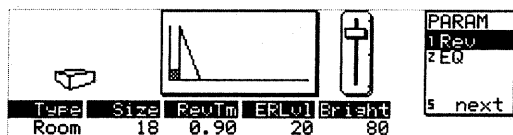

ER

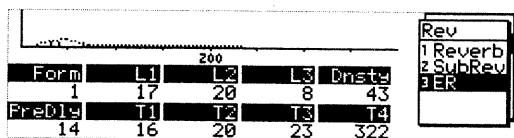

EQ

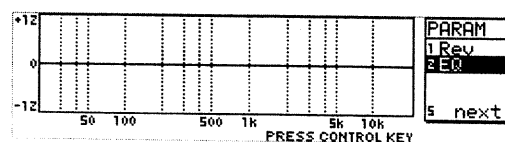



# MIXER

I/OLvl

InA 0	InA 0	InB 0	InB 0	InLvl
+100.0	+ 0.0	+100.0	+ 0.0	I/OLvl
Out1 0	Out2 0	Out3 0	Out4 0	
+100.0	+100.0	+100.0	+100.0	
Out1 0	Out2 0	Out3 0	Out4 0	
+ 0.0	+ 0.0	+ 0.0	+ 0.0	

MXLvl

Mix01A	Mix11A	Mix21A	Mix31A	Mix41A	MxLvl
+ 50.0	+ 70.0	+ 70.0	-----	+ 50.0	1 MxLvl1
Mix01B	Mix11B	Mix21B	Mix31B	Mix41B	2 MxLvl2
+ 50.0	+ 70.0	+ 70.0	-----	+ 50.0	
Mix0 0	Mix1 0	Mix2 0	Mix3 0	Mix4 0	
+100.0	+100.0	+100.0	-----	+100.0	

Mix51A	Mix61A	Mix71A	Mix81A	Mix91A	MxLvl
+ 50.0	+ 50.0	+ 50.0	-----	-----	1 MxLvl1
Mix51B	Mix61B	Mix71B	Mix81B	Mix91B	2 MxLvl2
+ 50.0	+ 50.0	+ 50.0	-----	-----	
Mix5 0	Mix6 0	Mix7 0	Mix8 0	Mix9 0	
+100.0	+100.0	+100.0	-----	-----	

Memory No.	Int 7
Name	1 - 2 Middle Room 2

## ALG (ALGORITHM)

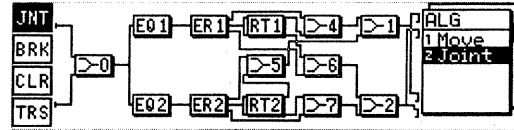
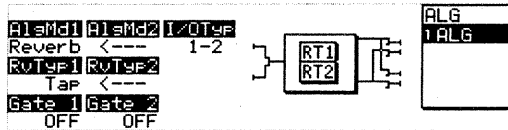

## HELP

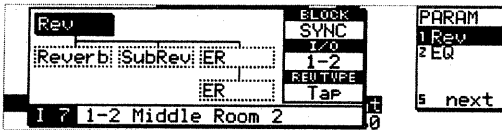

## PARAM (PARAMETER)

Rev

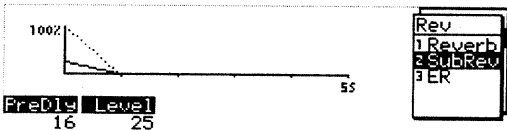
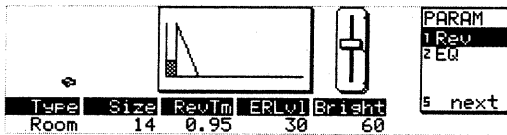

ER

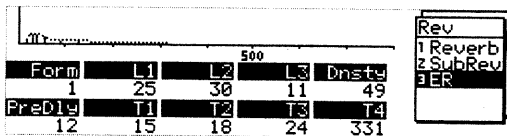

EQ

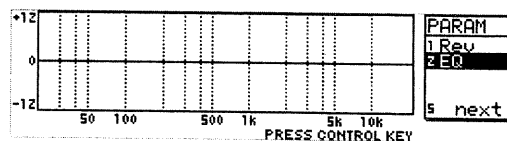
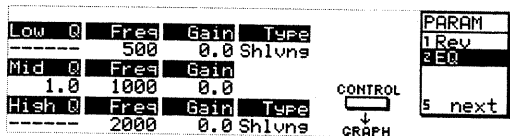

# MIXER

I/OLvl

InA A	InA 0	InB A	InB 0	
+100.0	+ 0.0	+100.0	+ 0.0	
Out1 A	Out2 A	Out3 A	Out4 A	
+100.0	+100.0	+100.0	+100.0	
Out1 B	Out2 B	Out3 B	Out4 B	
+ 0.0	+ 0.0	+ 0.0	+ 0.0	

InLvl
1 I/OLvl

MXLvl

Mix01A	Mix11A	Mix21A	Mix31A	Mix41A	
+ 50.0	+ 65.0	+ 65.0	-----	+ 50.0	
Mix01B	Mix11B	Mix21B	Mix31B	Mix41B	
+ 50.0	+ 65.0	+ 65.0	-----	+ 50.0	
Mix0 0	Mix1 0	Mix2 0	Mix3 0	Mix4 0	
+100.0	+100.0	+100.0	-----	+100.0	

MxLvl
1 MxLvl1
2 MxLvl2

Mix51A	Mix61A	Mix71A	Mix81A	Mix91A	
+ 50.0	+ 50.0	+ 50.0	-----		
Mix51B	Mix61B	Mix71B	Mix81B	Mix91B	
+ 50.0	+ 50.0	+ 50.0	-----		
Mix5 0	Mix6 0	Mix7 0	Mix8 0	Mix9 0	
+100.0	+100.0	+100.0	-----		

MxLvl
1 MxLvl1
2 MxLvl2

Memory No.	Int 8
Name	1 - 2 Small Room 1

## ALG (ALGORITHM)

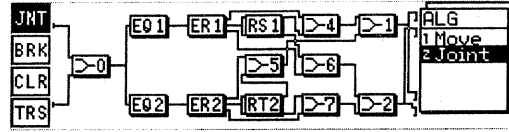
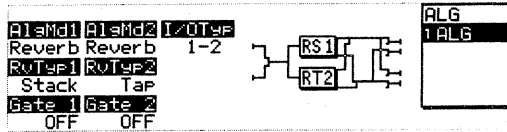

## HELP

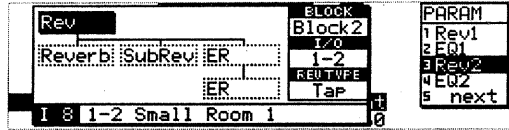
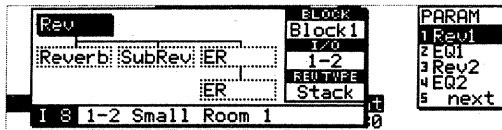

## PARAM (PARAMETER)

Rev1

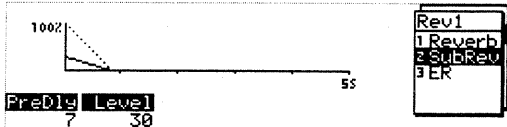
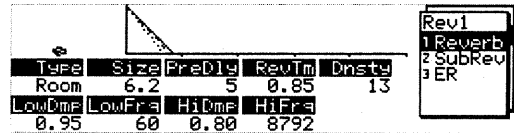
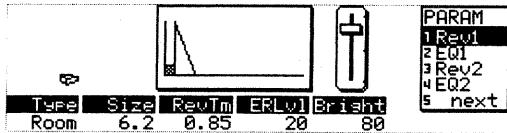

ER

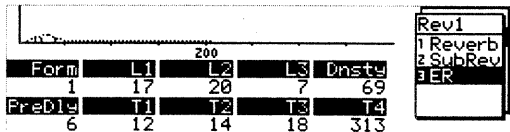

EQ1

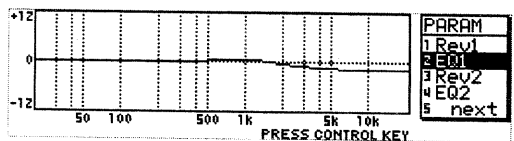
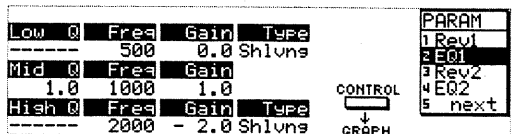

### Rev2

Type	Size	RevTm	ERLvl	Bright
Room	9.4	0.90	12	60

PARAM  
1 Rev1  
2 EQ1  
3 Rev2  
4 EQ2  
5 next

Type	Size	PreDly	RevTm	EDnsty
Room	9.4	8	0.90	28
LowDmp	LowFrs	HiDmp	HiFrs	RDnsty
0.95	60	0.60	5444	19

Rev2  
1 Reverb  
2 SubRev  
3 ER

100%  
5s

PreDly	Level
11	25

Rev2  
1 Reverb  
2 SubRev  
3 ER

### ER

Form	L1	L2	L3	Dnsty
1	10	12	4	58
PreDly	T1	T2	T3	T4
9	13	15	21	322

Rev2  
1 Reverb  
2 SubRev  
3 ER

### EQ2

Low Q	Freq	Gain	Type
---	500	0.0	Shlvs
Mid Q	Freq	Gain	Type
1.0	1000	1.0	---
High Q	Freq	Gain	Type
---	2000	-1.0	Shlvs

PARAM  
1 Rev1  
2 EQ1  
3 Rev2  
4 EQ2  
5 next

CONTROL  
↓  
GRAPH

PARAM  
1 Rev1  
2 EQ1  
3 Rev2  
4 EQ2  
5 next

PRESS CONTROL KEY

## MIXER

### I/O Lvl

InA	InA 0	InB	InB 0
+100.0	+ 0.0	+100.0	+ 0.0
Out1	Out2	Out3	Out4
+100.0	+100.0	+100.0	+100.0
Out1	Out2	Out3	Out4
+ 0.0	+ 0.0	+ 0.0	+ 0.0

InLvl  
1 I/O Lvl

### MX Lvl

Mix01A	Mix11A	Mix21A	Mix31A	Mix41A
+ 50.0	+ 65.0	+ 65.0	-----	+ 50.0
Mix01B	Mix11B	Mix21B	Mix31B	Mix41B
+ 50.0	+ 65.0	+ 65.0	-----	+ 50.0
Mix0 0	Mix1 0	Mix2 0	Mix3 0	Mix4 0
+100.0	+100.0	+100.0	-----	+100.0

MxLvl  
1 MxLvl1  
2 MxLvl2

Mix51A	Mix61A	Mix71A	Mix81A	Mix91A
+ 50.0	+ 50.0	+ 50.0	-----	-----
Mix51B	Mix61B	Mix71B	Mix81B	Mix91B
+ 50.0	+ 50.0	+ 50.0	-----	-----
Mix5 0	Mix6 0	Mix7 0	Mix8 0	Mix9 0
+100.0	+100.0	+100.0	-----	-----

MxLvl  
1 MxLvl1  
2 MxLvl2

Memory No.	Int 9
Name	1 - 2 Small Room 2

## ALG (ALGORITHM)

ALG1 ALG2 1-2 OF  
Reverb <--- 1-2  
RT1 RT2  
Tap <---  
Gate 1 Gate 2  
OFF OFF

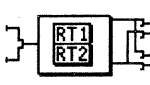

ALG  
1 ALG

JNT  
BRK  
CLR  
TRS

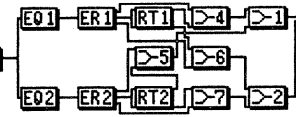

ALG  
1 Move  
2 Joint

## HELP

Rev  
Reverb: SubRev: ER  
ER  
I 9 1-2 Small Room 2

BLOCK  
SYNC  
1/0  
1-2  
REVTYP  
Tap

PARAM  
1 Rev  
2 EQ  
5 next

## PARAM (PARAMETER)

Rev

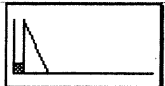

PARAM  
1 Rev  
2 EQ  
5 next

Type	Size	Revtm	ERLvl	Bright
Room	9.4	1.00	20	50



Rev  
1 Reverb  
2 SubRev  
3 ER

Type	Size	PreDly	Revtm	EDnsty
Room	9.4	8	1.00	28
LowDm	LowFrs	HiDm	HiFrs	EDnsty
0.95	60	0.50	4587	19

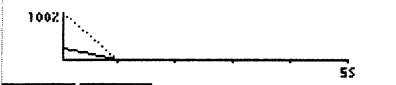

Rev  
1 Reverb  
2 SubRev  
3 ER

PreDly	Level
11	25

ER

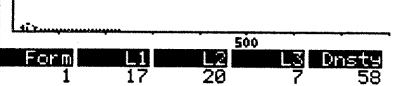

Rev  
1 Reverb  
2 SubRev  
3 ER

Form	L1	L2	L3	Dnsty
1	17	20	7	58
PreDly	T1	T2	T3	T4
9	13	15	23	340

EQ

Low	Q	Freq	Gain	Type
---	---	500	0.0	Shluns
Mid	Q	Freq	Gain	Type
---	---	1.0	1000	0.0
High	Q	Freq	Gain	Type
---	---	2000	0.0	Shluns

CONTROL  
↓  
GRAPH

PARAM  
1 Rev  
2 EQ  
5 next

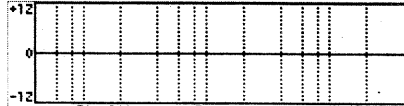

PARAM  
1 Rev  
2 EQ  
5 next

PRESS CONTROL KEY

# MIXER

I/O Lvl

InA A	InA 0	InB A	InB 0	InLvl
+100.0	+ 0.0	+100.0	+ 0.0	1 I/O Lvl
Out1 A	Out2 A	Out3 A	Out4 A	
+100.0	+100.0	+100.0	+100.0	
Out1 B	Out2 B	Out3 B	Out4 B	
+ 0.0	+ 0.0	+ 0.0	+ 0.0	

MX Lvl

Mix01A	Mix11A	Mix21A	Mix31A	Mix41A	MxLvl
+ 50.0	+ 65.0	+ 65.0	-----	+ 50.0	1 MxLvl1
Mix01B	Mix11B	Mix21B	Mix31B	Mix41B	2 MxLvl2
+ 50.0	+ 65.0	+ 65.0	-----	+ 50.0	
Mix0 0	Mix1 0	Mix2 0	Mix3 0	Mix4 0	
+100.0	+100.0	+100.0	-----	+100.0	

Mix51A	Mix61A	Mix71A	Mix81A	Mix91A	MxLvl
+ 50.0	+ 50.0	+ 50.0	-----		1 MxLvl1
Mix51B	Mix61B	Mix71B	Mix81B	Mix91B	2 MxLvl2
+ 50.0	+ 50.0	+ 50.0	-----		
Mix5 0	Mix6 0	Mix7 0	Mix8 0	Mix9 0	
+100.0	+100.0	+100.0	-----		

Memory No.	Int 10
Name	1 - 2 Small Room 3

## ALG (ALGORITHM)

Alamd1	Alamd2	I-OUTP	
Reverb	Plate	1-2	
ROUTP1	ROUTP2		
Stack	Stack		
Gate 1	Gate 2		
OFF	OFF		

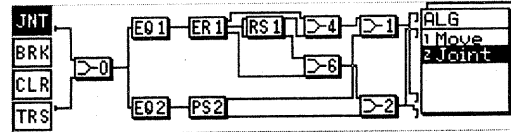

## HELP

Rev	Block1	PARAM
Reverb	1-2	1 Rev1
SubRev	Stack	2 EQ1
ER		3 Plate2
ER		4 EQ2
		5 next

I10 1-2 Small Room 3

Plate	Block2	PARAM
Plate	1-2	1 Rev1
SubRev	Stack	2 EQ1
		3 Plate2
		4 EQ2
		5 next

I10 1-2 Small Room 3

## PARAM (PARAMETER)

Rev1

Type	Size	PreDly	RevTm	ERLvl	Bright
Room	6.2	0.90	80		65

PARAM
1 Rev1
2 EQ1
3 Plate2
4 EQ2
5 next

Type	Size	PreDly	RevTm	Dnsty
Room	6.2	5	0.90	13
LowDm	LowFrs	HiDm	HiFrs	
0.95	60	0.65	6918	

Rev1
1 Reverb
2 SubRev
3 ER

PreDly	Level
7	30

Rev1
1 Reverb
2 SubRev
3 ER

ER

Form	L1	L2	L3	Dnsty
1	68	80	28	69
PreDly	T1	T2	T3	T4
6	12	14	19	322

Rev1
1 Reverb
2 SubRev
3 ER

EQ1

Low	Q	Freq	Gain	Type
		500	0.0	Shlvs
Mid	Q	Freq	Gain	
		1.0	1000	1.0
High	Q	Freq	Gain	Type
		2000	4.0	Shlvs

CONTROL  
↓  
GRAPH

PARAM
1 Rev1
2 EQ1
3 Plate2
4 EQ2
5 next

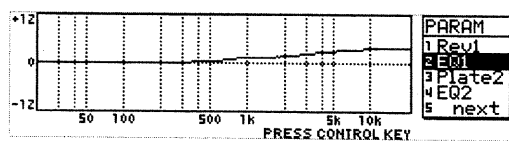



### Plate2

		<table border="1"> <tr><th colspan="2">PARAM</th></tr> <tr><td>1 Rev1</td><td></td></tr> <tr><td>2 EQ1</td><td></td></tr> <tr><td>3 Plate2</td><td></td></tr> <tr><td>4 EQ2</td><td></td></tr> <tr><td>5 next</td><td></td></tr> </table>	PARAM		1 Rev1		2 EQ1		3 Plate2		4 EQ2		5 next	
PARAM														
1 Rev1														
2 EQ1														
3 Plate2														
4 EQ2														
5 next														
Type	RevTm	BriShft												
3	0.50	70												

	<table border="1"> <tr><th colspan="2">Plate2</th></tr> <tr><td>1 Plate</td><td></td></tr> <tr><td>2 SubRev</td><td></td></tr> </table>	Plate2		1 Plate		2 SubRev	
Plate2							
1 Plate							
2 SubRev							
Type	Brill	Death	PreDly	RevTm	Dnste		
3	62	50	16	0.50	100		
LowDmp	LowFrs	HiDmp	HiFrs				
0.86	50	0.98	7409				

	<table border="1"> <tr><th colspan="2">Plate2</th></tr> <tr><td>1 Plate</td><td></td></tr> <tr><td>2 SubRev</td><td></td></tr> </table>	Plate2		1 Plate		2 SubRev	
Plate2							
1 Plate							
2 SubRev							
PreDly	Level						
0	25						

### EQ2

<table border="1"> <tr><th>Low Q</th><th>Freq</th><th>Gain</th><th>Type</th></tr> <tr><td>500</td><td></td><td>0.0</td><td>Shlvs</td></tr> <tr><th>Mid Q</th><th>Freq</th><th>Gain</th><th></th></tr> <tr><td>1.0</td><td>1000</td><td>1.0</td><td></td></tr> <tr><th>High Q</th><th>Freq</th><th>Gain</th><th>Type</th></tr> <tr><td>2000</td><td></td><td>1.0</td><td>Shlvs</td></tr> </table>	Low Q	Freq	Gain	Type	500		0.0	Shlvs	Mid Q	Freq	Gain		1.0	1000	1.0		High Q	Freq	Gain	Type	2000		1.0	Shlvs	<table border="1"> <tr><th colspan="2">PARAM</th></tr> <tr><td>1 Rev1</td><td></td></tr> <tr><td>2 EQ1</td><td></td></tr> <tr><td>3 Plate2</td><td></td></tr> <tr><td>4 EQ2</td><td></td></tr> <tr><td>5 next</td><td></td></tr> </table>	PARAM		1 Rev1		2 EQ1		3 Plate2		4 EQ2		5 next	
Low Q	Freq	Gain	Type																																		
500		0.0	Shlvs																																		
Mid Q	Freq	Gain																																			
1.0	1000	1.0																																			
High Q	Freq	Gain	Type																																		
2000		1.0	Shlvs																																		
PARAM																																					
1 Rev1																																					
2 EQ1																																					
3 Plate2																																					
4 EQ2																																					
5 next																																					

CONTROL  
↓  
GRAPH

	<table border="1"> <tr><th colspan="2">PARAM</th></tr> <tr><td>1 Rev1</td><td></td></tr> <tr><td>2 EQ1</td><td></td></tr> <tr><td>3 Plate2</td><td></td></tr> <tr><td>4 EQ2</td><td></td></tr> <tr><td>5 next</td><td></td></tr> </table>	PARAM		1 Rev1		2 EQ1		3 Plate2		4 EQ2		5 next	
PARAM													
1 Rev1													
2 EQ1													
3 Plate2													
4 EQ2													
5 next													
PRESS CONTROL KEY													

## MIXER

### I/O Lvl

<table border="1"> <tr><th>InA</th><th>InA Q</th><th>InB</th><th>InB Q</th></tr> <tr><td>+100.0</td><td>+ 0.0</td><td>+100.0</td><td>+ 0.0</td></tr> <tr><th>Out1</th><th>Out2</th><th>Out3</th><th>Out4</th></tr> <tr><td>+100.0</td><td>+100.0</td><td>+100.0</td><td>+100.0</td></tr> <tr><th>Out1 B</th><th>Out2 B</th><th>Out3 B</th><th>Out4 B</th></tr> <tr><td>+ 0.0</td><td>+ 0.0</td><td>+ 0.0</td><td>+ 0.0</td></tr> </table>	InA	InA Q	InB	InB Q	+100.0	+ 0.0	+100.0	+ 0.0	Out1	Out2	Out3	Out4	+100.0	+100.0	+100.0	+100.0	Out1 B	Out2 B	Out3 B	Out4 B	+ 0.0	+ 0.0	+ 0.0	+ 0.0	<table border="1"> <tr><th colspan="2">InLvl</th></tr> <tr><td>1 I/O Lvl</td><td></td></tr> </table>	InLvl		1 I/O Lvl	
InA	InA Q	InB	InB Q																										
+100.0	+ 0.0	+100.0	+ 0.0																										
Out1	Out2	Out3	Out4																										
+100.0	+100.0	+100.0	+100.0																										
Out1 B	Out2 B	Out3 B	Out4 B																										
+ 0.0	+ 0.0	+ 0.0	+ 0.0																										
InLvl																													
1 I/O Lvl																													

### MX Lvl

<table border="1"> <tr><th>Mix01A</th><th>Mix11A</th><th>Mix21A</th><th>Mix31A</th><th>Mix41A</th></tr> <tr><td>+ 50.0</td><td>+ 60.0</td><td>+ 60.0</td><td></td><td>+ 50.0</td></tr> <tr><th>Mix01B</th><th>Mix11B</th><th>Mix21B</th><th>Mix31B</th><th>Mix41B</th></tr> <tr><td>+ 50.0</td><td>+ 60.0</td><td>+ 60.0</td><td></td><td>+ 50.0</td></tr> <tr><th>Mix0 0</th><th>Mix1 0</th><th>Mix2 0</th><th>Mix3 0</th><th>Mix4 0</th></tr> <tr><td>+100.0</td><td>+100.0</td><td>+100.0</td><td></td><td>+100.0</td></tr> </table>	Mix01A	Mix11A	Mix21A	Mix31A	Mix41A	+ 50.0	+ 60.0	+ 60.0		+ 50.0	Mix01B	Mix11B	Mix21B	Mix31B	Mix41B	+ 50.0	+ 60.0	+ 60.0		+ 50.0	Mix0 0	Mix1 0	Mix2 0	Mix3 0	Mix4 0	+100.0	+100.0	+100.0		+100.0	<table border="1"> <tr><th colspan="2">MxLvl</th></tr> <tr><td>1 MxLvl1</td><td></td></tr> <tr><td>2 MxLvl2</td><td></td></tr> </table>	MxLvl		1 MxLvl1		2 MxLvl2	
Mix01A	Mix11A	Mix21A	Mix31A	Mix41A																																	
+ 50.0	+ 60.0	+ 60.0		+ 50.0																																	
Mix01B	Mix11B	Mix21B	Mix31B	Mix41B																																	
+ 50.0	+ 60.0	+ 60.0		+ 50.0																																	
Mix0 0	Mix1 0	Mix2 0	Mix3 0	Mix4 0																																	
+100.0	+100.0	+100.0		+100.0																																	
MxLvl																																					
1 MxLvl1																																					
2 MxLvl2																																					

<table border="1"> <tr><th>Mix51A</th><th>Mix61A</th><th>Mix71A</th><th>Mix81A</th><th>Mix91A</th></tr> <tr><td></td><td>+ 50.0</td><td></td><td></td><td></td></tr> <tr><th>Mix51B</th><th>Mix61B</th><th>Mix71B</th><th>Mix81B</th><th>Mix91B</th></tr> <tr><td></td><td>+ 50.0</td><td></td><td></td><td></td></tr> <tr><th>Mix5 0</th><th>Mix6 0</th><th>Mix7 0</th><th>Mix8 0</th><th>Mix9 0</th></tr> <tr><td></td><td>+100.0</td><td></td><td></td><td></td></tr> </table>	Mix51A	Mix61A	Mix71A	Mix81A	Mix91A		+ 50.0				Mix51B	Mix61B	Mix71B	Mix81B	Mix91B		+ 50.0				Mix5 0	Mix6 0	Mix7 0	Mix8 0	Mix9 0		+100.0				<table border="1"> <tr><th colspan="2">MxLvl</th></tr> <tr><td>1 MxLvl1</td><td></td></tr> <tr><td>2 MxLvl2</td><td></td></tr> </table>	MxLvl		1 MxLvl1		2 MxLvl2	
Mix51A	Mix61A	Mix71A	Mix81A	Mix91A																																	
	+ 50.0																																				
Mix51B	Mix61B	Mix71B	Mix81B	Mix91B																																	
	+ 50.0																																				
Mix5 0	Mix6 0	Mix7 0	Mix8 0	Mix9 0																																	
	+100.0																																				
MxLvl																																					
1 MxLvl1																																					
2 MxLvl2																																					

Memory No.	Int 11
Name	1 - 2 Concert Hall

## ALG (ALGORITHM)

AlMid1	AlMid2	1/0	Off
Reverb	Reverb	1-2	
RT1	RT2		
Stack	Tap		
Gate 1	Gate 2		
OFF	OFF		

ALG
TALG

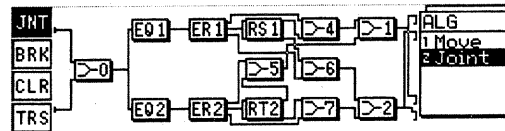

## HELP

Rev	Block1	PARAM
Reverb	1/0	1 Rev1
SubRev	1-2	2 EQ1
ER	REUTYPE	3 Rev2
ER	Stack	4 EQ2
		5 next

111 1-2 Concert Hall

Rev	Block2	PARAM
Reverb	1/0	1 Rev1
SubRev	1-2	2 EQ1
ER	REUTYPE	3 Rev2
ER	Tap	4 EQ2
		5 next

111 1-2 Concert Hall

## PARAM (PARAMETER)

### Rev1

Type	Size	RevTm	ERLvl	Bright
Room	51	0.90	46	70

PARAM
1 Rev1
2 EQ1
3 Rev2
4 EQ2
5 next

Type	Size	PreDly	RevTm	DnStg
Room	51	49	0.90	84
LowDmp	LowFrs	HiDmp	HiFrs	
0.95	60	0.70	7934	

Rev1
1 Reverb
2 SubRev
3 ER

PreDly	Level
73	30

Rev1
1 Reverb
2 SubRev
3 ER

### ER

Form	L1	L2	L3	DnStg
1	39	46	32	21
PreDly	T1	T2	T3	T4
21	19	31	27	322

Rev1
1 Reverb
2 SubRev
3 ER

### EQ1

Low Q	Freq	Gain	Type
---	500	0.0	Shlvs
Mid Q	Freq	Gain	
---	1.0	1000	1.0
High Q	Freq	Gain	Type
---	2000	4.0	Shlvs

CONTROL  
↓  
GRAPH

PARAM
1 Rev1
2 EQ1
3 Rev2
4 EQ2
5 next

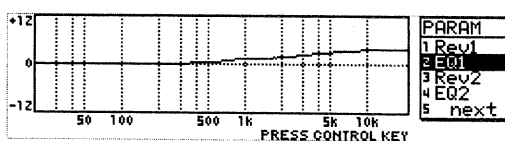

Rev2

Type	Size	RevTm	ERLw	Bright
Hall	36	3.00	38	60

PARAM  
1 Rev1  
2 EQ1  
3 Rev2  
4 EQ2  
5 next

Type	Size	PreDly	RevTm	EDnsty
Hall	36	70	3.00	80
LowDns	LowFrs	HiDns	HiFrs	RDnsty
0.95	80	0.60	5444	85

Rev2  
1 Reverb  
2 SubRev  
3 ER

PreDly Level  
85 40

Rev2  
1 Reverb  
2 SubRev  
3 ER

ER

Form	L1	L2	L3	Dnsty
2	32	38	19	29
PreDly	T1	T2	T3	T4
19	19	28	85	588

Rev2  
1 Reverb  
2 SubRev  
3 ER

EQ2

Low	Q	Freq	Gain	Type
---	---	500	0.0	Shlvs
Mid	Q	Freq	Gain	
---	---	1.0	1.0	
High	Q	Freq	Gain	Type
---	---	2000	3.0	Shlvs

CONTROL  
↓  
GRAPH

PARAM  
1 Rev1  
2 EQ1  
3 Rev2  
4 EQ2  
5 next

PARAM  
1 Rev1  
2 EQ1  
3 Rev2  
4 EQ2  
5 next

PRESS CONTROL KEY

MIXER

I/OLvl

InA	InA	InB	InB
+100.0	+ 0.0	+100.0	+ 0.0
Out1	Out2	Out3	Out4
+100.0	+100.0	+100.0	+100.0
Out1	Out2	Out3	Out4
+ 0.0	+ 0.0	+ 0.0	+ 0.0

InLvl  
1 I/OLvl

MXLvl

Mix01A	Mix11A	Mix21A	Mix31A	Mix41A
+ 50.0	+ 55.0	+ 55.0	-----	+ 50.0
Mix01B	Mix11B	Mix21B	Mix31B	Mix41B
+ 50.0	+ 62.0	+ 62.0	-----	+ 50.0
Mix0	Mix1	Mix2	Mix3	Mix4
+100.0	+100.0	+100.0	-----	+100.0

MxLvl  
1 MxLvl1  
2 MxLvl2

Mix51A	Mix61A	Mix71A	Mix81A	Mix91A
+ 50.0	+ 50.0	+ 50.0	-----	
Mix51B	Mix61B	Mix71B	Mix81B	Mix91B
+ 50.0	+ 50.0	+ 50.0	-----	
Mix5	Mix6	Mix7	Mix8	Mix9
+100.0	+100.0	+100.0	-----	

MxLvl  
1 MxLvl1  
2 MxLvl2

Memory No.	Int 12
Name	1 - 2 Garage

## ALG (ALGORITHM)

Alamd1	Alamd2	1/OTap		<table border="1"> <tr><td>ALG</td></tr> <tr><td>1 ALG</td></tr> </table>	ALG	1 ALG
ALG						
1 ALG						
Reverb	<---	1-2				
RT1	RT2					
Tap	<---					
Gate 1	Gate 2					
OFF	OFF					

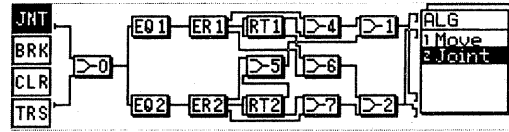

## HELP

Rev	Block	PARAM
Reverb	SYNC	1 Rev
SubRev	1-2	2 EQ
ER	REVERB	5 next
ER	Tap	
63 I12 1-2 Garage	0	

## PARAM (PARAMETER)

Rev

Type	Size	RevTm	ERLvl	Bright
Garage	14	0.85	64	90

PARAM
1 Rev
2 EQ
5 next

Type	Size	PreDly	RevTm	EDnste
Garage	14	4	0.85	70
LowDmp	LowFrs	HiDmp	HiFrs	RDnste
1.00	80	0.90	5261	70

Rev
1 Reverb
2 SubRev
3 ER

Rev
1 Reverb
2 SubRev
3 ER

ER

Form	L1	L2	L3	Dnste
4	81	64	54	72
PreDly	T1	T2	T3	T4
2	6	12	18	33

Rev
1 Reverb
2 SubRev
3 ER

EQ

Low Q	Freq	Gain	Type
---	500	0.0	Shlvs
Mid Q	Freq	Gain	
1.0	1000	1.0	
High Q	Freq	Gain	Type
---	2000	0.0	Shlvs

CONTROL  
↓  
GRAPH

PARAM
1 Rev
2 EQ
5 next

PARAM
1 Rev
2 EQ
5 next

PRESS CONTROL KEY

# MIXER

I/OLvl

InA A	InA 0	InB A	InB 0	InLvl
+ 50.0	+ 0.0	+ 50.0	+ 0.0	1 I/OLvl
Out1 A	Out2 A	Out3 A	Out4 A	
+100.0	+100.0	+100.0	+100.0	
Out1 B	Out2 B	Out3 B	Out4 B	
+ 0.0	+ 0.0	+ 0.0	+ 0.0	

MXLvl

Mix01A	Mix11A	Mix21A	Mix31A	Mix41A	MxLvl
+ 50.0	+ 85.0	+ 85.0	-----	+ 50.0	1 MxLvl1
Mix01B	Mix11B	Mix21B	Mix31B	Mix41B	2 MxLvl2
+ 50.0	+ 85.0	+ 85.0	-----	+ 50.0	
Mix0 0	Mix1 0	Mix2 0	Mix3 0	Mix4 0	
+100.0	+100.0	+100.0	-----	+100.0	

Mix51A	Mix61A	Mix71A	Mix81A	Mix91A	MxLvl
+ 50.0	+ 50.0	+ 50.0	-----	-----	1 MxLvl1
Mix51B	Mix61B	Mix71B	Mix81B	Mix91B	2 MxLvl2
+ 50.0	+ 50.0	+ 50.0	-----	-----	
Mix5 0	Mix6 0	Mix7 0	Mix8 0	Mix9 0	
+100.0	+100.0	+100.0	-----	-----	

Memory No.	Int 13
Name	1 - 2 Warehouse

## ALG (ALGORITHM)

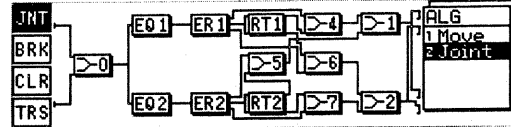
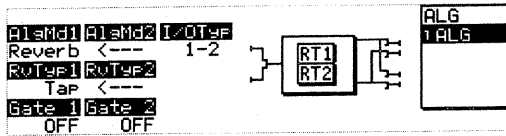

## HELP

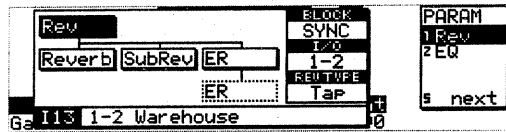

## PARAM (PARAMETER)

### Rev

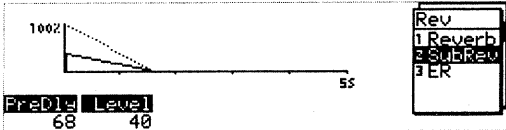
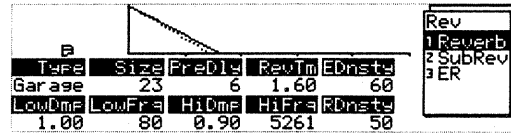
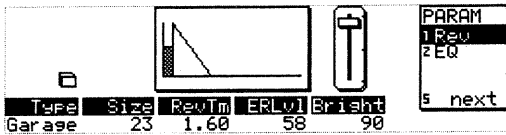

### ER

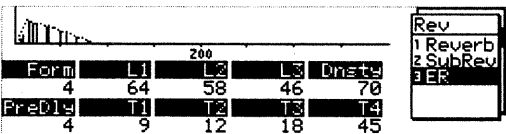

### EQ

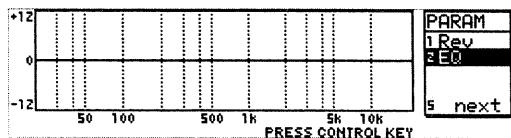
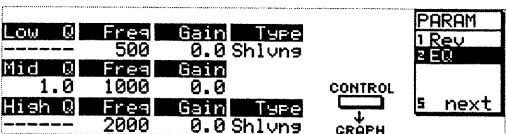

# MIXER

I/O Lvl

InA 0	InA 0	InB 0	InB 0	
+100.0	+ 0.0	+100.0	+ 0.0	
Out1 0	Out2 0	Out3 0	Out4 0	
+100.0	+100.0	+100.0	+100.0	
Out1 0	Out2 0	Out3 0	Out4 0	
+ 0.0	+ 0.0	+ 0.0	+ 0.0	

InLvl
1 I/O Lvl

MX Lvl

Mix0 0	Mix1 0	Mix2 0	Mix3 0	Mix4 0	
+ 50.0	+ 60.0	+ 60.0	-----	+ 50.0	
Mix0 0	Mix1 0	Mix2 0	Mix3 0	Mix4 0	
+ 50.0	+ 60.0	+ 60.0	-----	+ 50.0	
Mix0 0	Mix1 0	Mix2 0	Mix3 0	Mix4 0	
+100.0	+100.0	+100.0	-----	+100.0	

MxLvl
1 MX Lvl1
2 MX Lvl2

Mix5 0	Mix6 0	Mix7 0	Mix8 0	Mix9 0	
+ 50.0	+ 50.0	+ 50.0	-----		
Mix5 0	Mix6 0	Mix7 0	Mix8 0	Mix9 0	
+ 50.0	+ 50.0	+ 50.0	-----		
Mix5 0	Mix6 0	Mix7 0	Mix8 0	Mix9 0	
+100.0	+100.0	+100.0	-----		

MxLvl
1 MX Lvl1
2 MX Lvl2

Memory No.	Int 14
Name	1 - 2 Kitchen

## ALG (ALGORITHM)

AlSMD1	AlSMD2	1/OTyp	
Plate	Plate	1-2	
RevTYP1	RevTYP2		
Stack	Stack		
Gate 1	Gate 2		
OFF	OFF		

ALG
1 ALG

JNT						
BRK	>0	EQ1	PS1	>1		
CLR		EQ2	PS2	>2		
TRS						

ALG
1 Move
2 Joint

## HELP

Plate		BLOCK	PARAM
Plate	SubRev	Block1	1 Plate1
		1/0	2 EQ1
		1-2	3 Plate2
		REUTYPE	4 EQ2
		Stack	5 next
I14 1-2 Kitchen			

Plate		BLOCK	PARAM
Plate	SubRev	Block2	1 Plate1
		1/0	2 EQ1
		1-2	3 Plate2
		REUTYPE	4 EQ2
		Stack	5 next
I14 1-2 Kitchen			

## PARAM (PARAMETER)

Plate1

Type	RevTm	Bright
3	0.60	20

PARAM
1 Plate1
2 EQ1
3 Plate2
4 EQ2
5 next

Type	Brill	Depth	PreD1	RevTm	Dnstr
3	32	50	16	0.60	100
	LowDmp	LowFrs	HiDmp	HiFrs	
	0.86	50	0.80	7409	

Plate1
1 Plate
2 SubRev

PreD1	Level
0	25

Plate1
1 Plate
2 SubRev

EQ1

Low Q	Freq	Gain	Type
	500	0.0	Shlvs
Mid Q	Freq	Gain	
	1.0	2884	2.0
High Q	Freq	Gain	Type
	4274	-3.0	Shlvs

CONTROL  
↓  
GRAPH

PARAM
1 Plate1
2 EQ1
3 Plate2
4 EQ2
5 next

PRESS CONTROL KEY

PARAM
1 Plate1
2 EQ1
3 Plate2
4 EQ2
5 next



### Plate2

[Visualizer]			PARAM		
Type	RevTm	Bright	1 Plate1		
4	0.16	50	2 EQ1		
			3 Plate2		
			4 EQ2		
			5 next		

Plate2					
Type	4				
Brill	Depth	PreDly	RevTm	Dnstr	
50	50	13	0.16	62	
LowDm	LowFrs	HiDm	HiFrs		
0.92	50	0.86	7159		

1000		55		Plate2	
PreDly	Level			1 Plate	
0	25			2 SubRev	

### EQ2

Low Q	Freq	Gain	Type	PARAM	
-----	500	0.0	Shlvs	1 Plate1	
Mid Q	Freq	Gain		2 EQ1	
-----	1.0	1000	0.0	3 Plate2	
High Q	Freq	Gain	Type	4 EQ2	
-----	2000	-2.0	Shlvs	5 next	

CONTROL  
↓  
GRAPH

+12		-12		PARAM	
[Graph]				1 Plate1	
				2 EQ1	
				3 Plate2	
				4 EQ2	
				5 next	

PRESS CONTROL KEY

## MIXER

### I/O Lvl

InA A	InA 0	InB A	InB 0	InLvl	
+100.0	+ 0.0	+100.0	+ 0.0	1 I/O Lvl	
Out1 A	Out2 A	Out3 A	Out4 A		
+100.0	+100.0	+100.0	+100.0		
Out1 B	Out2 B	Out3 B	Out4 B		
+ 0.0	+ 0.0	+ 0.0	+ 0.0		

### MX Lvl

Mix01A	Mix11A	Mix21A	Mix31A	Mix41A	MxLvl	
+ 50.0	+ 60.0	+ 60.0			1 MxLvl1	
Mix01B	Mix11B	Mix21B	Mix31B	Mix41B	2 MxLvl2	
+ 50.0	+ 40.0	+ 40.0				
Mix0 0	Mix1 0	Mix2 0	Mix3 0	Mix4 0		
+100.0	+100.0	+100.0				

Mix51A	Mix61A	Mix71A	Mix81A	Mix91A	MxLvl	
Mix51B	Mix61B	Mix71B	Mix81B	Mix91B	1 MxLvl1	
Mix5 0	Mix6 0	Mix7 0	Mix8 0	Mix9 0	2 MxLvl2	

Memory No.	Int 15
Name	1 - 2 Cathedral

## ALG (ALGORITHM)

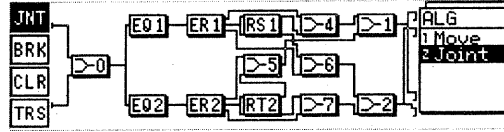
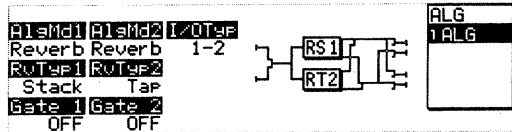

## HELP

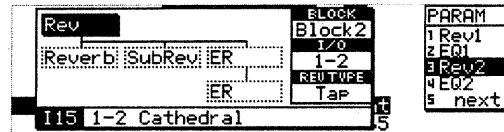
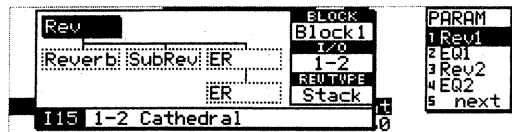

## PARAM (PARAMETER)

### Rev1

Type	Size	RevTm	ERLvl	Bright
Room	43	4.00	90	60

Type	Size	PreDly	RevTm	Dnсты
Room	43	41	4.00	74
LowDm	LowFrs	HiDm	HiFrs	
0.95	60	0.60	6918	

PreDly	Level
61	30

### ER

Form	L1	L2	L3	Dnсты
1	77	90	55	24
PreDly	T1	T2	T3	T4
20	19	30	118	680

### EQ1

Low Q	Freq	Gain	Type
---	500	0.0	Shlvs
Mid Q	Freq	Gain	Type
---	1.0	1000	4.0
High Q	Freq	Gain	Type
---	2000	0.0	Shlvs

CONTROL  
↓  
GRAPH

PARAM
1 Rev1
2 EQ1
3 Rev2
4 EQ2
5 next

50 100 500 1k 5k 10k  
PRESS CONTROL KEY

Rev2







Type	Size	RevTm	ERLvl	Bright
Room	43	3.50	80	65

PARAM				
1	Rev1			
2	EQ1			
3	Rev2			
4	EQ2			
5	next			



PreDly	Level
56	25

Rev2		
1	Reverb	
2	SubRev	
3	ER	

Type	Size	PreDly	RevTm	EDnsty
Room	43	40	3.50	85
LowDmp	LowFrs	HiDmp	HiFrs	RDnsty
0.95	60	0.65	5444	70

Rev2		
1	Reverb	
2	SubRev	
3	ER	

ER

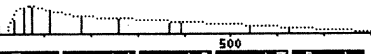

Form	L1	L2	L3	Dnsty
1	68	80	49	24
PreDly	T1	T2	T3	T4
20	19	30	103	636

Rev2		
1	Reverb	
2	SubRev	
3	ER	

EQ2

Low Q	Frea	Gain	Type
	500	6.0	Shlvs
Mid Q	Frea	Gain	
	1.0	1000	6.0
High Q	Frea	Gain	Type
	2000	-3.0	Shlvs

PARAM				
1	Rev1			
2	EQ1			
3	Rev2			
4	EQ2			
5	next			

CONTROL  
↓  
GRAPH

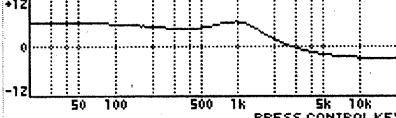

PARAM				
1	Rev1			
2	EQ1			
3	Rev2			
4	EQ2			
5	next			

PRESS CONTROL KEY

MIXER

I/OLvl

InA A	InA 0	InB A	InB 0
+ 50.0	+ 0.0	+ 50.0	+ 0.0
Out1 A	Out2 A	Out3 A	Out4 A
+100.0	+100.0	+100.0	+100.0
Out1 B	Out2 B	Out3 B	Out4 B
+ 0.0	+ 0.0	+ 0.0	+ 0.0

InLv1	
1	I/OLvl

MXLv1

Mix01A	Mix11A	Mix21A	Mix31A	Mix41A
+ 50.0	+100.0	+100.0		+ 50.0
Mix01B	Mix11B	Mix21B	Mix31B	Mix41B
+ 50.0	+100.0	+100.0		+ 50.0
Mix0 0	Mix1 0	Mix2 0	Mix3 0	Mix4 0
+100.0	+100.0	+100.0		+100.0

MxLv1	
1	MxLv1
2	MxLv12

Mix51A	Mix61A	Mix71A	Mix81A	Mix91A
+ 50.0	+ 50.0	+ 50.0		
Mix51B	Mix61B	Mix71B	Mix81B	Mix91B
+ 50.0	+ 50.0	+ 50.0		
Mix5 0	Mix6 0	Mix7 0	Mix8 0	Mix9 0
+ 80.0	+100.0	+ 80.0		

MxLv1	
1	MxLv1
2	MxLv12

Memory No.	Int 16
Name	1 - 2 Chorus & Reverb 1

## ALG (ALGORITHM)

ALG1 ALG2 I/O Tap  
 Reverb <--- 1-2  
 RT1P1 RT1P2  
 Tap <---  
 Gate 1 Gate 2  
 OFF OFF

mod:ff

ALG  
1 ALG

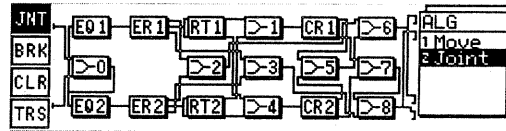

## HELP

Rev  
 Reverb: SubRev: ER  
 ER  
 116 1-2 Chorus & Reverb1

BLOCK  
 SYNC  
 I/O  
 1-2  
 REU TPE  
 Tap

PARAM  
 1 Rev  
 2 EQ  
 5 next

## PARAM (PARAMETER)

### Rev

PARAM  
1 Rev  
2 EQ  
5 next

Type	Size	RevTm	ERLvl	Bright
Hall	51	1.80	60	40

Rev  
1 Reverb  
2 SubRev  
3 ER

Type	Size	PreDly	RevTm	EDnsty
Hall	51	72	1.80	100
LowDm	LowFra	HiDm	HiFra	RDnsty
0.95	80	0.40	4284	100

Rev  
1 Reverb  
2 SubRev  
3 ER

PreDly	Level
122	40

### ER

Rev  
1 Reverb  
2 SubRev  
3 ER

Form	L1	L2	L3	Dnsty
2	51	60	42	21
PreDly	T1	T2	T3	T4
21	19	31	54	456

### EQ

Low Q	Freq	Gain	Type
---	500	0.0	Shlvs
Mid Q	Freq	Gain	Type
---	1.0	1000	0.0
High Q	Freq	Gain	Type
---	2000	0.0	Shlvs

CONTROL  
↓  
GRAPH

PARAM  
1 Rev  
2 EQ  
5 next

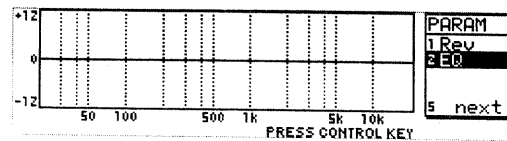

Chorus

Phase	PRE DELAY 1	F		PARAM
60	PRE DELAY 2	2		1 Chorus
PrDly1	Rate1	Depth1	2	2 Delay
0.1	0.6	10	5	next
PrDly2	Rate2	Depth2	5	
0.1	0.6	10		

MIXER

I/O Lvl

InA A	InA 0	InB A	InB 0	InLvl 1 I/O Lvl
+100.0	+ 0.0	+100.0	+ 0.0	
Out1 A	Out2 A	Out3 A	Out4 A	
+100.0	+100.0	+100.0	+100.0	
Out1 B	Out2 B	Out3 B	Out4 B	
+ 0.0	+ 0.0	+ 0.0	+ 0.0	

MX Lvl

Mix01A	Mix11A	Mix21A	Mix31A	Mix41A	MxLvl 1 MxLvl1 2 MxLvl2
+ 50.0	+ 50.0	+ 50.0	+ 50.0	+ 50.0	
Mix01B	Mix11B	Mix21B	Mix31B	Mix41B	
+ 50.0	+ 50.0	+ 50.0	+ 50.0	+ 50.0	
Mix0 0	Mix1 0	Mix2 0	Mix3 0	Mix4 0	
+100.0	+100.0	+100.0	+100.0	+100.0	

Mix51A	Mix61A	Mix71A	Mix81A	Mix91A	MxLvl 1 MxLvl1 2 MxLvl2
+ 70.0	+ 80.0	+ 30.0	+ 80.0	-----	
Mix51B	Mix61B	Mix71B	Mix81B	Mix91B	
+ 30.0	+ 80.0	+ 70.0	+ 80.0	-----	
Mix5 0	Mix6 0	Mix7 0	Mix8 0	Mix9 0	
+100.0	+100.0	+100.0	+100.0	+100.0	

Memory No.	Int 17
Name	2 - 2 Chorus & Reverb 2

## ALG (ALGORITHM)

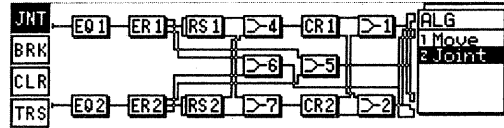
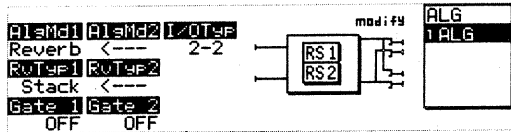

## HELP

Rev  
 Reverb SubRev ER  
 ER  
 117 2-2 Chorus & Reverb2

Block  
 SYNC  
 100  
 2-2  
 REVERB  
 Stack

PARAM  
 1 Rev  
 2 EQ  
 5 next

## PARAM (PARAMETER)

### Rev

PARAM  
 1 Rev  
 2 EQ  
 5 next

Type	Size	PreDly	ReuTm	ERLW1	Bright
Hall	43	10	2.80	58	76

Rev  
 1 Reverb  
 2 SubRev  
 3 ER

Type	Size	PreDly	ReuTm	Dnsta
Hall	43	10	2.80	74
LowDmF	LowFmF	HiDmF	HiFmF	
0.90	116	0.76	8496	

Rev  
 1 Reverb  
 2 SubRev  
 3 ER

PreDly	Level
87	34

### ER

Rev  
 1 Reverb  
 2 SubRev  
 3 ER

Form	L1	L2	L3	Dnsta
4	47	58	46	70
PreDly	T1	T2	T3	T4
7	17	18	27	65

### EQ

Low	0	Freq	Gain	Type
-----	500	0.0	Shlvs	
Mid	0	Freq	Gain	
-----	1.0	1000	0.0	
High	0	Freq	Gain	Type
-----	2000	0.0	Shlvs	

PARAM  
 1 Rev  
 2 EQ  
 5 next

CONTROL  
 ↓  
 GRAPH

PARAM  
 1 Rev  
 2 EQ  
 5 next

12  
 0  
 -12

50 100 500 1k 5k 10k

PRESS CONTROL KEY

Chorus

Phase	PRE DELAY 1		PARAM
60	PRE DELAY 2		1 Chorus
PrD1	Rate1	Depth1	2 Delay
0.1	0.3	10	
PrD2	Rate2	Depth2	5 next
0.1	0.3	10	

MIXER

I/OLvl

InA	InA 0	InB	InB 0	<table border="1"> <tr><td>InLvl</td></tr> <tr><td>1 I/OLvl</td></tr> </table>	InLvl	1 I/OLvl
InLvl						
1 I/OLvl						
+100.0	+ 0.0	+100.0	+ 0.0			
Out1	Out2	Out3	Out4			
+ 50.0	+ 50.0	+ 50.0	+ 50.0			
Out1	Out2	Out3	Out4			
+ 50.0	+ 50.0	+ 50.0	+ 50.0			

MXLvl

Mix01A	Mix11A	Mix21A	Mix31A	Mix41A	<table border="1"> <tr><td>MxLvl</td></tr> <tr><td>1 MxLvl1</td></tr> <tr><td>2 MxLvl2</td></tr> </table>	MxLvl	1 MxLvl1	2 MxLvl2
MxLvl								
1 MxLvl1								
2 MxLvl2								
-----	+ 85.0	+ 40.0	-----	+ 70.0				
Mix01B	Mix11B	Mix21B	Mix31B	Mix41B				
-----	+ 40.0	+ 85.0	-----	+ 30.0				
Mix0 0	Mix1 0	Mix2 0	Mix3 0	Mix4 0				
-----	+100.0	+100.0	-----	+100.0				

Mix51A	Mix61A	Mix71A	Mix81A	Mix91A	<table border="1"> <tr><td>MxLvl</td></tr> <tr><td>1 MxLvl1</td></tr> <tr><td>2 MxLvl2</td></tr> </table>	MxLvl	1 MxLvl1	2 MxLvl2
MxLvl								
1 MxLvl1								
2 MxLvl2								
-----	+ 60.0	+ 60.0	+ 30.0	-----				
Mix51B	Mix61B	Mix71B	Mix81B	Mix91B				
-----	+ 60.0	+ 60.0	+ 70.0	-----				
Mix5 0	Mix6 0	Mix7 0	Mix8 0	Mix9 0				
-----	+100.0	+100.0	+100.0	-----				

Memory No.	Int 18
Name	1 - 2 Delay & Reverb 1

## ALG (ALGORITHM)

AlMid1 AlMid2 1/0Type  
 Reverb Reverb 1-2  
 ROTEP1 ROTEP2  
 Stack Stack  
 Gate 1 Gate 2  
 OFF OFF

mod: #9

ALG  
1 ALG

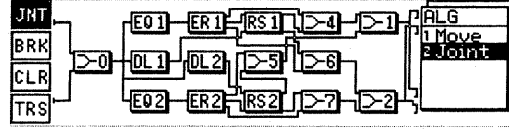

## HELP

Rev  
 Reverb: SubRev: ER  
 ER  
 I18 1-2 Delay & Reverb 1

Block  
Block1  
1/0  
1-2  
REVTYP  
Stack

PARAM  
1 Rev1  
2 EQ1  
3 Rev2  
4 EQ2  
5 next

Rev  
 Reverb: SubRev: ER  
 ER  
 I18 1-2 Delay & Reverb 1

Block  
Block2  
1/0  
1-2  
REVTYP  
Stack

PARAM  
1 Rev1  
2 EQ1  
3 Rev2  
4 EQ2  
5 next

## PARAM (PARAMETER)

Rev1

PARAM  
1 Rev1  
2 EQ1  
3 Rev2  
4 EQ2  
5 next

Type	Size	RevTm	ERLvl	Bright
Room	9.4	4.00	100	65

Rev1  
1 Reverb  
2 SubRev  
3 ER

Type	Size	PreDly	RevTm	Dnsta
Room	9.4	9	4.00	18
LowDm	LowFra	HiDm	HiFra	
0.95	60	0.65	6918	

Rev1  
1 Reverb  
2 SubRev  
3 ER

PreDly	Level
13	30

ER

Rev1  
1 Reverb  
2 SubRev  
3 ER

Form	L1	L2	L3	Dnsta
1	100	100	4	21
PreDly	T1	T2	T3	T4
20	5	95	35	0

ER  
1 ER

Number	Delay	Level
2	92	100

ER  
1 ER

Number	Delay	Level
1	70	100

ER  
1 ER

Number	Delay	Level
3	150	93

ER  
1 ER

Number	Delay	Level
4	130	90



### EQ1

Low Q	Freq	Gain	Type
-----	500	0.0	Shlvs
Mid Q	Freq	Gain	Type
-----	1.0	1000	0.0
High Q	Freq	Gain	Type
-----	2000	0.0	Shlvs

PARAM  
1 Rev1  
2 EQ1  
3 Rev2  
4 EQ2  
5 next

CONTROL  
↓  
GRAPH

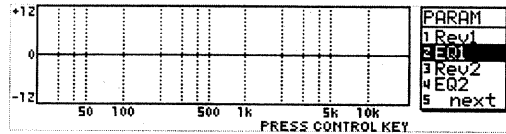

### Rev2

Type	Size	RevTm	ERLvl	Bright
Room	9.4	4.00	45	57

PARAM  
1 Rev1  
2 EQ1  
3 Rev2  
4 EQ2  
5 next

Rev2  
1 Reverb  
2 SubRev  
3 ER

100%

PreDly Level  
13 30

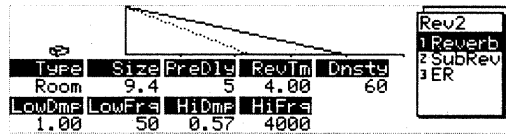

### ER

Form	L1	L2	L3	DnSty
4	100	45	0	7

PARAM  
1 Reverb  
2 SubRev  
3 ER

PreDly	T1	T2	T3	T4
72	1	286	80	0

### Delay

DlyTm1	FdBck1	Out1
174	+ 45.0	+ 50

PARAM  
1 Chorus  
2 Delay

DlyTm2	FdBck2	Out2
107	+ 45.0	+ 50

5 next

### EQ2

Low Q	Freq	Gain	Type
-----	500	0.0	Shlvs
Mid Q	Freq	Gain	Type
-----	1.0	1000	0.0
High Q	Freq	Gain	Type
-----	2000	0.0	Shlvs

PARAM  
1 Rev1  
2 EQ1  
3 Rev2  
4 EQ2  
5 next

CONTROL  
↓  
GRAPH

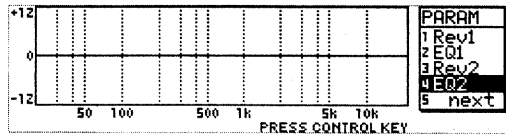

## MIXER

### I/O Lvl

InA A	InA 0	InB A	InB 0
+ 50.0	+ 0.0	+ 50.0	+ 0.0
Out1 A	Out2 A	Out3 A	Out4 A
+100.0	+100.0	+100.0	+100.0
Out1 B	Out2 B	Out3 B	Out4 B
+ 0.0	+ 0.0	+ 0.0	+ 0.0

InLvl  
1 I/O Lvl

### MX Lvl

Mix01A	Mix11A	Mix21A	Mix31A	Mix41A
+ 50.0	+100.0	+ 45.0	-----	+ 70.0
Mix01B	Mix11B	Mix21B	Mix31B	Mix41B
+ 50.0	+ 45.0	+100.0	-----	+ 70.0
Mix0 0	Mix1 0	Mix2 0	Mix3 0	Mix4 0
+100.0	+100.0	+100.0	-----	+100.0

MxLvl  
1 MxLvl1  
2 MxLvl2

Mix51A	Mix61A	Mix71A	Mix81A	Mix91A
+ 70.0	+ 70.0	+ 70.0	-----	+ 70.0
Mix51B	Mix61B	Mix71B	Mix81B	Mix91B
+ 70.0	+ 70.0	+ 70.0	-----	+ 70.0
Mix5 0	Mix6 0	Mix7 0	Mix8 0	Mix9 0
+100.0	+100.0	+100.0	-----	+100.0

MxLvl  
1 MxLvl1  
2 MxLvl2

Memory No.	Int 19
Name	2 - 2 Delay & Reverb 2

## ALG (ALGORITHM)

AlcMd1	AlcMd2	I/OType	
Reverb	<---	2-2	
ROUTYPE1	ROUTYPE2		
Stack	<---		
Gate 1	Gate 2		
OFF	OFF		

ALG	1 ALG
-----	-------

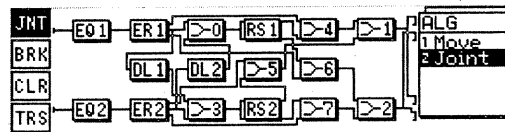

## HELP

Rev	Block	PARAM
Reverb: SubRev: ER	SYNC	1 Rev
	2-2	2 EQ
	2-2	
	REARTYPE	
	Stack	5 next
I19 2-2 Delay & Reverb 2		

## PARAM (PARAMETER)

### Rev

Type	Size	RevTm	ERLW	Bright
Hall	51	2.80	60	50

PARAM	1 Rev
	2 EQ
	5 next

Type	Size	PreDly	RevTm	Dnsty
Hall	51	76	2.80	90
LowDmp	LowFrs	HiDmp	HiFrs	
0.95	80	0.50	6033	

Rev	1 Reverb
	2 SubRev
	3 ER

PreDly	Level
144	40

Rev	1 Reverb
	2 SubRev
	3 ER

### ER

Form	L1	L2	L3	Dnsty
2	51	60	42	21
PreDly	T1	T2	T3	T4
21	19	31	85	568

Rev	1 Reverb
	2 SubRev
	3 ER

### EQ

Low	Q	Freq	Gain	Type
---	---	500	- 2.0	Shlvs
Mid	Q	Freq	Gain	
---	---	1000	0.0	
High	Q	Freq	Gain	Type
---	---	2000	- 8.0	Shlvs

CONTROL  
↓  
GRAPH

PARAM	1 Rev
	2 EQ
	5 next

PARAM	1 Rev
	2 EQ
	5 next

PRESS CONTROL KEY

Delay

Delay	FdBck	Out
102	0.0	+100
102	0.0	+100

PARAM  
1 Chorus  
2 Delay  
5 next

# MIXER

I/O Lvl

InA	InA 0	InB	InB 0
+100.0	+ 0.0	+100.0	+ 0.0
Out1 A	Out2 A	Out3 A	Out4 A
+100.0	+100.0	+100.0	+100.0
Out1 B	Out2 B	Out3 B	Out4 B
+ 0.0	+ 0.0	+ 0.0	+ 0.0

InLvl  
1 I/O Lvl

MX Lvl

Mix01A	Mix11A	Mix21A	Mix31A	Mix41A
+ 75.0	+100.0	+ 45.0	+ 30.0	+ 50.0
Mix01B	Mix11B	Mix21B	Mix31B	Mix41B
+ 30.0	+ 45.0	+100.0	+ 75.0	+ 50.0
Mix0 0	Mix1 0	Mix2 0	Mix3 0	Mix4 0
+100.0	+100.0	+100.0	+100.0	+100.0

MxLvl  
1 MxLvl1  
2 MxLvl2

Mix51A	Mix61A	Mix71A	Mix81A	Mix91A
+ 50.0	+ 50.0	+ 50.0	-----	-----
Mix51B	Mix61B	Mix71B	Mix81B	Mix91B
+ 50.0	+ 50.0	+ 50.0	-----	-----
Mix5 0	Mix6 0	Mix7 0	Mix8 0	Mix9 0
+100.0	+100.0	+100.0	-----	-----

MxLvl  
1 MxLvl1  
2 MxLvl2

Memory No.	Int 20
Name	2 - 2 Independent Rev

## ALG (ALGORITHM)

AlsmD1 AlsmD2 I/O TEP  
 Reverb Reverb 2-2  
 RUTYP1 RUTYP2  
 Stack Stack  
 Gate 1 Gate 2  
 OFF OFF

modify

ALG  
1ALG

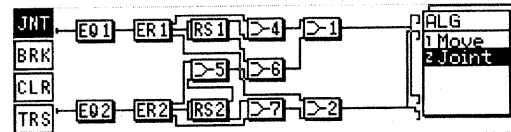

## HELP

Rev  
 Reverb SubRev ER  
 ER  
 I20 2-2 Independent Rev

BLOCK  
 Block1  
 I/O  
 2-2  
 REVTYPE  
 Stack

PARAM  
 1 Rev  
 2 EQ1  
 3 Rev2  
 4 EQ2  
 5 next

Rev  
 Reverb SubRev ER  
 ER  
 I20 2-2 Independent Rev

BLOCK  
 Block2  
 I/O  
 2-2  
 REVTYPE  
 Stack

PARAM  
 1 Rev  
 2 EQ1  
 3 Rev2  
 4 EQ2  
 5 next

## PARAM (PARAMETER)

Rev1

Type Size RevTm ERLvl Bright  
 Room 60 3.00 50 60

PARAM  
 1 Rev  
 2 EQ1  
 3 Rev2  
 4 EQ2  
 5 next

Type	Size	PreDly	RevTm	Dnsty
Room	60	58	3.00	94
LowDmp	LowFrg	HiDmp	HiFrg	
0.95	60	0.60	6918	

Rev1  
 1 Reverb  
 2 SubRev  
 3 ER

PreDly Level  
 87 30

Rev1  
 1 Reverb  
 2 SubRev  
 3 ER

ER

Form	L1	L2	L3	Dnsty
1	43	50	35	19
PreDly	T1	T2	T3	T4
22	20	32	94	588

Rev1  
 1 Reverb  
 2 SubRev  
 3 ER

EQ1

Low Q	Freq	Gain	Type
---	500	0.0	Shlvs
Mid Q	Freq	Gain	
---	1.0	1000	0.0
High Q	Freq	Gain	Type
---	2000	0.0	Shlvs

CONTROL  
 ↓  
 GRAPH

PARAM  
 1 Rev  
 2 EQ1  
 3 Rev2  
 4 EQ2  
 5 next

PARAM  
 1 Rev  
 2 EQ1  
 3 Rev2  
 4 EQ2  
 5 next

PRESS CONTROL KEY

Rev2

Type	Size	PreDly	RevTm	ERLvl	Bright
Room	51	3.10	50	50	60

PARAM  
1 Rev1  
2 EQ1  
3 Rev2  
4 EQ2  
5 next

Type	Size	PreDly	RevTm	Dnstr
Room	51	58	3.10	94
LowDnstr	LowFrs	HiDnstr	HiFrs	
0.95	60	0.60	6918	

Rev2  
1 Reverb  
2 SubRev  
3 ER

PreDly Level  
87 30

Rev2  
1 Reverb  
2 SubRev  
3 ER

ER

Form	L1	L2	L3	Dnstr
1	43	50	35	19
PreDly	T1	T2	T3	T4
22	20	32	94	558

Rev2  
1 Reverb  
2 SubRev  
3 ER

EQ2

Low Q	Freq	Gain	Type
	500	0.0	Shlvs
Mid Q	Freq	Gain	
	1.0	1000	0.0
High Q	Freq	Gain	Type
	2000	0.0	Shlvs

CONTROL  
↓  
GRAPH

PARAM  
1 Rev1  
2 EQ1  
3 Rev2  
4 EQ2  
5 next

PARAM  
1 Rev1  
2 EQ1  
3 Rev2  
4 EQ2  
5 next

PRESS CONTROL KEY

MIXER

I/O Lvl

InA	InA	InB	InB
+100.0	+ 0.0	+100.0	+ 0.0
Out1	Out2	Out3	Out4
+100.0	+100.0	+100.0	+100.0
Out1	Out2	Out3	Out4
+ 0.0	+ 0.0	+ 0.0	+ 0.0

InLvl  
1 I/O Lvl

MxLvl

Mix01A	Mix11A	Mix21A	Mix31A	Mix41A
+ 70.0	+ 70.0			+ 50.0
Mix01B	Mix11B	Mix21B	Mix31B	Mix41B
+ 70.0	+ 70.0			+ 50.0
Mix0	Mix1	Mix2	Mix3	Mix4
+100.0	+ 89.0			+100.0

MxLvl  
1 MxLvl1  
2 MxLvl2

Mix51A	Mix61A	Mix71A	Mix81A	Mix91A
+ 50.0	+ 50.0	+ 50.0		
Mix51B	Mix61B	Mix71B	Mix81B	Mix91B
+ 50.0	+ 50.0	+ 50.0		
Mix5	Mix6	Mix7	Mix8	Mix9
+100.0	+100.0	+100.0		

MxLvl  
1 MxLvl1  
2 MxLvl2

Memory No.	Int 21
Name	1 - 2 Gated Reverb

## ALG (ALGORITHM)

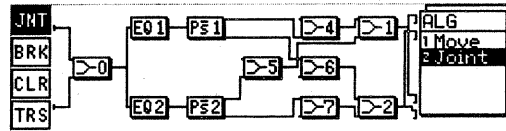
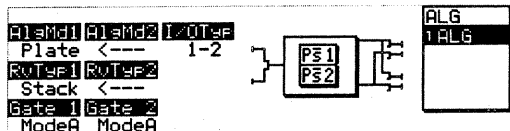

## HELP

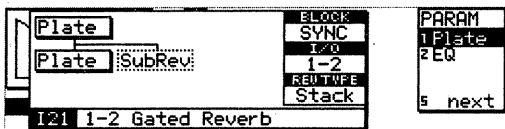

## PARAM (PARAMETER)

### Plate

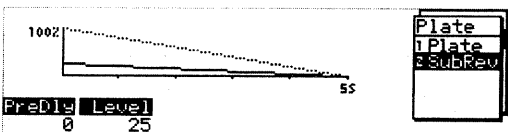
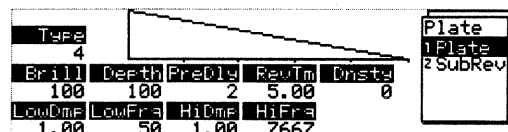

### EQ

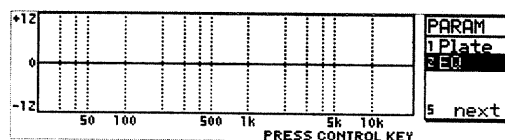
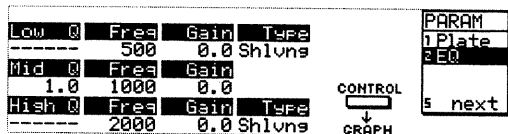

### Gate1

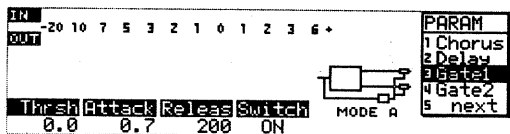

Gate2

IN	-20	10	7	5	3	2	1	0	1	2	3	6+	PARAM
OUT													1 Chorus
													2 Delay
													3 Gate1
													4 Gate2
													5 next
Thresh	Attack	Release	Switch	MODE A									
0.0	0.7	200	ON										

MIXER

I/O Lvl

InA A	InA 0	InB A	InB 0	InLvl
+100.0	+ 0.0	+100.0	+ 0.0	1 I/O Lvl
Out1 A	Out2 A	Out3 A	Out4 A	
+100.0	+100.0	+100.0	+100.0	
Out1 B	Out2 B	Out3 B	Out4 B	
+ 0.0	+ 0.0	+ 0.0	+ 0.0	

MX Lvl

Mix01A	Mix11A	Mix21A	Mix31A	Mix41A	MxLvl
+ 50.0	+ 80.0	+ 80.0	-----	+ 0.0	1 MxLvl1
Mix01B	Mix11B	Mix21B	Mix31B	Mix41B	2 MxLvl2
+ 50.0	+ 80.0	+ 80.0	-----	+ 70.0	
Mix0 0	Mix1 0	Mix2 0	Mix3 0	Mix4 0	
+100.0	+100.0	+100.0	-----	-Gate-	

Mix51A	Mix61A	Mix71A	Mix81A	Mix91A	MxLvl
+ 0.0	+ 70.0	+ 70.0	-----	-----	1 MxLvl1
Mix51B	Mix61B	Mix71B	Mix81B	Mix91B	2 MxLvl2
+ 70.0	+ 0.0	+ 0.0	-----	-----	
Mix5 0	Mix6 0	Mix7 0	Mix8 0	Mix9 0	
-Gate-	-Gate-	-Gate-	-----	-----	

Memory No.	Int 22
Name	2 - 2 Non Linear

## ALG (ALGORITHM)

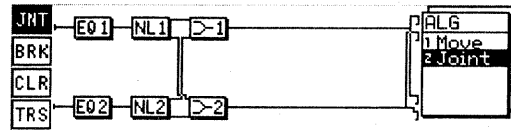
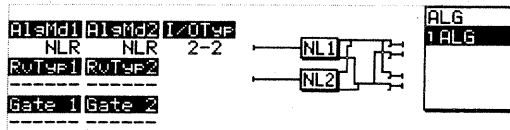

## HELP

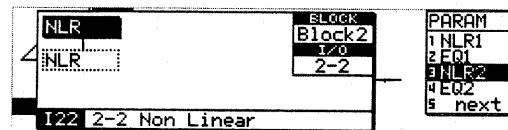
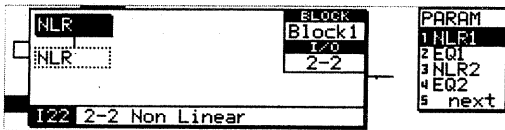

## PARAM (PARAMETER)

NLR1

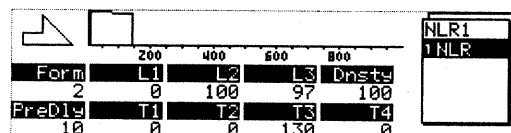
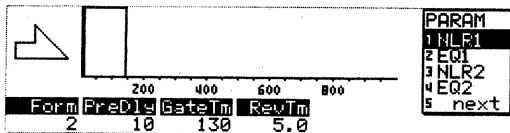

EQ1

Low @	Freq	Gain	Type
	500	0.0	Shluns
Mid @	Freq	Gain	
	1.0	1000	0.0
High @	Freq	Gain	Type
	2000	0.0	Shluns

CONTROL  
↓  
GRAPH

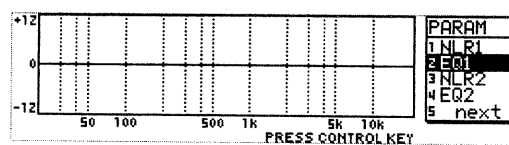



NLR2

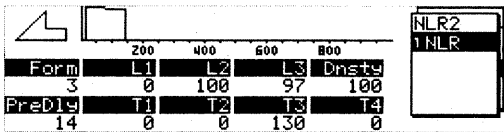
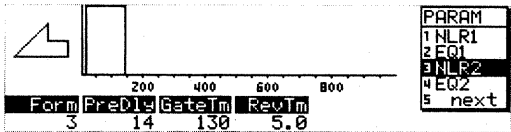

-EQ2

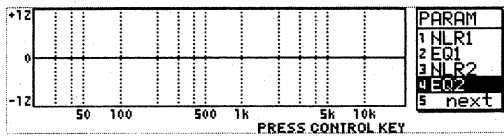
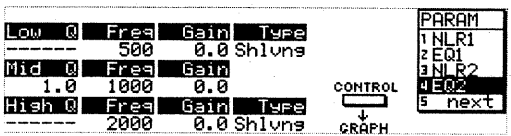

MIXER

I/O Lvl



MX Lvl

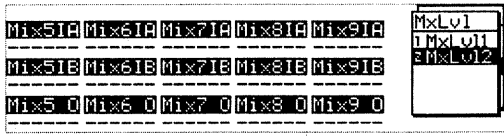

Memory No.	Int 23
Name	1 - 2 INSANE

## ALG (ALGORITHM)

Al1Md1	Al1Md2	1/OT	SP
Reverb	<---	2-2	
RUTP1	RUTP2		
Tap	<---		
Gate1	Gate2		
OFF	OFF		

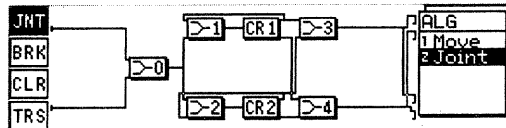

## PARAM (PARAMETER)

### Chorus

Phase	PRE DELAY 1		PARAM
180	PRE DELAY 2		1 Chorus
PrDly1	Rate1	Depth1	2 Delay
0.1	0.3	50	
PrDly2	Rate2	Depth2	3 next
0.1	0.3	50	

## MIXER

### I/O Lvl

InA A	InA 0	InB A	InB 0	<table border="1"> <tr> <td>InLvl</td> </tr> <tr> <td>1 I/O Lvl</td> </tr> </table>	InLvl	1 I/O Lvl
InLvl						
1 I/O Lvl						
+100.0	+ 0.0	+100.0	+ 0.0			
Out1 A	Out2 A	Out3 A	Out4 A			
+100.0	+100.0	+100.0	+100.0			
Out1 B	Out2 B	Out3 B	Out4 B			
+ 0.0	+ 0.0	+ 0.0	+ 0.0			

### MX Lvl

Mix01A	Mix11A	Mix21A	Mix31A	Mix41A	<table border="1"> <tr> <td>MxLvl</td> </tr> <tr> <td>1 MxLvl1</td> </tr> <tr> <td>2 MxLvl2</td> </tr> </table>	MxLvl	1 MxLvl1	2 MxLvl2
MxLvl								
1 MxLvl1								
2 MxLvl2								
+ 50.0	-100.0	+100.0	+ 50.0	+ 50.0				
Mix01B	Mix11B	Mix21B	Mix31B	Mix41B				
+ 50.0	-100.0	+100.0	+ 50.0	+ 50.0				
Mix0 0	Mix1 0	Mix2 0	Mix3 0	Mix4 0				
+100.0	-100.0	+100.0	+ 70.0	+ 70.0				

Mix51A	Mix61A	Mix71A	Mix81A	Mix91A	<table border="1"> <tr> <td>MxLvl</td> </tr> <tr> <td>1 MxLvl1</td> </tr> <tr> <td>2 MxLvl2</td> </tr> </table>	MxLvl	1 MxLvl1	2 MxLvl2
MxLvl								
1 MxLvl1								
2 MxLvl2								
Mix51B	Mix61B	Mix71B	Mix81B	Mix91B				
Mix5 0	Mix6 0	Mix7 0	Mix8 0	Mix9 0				



**Roland®**

---

**74148229**

UPC

74148229



10901

**Roland**