

***FP-4***

Owner's Manual

Roland®



# Introduction

Thank you, and congratulations on your choice of the FP-4. To ensure that you obtain the maximum enjoyment and take full advantage of the FP-4's functionality, please read this owner's manual carefully.

## About the Manual

You should first read the "Before You Play" (p. 15) section of the owner's manual (this document). This explains how to connect the AC adaptor and turn on the power.

The owner's manual explains basic operations you'll need to know in order to master the FP-4's performance functions, as well as more advanced operations, such as using the FP-4 to record a song.

## Conventions in this Manual

In order to explain the operations as clearly as possible, this manual uses the following conventions.

- Text enclosed in square brackets [ ] indicates the name of a button or a knob, such as the [Display] button.
- Lines that begin with **NOTE** or an asterisk \* are cautionary statements that you must be sure to read.
- The numbers of pages that you can turn to for additional, related information are given like this: (p. \*\*).
- This document uses screen shots for explanatory purposes. Please be aware that the settings in these explanatory screen shots may not match the actual factory settings (Tone names, etc.).

**Before using this unit, carefully read the sections entitled: "USING THE UNIT SAFELY" (p. 7), and "Important Notes" (p. 10). These sections provide important information concerning the proper operation of the unit. Additionally, in order to feel assured that you have gained a good grasp of every feature provided by your new unit, owner's manual should be read in its entirety. The manual should be saved and kept on hand as a convenient reference.**

Copyright © 2006 ROLAND CORPORATION

All rights reserved. No part of this publication may be reproduced in any form without the written permission of ROLAND CORPORATION.

# Main Features

## Serious piano performance

The FP-4 provides the sounds of a high-quality concert grand piano coupled with the PHA alpha II keyboard, which delivers a more piano-like touch, where the low range is heavier and the high range is lighter.

It provides three pedal jacks, and is shipped with a pedal that supports half-damper operation, allowing you to adjust the depth of the lingering resonances so that you can enjoy the subtle nuances of serious piano performance.

## High-quality speakers and piano sounds

The FP-4 features 88-key multi-sampled piano sounds.

Every note of an 88-key grand piano has been sampled to faithfully reproduce its tonal character and allow for dynamic expression of the full range of sonic nuances, from delicate pianissimo to powerful fortissimo.

The rich resonances and lifelike presence of these sounds are faithfully reproduced through the high-quality speakers of the FP-4.

## “Session Partner” lets you enjoy session-style playing

You can play the piano along with realistic “rhythms” to enjoy session-style performances.

Since suitable chord progressions are assigned to each rhythm, simply selecting a rhythm will automatically choose the appropriate chord progression.

## “Registrations” let you store favorite performance settings

Your performance settings such as sound selections, settings for Session Partner, and keyboard touch settings can be stored as a “registration” for instant recall when desired.

## Sounds that cover a wide range of styles, plus high-quality effects

In addition to piano sounds, the FP-4 contains more than 300 different sounds that can be used in a wide range of musical genres. You can also use the keyboard to play drum sets.

You can also apply sixty-two types of high-quality effects for even greater expressive potential.



# Contents

<b>Introduction .....</b>	<b>3</b>	Transposing the Key of the Keyboard (Key Transpose) ..	39
About the Manual.....	3	Performing with the Metronome.....	40
Conventions in this Manual.....	3	Changing the Tempo .....	41
<b>Main Features .....</b>	<b>4</b>	Changing the Volume .....	41
<b>USING THE UNIT SAFELY .....</b>	<b>7</b>	Adding Liveliness to the Sound (Sound Control).....	42
<b>Important Notes.....</b>	<b>10</b>	Changing the Tonal Quality (Equalizer).....	43
<b>Names of Things and What They Do .....</b>	<b>12</b>	Changing the Equalizer Type.....	43
<b>Before You Play .....</b>	<b>15</b>	<b>Playing Along with Rhythms.....</b>	<b>44</b>
Getting Ready to Play .....	15	What is Session Partner?.....	44
Connecting the AC Adaptor.....	15	Performing Along with Session Partner .....	45
Turning the Power On/Off.....	16	Changing the Volume of the Session Partner	
Adjusting the Volume .....	17	Performance .....	47
Attaching the Music Rest.....	17	Selecting Parts .....	47
Connecting the Pedals.....	18	Selecting a Rhythm .....	48
Listening through Headphones.....	19	Changing a Rhythm's Tempo .....	49
<b>Listening to Songs .....</b>	<b>20</b>	Selecting a Rhythm's Chord Progression .....	50
Listening to Demo Songs.....	20	Performing with the Chord Progression Specified	
Listening to Internal Songs.....	22	in the Left Hand (Chord Progression Off) .....	51
Changing the Volume of the Song .....	23	Changing the Rhythm Pattern (Original/Variation).....	53
Playing Back All Songs Continuously (All Song Play) .	24	Recording the Chord Progression .....	54
Listening to Each Part Separately (Track Mute).....	25	Changing the Number of Measures of the Chord	
Determining the Volume of a Muted Track .....	26	Progression You Record .....	55
Listening to Songs Saved in Internal Memory.....	27	<b>Saving Your Favorite Performance Settings .</b>	<b>56</b>
<b>Performing.....</b>	<b>28</b>	About the Performance Settings (Registration).....	56
Performing with a Variety of Sounds .....	28	Storing Your Performance Settings (Registration).....	57
Performing with Two Layered Tones (Dual Play) .....	29	Recalling a Registration.....	59
Changing the Tone Variations .....	30	Saving a Registration Set.....	60
Performing with Different Tones in the Left and		Loading a Registration Set You Saved .....	62
Right Sides of the Keyboard (Split Play) .....	31	Deleting a Registration Set You Saved.....	63
Switching Tone Groups and Tone Variations.....	32	Using a Pedal to Switch Registrations.....	64
Changing the Keyboard's Split Point.....	33	<b>Recording.....</b>	<b>65</b>
Changing the Volume Balance for Dual Play and		Recording a New Song.....	66
Split Play .....	34	Recording Your Playing Along with a Song .....	68
Adjusting the Keyboard Sensitivity (Key Touch).....	35	Recording Your Performance with Session Partner .....	70
Adding Reverberation to Sounds (Reverb Effect) .....	36	Recording Selected Track Buttons .....	72
Changing the Depth of Reverb Effect.....	36	Erasing Recorded Performances .....	75
Adding a Variety Effects to the Sound (Effects).....	37	<b>Saving a Performance.....</b>	<b>76</b>
Adding a Spinning Sound to Organ Tones		Saving the Songs You Record .....	76
(Rotary Effect).....	38	Deleting a Saved Song .....	77

## Contents

---

### Settings ..... 78

Tuning Settings .....	79
Matching the Pitch with Other Instruments (Master Tuning) .....	79
Adjusting the Tuning (Temperament).....	80
Pedal Settings .....	81
Changing How the Pedal Effects Are Applied .....	81
Changing How the Pedals Work .....	82
Effect Settings.....	83
Changing the Effect Type.....	83
Setting the Part to Which Effects Are Added.....	84
System Settings.....	84
Specifying the Sound Control Setting at Power-on.....	84
Specifying the Equalizer Setting at Power-on.....	84
Adjusting the Volume (Master Gain).....	85
Equalizer Settings .....	85
Changing the Equalizer Settings .....	85
Keyboard Settings .....	86
Changing the Keyboard Touch (Key Touch) .....	86
Changing the Velocity When the Key Touch is Set to "OFF" .....	87
Changing the Pitch of the Lower Tone in Octave Steps (Octave Shift) .....	87
Session Partner Settings .....	88
Setting the Intro and Ending On or Off.....	88
Selecting a Chord Progression Pattern .....	88
Selecting the Root Note of the Chord Progression .....	89
Fixing a Set Chord Progression .....	89
Setting the Chord Display On or Off.....	90
Initializing (Formatting) Memory .....	90
Initializing Internal Memory .....	90
Metronome Setting.....	91
Changing the Beat of Metronome .....	91
Other Settings .....	91
Restoring the Factory-set Condition (Factory Reset) ....	91
Disabling the Buttons (Panel Lock) .....	92
Using the V-LINK Function.....	92

### Connecting Other Equipment ..... 93

Connecting Audio Equipment.....	94
Sending the Sound to External Speakers.....	94
Listening to a CD from the FP-4's Speakers.....	95
Recording an FP-4 Performance to an External Device ...	96
Recording an FP-4 Performance to a CD or Cassette Tape, etc. ....	96
Using Your Computer to Create a CD .....	97

Connecting to a Computer.....	98
Connecting to a Computer via the USB (MIDI) Connector .....	98
Connecting to MIDI Devices.....	99
What's MIDI? .....	99
Making the Connections.....	99
Using the FP-4 to Play Another MIDI Sound Module..	100
MIDI Settings .....	100

### Appendices

Troubleshooting.....	106
Error Messages .....	110
Tone List .....	111
Rhythm List.....	116
Chord Progression Pattern List .....	117
Chord Fingering List.....	120
Internal Song List .....	124
Registration List .....	125
Effects List .....	126
Stored Settings .....	128
MIDI Implementation Chart .....	129
Specifications .....	130
Index .....	132

# USING THE UNIT SAFELY

## INSTRUCTIONS FOR THE PREVENTION OF FIRE, ELECTRIC SHOCK, OR INJURY TO PERSONS

### About ⚠ WARNING and ⚠ CAUTION Notices

<b>⚠ WARNING</b>	Used for instructions intended to alert the user to the risk of death or severe injury should the unit be used improperly.
<b>⚠ CAUTION</b>	Used for instructions intended to alert the user to the risk of injury or material damage should the unit be used improperly. * Material damage refers to damage or other adverse effects caused with respect to the home and all its furnishings, as well to domestic animals or pets.

### About the Symbols

	The ⚠ symbol alerts the user to important instructions or warnings. The specific meaning of the symbol is determined by the design contained within the triangle. In the case of the symbol at left, it is used for general cautions, warnings, or alerts to danger.
	The ⓧ symbol alerts the user to items that must never be carried out (are forbidden). The specific thing that must not be done is indicated by the design contained within the circle. In the case of the symbol at left, it means that the unit must never be disassembled.
	The ● symbol alerts the user to things that must be carried out. The specific thing that must be done is indicated by the design contained within the circle. In the case of the symbol at left, it means that the power-cord plug must be unplugged from the outlet.

## ALWAYS OBSERVE THE FOLLOWING

### ⚠ WARNING

#### Do not disassemble or modify

Do not open (or modify in any way) the unit or its AC adaptor.



#### Do not repair or replace parts

Never attempt to repair this device or replace parts. If repair or part replacement should become necessary, you must contact your dealer or a Roland service center.



#### Do not use or store in the following types of locations

- Locations of extremely high temperature (such as in direct sunlight, near heating equipment, or on a device that generates heat)
- Near moisture (such as in a bathroom, near a sink, or on a wet floor) or in locations of high humidity
- Locations exposed to rain
- Locations of excessive dust
- Locations subject to heavy vibration

#### Use only a stand that is recommended

This unit should be used only with a stand that is recommended by Roland.



#### Do not place in an unstable location

When using the unit with a stand recommended by Roland, the stand must be carefully placed so it is level and sure to remain stable. If not using a stand, you still need to make sure that any location you choose for placing the unit provides a level surface that will properly support the unit, and keep it from wobbling.



### ⚠ WARNING

#### Connect the AC adaptor to an outlet of the correct voltage

Be sure to use only the AC adaptor supplied with the unit. Also, make sure the line voltage at the installation matches the input voltage specified on the AC adaptor's body. Other AC adaptors may use a different polarity, or be designed for a different voltage, so their use could result in damage, malfunction, or electric shock



#### Use only the included power cord

You must use only the power cord included with the device. Do not use the included power cord with any other device.



#### Do not bend the power cord or place heavy objects on it

Do not bend the power cord excessively, or place heavy objects on the power cord. Doing so will damage the power cord, and may cause short circuits or faulty connections, possibly resulting in fire or electrical shock.



#### Do not share an outlet with an unreasonable number of other devices

Do not connect excessive numbers of electrical devices to a single power outlet. In particular, when using a power strip, exceeding the rated capacity (watts/amps) of the power strip may cause heat to be generated, possibly melting the cable.



### **WARNING**

#### **Avoid extended use at high volume**

This device, either by itself or used in conjunction with headphones, amps, and/or speakers, is capable of producing volume levels that can cause permanent hearing damage. If you experience impaired hearing or ringing in your ears, immediately stop using the device and consult a medical specialist.



#### **Do not insert foreign objects**

Never allow foreign objects (flammable objects, coins, wires, etc.) to enter this device. This can cause short circuits or other malfunctions.



#### **Turn off the power if an abnormality or malfunction occurs**

Immediately turn the power off, remove the AC adaptor from the outlet, and contact your dealer or a service center to have the device serviced.



- The AC adaptor, the power-supply cord, or the plug has been damaged
- The device produces smoke or an unusual smell
- A foreign object enters the device, or liquid spills into the device
- The device becomes wet (by rain, etc.)
- An abnormality or malfunction occurs in the device

#### **Do not allow children to use without supervision**

In households with children, take particular care against tampering. If children are to use this device, they must be supervised or guided by an adult.



#### **Do not drop or subject to strong impact**

Do not drop this device or subject it to strong impact.



#### **Do not use overseas**

If you wish to use this device overseas, please contact your dealer or a service center.



#### **Do not place containers of water on the device**

Do not place containers of water (such as a flower vase) or drinks on the device. Nor should you place containers of insecticide, perfume, alcoholic liquids, nail polish, or spray cans on the device. Liquids that spill into the device may cause it to malfunction, and may cause short circuits or faulty operation.



### **CAUTION**

#### **Place in a well ventilated location**

When using this device and AC adaptor, ensure that it is placed in a well ventilated location.



#### **Grasp the plug when connecting or disconnecting the power cord**

Always grasp only the plug on the AC adaptor cord when plugging into, or unplugging from, an outlet or this unit.



#### **Periodically wipe the dust off the AC adaptor plug**

At regular intervals, you should unplug the AC adaptor and clean it by using a dry cloth to wipe all dust and other accumulations away from its prongs. Also, disconnect the power plug from the power outlet whenever the unit is to remain unused for an extended period of time. Any accumulation of dust between the power plug and the power outlet can result in poor insulation and lead to fire.



#### **Manage cables for safety**

Ensure that the connected cables are organized and managed in a safe manner. In particular, place the cables out of reach of children.



#### **Do not stand or place heavy objects on this device**

Do not stand on this device, or place heavy objects on it.



#### **Do not connect or disconnect the AC adaptor with wet hands**

Never handle the AC adaptor or its plugs with wet hands when plugging into, or unplugging from, an outlet or this unit.



#### **Cautions when moving this device**

When moving this device, please check the following cautions. Then, make sure that at least two persons work together in lifting and carrying the device, all the while making sure to keep it level. When doing so, be careful not to pinch your hands or drop the device on your feet.



- Check whether the knob bolts fastening the device to its stand have become loose. If they are loose, tighten them firmly.
- Disconnect the power cord.
- Disconnect external devices.
- Remove the music rest.

**⚠ CAUTION**

**Unplug the AC adaptor from the AC outlet before cleaning**

Before cleaning the unit, turn off the power and unplug the AC adaptor from the outlet (p. 15).



**If there is a possibility of lightning strike, disconnect the AC adaptor from the AC outlet**

Whenever you suspect the possibility of lightning in your area, disconnect the AC adaptor from the outlet.



**Keep small items out of the reach of children**

To prevent small items such as the following from being swallowed accidentally, keep them out of the reach of children.



- Included items
  - Music rest attachment screws

**Don't touch parts that get hot**

The area near the power switch may become hot; be careful to avoid burns.



# Important Notes

In addition to the "USING THE UNIT SAFELY" listed on page 7, please observe the following cautions.

## Power Supply

- Do not connect this device to the same electrical outlet as an inverter-controlled device such as a refrigerator, microwave oven, or air conditioner, or a device that contains an electric motor. Depending on how the other device is used, power supply noise could cause this device to malfunction or produce noise. If it is not practical to use a separate electrical outlet, please connect this device via a power supply noise filter.
- The AC adaptor will begin to generate heat after long hours of consecutive use. This is normal, and is not a cause for concern.
- Before you make connections, you must switch off the power on all devices to prevent malfunction and/or speaker damage.

## Location

- If this device is placed near devices that contain large transformers, such as power amps, hum may be induced in this device. If this occurs, move this device farther away or change its orientation.
- If this device is operated near a television or radio, color distortion may be seen in the television screen or noise may be heard from the radio. If this occurs, move this device farther away.
- Keep your cell phone powered off or at a sufficient distance from this device. If a cell phone is nearby, noise may be heard when a call is received or initiated, or during conversation.
- Do not leave this device in direct sunlight, near devices that produce heat, or in a closed-up automobile. Do not allow illumination devices operated in close proximity (such as a piano light) or powerful spotlights to shine on the same location on this device for an extended time. This can cause deformation or color change.
- If you move this device between locations of radically different temperature or humidity, water droplets (condensation) may form inside the device. Using the device in this condition will cause malfunctions, so please allow several hours for the condensation to disappear before you use the device.
- Do not allow items made of rubber or vinyl to remain on top of this device for an extended time. This can cause deformation or color change.
- Do not leave objects on top of the keyboard. This can cause malfunctions such as failure to sound.
- Do not affix adhesive labels to this device. The exterior finish may be damaged when you remove the labels.

- Depending on the material and temperature of the surface on which you place the unit, its rubber feet may discolor or mar the surface.  
You can place a piece of felt or cloth under the rubber feet to prevent this from happening. If you do so, please make sure that the unit will not slip or move accidentally.

## Care

- For everyday care, wipe with a soft dry cloth, or remove stubborn dirt using a tightly wrung-out cloth. If this device contains wooden components, wipe the entire area following the direction of the grain. The finish may be damaged if you continue strongly rubbing a single location.
- If water droplets should adhere to this device, immediately wipe them off using a soft dry cloth.
- Do not use solvents such as benzene, thinner, or alcohol, since these can cause deformation or color change.



## Servicing

- Please be aware that all data contained in the unit's memory may be lost when the unit is sent for repairs. Important data should always be backed up in another MIDI device (e.g., a sequencer), or written down on paper (when possible). During repairs, due care is taken to avoid the loss of data. However, in certain cases (such as when circuitry related to memory itself is out of order), we regret that it may not be possible to restore the data, and Roland assumes no liability concerning such loss of data.

## Other Cautions

- Stored content may be lost due to a malfunction of the device or because of inadvertent operation. You should back up important content on another MIDI device (e.g., a sequencer) as a safeguard against such loss.
- We cannot accept responsibility for the recovery of any content lost from internal memory, or for the consequences of such loss.
- Do not apply excessive force to the buttons, knobs, or input/output jacks, since this may cause malfunctions.
- When connecting or disconnecting cables, grasp the plug (not the cable) to prevent short circuits or broken connections.
- This device may produce a certain amount of heat, but this is not a malfunction.

- Please enjoy your music in ways that do not inconvenience other people nearby, and pay particular attention to the volume at nighttime. Using headphones will allow you to enjoy music without having to be concerned about others.
- When you need to transport the unit, package it in the box (including padding) that it came in, if possible. Otherwise, you will need to use equivalent packaging materials.
- If using the music rest, do not apply excessive force to it.
- Use only the specified expression pedal (EV-5; available separately). Connecting a pedal made by a different manufacturer may cause this device to malfunction.
- Some connection cables contain a resistor. Do not connect such cables to this device. Doing so may make the volume extremely low or inaudible. Please use connection cables not containing a resistor.

- \* GS (  ) is a registered trademark of Roland Corporation.
- \* XG lite (  ) is a registered trademark of Yamaha Corporation.
- \* Microsoft and Windows are registered trademarks of Microsoft Corporation.
- \* Windows® is known officially as: "Microsoft® Windows® operating system."
- \* Apple and Macintosh are registered trademarks of Apple Computer, Inc.
- \* Mac OS is a trademark of Apple Computer, Inc.
- \* All product names mentioned in this document are trademarks or registered trademarks of their respective owners.

# Names of Things and What They Do

## Front Panel

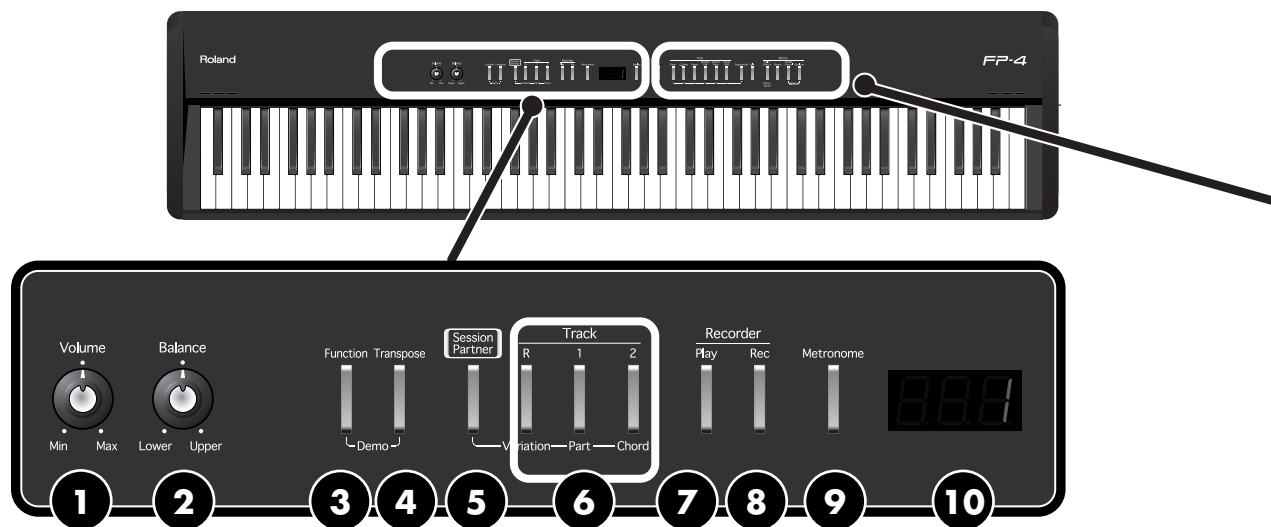

### 1 [Volume] Knob

Adjusts the overall volume of the FP-4 (p. 17). If headphones are connected, this adjusts the headphone volume (p. 19).

### 2 [Balance] Knob

Adjusts the volume balance of the Upper and Lower Tones in Dual Play and Split Play (p. 34).

### 3 [Function] Button

This button lets you make various settings. By holding down this button and pressing the [Transpose] button, you can listen to the demo song (p. 20).

### 4 [Transpose] Button

This button lets you transpose the keyboard or (p. 39). By holding down this button and pressing the [Function] button, you can listen to the demo song (p. 20).

### 5 [Session Partner] Button

This button switches on/off the Session Partner function (p. 45). By switching Session Partner on, you can produce a rhythm in a variety of styles.

### 6 Track Buttons

These buttons switch the performance part when playing a song (p. 25). These buttons also switch Session Partner's performance parts, chord progression patterns, and rhythm patterns (p. 47, p. 50, p. 53).

### 7 [Play] Button

Starts and stops playback of internal songs and recorded performances (p. 22). Used for starting recording of performances (p. 65).

### 8 [Rec] Button

You can record your own playing into the FP-4 (p. 65).

### 9 [Metronome] Button

Turns the internal metronome on and off (p. 40).

### 10 Display

This shows information such as tone numbers, song numbers, rhythm numbers, tempo, and the values of various settings.



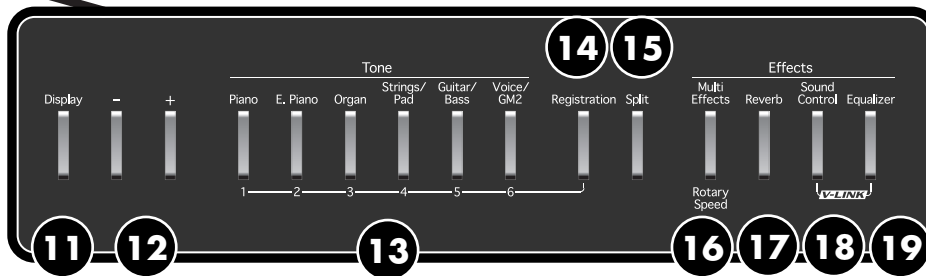

### 11 [Display] Button

Press this button when you want to change the tone, the song to play back, the rhythm, or the tempo. Each time you press this button, the display will alternate between showing the tone number, song number, rhythm number, and tempo.

### 12 [-] [+] Buttons

These two buttons are used to modify the values of a variety of settings. Pressing both the [-] and [+] buttons simultaneously returns the setting of a particular item or function to its original value.

If you're playing the song while the song select screen is displayed, you can hold down these buttons to rewind or fast-forward.

### 13 Tone Buttons

They are used to choose the kinds of sounds (Tone Groups) played by the keyboard (p. 28).

While the [Registration] button is lit, Tone buttons [1]–[6] can be used to select registrations.

### 14 [Registration] Button

This button lets you store your favorite performance settings, such as those for the selection of tones, Session Partner (p. 56).

### 15 [Split] Button

Allows you to play different tones in the left and right sides of the keyboard (p. 31).

### 16 [Multi Effects] Button

This button lets you apply various effects to the sound (p. 37).

### 17 [Reverb] Button

You can use this to add the characteristic reverberation of a concert hall to what you play (p. 36).

### 18 [Sound Control] Button

This button gives the sound more expressive range (p. 42).

By holding down this button and pressing the [Equalizer] button, you can turn V-LINK on and off (p. 92).

### 19 [Equalizer] Button

Switches the equalizer on or off (p. 43). You can use the equalizer to adjust the tonal character by boosting or cutting just the low or high frequency regions.

By holding down this button and pressing the [Sound Control] button, you can turn V-LINK on and off (p. 92).

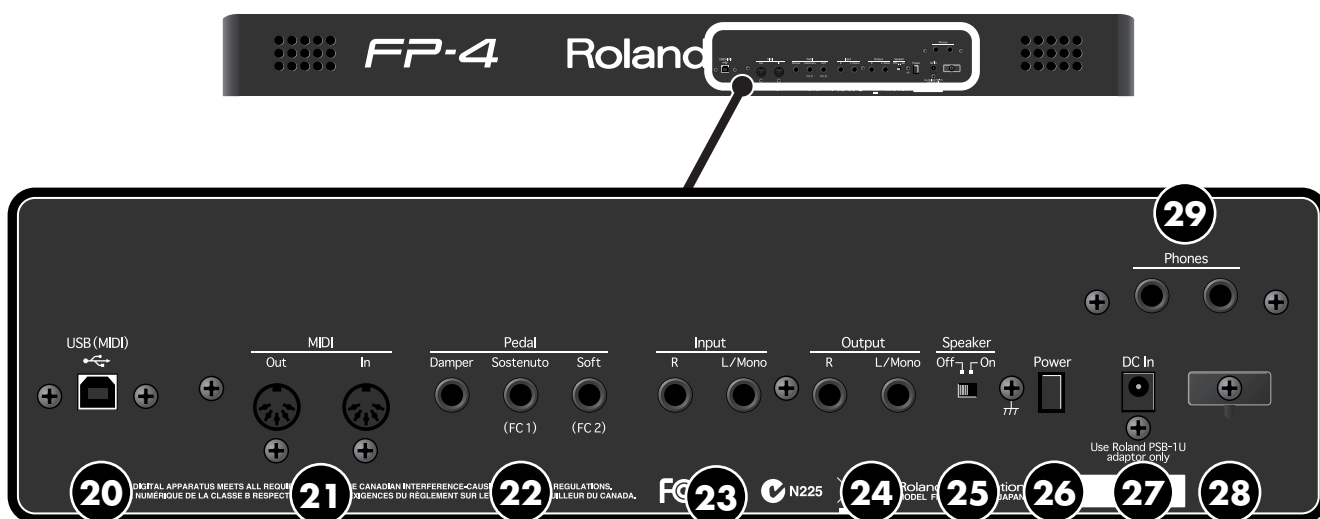

## Rear Panel

These connectors are located at the rear panel.

### 20 USB (MIDI) Connector

You can connect this to your computer for transferring performance data (p. 98).

### 21 MIDI Connector

You can connect these to external MIDI devices to transfer performance data (p. 99).

### 22 Pedal Jacks

Accepts connection of the supplied pedal (DP Series), or other suitable pedals (p. 18).

### 23 Input Jacks

Here you can connect an audio device or another electronic musical instrument, and listen to the connected device through the FP-4's speakers (p. 95).

### 24 Output Jacks

You can connect external speakers here to reproduce the FP-4's sound (p. 94, p. 96).

### 25 Speaker Switch

This switch turns the internal speaker on/off (p. 94).

### 26 [Power] Switch

Turns the power on/off (p. 16).

### 27 DC In Jack

Connect the supplied AC adaptor here (p. 15).

### 28 Cord Hook

Use this to fix in place the cord from the supplied AC adaptor (p. 15).

### 29 Phones Jacks

Here you can connect headphones. The FP-4 lets you use two sets of headphones simultaneously (p. 19).

# Before You Play

## Getting Ready to Play

### Connecting the AC Adaptor

1. Make sure that the [Power] switch located at the rear of the keyboard is off (in the upper position).

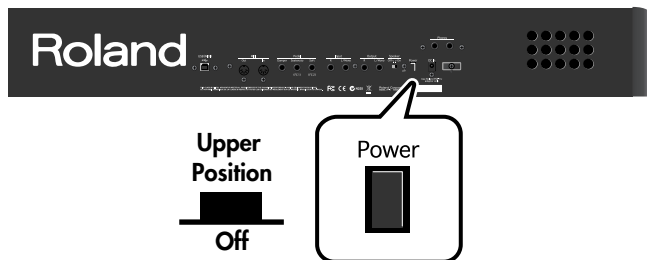

2. Turn the [Volume] knob all the way toward the left to minimize the volume.
3. Connect the supplied Power Cord to the supplied AC adaptor.

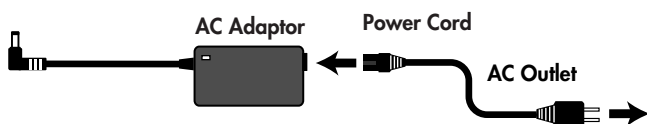

4. Connect the AC adaptor to the FP-4's DC In jack, and plug the power cord into an electrical outlet.
5. Loop the AC adaptor cord around the cord hook to fasten it in place.

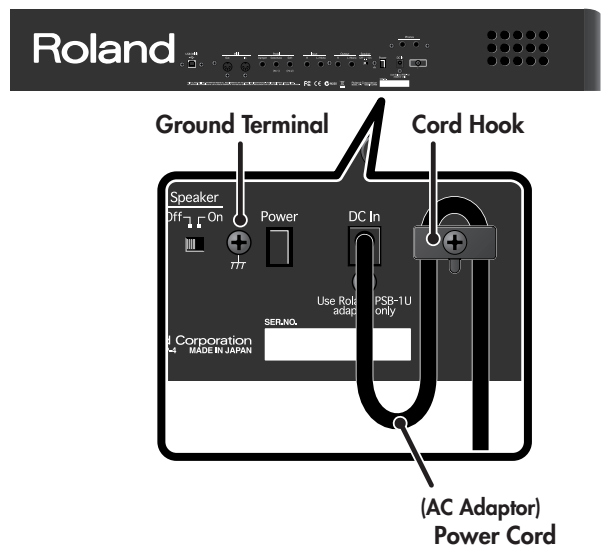

To prevent the inadvertent disruption of power to your unit (should the plug be pulled out accidentally), and to avoid applying undue stress to the AC adaptor jack, anchor the power cord using the cord hook, as shown in the illustration.

Even if the cord is fastened, strong tension applied to the cord may cause it to be damaged or broken. Be careful not to pull the cord accidentally, or to apply strong pressure to it.

Depending on the circumstances of a particular setup, you may experience a discomforting sensation, or perceive that the surface feels gritty to the touch when you touch this device. This is due to an infinitesimal electrical charge, which is absolutely harmless. However, if you are concerned about this, connect the ground terminal (see figure) with an external ground. When the unit is grounded, a slight hum may occur, depending on the particulars of your installation. If you are unsure of the connection method, contact the nearest Roland Service Center, or an authorized Roland distributor, as listed on the "Information" page.

#### Unsuitable places for connection

- Water pipes (may result in shock or electrocution)
- Gas pipes (may result in fire or explosion)
- Telephone-line ground or lightning rod (may be dangerous in the event of lightning)

## Turning the Power On/Off

**NOTE** Once you've got everything connected properly, you can turn on the power using the following procedure. If you fail to perform these steps in the correct order, you risk causing a malfunction or damaging the speakers.

### Turning the Power On

1. Turn the [Volume] knob all the way toward the left to minimize the volume.

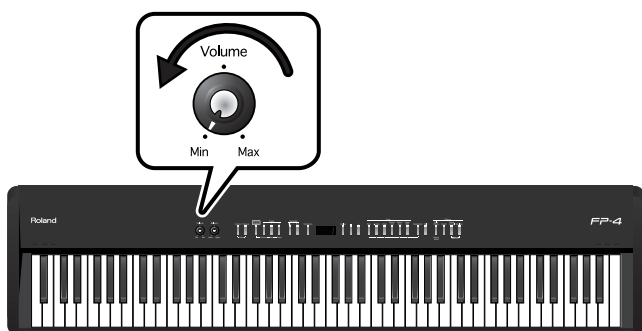

2. Press the [Power] switch.

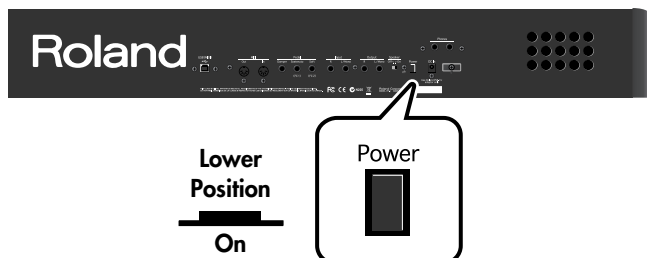

The power will turn on, and the [Piano] and other buttons will light.

3. Use the [Volume] knob to adjust the volume (p. 17).

The unit becomes operable and playing the keyboard produces sound.

**NOTE** Due to a circuitry protection feature, this unit requires a few moments after power is turned on before it is ready for normal operation.

### Turning the Power Off

1. Turn the [Volume] knob all the way toward the left to minimize the volume.

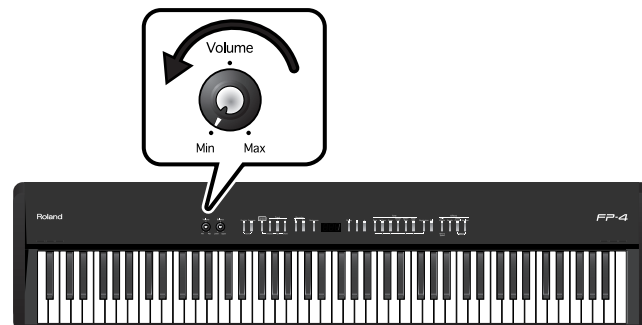

2. Press the [Power] switch.

The screen goes blank and the power is turned off.

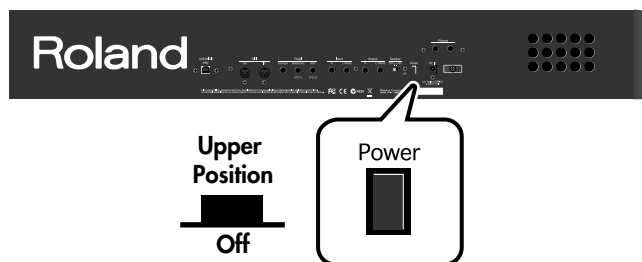

## Adjusting the Volume

Here's how to adjust the volume when you're playing the keyboard, or when you're playing back internal preset songs or internal memory songs.

If headphones are connected, use the [Volume] knob to adjust the headphone volume.

### 1. Turn the [Volume] knob to adjust the overall volume.

Adjust the volume while you play the keyboard to produce sound.

Rotating the knob clockwise increases the volume; counterclockwise rotation decreases it.

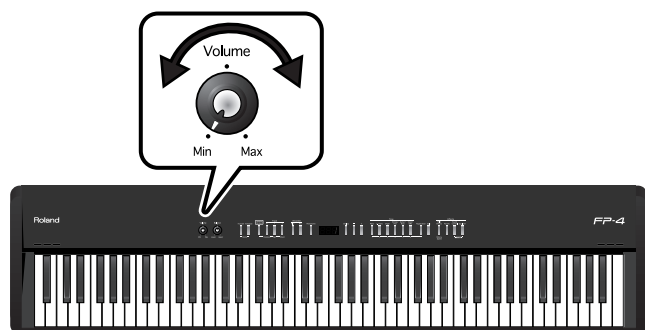

## Attaching the Music Rest

Here's how to attach the included music rest.

### 1. Install the included screws into the back of the instrument (two locations) as shown in the illustration.

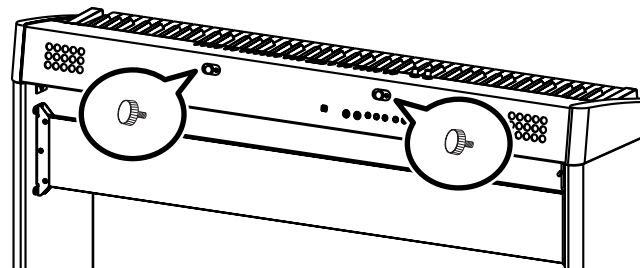

### 2. Place the music rest between the screws and the chassis.

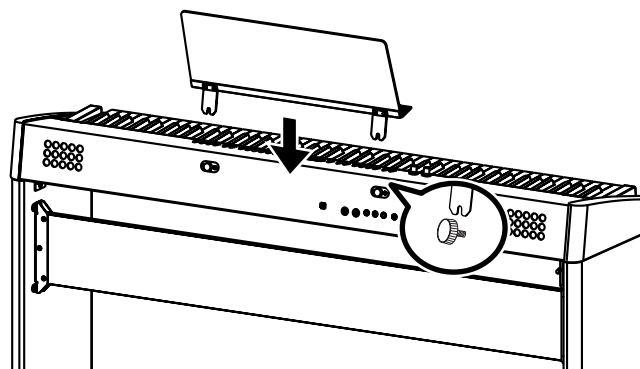

### 3. While using one hand to support the music rest, tighten the screws (two locations) to fasten the music rest firmly in place.

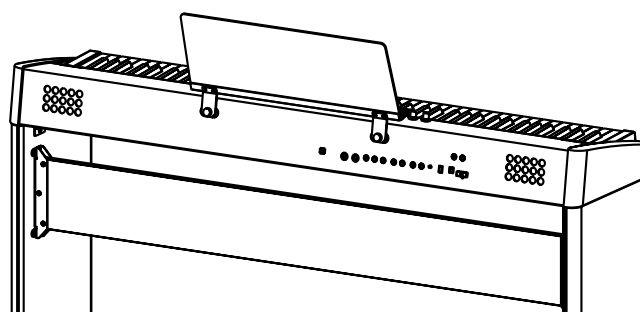

When attaching the music rest, you must use your hand to support it firmly so that it does not fall. Be careful not to pinch your hand.

To remove the music rest, support it with one hand while you loosen the screws. Remove the music rest, and then securely retighten the screws.

#### NOTE

Don't apply excessive force to the installed music rest.

#### NOTE

You must use the included screws to attach the music rest.

## Connecting the Pedals

Connect the included pedal to one of the Pedal jacks. The operation of the pedal will differ depending on the jack to which it's connected.

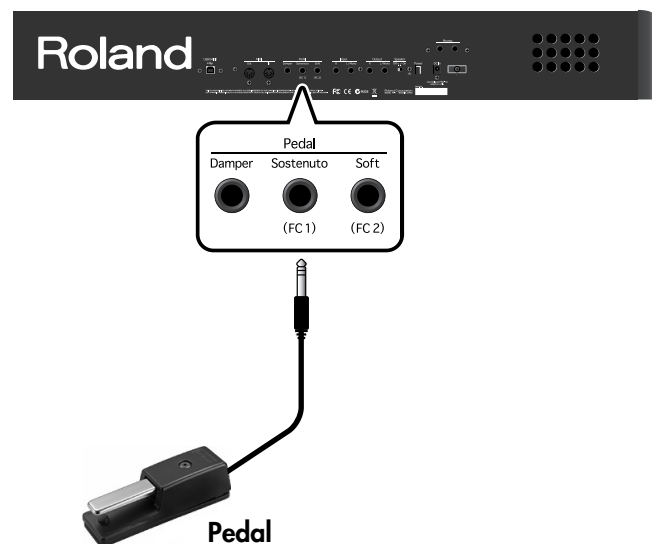

Connected jack	Operation
<b>Damper jack</b>	The pedal will operate as a damper pedal.
<b>Sostenuto / (FC1) jack</b>	The pedal will operate as a sostenuto pedal. Alternatively, you can assign a different function (p. 64, p. 82).
<b>Soft / (FC2) jack</b>	The pedal will operate as a soft pedal. Alternatively, you can assign a different function (p. 64, p. 82).

**NOTE** Unplugging a pedal cord from the unit while the power is on may cause the pedal's effect to be applied without stopping. The power of the FP-4 must be turned off before inserting or removing a pedal cord.

**MEMO** By obtaining a second and third pedal, you can then use three pedals simultaneously. If you wish to purchase the optional pedal (DP series), please contact the dealer where you purchased the FP-4.

**NOTE** You can connect an expression pedal to the Sostenuto (FC 1) jack or Soft (FC 2) jack and use it to adjust the FP-4's volume.

Use only the specified expression pedal (EV-5; sold separately). By connecting any other expression pedals, you risk causing malfunction and/or damage to the unit.

### Damper Pedal

Use this pedal to sustain the sound.

While this pedal is held down, notes will be sustained for an extended time even if you release your fingers from the keyboard.

The pedal included with the FP-4 functions as a half-damper pedal, which allows you to adjust the amount of resonance.

On an acoustic piano, holding down the damper pedal will cause the strings for notes other than the ones you actually play to vibrate in sympathy with what you've played, producing a rich resonance. The FP-4 simulates this sympathetic vibration (damper resonance).

**MEMO** Set the switch on the included pedal to "Continuous" when the pedal is connected.

### Sostenuto Pedal

The notes you are pressing when this pedal is depressed will be sustained.

**MEMO** With the pedal connected to the Sostenuto / (FC1) jack, it can be assigned other functions as well. Refer to "Changing How the Pedals Work" (p. 82), "Using a Pedal to Switch Registrations" (p. 64).

### Soft Pedal

This pedal is used to make the sound softer.

Playing with the soft pedal depressed produces a sound that is not as strong as when otherwise played with the equivalent strength. This is the same function as the left pedal of an acoustic piano.

The softness of the tone can be varied subtly by the depth to which you press the pedal.

**MEMO** With the pedal connected to the Soft / (FC2) jack, it can be assigned other functions as well. Refer to "Changing How the Pedals Work" (p. 82), "Using a Pedal to Switch Registrations" (p. 64).

## Listening through Headphones

You can use headphones to enjoy the FP-4 without disturbing those around you, such as at night. Since the FP-4 has two headphone jacks, two people can also use headphones simultaneously.

If you're using only one set of headphones, you may connect them to either of the two headphone jacks.



### 1. Plug the headphones into the Phones jack.

If headphones are connected, no sound will be output from the FP-4's speakers.

### 2. Use the FP-4's [Volume] knob (p. 17) to adjust the headphone volume.

## Cautions when Using Headphones

- To prevent damage to the cord's internal conductors, avoid rough handling. When using headphones, mainly try to handle either the plug or the headset.
- Your headphones may be damaged if the volume of a device is already turned up when you plug them in. Minimize the volume before you plug in the headphones.
- Excessive input will not only damage your hearing, but may also strain the headphones. Please enjoy music at an appropriate volume.
- Use headphones that have a stereo 1/4" phone plug.









# Listening to Songs

## Listening to Demo Songs

Now, try listening to demo songs.

The FP-4 comes with eight demo songs.

The six Tone buttons, the [Session Partner] button, and the [Play] button are each assigned one demo song.

Button	Indication	Composer/Copyright
Piano		Masaki & Kazuko Hirashita / © 2006 Roland Corporation
E.Piano		Masaki & Kazuko Hirashita / © 2006 Roland Corporation
Organ		Masaki & Kazuko Hirashita / © 2006 Roland Corporation
Strings/Pad		Masaki & Kazuko Hirashita / © 2006 Roland Corporation
Guitar/Bass		Masaki & Kazuko Hirashita / © 2006 Roland Corporation
Voice/GM2		Masaki & Kazuko Hirashita / © 2006 Roland Corporation
Session Partner		© 2006 Roland Corporation
Play		Masaki & Kazuko Hirashita / © 2006 Roland Corporation

**NOTE** All rights reserved. Unauthorized use of this material for purposes other than private, personal enjoyment is a violation of applicable laws.

**NOTE** No MIDI data for the music that is played will be output.

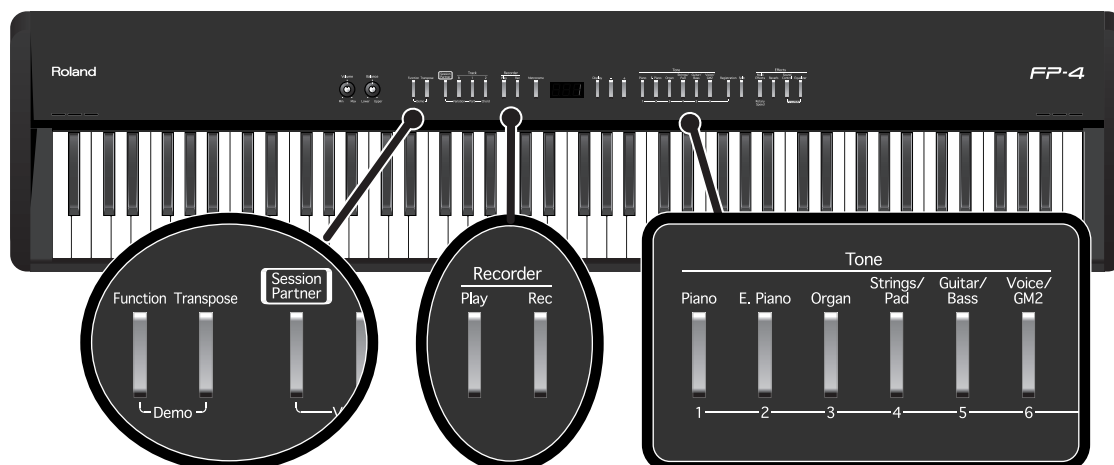



**1. Hold down the [Function] button and press the [Transpose] button.**

The indicators for the six Tone and [Function], [Transpose], [Session Partner] and [Play] buttons flash.

The following appears in the display.



You can't play back the demo songs if your recorded performance has not been saved. Either erase your performance (p. 26), or save your recorded performance (p. 76).

**2. Press one of the six Tone buttons, the [Session Partner] button, or the [Play] button.**

The songs will play consecutively, starting with the demo song you selected. The button for the song currently being played back flashes on and off.

When playback of the last song is reached, playback continues by returning to the first song and playing that again.

The display will show the name of the currently playing demo song.

**3. To stop playback, press the flashing button.****4. Press the [Function] button or the [Transpose] button to exit Demo mode.**

The indicators return to their previous state.



A demo song will not play if you press an unlit button.

## Listening to Internal Songs

The FP-4 contains 65 built-in songs. Here's how to select and play back one of these songs.

**MEMO** About the name of the internal song, refer to "Internal Song List" (p. 124).

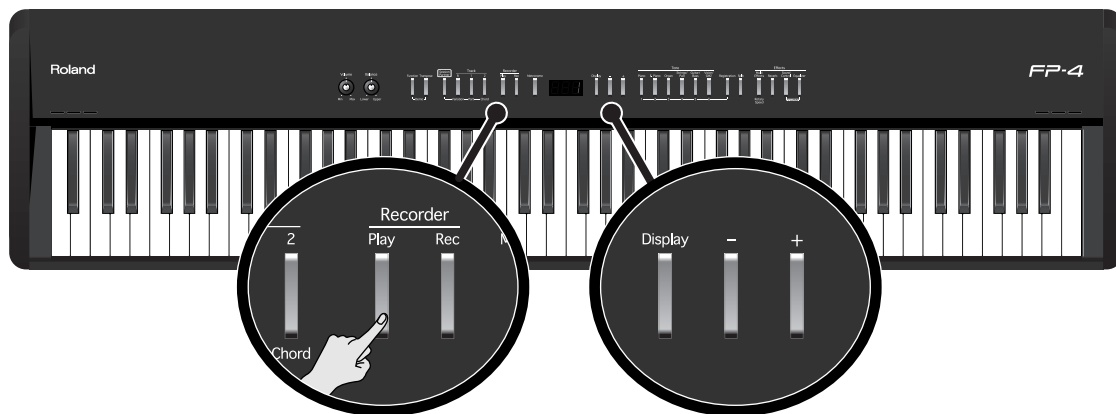

### Selecting a Song

1. Press the [Display] button several times so it's lit in green.

The following appears in the display.



Each time you press the [Display] button, the display will alternate between showing the currently selected tone number, the currently selected song number (a "U" or "P" is shown before the number), the currently selected rhythm number (an "r" is shown before the number), and tempo. If you press the [Display] button while using Session Partner, the rhythm number, tempo, and tone number will be alternately shown.

Button	Display
Unlit	Tone Number
Green	Song Number
Red	Rhythm Number
Orange	Tempo

2. Press the [-] or [+] button to select the song.

The character "P" is shown before internal (preset) song numbers.



## Playing the Song

### 3. Press the [Play] button.

The selected song will play.

The selected song is played to the end, and then playback stops.

**MEMO** If a song is playing while the song select screen is displayed, you can rewind the song by holding down the [-] button, or fast-forward the song by holding down the [+] button. The display will indicate the measure number during fast-forward or rewind.

To stop playback, press the [Play] button once more.

The next time you press the [Play] button, playback will resume from the point at which you stopped.

If playback has stopped at the end of the song, playback will start from the beginning of the song. If the song select screen is displayed, pressing the [-] button will return you to the beginning of the song. Pressing the [-] button once again will return you to the preceding song.

#### About the Song Select Display

The song select display will change as follows.



By holding down the [Display] button and pressing the [-] [+] buttons, you can quickly select the first song in the song group (i.e., "first song in internal memory," or "first built-in preset song").

**NOTE** "U.\*\*" will not appear if there is no song in internal memory.

## Changing the Volume of the Song

Here's how to adjust the volume when song is playing back.

### 1. While holding down the [Play] button, press the [-] or [+] button.



The song volume can be set to any value from 0 to 127.

**MEMO** While you hold down the [Play] button, the display will show the volume of the song.

**NOTE** You can not change the volume of the demo song.

**MEMO** You can also adjust the volume of the song by turning the [Balance] knob while you hold down the [Play] button.

## Playing Back All Songs Continuously (All Song Play)

The internal songs and the songs in internal memory can be played repeatedly in succession. This function is called "All Song Play."

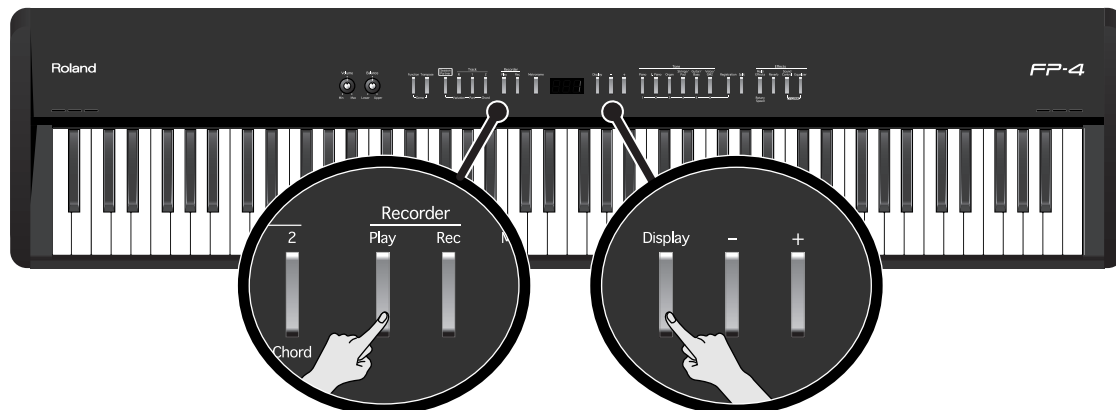

### Specifying the First Song

1. Press the [Display] button several times so it's lit in green.
2. Press the [-] or [+] button to select the song.

### Playing Back the Songs Successively

3. While holding down the [Display] button, press the [Play] button.

The [Play] button will blink.



The songs will play back successively, starting with the selected song.

When the last song finishes playing, the instrument will return to the first song and playback will continue. If you selected an internal song, it will return to internal song number 1. If you selected an internal memory song, it will return to internal memory number 1.

### To Stop Playback

4. Press the [Play] button so its illumination is turned off.

All Song Play is exited when the performance is stopped.

The next time you press the [Play] button, playback will resume from the point at which you stopped.

## Listening to Each Part Separately (Track Mute)

With the internal songs, you can select the performance part that is to be played back. You can also practice each hand separately while playing along with the song.

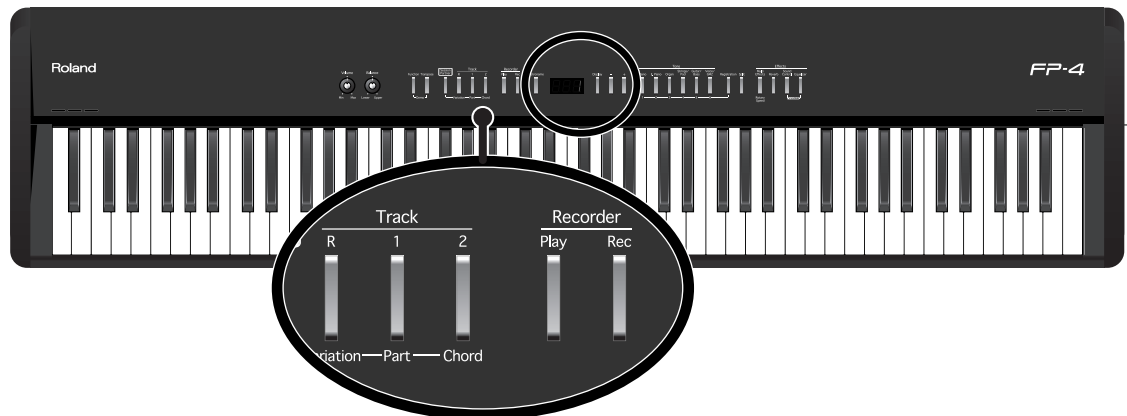

The performance data is assigned to the Track buttons as shown below.

In the internal songs, the left-hand performance is assigned to the Track [1] button and the right-hand performance is assigned to the Track [2] button. Other performance is assigned to the Track [R] button. "Tracks" are areas in which music data is held, and buttons [1], [2], and [R] are referred to as the "track buttons."

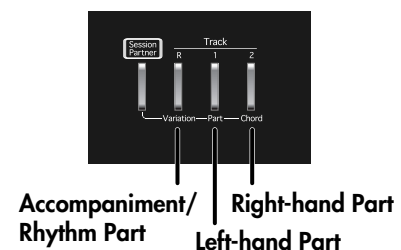

1. Select the song that you want to play (p. 22, p. 27).
2. Press the [Play] button to play the song.
3. Select the part that you don't want to play back.

Press the Track [1] button, the Track [2] button, or the [R] button.

The button you pressed will go out, and the corresponding part will no longer be heard.

Temporarily silencing a specific part in this way is called "muting."



For example, if you want to practice the right-hand part, press the Track [2] button so its illumination is turned off. When you play back the song, the right-hand part will not play.

If you again press the button you selected in step 3, so the button is lit, the sound of that part will be heard.

Even while the song is stopped, you can press the track buttons to mute or un-mute the sound.

4. Press the [Play] button to stop playback.



Mute settings will be cleared when you switch songs.

**NOTE** Internal songs 6–65 do not contain a performance in the rhythm/accompaniment part (Track [R] button). If you press a track button that does not contain a performance, it will not light.

### When the following appears in the display

If there is the performance you recorded but have not yet saved, the following display will appear if you attempt to select a song.



You cannot play back an internal preset song if memory contains an unsaved song. If you want to delete your performance and play back the internal preset song, press the [Rec] button. If you don't want to delete your performance, press the [Play] button. If you want to save your recorded performance, refer to "Saving the Songs You Record" (p. 76).

## Determining the Volume of a Muted Track

Here's how to adjust the volume that a part will have after you've pressed a track button to mute the playback while playing back a song.

The FP-4 lets you play back a specific part at a reduced volume so you can use that part as a "guide" for your own playing.

- 1. Select the song that you want to play (p. 22, p. 27).**
- 2. Hold down a track button and use the [-] [+] buttons to specify the volume that the track will have when its playback is muted.**

The volume for when the playback is muted will be shown while you hold down the track button.



The track mute volume can be set to any value from 0 to 80.

**NOTE** When you turn off the power, the track mute volume setting will return to "0."

**MEMO** You can also adjust the track mute volume by turning the [Balance] knob while you hold down the track button.

## Listening to Songs Saved in Internal Memory

Here's how to play back songs that you've saved in internal memory.

**MEMO** You can save the internal (built-in) songs and the songs (user songs) you've recorded to internal memory. For details, refer to "Saving the Songs You Record" (p. 76).

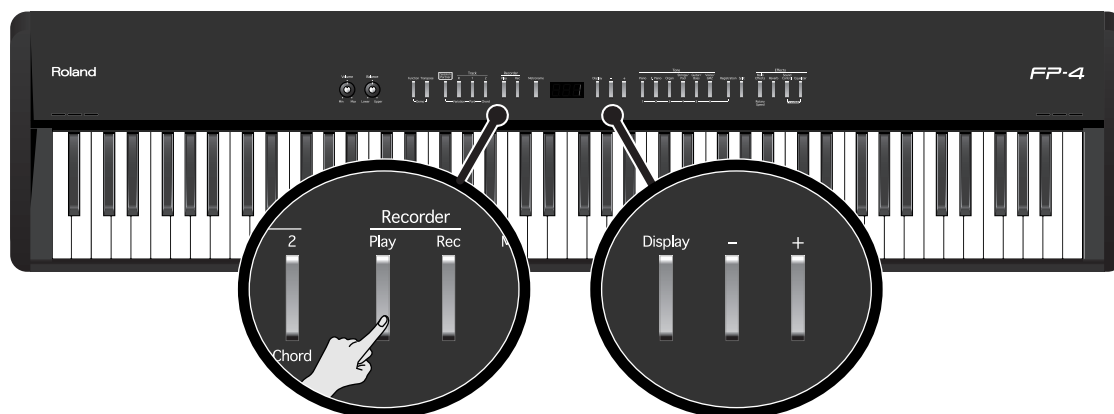

### Selecting a Song

1. Press the [Display] button several times so it's lit in green.
2. Press the [-] or [+] button to select the song.

If a song you've saved in internal memory is selected, the display will indicate "U.\*\*" (user).



**NOTE** If you have not saved any songs in internal memory, the "U.\*\*" indication will not appear.

### Playing the Song

3. Press the [Play] button.

The selected song will play.

The selected song is played to the end, and then playback stops.

To stop playback, press the [Play] button once more. The next time you press the [Play] button, playback will resume from the point at which you stopped.

If playback has stopped at the end of the song, playback will start from the beginning of the song.

If the song select screen is displayed, pressing the [-] button will return you to the beginning of the song. Pressing the [-] button once again will return you to the preceding song.

**MEMO** If a song is playing while the song select screen is displayed, you can rewind the song by holding down the [-] button, or fast-forward the song by holding down the [+] button. The display will indicate the measure number during fast-forward or rewind.

## Performing with a Variety of Sounds

The FP-4 features over 300 different internal sounds, allowing you to enjoy performing with sounds suitable for many different types of music.

These onboard sounds are called “Tones.” The Tones are divided into six different groups, each of which is assigned to a different Tone button.

The Tone “Grand Piano 1” is selected when the instrument’s power is turned on.

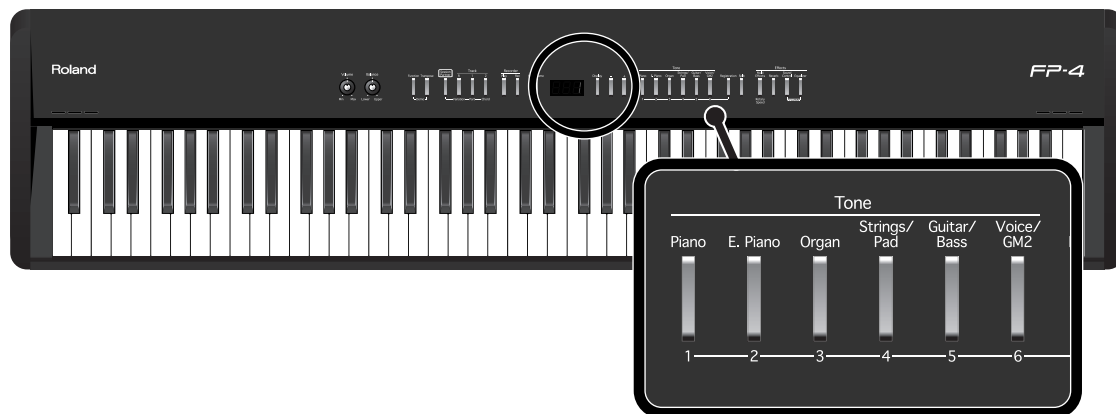

When the [Registration] button is lit, Tone buttons ([1]–[6]) can be pressed to select registrations. If you want to select a tone, press the [Registration] button to turn off its light.

### 1. Press a Tone button to select a tone group.

Try fingering the keyboard. You’ll hear a tone of the selected tone group. The display will indicate the number of the currently selected tone.



### 2. Use the [-] [+] buttons to select a variation tone from the tone group.

The Tone you’ve selected is heard when you finger the keyboard. The next time you select this Tone button, you’ll hear the tone you selected here.



**MEMO** About the Tone name, refer to “Tone List” (p. 111).



## Performing with Two Layered Tones (Dual Play)

You can play two different tones from a single key at the same time. This method of performance is called “Dual Play.”

As an example, let’s try layering piano and strings sounds.

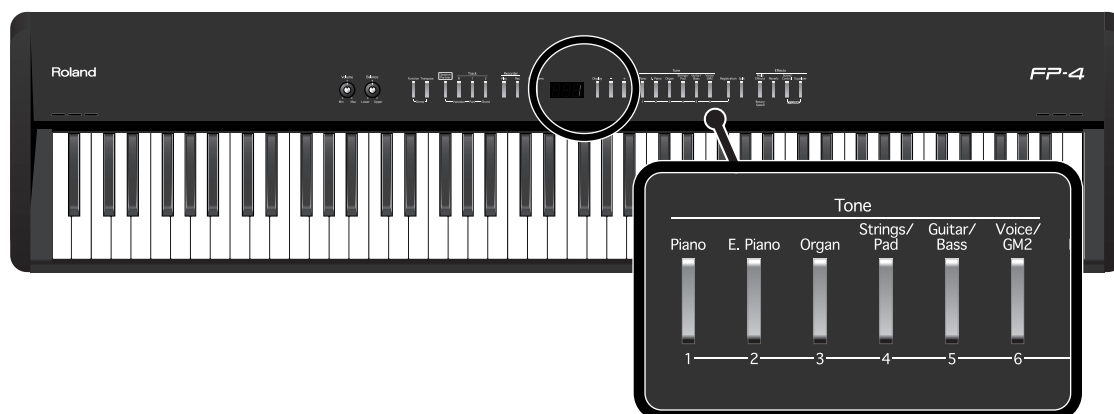

When the [Registration] button is lit, Tone buttons ([1]–[6]) can be pressed to select registrations. If you want to select a tone, press the [Registration] button to turn off its light.

### 1. Hold down the [Piano] button and press the [Strings/Pad] button.

The indicators for both buttons light.

Try fingering the keyboard. Both the piano and strings sounds play.

Pressing two Tone buttons at the same time in this manner activates Dual Play.

Of these two selected tones, the one for the Tone button you pressed first is called the “Upper Tone,” and the one for the Tone button you pressed after that is called the “Lower Tone.”

The display will show the tone number of the upper tone.



Here, the piano tone is the Upper Tone and the strings tone is the Lower Tone.

## Turning Off Dual Play

### 1. Press any one of the Tone buttons.

Now you’ll hear only the tone of the button you pressed.



You can change the pitch of the Lower Tone an octave at a time. Refer to “Changing the Pitch of the Lower Tone in Octave Steps (Octave Shift)” (p. 87).



You can vary the volume-level balance of the two tones. Take a look at “Changing the Volume Balance for Dual Play and Split Play” (p. 34).



You can select the part that will take priority for effects if the Upper tone and Lower tone have different effect settings when you’re using Dual play. Refer to “Setting the Part to Which Effects Are Added” (p. 84).



You can change the part to which the function assigned to the pedal will apply. Refer to “Changing How the Pedal Effects Are Applied” (p. 81).



If you’re using Split play, pressing two Tone buttons won’t switch you to Dual play.

## Changing the Tone Variations

### Changing the Upper Tone

.....

1. Press the [-] or [+] button.

### Changing the Lower Tone

.....

1. Hold down the Tone button for the Lower Tone, and press the [-] or [+] button.

The display will show the tone number of the lower tone.

## Performing with Different Tones in the Left and Right Sides of the Keyboard (Split Play)

Performing with the keyboard divided at a certain key into a left side and a right side is called “Split Play,” and the point at which the keyboard is divided is called the “Split Point.” In Split Play, you can have a different tone sound in the left and right sides.

When the instrument is turned on, the split point is set to “F # 3.” The split point key is included in the left side.

While in Split Play, a sound played in the right side is called an “Upper Tone,” and the sound played in the left side is called a “Lower Tone.”

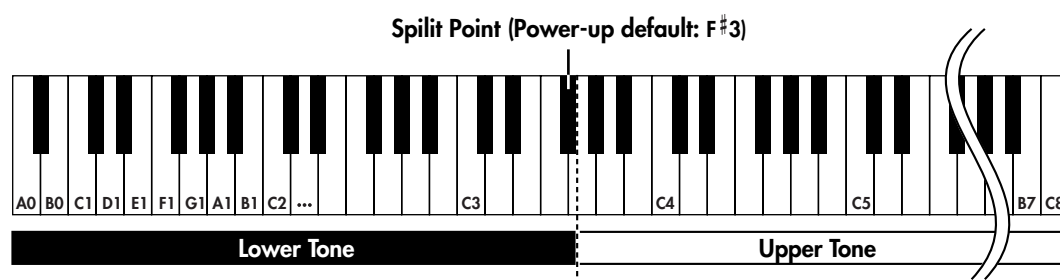

As an example, here’s how to play the tone of the [Piano] button as part of a Split play.

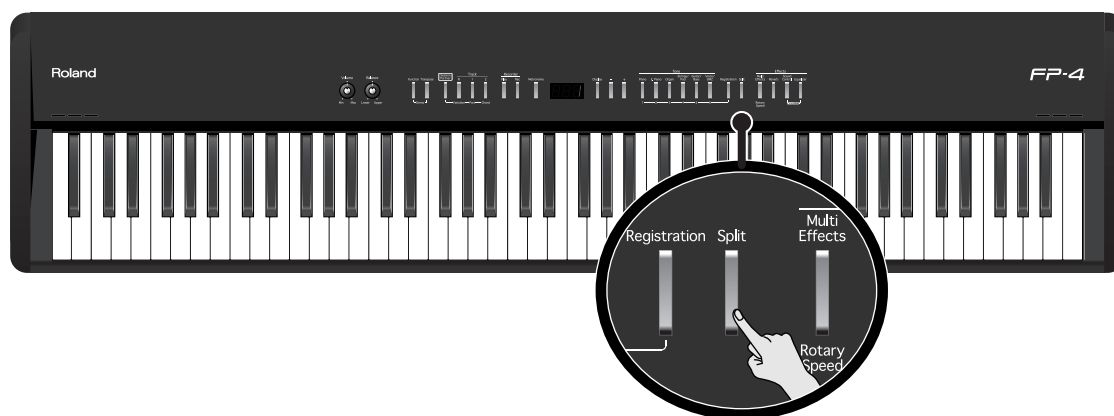

When the [Registration] button is lit, Tone buttons ([1]–[6]) can be pressed to select registrations. If you want to select a tone, press the [Registration] button to turn off its light.

### 1. Press the [Piano] button.

Now, the piano tone is selected.

### 2. Press the [Split] button, getting its indicator to light.

The keyboard will be divided into left and right sides.  
The F # 3 key forms the division between the left and right sides of the keyboard.

The right-hand section of the keyboard plays piano tone, and the left-hand section plays “A. Bass+Cymbal” tone.

You can play a tone for the right side (the Upper Tone) before splitting the keyboard.

## Turning Off Split Play

---

### 1. Press the [Split] button so its illumination is turned off.

The [Split] button's indicator light goes out and the upper tone becomes the tone for the entire keyboard.



You can vary the volume-level balance of the two tones. Take a look at "Changing the Volume Balance for Dual Play and Split Play" (p. 34).



When you switch from Dual Play (p. 29) to Split Play, the Upper Tone used in Dual Play is selected as the Upper Tone for Split Play.



You can specify which part is to have priority when the effects assigned to the Upper Tone and Lower Tone differ. Refer to "Setting the Part to Which Effects Are Added" (p. 84).

## Switching Tone Groups and Tone Variations

### Changing the Upper Tone

---

1. Press the Tone button to choose a tone group.
2. Press the [-] or [+] button to select a variation tone.

### Changing the Lower Tone

---

1. Hold down the [Split] button and press the Tone button to choose a tone group.
2. Hold down the [Split] button and press the [-] or [+] button to select a variation tone.



You can change the pitch of the Lower Tone an octave at a time. Refer to "Changing the Pitch of the Lower Tone in Octave Steps (Octave Shift)" (p. 87).

## Changing the Keyboard's Split Point

You can change the split point (the key at which the keyboard is divided).

The split point can be set to any value from B1 through B6.

This is set to "F# 3" when the instrument is turned on.

This setting remains in effect until you turn off the power.

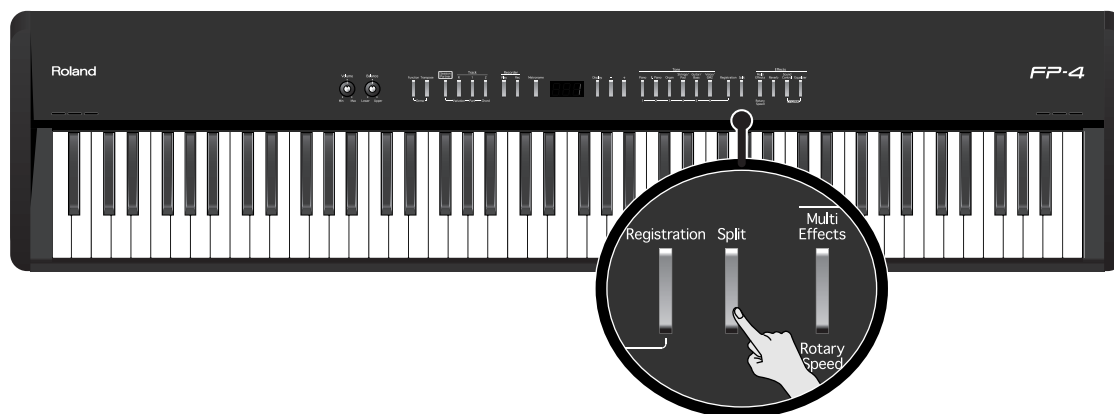
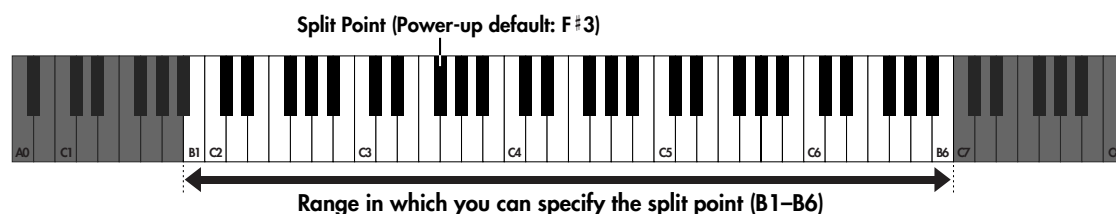

### 1. Hold down the [Split] button and press a key set as the split point.

The key you pressed becomes the split point, and appears in the display.



The key being used as the split point belongs to the left-hand section of the keyboard.

**MEMO** The name of the key acting as the split point is indicated in the display, as shown below.

Display	C	C <sup>♭</sup>	d	E <sub>♭</sub>	E	F	F <sup>♭</sup>	G	A <sub>♭</sub>	A	b <sub>♭</sub>	b
Key	C	C <sup>♯</sup>	D	E <sub>♭</sub>	E	F	F <sup>♯</sup>	G	A <sub>♭</sub>	A	B <sub>♭</sub>	B

**MEMO** The number of the lower tone is displayed while you hold down the [Split] button.

## Changing the Volume Balance for Dual Play and Split Play

You can change the volume balance of the Upper and Lower Tones in Dual Play (p. 29) and Split Play (p. 31).

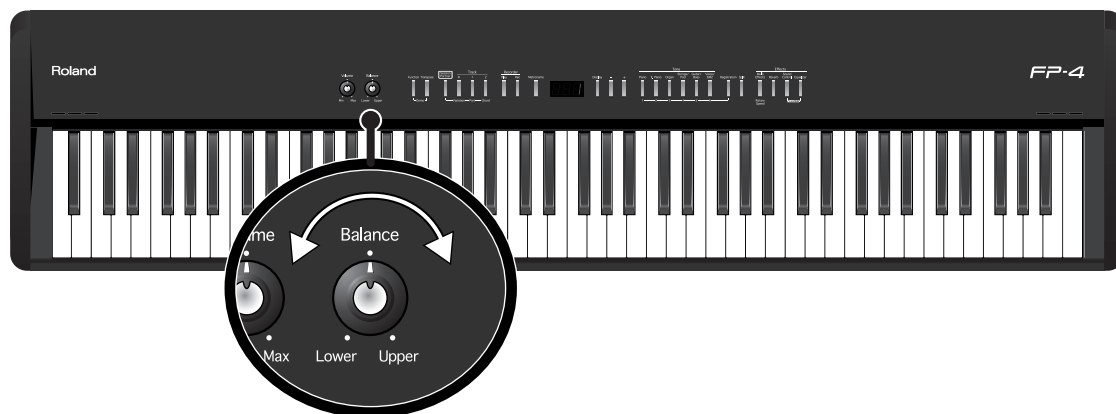

### **1. Use the [Balance] knob to adjust the volume balance.**

Turning the knob toward the left (toward "Lower") increases the volume of the Lower tone.

Turning the knob toward the right (toward "Upper") increases the volume of the Upper tone.

## Adjusting the Keyboard Sensitivity (Key Touch)

You can change the touch sensitivity, or response of the keys. You can adjust the keyboard touch as appropriate for the playing strength of the person who is performing.

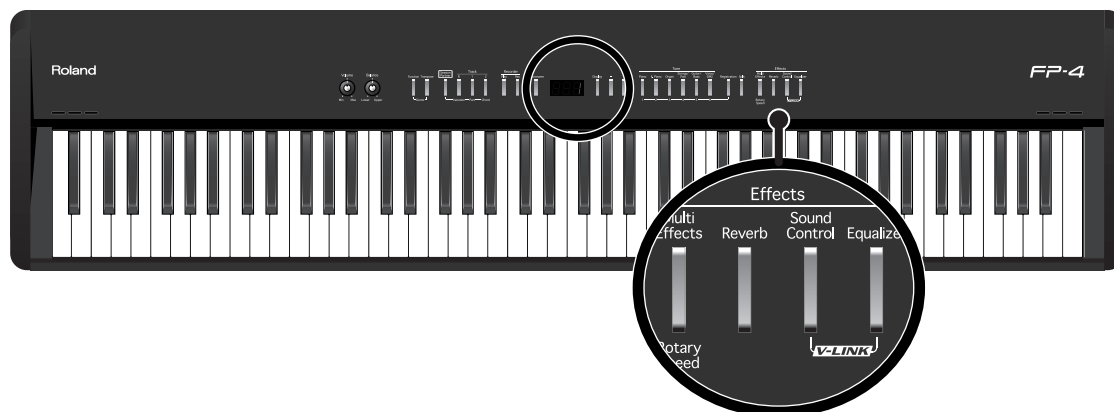

### 1. Hold down the [Reverb] button and press the [Sound Control] button.

The currently selected keyboard touch appears in the display.



### 2. Press the [-] or [+] buttons to select the keyboard touch.

Setting	Description
 (OFF)	The sound plays at one set volume, regardless of the force used to play the keys.
 (Light)	You can achieve fortissimo (ff) play with a less forceful touch than usual, so the keyboard feels lighter. This setting makes it easy to play, even for children.
 (Medium)	This sets the standard keyboard touch. You can play with the most natural touch. This is the closest to the touch of an acoustic piano.
 (Heavy)	You have to finger the keyboard more forcefully than usual in order to play fortissimo (ff), so the keyboard touch feels heavier. Dynamic fingering adds even more feeling to what you play.

### 3. Hold down the [Reverb] button and press the [Sound Control] button.

You can specify the loudness at which each note will sound when the "OFF" keyboard touch is selected. Refer to "Changing the Velocity When the Key Touch is Set to "OFF"" (p. 87).

You can adjust the keyboard touch sensitivity in the Function screen (p. 86).

## Adding Reverberation to Sounds (Reverb Effect)

You can apply a reverb effect to the notes you play on the keyboard. With the reverb effect, you obtain a pleasant reverberation, making it sound as if you were performing in a concert hall or similar space.

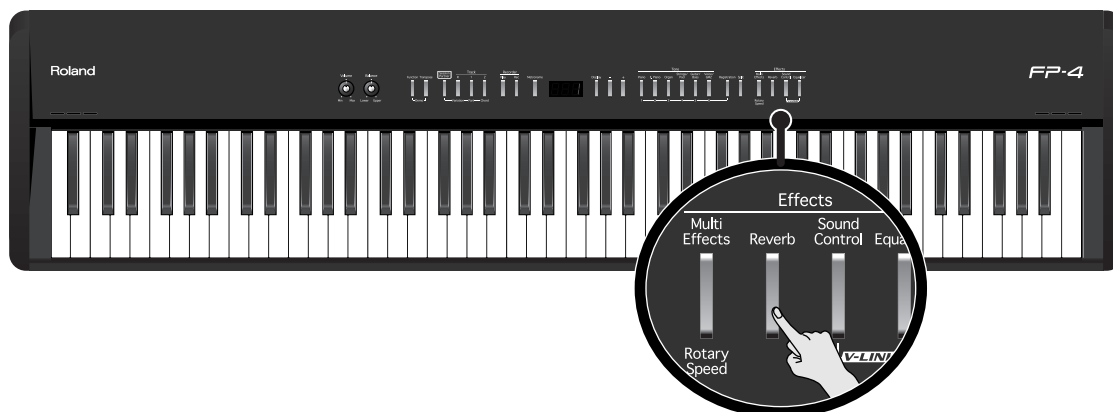

### 1. Press the [Reverb] button so it's lit.

Try fingering the keyboard.  
The reverb effect is applied to the entire tone.

## Turning Off the Reverb Effect

### 1. Press the [Reverb] button so its light is turned off.

## Changing the Depth of Reverb Effect

You can select from ten levels of depth for the reverb effect.

### 1. Hold down the [Reverb] button and press the [-] or [+] button.

The depth for the reverb effect appears in the display.



**NOTE** You cannot make separate reverb effect depth settings for each individual tone. The same depth of reverb effect will apply to all sounds.

**NOTE** You cannot change reverb effect depth of Session Partner, Demo songs, and Internal song.



## Adding a Variety Effects to the Sound (Effects)

In addition to reverb, you can apply a variety of effects to the FP-4's sounds. These are referred to as "effects." With the FP-4, you can select from 62 different effect types. With the factory settings, an effect suitable for each tone is selected.

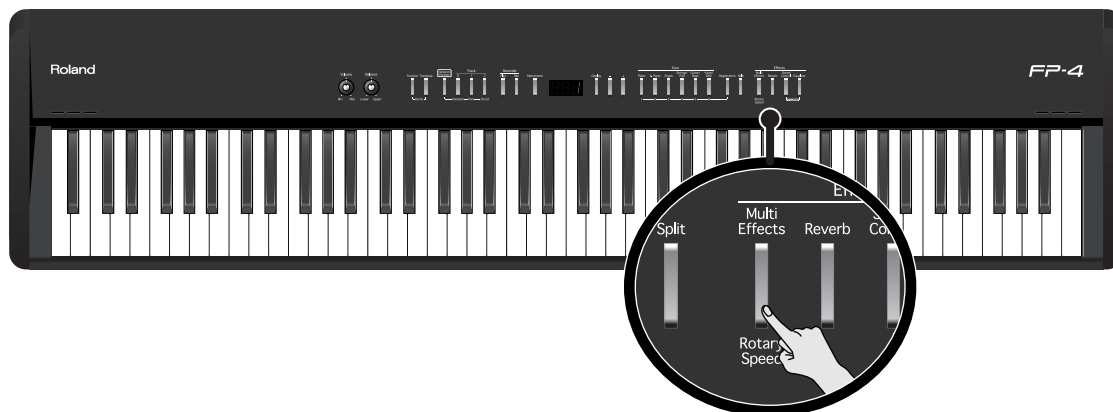

### 1. Press the [Multi Effects] button so it's lit.

Try fingering the keyboard.

The effect is applied to the currently selected tone.



Some tones initially have effect applied. Selecting such a tone makes the [Multi Effects] button light up automatically.



You can change the effect type. Refer to "Changing the Effect Type" (p. 83).

## Editing the Effect Settings in Detail

You can make detailed changes for each effect, such as adjusting the effect depth.

### 1. Hold down the [Multi Effects] button and use the [-] [+] buttons to edit the setting.

The value of the effect setting applied to the currently selected sound is displayed.

## Turning Off the Effects

### 1. Press the [Multi Effects] button so its light is turned off.



You can specify which part is to have priority when the effects assigned to the Upper Tone and the Lower Tone differ. Refer to "Setting the Part to Which Effects Are Added" (p. 84).

## Adding a Spinning Sound to Organ Tones (Rotary Effect)

The Rotary effect is applied to some Organ tones you can select with the [Organ] button. When one of these tones is selected, you can use the [Multi Effects] button to change the speed of the rotary effect.

### What's the Rotary Effect?

What the rotary effect does is to add a "spinning" effect similar to the sound of an organ using a rotating speaker.

In most rotary speakers, the high-frequency speaker and low-frequency speaker rotate at different speeds. The FP-4 can simulate this complex type of modulation.

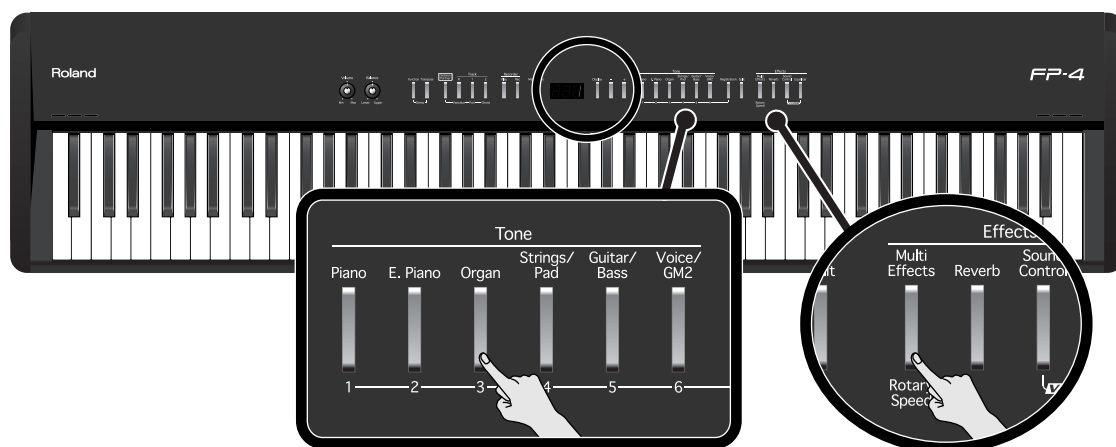

### 1. Press the [Organ] button and select the organ tone.

When a tone that has the Rotary effect added is selected, the [Multi Effects] button flashes or blinks.

### 2. Each time pressing the [Multi Effects] button, switch the speed of the rotary effect between rapid and slow rotation.

Pressing the [Multi Effects] button toggles the rotary effect between fast and slow rotation. If the [Multi Effects] button is blinking rapidly, the rotary effect is being applied with the fast rotational speed. If the [Multi Effects] button is blinking slowly, the rotary effect is being applied with the slow rotational speed.

**NOTE** If you don't want the rotary effect to be applied, select an effect type other than the rotary effect (p. 83), then turn off the effect (p. 37).

## Transposing the Key of the Keyboard (Key Transpose)

You can transpose the key of a performance without having to shift the position of your fingers on the keyboard. This feature is called “Key Transpose.”

This lets you take a song in a difficult key with lots of sharps (#) and flats (b) and play it in a key with fingering that’s easier for you. This is handy when playing accompaniment to a song, to match what you play to the pitch of the singer’s voice.

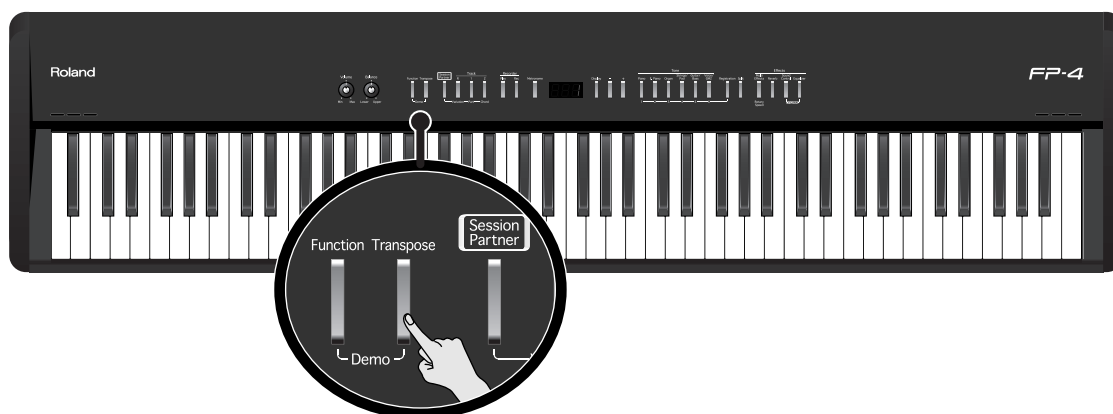

1. Hold down the [Transpose] button and press the key corresponding to the tonic of the desired key.

The Key Transpose settings value continues to appear in the display while the [Transpose] button is held down.



**MEMO** With the [Transpose] button held down, you can change the value, even by pressing the [-] or [+] button.

The available range is -6–0–5. If the Key Transpose value is not “0,” you can use the [Transpose] button to turn the Key Transpose function on/off.

When you release the [Transpose] button, you return to the previous screen.

**MEMO** By holding down the [Transpose] button and pressing both the [-] and [+] buttons simultaneously, the setting returns to its original value (0).

### Example: Playing a Song in the Key of E Major After Transposition to C Major

Hold down the [Transpose] button and press the E key (since E is the tonic).

Counting from C as a reference point, one moves up four keys, including the black keys, to reach E, thus “4” appears in the display.

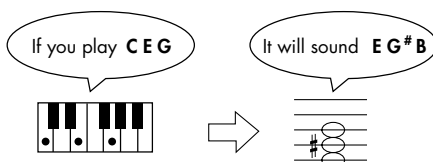

## Performing with the Metronome

You can perform while the metronome sounds.

The FP-4 provides a versatile Metronome function. You can also change the volume and time signature of the metronome.

If a song is playing, the metronome will sound at the tempo and time signature of that song. If a rhythm is playing, the metronome will sound at the tempo and time signature of that rhythm.

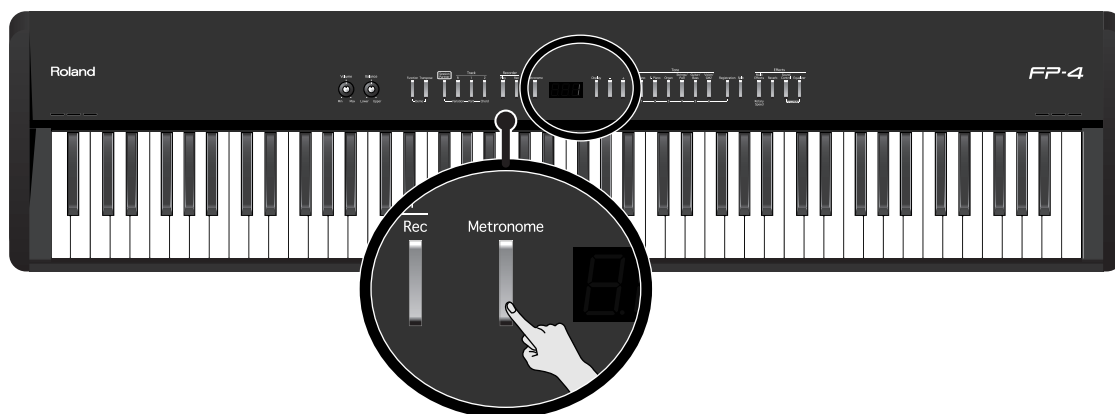

### 1. Press the [Metronome] button so it's lit.

The [Metronome] button flashes in red and green in time with the beat selected at that time. The indicator lights in red on the downbeats, and in green on weak beats.

## Stopping the Metronome Function

### 1. Press the [Metronome] button so its light is turned off.



You can change the beat of metronome. Please refer to the "Changing the Beat of Metronome" (p. 91).

## Changing the Tempo

### 1. Press the [Display] button several times so it's lit in orange.

The tempo is displayed.



### 2. Press the [-] or [+] button to adjust the tempo.

The tempo is set in terms of the value of a quarter note, with possible values ranging from 10 up to 500.

Each time you press the [Display] button, the display will alternate between showing the currently selected tone number, the currently selected song number (a "U" or "P" is shown before the number), the currently selected rhythm number (an "r" is shown before the number), and tempo. If you press the [Display] button while using Session Partner, the rhythm number, tempo, and tone number will be alternately shown.

Button	Display
Unlit	Tone Number
Green	Song Number
Red	Rhythm Number
Orange	Tempo

## Changing the Volume

The volume of the metronome can be adjusted, with ten volume levels available. This is set to "5" when the instrument is turned on.

### 1. While holding down the [Metronome] button, press the [-] or [+] button to adjust the volume.

The display will indicate the metronome volume.



**NOTE** When the metronome volume is set to "0," the metronome sound does not play.



You can also adjust the volume of the metronome by turning the [Balance] knob while you hold down the [Metronome] button.

## Adding Liveliness to the Sound (Sound Control)

You can add liveliness to the sound to give it superb clarity and distinctness.

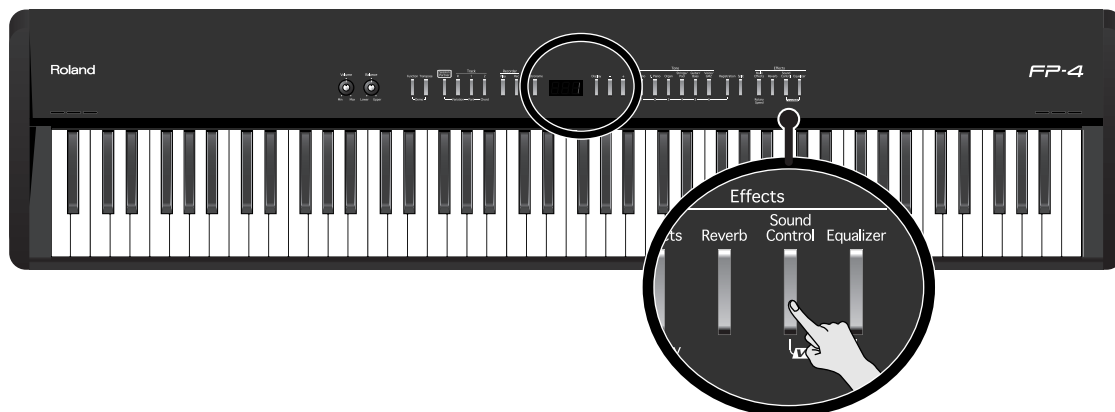

1. Press the [Sound Control] button so it's lit.  
The Sound Control function is switched on, enlivening the sound.
2. While holding down the [Sound Control] button, press the [-] or [+] button to change the type.



Setting	Type	Description
1	Sharp	Creates a sound with boosted bass and treble.
2	Clear	Produces a sound with chords in the low registers that are clear and distinct.
3	Power	Creates a sound with boosted bass.

### Turning Off Sound Control

1. Press the [Sound Control] button so its light is turned off.



You can have the FP-4 remember whether the [Sound Control] button should be on or off when you turn on the power (p. 84).



For some sounds, this may cause distortion. If the sound distorts, refer to "Adjusting the Volume (Master Gain)" (p. 85).



The Sound Control function is not applied to the sounds of external devices connected to the Input jacks.

## Changing the Tonal Quality (Equalizer)

You can use the equalizer to adjust the tonal quality.

This allows you to adjust the tonal character by boosting or decreasing the low-frequency or high-frequency portions.

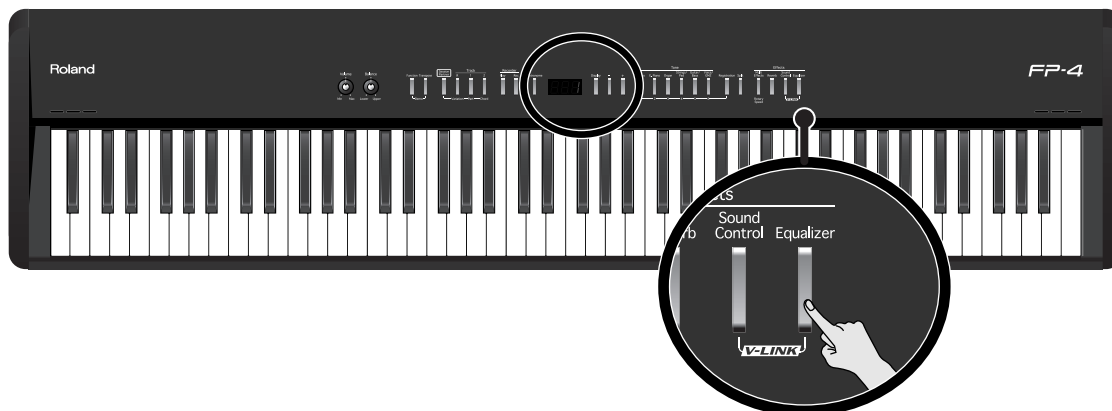

### 1. Press the [Equalizer] button so it's lit.

The equalizer will be turned on, and the tonal character will change.

## Turning Off the Equalizer

### 1. Press the [Equalizer] button so its light is turned off.

## Changing the Equalizer Type

You can switch the equalizer settings to apply different changes to the tonal character. The FP-4 provides four equalizer settings.

### 1. While holding down the [Equalizer] button, press the [-] or [+] button to select the equalizer type.



Setting	Description
1	The high frequencies will be boosted, producing a bright, sparkling sound.
2	The high frequencies will be restrained, producing a more mellow sound.
3	The low-mid frequencies will be boosted, producing a powerful sound.
4	This setting is suitable for piano solos.



You can make more exacting changes to the equalizer settings. Please refer to the "Changing the Equalizer Settings" (p. 85).

# Playing Along with Rhythms

## What is Session Partner?

### “Session Partner” Lets You Enjoy Playing with a Session-Like Feel

“Session Partner” is an easy-to-use function that plays accompaniment in a variety of musical styles. Playing along with this accompaniment, with its realistic sounds, gives you the feel that you are playing live with a band backing you.

For example, playing with “Session Partner” instead of using the metronome always lets you practice the piano with something different.

You can also change the accompaniment as you like to suit whatever you are playing. By changing the chords and Rhythms, even while playing the same melody, you can easily create all kinds of new arrangements.

We encourage you to enjoy the variety of performance options open to you by using the “Session Partner” feature.

### What You Can Do with “Session Partner”

“Session Partner” lets you mainly do the following things.

- Play piano with a session-like feel along with Rhythms while the chord progression continues automatically (p. 45).
- Play the piano to provide your own accompaniment as you specify chords with the left hand (the left part of the keyboard) (p. 51).
- Enjoy freer piano performances using your own original chord progressions (p. 54).

“Session Partner” lets you add accompaniment with the “rhythms” and performance parts you select.

You can play intros, endings, and fill-ins (short phrases inserted at transition points in the song) by pressing buttons as you play the keyboard.

### What are the FP-4’s “Rhythms?”

The FP-4 features internal “Rhythms” complementing Pops, Jazz, and other various musical genres.

“Rhythms,” or combinations of elements from a musical genre that recreate the mood or signature sound of a particular style, form the foundation of the accompaniment used in “Session Partner.”

A “Rhythm” is composed from the following three items.

**Drums Part**

**Bass Part**

**Accompaniment Part (except drum and bass part)**



## Performing Along with Session Partner

Now, let's try performing along with Session Partner.

Since a wide variety of musical genres is provided, be sure to use a Rhythm that best suits the song you are performing.

**MEMO** Please refer to "Selecting a Rhythm" (p. 48).

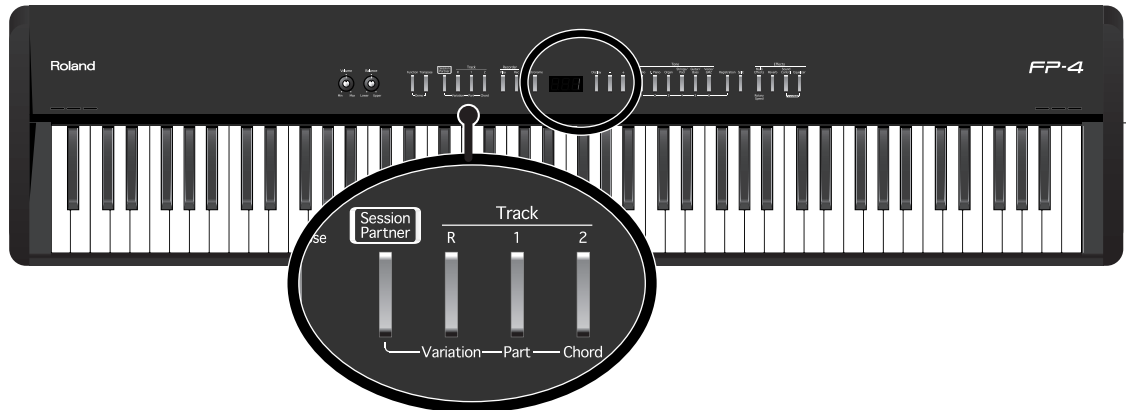

### 1. Press the [Session Partner] button.

The [Session Partner] button will light, and the performance will begin from the intro.

During the intro, the Track [R] button will blink.

The chord is shown in the display.

The chord progression advances automatically, freeing you up to play the melody.



The chord name will blink slightly before the chord changes.

**NOTE** When you press the [Session Partner] button to make the Session Partner play, the chords will be shown as the chord progression continues, so the setting that had been shown until then will no longer be visible.

You can set the Chord display on or off. Refer to "Setting the Chord Display On or Off" (p. 90).

## Stopping the Session Partner Performance

---

### 1. Press the [Session Partner] button.

When you press the [Session Partner] button, an ending will be played and then Session Partner will stop.

The Track [R] button will blink while the ending is playing. When Session Partner stops, the [Session Partner] button and Track button will go out.

If you press the [Session Partner] button once again during the intro or ending, the performance will stop immediately.

You can change the rhythm that will sound.

→ "Rhythm List" (p. 116)

You can set the Chord display on or off.

→ "Setting the Chord Display On or Off" (p. 90)

You can also specify the chords to be played in a Rhythm.

→ "Performing with the Chord Progression Specified in the Left Hand (Chord Progression Off)" (p. 51)

You can change the chord progression patterns.

→ "Selecting a Rhythm's Chord Progression" (p. 50)

You can perform without adding an intro or ending.

→ "Setting the Intro and Ending On or Off" (p. 88)

## Changing the Volume of the Session Partner Performance

Here's how to adjust the volume when Session Partner is playing.

1. While holding down the [Session Partner] button, press the [-] or [+] button.



While you hold down the [Session Partner] button, the display will show the volume of Session Partner.



You can also adjust the volume of the Session Partner by turning the [Balance] knob while you hold down the [Session Partner] button.

## Selecting Parts

You can select the part to be played.

1. Press the [Session Partner] button so Session Partner starts playing.
2. Press the Track [1].

The part or group of parts enabled for performance changes each time you press the Track [1] button, as shown below.

Track [1] button	The parts that will play
Lit in red	Drums, Bass, Accompaniment
Lit in orange	Drums, Bass
Lit in green	Drums

## Stopping the Session Partner Performance

1. Press the [Session Partner] button.

When you press the [Session Partner] button, an ending will be played and then Session Partner will stop.

## Selecting a Rhythm

Now, try changing the Rhythm being performed.  
Let's try changing the rhythm to suit the song you want to play.

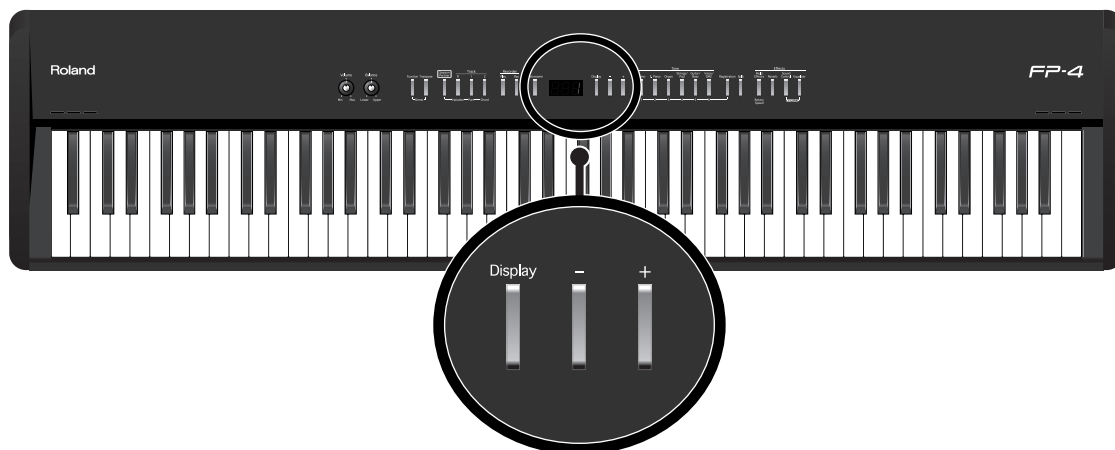

### 1. Press the [Display] button, getting its indicator to light in red.

The Rhythm number is displayed.  
Rhythm numbers are indicated by an "r" before the number.



### 2. Press the [-] or [+] button to select the Rhythm.

**MEMO** For more information on the different Rhythm type, refer to "Rhythm List" (p. 116).

## Changing Rhythms As You Perform

If you change Rhythms while a Rhythm is being played, the selected Rhythm begins after the fill-in is played.

### What's a "Fill In"?

A short improvisational phrase inserted at the bar line is called a "Fill In."  
The phrase best suited to the selected Rhythm is played.

**MEMO** The Track [R] button will blink while the fill-in is playing.

## Changing a Rhythm's Tempo

The FP-4 has an optimal tempo for each Rhythm.  
You can change the tempo of the selected Rhythm.

**MEMO** Furthermore, you can change the tempo as the Rhythm is being played.

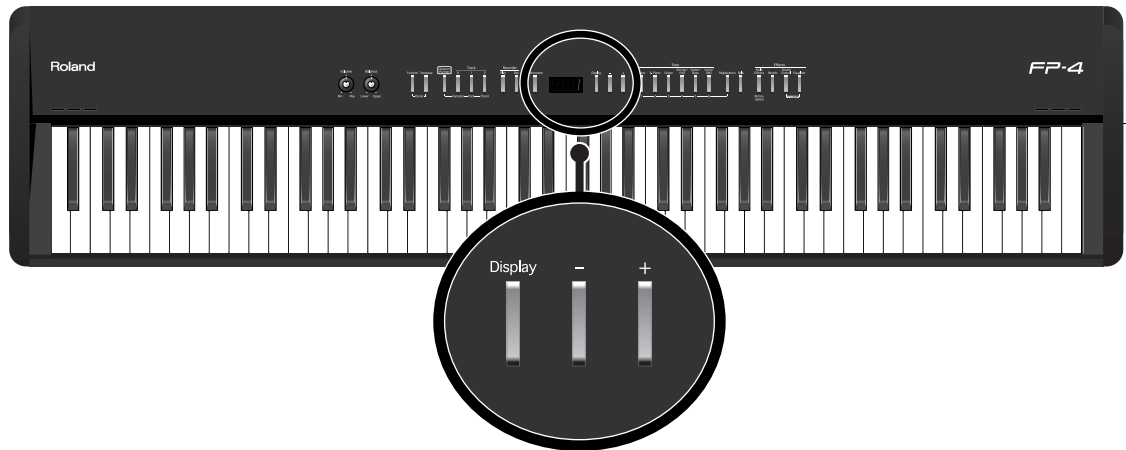

### 1. Press the [Display] button, getting its indicator to light in orange.

The tempo is displayed.



### 2. Press the [-] or [+] buttons to adjust the tempo.

The tempo is set in terms of the value of a quarter note, with possible values ranging from 10 up to 500.

When the [Session Partner] button is pressed, the Rhythm is played at the selected tempo.

**NOTE**

If you change the Rhythm during Session Partner play, the tempo won't change. At such times, you can set it to the optimal tempo by getting the tempo to appear in the display, then pressing the [-] and [+] buttons at the same time.

## Selecting a Rhythm's Chord Progression

The FP-4 has an optimal chord progression pattern for each Rhythm. You can change the chord progression pattern if you want.



For more information on chord progression patterns, refer to the "Chord Progression Pattern List" (p. 117).

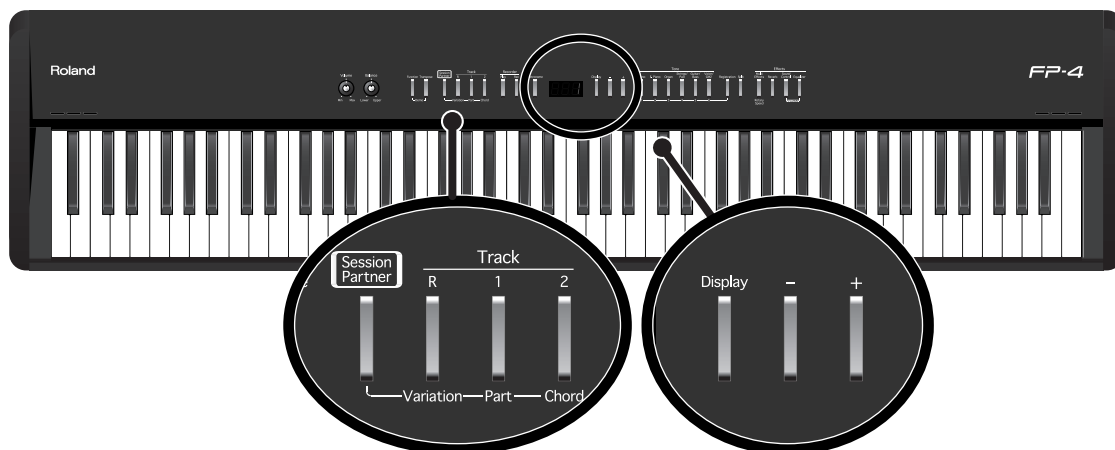

1. Press the [Session Partner] button so Session Partner starts playing.
2. Hold down the Track [2] button and press the [-] or [+] button to change the chord progression pattern.

The pattern number of the currently selected chord progression will be displayed while you hold down the Track [2] button.



If you change the chord progression pattern during the performance, a fill-in will be played, and then the performance will begin using the selected chord progression.

## Stopping the Session Partner Performance

1. Press the [Session Partner] button.

When you press the [Session Partner] button, an ending will be played and then Session Partner will stop.



You can change the root note of the chord. Refer to "Selecting the Root Note of the Chord Progression" (p. 89).



Recorded chord progression patterns are saved to "USR." You can select "USR" patterns by pressing the [-] button when pattern number 1 is displayed.

## Performing with the Chord Progression Specified in the Left Hand (Chord Progression Off)

Performing with the keyboard divided at a certain key into a left side and a right side is called "Split Play." While in Split Play, you can use the left side to specify chords instead of using it to play the Lower Tone.

**NOTE** When specifying the chords in the left part of the keyboard, Dual Play (p. 29) is disabled in the right part.

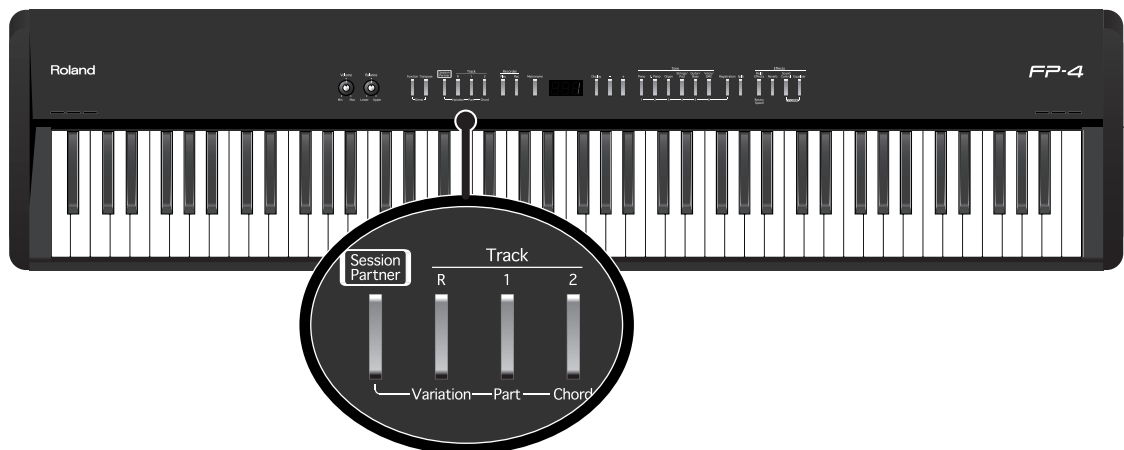

1. Press the [Session Partner] button so Session Partner starts playing.
2. Press the Track [2] button so its light is turned off.  
The [Split] button lights up.  
The left side of the keyboard will no longer produce sound.
3. Use the left side of the keyboard to specify a chord, and play a melody in the right side.

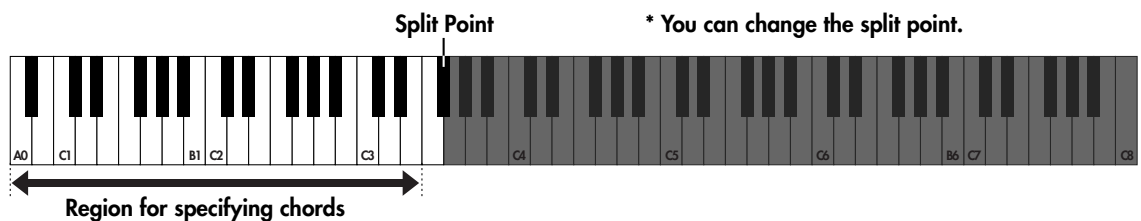

It is not necessary to continue holding down the keys for chords in the left side. Even after you release the key, the same chord continues until the next chord is played.

**MEMO** You can specify chords simply with your finger, even without playing the keys for all the chords' constituent notes. For more information about chord fingering, refer to the "Chord Fingering List" (p. 120).



The point at which the keyboard is divided is called the “split point”; you can also change this split point. For more information, take a look at “Changing the Keyboard’s Split Point” (p. 33).



On the left side of the keyboard, you can specify chords while playing the Lower tone. Press the [Split] button to turn off its light, then press the [Split] button once again so it’s lit. The Lower tone will sound when you play the left side of the keyboard.

### Returning to Automatic Chord Progression Switching

---

#### 4. Press the Track [2] button so it’s lit.

You’ll be returned to the setting for automatic chord progression switching.

### Stopping the Session Partner Performance

---

#### 5. Press the [Session Partner] button.

After the ending, the performance will stop.  
The [Session Partner] button will go out.

You can change the performance settings by using your left hand to specify a chord before Session Partner begins playing.

##### 1. While holding down the [Session Partner] button, press the Track [2] button so the Track [2] button’s illumination is turned off.

The [Split] button will light.

The [Session Partner] button will blink, and the instrument will wait for the performance to begin.

##### 2. Use the left side of the keyboard to specify a chord, and play a melody in the right side.

##### 3. Press the [Session Partner] button to stop the playback.

When you press the [Session Partner] button, an ending will be played and then Session Partner will stop.

The [Session Partner] button will blink, and the instrument will wait for the performance to begin.

To defeat the setting for using your left hand to specify the chords while you play, hold down the [Session Partner] button once again and press the Track [2] button so its indicator is turned on.



## Changing the Rhythm Pattern (Original/Variation)

Each rhythm has two varieties of accompaniment patterns; the original accompaniment pattern, and a slightly more colorful variation of that pattern.

A fill-in (short phrase) will be inserted between changes of the accompaniment pattern, adding contrast to the song.

For example, it is effective to use the quiet Original pattern for the first half of the song, and then switch to the Variation pattern for the second half when you want to build excitement.

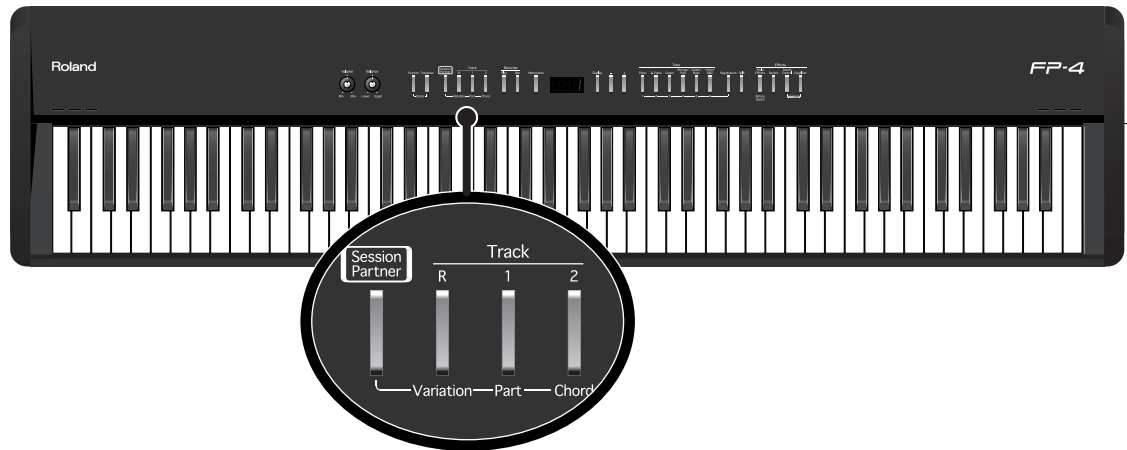

1. Press the [Session Partner] button so Session Partner starts playing.
2. Press the Track [R] button to make it light or go out.

Track [R] button	Description
Unlit	The original accompaniment pattern will play.
Lit	The variation accompaniment pattern will play.

**MEMO** The Track [R] button will blink while the fill-in is playing.

## Stopping the Session Partner Performance

1. Press the [Session Partner] button.

When you press the [Session Partner] button, an ending will be played and then Session Partner will stop.

## Recording the Chord Progression

You can save a chord progression you've specified using the left-hand section of the keyboard.

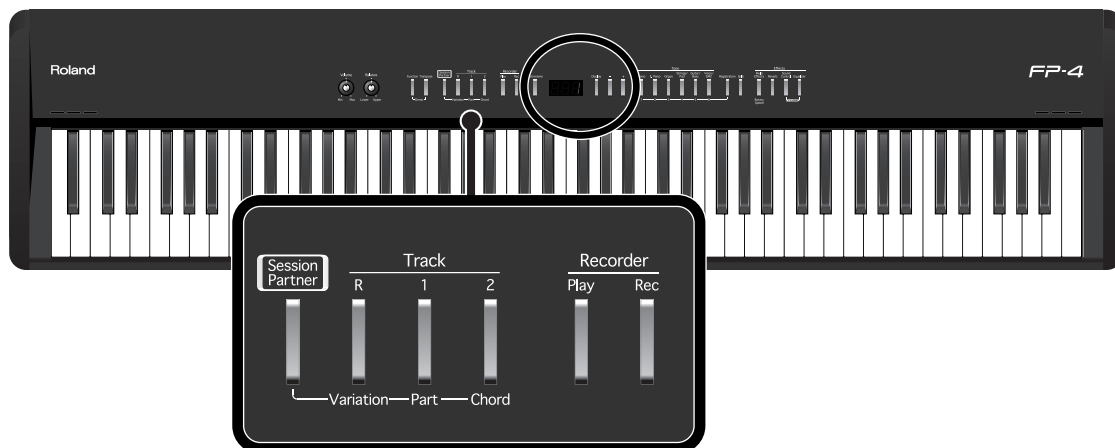

### 1. Hold down the [Session Partner] button and press the [Rec] button.

The [Session Partner] and the [Rec] buttons flash, and the FP-4 is put into recording standby. The "UCP (User Chord Progression)" appears in the display.



**MEMO** Press the [Session Partner] button or the [Rec] button to exit from recording standby.

### 2. Use the left side of the keyboard to specify a chord and begin recording the chord progression.

The display will show the chord you played. The intro will not play at this time. You can store up to sixteen chords.

### 3. Press the [Session Partner] button to stop recording the chord progression.

Recorded chord progression patterns are saved to "USR." You can select "USR" patterns by pressing the [-] button when pattern number 1 is displayed.

**MEMO** You can record a chord progression of up to sixteen measures. However, when the instrument is shipped from the factory, this is set so that eight measures can be recorded. Recording will stop automatically when you reach the specified number of measures. You can store up to sixteen chords. If you want to change the number of measures for which you can record a chord progression, refer to "Changing the Number of Measures of the Chord Progression You Record" (p. 55).

**MEMO** You can make settings so that the chord progression pattern won't change when you change the rhythm. Refer to "Fixing a Set Chord Progression" (p. 89).



The song may not play back correctly if the performance is played with a different beat than the one used in recording the original chord progression.



The recorded chord progression will be discarded as soon as the power is turned off. If you want to keep it, you'll need to save registration (p. 57).

## Changing the Number of Measures of the Chord Progression You Record

When creating your own chord progression pattern, you can specify the number of measures for the chord progression.

When you turn on the power, this is set to eight measures.

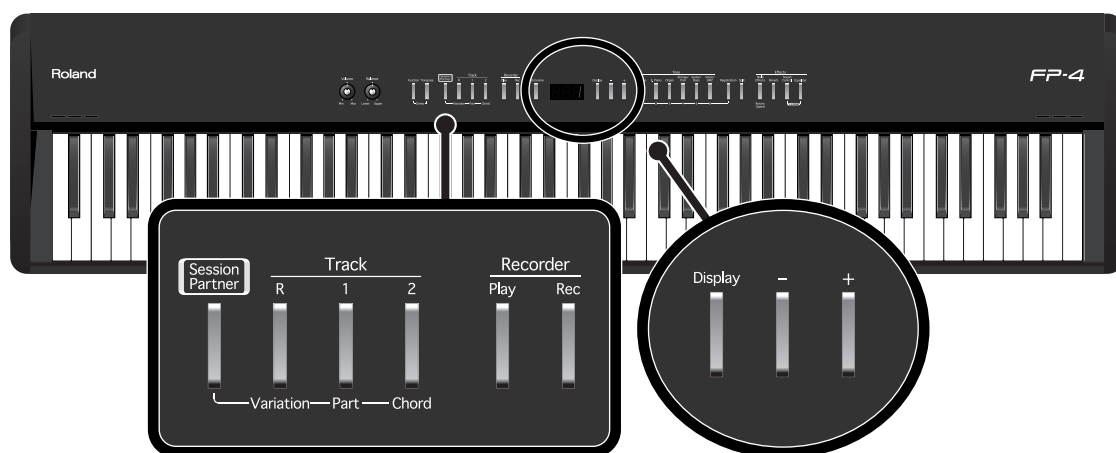

1. Hold down the [Session Partner] button and press the [Rec] button.

The "UCP (User Chord Progression)" appears in the display.



2. Press the [+] button.

The display will show the number of measures for which you will record a chord progression.



3. Use the [-] [+] buttons to select the desired number of measures.

You can choose 4, 8, 12, or 16 measures.

4. Use the left side of the keyboard to specify a chord and begin recording.

Press the [Session Partner] button to stop recording.

# Saving Your Favorite Performance Settings

## About the Performance Settings (Registration)

You can save your favorite combinations of performance settings, including the tone selection, the dual/split play setting, and Session Partner settings as "Registrations." You can use the [Registration] button to store twenty-four sets of your favorite performance settings. These twenty-four registrations are collectively called a "registration set."

The registrations are assigned to the six buttons from [Piano/1] to [Voice/GM2 / 6], with four registrations assigned to each button for a total of twenty-four registrations.

The registration set can be saved in the FP-4's internal memory.

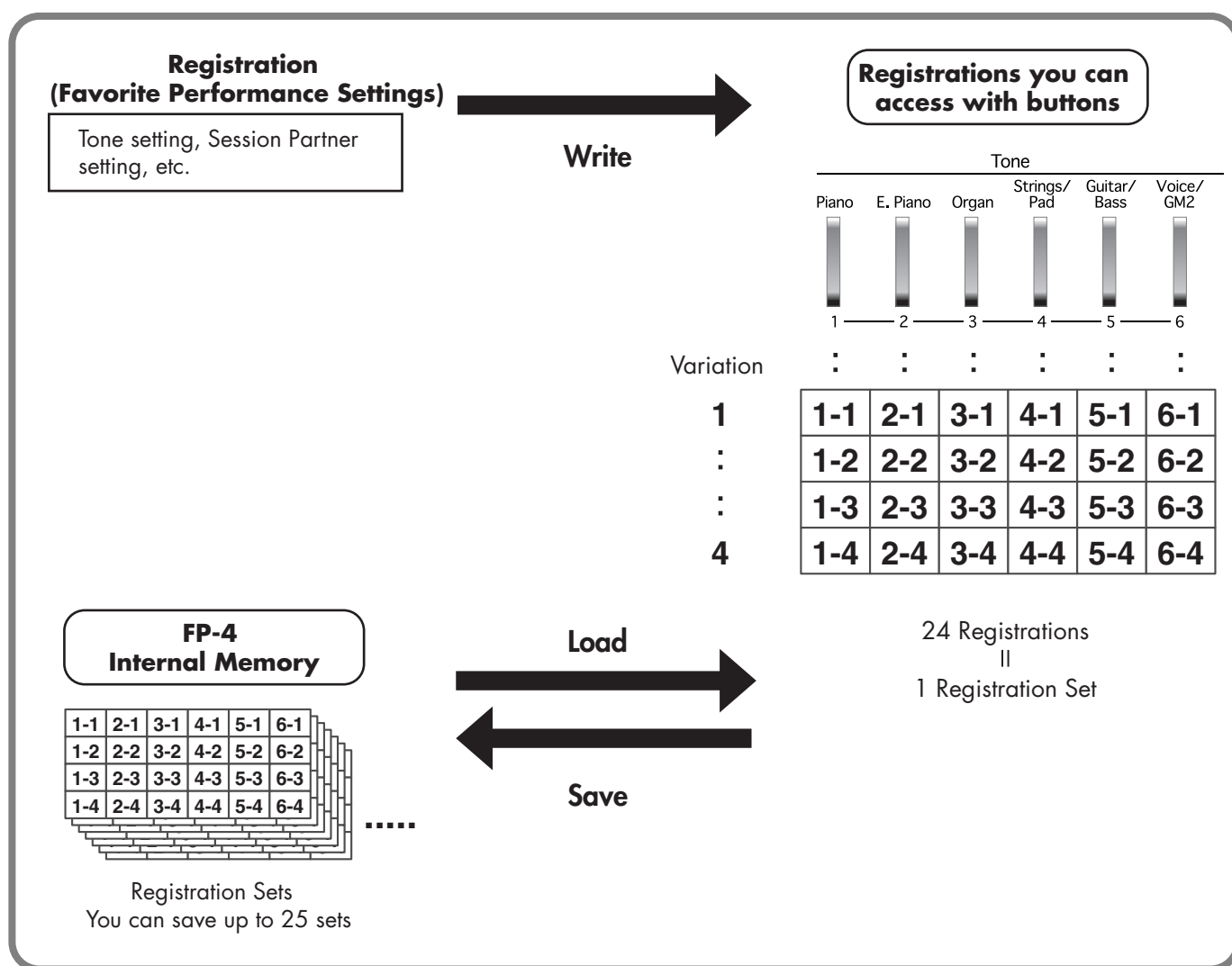

For details on the settings that are saved as a registration, refer to "Settings Stored in a Registration" (p. 128).

## Storing Your Performance Settings (Registration)

You can use the [Registration] button to store the currently selected buttons and Session Partner settings. You can also use the [Registration] button and [1]–[6] buttons to recall the settings you’ve stored. If you have certain combinations of Session Partner settings and tones that you use frequently, you will find it convenient to save them as registrations. The FP-4 lets you store twenty-four different sets of performance settings. The recommended settings were stored in the FP-4 when it shipped from the factory. Registration from 6-1 to 6-4 include the “Basic Registration.” Use this when creating registration from scratch.



For details on the settings that are saved as a registration, refer to “Settings Stored in a Registration” (p. 128).

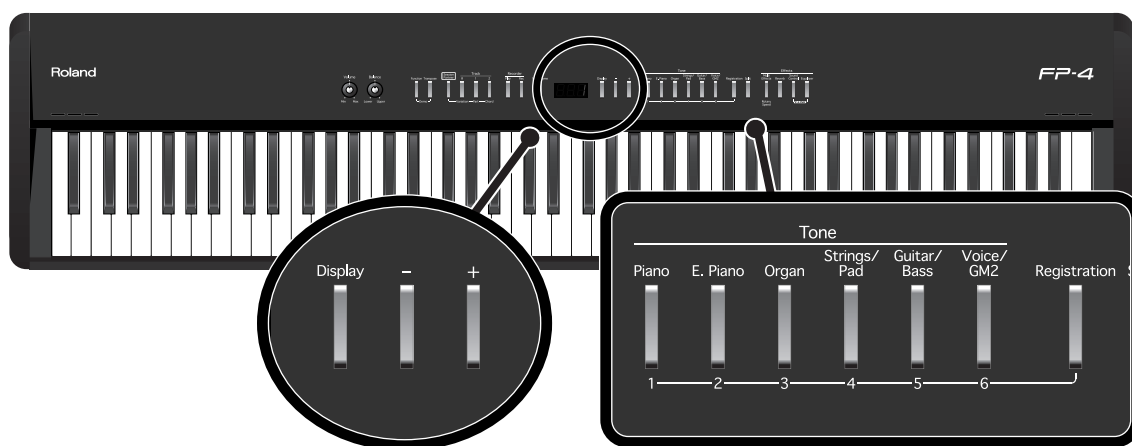

### Specifying the Storage Destination for the Registration

1. Make the desired Session Partner settings and tone settings.
2. While holding down the [Registration] button, press the button to which you want to store the registration (button [1]–[6]).

Keep holding down the [Registration] button.



3. Continuing to hold down the [Registration] button, use the [-] [+] buttons to select a variation.



## Storing the Registration

---

### 4. Release the [Registration] button.

Your performance settings will be saved.

The [Registration] button will change from blinking to lit.

**NOTE** Never turn off the power while settings are being saved. If you do so, the FP-4's internal memory will be destroyed, rendering it unusable.

**MEMO** You can return the content saved at a [Registration] button to the factory-set condition. Refer to "Restoring the Factory-set Condition (Factory Reset)" (p. 91).

To select the performance settings you saved, refer to "Recalling a Registration" (p. 59).

## Recalling a Registration

Settings you've stored with the [Registration] button can be recalled instantly. The recommended settings were stored in the instrument when it shipped from the factory. Registration from 6-1 to 6-4 include the "Basic Registration." Use this when creating registration from scratch.



For details on the settings that are saved as a registration, refer to "Settings Stored in a Registration" (p. 128).

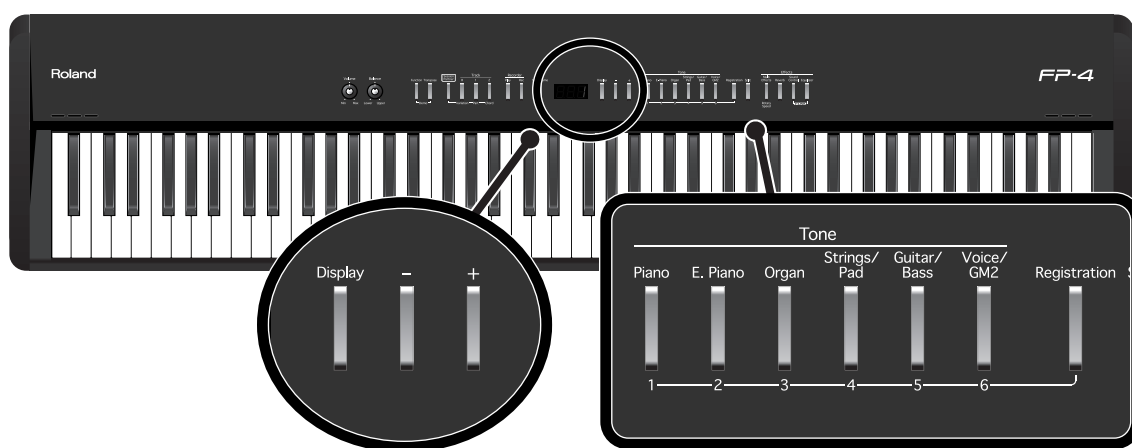

1. Press the [Registration] button.
2. Press one of the buttons from [1] to [6] to select the button at which you saved the desired registration.



3. Use the [-] [+] buttons to select the registration variation.



The performance settings will change accordingly.

## Saving a Registration Set

Here's how the twenty-four registrations stored with the [Registration] button can be saved in internal memory as a single set.

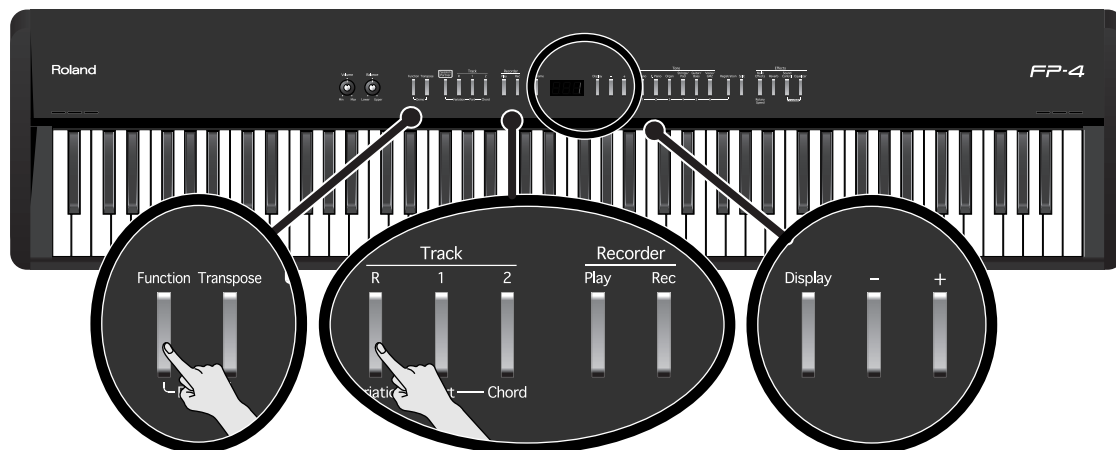

1. Press the [Function] button.
2. Press the Track [R] button.
3. While holding down the Track [R] button, use the [-] [+] buttons to get the following indication.



### Selecting a Place to Store the Registration Set

4. Use the [-] [+] buttons to select the storage destination.

A dot "." is displayed following numbers in which a registration set has already been saved, as shown below.



If you select a number in which a registration set has already been saved, the previously saved registration set will be erased. If you don't want to delete the previously saved registration set, select a number for which a dot "." is not displayed after the save-destination registration number.



## Saving the Registration Set

---

### 5. Press the [Rec] button.

The registration set will be saved.

**NOTE** Never turn off the power while settings are being saved. If you do so, the FP-4's internal memory will be destroyed, rendering it unusable.

**MEMO** You can return the content saved at a [Registration] button to the factory-set condition. Refer to "Restoring the Factory-set Condition (Factory Reset)" (p. 91).

**MEMO** To recall the saved performance settings, refer to "Loading a Registration Set You Saved" (p. 62).

## Loading a Registration Set You Saved

Here's how an entire set of registrations you saved in internal memory can be loaded back to the [Registration] button.

**NOTE** Note that when you load a registration set, all of the settings that were stored at the [Registration] button will be overwritten and lost.

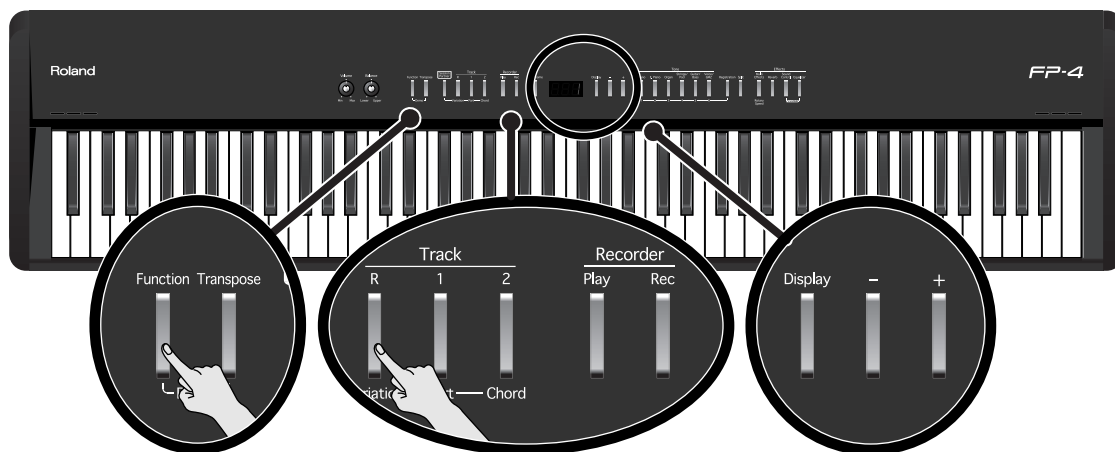

1. Press the [Function] button.
2. Press the Track [R] button.
3. While holding down the Track [R] button, use the [-] [+] buttons to get the following indication.



4. Use the [-] [+] buttons to select the number of the registration set that you want to load.

**NOTE** If no registration set has been saved in internal memory, "---" is shown in the display.

## Loading the Registration Set

5. Press the [Rec] button.

The registration set will be loaded to the [Registration] button.

**NOTE** Never turn off the power while settings are being loaded. If you do so, the FP-4's internal memory will be destroyed, rendering it unusable.

## Deleting a Registration Set You Saved

Here's how to delete an entire registration set that's been saved in internal memory.

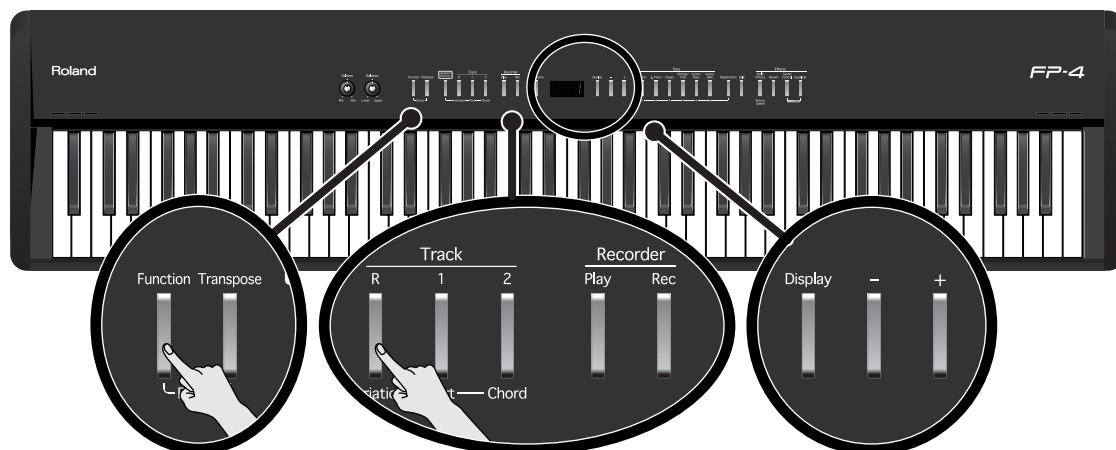

1. Press the [Function] button.
2. Press the Track [R] button.
3. While holding down the Track [R] button, use the [-] [+] buttons to get the following indication.



4. Use the [-] [+] buttons to select the number of the registration set that you want to delete.

**NOTE** If no registration set has been saved in internal memory, "---" is shown in the display.

### Deleting the Registration Set

5. Press the [Rec] button.

The registration set you selected will be deleted.

**NOTE** Never turn off the power while settings are being deleted. If you do so, the FP-4's internal memory will be destroyed, rendering it unusable.

## Using a Pedal to Switch Registrations

You can assign a pedal to successively switch registrations. Each time you press the pedal, you will switch to the next registration.

Before a concert or other performance, you can save the appropriate registrations in the order in which you'll use them, and then step smoothly through the registrations while you play.

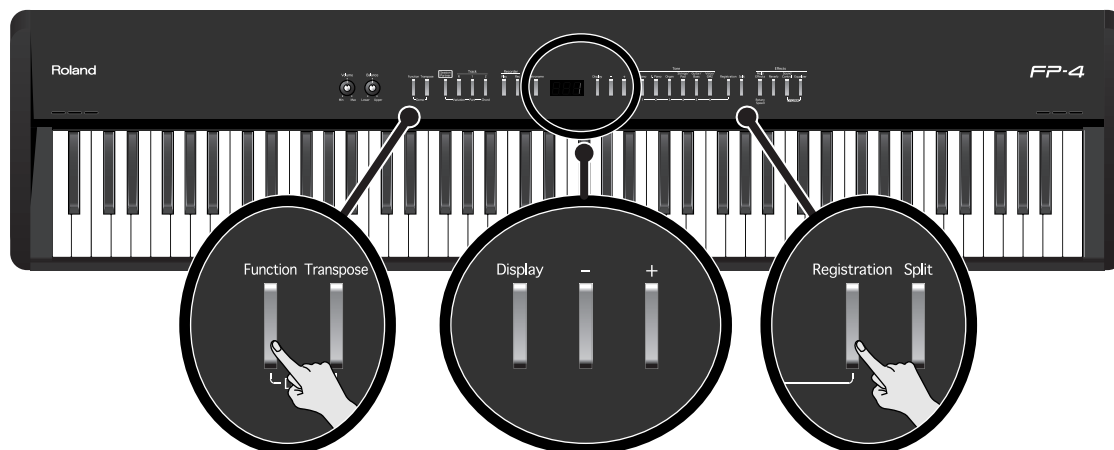

1. Press the [Function] button.
2. Press the [Registration] button.
3. While holding down the [Registration] button, use the [-] [+] buttons to get the following indication.



4. Use the [-] [+] buttons to change the setting.

Setting	Description
	Pressing a pedal connected to the FC2 connector or FC1 connector will not switch registrations. The functions assigned to the FC2 jack and FC1 jack will be available for use (p. 82).
	The pedal connected to the FC2 jack can be used only for switching registrations. In this case, the function assigned to the FC2 jack cannot be used.
	The pedal connected to the FC1 jack can be used only for switching registrations. In this case, the function assigned to the FC1 jack cannot be used.

# Recording

You can easily record your performances.

You can play back a performance you have recorded to check what and how you played, and play melodies on the keyboard along with prerecorded accompaniment using the Rhythm.

## Memo

- The song you record will disappear when you turn off the power of the FP-4.  
If you want to preserve your performance, you must save it to internal memory.  
→ “Saving the Songs You Record” (p. 76)
- With second or later recordings, the previously recorded song is erased as the new material is recorded. When recording a new performance, it is probably a good idea to erase the previously recorded performance first (p. 75).
- About the Track Buttons

Track buttons	Description
<b>Blinking</b>	The performance will be recorded. If performance data already exists, the existing performance will be erased and replaced as the new recording proceeds.
<b>Lit</b>	The performance will not be recorded. During recording, the performance located at this track button will play back.
<b>Unlit</b>	The performance will not be recorded. This track does not contain performance data.

## If the Following Display Appears

If you attempt to select another song before saving a performance you've recorded, a screen like the following will appear.



You can't play back an internal (built-in) song if there is an unsaved (user) song.

If it is OK to delete the song, press the [Rec] button.

If you don't want to delete the song, press the [Play] button to save your song to internal memory (p. 76).

## Recording a New Song

Here's how to record just your own keyboard performance without using Session Partner or an internal song.

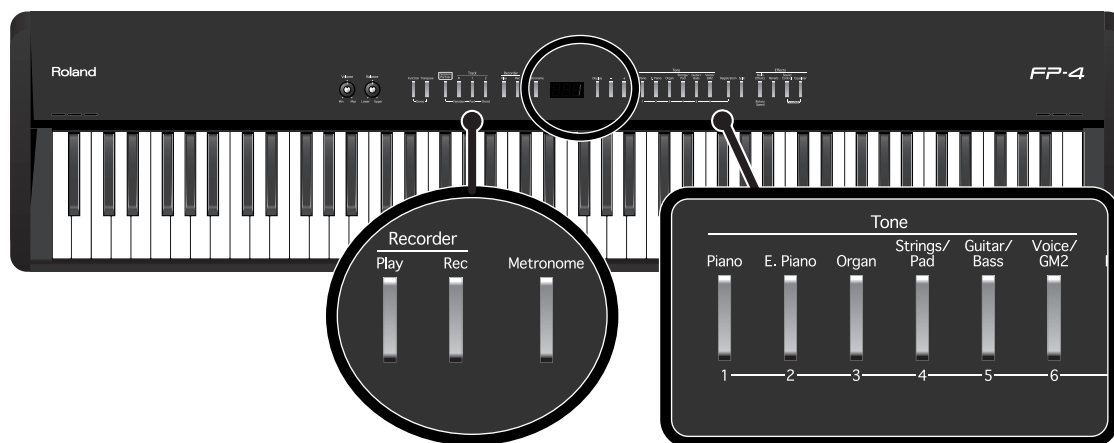

### Settings for Recording

If there is already a recorded song, delete the recorded song before you proceed (p. 75).

1. Press the [Display] button several times so it's lit in green.
2. Press the [-] button several times to get the following display.



3. Press the [Rec] button.

The [Rec] button lights, the [Play] button begins flashing, and the FP-4 is put into recording standby.

If you decide not to record, press the [Rec] button once again.

### Starting Recording

4. Press the [Play] button.

After two measures of count sound, recording begins.

Recording starts when you start playing the keyboard (without pressing the [Play] button). In this case, a count is not sounded.

When recording begins, the [Rec] button and [Play] button will light.



During the count-in, the count measure is indicated in the display as "-2" then "-1."

## Stopping Recording

### 5. Press the [Play] button.

Recording will stop.

The "USr" indication will change to "USr." when you stop recording. The dot "." in the lower right of the display indicates that a previously recorded performance exists.

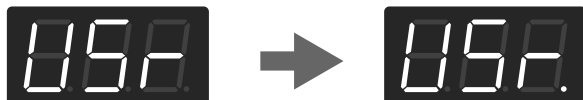

## Listening to the Recorded Performance

### 6. Press the [Play] button.

The recorded performance will play back.

### 7. Press the [Play] button once again to stop playback.

**NOTE** The recorded performance will disappear when you turn off the power. If you want to keep the performance you recorded, you must save it in internal memory. Refer to "Saving the Songs You Record" (p. 76).

**MEMO** You can save your recorded songs on an external sequencer or computer. Refer to "Connecting to MIDI Devices" (p. 99) and "Connecting to a Computer via the USB (MIDI) Connector" (p. 98).

You can change the tone used in recording.

→ "Performing with a Variety of Sounds" (p. 28)

You can change the tempo and set the beat for the song.

→ "Changing the Tempo" (p. 41)

→ "Changing the Beat of Metronome" (p. 91)

You can use the FP-4's metronome function.

In this case, the metronome sound is not recorded.

→ "Performing with the Metronome" (p. 40)

### Track Button Assignments for the Recorded Performance

When you record only a keyboard performance, the performance will be assigned to the track buttons as follows.

Performance recorded	Track button
Normal performance (playing a single sound from the entire keyboard)	The performance is recorded to the Track [2] button.
Dual performance (p. 29)	The performance is recorded to the Track [2] button.
Split performance (p. 31)	The Lower Tone is recorded to the Track [1] button, and the Upper Tone to the Track [2] button.

## Recording Your Playing Along with a Song

Here's how you can play along with an internal song and record your performance. The song being played back will be recorded together with the performance you play on the keyboard. The FP-4 is able to record your playing along with an internal piano song. For example, you could listen to the left-hand part while you record the right-hand part.



If you select a track button and then record, the sound of the selected track button will not be heard during recording.

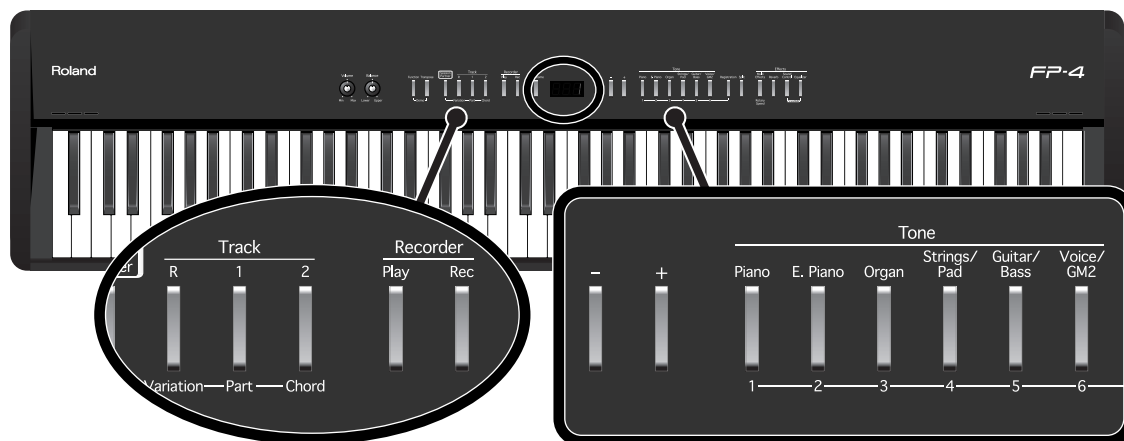

### Performance Settings

#### 1. Select a song.

For details on how to select a song, refer to "Listening to Internal Songs" (p. 22). You can change the tone used in performances (p. 28) and change the tempo at which songs are played back (p. 41). You can also play the metronome sound while recording (p. 40).

### Settings for Recording

#### 2. Press the [Rec] button.

If you decide not to record, press the [Rec] button once again.

#### 3. Press the button of the track you want to record, so the button is blinking.

Track buttons	Description
<b>Blinking</b>	The performance will be recorded. If performance data already exists, the existing performance will be erased and replaced as the new recording proceeds.
<b>Lit</b>	The performance will not be recorded. During recording, the performance located at this track button will play back.
<b>Unlit</b>	The performance will not be recorded. This track does not contain performance data.



## How the track buttons correspond to an internal song's performance parts

Track button	Performance part
Track [1] button	Left-hand part
Track [2] button	Right-hand part
Track [R] button	For internal song numbers 1–5, this track contains performance data other than the right-hand part and left-hand part. For internal song numbers 6–65, this track does not contain performance data.

The [Rec] button will light, the [Play] button will blink, and the instrument will enter recording standby mode. This setting lets you record while listening to the selected song.

## Starting Recording

### 4. Press the [Play] button.

After two measures of count sound, recording begins.

Recording starts when you start playing the keyboard (without pressing the [Play] button). In this case, a count is not sounded.

When recording begins, the [Rec] button and [Play] button will light.

**MEMO** During the count-in, the count measure is indicated in the display as “-2” then “-1.”

## Stopping Recording

### 5. Press the [Play] button.

Recording will stop.

## Listening to the Recorded Performance

### 6. Press the [-] button to return to the beginning of the song you recorded.

### 7. Press the [Play] button.

The recorded performance will play back.

### 8. Press the [Play] button once again to stop playback.

**NOTE** The recorded performance will disappear when you turn off the power. If you want to keep the performance you recorded, you must save it in internal memory. Refer to “Saving the Songs You Record” (p. 76).

**MEMO** You can save your recorded songs on an external sequencer or computer. Refer to “Connecting to MIDI Devices” (p. 99) and “Connecting to a Computer via the USB (MIDI) Connector” (p. 98).

**NOTE** The tempo of the performance you recorded will be stored as the tempo of the song you selected when recording. If you record your performance while playing along with a song, it will be recorded with the time signature of that song.

## Recording Your Performance with Session Partner

You can easily record session performances to the session partner.

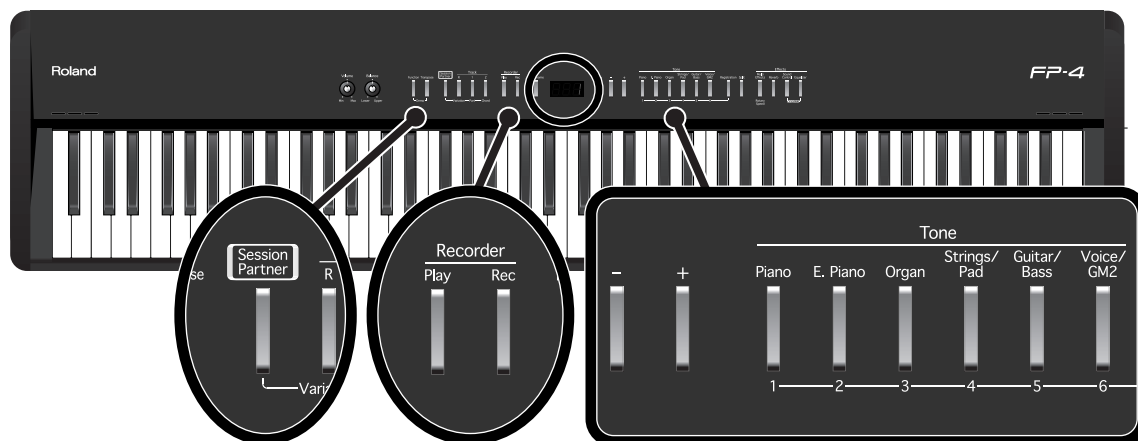

The Session Partner performance can be recorded only to the Track [R] button.

### Performance Settings

1. Select the Tone to be played (p. 28).
2. Make the desired settings for Session Partner (p. 44).

### Settings for Recording

If there is already a recorded song, delete the recorded song before you proceed (p. 75).

3. Press the [Display] button several times so it's lit in green.
4. Press the [-] button several times to get the following display.



5. Press the [Rec] button.

The [Rec] button will light, the [Play] button will blink, and the instrument will enter recording standby mode. If you decide not to record, press the [Rec] button once again.

### Starting Recording

6. Start the Session Partner performance (p. 45, p. 51).

The Rhythm starts to play, while simultaneously recording begins. When recording begins, the [Rec] button and [Play] button will light.



For more information on the different Rhythm and Chord progression pattern, refer to the “Rhythm List” (p. 116) and “Chord Progression Pattern List” (p. 117).



If you’ll be specifying chord progressions while you record (p. 51), recording will begin when you specify a chord in the left-hand region of the keyboard.

## Stopping Recording

### 7. Press the [Play] button.

Recording will stop.

The “USr” indication will change to “USr.” when you stop recording. The dot “.” in the lower right of the display indicates that a previously recorded performance exists.

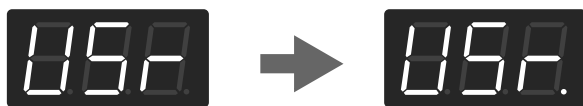

## Listening to the Recorded Performance

### 8. Press the [-] button to return to the beginning of the song you recorded.

### 9. Press the [Play] button.

The recorded performance will play back.

### 10. Press the [Play] button once again to stop playback.



The recorded performance will disappear when you turn off the power. If you want to keep the performance you recorded, you must save it in internal memory. Refer to “Saving the Songs You Record” (p. 76).



You can save your recorded songs on an external sequencer or computer. Refer to “Connecting to MIDI Devices” (p. 99) and “Connecting to a Computer via the USB (MIDI) Connector” (p. 98).

### Track Button Assignments for the Recorded Performance

Performance recorded	Track button
Session Partner performance	The performance is recorded to the Track [R] button.
Normal performance (playing a single sound from the entire keyboard)	The performance is recorded to the Track [2] button.
Dual performance (p. 29)	The performance is recorded to the Track [2] button.
Split performance (p. 31)	The Lower Tone is recorded to the Track [1] button, and the Upper Tone to the Track [2] button.

## Recording Selected Track Buttons

FP-4's Recorder has three Track buttons.

When you press the [Rec] button, all Track buttons are set to be recorded, but by selecting Track buttons that are not to be recorded, you can then record only on the specific Track buttons you want.

You can play each hand of your performance separately, for example recording the left-hand part on the Track [1] button and the right-hand part on the Track [2] button. You can also re-record just a specific part of a previously recorded performance.

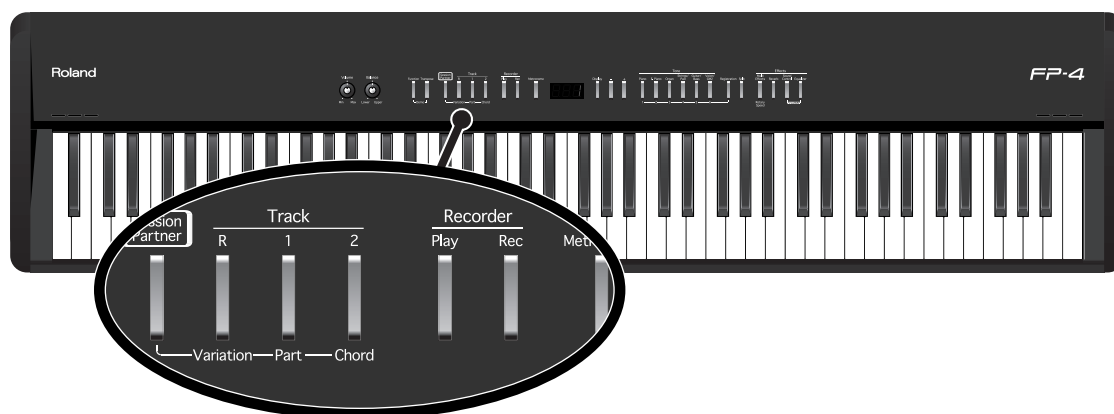

If you're recording a new song, select "USr" as described in steps 1–2 of "Recording a New Song" (p. 66). If you decide to re-record an existing song, select that song.

## Performance Settings

### 1. Press the [Rec] button.

The [Rec] button will light, the [Play] button will blink, and the instrument will enter recording standby mode.

If you decide not to record, press the [Rec] button once again.

### 2. Press the button of the track you want to record, so the button is blinking.

Track buttons	Description
<b>Blinking</b>	The performance will be recorded. If performance data already exists, the existing performance will be erased and replaced as the new recording proceeds.
<b>Lit</b>	The performance will not be recorded. During recording, the performance located at this track button will play back.
<b>Unlit</b>	The performance will not be recorded. This track does not contain performance data.

## Starting Recording

---

### 3. Press the [Play] button.

After two measures of count sound, recording begins.

Recording starts when you start playing the keyboard (without pressing the [Play] button). In this case, a count is not sounded.

When recording begins, the [Rec] button and [Play] button will light.

**MEMO** During the count-in, the count measure is indicated in the display as "-2" then "-1."

## Stopping Recording

---

### 4. Press the [Play] button.

Recording will stop.

**NOTE** If you record without erasing the existing song, the song tempo, time signature, and metronome settings will remain as they were for the first recording.

## Listening to the Recorded Performance

---

### 5. Press the [-] button to return to the beginning of the song you recorded.

### 6. Press the [Play] button.

The recorded performance will play back.

### 7. Press the [Play] button once again to stop playback.

**NOTE** The recorded performance will disappear when you turn off the power. If you want to keep the performance you recorded, you must save it in internal memory. Refer to "Saving the Songs You Record" (p. 76).

**MEMO** You can save your recorded songs on an external sequencer or computer. Refer to "Connecting to MIDI Devices" (p. 99) and "Connecting to a Computer via the USB (MIDI) Connector" (p. 98).

### Correspondence Between Recorded Performance and Track Buttons

A recorded performance will be assigned to the Track buttons as follows.

#### ● Session Partner performances, and Upper and Lower tones during Split performance

Track button	Performance recorded
Track [R] button	Session Partner (p. 44)
Track [1] button	Lower Tone in Split play (p. 31)
Track [2] button	Upper Tone in Split play (p. 31)

#### ● Normal performance (playing a single sound from the entire keyboard) and Dual performance

- When you record without specifying a recording track  
If none of the track buttons ([R] [1] [2] buttons) has performance data, the data will be recorded to button [2]. If any of the track buttons have performance data, the data will be recorded in the order of button [2] → button [1] → button [R].
- When you record with a specified recording track  
Your performance will be recorded on the track you've specified.

## Erasing Recorded Performances

You can erase recorded performances.

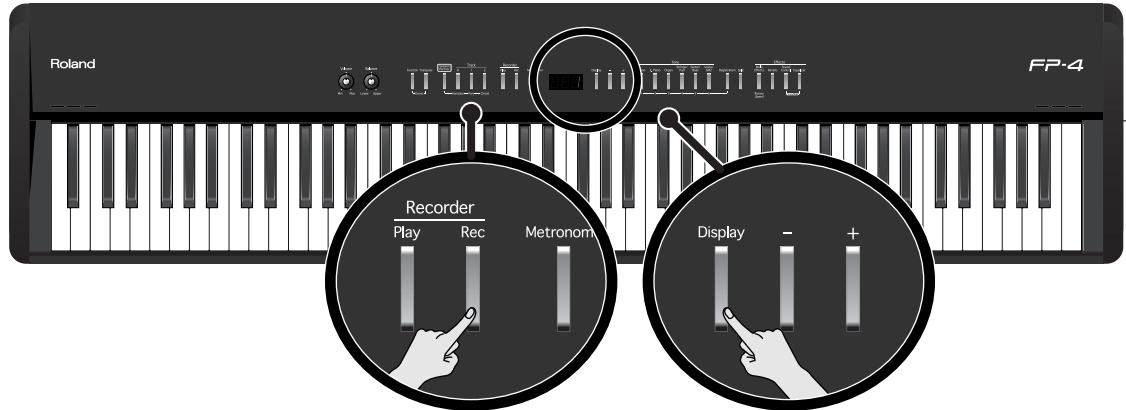

### 1. Hold down the [Display] button and press the [Rec] button.

A confirmation message appears in the display.



If you decide not to delete the song, press the [Play] button.

### 2. Press the [Rec] button.

The recorded performance is erased.



After playing back a song, you can hold down one of the track buttons and press the [Rec] button to erase the performance of only that track. At this time, the display will indicate "USr." If you erase the performance from all tracks, the display will indicate "USr".



A performance you recorded will be deleted automatically when you turn off the power.

# Saving a Performance

## Saving the Songs You Record

A song you've recorded can be saved in internal memory.

If you record a song and then turn off the power of the FP-4 without saving the song, your recorded song will disappear. Songs that you've saved in internal memory will not disappear even if you turn off the power; if you want to keep a song, you should save it in internal memory.

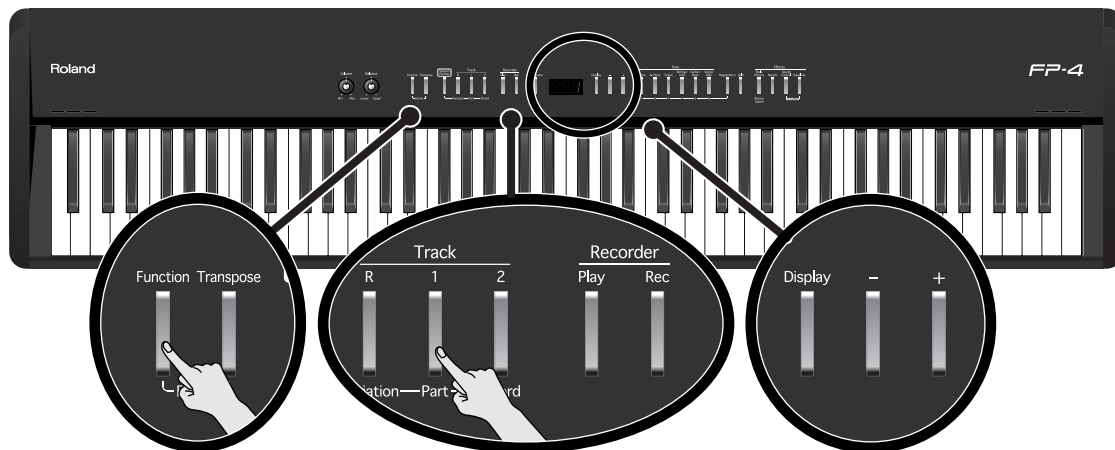

1. Record your performance (p. 66, p. 68, p. 70, p. 72).
2. Press the [Function] button.
3. Press the Track [1] button.
4. Hold down the Track [1] button and use the [-] [+] buttons to get the following display.



5. Use the [-] [+] buttons to select the save-destination song number.

As shown below, a dot "." is shown following numbers in which a song has already been saved.



If you select a number in which a song has already been saved, and then save your new song, the previously saved song will be overwritten and lost. If you don't want to delete the previously saved song, select a number for which a dot "." is not displayed.

## Saving the Song

6. Press the [Rec] button.

The song will be saved.

**NOTE** Never turn off the power while data is being saved. If you do so, the internal memory will be destroyed, rendering it unusable.



## Deleting a Saved Song

Here's how to delete a song you've saved in internal memory.

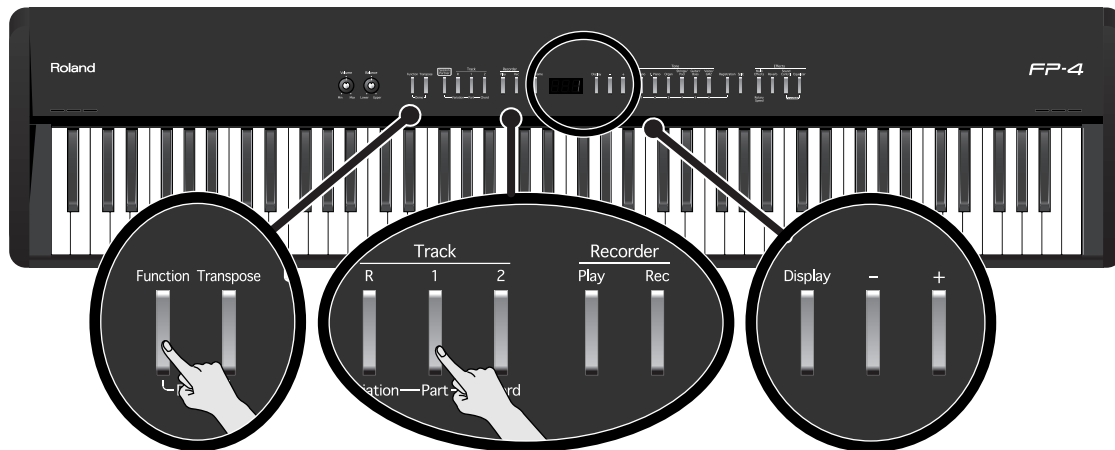

1. Press the [Function] button.
2. Press the Track [1] button.
3. Hold down the Track [1] button and use the [-] [+] buttons to get the following display.



4. Use the [-] [+] buttons to select the song number that you want to delete.

### Deleting the Song

5. Press the [Rec] button.

The selected song will be deleted.

**NOTE**

Never turn off the power while a song is being deleted. If you do so, the FP-4's internal memory will be destroyed, rendering it unusable.

# Settings

You can make a variety of performance- and recording-related settings in "Function Mode."

Function	Display	Button	Page
Master Tuning		Piano	p. 79
Storing the Master Tuning Setting			p. 79
Temperament, Keynote			p. 80
FC2 Part		E.Piano	p. 81
FC1 Part		Organ	p. 81
Damper Pedal Part		Strings/Pad	p. 81
FC2 Function		Guitar/Bass	p. 82
FC1 Function		Voice/GM2	p. 83
Pedal Shift		Registration	p. 64
Bank Select MSB			p. 103
Bank Select LSB			p. 103
Program Change			p. 103
MIDI Transmit Channel			p. 104
Bulk Dump			p. 104
Octave Shift			Split
Effect Type		Multi Effects	p. 83
Part to which the Effect will Apply			p. 84
Sound Control Setting at Power-on		Reverb	p. 84
Equalizer Setting at Power-on			p. 84
Master Gain			p. 85
USB Driver			p. 98
Upper Transmit Channel			Sound Control
Lower Transmit Channel		p. 100	
Send PC		p. 102	
Local Control		p. 101	
Transmit the Recorded Performance		p. 102	

Function	Display	Button	Page
Low Gain		Equalizer	p. 85
Low Freq			p. 85
Low Mid Gain			p. 85
Low Mid Freq			p. 85
Low Mid. Q			p. 85
High Mid Gain			p. 85
High Mid Freq			p. 86
High Mid Q			p. 86
High Gain			p. 86
High Freq			p. 86
Key Touch		Transpose	p. 86
Velocity when Key Touch is "OFF"			p. 87
Intro/Ending On/Off		Session Partner	p. 88
Chord Pattern			p. 88
Chord Root			p. 89
Automatic Chord Progression On/Off			p. 89
Chord Display On/Off			p. 90
Registration Load		Track R	p. 62
Registration Save			p. 60
Registration Delete			p. 63
Song Save		Track 1	p. 76
Song Delete			p. 77
Initializing the Internal Memory		Track 2	p. 90
Metronome Beat		Metronome	p. 91

## Tuning Settings

### Matching the Pitch with Other Instruments (Master Tuning)

When playing ensemble with other instruments and in other such instances, you can match the standard pitch to another instrument.

The standard pitch generally refers to the pitch of the note that's played when you finger the middle A key. For a cleaner ensemble sound while performing with one or more other instruments, ensure that each instrument's standard pitch is in tune with that of the other instruments. This tuning of all the instruments to a standard pitch is called "master tuning."

1. Press the [Function] button.
2. Press the [Piano] button.
3. Hold down the [Piano] button and use the [-] [+] buttons to get "tun" to appear in the display.

4. Use the [-] [+] buttons to change the setting.

Setting
15.3-40.0-66.2 (415.3 Hz-440.0 Hz-466.2 Hz)

When the instrument is shipped from the factory, this is set to "40.0 (440.0 Hz)."

### Storing the Master Tuning Setting in Internal Memory

After adjusting the master tuning setting, you can store that setting to internal memory.

If you've stored the master tuning setting, it will be preserved even when the power is turned off.

5. Hold down the [Piano] button and use the [-] [+] buttons to get "bUP" to appear in the display.

When you take your finger off the [Piano] button, a confirmation message will appear.

If you press the [Play] button once again, you will return to the previous screen without storing the master tuning setting.

6. Press the [Rec] button.

The master tuning setting will be stored to internal memory.

## Adjusting the Tuning (Temperament)

You can play classical music such as baroque pieces using their original tuning.

Most modern songs are composed and played with the assumption that equal temperament (the most common tuning in use today) will be used, but when classical music was composed, there were a wide variety of other tuning systems in existence. Playing a composition with its original tuning lets you enjoy the sonorities of the chords that the composer originally intended.

1. Press the [Function] button.
2. Press the [Piano] button.
3. Hold down the [Piano] button and use the [-] [+] buttons to get "tmP" to appear in the display.



4. Use the [-] [+] buttons to change the temperament setting.



Temperament      Keynote

You can choose from among the seven tunings described below.

Display	Temperament	Description
1	Equal	In this tuning, each octave is divided into twelve equal steps. Every interval produces about the same amount of slight dissonance. This setting is in effect when you turn on the power.
2	Just Major	This tuning eliminates ambiguities in the fifths and thirds. It is unsuited to playing melodies and cannot be transposed, but is capable of beautiful sonorities.
3	Just Minor	The Just tunings differ from major and minor keys. You can get the same effect with the minor scale as with the major scale.

Display	Temperament	Description
4	Kirnberger	This is an improvement of the Mean Tone and Just tunings that provides a high degree of freedom of modulation. Performances are possible in all keys (third method).
5	Mean Tone	This scale makes some compromises in just intonation, enabling transposition to other keys.
6	Pythagorean	This tuning, devised by the philosopher Pythagoras, eliminates dissonance in fourths and fifths. Dissonance is produced by third-interval chords, but melodies are euphonious.
7	Werckmeister	This temperament combines the Mean Tone and Pythagorean tunings. Performances are possible in all keys (first method, number three).

## Specifying the Keynote

When playing with tuning other than equal temperament, you need to specify the keynote for tuning the song to be performed (that is, the note that corresponds to C for a major key or to A for a minor key).

If you choose an equal temperament, there's no need to select a keynote.

5. Hold down the [Piano] button and use the [-] [+] buttons to get "tmP" to appear in the display.



6. While holding down the [Piano] button, press the key that you want to specify as the keynote.



Temperament      Keynote

Display	C	C <sup>-</sup>	d	E <sub>-</sub>	E	F	F <sup>-</sup>	G	A <sub>-</sub>	A	b <sub>-</sub>	b
Key	C	C#	D	E <sub>b</sub>	E	F	F#	G	A <sub>b</sub>	A	B <sub>b</sub>	B



**NOTE**

When performing in ensemble with other instruments, be aware that depending on the key, there may be some shifting of the pitch. Tune the FP-4 to the fundamental pitch of the other instruments.

## Pedal Settings

### Changing How the Pedal Effects Are Applied

When the pedal is pressed in Dual Play (p. 29) or Split Play (p. 31), the pedal's effect is applied to both the Upper Tone and the Lower Tone, but you can change the settings for the tone to which the effect is applied.

Setting	Description
 (Upper&Lower)	All enabled
 (Upper)	Applied only to the Upper Tone
 (Lower)	Applied only to the Lower Tone

### How the Soft Pedal (FC2) Effects are Applied

1. Press the [Function] button.
2. Press the [E.Piano] button.



3. Use the [-] [+] buttons to specify the part(s) to which the pedal will apply.

### How the Sostenuto Pedal (FC1) Effects are Applied

1. Press the [Function] button.
2. Press the [Organ] button.



3. Use the [-] [+] buttons to specify the part(s) to which the pedal will apply.

### How the Damper Pedal Effects are Applied

1. Press the [Function] button.
2. Press the [Strings/Pad] button.













3. Use the [-] [+] buttons to specify the part(s) to which the pedal will apply.

## Changing How the Pedals Work

A pedal connected to the Soft/(FC2) jack normally functions as a soft pedal (p. 18). A pedal connected to the Sostenuto/(FC1) jack normally functions as a sostenuto pedal (p. 18). It can also be set to function as another works.

You can select from the following pedal functions.

Setting	Description
 (Damper)	Sets function to damper pedal.
 (Soft)	Sets function to soft pedal.
 (Sostenuto)	Sets function to sostenuto pedal.
 (Expression)	Allows control of the volume. Connect a separately available expression pedal (EV-5). You cannot change volume level of session partner and recorder.
 (Start/Stop)	You can start/stop Session Partner by pressing the pedal instead of pressing [Session Partner] button.
 (Leading Bass)	Allows control the on/off of leading bass function*. It is turned on while having stepped on the pedal.
 (On/Off of Effects)	Effects can be switched on/off by pressing the pedal instead of pressing the [Multi Effects] button. When effect type is rotary, you can control the slow/fast of spinning.
 (Bend Up)	Pitch rises by pressing the pedal.
 (Bend Down)	Pitch lowers by pressing the pedal.
 (Modulation)	Vivtrato is added by pressing the pedal.

### \* What is the leading bass function?

The function that sounds the lowest note of a fingered chord as the bass tone is called "Leading Bass."

**NOTE** With certain sounds, the function may not work.

**NOTE** Use only the specified expression pedal (EV-5; sold separately). By connecting any other expression pedals, you risk causing malfunction and/or damage to the unit.

**NOTE** This may not work correctly if you connect a pedal other than an expression pedal or a half-damper compatible pedal.

**NOTE** Be sure to switch off the power to the unit before attempting to disconnect or connect a pedal cord.

**NOTE** If a pedal connected to the FP-4 is assigned to switch registrations, that pedal will operate only to switch registrations. The function assigned to the pedal will not operate.

## Changing the Works of the Soft Pedal (FC2)

When the instrument is turned on, this is set to function as a soft pedal.

1. Press the [Function] button.
2. Press the [Guitar/Bass] button.



3. Use the [-] [+] buttons to select the pedal function.



## Changing the Works of the Sostenuto Pedal (FC1)

When the instrument is turned on, this is set to function as a sostenuto pedal.

1. Press the [Function] button.
2. Press the [Voice/GM2] button.



3. Use the [-] [+] buttons to select the pedal function.



## Effect Settings

### Changing the Effect Type

Here's how to select the effect that will be applied when you press the [Multi Effects] button.

1. Press the [Function] button.
2. Press the [Multi Effects] button.
3. Hold down the [Multi Effects] button and use the [-] [+] buttons to get "E.ty" to appear in the display.



4. Use the [-] [+] buttons to select the effect type.



For details on the effect types and the settings for each effect, refer to "Effects List" (p. 126).

## Setting the Part to Which Effects Are Added

This specifies which part is to have priority when the effects assigned to the Upper Tone and Lower Tone differ in Dual Play (p. 29) or Split Play (p. 31).

1. Press the [Function] button.
2. Press the [Multi Effects] button.
3. Hold down the [Multi Effects] button and use the [-] [+] buttons to get "E.Pt" to appear in the display.



4. Use the [-] [+] buttons to select the part to which you want to apply effects.

Setting	Description
(Upper)	The effect will be preferentially applied to the Upper tone.
(Lower)	The effect will be preferentially applied to the Lower tone.



If same effects are assigned to the Upper Tone and Lower Tone, the same effects are added to both of Tones.

## System Settings

### Specifying the Sound Control Setting at Power-on

You can change the Sound Control type that is selected when you turn on the power of the FP-4. You can also specify that Sound Control be off when you turn on the power.

1. Press the [Function] button.
2. Press the [Reverb] button.
3. Hold down the [Reverb] button and use the [-] [+] buttons to get "S.Ct" to appear in the display.



4. Use the [-] [+] buttons to change the setting.

Setting	Description
	When you turn on the power, the [Sound Control] button will be on, and the Type 1 Sound Control setting will be selected.
	When you turn on the power, the [Sound Control] button will be on, and the Type 2 Sound Control setting will be selected.
	When you turn on the power, the [Sound Control] button will be on, and the Type 3 Sound Control setting will be selected.
	When you turn on the power, the [Sound Control] button will be off.

### Specifying the Equalizer Setting at Power-on

You can specify that the equalizer be on when you turn on the power.

You can also specify the equalizer type that will be selected if the equalizer is on when you turn on the power of the FP-4.

1. Press the [Function] button.
2. Press the [Reverb] button.
3. Hold down the [Reverb] button and use the [-] [+] buttons to get "Eq" to appear in the display.





#### 4. Use the [-] [+] buttons to change the setting.

Setting	Description
	When you turn on the power, the [Equalizer] button will be on, and the Type 1 Equalizer setting will be selected.
	When you turn on the power, the [Equalizer] button will be on, and the Type 2 Equalizer setting will be selected.
	When you turn on the power, the [Equalizer] button will be on, and the Type 3 Equalizer setting will be selected.
	When you turn on the power, the [Equalizer] button will be on, and the Type 4 Equalizer setting will be selected.
	When you turn on the power, the [Equalizer] button will be off.

### Adjusting the Volume (Master Gain)

If you've connected an external device to the Input jacks and want to listen to the sound from it, the sound from the external device may not be loud enough even if you've turned the FP-4's volume knob to the maximum position. In such cases, you can adjust the master gain setting as follows.

Adjusting the master gain will also affect the volume of the internal speakers and headphones.

**NOTE** The sound may distort if you increase the volume excessively.

1. Press the [Function] button.
2. Press the [Reverb] button.
3. Hold down the [Reverb] button and use the [-] [+] buttons to get "MAS" to appear in the display.



#### 4. Use the [-] [+] buttons to change the setting.

Setting
-10-10





## Equalizer Settings

### Changing the Equalizer Settings

You can make fine, detailed changes to the equalizer settings. Before you make detailed adjustments to the equalizer settings, select the equalizer type that you want to edit (p. 43).

1. Press the [Function] button.
2. Press the [Equalizer] button.
3. Hold down the [Equalizer] button, and press the [-] or [+] button to select item.
4. Use the [-] [+] buttons to change the setting.

Indication	Setting	Description
 (Low Gain)	-12-12 (dB)	Adjusts the level of the low-frequency range.
 (Low Freq)	100, 200, 400 (Hz)	Frequency point in the low-frequency range. Generally, this changes the level at and below this frequency.
 (Low Mid Gain)	-12-12 (dB)	Adjusts the level of the low-frequency range to midrange.
 (Low Mid Freq)	200, 250, 315, 400, 500, 630, 800 (Hz), 1.00, 1.25, 1.60, 2.00, 2.50, 3.15, 4.00, 5.00, 6.30, 8.00 (KHz)	Frequency point in the low-frequency range to midrange. This changes the level of the specified bandwidth centered on this frequency.
 (Low Mid Q)	0.5, 1.0, 2.0, 4.0, 8.0	Changes the bandwidth of the low-frequency range to midrange. The bandwidth affected by the controls narrows as the value increases.

Indication	Setting	Description
 (High Mid Gain)	-12-12 (dB)	Adjusts the level of the mid-to high-frequency range.
 (High Mid Freq)	200, 250, 315, 400, 500, 630, 800 (Hz), 1.00, 1.25, 1.60, 2.00, 2.50, 3.15, 4.00, 5.00, 6.30, 8.00 (KHz)	Frequency point in the mid-to high-frequency range to midrange. This changes the level of the specified bandwidth centered on this frequency.
 (High Mid Q)	0.5, 1.0, 2.0, 4.0, 8.0	Changes the bandwidth of the mid- to high-frequency range. The bandwidth affected by the controls narrows as the value increases.
 (High Gain)	-12-12 (dB)	Adjusts the level of the high-frequency range.
 (High Freq)	2.00, 4.00, 8.00 (KHz)	Frequency point in the high-frequency range. Generally, this changes the level at and over this frequency.



Sounds may become distorted as the Gain level increases.



The equalizer will be turned on when you access the Equalizer screen.



The FP-4 remembers the settings even while its power is turned off.

## Keyboard Settings





### Changing the Keyboard Touch (Key Touch)

You can adjust the sensitivity with which the keyboard responds to your playing.

1. Press the [Function] button.
2. Press the [Transpose] button.
3. Hold down the [Transpose] button and use the [-] [+] buttons to get "tch" to appear in the display.



4. Use the [-] [+] buttons to change the setting.

Setting	Description
 (OFF)	With this setting, all notes will sound at a fixed volume regardless of how strongly you play the keyboard.
 (Light)	This setting allows you to produce fortissimo (ff) sounds without having to play so strongly, giving you the sensation that the keyboard is lighter. A child whose hand strength is not yet developed will find it easy to play using this setting.
 (Medium)	This setting offers the most natural-feeling touch, and is closest to the sensitivity of an acoustic piano.
 (Heavy)	This setting requires that you play more strongly in order to produce fortissimo (ff) sounds, giving you the sensation that the keyboard is heavier. With this setting, you'll have greater expressive range when you play dynamically.



You can specify the loudness at which each note will sound when the "OFF" keyboard touch is selected. Refer to "Changing the Velocity When the Key Touch is Set to "OFF"" (p. 87).

## Changing the Velocity When the Key Touch is Set to "OFF"

This sets the velocity the sound will have when the keyboard touch is set to "OFF."

If you turn the keyboard's touch sensitivity "OFF," all notes will sound at a fixed loudness regardless of how strongly you play the keyboard. The setting described below specifies the loudness in this case.

1. Press the [Function] button.
2. Press the [Transpose] button.
3. Hold down the [Transpose] button and use the [-] [+] buttons to get "vEL" to appear in the display.



4. Use the [-] [+] buttons to change the setting.

Setting
1-127

## Changing the Pitch of the Lower Tone in Octave Steps (Octave Shift)

You can change the pitch of the Lower Tone in Dual Play (p. 29) and Split Play (p. 31) an octave at a time.

Altering the pitch in one-octave units in this way is called "Octave Shift."

For example, you can raise the pitch of the Lower Tone to the same pitch of the Upper Tone in Split Play.

1. Press the [Function] button.
2. Press the [Split] button.



3. Use the [-] [+] buttons to specify the pitch of the notes.

The range of available pitch change spans from two octaves higher to two octaves lower.

The pitch is lowered one octave each time the [-] button is pressed, while each press of the [+] button raises the pitch by one octave.

To return to the original pitch, press the [-] and [+] buttons simultaneously.

Setting
-2-0-2

## Session Partner Settings

### Setting the Intro and Ending On or Off

This sets session partner Intro and Ending on or off. When set to "OFF," pressing the [Session Partner] button causes the Intro and Ending not to be played.

1. Press the [Function] button.
2. Press the [Session Partner] button.
3. Hold down the [Session Partner] button and use the [-] [+] buttons to get "ltr" to appear in the display.



4. Use the [-] [+] buttons to change the setting.

Setting	Description
	Pressing the [Session Partner] button causes the Intro and Ending to be played.
	Pressing the [Session Partner] button causes the Intro and Ending not to be played.

## Selecting a Chord Progression Pattern

Here's how to select the chord progression pattern for the currently selected rhythm used when Session Partner plays.

1. Press the [Function] button.
2. Press the [Session Partner] button.
3. Hold down the [Session Partner] button and use the [-] [+] buttons to get "Ptn" to appear in the display.



4. Use the [-] [+] buttons to change the setting.

Setting
(USr), 1-56



"USr" is displayed if there is a chord progression you yourself created (p. 54).

## Selecting the Root Note of the Chord Progression

Here's how to specify the root note of the first chord of currently Session Partner's chord progression.

1. Press the [Function] button.
2. Press the [Session Partner] button.
3. Hold down the [Session Partner] button and use the [-] [+] buttons to get "rot" to appear in the display.



4. Press the [-] [+] buttons or the key corresponding to the root note of the first chord.

Display	C	C <sup>-</sup>	d	E <sub>-</sub>	E	F	F <sup>-</sup>	G	A <sub>-</sub>	A	b <sub>-</sub>	b
Key	C	C#	D	E <sub>b</sub>	E	F	F#	G	A <sub>b</sub>	A	B <sub>b</sub>	B

## Fixing a Set Chord Progression



Session Partner contains chord progression pattern data that is suitable for each rhythm.

Here you can specify whether a chord progression suitable for the rhythm will be automatically selected when you switch the rhythm of the Session Partner function.

1. Press the [Function] button.
2. Press the [Session Partner] button.
3. Hold down the [Session Partner] button and use the [-] [+] buttons to get "ACP" to appear in the display.



4. Use the [-] [+] buttons to change the setting.

Setting	Description
	When you change rhythms, the chord progression pattern will switch to the pattern that is most suitable for the selected rhythm.
	When the rhythm changes, the chord progression pattern does not change.

## Setting the Chord Display On or Off

This setting determines whether or not the chords are indicated in the display during performances using Session Partner.

1. Press the [Function] button.
2. Press the [Session Partner] button.
3. Hold down the [Session Partner] button and use the [-] [+] buttons to get "chd" to appear in the display.



4. Use the [-] [+] buttons to change the setting.

Setting	Description
	Chords are displayed.
	Chords are not displayed.

## Initializing (Formatting) Memory

### Initializing Internal Memory

The FP-4 contains a storage area in which you can save your recorded performances or your registration sets. This area is called "internal memory."

If you want to erase the entire contents of internal memory and restore it to the factory-set condition, execute the following procedure.

1. Press the [Function] button.
2. Press the Track [2] button.

While you hold down the Track [2] button, the display will indicate "FMT."



When you take your finger off the Track [2] button, a confirmation message will appear.



If you press the [Play] button once again, you will return to the previous screen without initializing.

3. Press the [Rec] button.

Initialization will begin.

The entire contents of internal memory will be erased.

\* *Never turn off the power before the screen indicates "End." Doing so may destroy the FP-4's memory, rendering it unusable.*

**NOTE**

This operation will not initialize any settings other than the contents of internal memory. If you want to return settings other than internal memory to the factory-set state, please execute Factory Reset (p. 91).

## Metronome Setting

### Changing the Beat of Metronome

You can specify the time signature at which the metronome will sound.

When you record your own performance, it will be recorded with the time signature you specify here.

1. Press the [Function] button.
2. Press the [Metronome] button.



When you release your finger from the button, the currently selected time signature will be displayed.

3. Press the [-] [+] buttons to select the beat.



Indication	Beat	Indication	Beat
	2/2		6/4
	Weak beats only		7/4
	2/4		3/8
	3/4		6/8
	4/4		9/8
	5/4		12/8



When you change the rhythm or the Internal song, the beat of metronome is changed.



You cannot change the metronome beat while a song or Rhythm is being played.

## Other Settings

### Restoring the Factory-set Condition (Factory Reset)

You can restore the settings you've changed on the FP-4 to their factory-set condition. This operation is called "Factory Reset."



When you perform a Factory Reset, all the settings you have stored will be erased, and the FP-4 will return to the factory-set condition. This operation will not restore the contents of internal memory to the factory-set condition.

Refer to "Initializing Internal Memory" (p. 90).



Executing "Factory Reset" results in deletion of the registration settings. If you want to keep any data you have stored, use the "Bulk Dump" operation to save the data to an external sequencer (p. 104).

1. Turn the volume to the minimum, and press the [Power] switch to turn off the power.
2. Hold down the [Function] button, and press the [Power] switch to turn on the power.

Continue holding down the [Function] button until "Fct" appears in the display.



"Fct" appears in the display. Then, the screen goes back to normal.

## Disabling the Buttons (Panel Lock)

If you activate the Panel Lock function, buttons will not operate when they are pressed. You can use this to prevent children from inadvertently changing the settings by pressing buttons.

1. Hold down the [Function] button and press the [Equalizer] button.

The Panel Lock function will be turned on.

The following display appears.



## Releasing the Panel Lock

1. Hold down the [Function] button and press the [Equalizer] button.

The “- - -” indication will disappear from the screen.



If you have pressed a Tone button to select a tone before you activate Panel Lock, you'll be able to play the specified tone. You can't change tone while Panel Lock is active, so you'll need to select a tone before you activate Panel Lock.

## Using the V-LINK Function

Connecting the FP-4 to a V-LINK compatible image device allows you to control the images with the FP-4.



To prevent malfunction and/or damage to speakers or other devices, always turn down the volume, and turn off the power on all devices before making any connections.

### V-LINK

V-LINK ( **V-LINK** ) is functionality promoted by Roland that allows linked performance of music and visual material. By using V-LINK-compatible video equipment, visual effects can be easily linked to, and made part of the expressive elements of a performance.

## How to Use the V-LINK

1. Hold down the [Sound Control] button and press the [Equalizer] button.

The lower part of the display will show “. . .” to indicate that video control mode is active.



You can control images using the twelve keys at the left end of the keyboard.

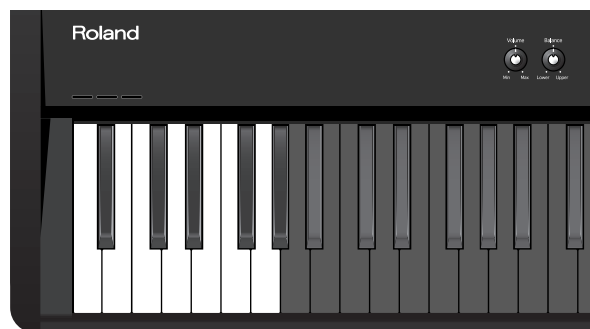

A0-A1 (lowest twelve keys)



While V-LINK is switched on, no sound is produced when you press any of the twelve keys at the left end of the keyboard.

To deactivate the V-LINK function, hold down the [Sound Control] button and press the [Equalizer] button.



# Connecting Other Equipment

<b>Connecting Audio Equipment.....</b>	<b>94</b>
Sending the Sound to External Speakers.....	94
Listening to a CD from the FP-4's Speakers.....	95
<b>Recording an FP-4 Performance to an External Device.....</b>	<b>96</b>
Recording an FP-4 Performance to a CD or Cassette Tape, etc. ....	96
Using Your Computer to Create a CD .....	97
<b>Connecting to a Computer.....</b>	<b>98</b>
Connecting to a Computer via the USB (MIDI) Connector.....	98
<b>Connecting to MIDI Devices .....</b>	<b>99</b>
What's MIDI?.....	99
Making the Connections.....	99
Using the FP-4 to Play Another MIDI Sound Module .....	100
MIDI Settings.....	100

# Connecting Audio Equipment

By connecting audio equipment to the FP-4, you can listen to its sound from the speakers of your audio system, or listen to sound from your audio system via the FP-4's speakers. To make connections, use an audio cable with 1/4" phone plugs.

- NOTE** Before connecting this unit to other devices, turn off the power to all units. This will help prevent malfunctions and/or damage to speakers or other devices.
- NOTE** Some connection cables contain resistors. Do not use cables that incorporate resistors for connecting to this unit. The use of such cables can cause the sound level to be extremely low, or impossible to hear. For information on cable specifications, contact the manufacturer of the cable.

## Sending the Sound to External Speakers

If you'll be playing the FP-4 in a larger space, such as in a concert, you can connect amplified speakers to make the sound louder.

Make connections as shown below.

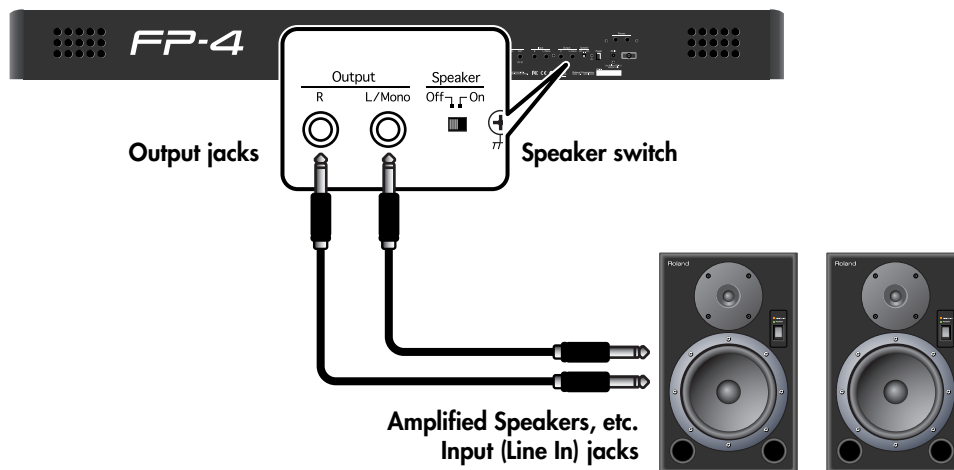

- Sound will still be heard from the FP-4's internal speakers even if you connect external speakers.  
If you don't want to hear the internal speakers, turn the [Speaker switch "Off" so that sound will be heard only from the external speakers.
- \* If headphones are connected, no sound will emanate from the FP-4's speakers even if the [Speaker] switch is in the "On" position.
- \* If you connect the FP-4 to an external device (such as an external speaker) in monaural, it may sound differently than when using a stereo connection.

## Listening to a CD from the FP-4's Speakers

If you connect your CD player or cassette tape player to the FP-4 so that the sound is heard from the FP-4's speakers, you can perform on the FP-4 while you listen to the accompaniment provided by the song of the tape cassette or CD.

Make connections as shown below.

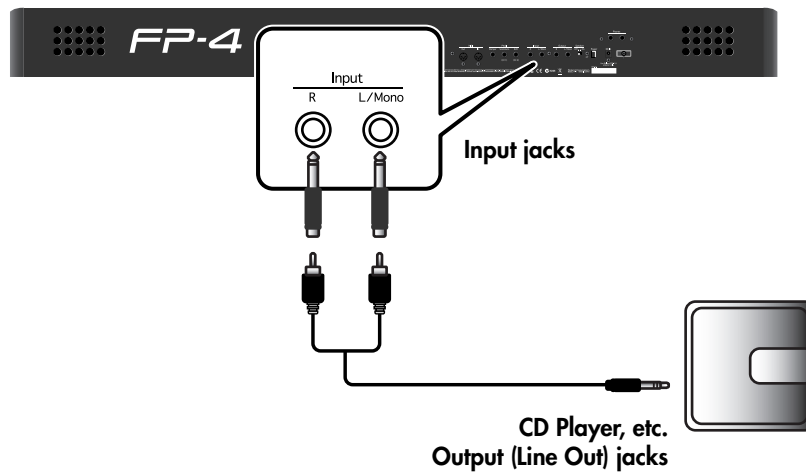

- \* If you need to change the volume of the CD, adjust the volume on the connected CD player.

# Recording an FP-4 Performance to an External Device

**NOTE** Before connecting this unit to other devices, turn off the power to all units. This will help prevent malfunctions and/or damage to speakers or other devices.

## Recording an FP-4 Performance to a CD or Cassette Tape, etc.

### Using the Roland CD-2 or Other Dedicated Unit to Create a CD

By using a Roland CD-2, you can record your FP-4 performance directly to a CD without using a computer.

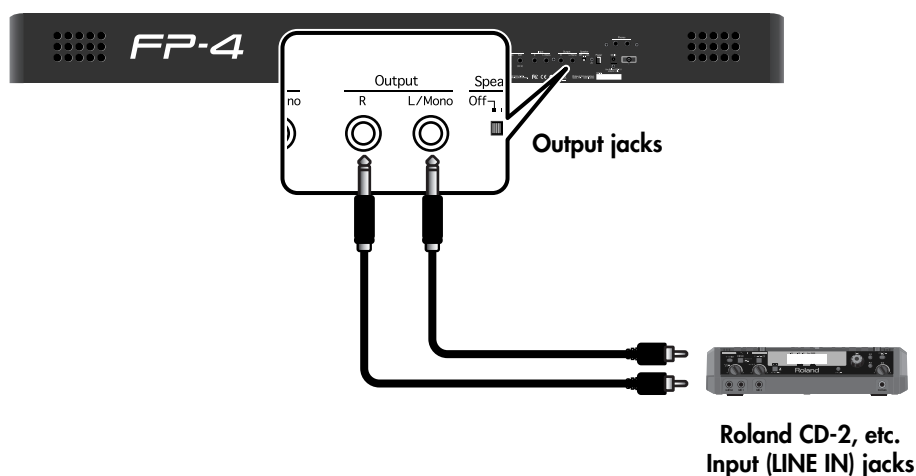

### Recording an FP-4 Performance to an Cassette Tape

You can record an FP-4 performance on cassette tape. This is a convenient way for you to check the results of your practicing or to let a friend hear your performance. Make connections as shown below.

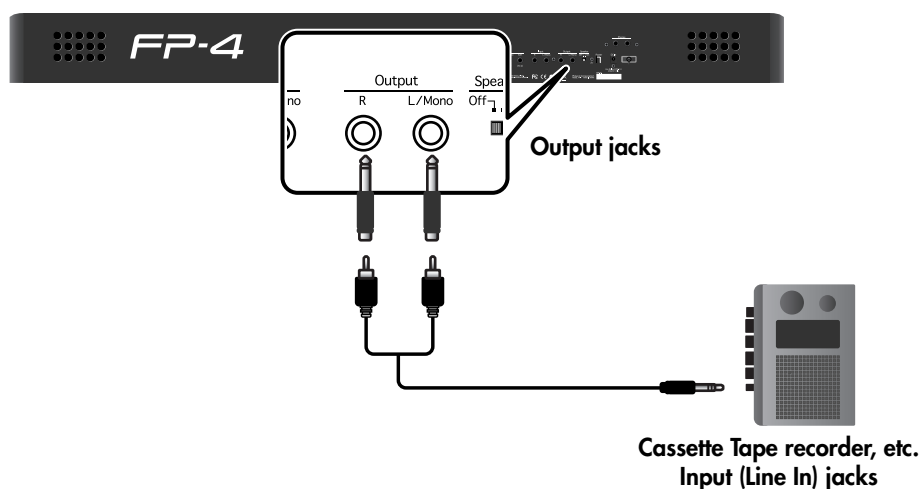

## Using Your Computer to Create a CD

In order to use your computer to record a performance from the FP-4, you'll need a drive that can write CDs, and software such as "Windows Media Player" (in Windows) or "iTunes" (in Mac OS).

**NOTE** These requirements are met by most computers today, but some versions are unable to create a CD. For details, refer to the owner's manual or online help for your software.

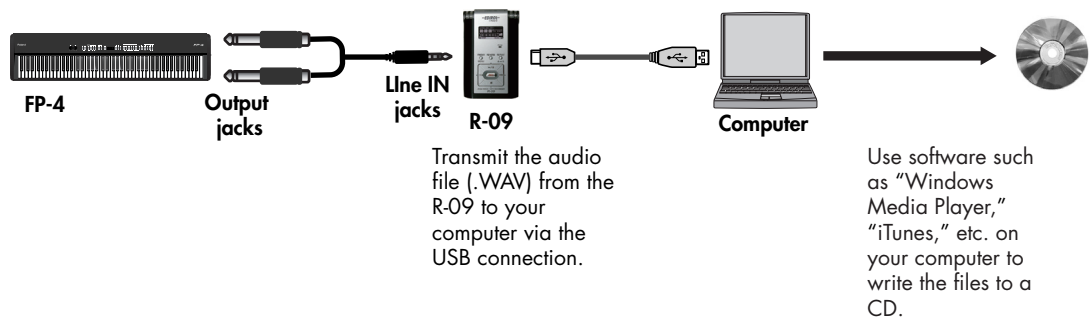
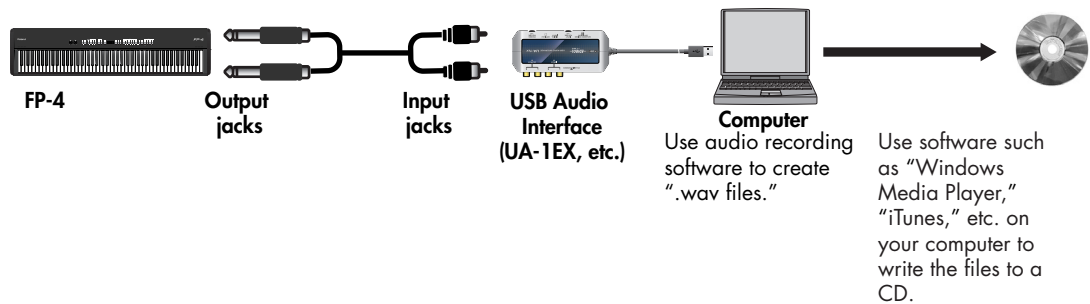

# Connecting to a Computer

## Connecting to a Computer via the USB (MIDI) Connector

If you use a USB cable (commercially available) to connect the USB (MIDI) connector located on the FP-4's rear panel to the USB connector of your computer, you'll be able to do the following things.

- Use the FP-4 to play SMF music files played back by MIDI-compatible software.
- By transferring MIDI data between the FP-4 and your sequencer software, you'll be able to enjoy a wide range of possibilities for music production and editing.

Connect the FP-4 to your computer as shown below.

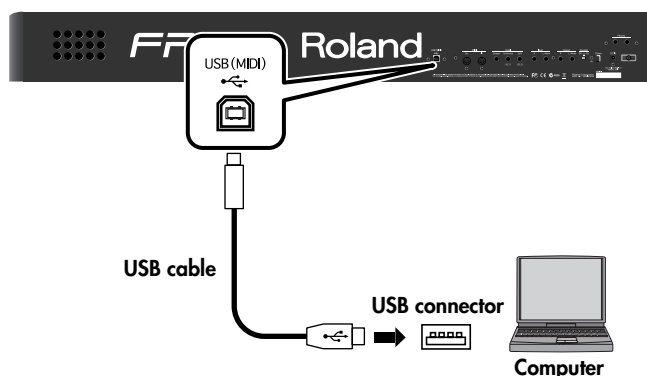

\* Refer to the Roland website for system requirements.  
Roland website: <http://www.roland.com/>

## If connection to your computer is unsuccessful...

Normally, you don't need to install a driver in order to connect the FP-4 to your computer. However, if some problem occurs, or if the performance is poor, using the Roland original driver may solve the problem.

For details on downloading and installing the Roland original driver, refer to the Roland website.

Roland website: <http://www.roland.com/>

Specify the USB driver you want to use, and then install the driver. For details, refer to "Changing the USB Driver Settings" (p. 98).

### Caution



- To avoid the risk of malfunction and/or speaker damage, always make sure to turn the volume all the way down and turn off the power on all equipment before you make any connections.
- Only MIDI data can be transmitted and received via USB.
- A USB cable is not included. If you need to obtain one, ask the dealer where you purchased the FP-4.
- Switch on power to the FP-4 before you start up the MIDI application on your computer. Don't turn the FP-4's power on/off while your MIDI application is running.

## Changing the USB Driver Settings

1. Press the [Function] button.
2. Press the [Reverb] button.
3. While holding down the [Reverb] button, use the [-] [+] buttons to make the display indicate "USB."



4. Press the [-] or [+] button to select the USB driver you want to use.

Setting	Description
 (Generic)	Choose this if you want to use the standard USB driver that was included with your computer. Normally, you should use this mode.
 (Original)	Choose this if you want to use a USB driver downloaded from the Roland website.

5. Turn the power off, then on again.

# Connecting to MIDI Devices

The FP-4 provides MIDI connectors so that performance data can be transferred between it and other devices. By using these connectors to connect other devices with the FP-4, you can take advantage of a wide range of possibilities.

## What's MIDI?

"MIDI" stands for "Musical Instrument Digital Interface." It is a universal standard that allows performance data to be exchanged among electronic musical instruments and computers. The FP-4 contains a General MIDI 2 compatible sound generator.

### General MIDI

The General MIDI is a set of recommendations which seeks to provide a way to go beyond the limitations of proprietary designs, and standardize the MIDI capabilities of sound generating devices. Sound generating devices and music files that meets the General MIDI standard bears the General MIDI logo. Music files bearing the General MIDI logo can be played back using any General MIDI sound generating unit to produce essentially the same musical performance.

### General MIDI 2

The upwardly compatible General MIDI 2 recommendations pick up where the original General MIDI left off, offering enhanced expressive capabilities, and even greater compatibility. Issues that were not covered by the original General MIDI recommendations, such as how sounds are to be edited, and how effects should be handled, have now been precisely defined. Moreover, the available sounds have been expanded. General MIDI 2 compliant sound generators are capable of reliably playing back music files that carry either the General MIDI or General MIDI 2 logo. In some cases, the conventional form of General MIDI, which does not include the new enhancements, is referred to as "General MIDI 1" as a way of distinguishing it from General MIDI 2.

## Connectors

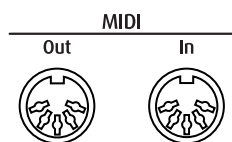

### MIDI Out Connector

Sends data about what is being played on the keyboard and other performance data.

Connect to the MIDI In connector on the external MIDI device.

### MIDI In Connector

Receives messages sent from external MIDI devices.

Connect to the MIDI Out connector on the external MIDI device.

## Making the Connections

**NOTE** To prevent malfunction and/or damage to speakers or other devices, always turn down the volume, and turn off the power on all devices before making any connections.

**NOTE** MIDI cables are not included. Consult your Roland dealer if you need to purchase.

- 1. Turn the volume all the way down on the FP-4 and the device you're about to connect.**
- 2. Turn off the power to the FP-4 and the device being connected.**
- 3. Connect a MIDI cable (sold separately) between the MIDI connectors on each device.**
- 4. Switch on the power to the FP-4 and the connected device.**
- 5. Adjust the volume level on the FP-4 and the connected device.**
- 6. You should also set the MIDI settings as needed.**

You may need to set things such as the MIDI transmit channel (p. 100) and the Local on/off setting (p. 101).

## Using the FP-4 to Play Another MIDI Sound Module

You can use the FP-4 to play sounds on another connected MIDI sound generating device (a sound module or instrument that supports the MIDI specification). This lets you layer sounds to create a richer performance, or play sounds on an external sound module that does not have a keyboard.

In order to use this type of connection, you must set the FP-4's transmit channel to match the receive channel of your external MIDI equipment (p. 100).

### Connection Example: Connection to a MIDI Sound Module

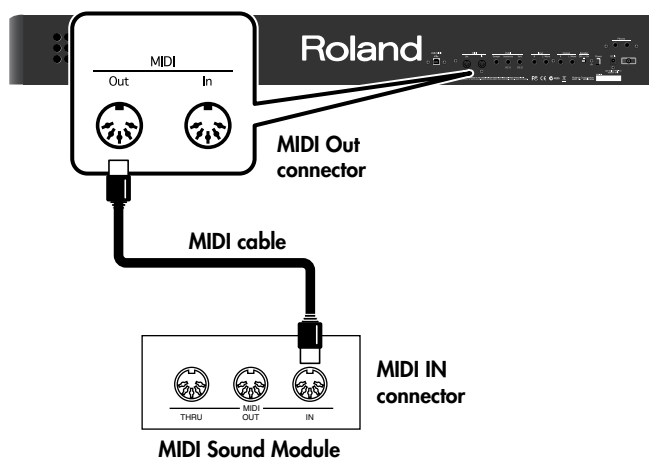

## MIDI Settings

### Matching the Channels of the FP-4 and the Connected Device (MIDI Transmit Channel)

This setting specifies the MIDI channel on which the FP-4 will transmit.

MIDI uses sixteen "MIDI channels," which are numbered 1 through 16. By connecting MIDI devices and specifying the appropriate MIDI channel for each device, you can play or select sounds on those devices.

The FP-4 will receive all sixteen channels (1–16).

1. Press the [Function] button.
2. Press the [Sound Control] button.
3. Hold down the [Sound Control] button, and press the [-] or [+] button so [U.Ch] or [L.Ch] is displayed.

Item	Description
	MIDI transmit channel of the Upper tone
	MIDI transmit channel of the Lower tone

4. Press the [-] or [+] button to select the transmission channel.

Setting (Channel)
OFF, 1–16

**NOTE**

If you choose the "OFF" setting, MIDI data will not be transmitted.

**MEMO**

For details on connecting MIDI devices, refer to "Making the Connections" (p. 99).



## Preventing Doubled Notes When Connected to a Sequencer (Local Control)

When you have a MIDI sequencer connected, set this parameter to Local Off.

Since the Thru function of your sequencer will normally be turned on, notes played on the keyboard or played back by the recorder will be transmitted to the sound generator by the two routes (1) and (2) shown in the illustration, causing notes to be sounded in duplicate or to be cut off unnaturally. To prevent this, the setting called "Local Off" is used to disconnect the route in (1).

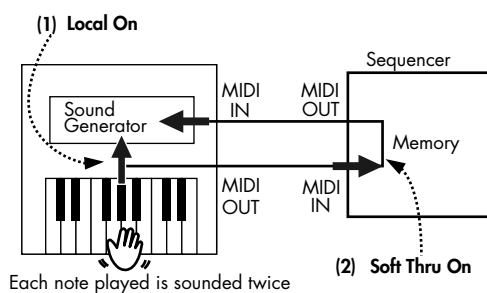

**Local On:** The keyboard and recorder are connected to the internal sound generator.

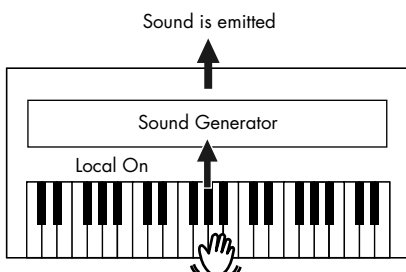

**Local Off:** The keyboard and recorder are not connected to the internal sound generator. No sound will be produced by the keyboard when it is played.

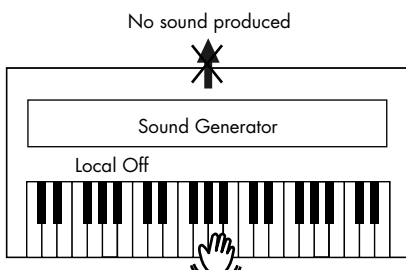

When a Roland MT series instrument is connected, it is not necessary to make the Local Off setting. The MT transmits a Local Off message when the power is turned on. If you turn on the power in the order of the FP-4 → MT series, Local Off will be set automatically.

1. Press the [Function] button.
2. Press the [Sound Control] button.
3. Hold down the [Sound Control] button, and press the [-] or [+] button so [L.Ct] is displayed.



4. Press the [-] or [+] button to change the settings.

Setting	Description
	The Local Control is set to On. The keyboard and recorder are connected to the internal sound generator.
	The Local Control is set to Off. The keyboard and recorder are not connected to the internal sound generator. Playing the keyboard or playing back a song will not produce sound.

### Transmitting Tone Change Data (Program Change Transmit Switch)

You can specify whether a tone selection message will be transmitted to the MIDI device connected to the FP-4 when you switch tones on the FP-4.

1. Press the [Function] button.
2. Press the [Sound Control] button.
3. While holding down the [Sound Control] button, use the [-] [+] buttons to make the display indicate "PC."



4. Press the [-] or [+] button to change the settings.

Setting	Description
	Tone selections you make on the FP-4 will be transmitted to the MIDI device connected to the FP-4.
	Tone selections you make on the FP-4 will not be transmitted to the MIDI device connected to the FP-4.

### Transmitting a Recorded Performance (Recorder MIDI Out)

A performance you've recorded on FP-4 can be transmitted to an external MIDI device or computer, allowing you to save the performances you record.

1. Press the [Function] button.
2. Press the [Sound Control] button.
3. While holding down the [Sound Control] button, use the [-] [+] buttons to make the display indicate "Out."



4. Press the [-] or [+] button to change the settings.

Setting	Description
	When you play back a performance that you recorded on the FP-4, the recorded performance will be transmitted to an external MIDI device or computer.
	Even if you play back a performance that you recorded on the FP-4, the recorded performance will not be transmitted to an external MIDI device or computer.

If you want your recorded performance to be saved on a MIDI sequencer such as an MT-series unit (except for the MT-90s), proceed as follows.

In this case, turn off the MIDI Thru setting of your external MIDI sequencer. For details, refer to the owner's manual of your MIDI sequencer.

- 1. Make the appropriate connections for your MT-series or other MIDI sequencer.**
- 2. Record your performance on the FP-4 (p. 65).**
- 3. Turn on the "Out" setting (p. 102).**
- 4. Start recording on your connected MIDI sequencer.**
- 5. Play back the performance that you recorded on the FP-4.**
- 6. When playback is finished, stop recording on your MIDI sequencer.**
- 7. On the connected MIDI sequencer, save the performance data that was transmitted from the FP-4.**

## Transmitting Program Changes Simultaneously with Registration Changes

You can cause program changes (PC) to be transmitted to an external MIDI device each time you switch registrations (favorite performance settings) on the FP-4.

The program change setting will be stored as part of each registration, together with the other button settings, etc.



A Program Change is a MIDI message that means "change to the Tone of the specified number." The device that receives this changes to the Tone of the corresponding number.

When you choose a Program Change message (Program Number), the Program Number will be transmitted to the MIDI device connected to the FP-4. The MIDI device that receives the Program Number changes the tone to the corresponding Program Number.



Normally, the Tone is selected from the 128 Tones available. Some MIDI devices, however, have more than 128 Tones. With such devices, the Tone is selected through a combination of Program Change messages and Bank Select messages. There are two parts of a Bank Select message: the MSB (Controller 0, with a value of 0–127) and the LSB (Controller 32, with a value of 0–127).

\* Some MIDI instruments can't handle Bank Select messages. Others can handle Bank Selects, but do not recognize the LSB part.

- 1. Press the [Function] button.**
- 2. Press the [Registration] button.**
- 3. Hold down the [Registration] button, and press the [-] or [+] button to choose the item.**

Item	Description
 (Bank Select MSB)	Specifies the Bank Select MSB that will be transmitted.
 (Bank Select LSB)	Specifies the Bank Select LSB that will be transmitted.
 (Program Change)	Specifies the Program Change number that will be transmitted.

- 4. Press the [-] or [+] button to change the settings.**

Item	Setting
 (Bank Select MSB)	0 (00)–127 (7Fh)
 (Bank Select LSB)	0 (00)–127 (7Fh)
 (Program Change)	1 (00)–128 (7Fh)

### Setting the Transmit Channel

Here's how to specify the channel on which a PC (program change) message will be transmitted to an external MIDI device when you switch registrations on the FP-4.

- 5. Hold down the [Registration] button, and press the [-] or [+] button so "Ch" is displayed.**



- 6. Press the [-] or [+] button to select the transmission channel.**

Setting (Channel)
OFF, 1–16

**NOTE** If you choose the "OFF" setting, program change will not be transmitted.

- 7. Save the setting in the registration (p. 57).**

### Transmitting Registration Set to an External Device (Bulk Dump)

The contents of the registration set can be transmitted to an external MIDI device. This type of procedure is referred to as a "bulk dump."

- 1. Connect the FP-4 to your external device.**

If you're connecting the FP-4 to an external MIDI sequencer, use a MIDI cable (sold separately) to connect the FP-4's MIDI Out connector to the MIDI In connector of your external MIDI sequencer.

→ "Connecting to MIDI Devices" (p. 99)

If you're connecting the FP-4 to a computer, use a USB cable (sold separately) to connect the FP-4's USB (MIDI) connector to your computer's USB connector.

→ "Connecting to a Computer via the USB (MIDI) Connector" (p. 98)

- 2. Press the [Function] button.**

- 3. Press the [Registration] button.**

- 4. Hold down the [Registration] button, and press the [-] or [+] button so "dMP" is displayed.**



When you take your fingers off the [Registration] button and the [-] [+] buttons, the following screen will appear.



The [Rec] button blinks.

- 5. Put your external MIDI sequencer or computer in recording mode.**

## 6. Press the [Rec] button to begin transmitting the data.

During transmission, the following will be shown in the display.



Once the transmission is over, the indication "dMP" reappears in the display.



## 7. Stop your external MIDI sequencer.

Each registration contains tone settings, dual or split performance settings, and Session Partner settings. By switching registrations, you can instantly change the FP-4's settings.

The registrations you've saved in the FP-4's internal memory can also be sent to a MIDI sequencer or computer that's connected to the FP-4. This is a convenient way to back up your registrations.

## Loading Externally Stored Registrations Back into the FP-4

### 1. Connect your external device to the FP-4.

If you're connecting the FP-4 to an external MIDI sequencer, use a MIDI cable (sold separately) to connect the FP-4's MIDI In connector to the MIDI Out connector of your external MIDI sequencer.

→ "Connecting to MIDI Devices" (p. 99)

If you're connecting the FP-4 to a computer, use a USB cable (sold separately) to connect the FP-4's USB (MIDI) connector to your computer's USB connector.

→ "Connecting to a Computer via the USB (MIDI) Connector" (p. 98)

### 2. Press the [Function] button.

### 3. Press the [Registration] button.

### 4. While holding down [Registration], use the [-] [+] buttons to make the display indicate "dMP."



When you take your fingers off the [Registration] button and the [-] [+] buttons, the following screen will appear.



The [Rec] button blinks.

### 5. Begin playback on your external device.

When playback begins on your external device, the following screen will appear.



Once the receiving is over, the indication "Sur" reappears in the display.



### 6. Stop playback on your external device.

# Troubleshooting

If you think there's a problem, read this first.

Symptom	Cause/Action	Page
<b>Power does not turn on</b>	Is the power cord connected correctly?	p. 15
<b>The button doesn't work</b>	Is Panel Lock activated? Hold down the [Function] button and press the [Equalizer] button to turn off the Panel Lock function.	p. 92
<b>Pedal does not work, or is "stuck" / Pedal does not operate correctly</b>	Is the pedal connected correctly? Plug the cord firmly into the pedal jack.	p. 18
	Are you using a pedal made by another manufacturer? Use the pedal included with the FP-4 or an optional DP Series or similar pedal.	—
	Unplugging a pedal cord from the FP-4 while the power is on may cause the pedal's effect to be applied nonstop. Be sure to switch off the power to the FP-4 before attempting to disconnect or connect a pedal cord.	—
	If you've assigned the soft pedal or sostenuto pedal as a registration select switch, or assigned it to some other function, the pedal won't operate as a soft pedal or sostenuto pedal.	p. 64 p. 82
<b>"Buzz" is heard from external devices</b>	Are the external devices connected to more than one AC power outlet? If you connect external devices, be sure to connect them to the same AC outlet.	—
<b>Device connected to the Input jacks has insufficient volume</b>	Could you be using a connection cable that contains a resistor? Use a connection cable that does not contain a resistor.	—

## No sound

<b>No sound</b>	Could the FP-4's volume or the volume of the connected equipment be turned down?	p. 17
	Could headphones be connected? Could there be a plug inserted in a headphone jack? The speakers will not produce sound if headphones or plug are connected to the headphone jacks.	p. 19
	Could the [Balance] knob be set all the way toward "Lower" or "Upper"?	p. 34
	Is the Speaker switch to "Off"? Turn it on with the Speaker switch.	p. 14
	Is Local Off set to Off? When Local Control is set to Off, no sound is produced by playing the keyboard. Set Local Control to "On."	p. 101

Symptom	Cause/Action	Page
<b>Can't hear the recorder song</b>	Could the local control setting be turned "OFF"? If the local control setting is "OFF" when you play back a song, you won't hear sound from the speakers of the FP-4.	p. 101
	Could the song volume be set to "0"?	p. 23
<b>No sound from the leftmost notes of the keyboard</b>	Is V-LINK switched on? When V-LINK is switched on, the twelve keys at the left end of the keyboard are used to control images, and no sounds are played with these keys.	p. 92
<b>No sound (when a MIDI device is connected)</b>	Are all devices powered on?	p. 99
	Are the MIDI cables connected correctly?	p. 99
	Do the MIDI channels of the FP-4 and the connected device match?	p. 100
<b>Not all the notes you play are sounded</b>	The maximum simultaneous polyphony is 128 notes. If you are playing along with a song and making heavy use of the damper pedal, the number of notes the FP-4 is attempting to produce may exceed the maximum polyphony, meaning that some of the notes will drop out.	—

**Notes don't sound right**

<b>Pitch of the keyboard or song is incorrect</b>	Could you have made Key transpose settings?	p. 39
	Is the Master Tune setting appropriate?	p. 79
	Are the settings for the Temperament correct?	p. 80
<b>Two sounds are produced when the keyboard is played</b>	Is the FP-4 in Dual Play?	p. 29
	When the FP-4 is connected to an external sequencer, set it to the Local Off mode. Alternatively, set SOFT THRU on the sequencer to "OFF."	p. 101
<b>Effect does not apply</b>	You can specify which part is to have priority when the effects assigned to the Upper Tone and Lower Tone differ in Dual Play or Split Play.	p. 84
<b>Reverberation remains even if you defeat the Reverb effect</b>	The FP-4's piano sound faithfully simulates the depth and resonance of an acoustic piano, and this may give the impression of reverberation even if you've defeated the Reverb effect.	—
<b>The sound of the higher notes suddenly changes from a certain key</b>	On an acoustic piano, the approximately one and a half octaves of notes at the top of the keyboard will continue sounding regardless of the damper pedal. These notes also have a somewhat different tonal character. FP-4 faithfully simulate this characteristic of acoustic pianos. On the FP-4, the range that is unaffected by the damper pedal will change according to the key control setting.	—

## Troubleshooting

Symptom	Cause/Action	Page
<b>High-pitched ringing is heard</b>	<p>If you hear this in headphones: Piano sounds that have a brilliant and crisp character contain substantial high-frequency components that may sound as though a metallic ringing has been added. This is because the character of an actual piano is being faithfully reproduced, and is not a malfunction. This ringing is more obtrusive if the reverb effect is applied heavily, so you may be able to minimize it by decreasing the reverb.</p> <p>If you don't hear this in headphones: It is likely that there is some other reason (such as resonances within the unit). Please contact your dealer or a nearby Roland service center.</p>	—
<b>Low notes sound wrong, or are buzzy</b>	<p>If you don't hear this in headphones: Performing at high volumes may cause the speakers or objects near the FP-4 to resonate. Fluorescent lights or glass doors may also resonate sympathetically. In particular, this is more likely to occur for lower notes and higher volumes. You can take the following measures to minimize resonances.</p> <ul style="list-style-type: none"> <li>• Locate the speakers 10–15 cm away from walls or other surfaces.</li> <li>• Keep the volume down.</li> <li>• Move away from the objects that are resonating.</li> </ul> <p>If you hear this in headphones: It is likely that there is some other reason. Please contact your dealer or a nearby Roland service center.</p>	—
	<p>With certain tones, the sounds may seem to be distorted. Turn down the volume. Alternatively, lower the master gain setting.</p>	
<b>Song does not play correctly</b>		
<b>Song won't play</b>	<p>Does "dEL" appear in the display? You cannot play back an internal preset song if memory contains an unsaved song. Try playing back the song after deleting the performance data.</p>	p. 26
<b>Only the sound of a particular instrument in a song does not play</b>	<p>Is Track Mute on? The track mute volume is set to "0," the music on that track is not heard.</p>	p. 25
<b>Even though you've pressed a track button and turned off its light (Track Muted), you still hear the sound of that track</b>	<p>Could you have changed the track mute volume?</p>	p. 26
<b>Can't record / play back</b>		
<b>Can't record</b>	<p>You can't record while a notation is being generated. When the notation has been generated (the measure numbers in the screen are no longer highlighted), try the operation once again.</p>	—



Symptom	Cause/Action	Page
<b>The recorded performance disappeared</b>	Your recorded performance will disappear if you switch off the FP-4's power or select a song. There is no way to recover the lost performance. Before you turn off the power, save your recorded performance in internal memory.	p. 76
<b>Tempo of recorded song or metronome is off</b>	If you select an internal song in which the tempo changes during the song, and then record, the tempo will change in the same way for the performances that are recorded on the other tracks. The tempo of the metronome will also change in the same way.	—
	If you record additional material without erasing the previously recorded song, the song will be recorded at the first-recorded tempo. Please erase the previously recorded song before you re-record.	p. 77

# Error Messages

Indication	Meaning
<b>E11</b>	There is not sufficient free memory in the save destination. Delete unneeded files (Songs or Registration Sets) you've saved in internal memory and try again.
<b>E14</b>	An error occurred during writing. The internal memory may be corrupted. Initialize the internal memory.
<b>E15</b>	The file is unreadable. The data format is not compatible with the FP-4.
<b>E16</b>	Data was not called up in time for playback of the song. After waiting several seconds, you may be able to play back the song by pressing the [Play] button again.
<b>E30</b>	The internal memory capacity of the FP-4 is full.
<b>E40</b>	The FP-4 cannot deal with the excessive MIDI data sent from the external MIDI device. Reduce the amount of MIDI data sent to the FP-4.
<b>E41</b>	A MIDI cable has been disconnected. Connect it properly and securely.
<b>E43</b>	A MIDI transmission error has occurred. Check the MIDI cable and connected MIDI device.
<b>E51</b>	There may be a problem with the system. Repeat the procedure from the beginning. If it is not solved after you have tried several times, contact the Roland service center.

Indication	Meaning
<b>USR</b>	User Song. Stores recorded performances (p. 66, p. 67, p. 71). Recorded Chord Progression Pattern
<b>USR.</b>	The "." in the display indicates that there is performance material already recorded (p. 67, p. 71).
<b>P01</b>	Internal (preset) song number (p. 22)
<b>U01</b>	Song number of the internal memory (p. 27)
<b>r01</b>	Rhythm number (p. 48)
<b>DEL</b>	This appears when you attempt to delete a recorded song (p. 26, p. 65, p. 75).
<b>rGE</b>	Registration
<b>Fnc</b>	Function
<b>PU</b>	This appears when a song with a pickup (a song that does not start on the first beat) is played back.
<b>120</b>	V-LINK function is On (p. 92).
<b>---</b>	Panel Lock function is On (p. 92).

\* Error messages are indicated by an "E." before the number. Press [Display] button, and you can cancel the error message.

# Tone List

## Piano

- 1 Grand Piano1
- 2 Piano + Str.
- 3 Grand Piano2
- 4 Piano + Pad
- 5 Grand Piano3
- 6 MagicalPiano
- 7 Rock Piano
- 8 Piano+Choir
- 9 Honky-tonk
- 10 Harpsichord
- 11 Coupled Hps.

## E.Piano

- 1 Vintage EP
- 2 Pop E.Piano
- 3 '60s E.Piano
- 4 FM E.Piano
- 5 '70s E.Piano
- 6 Stage Phaser
- 7 E.Grand
- 8 Clav.
- 9 Vibraphone
- 10 Marimba
- 11 Celesta
- 12 Mallet Isle
- 13 Morning Lite
- 14 EP Belle
- 15 Ballad Bells

## Organ

- 1 Combo Jz.Org
- 2 Ballad Organ
- 3 Gospel Spin
- 4 Full Stops
- 5 Mellow Bars
- 6 Light Organ
- 7 Lower Organ
- 8 Purple Spin
- 9 '60s Organ
- 10 ChurchOrgan1
- 11 ChurchOrgan2
- 12 Nason flt 8'
- 13 Accordion

## Strings/Pad

- 1 Rich Strings
- 2 OrchestraStr
- 3 Velo Strings
- 4 DecayStrings \*1
- 5 SynthStrings
- 6 Soft Pad
- 7 Glass Pad
- 8 Silky Way
- 9 Lunar Strngs
- 10 Dcy ChoirPad \*1
- 11 Orchestra
- 12 OrchestraBrS
- 13 Harp

## Guitar/Bass

- 1 Nylon-str.Gt
- 2 Steel-str.Gt
- 3 Clean Guitar
- 4 Jazz Guitar
- 5 Overdrive Gt
- 6 AcousticBass
- 7 A.Bass+CymbI
- 8 FingeredBass
- 9 FretlessBass
- 10 Slap Bass
- 11 Synth Bass
- 12 Thum Voice

## Voice/GM2

- 1 Aerial Choir
- 2 Jazz Scat
- 3 Female Aahs
- 4 Angels Choir
- 5 Beauty Vox
- 6 Male Aahs
- 7 Harpvox
- 8 Decay Choir \*1
- 9 Alto Sax
- 10 Tenor Sax
- 11 BrassSection
- 12 Flute
- 13 ChamberWinds

## GM2

- 14 STANDARD Set
- 15 ROOM Set
- 16 POWER Set
- 17 ELEC.Set
- 18 ANALOG Set
- 19 JAZZ Set
- 20 BRUSH Set
- 21 ORCH.Set
- 22 SFX Set

\* 14–22 are drum/SFX sets.  
Refer to p. 113–p. 115 for  
details on the sounds in the  
drum/SFX sets.

- 23 Piano 1
- 24 Piano 1w
- 25 Piano 1d
- 26 Piano 2
- 27 Piano 2w
- 28 Piano 3
- 29 Piano 3w
- 30 Honky-tonk
- 31 Honky-tonk w
- 32 E.Piano 1
- 33 Detuned EP 1
- 34 Vintage EP
- 35 '60s E.Piano
- 36 E.Piano 2
- 37 Detuned EP 2
- 38 St.FM EP
- 39 EP Legend
- 40 EP Phase
- 41 Harpsichord
- 42 Coupled Hps.

- 43 Harpsi.w
- 44 Harpsi.o
- 45 Clav.
- 46 Pulse Clav.
- 47 Celesta
- 48 Glockenspiel
- 49 Music Box
- 50 Vibraphone
- 51 Vibraphone w
- 52 Marimba
- 53 Marimba w
- 54 Xylophone
- 55 TubularBells
- 56 Church Bell
- 57 Carillon
- 58 Santur
- 59 Organ 1
- 60 TremoloOrgan
- 61 '60s Organ
- 62 Organ 2
- 63 Perc.Organ 1
- 64 Chorus Organ
- 65 Perc.Organ 2
- 66 Rock Organ
- 67 Church Org.1
- 68 Church Org.2
- 69 Church Org.3
- 70 Reed Organ
- 71 Puff Organ
- 72 Accordion 1
- 73 Accordion 2
- 74 Harmonica
- 75 Bandoneon
- 76 Nylon-str.Gt
- 77 Ukulele
- 78 Nylon Gt o
- 79 Nylon Gt 2
- 80 Steel-str.Gt
- 81 12-str.Gt
- 82 Mandolin
- 83 Steel+Body
- 84 Jazz Guitar
- 85 Hawaiian Gt
- 86 Clean Guitar
- 87 Chorus Gt 1
- 88 Mid Tone Gt
- 89 Muted Guitar
- 90 Funk Guitar1
- 91 Funk Guitar2
- 92 Chorus Gt 2



	STANDARD Set	ROOM Set	POWER Set	ELEC.Set
28	27 High-Q Slap	High-Q Slap	High-Q Slap	High-Q Slap
29	Scratch Push [EXC7]	Scratch Push [EXC7]	Scratch Push [EXC7]	Scratch Push [EXC7]
30	Scratch Pull [EXC7]	Scratch Pull [EXC7]	Scratch Pull [EXC7]	Scratch Pull [EXC7]
31	Sticks	Sticks	Sticks	Sticks
32	Square Click	Square Click	Square Click	Square Click
33	Metronome Click	Metronome Click	Metronome Click	Metronome Click
34	Metronome Bell	Metronome Bell	Metronome Bell	Metronome Bell
35	Kick Drum 2	Room Kick 2	Room Kick 1	Power Kick
C2 36	Kick Drum 1	Room Kick 1	Power Kick	Electric Kick
37	Side Stick	Side Stick	Side Stick	Side Stick
38	Snare Drum	Room Snare	Power Snare	Electric Snare 1
39	Hand Clap	Hand Clap	Hand Clap	Hand Clap
40	Electric Snare 3	Electric Snare 4	Electric Snare 5	Electric Snare 2
41	Low Tom 2	Room Low Tom 2	Power Low Tom 2	Electric Low Tom 2
42	Closed Hi-Hat 1 [EXC1]	Closed Hi-Hat 2 [EXC1]	Closed Hi-Hat 2 [EXC1]	Closed Hi-Hat 2 [EXC1]
43	Low Tom 1	Room Low Tom 1	Power Low Tom 1	Electric Low Tom 1
44	Pedal Hi-Hat 1 [EXC1]	Pedal Hi-Hat 2 [EXC1]	Pedal Hi-Hat 2 [EXC1]	Pedal Hi-Hat 2 [EXC1]
45	Mid Tom 2	Room Mid Tom 2	Power Mid Tom 2	Electric Mid Tom 2
46	Open Hi-Hat 1 [EXC1]	Open Hi-Hat 2 [EXC1]	Open Hi-Hat 2 [EXC1]	Open Hi-Hat 2 [EXC1]
47	Mid Tom 1	Room Mid Tom 1	Power Mid Tom 1	Electric Mid Tom 1
C3 48	High Tom 2	Room High Tom 2	Power High Tom 2	Electric High Tom 2
49	Crash Cymbal 1	Crash Cymbal 3	Crash Cymbal 3	Crash Cymbal 3
50	High Tom 1	Room High Tom 1	Power High Tom 1	Electric High Tom 1
51	Ride Cymbal 1	Ride Cymbal 3	Ride Cymbal 3	Ride Cymbal 3
52	Chinese Cymbal 1	Chinese Cymbal 2	Chinese Cymbal 2	Reverse Cymbal
53	Ride Bell 1	Ride Bell 2	Ride Bell 2	Ride Bell 2
54	Tambourine	Tambourine	Tambourine	Tambourine
55	Splash Cymbal	Splash Cymbal	Splash Cymbal	Splash Cymbal
56	Cowbell	Cowbell	Cowbell	Cowbell
57	Crash Cymbal 2	Crash Cymbal 4	Crash Cymbal 4	Crash Cymbal 4
58	Vibraslap	Vibraslap	Vibraslap	Vibraslap
59	Ride Cymbal 2	Ride Cymbal 4	Ride Cymbal 4	Ride Cymbal 4
C4 60	High Bongo 1	High Bongo 2	High Bongo 2	High Bongo 2
61	Low Bongo 1	Low Bongo 2	Low Bongo 2	Low Bongo 2
62	Mute High Conga 1	Mute High Conga 2	Mute High Conga 2	Mute High Conga 2
63	Open High Conga	Open High Conga	Open High Conga	Open High Conga
64	Low Conga	Low Conga	Low Conga	Low Conga
65	High Timbale	High Timbale	High Timbale	High Timbale
66	Low Timbale	Low Timbale	Low Timbale	Low Timbale
67	High Agogo	High Agogo	High Agogo	High Agogo
68	Low Agogo	Low Agogo	Low Agogo	Low Agogo
69	Cabasa	Cabasa	Cabasa	Cabasa
70	Maracas	Maracas	Maracas	Maracas
71	Short High Whistle [EXC2]	Short High Whistle [EXC2]	Short High Whistle [EXC2]	Short High Whistle [EXC2]
C5 72	Long Low Whistle [EXC2]	Long Low Whistle [EXC2]	Long Low Whistle [EXC2]	Long Low Whistle [EXC2]
73	Short Guiro [EXC3]	Short Guiro [EXC3]	Short Guiro [EXC3]	Short Guiro [EXC3]
74	Long Guiro [EXC3]	Long Guiro [EXC3]	Long Guiro [EXC3]	Long Guiro [EXC3]
75	Claves	Claves	Claves	Claves
76	High Woodblock	High Woodblock	High Woodblock	High Woodblock
77	Low Woodblock	Low Woodblock	Low Woodblock	Low Woodblock
78	Mute Cuica [EXC4]	Mute Cuica [EXC4]	Mute Cuica [EXC4]	Mute Cuica [EXC4]
79	Open Cuica [EXC4]	Open Cuica [EXC4]	Open Cuica [EXC4]	Open Cuica [EXC4]
80	Mute Triangle [EXC5]	Mute Triangle [EXC5]	Mute Triangle [EXC5]	Mute Triangle [EXC5]
81	Open Triangle [EXC5]	Open Triangle [EXC5]	Open Triangle [EXC5]	Open Triangle [EXC5]
82	Shaker	Shaker	Shaker	Shaker
83	Jingle Bell	Jingle Bell	Jingle Bell	Jingle Bell
C6 84	Bar Chimes	Bar Chimes	Bar Chimes	Bar Chimes
85	Castanets	Castanets	Castanets	Castanets
86	Mute Surdo [EXC6]	Mute Surdo [EXC6]	Mute Surdo [EXC6]	Mute Surdo [EXC6]
87	Open Surdo [EXC6]	Open Surdo [EXC6]	Open Surdo [EXC6]	Open Surdo [EXC6]
88	-----	-----	-----	-----

\* -----: No sound.

\* [EXC]: will not sound simultaneously with other percussion instruments of the same number.

# Tone List

	ANALOG Set	JAZZ Set	BRUSH Set	ORCH.Set
27	High-Q	High-Q	High-Q	Closed Hi-Hat 2 [EXC1]
28	Slap	Slap	Slap	Pedal Hi-Hat 2 [EXC1]
29	Scratch Push [EXC7]	Scratch Push [EXC7]	Scratch Push [EXC7]	Open Hi-Hat 2 [EXC1]
30	Scratch Pull [EXC7]	Scratch Pull [EXC7]	Scratch Pull [EXC7]	Ride Cymbal 3
31	Sticks	Sticks	Sticks	Sticks
32	Square Click	Square Click	Square Click	Square Click
33	Metronome Click	Metronome Click	Metronome Click	Metronome Click
34	Metronome Bell	Metronome Bell	Metronome Bell	Metronome Bell
35	TR-808 Kick 2	Room Kick 2	Room Kick 2	Concert Bass Drum 2
C36	TR-808 Kick 1	Jazz Kick	Jazz Kick	Concert Bass Drum 1
37	TR-808 Rim shot	Side Stick	Side Stick	Side Stick
38	TR-808 Snare	Jazz Snare	Brush Tap	Concert Snare Drum
39	Hand Clap	Hand Clap	Brush Slap1	Castanets
40	Electric Snare 6	Electric Snare 7	Brush Swirl	Concert Snare Drum
41	TR-808 Low Tom 2	Jazz Low Tom	Brush Low Tom 2	Timpani F
42	TR-808 Closed Hi-Hat 1 [EXC1]	Closed Hi-Hat 2 [EXC1]	Brush Closed Hi-Hat [EXC1]	Timpani F#
43	TR-808 Low Tom 1	Low Tom 1	Brush Low Tom 1	Timpani G
44	TR-808 Closed Hi-Hat 2 [EXC1]	Pedal Hi-Hat 2 [EXC1]	Brush Pedal Hi-Hat [EXC1]	Timpani G#
45	TR-808 Mid Tom 2	Mid Tom 2	Brush Mid Tom 2	Timpani A
46	TR-808 Open Hi-Hat [EXC1]	Open Hi-Hat 2 [EXC1]	Brush Open Hi-Hat [EXC1]	Timpani A#
47	TR-808 Mid Tom 1	Jazz Mid Tom	Brush Mid Tom 1	Timpani B
C48	TR-808 High Tom 2	Jazz High Tom 2	Brush High Tom 2	Timpani C
49	TR-808 Crash Cymbal	Crash Cymbal 3	Jazz Crash Cymbal	Timpani C#
50	TR-808 High Tom 1	Jazz High Tom 1	Brush High Tom 1	Timpani D
51	Ride Cymbal 3	Ride Cymbal 3	Jazz Ride Cymbal 1	Timpani D#
52	Chinese Cymbal 2	Chinese Cymbal 2	Chinese Cymbal 2	Timpani E
53	Ride Bell 2	Ride Bell 2	Jazz Ride Cymbal 2	Timpani F
54	Tambourine	Tambourine	Tambourine	Tambourine
55	Splash Cymbal	Splash Cymbal	Splash Cymbal	Splash Cymbal
56	TR-808 Cowbell	Cowbell	Cowbell	Cowbell
57	Crash Cymbal 4	Crash Cymbal 4	Crash Cymbal 4	Concert Cymbal 2
58	Vibraslap	Vibraslap	Vibraslap	Vibraslap
59	Ride Cymbal4	Ride Cymbal4	Ride Cymbal4	Concert Cymbal 1
C60	High Bongo 2	High Bongo 2	High Bongo 2	High Bongo 2
61	Low Bongo 2	Low Bongo 2	Low Bongo 2	Low Bongo 2
62	TR-808 High Conga	Mute High Conga 2	Mute High Conga 2	Mute High Conga 2
63	TR-808 Mid Conga	Open High Conga	Open High Conga	Open High Conga
64	TR-808 Low Conga	Low Conga	Low Conga	Low Conga
65	High Timbale	High Timbale	High Timbale	High Timbale
66	Low Timbale	Low Timbale	Low Timbale	Low Timbale
67	High Agogo	High Agogo	High Agogo	High Agogo
68	Low Agogo	Low Agogo	Low Agogo	Low Agogo
69	Cabasa	Cabasa	Cabasa	Cabasa
70	TR-808 Maracas	Maracas	Maracas	Maracas
71	Short High Whistle [EXC2]	Short High Whistle [EXC2]	Short High Whistle [EXC2]	Short High Whistle [EXC2]
C72	Long Low Whistle [EXC2]	Long Low Whistle [EXC2]	Long Low Whistle [EXC2]	Long Low Whistle [EXC2]
73	Short Guiro [EXC3]	Short Guiro [EXC3]	Short Guiro [EXC3]	Short Guiro [EXC3]
74	Long Guiro [EXC3]	Long Guiro [EXC3]	Long Guiro [EXC3]	Long Guiro [EXC3]
75	Claves	Claves	Claves	Claves
76	High Woodblock	High Woodblock	High Woodblock	High Woodblock
77	Low Woodblock	Low Woodblock	Low Woodblock	Low Woodblock
78	Mute Cuica [EXC4]	Mute Cuica [EXC4]	Mute Cuica [EXC4]	Mute Cuica [EXC4]
79	Open Cuica [EXC4]	Open Cuica [EXC4]	Open Cuica [EXC4]	Open Cuica [EXC4]
80	Mute Triangle [EXC5]	Mute Triangle [EXC5]	Mute Triangle [EXC5]	Mute Triangle [EXC5]
81	Open Triangle [EXC5]	Open Triangle [EXC5]	Open Triangle [EXC5]	Open Triangle [EXC5]
82	Shaker	Shaker	Shaker	Shaker
83	Jingle Bell	Jingle Bell	Jingle Bell	Jingle Bell
C84	Bar Chimes	Bar Chimes	Bar Chimes	Bar Chimes
85	Castanets	Castanets	Castanets	Castanets
86	Mute Surdo [EXC6]	Mute Surdo [EXC6]	Mute Surdo [EXC6]	Mute Surdo [EXC6]
87	Open Surdo [EXC6]	Open Surdo [EXC6]	Open Surdo [EXC6]	Open Surdo [EXC6]
88	-----	-----	-----	Applause

\* -----: No sound.

\* [EXC]: will not sound simultaneously with other percussion instruments of the same number.

SFX Set	
28	27 -----
	-----
29	30 -----
31	-----
	32 -----
33	-----
	34 -----
35	-----
C2	36 -----
	37 -----
38	-----
	39 High Q
40	Slap
	Scratch Push [EXC7]
41	Scratch Pull [EXC7]
	42 Sticks
43	44 Square Click
45	Metronome Click
	46 Metronome Bell
47	Guitar Fret Noise
C3	Guitar Cutting Noise Up
48	Guitar Cutting Noise Down
	50 String Slap of Double Bass
	51 Fl.Key Click
52	Laughing
	Screaming
53	54 Punch
55	Heart Beat
	56 Footsteps 1
57	Footsteps 2
	58 Applause
59	Door Creaking
C4	Door
60	61 Scratch
62	Wind Chimes
	63 Car-Engine
64	Car-Stop
	Car-Pass
65	66 Car-Crash
67	Siren
	68 Train
69	Jet Plane
	70 Helicopter
71	Starship
C5	Gun Shot
72	73 Machine Gun
74	Laser Gun
	75 Explosion
76	Dog
	Horse-Gallop
77	78 Birds
79	Rain
	80 Thunder
81	Wind
	82 Seashore
83	Stream
C6	Bubble
84	85 -----
86	-----
	87 -----
88	-----

\* -----: No sound.

\* [EXC]: will not sound simultaneously with other percussion instruments of the same number.

# Rhythm List

No.	Style Name	Chord	Tempo
1	8-Beat Funk	16	108
2	Guitar Funk	19	104
3	8-Beat Pop 1	26	108
4	Street Pop	51	94
5	8-Beat Rock 1	52	128
6	Loose Rock	13	174
7	Ballad	39	82
8	R&B Ballad	41	60
9	Fast Jazz 1	36	128
10	Jazz	35	136
11	8-Bt Fusion 1	23	113
12	Fusion	21	95
13	Latin Fusion	48	125
14	Latin Pop	47	150
15	16-BeatFunk 1	24	120
16	16-BeatFunk 2	38	110
17	Slow Funk	33	85
18	Y2K Funk	16	103
19	Cutting Gt	20	100
20	'70s Soul	22	96
21	16-Beat Pop	14	116
22	8-Bt Shuffle	28	96
23	S.Street Pop	51	94
24	Pop	17	100
25	S.Pop	17	100
26	Contemporary	23	93
27	Medium Pop	24	86
28	S.Medium Pop	24	86
29	8-Beat Pop 2	14	126
30	S.8-Bt Pop 2	14	126
31	Piano Pop	52	116
32	S.Piano Pop	52	116
33	Guitar Pop	26	132
34	Country Pop	27	98
35	Shuffle	28	116
36	S.Shuffle	28	116
37	Smooth Pop	53	88
38	8-Beat Rock 2	19	106
39	S.8-Bt Rock 2	19	106
40	8-Beat Rock 3	29	140

No.	Style Name	Chord	Tempo
41	S.8-Bt Rock 3	29	140
42	16-BeatRock 1	53	142
43	16-BeatRock 2	54	86
44	Bounce Rock	11	105
45	S.BounceRock	11	105
46	Gt Ballad	12	80
47	S.Gt Ballad	12	80
48	E.Piano Bld	40	67
49	808 Ballad	42	65
50	New Age Bld	43	66
51	S.NewAge Bld	43	66
52	6/8 Ballad	44	178
53	Piano Ballad	55	64
54	Piano Waltz	50	90
55	Jazz Brush	37	60
56	S.Jazz	35	136
57	Fast Jazz 2	34	220
58	W Time Feel	36	140
59	S.WTime Feel	36	140
60	Scat Swing	37	120
61	Piano Jazz	38	110
62	Jazz Waltz	56	90
63	8-Bt Fusion 2	25	112
64	16-Bt Fusion	21	124
65	Fast Bossa	47	110
66	Bossa Nova	48	125
67	Salsa	45	92
68	Latin	46	116
69	S.Latin	46	116
70	Mambo	45	92
71	Beguine	49	105
72	Hip Hop	18	98
73	808 Hip Hop	25	102
74	S.808 HipHop	25	102
75	Euro Dance	15	135
76	Honky Pop	32	185
77	S.Honky Pop	32	185
78	Boogie	33	170
79	Gospel	30	120
80	Gospel Shout	31	150



# Chord Progression Pattern List

It is the Chord Progression Pattern List by each measure. These are basic chord progression pattern from No. 1 to No. 10, and these are suitable chord progression for the internal rhythm from No. 11 to No. 56.

No.	Rhythm Pattern	Chord Progression															
		1	2	3	4	5	6	7	8	9	10	11	12	13	14	15	16
1	Orig/ Vari	C	Am	Dm7	G7	C	Am	Dm7	G7								
2	Orig/ Vari	Am	G	F	E7	Am	G	F	E7								
3	Orig/ Vari	CM7	Am7	Dm7	G7	CM7	Am7	Dm7	G7								
4	Orig/ Vari	Dm7	G7	CM7	Am7	Dm7	G7	CM7	A7								
5	Orig/ Vari	C	Bm7	Em7	Am	F	G	Csus4	C								
6	Orig/ Vari	Dm7	G7	CM7	FM7	Bm7♭5	E7	Am7	A7								
7	Orig/ Vari	C7	F7	C7	→	F7	→	C7	→	G7	F7	C7	G7				
8	Orig/ Vari	CM7	→	Cdim	→	Dm9	G7	CM7	Dm9	CM7	→	Cdim	→	Dm9	G7	CM7	→
9	Orig/ Vari	C	→	Am7	→	Dm7	→	G7sus4	→								
10	Orig/ Vari	C	C/B	Am	Am/G	F	G	C	→								
11	Orig	C	C7sus4	F	B♭7sus4	C	C7sus4	F	Fm6								
	Vari	Am	E7	C7	F	Fm6	Em7	F	G								
12	Orig	Dm	G7	C	A7	Dm	G7	Am	D7								
	Vari	F	G	C	C7sus4	F	G	Am	A7								
13	Orig	Am	→	G	Am	→	→	F	D								
	Vari	D	→	C	D	→	→	F	G								
14	Orig	C	→	E♭7	F7	C	→	E♭7	B♭								
	Vari	C7sus4	C7	B♭7sus4	B♭7	C7sus4	C7	A♭7sus4	B♭7sus4								
15	Orig	Am	→	D	→	Am	→	G	→								
	Vari	C	→	B♭	→	C	→	E♭	G								
16	Orig	F	→	B♭	→	F	→	B♭	→								
	Vari	Dm	C	Dm	C	B♭	→	Gm	C								
17	Orig	C	Gm7	FM7	B♭7	C	Gm7	F	F/G								
	Vari	FM9	F/G	C	Am7	FM9	F/G	B♭7	F/G								
18	Orig	C	B♭	C	Gm7	C	B♭	C	Gm7								
	Vari	C	G7	C	G7	C	G7	C	B♭								
19	Orig	C	Am7	Dm7	G7	C	Am7	Dm7	G7								
	Vari	FM7	→	CM7	Am7	FM7	Fm7	F/G	→								
20	Orig	Am7	D7	Am7	D7	Am7	D7	Am7	F/G								
	Vari	C	→	Am7	→	C	→	F/G	→								
21	Orig	CM9	A♭M7	CM9	A♭M7	CM9	A♭M7	FM9	F/G								
	Vari	A♭M9	→	B♭9	→	A♭M9	→	B♭9	→								
22	Orig	CM9	→	Am9	→	CM9	→	Am9	→	FM9	→	G6	→				
	Vari	FM9	G6	FM9	G6	FM9	G6	FM9	G6	CM9	→	F/G	→				

# Chord Progression Pattern List

No.	Rhythm Pattern	Chord Progression															
		1	2	3	4	5	6	7	8	9	10	11	12	13	14	15	16
23	Orig	C	→	FM7	→	C	→	F/G	→								
	Vari	Dm7	G7	C	Am7	Dm7	G7	C	→								
24	Orig	C	→	G	→	G7	→	C	C7	F	→	C	Am7	Dm7	G	C	C7
	Vari	FM7	→	G	→	FM7	→	G	→	FM7	→	G	G7	C	→	→	F/G
25	Orig	Am7	D7	Am7	D7	Gm7	C7	Gm7	E7#9								
	Vari	Am7	D7sus4	Am7	D7	FM7	E7#9	Am7	BbM7								
26	Orig	CM7	→	Am7	→	Dm7	→	G7	→								
	Vari	C	→	F	→	Dm	→	G	→	C	→	F	→	G	→	C	→
27	Orig	C	Am	C	Am	C	Am	F	G								
	Vari	C	G	F	G	C	G	F	G7								
28	Orig	C	→	→	→	F7sus4	F7	G7sus4	G7								
	Vari	FM7	G7	C	→	FM7	G7	C	→								
29	Orig	C	→	G	→	C	→	G	→								
	Vari	F	Am	G7	Dm7	F	Am7	G7	→								
30	Orig	C	→	Fm7	→	C	D <sup>b</sup> dim (C#dim)	Dm7	G7								
	Vari	F	G <sup>b</sup> dim (F#dim)	C/G	A7	D7	→	G7	→								
31	Orig	C	→	→	→	→	→	→	→	F	C	F	C	F	C	G7	→
	Vari	C	→	→	→	→	→	C7	→	G	→	F7	→	G7	→	F7	G7
32	Orig	C	→	→	→	F	→	G	→								
	Vari	F	→	C	→	F	→	G	→								
33	Orig	A7	D7	A7	→	D7	→	A7	→	E7	D7	A7	E7				
	Vari	C	F	C	C7	F7	→	C	A7	D7	G7	C	G7				
34	Orig	F	C7	Am7	C7	F7	Bb7	F/C	C7								
	Vari	A7	→	D7	→	G7	→	C7	→								
35	Orig	C6	→	Dm7	G7	Dm7	G7	C6	→	Am	Am9	Dm7	→	G(11)	→	C6	F/G
	Vari	C6	→	Dm7	G7	Dm7	G7	C6	→	Am	A <sup>b</sup> aug	Dm7	→	G(11)	→	C6	C6
36	Orig	C	→	→	C7	F	→	C	→	G7	F7	C	G7				
	Vari	C	F	C	C7	F7	→	C	A7	D7	G7	C	G7				
37	Orig	C	→	F	→	C	→	F	→								
	Vari	Em7	A7b9	Dm7	G7	Em7	D <sup>b</sup> dim (C#dim)	Dm7	G7								
38	Orig	CM9	→	F/G	→	CM9	C9	FM9	F/G								
	Vari	FM9	F/G	CM9	Am9	Dm7b5	G7b9	CM7	F/G								
39	Orig	C	→	Gm7	→	C	→	Gm7	→								
	Vari	F	G7	C	C7	F	G7	Am	F/G								
40	Orig	CM7	D <sup>b</sup> dim (C#dim)	Dm7	G7	CM7	D <sup>b</sup> dim (C#dim)	Dm7	G7								
	Vari	FM7	G7	CM7	→	FM7	G7	C	C7								
41	Orig	Cm7	Fm7	Cm7	Fm7	Cm7	Fm7	Cm7	Fm7								
	Vari	Ddim	G7b9	Ddim	G7b9	Ddim	G7b9	Ddim	G7b9								

## Chord Progression Pattern List

No.	Rhythm Pattern	Chord Progression															
		1	2	3	4	5	6	7	8	9	10	11	12	13	14	15	16
42	Orig	Gm	→	Am7♭5	D7	Gm	→	Am7♭5	D7								
	Vari	E♭6	D7	Gm7	C7	E♭M7	D7	Gm	Gm								
43	Orig	C	Dm	Dm7/G	C	F	Em7	E♭	D								
	Vari	C	Bm7	Em9	A7	Am	D7	Dm9	G7sus4								
44	Orig	C	Am	F	G	C	Am	F	G								
	Vari	F	→	Em	→	Dm	→	C	→	Em	→	Am	→	F	→	F/G	G7
45	Orig	C	G7	→	C	→	G7	→	C								
	Vari	F	C	G7	C7	F	C	G7	C								
46	Orig	Am	E7	Am	E7	Am	E7	Dm7	E7								
	Vari	Am	E7	Am	E7	Dm7	G7	Bm7	E7								
47	Orig	DM7	→	CM7	→	G♭m9 (F♯m9)	F9	Em9	E♭9								
	Vari	DM7	D♭m7♭5 (C♯m7♭5)	Bm7	Am7	GM7	Fm7♭5	Em9	A7								
48	Orig	C	→	D6	→	Dm7	G7	C	→								
	Vari	F	Fm	C	→	F	Fm	G7sus4	G7								
49	Orig	C	→	→	→	→	→	G	→	G7	→	G	→	G7	→	C	→
	Vari	C	→	G7	→	→	→	C	→	→	→	G7	→	Dm7	G7	C	→
50	Orig	C	→	CM7	→	C7	→	F	→	→	→	CM7	D♭dim (C♯dim)	Dm7	Fm	C	→
	Vari	Dm	E♭dim (D♯dim)	Em7	A7	Dm7	G7	C	→								
51	Orig	C	G7	A♭	F	C	G7	A♭	F								
	Vari	C	G7	E♭	D7	C	G7	E♭	G7								
52	Orig	C	→	Am	→	C	→	Am	→								
	Vari	FM7	C	FM7	C	E♭	C	G7	→								
53	Orig	Cm	CmM7	Cm7	F7	Cm	A♭7	G7	→								
	Vari	Cm	CmM7	Cm7	F7	A♭7	G7	Cm	F7								
54	Orig	D	C/D	G/D	B♭/D	D	C/D	G/D	B♭/D								
	Vari	G♭m7 (F♯m7)	Bm	D	D♭7 (C♯7)	G♭m7 (F♯m7)	Bm	G	A7								
55	Orig	C	F	C	F	C	F	C	F/G								
	Vari	F	C	F	C	F	C	Dm7	F/G								
56	Orig	Fm7	B♭7	Fm7	B♭7	Fm7	B♭7	D♭7	C7	Fm7	B♭7	Fm7	B♭7	Fm7	B♭7	C7	Fm
	Vari	B♭m7	E♭7	A♭	D♭	G♭ (F♯)	B	Gm7♭5	C7								

Orig: Original



















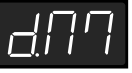
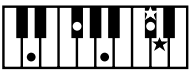
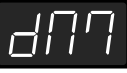



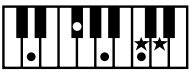



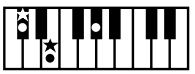

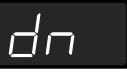

















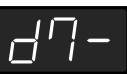



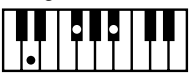

















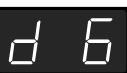

Vari: Variation

# Chord Fingering List

● symbol: indicates the constituent notes of chords.

★ symbol: Chords shown with an "★" can be played by pressing just the key marked with the "★".

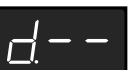
→ "Performing with the Chord Progression Specified in the Left Hand (Chord Progression Off)" (p. 51)

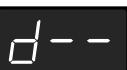
C  	C# / Db  	D  
CM7  	C#M7 / DbM7  	DM7  
C7  	C#7 / Db7  	D7  
Cm  	C#m / Dbm  	Dm  
Cm7  	C#7m / Db7m  	Dm7  
Cdim  	C#dim / Dbdim  	Ddim  
Cm7 (b5)  	C#m7(b5) / Dbm7(b5)  	Dm7 (b5)  
Caug  	C#aug / Dbaug  	Daug  
Csus4  	C#sus4 / Db#sus4  	Dsus4  
C7sus4  	C#7sus4 / Db7sus4  	D7sus4  
C6  	C#6 / Db6  	D6  
Cm6  	C#m6 / Dbm6  	Dm6  
C other  	C# other / Dbother  	D other  

● symbol: indicates the constituent notes of chords.

★ symbol: Chords shown with an "★" can be played by pressing just the key marked with the "★".

→ "Performing with the Chord Progression Specified in the Left Hand (Chord Progression Off)" (p. 51)

E <sup>b</sup>  E	E  E	F  F
E <sup>b</sup> M7  E <sup>b</sup> M7	EM7  EM7	FM7  FM7
E <sup>b</sup> 7  E 7	E7  E 7	F7  F 7
E <sup>b</sup> m  E m	Em  E m	Fm  F m
E <sup>b</sup> m7  E m7	Em7  E m7	Fm7  F m7
E <sup>b</sup> dim  E d m	Edim  E d m	Fdim  F d m
E <sup>b</sup> m7(b5)  E 7 -	Em7(b5)  E 7 -	Fm7(b5)  F 7 -
E <sup>b</sup> aug  E a u g	Eaug  E a u g	Faug  F a u g
E <sup>b</sup> sus4  E u 4	Esus4  E u 4	Fsus4  F u 4
E <sup>b</sup> 7sus4  E 7 u 4	E7sus4  E 7 u 4	F7sus4  F 7 u 4
E <sup>b</sup> 6  E 6	E6  E 6	F6  F 6
E <sup>b</sup> m6  E m 6	Em6  E m 6	Fm6  F m 6
E <sup>b</sup> other  E - -	E other  E - -	F other  F - -

## Chord Fingering List

● symbol: indicates the constituent notes of chords.

★ symbol: Chords shown with an "★" can be played by pressing just the key marked with the "★".





























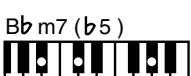
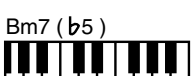

→ "Performing with the Chord Progression Specified in the Left Hand (Chord Progression Off)" (p. 51)

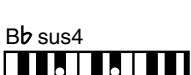
F# / Gb		G		Ab	
F#M7 / GbM7		GM7		AbM7	
F#7 / Gb7		G7		Ab7	
F#m / Gbm		Gm		Abm	
F#m7 / Gbm7		Gm7		Abm7	
F#dim / Gbdim		Gdim		Abdim	
F#m7(b5) / Gbm7(b5)		Gm7(b5)		Abm7(b5)	
F#aug / Gbaug		Gaug		Abaug	
F#sus4 / Gbsus4		Gsus4		Ab sus4	
F#7sus4 / Gb7sus4		G7sus4		Ab7sus4	
F#6 / Gb6		G6		Ab6	
F#m6 / Gbm6		Gm6		Abm6	
F# other / Gb other		G other		Ab other	

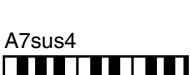
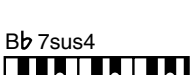
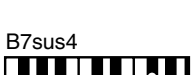
● symbol: indicates the constituent notes of chords.

★ symbol: Chords shown with a "★" can be played by pressing just the key marked with the "★".

→ "Performing with the Chord Progression Specified in the Left Hand (Chord Progression Off)" (p. 51)

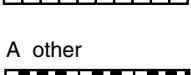
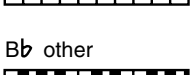
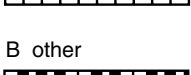
A  A	Bb  b	B  b
AM7  A77	Bb M7  b77	BM7  b77
A7  A 7	Bb 7  b 7	B7  b 7
Am  An	Bb m  bn	Bm  bn
Am7  An7	Bb m7  bn7	Bm7  bn7
Adim  Adn	Bb dim  bdn	Bdim  bdn
Am7 (b5)  A7-	Bb m7 (b5)  b7-	Bm7 (b5)  b7-
Aaug  A2G	Bb aug  b2G	Baug  b2G
Asus4  Au4	Bb sus4  bu4	Bsus4  bu4
A7sus4  Au7	Bb 7sus4  bu7	B7sus4  bu7
A6  A 6	Bb6  b 6	B6  b 6
Am6  An6	Bb m6  bn6	Bm6  bn6
A other  A--	Bb other  b--	B other  b--

# Internal Song List

1	Trio Grande
2	Wedding Song
3	Late Night Chopin
4	Preludelight
5	Blue Sky Rag
6	Sonate No.15
7	Liebesträume 3
8	Étude, op.10-3
9	Je te veux
10	Valse, op.64-1
11	Golliwog's Cakewalk
12	Fantaisie-Impromptu
13	Arabesque 1
14	An der schönen, blauen Donau
15	Auf Flügeln des Gesanges
16	Mazurka No.5
17	Gymnopédie 1
18	Étude, op.25-1
19	Clair de Lune
20	Étude, op.10-5
21	Dr. Gradus ad Parnassum
22	Grande Valse Brillante
23	La prière d'une Vierge
24	Course en Troïka
25	To The Spring
26	Valse, op.64-2
27	Radetzky Marsch
28	Träumerei
29	Moments Musicaux 3
30	Prélude, op.28-15
31	Harmonious Blacksmith
32	Ungarische Tänze 5
33	Türkischer Marsch (Beethoven)
34	Nocturne No.2
35	Frühlingslied
36	Präludium
37	Jägerlied
38	Menuet Antique

39	Für Elise
40	Türkischer Marsch (Mozart)
41	Ständchen
42	Humoreske
43	Blumenlied
44	Alpenglöckchen
45	Menuett G dur (Beethoven)
46	Venezianisches Gondellied
47	Alpenabendröte
48	Farewell to the Piano
49	Brautchor
50	Battle of Waterloo
51	Wiener Marsch
52	Le Coucou
53	Menuett G dur (Bach)
54	Spinnerlied
55	Gavotte
56	Heidenröslein
57	Zigeuner Tanz
58	La Cinquantaine
59	Csikos Post
60	Dolly's Dreaming Awakening
61	La Violette
62	Fröhlicher Landmann
63	Sonatine op.36-1 (Clementi)
64	Sonatine op.20-1 (Kuhlau)
65	Sonatine No.5 (Beethoven)

\* All rights reserved. Unauthorized use of this material for purposes other than private, personal enjoyment is a violation of applicable laws.



# Registration List

The recommended settings were stored in the instrument when it shipped from the factory.

No.	Registration Name
1-1	Piano + Str.
1-2	Piano+EPiano
1-3	Winds + Str.
1-4	JazzComboSes

No.	Registration Name
2-1	E.Piano / Bs
2-2	Vib. / BsCym
2-3	Piano / Pad
2-4	MamboSession

No.	Registration Name
3-1	JazzPno Ses1
3-2	RockPno Ses
3-3	LatinPno Ses
3-4	JazzPno Ses2

No.	Registration Name
4-1	BossaEP Ses
4-2	'60sEP Ses
4-3	'70sEP Ses
4-4	Funk Session

No.	Registration Name
5-1	Rock Organ
5-2	Jazz Organ
5-3	Bossa Organ
5-4	Full Organ

No.	Registration Name
6-1	FP REGIST.
6-2	FP REGIST.
6-3	FP REGIST.
6-4	FP REGIST.



Registration from 6-1 to 6-4 include the "Basic Registration." Use this when creating registration from scratch.

# Effects List

No	Effect Name	Value	Description
1	Equalizer	0-30	Gain of the low range (-15- +15 dB)
2	Spectrum	0-30	Gain of 500 Hz band (-15- +15 dB)
3	Enhancer	0-127	Sensitivity of the enhancer (0-127)
4	Isolator	0-64	At -60 dB, the sound of the middle range becomes inaudible. 0 dB is equivalent to the input level of the sound (-60- +4 dB)
5	Low Boost	0-12	Amount by which the lower range will be boosted (0- +12 dB)
6	High Pass Filter	0-127	Cutoff frequency of the filter Increasing this value will raise the cutoff frequency. (0-127)
7	Overdrive	0-127	Output Level (0-127)
8	Distortion	0-127	
9	Overdrive2	0-127	
10	Distortion2	0-127	
11	Speaker Simulator	0-127	
12	Guitar Amp Simulator	0-13	Type of guitar amp (JC-120, CLEAN TWIN, MATCH DRIVE, BG LEAD, MS1959I, MS1959II, MS1959I+II, SLDN LEAD, METAL5150, METAL LEAD, OD-1, OD-2 TURBO, DISTORTION, FUZZ)
13	Phaser	1-127	Frequency of modulation (Hz) (0.05-10.00 Hz)
14	Multi Stage Phaser	1-127	
15	Infinite Phaser	0-127	Speed at which to raise or lower the frequency at which the sound is modulated (+: upward / -: downward) (-100- +100)
16	Stereo Flanger	0-127	Depth of modulation (0-127)
17	3D Flanger	0-127	Depth of modulation (0-127)
18	2Band Flanger	1-127	Rate at which the low-range flanger sound is modulated (Hz) (0.05-10.00 Hz)
19	Auto Wah	1-127	Frequency of modulation (Hz) (0.05-10.00 Hz)
20	Humanizer	0-21	Frequency at which the two vowels switch
21	Ring Modulator	0-127	Adjusts the frequency at which modulation is applied. (0-127)
22	Tremolo	1-127	Frequency of the change (Hz) (0.05-10.00 Hz)
23	Auto Pan	1-127	
24	Slicer	12-21	Rate at which the 16-step sequence will cycle
25	Compressor	0-127	Adjusts the volume at which compression begins (0-127)
26	Limiter	0-127	
27	Stereo Chorus	0-127	Depth of modulation (0-127)
28	Hexa Chorus	0-127	
29	Tremolo Chorus	0-127	Modulation depth of the chorus effect (0-127)
30	Space D	0-127	Depth of modulation (0-127)
31	3D Chorus	0-127	Modulation depth of the chorus effect (0-127)
32	2Band Chorus	0-127	Modulation depth for the low-range chorus sound (0-127)
33	Rotary	0-1	Simultaneously switch the rotational speed of the low frequency rotor and high frequency rotor (Slow, Fast) Slow: Slows down the rotation to the Slow Rate. Fast: Speeds up the rotation to the Fast Rate.
34	Rotary2	0-1	
35	Rotary Multi	0-1	

No	Effect Name	Value	Description
36	Stereo Delay1	0–100	Volume balance between the direct sound (D) and the delay sound (W) (D100:0W–D0:100W)
37	Stereo Delay2	0–100	
38	Stereo Delay3	0–100	
39	Stereo Delay4	0–100	
40	Stereo Delay5	0–100	
41	Monaural Delay	0–100	
42	Modulation Delay	0–100	
43	Triple Tap Delay	0–100	
44	3D Delay	0–100	Volume balance between the direct sound (D) and the effect sound (W) (D100:0W–D0:100W)
45	Tape Echo	0–127	Volume of the echo sound (0–127)
46	Reverse Delay	0–100	Volume balance of the original sound (D) and delay the sound (W) (D100:0W–D0:100W)
47	Lo-Fi	0–100	Volume balance between the direct sound (D) and the effect sound (W) (D100:0W–D0:100W)
48	Telephone	0–100	
49	Gate Reverb	0–100	Volume balance between the direct sound (D) and the reverb sound (W) (D100:0W–D0:100W)
50	Overdrive→Chorus	0–100	Adjusts the volume balance between the sound that is sent through the chorus (W) and the sound that is not sent through the chorus (D). (D100:0W–D0:100W)
51	Overdrive→Flanger	0–100	Adjusts the volume balance between the sound that is sent through the flanger (W) and the sound that is not sent through the flanger (D). (D100:0W–D0:100W)
52	Overdrive→Delay	0–100	Adjusts the volume balance between the sound that is sent through the delay (W) and the sound that is not sent through the delay (D). (D100:0W–D0:100W)
53	Distortion→Chorus	0–100	Adjusts the volume balance between the sound that is sent through the chorus (W) and the sound that is not sent through the chorus (D). (D100:0W–D0:100W)
54	Distortion→Flanger	0–100	Adjusts the volume balance between the sound that is sent through the flanger (W) and the sound that is not sent through the flanger (D). (D100:0W–D0:100W)
55	Distortion→Delay	0–100	Adjusts the volume balance between the sound that is sent through the delay (W) and the sound that is not sent through the delay (D). (D100:0W–D0:100W)
56	Enhancer→Chorus	0–100	Adjusts the volume balance between the sound that is sent through the chorus (W) and the sound that is not sent through the chorus (D). (D100:0W–D0:100W)
57	Enhancer→Flanger	0–100	Adjusts the volume balance between the sound that is sent through the flanger (W) and the sound that is not sent through the flanger (D). (D100:0W–D0:100W)
58	Enhancer→Delay	0–100	Adjusts the volume balance between the sound that is sent through the delay (W) and the sound that is not sent through the delay (D). (D100:0W–D0:100W)
59	Chorus→Delay	0–100	
60	Flanger→Delay	0–100	
61	Chorus→Flanger	0–100	Volume balance between the direct sound (D) and the chorus sound (W) (D100:0W–D0:100W)
62	Damper Resonance	0–127	Depth of the effect (0–127)

# Stored Settings

## Settings Stored in a Registration

Stored Items	Page
Tone and variation selected for the Upper part and Lower part	p. 28, p. 29, p. 31
Settings for dual and split play	p. 29, p. 31
The volume balance for dual and split play	p. 34
Keyboard Touch, The velocity when the keyboard touch is set to "OFF"	p. 35, p. 86, p. 87
Reverb switch's on or off, and the depth of reverb	p. 36
The effect type and the settings of effects (*1)	p. 37, p. 83, p. 84
Speed of the rotary effect for organ sounds	p. 38
Key Transpose's on or off, and its value	p. 39
Session Partner settings	p. 44–p. 55 p. 88–p. 90
How the pedal effect is applied, and the function of the pedal	p. 81, p. 82
Setting the part to which effects are added	p. 84
Octave Shift for the Lower tone	p. 87
MIDI transmit channel	p. 100
Program Change settings	p. 103

\*1: Only the selected tone and rhythm-related settings are stored.

## Settings Stored While the Power is Off

Stored Items	Page
USB Driver Setting	p. 98
Equalizer Settings	p. 85
Sound Control's on or off, and the type of Sound Control	p. 84
Equalizer's on or off, and the type of Equalizer	p. 84

## Settings that Can be Stored by Backing Up

Stored Items	Page
Master Tuning	p. 79



# Specifications

## FP-4: Digital Piano

<b>Keyboard</b>	88 keys PHA alpha II keyboard
<b>Touch Sensitivity</b>	Light, Medium, Heavy, Off (velocity adjustable)
<b>Sound Generator</b>	GM2 system/GS/XG lite compatible
<b>Max. Polyphony</b>	128 voices
<b>Tones</b>	333 tones + 9 Drum Sets
<b>Effects</b>	Reverb Digital Effect (62 types) Sound Control (3 types) 4-band Digital Equalizer
<b>Session Partner</b>	Rhythm: 80 types x 2 variations Chord Progression: Automatic or input with keyboard (User Programmable)
<b>Recorder</b>	Tracks: 3 tracks Song: 1 song (Max. 99 songs to Internal Memory) Note Storage: Approx. 30000 notes Tempo: Quarter note = 10 to 500 Resolution: 120 ticks per quarter note
<b>Registration</b>	24 Max. 25 sets to Internal Memory
<b>Internal Songs</b>	65 Songs
<b>Demo Songs</b>	8 Songs
<b>&lt;Others&gt;</b>	
<b>Rated Power Output</b>	7 W x 2
<b>Speakers</b>	8 cm x 12cm x 2
<b>Display</b>	7 segments, 3 characters (LED)
<b>Connectors</b>	Output Jacks (L/Mono, R): 1/4 inch phone type Input Jacks (L/Mono, R): 1/4 inch phone type Headphone Jack x 2: Stereo 1/4 inch phone type USB (MIDI) Connector MIDI Connectors (In, Out) Pedal Jacks (Damper, Soft*, Sostenuto*) * Assignable DC In Jack
<b>Power Supply</b>	DC 9 V (AC Adaptor)
<b>Power Consumption</b>	22 W
<b>Dimensions (Including stand)</b>	1342 (W) x 305 (D) x 135 (H) mm 52-7/8 (W) x 12-1/16 (D) x 5-3/8 (H) inches
<b>Weight</b>	15.3kg / 33 lbs 12 oz

<b>Accessories</b>	Owner's Manual AC Adaptor Power Cord Music Rest 2 screws for the Music Rest Pedal (available Half-damper)
<b>Options</b>	Dedicated stand: KSC-44 Damper Pedal Pedal Switch Foot Switch Expression Pedal (EV-5)

\* In the interest of product improvement, the specifications and/or appearance of this unit are subject to change without prior notice.

### GS Format

The GS Format is Roland's set of specifications for standardizing the performance of sound generating devices. In addition to including support for everything defined by the General MIDI, the highly compatible GS Format additionally offers an expanded number of sounds, provides for the editing of sounds, and spells out many details for a wide range of extra features, including effects such as reverb and chorus. Designed with the future in mind, the GS Format can readily include new sounds and support new hardware features when they arrive. Since it is upwardly compatible with the General MIDI, Roland's GS Format is capable of reliably playing back GM Scores equally as well as it performs GS music files (music files that have been created with the GS Format in mind).

### XG lite

XG is a tone generator format of YAMAHA Corporation, that defines the ways in which voices are expanded or edited and the structure and type of effects, in addition to the General MIDI 1 specification. XGlite is a simplified version of XG tone generation format. You can play back any XG music files using an XGlite tone generator. However, keep in mind that some music files may play back differently compared to the original files, due to the reduced set of control parameters and effects.

- A**
- AC Adaptor ..... 15
  - All Song Play ..... 24
  - Audio Equipment ..... 94
- B**
- [Balance] Knob ..... 12, 34
  - Beat of Metronome ..... 91
  - Bend Down ..... 82
  - Bend Up ..... 82
  - Bulk Dump ..... 104
- C**
- Chord Fingering List ..... 120
  - Chord Progression ..... 50–51, 54–55
  - Chord Progression Off ..... 51
  - Chord Progression Pattern List ..... 117
  - Computer ..... 97–98
  - Connecting
    - AC Adaptor ..... 15
    - Audio Equipment ..... 94
    - Computer ..... 97–98
    - External Speakers ..... 94
    - Headphones ..... 19
    - MIDI Devices ..... 99
    - MIDI Sound Module ..... 100
    - Pedal ..... 18
    - Power Cord ..... 15
    - Roland CD-2 ..... 96
  - Cord Hook ..... 14–15
- D**
- Damper Jack ..... 18, 81
  - Damper Pedal ..... 18, 82
  - Damper Resonance ..... 18
  - DC In Jack ..... 14–15
  - Deleting
    - Saved Song ..... 77
  - Demo Songs ..... 20
  - Display ..... 12
  - [Display] Button ..... 13
  - Dual Play ..... 29
- E**
- Effect Type ..... 83
  - Effects ..... 37
  - Effects List ..... 126
  - Equalizer ..... 43, 85
  - [Equalizer] Button ..... 13, 43
  - Equalizer Settings ..... 85
  - Equalizer Type ..... 43
- Erasing
    - Recorded Performance ..... 75
  - Error Message ..... 110
  - Expression ..... 82
  - Expression Pedal ..... 18, 82
  - External Speaker ..... 94
- F**
- Factory Reset ..... 91
  - Fill In ..... 48
  - Front Panel ..... 12
  - [Function] Button ..... 12
  - Function Mode ..... 78
- G**
- General MIDI ..... 99
  - General MIDI 2 ..... 99
  - Ground Terminal ..... 15
  - GS ..... 131
- H**
- Headphones ..... 19
- I**
- Initializing ..... 90
  - Input Jacks ..... 14, 95
  - Internal Memory ..... 24, 27, 56, 60, 62–63, 76–77
    - Initializing ..... 90
  - Internal Song ..... 22, 24–25, 68
  - Internal Song List ..... 124
- K**
- Key Touch ..... 35, 86
    - Velocity ..... 87
  - Key Transpose ..... 39
  - Keyboard Sensitivity ..... 35, 86
  - Keynote ..... 80
- L**
- Leading Bass ..... 82
  - Listening
    - All Song Play ..... 24
    - Demo Song ..... 20
    - Each Part Separately ..... 25
    - Internal Song ..... 22
    - Songs Saved in Internal Memory ..... 27
  - Local Control ..... 101
  - Local Off ..... 101
  - Local On ..... 101



- M**
- Master Gain ..... 85
  - Master Tuning ..... 79
  - Message ..... 110
  - Metronome ..... 40
    - Beat ..... 91
    - Tempo ..... 41
    - Volume ..... 41
  - [Metronome] Button ..... 12, 40
  - MIDI ..... 99
  - MIDI Connector ..... 14, 99
  - MIDI Device ..... 99
  - MIDI In Connector ..... 99
  - MIDI Out Connector ..... 99
  - MIDI Settings ..... 100
  - MIDI Sound Module ..... 100
  - MIDI Transmit Channel ..... 100
  - Modulation ..... 82
  - [Multi Effects] Button ..... 13, 37
  - Music Rest ..... 17
  - Muting ..... 25
- O**
- Octave Shift ..... 87
  - Output Jacks ..... 14, 94, 96
- P**
- Panel Lock ..... 92
  - Pedal ..... 18, 81–82
    - Effects ..... 81
    - Works ..... 82
  - Pedal Jacks ..... 14
  - Pedals' Function ..... 82
  - Phones Jacks ..... 14, 19
  - [Play] Button ..... 12, 20–27
  - Playing Back
    - All Songs ..... 24
    - Demo Song ..... 20
    - Each Part Separately ..... 25
    - Internal Song ..... 22
    - Songs Saved in Internal Memory ..... 27
  - Power Cord ..... 15
  - Power On ..... 16
  - [Power] Switch ..... 14–16
  - Program Change ..... 103
  - Program Change Transmit Switch ..... 102
- R**
- Rear Panel ..... 14
  - [Rec] Button ..... 12, 54–55, 66–75
  - Recorder ..... 65, 72
  - Recorder MIDI Out ..... 102
  - Recording ..... 54, 65–74
    - Chord Progression ..... 54
    - Erasing Recorded Performances ..... 75
    - New Song ..... 66
    - Recording Along with a Song ..... 68
    - Recording Selected Track Button ..... 72
    - Recording Song with Session Partner ..... 70
  - Registration ..... 56–64, 103–105, 110, 128
  - [Registration] Button ..... 13, 56, 58–59, 64
  - Registration Set ..... 56, 60–63
  - [Reverb] Button ..... 13, 36
  - Reverb Effect ..... 36
    - Depth ..... 36
  - Rhythm List ..... 116
  - Rhythm Pattern ..... 53
  - Rotary Effect ..... 38
- S**
- Saving
    - Registration Set ..... 60
    - Songs You Record ..... 76
  - Session Partner ..... 44–55, 70
  - [Session Partner] Button ..... 12, 45–47, 50–55
  - Soft / (FC2) Jack ..... 18, 81
  - Soft Pedal ..... 18, 82
  - Song
    - All Song Play ..... 24
    - Deleting ..... 77
    - Demo Song ..... 20
    - Internal Song ..... 22
    - Saving ..... 76
    - Song Saved in Internal Memory ..... 27
    - Transmitted to an External MIDI Device ..... 102
    - Volume ..... 23
  - Sostenuto / (FC1) Jack ..... 18, 81
  - Sostenuto Pedal ..... 18, 82
  - Sound Control ..... 42, 84
  - [Sound Control] Button ..... 13, 42
  - Speaker Switch ..... 14, 94
  - [Split] Button ..... 13, 31–33, 51
  - Split Play ..... 31, 51
  - Split Point ..... 31, 33, 51
  - Standard Pitch ..... 79
- T**
- Temperament ..... 80
  - Tempo ..... 41, 49
    - Metronome ..... 41
    - Rhythm ..... 49
  - Tone ..... 28
  - Tone Buttons ..... 13, 28
  - Tone List ..... 111
  - Track Buttons ..... 12, 25, 65, 67–69, 71–72, 74
  - Track Mute ..... 25

## Index

---

Transpose .....	39
[Transpose] Button .....	12, 39
Troubleshooting .....	106
Tuning .....	79–80

## U

USB (MIDI) Connector .....	14, 98
USB Driver .....	98

## V

Velocity .....	87
V-LINK .....	92
Volume	
Headphone .....	19
Metronome .....	41
Muted Track .....	26
Overall .....	17
Session Partner Performance .....	47
Song .....	23
Volume Balance .....	34
[Volume] Knob .....	12, 15–17, 19

## X

XG lite .....	131
---------------	-----

---

# MEMO

---

# MEMO

## Information

When you need repair service, call your nearest Roland Service Center or authorized Roland distributor in your country as shown below.

### AFRICA

#### EGYPT

**A1 Fanny Trading Office**  
9, EBN Hagar A1 Askalany Street,  
ARD E1 Golf, Heliopolis,  
Cairo 11341, EGYPT  
TEL: 20-2-417-1828

#### REUNION

**Maison FO - YAM Marcel**  
25 Rue Jules Hermann,  
Chaudron - BP79 97 491  
Ste Clotilde Cedex,  
REUNION ISLAND  
TEL: (0262) 218-429

#### SOUTH AFRICA

**T.O.M.S. Sound & Music (Pty)Ltd.**  
2 ASTRON ROAD DENVER  
JOHANNESBURG ZA 2195,  
SOUTH AFRICA  
TEL: (011)417 3400  
FAX: (011)417 3462

**Paul Bothner(Pty)Ltd.**  
Royal Cape Park, Unit 24  
Londonderry Road, Ottery 7800  
Cape Town, SOUTH AFRICA  
TEL: (021) 799 4900

### ASIA

#### CHINA

**Roland Shanghai Electronics Co.,Ltd.**  
5F, No.1500 Pingliang Road  
Shanghai 200090, CHINA  
TEL: (021) 5580-0800

**Roland Shanghai Electronics Co.,Ltd.**  
**(BEIJING OFFICE)**  
10F, No.18 3 Section Anhuaxili  
Chaoyang District Beijing  
100011 CHINA  
TEL: (010) 6426-5050

#### HONG KONG

**Tom Lee Music Co., Ltd.**  
Service Division  
22-32 Pun Shan Street, Tsuen  
Wan, New Territories,  
HONG KONG  
TEL: 2415 0911

**Parsons Music Ltd.**  
8th Floor, Railway Plaza, 39  
Chatham Road South, T.S.T,  
Kowloon, HONG KONG  
TEL: 2333 1863

#### INDIA

**Rivera Digitec (India) Pvt. Ltd.**  
409, Nirman Kendra  
Mahalaxmi Flats Compound  
Off. Dr. Edwin Moses Road,  
Mumbai-400011, INDIA  
TEL: (022) 2493 9051

#### INDONESIA

**PT Citra IntiRama**  
Jl. Cideng Timur No. 15J-150  
Jakarta Pusat  
INDONESIA  
TEL: (021) 6324170

#### KOREA

**Cosmos Corporation**  
1461-9, Seocho-Dong,  
Seocho Ku, Seoul, KOREA  
TEL: (02) 3486-8855

#### MALAYSIA

**Roland Asia Pacific Sdn. Bhd.**  
45-1, Block C2, Jalan PJU 1/39,  
Dataran Prima, 47301 Petaling  
Jaya, Selangor, MALAYSIA  
TEL: (03) 7805-3263

#### PHILIPPINES

**G.A. Yupangco & Co. Inc.**  
339 Gil J. Puyat Avenue  
Makati, Metro Manila 1200,  
PHILIPPINES  
TEL: (02) 899 9801

#### SINGAPORE

**SWEE LEE MUSIC COMPANY PTE. LTD.**  
150 Sims Drive,  
SINGAPORE 387381  
TEL: 6846-3676

#### TAIWAN

**ROLAND TAIWAN ENTERPRISE CO., LTD.**  
Room 5, 9fl. No. 112 Chung  
Shan N. Road Sec.2, Taipei,  
TAIWAN, R.O.C.  
TEL: (02) 2561 3339

#### THAILAND

**Theera Music Co., Ltd.**  
330 Soi Vergn NakornKasem,  
New Road, Sumpantawongse,  
Bangkok 10100, THAILAND  
TEL: (02) 224-8821

### AUSTRALIA/ NEW ZEALAND

#### AUSTRALIA/ NEW ZEALAND

**Roland Corporation Australia Pty.,Ltd.**  
38 Campbell Avenue  
Dee Why West. NSW 2099  
AUSTRALIA

For Australia  
Tel: (02) 9982 8266  
For New Zealand  
Tel: (09) 3098 715

### CENTRAL/LATIN AMERICA

#### ARGENTINA

**Instrumentos Musicales S.A.**  
Av.Santa Fe 2055  
(1123) Buenos Aires  
ARGENTINA  
TEL: (011) 4508-2700

#### BARBADOS

**A&B Music Supplies LTD**  
12 Webster Industrial Park  
Wilbey, St.Michael, Barbados  
TEL: (246)430-1100

#### BRAZIL

**Roland Brasil Ltda.**  
Rua San Jose, 780 Sala B  
Parque Industrial San Jose  
Cotia - Sao Paulo - SP, BRAZIL  
TEL: (011) 4615 5666

#### CHILE

**Comercial Fancy II S.A.**  
Rut.: 96.919.420-1  
Nataniel Cox #739, 4th Floor  
Santiago - Centro, CHILE  
TEL: (02) 688-9540

#### COLOMBIA

**Centro Musical Ltda.**  
Cra 43 B No 25 A 41 Bododega 9  
Medellin, Colombia  
TEL: (574)3812529

#### COSTA RICA

**JUAN Bansbach Instrumentos Musicales**  
Ave.1. Calle 11, Apartado  
10237,  
San Jose, COSTA RICA  
TEL: 258-0211

#### CURACAO

**Zeelandia Music Center Inc.**  
Orionweg 30  
Curacao, Netherland Antilles  
TEL:(305)5926866

#### DOMINICAN REPUBLIC

**Instrumentos Fernando Giraldez**  
Calle Proyecto Central No.3  
Ens.La Esperilla  
Santo Domingo,  
Dominican Republic  
TEL:(809) 683 0305

#### ECUADOR

**Mas Musica**  
Rumichaca 822 y Zaruma  
Guayaquil - Ecuador  
TEL:(593-4)2302364

#### EL SALVADOR

**OMNI MUSIC**  
75 Avenida Norte y Final  
Alameda Juan Pablo II,  
Edificio No.4010 San Salvador,  
EL SALVADOR  
TEL: 262-0788

#### GUATEMALA

**Casa Instrumental**  
Calzada Roosevelt 34-01,zona 11  
Ciudad de Guatemala  
Guatemala  
TEL:(502) 599-2888

#### HONDURAS

**Almacen Pajaro Azul S.A. de C.V.**  
BO.Paz Barahona  
3 Ave.11 Calle S.O  
San Pedro Sula, Honduras  
TEL: (504) 553-2029

#### MARTINIQUE

**Musique & Son**  
Z.Les Mangle  
97232 Le Lamantin  
Martinique F.W.I.  
TEL: 596 596 426860

**Gigamusic SARRL**  
10 Rte De La Folie  
97200 Fort De France  
Martinique F.W.I.  
TEL: 596 596 715222

#### MEXICO

**Casa Veerkamp, s.a. de c.v.**  
Av. Toluca No. 323, Col. Olivar  
de los Padres 01780 Mexico  
D.F. MEXICO  
TEL: (55) 5668-6699

#### NICARAGUA

**Bansbach Instrumentos Musicales Nicaragua**  
Altamira D'Este Calle Principal  
de la Farmacia 5ta.Avenida  
1 Cuadra al Lago.#503  
Managua, Nicaragua  
TEL: (505)277-2557

#### PANAMA

**SUPRO MUNDIAL, S.A.**  
Boulevard Andrews, Albrook,  
Panama City, REP. DE  
PANAMA  
TEL: 315-0101

#### PARAGUAY

**Distribuidora De Instrumentos Musicales**  
J.E. Olear y ESQ. Manduvira  
Asuncion PARAGUAY  
TEL: (595) 21 492147

#### PERU

**Audionet**  
Distribuciones Musicales SAC  
Juan Flores 530  
Miraflores  
Lima - Peru  
TEL: (511) 4461388

#### TRINIDAD

**AMR Ltd**  
Ground Floor  
Maritime Plaza  
Barataria Trinidad W.I.  
TEL: (868) 638 6385

#### URUGUAY

**Todo Musica S.A.**  
Francisco Acuna de Figueroa  
1771  
C.P.: 11.800  
Montevideo, URUGUAY  
TEL: (02) 924-2335

#### VENEZUELA

**Instrumentos Musicales Allegro,C.A.**  
Av.las industrias edf.Guitar  
import  
#7 zona Industrial de Turumo  
Caracas, Venezuela  
TEL: (212) 244-1122

### EUROPE

#### AUSTRIA

**Roland Elektronische Musikinstrumente HmbH. Austrian Office**  
Eduard-Bodem-Gasse 8,  
A-6020 Innsbruck, AUSTRIA  
TEL: (0512) 26 44 260

#### BELGIUM/FRANCE/ HOLLAND/ LUXEMBOURG

**Roland Central Europe N.V.**  
Houtstraat 3, B-2260, Oevel  
(Westerlo) BELGIUM  
TEL: (014) 575811

#### CROATIA

**ART-CENTAR**  
Degenova 3.  
HR - 10000 Zagreb  
TEL: (1) 466 8493

#### CZECH REP.

**CZECH REPUBLIC DISTRIBUTOR S.r.o**  
Votárova 247/16  
CZ - 180 00 PRAHA 8,  
CZECH REP.  
TEL: (2) 830 20270

#### DENMARK

**Roland Scandinavia A/S**  
Nordhavnsvej 7, Postbox 880,  
DK-2100 Copenhagen  
DENMARK  
TEL: 3916 6200

#### FINLAND

**Roland Scandinavia As, Filial Finland**  
Elannontie 5  
FIN-01510 Vantaa, FINLAND  
TEL: (09) 68 24 020

#### GERMANY

**Roland Elektronische Musikinstrumente HmbH.**  
Oststrasse 96, 22844  
Norderstedt, GERMANY  
TEL: (040) 52 60090

#### GREECE/CYPRUS

**STOLLAS S.A.**  
Music Sound Light  
155, New National Road  
Patras 26442, GREECE  
TEL: 2610 435400

#### HUNGARY

**Roland East Europe Ltd.**  
Warehouse Area 'DEPO' Pf.83  
H-2046 Torokbalint,  
HUNGARY  
TEL: (23) 511011

#### IRELAND

**Roland Ireland**  
G2 Calmount Park, Calmount  
Avenue, Dublin 12  
Republic of IRELAND  
TEL: (01) 4294444

#### ITALY

**Roland Italy S. p. A.**  
Viale delle Industrie 8,  
20020 Arese, Milano, ITALY  
TEL: (02) 937-78300

#### NORWAY

**Roland Scandinavia Avd.**  
**Kontor Norge**  
Lilleakerveien 2 Postboks 95  
Lilleaker N-0216 Oslo  
NORWAY  
TEL: 2273 0074

#### POLAND

**ROLAND POLSKA SP. Z O.O.**  
UL. Gibraltarska 4.  
PL-03 664 Warszawa  
POLAND  
TEL: (022) 679 4419

#### PORTUGAL

**Roland Iberia, S.L.**  
**Portugal Office**  
Cais das Pedras, 8/9-1 Dto  
4050-465, Porto, PORTUGAL  
TEL: 22 608 00 60

#### ROMANIA

**FBS LINES**  
Piata Libertatii 1,  
535500 Gheorgheni,  
ROMANIA  
TEL: (0512) 364 609

#### RUSSIA

**MuTek**  
Dorozhnaya ul.3,korp.6  
117 545 Moscow, RUSSIA  
TEL: (095) 981-4967

#### SLOVAKIA

**DAN Acoustic s.r.o.**  
Povazská 18.  
SK - 940 01 Nové Zámky  
TEL: (035) 6424 330

#### SPAIN

**Roland Iberia, S.L.**  
Paseo Garcia Faria, 33-35  
08005 Barcelona SPAIN  
TEL: 93 493 91 00

#### SWEDEN

**Roland Scandinavia A/S**  
**SWEDISH SALES OFFICE**  
Danvik Center 28, 2 tr.  
S-131 30 Nacka SWEDEN  
TEL: (08) 702 00 20

#### SWITZERLAND

**Roland (Switzerland) AG**  
Landstrasse 5, Postfach,  
CH-4452 Ittingen,  
SWITZERLAND  
TEL: (061) 927-8383

#### UKRAINE

**EURHYTHMICS Ltd.**  
P.O.Box: 37-a.  
Nedecey Str. 30  
U.A - 89600 Mukachevo,  
UKRAINE  
TEL: (03131) 414-40

#### UNITED KINGDOM

**Roland (U.K.) Ltd.**  
Atlantic Close, Swansea  
Enterprise Park, SWANSEA  
SA7 9FJ,  
UNITED KINGDOM  
TEL: (01792) 702701

### MIDDLE EAST

#### BAHRAIN

**Moon Stars**  
No.16, Bab Al Bahrain Avenue,  
P.O.Box 247, Manama 304,  
State of BAHRAIN  
TEL: 17 211 005

#### IRAN

**MOCO INC.**  
No.41 Nike St, Dr.Shariyati Ave.,  
Roberoye Cerahe Mirdamad  
Tehran, IRAN  
TEL: (021) 285-4169

#### ISRAEL

**Halilit P. Greenspoon & Sons Ltd.**  
8 Retzif Ha'aliya Hashnya St.  
Tel-Aviv-Yafo ISRAEL  
TEL: (03) 6823666

#### JORDAN

**MUSIC HOUSE CO. LTD.**  
**FREDDY FOR MUSIC**  
P. O. Box 922846  
Amman 11192 JORDAN  
TEL: (06) 5692696

#### KUWAIT

**EASA HUSAIN AL-YOUSIFI & SONS CO.**  
Abdullah Salem Street,  
Safat, KUWAIT  
TEL: 243-6399

#### LEBANON

**Chahine S.A.L.**  
Gerge Zeidan St., Chahine  
Bldg., Achrafieh, P.O.Box: 16-  
5857  
Beirut, LEBANON  
TEL: (01) 20-1441

#### OMAN

**TALENTZ CENTRE L.L.C.**  
Malatan House No.1  
Al Noor Street, Ruwi  
SULTANATE OF OMAN  
TEL: 2478 3443

#### QATAR

**Al Emadi Co. (Badie Studio & Stores)**  
P.O. Box 62, Doha, QATAR  
TEL: 4423-554

#### SAUDI ARABIA

**aDawlah Universal Electronics APL**  
Corniche Road, Aldossary  
Bldg., 1st Floor, Alkhobar,  
SAUDI ARABIA

P.O.Box 2154, Alkhobar 31952  
SAUDI ARABIA  
TEL: (03) 898 2081

#### SYRIA

**Technical Light & Sound Center**  
Rawda, Abdul Qader Jazairi St.  
Bldg. No. 21, P.O.BOX 13520,  
Damascus, SYRIA  
TEL: (011) 223-5384

#### TURKEY

**ZUHAL DIS TICARET S.A.**  
Galip Dede Cad. No.37  
Beyoglu - Istanbul / TURKEY  
TEL: (0212) 249 85 10

#### U.A.E.

**Zak Electronics & Musical Instruments Co. L.L.C.**  
Zabeel Road, Al Sherooq Bldg.,  
No. 14, Grand Floor, Dubai,  
U.A.E.  
TEL: (04) 3360715

### NORTH AMERICA

#### CANADA

**Roland Canada Ltd.**  
**(Head Office)**  
5480 Parkwood Way  
Richmond B. C., V6V 2M4  
CANADA  
TEL: (604) 270 6626

#### Roland Canada Ltd.

**(Toronto Office)**  
170 Admiral Boulevard  
Mississauga On L5T 2N6  
CANADA  
TEL: (905) 362 9707

#### U. S. A.

**Roland Corporation U.S.**  
5100 S. Eastern Avenue  
Los Angeles, CA 90040-2938,  
U. S. A.  
TEL: (323) 890 3700

For the U.K.

**IMPORTANT:** THE WIRES IN THIS MAINS LEAD ARE COLOURED IN ACCORDANCE WITH THE FOLLOWING CODE.

BLUE: NEUTRAL  
BROWN: LIVE

As the colours of the wires in the mains lead of this apparatus may not correspond with the coloured markings identifying the terminals in your plug, proceed as follows:

The wire which is coloured BLUE must be connected to the terminal which is marked with the letter N or coloured BLACK.

The wire which is coloured BROWN must be connected to the terminal which is marked with the letter L or coloured RED.

Under no circumstances must either of the above wires be connected to the earth terminal of a three pin plug.

For EU Countries



This product complies with the requirements of European Directive 89/336/EEC.

For the USA

## FEDERAL COMMUNICATIONS COMMISSION RADIO FREQUENCY INTERFERENCE STATEMENT

This equipment has been tested and found to comply with the limits for a Class B digital device, pursuant to Part 15 of the FCC Rules. These limits are designed to provide reasonable protection against harmful interference in a residential installation. This equipment generates, uses, and can radiate radio frequency energy and, if not installed and used in accordance with the instructions, may cause harmful interference to radio communications. However, there is no guarantee that interference will not occur in a particular installation. If this equipment does cause harmful interference to radio or television reception, which can be determined by turning the equipment off and on, the user is encouraged to try to correct the interference by one or more of the following measures:

- Reorient or relocate the receiving antenna.
- Increase the separation between the equipment and receiver.
- Connect the equipment into an outlet on a circuit different from that to which the receiver is connected.
- Consult the dealer or an experienced radio/TV technician for help.

This device complies with Part 15 of the FCC Rules. Operation is subject to the following two conditions:

- (1) This device may not cause harmful interference, and
- (2) This device must accept any interference received, including interference that may cause undesired operation.

Unauthorized changes or modification to this system can void the users authority to operate this equipment.  
This equipment requires shielded interface cables in order to meet FCC class B Limit.

For Canada

### NOTICE

This Class B digital apparatus meets all requirements of the Canadian Interference-Causing Equipment Regulations.

### AVIS

Cet appareil numérique de la classe B respecte toutes les exigences du Règlement sur le matériel brouilleur du Canada.

For the USA

## DECLARATION OF CONFORMITY Compliance Information Statement

Model Name : FP-4  
Type of Equipment : Digital Piano  
Responsible Party : Roland Corporation U.S.  
Address : 5100 S. Eastern Avenue, Los Angeles, CA 90040-2938  
Telephone : (323) 890-3700



This product must be disposed of separately  
at your local waste recycling centre.  
Do not dispose of in household waste bin.



Roland®

