

Owner's Manual









Thank you, and congratulations on your choice of the Roland CY-5.

Before using the CY-5, carefully read the sections entitled: "USING THE UNIT SAFELY" and "IMPORTANT NOTES" (p. 2; p. 3). These sections provide important information concerning the proper operation of the unit. Additionally, in order to feel assured that you have gained a good grasp of every feature provided by your new unit, this owner's manual should be read in its entirety. The manual should be saved and kept on hand as a convenient reference.

Main Feature

The CY-5 has been designed to be used as a hi-hat pad or a cymbal pad, with the corresponding mounting parts for both functions included in the package. The dual trigger pad allows one to play edge shots, bow shots and choking techniques can be used. It's an ideal "add on" to any existing set up.

Package Contents

- CY-5 (cymbal pad)
- Connection Cable (stereo)
- Drum Key 
- Attachment Set for Cymbal
 - Wing Nut 
 - Felt Washer 
 - Stopper 
- Cable Tie
- Owner's Manual (this manual)
- Attachment Set for Hi-Hat
 - Upper Clutch 
 - Clutch Felt (S) 
 - Clutch Felt (L) 
 - Lower Clutch 

Names of Components

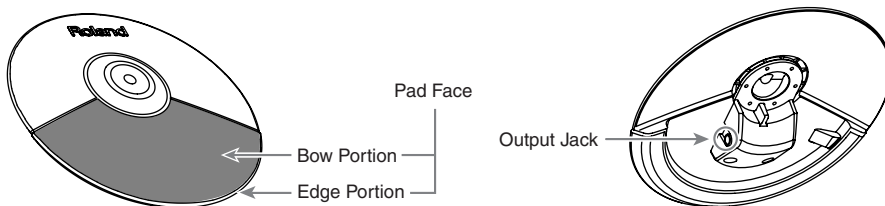



Copyright © 2006 ROLAND CORPORATION

All rights reserved. No part of this publication may be reproduced in any form without the written permission of ROLAND CORPORATION.







USING THE UNIT SAFELY

INSTRUCTIONS FOR THE PREVENTION OF FIRE, ELECTRIC SHOCK, OR INJURY TO PERSONS

About  WARNING and  CAUTION Notices





 WARNING	Used for instructions intended to alert the user to the risk of death or severe injury should the unit be used improperly.
 CAUTION	Used for instructions intended to alert the user to the risk of injury or material damage should the unit be used improperly. * Material damage refers to damage or other adverse effects caused with respect to the home and all its furnishings, as well to domestic animals or pets.

About the Symbols







	The  symbol alerts the user to important instructions or warnings. The specific meaning of the symbol is determined by the design contained within the triangle. In the case of the symbol at left, it is used for general cautions, warnings, or alerts to danger.
	The  symbol alerts the user to items that must never be carried out (are forbidden). The specific thing that must not be done is indicated by the design contained within the circle. In the case of the symbol at left, it means that the unit must never be disassembled.
	The  symbol alerts the user to things that must be carried out. The specific thing that must be done is indicated by the design contained within the circle. In the case of the symbol at left, it means that the power-cord plug must be unplugged from the outlet.

ALWAYS OBSERVE THE FOLLOWING

WARNING

- Before using this unit, make sure to read the instructions below, and the Owner's Manual. 
- Do not open or perform any internal modifications on the unit. 
- Do not attempt to repair the unit, or replace parts within it (except when this manual provides specific instructions directing you to do so). Refer all servicing to your retailer, the nearest Roland Service Center, or an authorized Roland distributor, as listed on the "Information" page. 
- Never use or store the unit in places that are:
 - Subject to temperature extremes (e.g., direct sunlight in an enclosed vehicle, near a heating duct, on top of heat-generating equipment); or are 
 - Damp (e.g., baths, washrooms, on wet floors); or are 
 - Humid; or are
 - Exposed to rain; or are
 - Dusty; or are
 - Subject to high levels of vibration.

WARNING

- This unit should be used only with a stand (MDS series) that is recommended by Roland (p. 4, p. 5). 
- When using the unit with a stand (MDS series) recommended by Roland, the stand must be carefully placed so it is level and sure to remain stable. If not using a stand, you still need to make sure that any location you choose for placing the unit provides a level surface that will properly support the unit, and keep it from wobbling. 
- Do not allow any objects (e.g., flammable material, coins, pins); or liquids of any kind (water, soft drinks, etc.) to penetrate the unit. 

- In households with small children, an adult should provide supervision until the child is capable of following all the rules essential for the safe operation of the unit. 
- Do not drop it! 

⚠ CAUTION

- Try to prevent cords and cables from becoming entangled. Also, all cords and cables should be placed so they are out of the reach of children.



- Never climb on top of, nor place heavy objects on the unit.



- Should you remove nuts, washers, etc. keep them in a safe place out of children's reach, so there is no chance of them being swallowed accidentally.



IMPORTANT NOTES

In addition to the items listed under “USING THE UNIT SAFELY” on page 2–3, please read and observe the following:

Placement

- Do not expose the unit to direct sunlight, place it near devices that radiate heat, leave it inside an enclosed vehicle, or otherwise subject it to temperature extremes. Excessive heat can deform or discolor the unit.
- Do not allow rubber, vinyl, or similar materials to remain on the unit for long periods of time. Such objects can discolor or otherwise harmfully affect the finish.

Maintenance

- For everyday cleaning wipe the unit with a soft, dry cloth or one that has been slightly dampened with water. To remove stubborn dirt, use a cloth impregnated with a mild, non-abrasive detergent. Afterwards, be sure to wipe the unit thoroughly with a soft, dry cloth.
- Never use benzine, thinners, alcohol or solvents of any kind, to avoid the possibility of discoloration and/or deformation.

Additional Precautions

- Use a reasonable amount of care when using the unit's buttons, sliders, or other controls; and when using its jacks and connectors. Rough handling can lead to malfunctions.

- When connecting / disconnecting all cables, grasp the connector itself—never pull on the cable. This way you will avoid causing shorts, or damage to the cable's internal elements.
- To avoid disturbing your neighbors, try to keep the unit's volume at reasonable levels. You may prefer to use headphones, so you do not need to be concerned about those around you (especially when it is late at night).
- This instrument is designed to minimize the extraneous sounds produced when it's played. However, since sound vibrations can be transmitted through floors and walls to a greater degree than expected, take care not to allow these sounds to become a nuisance to neighbors, especially when performing at night and when using headphones.

Making the Settings

Using the CY-5 as a cymbal pad

When mounting the CY-5 on a cymbal stand, use ONLY the attachment set as shown below.

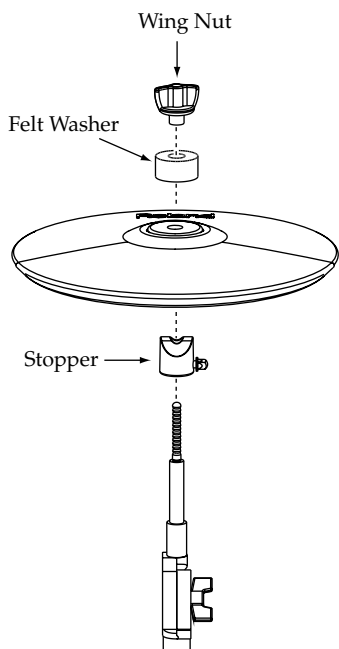

1. Mount the cymbal stopper as shown below.

The cymbal stopper keeps the cymbal from rotating, allowing proper function of the pad, and also prevents cables from winding around the stand.

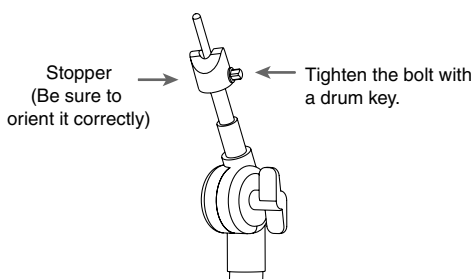

2. Attach the CY-5 so the Roland logo is positioned on the opposite side of the playing area.

3. Tighten the felt washer and the wing nut.

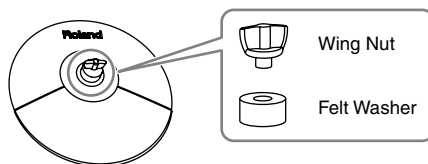

Wing Nut tension

The wing nut should be tightened to allow the movement you desire. BUT, if it is too loose, double triggering may occur.

Use ONLY the included felt washer and wing nut. Standard, metal wing nuts found on most cymbal stands should never be used.

4. Use the included connection cable and connect the output jack of the CY-5 to the trigger input jack of the percussion sound module.

Connect the L-shaped plug of the included cable to the CY-5.

NOTE

To make use of edge shot and choking play techniques, you'll need to connect to a trigger input jack on the percussion sound module that accommodates rim shots (p. 6).

* To prevent malfunction and/or damage to speakers or other devices, always turn down the volume, and turn off the power on all devices before making any connections.

5. Secure the cable with the provided cable tie.

Leave enough slack, so that the cymbal can still move freely, without pulling on the cable.

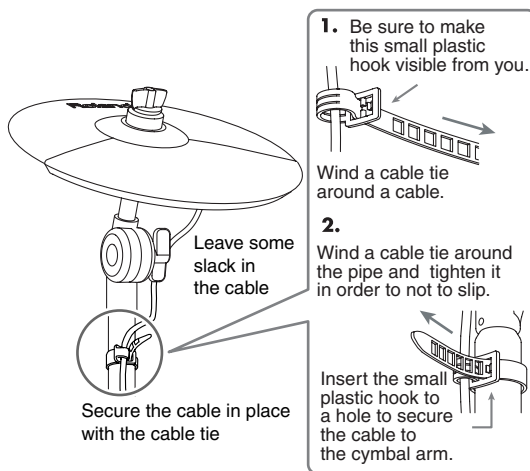

6. For the CY-5 to function correctly, the trigger type and trigger parameters in the sound module must be adjusted. See Page 6.

Using the CY-5 as a hi-hat pad

When mounting the CY-5 on an L-Rod (pad mount), use **ONLY** the attachment set as shown below.

Acceptable rod diameters:

10.5–11.5 mm (7/16 to 1/2 inch)

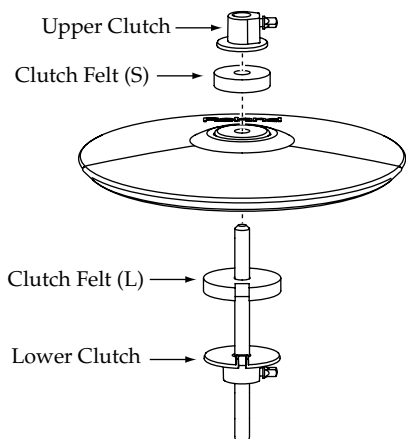

1. Mounting the lower clutch and the clutch felt (L).

Align the notched section as shown below. Then place the clutch felt so it fits securely.

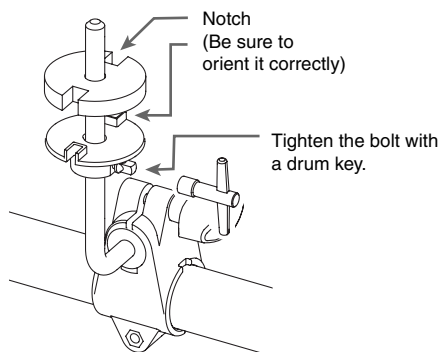

2. Mount the CY-5 so it fits the lower clutch as shown below.

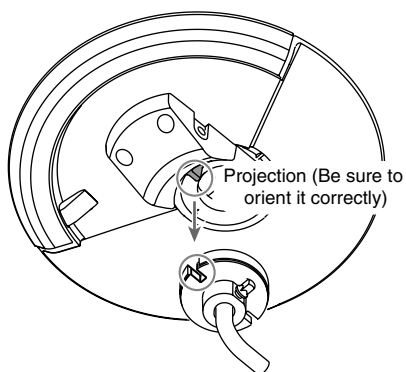

3. Place the clutch felt (S), and while applying some pressure, mount the upper clutch as shown.

Afterwards, you can adjust the upper clutch to have the movement you desire. If it is too loose, double triggering may occur.

Be sure the Roland logo is on the opposite side of the playing area.

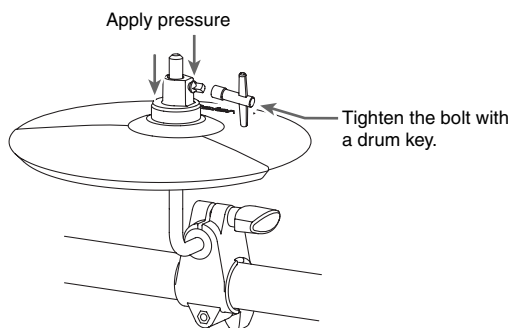

4. Use the included connection cable and connect the output jack of the CY-5 to the trigger input jack of the percussion sound module.

Connect the L-shaped plug of the included cable to the CY-5.

NOTE

To make use of edge shot and choking play techniques, you'll need to connect to a trigger input jack on the percussion sound module that accommodates rim shots (p. 6).

* To prevent malfunction and/or damage to speakers or other devices, always turn down the volume, and turn off the power on all devices before making any connections.

5. Secure the cable with the provided cable tie to the stand pipe.

Leave enough slack, so that the pad can still move freely without pulling on the cable.

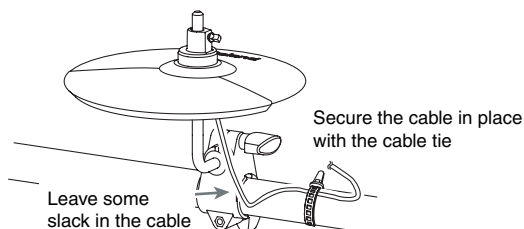

6. For the CY-5 to function correctly, the trigger type in the sound module must be adjusted. See page 6.

Trigger Settings For Percussion Sound Module

When using the CY-5, trigger parameter settings will be different depending on the module you are using.

Below you will find the parameters that correspond to different sound modules.

Make the trigger type setting for the percussion sound module.

TD-3 (Percussion Sound Module)

Trigger Type (LTP): Cy (CY)

Only the inputs listed below are capable of producing an edge shot and a choking play techniques.

- SNARE
- HI-HAT
- CRASH1
- CRASH2
- RIDE

TD-6V (Percussion Sound Module)

TrigTyp: Cy Type

TD-12/TD-20 (Percussion Sound Module)

Trig Type: CY6

Playing Methods

NOTE

Do NOT play on the hard plastic section of the pad.

Bow Shot

This is the most common playing method, playing the pad face of the cymbal. It corresponds to the sound of the “head-side” of the connected trigger input.

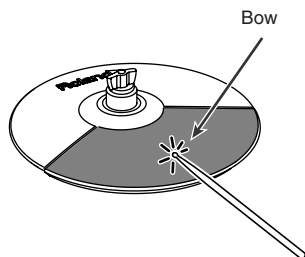

Edge Shot

This playing method involves striking the edge with the shoulder of the stick. It corresponds to the sound of the “rim-side” of the connected trigger input.

NOTE

To make use of edge shot, you’ll need to connect to a trigger input jack on the percussion sound module that accommodates rim shots.

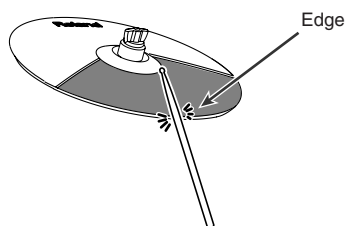

Choking

Choking (pinching) the cymbal’s edge with the hand immediately after hitting the cymbal makes the sound stop.

NOTE

To make use of choking play techniques, you’ll need to connect to a trigger input jack on the percussion sound module that accommodates rim shots.

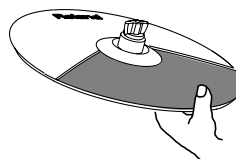

Specifications

CY-5

- Size: 10 inches
- Triggers: 2 (Bow, Edge)
- Dimensions: 246 (W) x 246 (D) x 45 (H) mm
9-11/16 (W) x 9-11/16 (D) x 1-13/16 (H) inches
- Weight: 380 g / 14 oz (without attachment)
- Accessories: Owner’s Manual
Connection Cable
Drum Key
Attachment Set for Cymbal
Wing Nut
Felt Washer
Stopper
Attachment Set for Hi-hat
Upper Clutch
Lower Clutch
Clutch Felt (L)
Clutch Felt (S)
Cable Tie
- Options: Cymbal Mount (MDY-10U)
Drum Stands (MDS-3C, MDS-6C, MDS-12, MDS-20)

NOTE

In the interest of product improvement, the specifications and/or appearance of this unit are subject to change without prior notice.

NOTE

Continuous playing may cause dis-coloration of the pad, but this will not affect the Pad’s function.

