

**BOSS**

**BX-800**

**8CHANNEL STEREO MIXER**

**INSTRUCTIONS**

•Please read the instructions carefully.

---

## ■ PANEL DESCRIPTIONS

### ● Input Jacks

These are to connect audio equipment, musical instruments, microphone, etc.

### ● Effect Send Jack

This is to connect the Input of the effect unit.

### ● Effect Return Jack

This is to connect the Output of the effect unit.

### ● Output Jacks

These are to connect a power amplifier or recording equipment, etc.

### ● Power Switch

Be sure to turn the Power Switch on or off with the Master Volume set low.

### ● Overload Indicator

This lights when input signal level is too high. Adjust the level lower than that by using the Gain Control.

### ● Gain Controls

This knob is to set the Gain level depending on the connected unit. Rotating this clockwise increases the level.

### ● Treble Controls

This knob adjust the treble. That is, rotating it clockwise boosts the high frequency range, and rotating it counterclockwise cuts it.

### ● Bass Controls

This adjusts bass sound. Rotating this clockwise boosts low frequency range, and rotating it counterclockwise cuts it.

\* When these knobs are set to zero, there is no boost or cutoff of harmonic contents, therefore flat characteristics are obtained.

### ● Effect Level Controls

This sets the level of the output signal sent to each effect unit (=Effect send level).

\* The pickup point of the Effect Send signal is post channel volume.

### ● Panpot Controls

The Panpot Control routes the input signal from an Input Channel to the left and/or right mixing busses. By means of the Panpot Controls, input signals can be sent exclusively to one mixing bus, or the other, to both mixing busses equally, or since the Panpot Control is continuously variable to both mixing busses in any relative proportion desired.

### ● Channel Volumes

This knob controls the volume of each channel independently. The "10" position gives the highest and "0" lowest level.

### ● Level Indicators

This detects the level of the output signal. When "OdB" lights, the signal of +4dBm is being sent through the Output Jack.

### ● Power Indicator

This lights when the BX-800 is turned on.

### ● Effect Return Level Control

This knob controls the volume of effect sound. As you rotate it clockwise, volume increases.

### ● Headphone Level Control

As you rotate this knob clockwise, the headphones volume increases. This knob allows separate level setting free from the Master Volume.

### ● Headphone Jack

This can be connected to headphones.

### ● Master Volume

These are two independent controls which control the volume of the left and right channels, thus acting as an overall volume controls for the BX-800. At the "10" position, the volume is highest, and at '0' lowest.

---

### Important Notes

● The BX-800 may become warm during operation, but this is quite a normal situation caused by AC powered operation, so there is nothing to worry about it.

● If the BX-800 is not in use, turn it off.







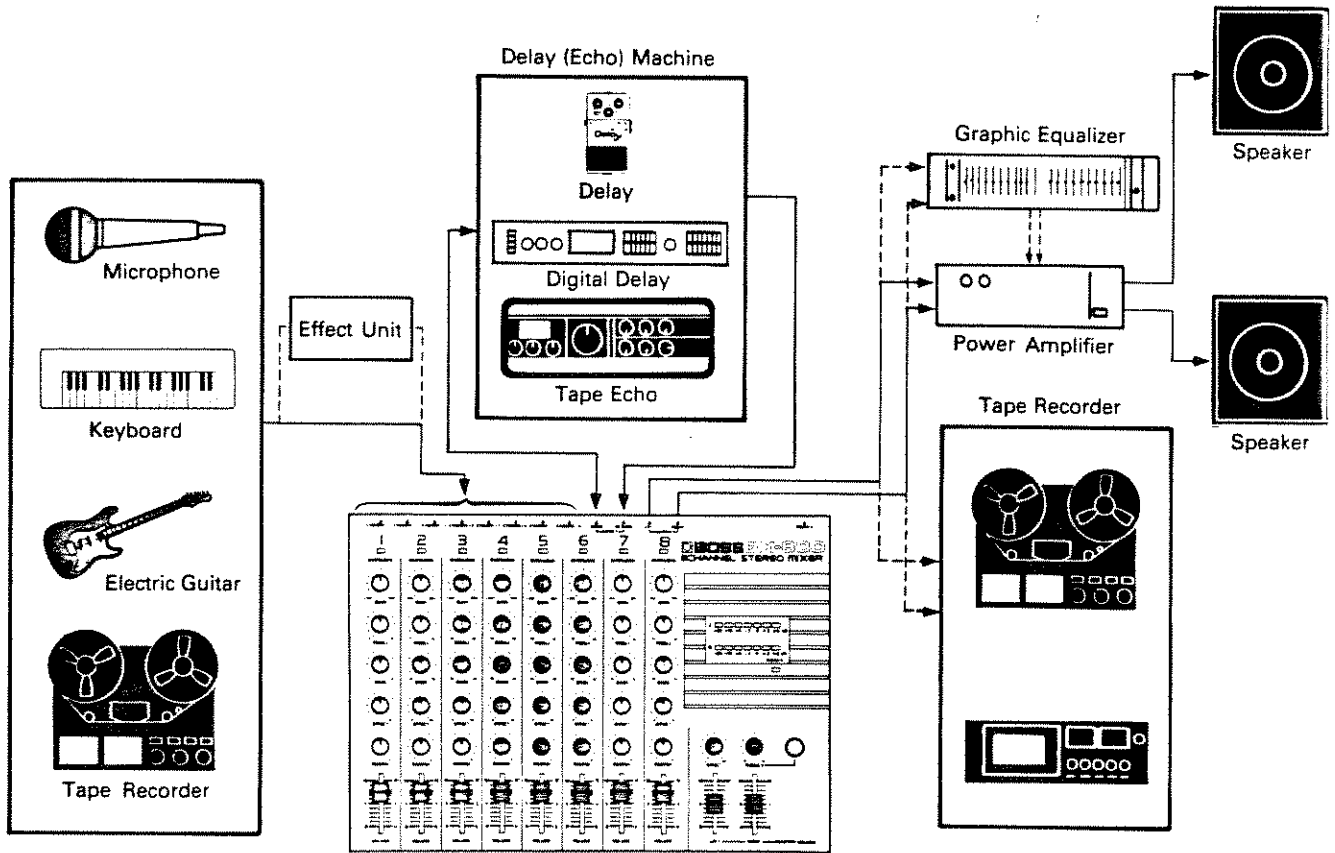



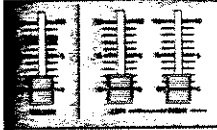

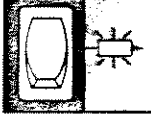
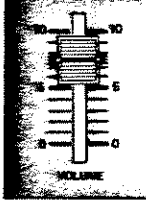

● Please avoid using the BX-800 in extreme heat or humidity or where it may be affected by dust.

---

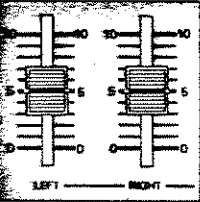
■ CONNECTIONS



■ OPERATION

 <p>1. After setting up the BX-800, set each Gain Control to LINE. Then set each Channel Volume and Master Volume to zero.</p> 	 <p>6. Set the Treble and Bass to appropriate levels.</p>	<p>10. If the Overload Indicator lights, the sound is distorted, so you need to reduce the channel volumes, the Gains or the Level Indicator +3 or +6dB or the Master Volume Controls.</p> 
 <p>2. Make sure that the BX-800 is turned off, then plug in the Power cord.</p>	<p>7. Set the Panpot control to an appropriate level.</p>    <p>△If you wish to hear sound only from the Left Channel, set the Panpot control to the L position.</p> <p>△If you wish to hear sound from the both Channels, set the Panpot to the centre position.</p> <p>△If you wish to hear sound only from the Right Channel, set the Panpot Control to the R position.</p>	<p><b>When using effect units</b></p>
 <p>3. Turn up the Power Switch, and make sure that the Power Indicator lights up.</p>	<p>8. Set each Channel Volume to an appropriate position. (Set the volume of the channel not in use to zero.)</p> 	<p>11. Set the relevant Effect Volume Controls to appropriate positions.</p> 
<p>4. Turn the external devices (such as an amplifier) on.</p>	<p>9. Set the Master Volumes to appropriate positions.</p> 	<p>12. Set each Effect Return Volume Controls to an appropriate position.</p> 
<p>5. Set the Gain Control to an appropriate level.</p>    <p>△LINE = Electronic Keyboard, Tape Recorder, etc.</p> <p>△INST = Electric Guitar, Electronic Keyboard, etc.</p> <p>△MIC = Microphone</p>	<p>13. Repeat procedure 10</p>	<p><b>When using headphones</b></p>
		<p>14. Connect Stereo headphones to the Headphone Jack, then set the Headphone Level Control to an appropriate position.</p> 

■ PANEL ILLUSTRATION

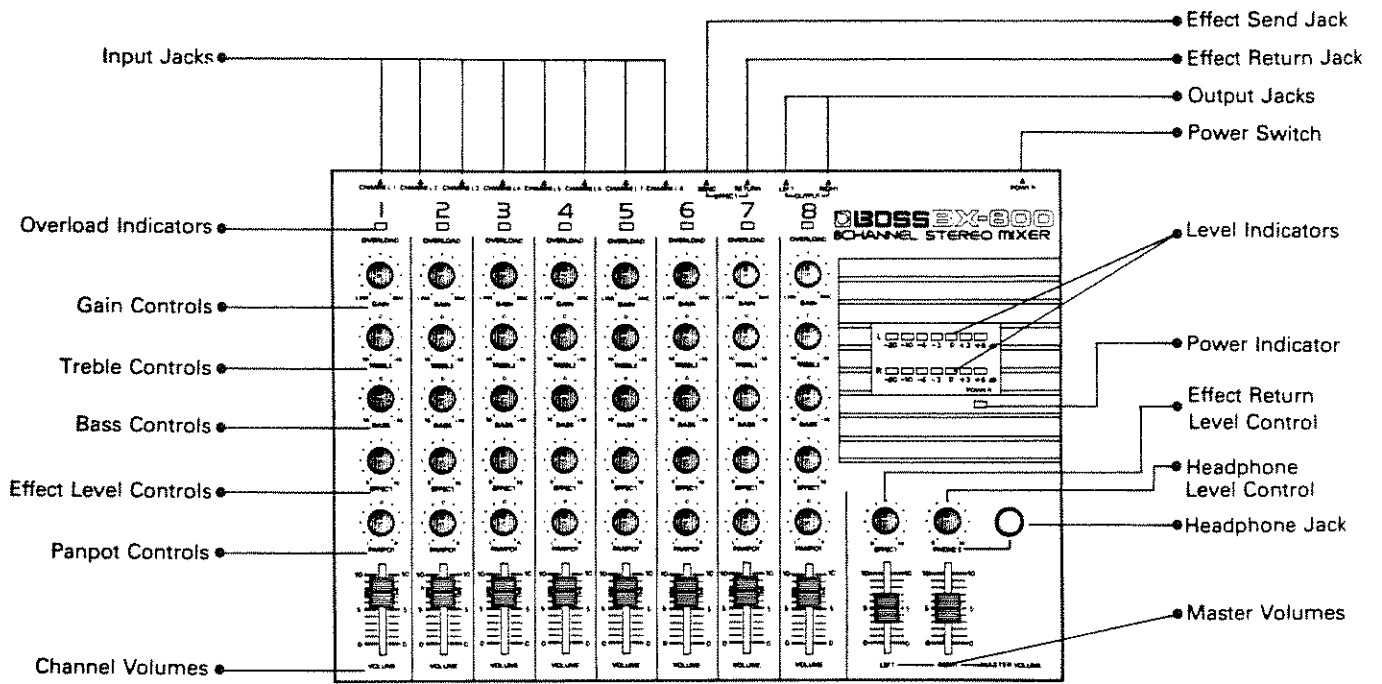

## SPECIFICATIONS

Input Level (Rated):	-50dBm to +4dBm
Input Impedance:	1.8k $\Omega$ to 160k $\Omega$
Output Level (Rated):	+4dBm
(Max):	+21dBm
Output Load Impedance:	more than 10k $\Omega$
Effect Send/Output Level (Rated):	-20dBm
/Load Impedance:	more than 10k $\Omega$
Effect Return/Input Level (Rated):	-20dBm
/Input Impedance:	47k $\Omega$
Equalizer/Treble:	$\pm 10$ dB/10kHz
/Bass:	$\pm 10$ dB/100Hz
Headphones:	50mW/30 $\Omega$
Equivalent Input Noise:	-113dBm (IHF-A)
Frequency Response:	20Hz to 40kHz ( $\pm 3$ dB)
(at minimum Gain):	* 0dBm = 0.775V
Controls:	Gain Controls $\times 8$
	Treble Controls $\times 8$
	Bass Controls $\times 8$
	Effect Level Controls $\times 8$
	Panpot Controls $\times 8$
	Channel Volumes $\times 8$
	Master Volumes $\times 2$
Main Controls:	Effect Return Level Control $\times 1$
	Headphone Level Control $\times 1$
	Power Switch $\times 1$
Jacks:	Input Jacks $\times 8$
	Effect Send Jack $\times 1$
	Effect Return Jack $\times 1$
	Output Jacks $\times 2$
	Headphone Jack $\times 1$
Indicators:	Overload Indicators $\times 8$
	Power Indicator $\times 1$
	Level Indicators $\times 2$
AC Power:	117/220/240V AC 50/60Hz
Consumption:	13W
Dimensions:	325(W) $\times$ 76(H) $\times$ 236(D)mm/ 12 $\frac{3}{4}$ (W) $\times$ 3(H) $\times$ 9 $\frac{1}{4}$ (D)in.
Weight:	2.2kg/4lb. 14 oz.

\* Specifications are subject to change without notice.

## BLOCK DIAGRAM

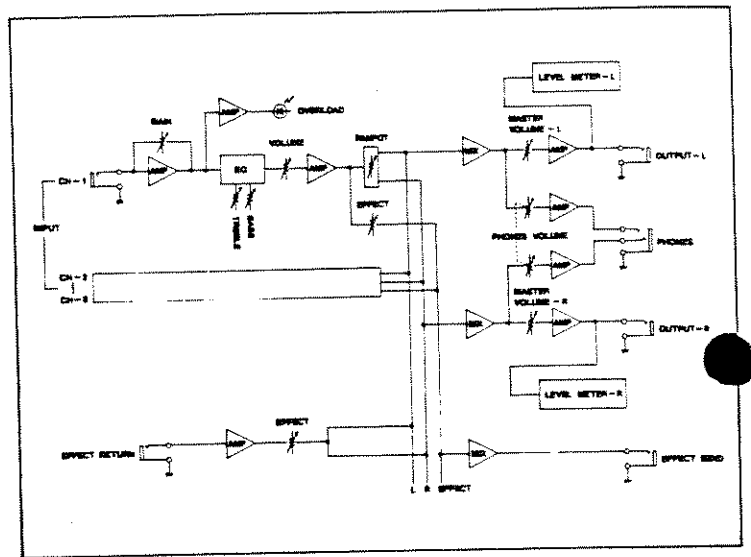

**BOSS**  
Products of Roland

**Roland**  
**RUS10067**

UPC

RUS10067



1 4981