

BALANCED MODULATOR

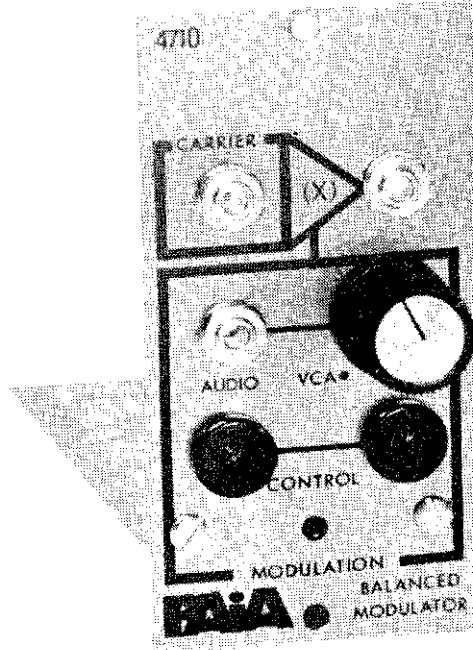

Conventional synthesizer components provide the user a multitude of sources of sound waveforms that are rich in harmonically related frequencies, but only the Balanced Modulator provides the basis for generating sounds with component frequencies spaced according to non-harmonic intervals. While natural sounds with these properties are less than numerous (chimes, gongs, certain man-made whistles, insects and others), the sound of the suppressed carrier waveform can be one of the most distinctively "electronic".

The inputs and controls of the PAIA 4710 Balanced Modulator have been arranged to provide for this module's convenient use as an auxiliary Voltage Controlled Amplifier as well as a sine wave frequency doubler.

SPECIFICATIONS

POWER REQUIREMENTS:	+ 18v. @ 10ma. + 9v. @ 1.5ma. - 9v. @ 7ma.
INPUT IMPEDANCE:	Carrier - 5K nominal Modulation - 50K nominal Control - 680K
OUTPUT IMPEDANCE:	3K nominal
FREQUENCY RESPONSE:	15 Hz. to 30 kHz.
CARRIER/MOD. REJECTION	50 db. typical

SOLDERING

Use care when mounting all components. Use only rosin core solder (acid core solder is never used in electronics work.) A proper solder joint has just enough solder to cover the round soldering pad and about 1/16 inch of the lead passing through it. There are two improper connections to beware of: Using too little solder will sometimes result in a connection which appears to be soldered but actually there is a layer of flux insulating the component lead from the solder bead. This situation can be cured by re-heating the joint and applying more solder. If too much solder is used there is the danger that a conducting bridge of excess solder will flow between adjacent circuit board conductors forming a short circuit. Unintentional bridges can be cleaned off by holding the board up-side down and flowing the excess solder off onto a clean hot soldering iron.

Select a soldering iron with a small tip and a power rating not more than 35 watts. Soldering guns are completely unacceptable for assembling transistorized equipment because the large magnetic field they generate can damage solid state components.

CIRCUIT BOARD ASSEMBLY

- () Prepare for assembly by thoroughly cleaning the conductor side of the board with a scouring cleanser. Rinse the board with clear water and dry completely.

Solder each of the fixed value resistors in place following the parts placement designators printed on the circuit board and the assembly drawing figure 2. Note that the fixed value resistors are non-polarized and may be mounted with either of their two leads in either of the holes provided. Cinch the resistors in place prior to soldering by putting their leads through the holes and pushing them firmly against the board; on the conductor side of the board bend the leads outward to about a 45° angle. Clip off each lead flush with the solder joint as the joint is made. Save the lead clippings for use as jumpers in later steps.

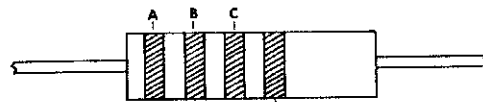

figure 1

silver or gold - disregard this band.

DESIGNATION	VALUE	COLOR CODE A-B-C
() R1	47K	yellow-violet-orange
() R2	680K	blue-grey-yellow
() R3	680K	blue-grey-yellow
() R4	220K	red-red-yellow
() R5	270	red-violet-brown
() R6	1800	brown-grey-red
() R7	27K	red-violet-orange
() R8	470	yellow-violet-brown
() R9	470	yellow-violet-brown
() R10	27K	red-violet-orange
() R11	1K	brown-black-red
() R12	1K	brown-black-red
() R13	27K	red-violet-orange
() R14	150	brown-green-brown
() R15	150	brown-green-brown
() R16	27K	red-violet-orange
() R17	470	yellow-violet-brown
() R18	4700	yellow-violet-red
() R19	3900	orange-white-red
() R20	3900	orange-white-red
() R21	330	orange-orange-brown
() R22	330	orange-orange-brown
() R23	100	brown-black-brown

NOTE: that R26 is not installed at this point.

Install the ceramic disk capacitor. The value of this capacitor is marked on the body of the part.

- () C4 100 pf ceramic disk

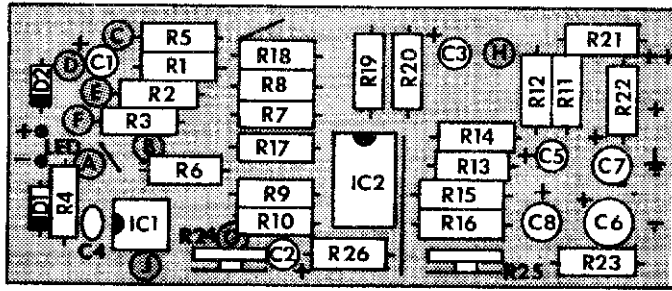

Figure 2

Up to this point all components have been non-polarized and either lead could be placed in either of the holes provided without affecting the operation of the unit. Electrolytic capacitors are polarized and must be mounted so that the "+" lead of the capacitor goes through the "+" hole in the circuit board. In the event that the "-" lead of the capacitor is marked rather than the "+" lead it is to go through the unmarked hole in the circuit board.

Note that the operating voltage (v.) specified for a capacitor is the minimum acceptable rating. Capacitors supplied with specific kits may have a higher voltage rating than that specified and may be used despite this difference. For instance, a 100 mfd. 25v. capacitor may be used in place of a 100 mfd. 10v. capacitor without affecting the operation of the circuit.

Mount the following electrolytic capacitors and solder them in place. The values, voltage rating and polarization are marked on the body of the part.

DESIGNATION	VALUE
() C1	2.2 mfd. 6v.
() C2	2.2 mfd. 6v.
() C3	2.2 mfd. 6v.
() C5	2.2 mfd. 6v.
() C6	33 mfd. 16v.
() C7	33 mfd. 10v.
() C8	100 mfd. 10v.

There are two "flea clips" on the circuit board that in a later step will be used to mount the Light Emitting Diode (LED) modulation indicator. Solder these clips in place at this time. Note that when properly installed the upright portions of the "U" shape of this clip will be pointing toward the closest edge of the circuit board. (see figure 5)

- () Install the two LED supporting flea clips.

Install the diodes D1 and D2. Note that these parts are polarized and must be properly oriented in order to operate properly. Polarization of the diodes is indicated by a colored band on one end of the case. Install as shown in figure 2. The physical appearance of the device is related to the schematic symbol used on the circuit board parts placement designators in figure 3.

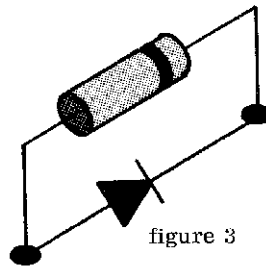

DESIGNATION	VALUE
() D1	1N914
() D2	1N914

- () Using the excess leads clipped from resistor installation, form and install the three wire jumpers indicated by the solid lines printed on the circuit board and shown in the parts placement diagram figure 2.

Install the trimmer potentiometers.

() R24	50K trimmer
() R25	50K trimmer

Mount the integrated circuits. Note that the orientation of the integrated circuit is keyed by a notch at one end of the case which aligns with the semi-circular key on the designator printed on the circuit board. Use particular care when installing this part, like any other semi-conductor it is heat sensitive and should not be exposed to extraordinarily high soldering temperatures. Make sure that the orientation is correct before soldering, once the unit is in place it cannot be removed without destroying it.

DESIGNATION	DESCRIPTION
() IC-1	748 op-amp
() IC-2	1496 Balanced Modulator

NOTE: Availability of integrated circuits is such that all kits may not have a 14 pin Dual In-line Package (DIP) for IC-2. The alternate package is a TO-5 metal can and should be installed as shown. Note that not all of the holes that are part of the DIP are used by the 10 leads of the TO-5 can.

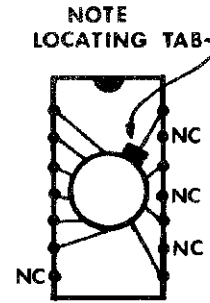

Figure 4

In the following steps wires will be soldered to the circuit board which will later connect to the front panel controls and jacks. At each step prepare the wire by cutting it to the specified length and stripping 1/4 inch of insulation from each end of the wire. "Tin" each end of the wire by twisting the exposed strands tightly together and melting a small amount of solder into the wire.

Using the wire provided make the following connections to the circuit board.

- () a 3 inch length to point "A".
- () a 3 inch length to point "B".
- () a 3 inch length to point "C".
- () a 2 1/4 inch length to point "D".
- () a 1 inch length to point "E".
- () a 1 1/2 inch length to point "F".
- () a 4 1/2 inch length to point "G".
- () a 6 3/4 inch length to point "H".
- () a 3 1/2 inch length to point "J".

You are now ready to mount the Light Emitting Diode. First examine this part carefully and note that one of the leads is marked with a color band. This color band marks the anode of the LED and when this component is properly installed its anode band will be on the opposite side of the device as are the bands on the conventional diodes D1 and D2. Note that the leads on the LED are fragile - excessive handling will fatigue the leads and cause them to break.

Observe that the rear side of the case of the LED is flat, while the front side is roughly dome shaped. In a later step the front dome shaped side of the package will match up with a hole in the front panel.

Bend the leads of the LED loosely back. Do not use pliers to form a right angle bend in the leads.

Elevate the front edge of the circuit board slightly and place the remaining resistor between the edge of the circuit board and the previously installed "flea clips". This resistor will serve as a spacer and assist in getting the LED installed at the proper height in the clips.

Slip the leads of the LED into the clips such that they rest on the resistor and are roughly parallel with the surface of the circuit board.

The ends of the LED leads should be even with the rear edges of the clips. Make sure that the lead with the color band is in the clip closest to D2, the clip marked "+". Lightly solder the LED leads to the clips.

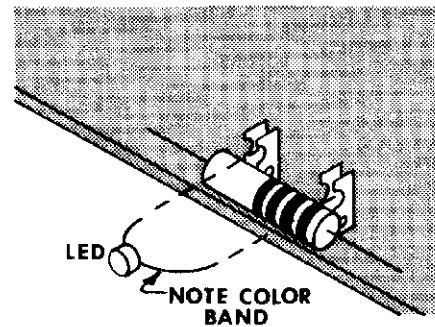

Figure 5

Install the remaining resistor on the circuit board.

- () R26 4700 yellow-violet-red

THIS COMPLETES ASSEMBLY OF THE 4710 PRINTED CIRCUIT BOARD. TEMPORARILY PUT THE BOARD ASIDE AND PROCEED TO THE INSTALLATION OF THE JACKS AND CONTROLS.

Place the front panel face down on a soft rag to prevent marring the finish.

- () Place a black pin jack (J2) in the hole provided as shown in figure 7 and fasten in place with a Tinnerman nut as shown in detail figure 6. Press the Tinnerman nut down firmly.
- () In a similar manner mount black pin jack J3 as shown in figure 7 and fasten in place.
- () Mount the miniature phone jack J1 to the front panel in the position shown in figure 7. Orient the jack as shown and fasten in place with the nut provided. Carefully tighten the nut **completely**. If the nut is of the knurled type it may be tightened by putting the points of the jaws of a small pair of diagonal cutters into the notches in the nut and using the cutters as a spanner.
- () In a similar manner mount the miniature phone jack J4.
- () In a similar manner mount the miniature phone jack J5.

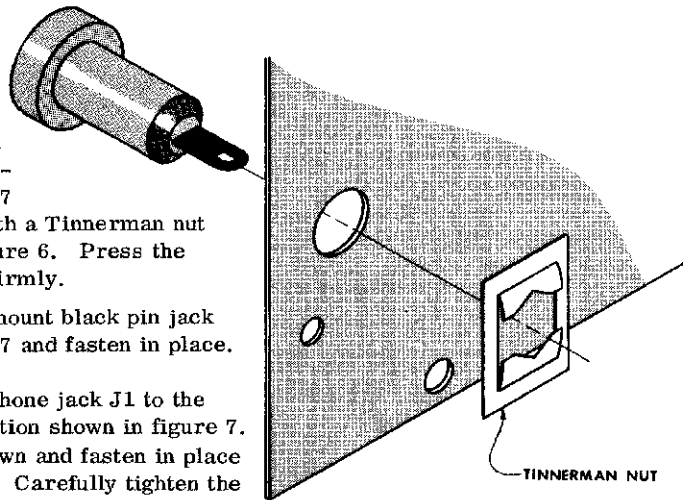

Figure 6

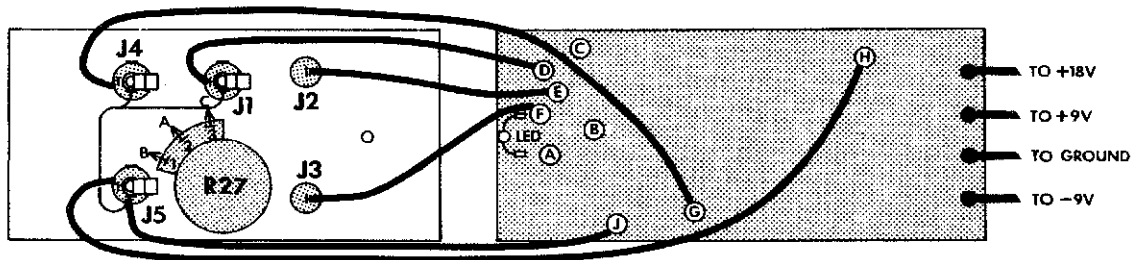

Figure 7

- () Mount the 5K ohm potentiometer in the location shown in figure 7. Use the two 3/8 inch nuts provided, one behind the front panel as a spacer and the second on the front side of the panel to secure the potentiometer. Adjust the rear nut so that none of the threaded bushing of the control is exposed when the nut is tightened down. This will allow the control knob which will be mounted in a later step to seat as closely as possible to the front panel. Orient the potentiometer precisely as illustrated.
- () Using the bare wire provided make connections between the ground lugs of phone jacks J1, J4 and J5. These are the bottom lugs of each jack when the panel is oriented as in figure 7. At J4 this wire need only be passed through the hole in the lug, a tight crimp connection is not necessary. Solder the wire at jacks J1 and J4 but **DO NOT SOLDER TO LUG J5 AT THIS TIME**.

- () Fasten the two "L" brackets to the front panel using one 4-40 X 1/4" machine screw, two lock washers and a 4-40 nut as shown in figure 8. Note that the unthreaded hole on the "L" bracket is used in this operation. **DO NOT COMPLETELY TIGHTEN THESE SCREWS AT THIS TIME.**

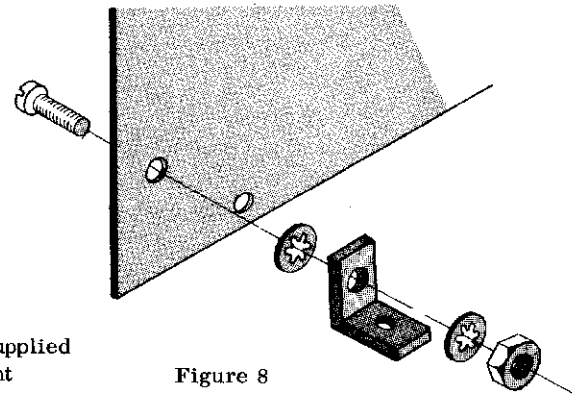

Figure 8

- () An insulating "dot" has been supplied to prevent the leads of the Light Emitting Diode from shorting against the front panel. Remove this "dot" from its cardboard backing and apply to the rear of the front panel so that the hole in the dot is centered over the LED hole in the front panel. (see fig. 9)

THE FRONT PANEL MAY NOW BE BOLTED TO THE CIRCUIT BOARD AS FOLLOWS:

- () When mounting the circuit board to the front panel note that the dome front of the LED is designed to fit into the small hole in the front panel. To most easily accomplish this, "cock" the circuit board in relation to the front panel and pass one 4-40 screw through the circuit board into the threaded hole in the "L" bracket as shown in figure 9. DO NOT COMPLETELY TIGHTEN THIS SCREW.

Pivot the circuit board toward the front panel and make sure that the LED engages the front panel hole. The leads on the LED may be slightly long causing them to bend slightly but this springing action is useful in holding the lamp securely in the hole.

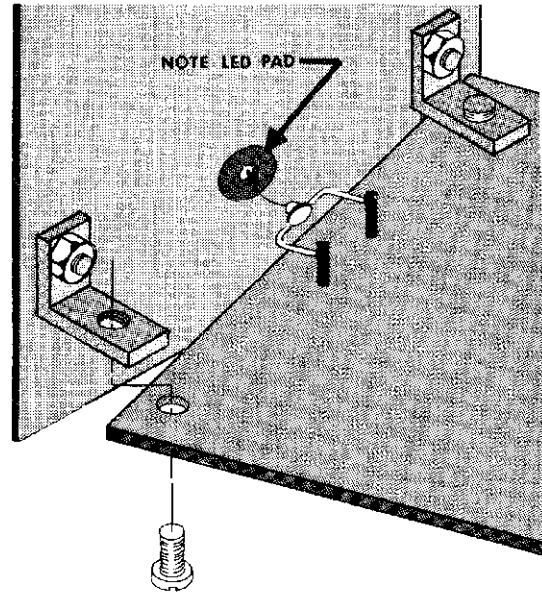

Figure 9

- () When the hole in the circuit board aligns with the threaded hole in the "L" bracket fasten the two together with the remaining 4-40 X 1/4" machine screw.

AT THIS POINT THE 4 SCREWS JOINING THE FRONT PANEL AND CIRCUIT BOARD MAY BE TIGHTENED COMPLETELY.

MAKE FINAL FRONT PANEL CONNECTIONS AS FOLLOWS:

- () Route the wire originating at point "C" on the circuit board between pin jacks J2 and J3 and attach it to lug 3 on potentiometer R27 as shown in figure 7. SOLDER THIS CONNECTION.
- () Connect the lead originating at point "A" on the circuit board to lug 2 on potentiometer R27. SOLDER THIS CONNECTION.
- () Connect the lead originating at point "B" on the circuit board to lug 1 on potentiometer R27. SOLDER THIS CONNECTION
- () Dress the three leads just installed as closely to the front panel as possible.
- () Connect the wire originating at circuit board point "E" to the lug on pin jack J2. SOLDER THIS CONNECTION.
- () Connect the wire originating at circuit board point "F" to the lug on pin jack J3. SOLDER THIS CONNECTION.
- () Route the wire originating at point "H" on the circuit board down the board, between R7 and R17 and up the front panel. Connect this wire to the center lug of miniature phone jack J5. SOLDER THIS CONNECTION.
- () Connect the wire originating at point "D" on the circuit board to the middle lug on miniature phone jack J1. SOLDER THIS CONNECTION.
- () Connect the wire originating at point "G" on the circuit board to the middle lug on miniature phone jack J4. SOLDER THIS CONNECTION. Dress this lead as closely as possible to both the circuit board and front panel.
- () Connect the wire originating at point "J" on the circuit board to the ground lug on J5. SOLDER THE TWO WIRES CONNECTED TO THIS LUG.
- () Rotate the shaft of sensitivity control R27 fully counter-clockwise as viewed from the front of the panel and push on the knob so that the pointer aligns with the dot following the designation "VCA".
- () Four "flea" clips have been included to facilitate power supply connection. Insert these clips in the holes at the end of the circuit board marked "++", "+", "-", and "⊕". Solder in place.

THIS COMPLETES ASSEMBLY OF THE 4710 BALANCED MODULATOR MODULE.

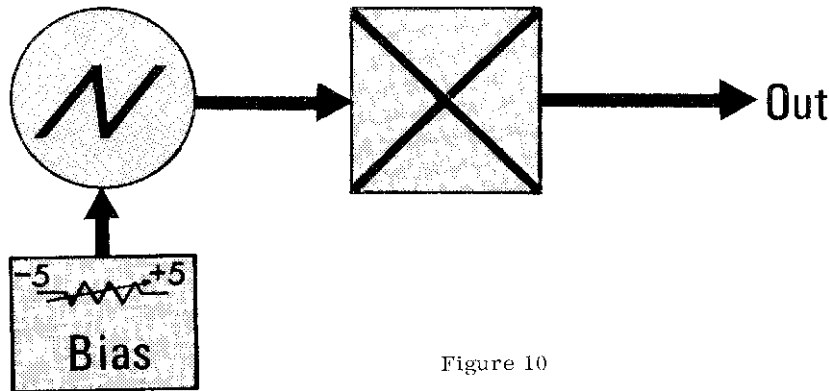

Figure 10

TESTING AND CALIBRATION

Before proceeding with testing and calibration thoroughly check the bottom of the circuit board for solder bridges and cold solder joints. Re-check parts placement and values.

You would expect that a module as sophisticated as the 4710 Balanced Modulator would require equally sophisticated test gear for its calibration. Not so, the only equipment required for calibration is gear that you already have on hand as part of the synthesizer. You will use the synthesizer's power supply, VCO and whatever external amplifier you have been using.

Begin by applying power to the connectors on the back edge of the circuit board. "++" goes to +18v., "+" to +9v., the (\equiv) symbol to ground and "-" connects to -9v. As shown in figure 10, use the -5 to +5volt bias source on the power supply to set the pitch of the oscillator to some intermediate frequency (exact pitch is not critical). Jumper the output of the Balanced Modulator to the input of the external amplifier.

Connect the triangle output of the VCO to the miniature phone jack audio modulation input and advance the modulation level control in a clockwise direction. At some point in the rotation of this control the modulation level indicator light should come on dimly and its brightness should increase as the control is rotated further clockwise. This indicates that the modulation buffer amplifier is working properly.

Rotate the modulation level control counter-clockwise until the point is reached at which the modulation level indicator light just goes out. At this point chances are that you will also be hearing a tone from the amplifier which indicates that the modulation input is not properly balanced. As the Modulation rejection trimmer (R25, marked MOD) is adjusted there should be a point near the center of its rotation at which the volume of the tone from the amplifier decreases noticeably. Careful adjustment of this control should suppress the tone to the point that it is, for all practical purposes, inaudible. Notice that if the front panel modulation level control is advanced to the point that the modulation level indicator light glows the tone will once again be heard. THIS IS AN UNNATURAL OPERATING CONDITION. In normal operation the modulation level indicator lamp will be extinguished.

Rotate the front panel modulation level control fully counter-clockwise. Remove the input to the audio modulation jack and re-connect it to the carrier input jack. You will probably hear the tone again. As with the modulation rejection trimmer, now adjust the carrier trimmer (R24, marked CAR.) until the tone is suppressed as much as possible.

NOTE: If it seems that the carrier and modulation are not being rejected completely bear in mind that the volume of your amplifier is probably set to a higher level than you would normally use. As a quick reference, jumper the VCO output directly to the amplifier, set the volume control for normal audio signal level and then once again check carrier and modulation rejection levels. Under these conditions there should be no noticeable output from the module.

With the output of the VCO connected to the carrier input of the Balanced Modulator and the modulation level control fully CCW, jumper the 0 to +5v. bias source of the Power Supply module to either of the control voltage input pin jacks and note that as the bias voltage increases the volume of the tone from the amplifier increases. At a control voltage input of 5 volts the volume of the tone should be about the same as it would be if the VCO were connected directly to the external amplifier.

USING THE 4710 BALANCED MODULATOR

Of all the processing modules available to the synthesist the balanced modulator is without a doubt the least understood and consequently the most difficult to employ

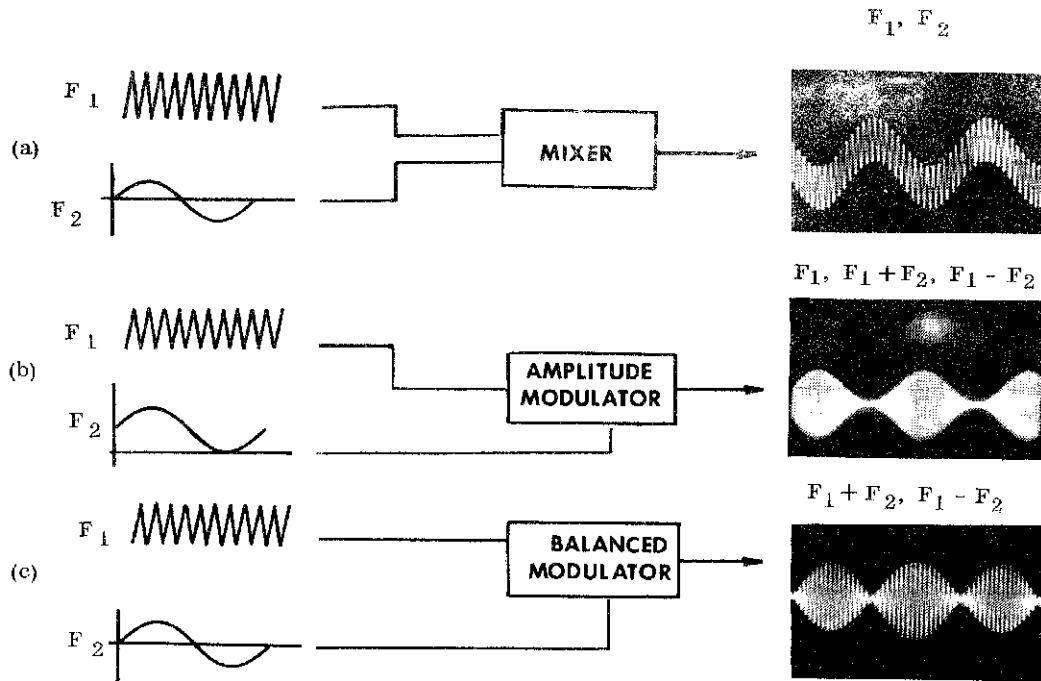

Figure 11

successfully. Before we even go over the operation of the controls we will take a few moments to go over exactly what this module is and does.

Balanced modulators are identified by a number of different names and to the average musician the most familiar is probably "ring" modulator. A ring modulator is simply a specific means of implementing a balanced modulator using a diode "ring" as the modulating element. As far as function is concerned there is no difference between the two.

For the purposes of this explanation a third name, "four quadrant multiplier", not only gives us something to call the module but as we shall shortly see is also an exact statement of what it does.

Figure 11 shows three possible ways of combining electronic signals - mixing, amplitude modulation, and balanced modulation - and the results of each process. Notice first that when two signals are mixed in the audio sense nothing changes. (figure 11a.) Two frequencies go in and the same two frequencies come out.

Figure 11b. shows the result of simple amplitude modulation and is representative of the situation that one normally encounters when working with a Voltage Controlled Amplifier. Two frequencies are applied to the inputs of the VCA and the amplitude of one directly determines the amplitude of the other. By convention, the higher of the two frequencies is commonly designated the "Carrier" and corresponds to the audio input of a VCA. The lower frequency is designated "Modulation" and corresponds to a control voltage input. There are a number of things of particular interest in figure 11b. For example, notice that this is a multiplier of sorts. When the modulation signal is zero, the output is zero and as the modulation voltage increases the output also increases. From working with VCA's we know that negative control voltages have no effect on the output, the amplifier is already off at zero volts and if anything, negative control voltages only turn it more off. In analog computer terms - and let's face it, a synthesizer is more analog computer than anything else - a VCA is a two quadrant multiplier, indicating that the multiplication process is valid for positive or negative carrier voltages but that the modulation input is constrained to only positive voltages. Notice the output of this two quadrant multiplier. Unlike the mixer, the output does not contain the two input frequencies. Instead, it contains the original carrier frequency and two brand new frequencies that are the sum of the original carrier and modulation frequencies and the difference of the two. These sum and difference frequencies are commonly called upper and lower sidebands respectively. Of particular note is the fact that the modulation frequency has been "rejected" and does not appear in the output. In a mathematical analysis, this is the reason that a good VCA will not "pop" when subjected to rapid control voltage changes.

Figure 11c. illustrates a balanced modulator. Once again we have the multiplication process in which increasing the voltage at the modulation input produces increased output level, but notice that in this case we have eliminated the constraint of keeping the modulation voltage always positive. This, then, is a four quadrant multiplier in which the output is valid for positive and negative modulation signals as well as positive and negative carrier signals. NOTE: in a balanced modulator the terms "carrier" and "modulation" actually lose their meaning since as a practical matter these two signals are interchangeable. We will continue their use, however, because in the 4710 a distinction is made between these two signals to ease the module's use in auxiliary applications.

Notice the frequency content of the output. Not only have we dropped out the modulation signal as we did with the VCA, now we have rejected the carrier as well. Neither of the two original signals is present and only the side-bands remain. If we stick to sine waves as the inputs to the modulator not a lot has been accomplished because the side-bands are sine waves too. But, when non-sinusoidal inputs are used the situation becomes considerably more complicated and musically much more interesting.

As has been pointed out innumerable times, any non-sinusoidal waveform can be broken down into a summation of sine wave components of various phase, amplitude and frequency relationships. What hasn't been strongly stressed is that until you begin working with a balanced modulator you are restricted almost exclusively to sounds that are harmonically structured; they have a fundamental frequency followed by overtones that are all integral multiples of that frequency. As it happens, most natural sounds have these same properties but by no means all.

Figure 12 shows two frequency spectra, the first (a) for a balanced modulator with sine waves at both inputs and the second (b) with a square wave substituted for one of the sine

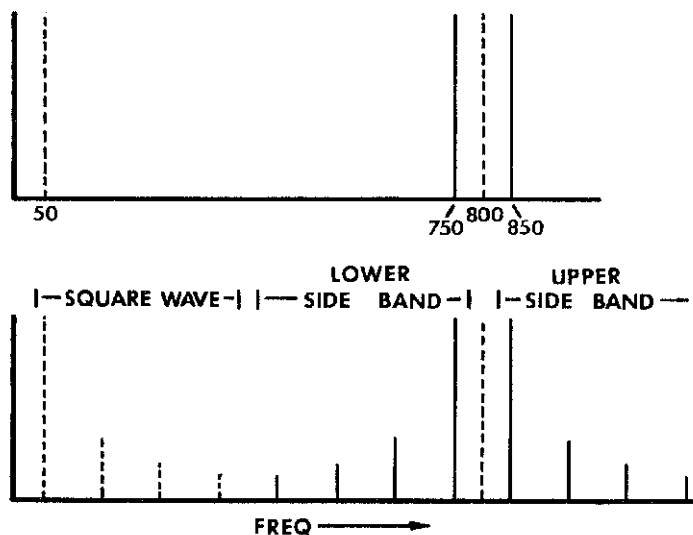

Figure 12

waves. In a frequency spectrum the position of some vertical line along the horizontal axis indicates the frequency of some component of the signal being examined while the height of the line indicates the relative amplitude of that component. For 50 Hz. and 800 Hz. sine wave inputs (dashed lines) the output (solid lines) consists of sinusoidal side-bands at 750 Hz. and 850 Hz.

Substituting a 50 Hz. square wave for the 50 Hz. sine wave produces the spectrum shown in (b). For simplicity only the first 4 harmonics of the square wave are shown and they appear at 50 Hz., 150 Hz., 250 Hz. and 350 Hz. respectively. These components are dropped out in the modulation process and in their place the side-bands appear. Each of the frequencies that appear in the side-bands is the sum or difference of one of the components in the square wave and the 800 Hz. carrier. Notice in particular that as predicted, these side-band components are non-harmonic; that is, there is no lowest frequency fundamental with additional components appearing at integral multiples.

OPERATION OF THE CONTROLS IS AS FOLLOWS:

CARRIER INPUT This miniature open circuit phone jack in the upper left hand corner of the front panel provides a capacitively coupled input to the module. Since this input is intended primarily to be driven from a synthesizer's Voltage Controlled Oscillator there is no provision for attenuation here but design parameters are such that the input will accept up to a 2v. peak to peak signal without overload or distortion.

MODULATION INPUTS There are a total of three modulation inputs to the module.

AUDIO The miniature phone jack in the middle of the left hand edge of the module provides a capacitively coupled, buffered access to the second input. This input is designed to accept a wide variety of sources such as electrified conventional instruments, VCO's, noise sources, etc. Maximum permissible signal level to this input is 1.5v. peak to peak.

CONTROL The two black pin jacks on the lower end of the module provide direct coupled summing access points to the second input of the balanced modulator. These jacks are intended as control voltage input points when using the balanced modulator as a VCA.

SENSITIVITY The sensitivity control in the right middle of the panel (upper right corner of the modulation control box) allows for optimization of a wide variety of modulation sources. Overall range of this control is approximately 34 db. Clockwise rotation of this control increases the sensitivity of the modulation input jacks.

MODULATION LEVEL INDICATOR The light emitting diode in the lower middle portion of the front panel gives a visual indication of an overload condition at any of the modulation inputs. Under normal operating conditions the sensitivity control will be advanced until the indicator glows and then reduced until the lamp goes out.

OUTPUT The miniature phone jack in the upper right hand corner of the module provides a capacitively coupled output from the circuitry.

CHIMES AND GONGS

Since we've spent so much time emphasizing the fact that the Balanced Modulator is primarily a source of non-harmonic frequencies, let's immediately duplicate a natural sound that is difficult to produce using more standard techniques; chimes and gongs.

The first sounds that most people do on a synthesizer are bells. They're easy (percussion envelope for high frequency sine or triangle), readily recognized by most listeners and add credence to the claim that any imagineable sound can be produced on a synthesizer. But the more you play with the equipment, the more you begin to realize that you're not getting any Big Ben type Gongs, only small sounding bells. There is a reason for this..

Small bells for the most part resonate at a single frequency with harmonic overtones while large gongs and chimes (by design or otherwise) produce sounds that are rich in non-harmonic frequencies. Given enough oscillators and a large enough mixer you could undoubtedly mix up some tone that when given a percussion envelope would sound something like a gong but the chore is considerably simplified by using a balanced modulator.

Figure 13 shows one way to do this by routing the sine output of a keyboard controlled VCO into the carrier input of the 4710 while using the triangle output of a manually controlled oscillator for the modulation input. The output of the balanced modulator is now treated the same as any other signal source and in this case is routed through a VCA which is under the control of a function generator for envelope shaping. The output of the VCA goes directly to the outboard amplifier. Rotate the sensitivity control until the modulation level indicator light goes on, then back off on the control until the light just goes out. Set the attack and decay times of the function generator for the fastest possible attack and medium decay. At this point pressing any key should produce an extremely realistic gong type sound. Some adjustment of the pitch of the modulation VCO may be necessary to achieve exactly the sound you have in mind for any given key.

Now would seem to be an appropriate time to demonstrate, and then investigate, something that to this point has only been vaguely implied. With the "gong" connection still intact try playing a simple tune on the keyboard. When you hear the results your first impulse may be to start looking for the loose connection that's caused your keyboard to go out of tune. Save your time. What has actually happened is much more subtle than a loose connection.

As we've already seen, a balanced modulator operating in a suppressed carrier mode drops out both the modulation and carrier frequencies and in their place generates side band frequencies that consist of the sums and differences of all the harmonics in each of the original inputs. The problem is that the carrier oscillator was providing the pitch information frequency and this signal has now been dropped out. The side-bands that have

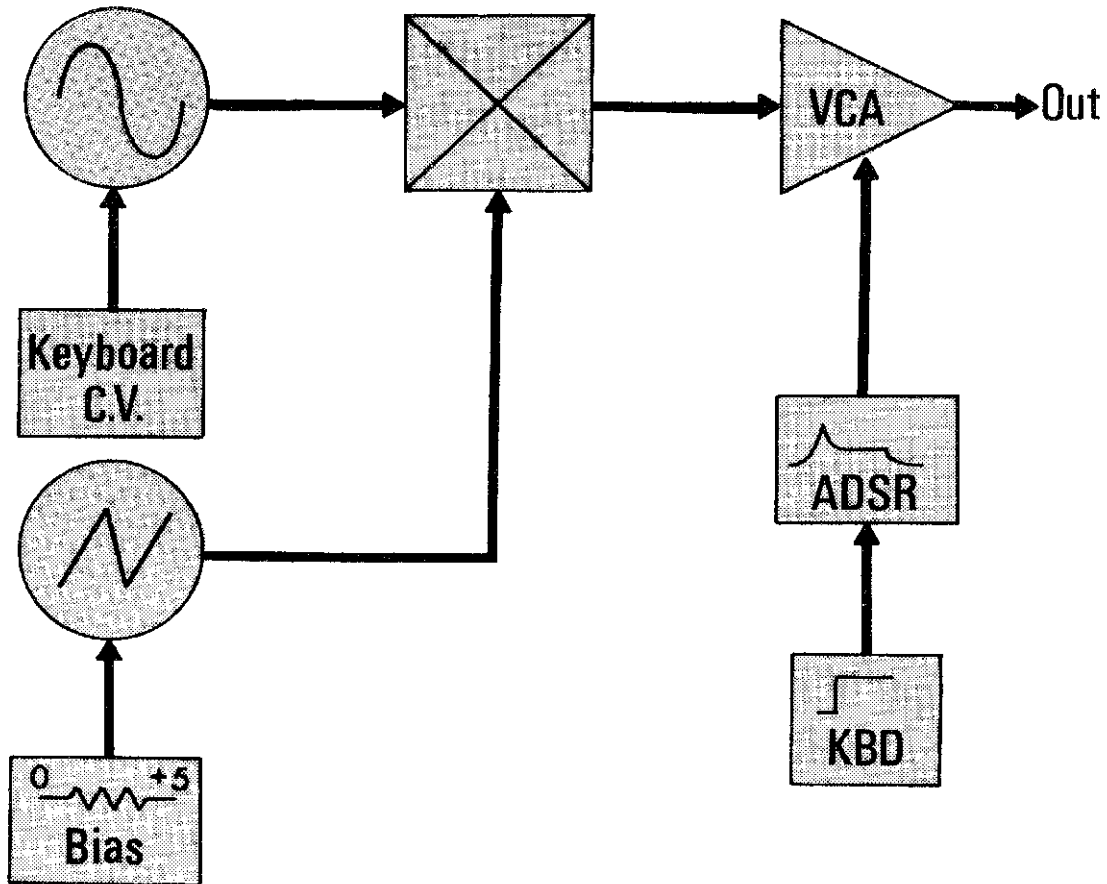

Figure 13

appeared in its place are unfortunately non-chromatic for reasons that trace back to their being sums of two frequencies rather than multiples of a frequency. The very physical laws that have provided us this interestingly textured sound also prevent its direct use in equally tempered musical scales. But, all is not lost. There are a number of ways that the original pitch information in the carrier can be recovered.

CARILLON

The most obvious, "brute force" method of recovering the carrier is to mix it back in using the mixing inputs found on the VCA. This works well but gives you only a mechanical (knob) control of the amount of carrier signal that appears in the final output. Since we decided long ago that voltage control was in most cases preferable to mechanical control it stands to reason that in this application a voltage controllable method of determining the amount of carrier that appears in the output is also desirable. The control voltage input jacks on the front of the 4710 provide a convenient way to do just that.

Referring back to figures 11 (b) and (c) for a moment we notice that common amplitude modulation does not eliminate the carrier and that the major difference between amplitude modulation and suppressed carrier modulation is that in the first the modulation input signal is not allowed to go negative. Since all three of the modulation inputs of the 4710 are summed together it is a simple matter to add a constant to the modulation input so as to "unbalance" the balanced modulator. The advantage here is that as the value of the constant is increased, the modulator becomes more unbalanced and more of the carrier appears in the output.

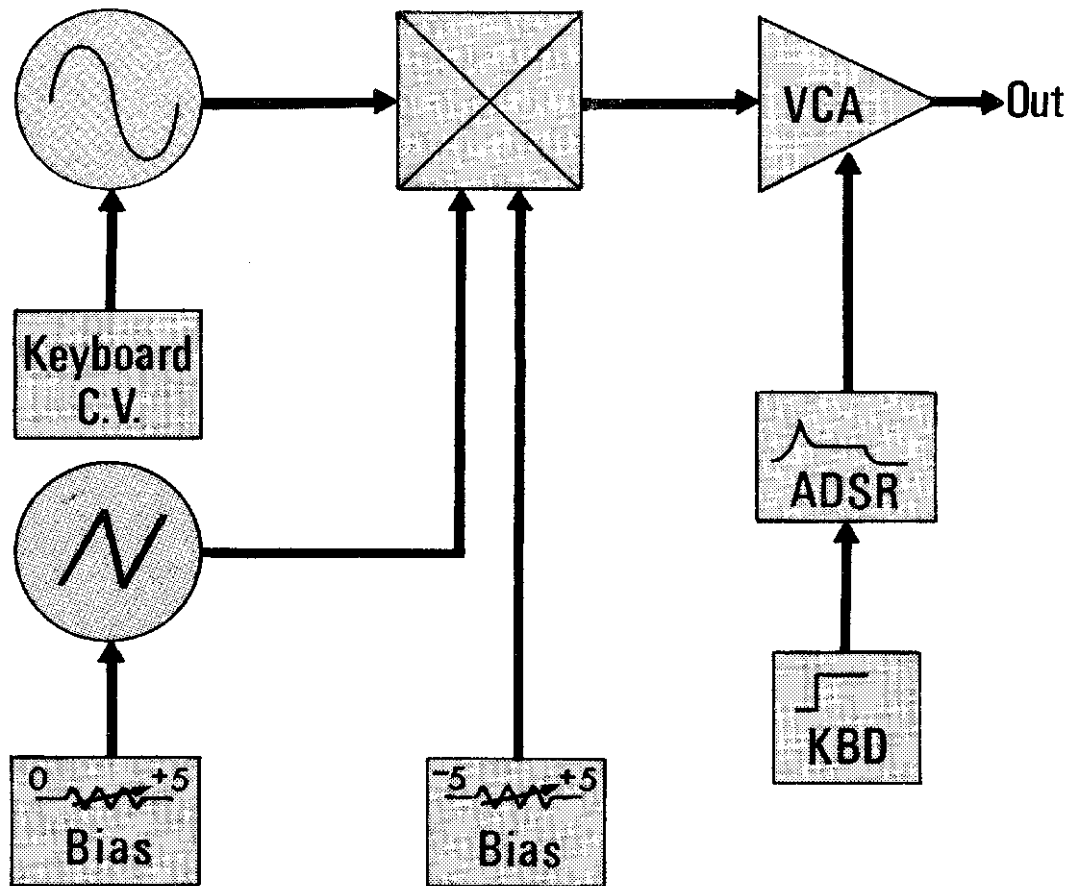

Figure 14

In practical terms this would be as shown in figure 14 where a control voltage is applied to one of the two control input pin jacks of the 4710. Ideally, either a positive or negative control voltage could be used but because of design limitation of the module a negative control voltage is considerably more suitable. As the magnitude of the control voltage is increased (in a negative direction) the amount of carrier frequency present in the output also increases.

To demonstrate this, using the gong connection, bias the control input at about -5v. and observe that you are now able to produce chromatic intervals on the keyboard. Observe that as the control voltage is decreased in amplitude (toward 0v.) the carrier disappears.

Standard voltage control techniques may now be used to produce time varying effects. For Example, if you wish to produce a sound that starts out with only side-bands in the output but finished with a strong carrier you can do it simply by adding a connection from the second output of the envelope function generator to the uncommitted control voltage input on the 4710. Here's what happens; when the function generator is triggered its output rapidly rises to 5v. which when summed to the -5v. from the bias supply produces an equivalent zero DC control voltage so that the balanced modulator is operating in the carrier suppression model. As the output of the function generator falls back to 0v. it leaves only the -5v. bias causing the modulator to be unbalanced so that the carrier feeds through.

At this point we have covered all of the basic principles involved in using the 4710 as a suppressed carrier modulator and enough practical applications have been cited to get you started. Complete coverage of all of the potential interconnections of the 4710 is impossible because of space limitations and undesirable because it could stifle individual creativity. Play, experiment; there are no possible combinations of intra-system connections that can damage the equipment. Try varying input waveforms and filtering of the carrier, modulation and/or output. Even the gong and carillon connections discussed have not been fully covered; try simulating rail-road type chime horns by simply changing from a fast attack on the function generator to a slow attack.

Meanwhile, there are other things the balanced modulator can do.

AUXILIARY VCA

We've already covered the differences between amplitude modulation and balanced modulation pretty thoroughly so it shouldn't take any great leap of the imagination to see that as long as the control voltage inputs are constrained to being between 0 and +5v. the balanced modulator will serve well as a Voltage Controlled Amplifier. We say "auxiliary VCA" simply because the typical carrier rejection of 50 db (which means that at normal room volumes the input signal may be barely audible when the module is supposed to be off) is not quite as good a spec. as you would want for your primary VCA. Unlike primary VCA's, negative control voltages will not serve to completely quiet the output; but rather, will cause the output to change phase. It seems that there should be some interesting application for this phase change somewhere (perhaps in conjunction with the enhanced filter connections mentioned in the 2720-12 Inverter/Buffer manual) but we have none to list here.

In operation, control voltages are applied to the CONTROL inputs just as they are in more conventional VCA's. The audio input is connected to the carrier input and the output taken from the output jack. When using the 4710 in VCA applications always rotate the level control fully counter-clockwise to the position indicated by the dot and "VCA" legend on the front panel.

Figure 15 a & b shows typical VCA waveforms with control voltage on top and resulting envelope on the bottom.

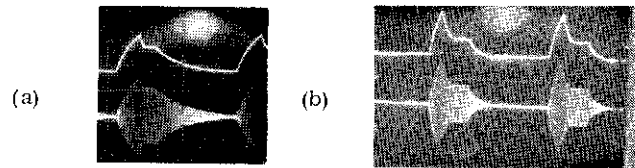

Figure 15

Lighting of the modulation level indicator lamp indicates that the module is at saturation and further increases in control voltage will produce no further increase in gain. This is an unnatural operating condition and unless you just happen to like seeing the light blink it should be avoided.

FREQUENCY DOUBLER

There is some danger of misunderstanding here so let's make one statement at the outset. THE 4710 WILL SERVE AS A TRUE FREQUENCY DOUBLE FOR SINE WAVE INPUTS ONLY. The connections that we will describe are valid for other excitation waveforms as well but strictly speaking the result will not be frequency doubling.

We have already seen (over and over again) that the output of the balanced modulator consists of frequencies that are the sum and differences of the two input frequencies. If the two input frequencies are the same, the difference frequency (lower side-band) disappears - any quantity subtracted from itself leaves nothing. The upper side-band on the other hand is the input frequency added to itself; in other words, twice the input frequency. Figure 16 (a) shows a schematic representation of the patch connection required. Ordinarily an auxiliary patch panel is used to make connections between the sine wave source and both carrier and modulation inputs simultaneously, and (b) of that figure is a photograph of an oscilloscope showing the lower frequency input (upper trace) and double frequency output. (lower trace)

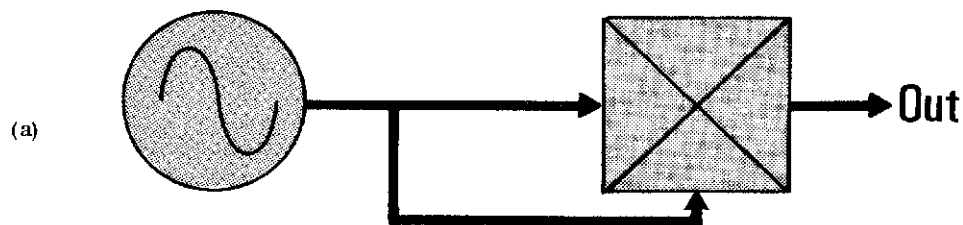

Frequency Doubler

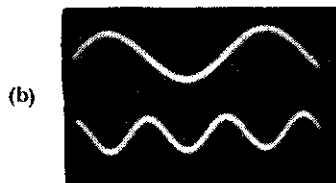

As with any of the other connections that we've discussed the modulation level control should be advanced until the over-load indicator lamp glows and then backed off until the lamp extinguishes. At this setting the amplitude of the input and output waveforms should be within 1 db. of each other. To answer in advance questions that we know are sure to be asked; yes, the output of one balanced modulator can be doubled again by using a second module. Frequency response of the 4710 is quite respectable and frequencies beyond the range of human hearing can be generated (though why you'd want to is beyond us).

PROCESSING CONVENTIONAL INSTRUMENTS

Many strange effects can be produced by using the output of a conventional musical instrument as the carrier input to the balanced modulator while using either a keyboard or foot controlled oscillator (or even a second instrument) as the modulation input. In the hands of a skillful user some of these effects even sound good.

In many cases interfacing the instrument to the 4710 is simply a matter of providing a patch cord with suitable jacks to fit both the 4710 and output connection of the instrument being used. Don't forget the ground on these cables. Within a single system grounds are established through the common power supply but when using external gear shielded cable should always be employed.

If extreme clockwise rotation of the modulation level control on the 4710 does not produce an overload indication of the modulation indicator lamp it is indicative of either an extreme mismatch between instrument and modulator impedances or low level output of the instrument. If increasing the output volume of the instrument produces no overload indication it would be best to first pre-amplify the signal (the PAIA 2720-12 Inverter/Buffer was designed to serve both as pre-amp and impedance matcher). It may seem contradictory, but once it has been established that the over-load indicator will glow the modulation level control should be rotated counter-clockwise to the point that it no longer does (glow, of course). **EXTREME DISTORTION WILL RESULT ANY TIME THE OVER-LOAD INDICATOR LAMP GLOWS DURING NORMAL OPERATION.**

DESIGN ANALYSIS

The 4710 Balanced Modulator is built around a type 1496 balanced modulator integrated circuit. The internal workings of this I. C. package are not pertinent to this discussion but certain general points should be made.

The 1496 chip has differential inputs for both carrier and modulation ports. Biasing for the carrier inputs (pins 8 and 10) are supplied by the voltage divider consisting of R11 and R12 with this biasing voltage coupled to the IC through R14 and R15. Input signals applied to the carrier input jack J4 are capacitively coupled by C2 to input isolating resistor R26 and finally appear across R14. Fixed resistors R13 and R16, along with trim pot R25 are used to supply adjustable current into the carrier input port to balance out variations that occur in the integrated circuit during manufacture. With no signal applied to either of the inputs there should be 7v. \pm 20% present at pins 8 and 10 and at the junction of R11 and R12.

The modulation inputs (pins 1 and 4) are similar to the carrier inputs except that they are tied to ground through R8 and R9 with R7, R10 and trimmer R24 supplying tolerance compensating bias currents. Pins 1 and 4 should read 0v. \pm 0.1v.

R19 and R20 serve as load resistors for IC-2 with the in-phase output coupled to output jack J5 by way of C3. Quiescent voltages at pins 6 and 12 should be 8v. \pm 20%.

The modulation input of the 4710 module is buffered by the 748 type operational amplifier IC-1. Control voltages are direct coupled to the inverting input of this IC by R2 and R3 while audio signals are capacitively coupled by R1 and C1. With the modulation LEVEL control fully counter-clockwise and no signals present at the inputs, pin 6 of IC-1 should be at 0v. \pm 0.1v.

Rotating the LEVEL control in a clockwise direction causes less of the output of the operational amplifier to appear as feed-back at the inverting input which in turn causes the voltage gain of this amplifier to go from approximately 4.5 to 90 (13 - 40 db.) for signals applied to the audio input and 0.3 to 6.3 (-10 to 16 db.) for signals applied to the control inputs. The voltages at pins 2 and 3 of IC-1 should be 0v. \pm 0.1v. and pins 7 and 4 are positive and negative supply respectively.

The overload Light Emitting Diode becomes forward biased and begins to conduct on negative excursions of the output of IC-1. Because of the forward voltage drops of D1 and D2, as well as the LED itself, conduction begins to occur at about -2v. The output of the buffer amplifier is coupled to IC-2 through R6.

Power supply decoupling is provided by the combinations R21, C6; R22, C7 and R23, C8. The voltages across C6, C7 and C8 respectively should be 13v. , 7v. and -8v. $\pm 20\%$.

