

MOTU 896mk3™

User Guide for Mac

MOTU

1280 Massachusetts Avenue
Cambridge, MA 02138
Business voice: (617) 576-2760
Business fax: (617) 576-3609
Web site: www.motu.com
Tech support: www.motu.com/support

SAFETY PRECAUTIONS AND ELECTRICAL REQUIREMENTS

CAUTION! READ THIS SAFETY GUIDE BEFORE YOU BEGIN INSTALLATION OR OPERATION. FAILURE TO COMPLY WITH SAFETY INSTRUCTIONS COULD RESULT IN BODILY INJURY OR EQUIPMENT DAMAGE.

HAZARDOUS VOLAGES: CONTACT MAY CAUSE ELECTRIC SHOCK OR BURN. TURN OFF UNIT BEFORE SERVICING.

WARNING: TO REDUCE THE RISK OF FIRE OR ELECTRICAL SHOCK, DO NOT EXPOSE THIS APPLIANCE TO RAIN OR OTHER MOISTURE.

CAUTION: TO REDUCE THE RISK OF ELECTRICAL SHOCK, DO NOT REMOVE COVER. NO USER-SERVICEABLE PARTS INSIDE. REFER SERVICING TO QUALIFIED SERVICE PERSONNEL.

WARNING: DO NOT PERMIT FINGERS TO TOUCH THE TERMINALS OF PLUGS WHEN INSTALLING OR REMOVING THE PLUG TO OR FROM THE OUTLET.

WARNING: IF NOT PROPERLY GROUNDED THE MOTU 896mk3 COULD CAUSE AN ELECTRICAL SHOCK.

The MOTU 896mk3 is equipped with a three-conductor cord and grounding type plug which has a grounding prong, approved by Underwriters' Laboratories and the Canadian Standards Association. This plug requires a mating three-conductor grounded type outlet as shown in Figure A below. If the outlet you are planning to use for the MOTU 896mk3 is of the two prong type, DO NOT REMOVE OR ALTER THE GROUNDING PRONG IN ANY MANNER. Use an adapter as shown below and always connect the grounding lug to a known ground. It is recommended that you have a qualified electrician replace the TWO prong outlet with a properly grounded THREE prong outlet. An adapter as illustrated below in Figure B is available for connecting plugs to two-prong receptacles.

Figure A

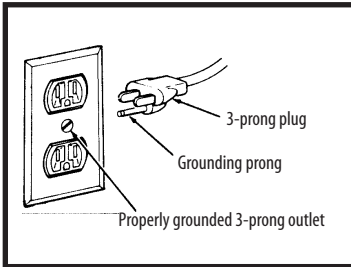
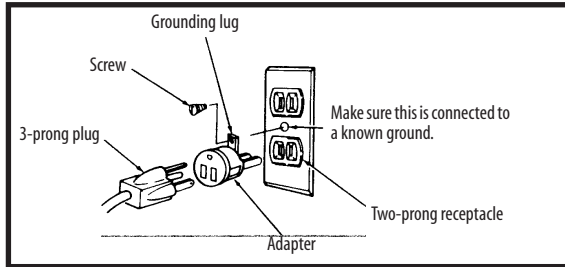

Figure B



WARNING: THE GREEN GROUNDING LUG EXTENDING FROM THE ADAPTER MUST BE CONNECTED TO A PERMANENT GROUND SUCH AS TO A PROPERLY GROUNDED OUTLET BOX. NOT ALL OUTLET BOXES ARE PROPERLY GROUNDED.

If you are not sure that your outlet box is properly grounded, have it checked by a qualified electrician. NOTE: The adapter illustrated is for use only if you already have a properly grounded two-prong receptacle. Adapter is not allowed in Canada by the Canadian Electrical Code. Use only three wire extension cords which have three-prong grounding type plugs and three-prong receptacles which will accept the MOTU 896mk3 plug.

IMPORTANT SAFEGUARDS

1. Read these instructions. All the safety and operating instructions should be read before operating the 896mk3.
2. Keep these instructions. These safety instructions and the 896mk3 owner's manual should be retained for future reference.
3. Heed all warnings. All warnings on the 896mk3 and in the owner's manual should be adhered to.
4. Follow all Instructions. All operating and use instructions should be followed.
5. Do not use the 896mk3 near water.
6. Cleaning - Unplug the 896mk3 from the computer and clean only with a dry cloth. Do not use liquid or aerosol cleaners.
7. Ventilation - Do not block any ventilation openings. Install in accordance with the manufacturer's instructions.
8. Heat - Do not install the 896mk3 near any heat sources such as radiators, heat registers, stoves, or another apparatus (including an amplifier) that produces heat.
9. Overloading - Do not overload wall outlets and extension cords as this can result in a risk of fire or electrical shock.
10. Grounding - Do not defeat the safety purpose of the polarized or grounding-type plug. A polarized plug has two blades with one wider than the other. A grounding-type plug has two blades and a third grounding prong. The wide blade or the third prong are provided for your safety. If the provided plug does not fit into your outlet, consult an electrician for replacement of the obsolete outlet.
11. Power cord - Protect the 896mk3 power cord from being walked on or pinched by items placed upon or against them. Pay particular attention to cords and plugs, convenience receptacles, and the point where they exit from the unit.
12. Power switch - Install the 896mk3 so that the power switch can be accessed and operated at all times.
13. Disconnect - The main plug is considered to be the disconnect device for the 896mk3 and shall remain readily operable.
14. Accessories - Only use attachments/accessories specified by the manufacturer.
15. Placement - Use only with the cart, stand, tripod, bracket or table specified by the manufacturer, or sold with the 896mk3. When a cart is used, use caution when moving the cart/apparatus combination to avoid injury from tip-over.
16. Surge protection - Unplug the 896mk3 during lightning storms or when unused for long periods of time.
17. Servicing - Refer all servicing to qualified service personnel. Servicing is required when the 896mk3 has been damaged in any way, such as when a power-supply cord or plug is damaged, liquid has been spilled or objects have fallen into the 896mk3, the 896mk3 has been exposed to rain or moisture, does not operate normally, or has been dropped.
18. Power Sources - Refer to the manufacturer's operating instructions for power requirements. Be advised that different operating voltages may require the use of a different line cord and/or attachment plug.
19. Installation - Do not install the 896mk3 in an unventilated rack, or directly above heat-producing equipment such as power amplifiers. Observe the maximum ambient operating temperature listed below.
20. Power amplifiers- Never attach audio power amplifier outputs directly to any of the unit's connectors.
21. Replacement Parts - When replacement parts are required, be sure the service technician has used replacement parts specified by the manufacturer or have the same characteristics as the original part. Unauthorized substitutions may result in fire, electric shock or other hazards.
22. Safety Check - Upon completion of any service or repairs to this MOTU 896mk3, ask the service technician to perform safety checks to determine that the product is in safe operating conditions.

ENVIRONMENT

Operating Temperature: 10°C to 40°C (50°F to 104°F)

TO REDUCE THE RISK OF ELECTRICAL SHOCK OR FIRE

Do not handle the power cord with wet hands. Do not pull on the power cord when disconnecting it from an AC wall outlet. Grasp it by the plug. Do not expose this apparatus to rain or moisture. Do not place objects containing liquids on it.

AC INPUT

100 - 240VAC ~ 50 / 60Hz • 25 Watts.



About the Mark of the Unicorn License Agreement and Limited Warranty on Software

TO PERSONS WHO PURCHASE OR USE THIS PRODUCT: carefully read all the terms and conditions of the "click-wrap" license agreement presented to you when you install the software. Using the software or this documentation indicates your acceptance of the terms and conditions of that license agreement.

Mark of the Unicorn, Inc. ("MOTU") owns both this program and its documentation. Both the program and the documentation are protected under applicable copyright, trademark, and trade-secret laws. Your right to use the program and the documentation are limited to the terms and conditions described in the license agreement.

Reminder of the terms of your license

This summary is not your license agreement, just a reminder of its terms. The actual license can be read and printed by running the installation program for the software. That license agreement is a contract, and clicking "Accept" binds you and MOTU to all its terms and conditions. In the event anything contained in this summary is incomplete or in conflict with the actual click-wrap license agreement, the terms of the click-wrap agreement prevail.

YOU MAY: (a) use the enclosed program on a single computer; (b) physically transfer the program from one computer to another provided that the program is used on only one computer at a time and that you remove any copies of the program from the computer from which the program is being transferred; (c) make copies of the program solely for backup purposes. You must reproduce and include the copyright notice on a label on any backup copy.

YOU MAY NOT: (a) distribute copies of the program or the documentation to others; (b) rent, lease or grant sublicenses or other rights to the program; (c) provide use of the program in a computer service business, network, time-sharing, multiple CPU or multiple user arrangement without the prior written consent of MOTU; (d) translate, adapt, reverse engineer, decompile, disassemble, or otherwise alter the program or related documentation without the prior written consent of MOTU.

MOTU warrants to the original licensee that the disk(s) on which the program is recorded be free from defects in materials and workmanship under normal use for a period of ninety (90) days from the date of purchase as evidenced by a copy of your receipt. If failure of the disk has resulted from accident, abuse or misapplication of the product, then MOTU shall have no responsibility to replace the disk(s) under this Limited Warranty.

THIS LIMITED WARRANTY AND RIGHT OF REPLACEMENT IS IN LIEU OF, AND YOU HEREBY WAIVE, ANY AND ALL OTHER WARRANTIES, BOTH EXPRESS AND IMPLIED, INCLUDING BUT NOT LIMITED TO WARRANTIES OF MERCHANTABILITY AND FITNESS FOR A PARTICULAR PURPOSE. THE LIABILITY OF MOTU PURSUANT TO THIS LIMITED WARRANTY SHALL BE LIMITED TO THE REPLACEMENT OF THE DEFECTIVE DISK(S), AND IN NO EVENT SHALL MOTU OR ITS SUPPLIERS, LICENSORS, OR AFFILIATES BE LIABLE FOR INCIDENTAL OR CONSEQUENTIAL DAMAGES, INCLUDING BUT NOT LIMITED TO LOSS OF USE, LOSS OF PROFITS, LOSS OF DATA OR DATA BEING RENDERED INACCURATE, OR LOSSES SUSTAINED BY THIRD PARTIES EVEN IF MOTU HAS BEEN ADVISED OF THE POSSIBILITY OF SUCH DAMAGES. THIS WARRANTY GIVES YOU SPECIFIC LEGAL RIGHTS WHICH MAY VARY FROM STATE TO STATE. SOME STATES DO NOT ALLOW THE LIMITATION OR EXCLUSION OF LIABILITY FOR CONSEQUENTIAL DAMAGES, SO THE ABOVE LIMITATION MAY NOT APPLY TO YOU.

Update Policy

In order to be eligible to obtain updates of the program, you must complete and return the attached Mark of the Unicorn Purchaser Registration Card to MOTU.

Copyright Notice

Copyright © 2008, 2007, 2006, 2005, 2004, 2003 by Mark of the Unicorn, Inc. All rights reserved. No part of this publication may be reproduced, transmitted, transcribed, stored in a retrieval system, or translated into any human or computer language, in any form or by any means whatsoever, without express written permission of Mark of the Unicorn, Inc., 1280 Massachusetts Avenue, Cambridge, MA, 02138, U.S.A.

Limited Warranty on Hardware

Mark of the Unicorn, Inc. and S&S Research ("MOTU/S&S") warrant this equipment against defects in materials and workmanship for a period of TWO (2) YEARS from the date of original retail purchase. This warranty applies only to hardware products; MOTU software is licensed and warranted pursuant to separate written statements.

If you discover a defect, first write or call Mark of the Unicorn at (617) 576-2760 to obtain a Return Merchandise Authorization Number. No service will be performed on any product returned without prior authorization. MOTU will, at its option, repair or replace the product at no charge to you, provided you return it during the warranty period, with transportation charges prepaid, to Mark of the Unicorn, Inc., 1280 Massachusetts Avenue, MA 02138. You must use the product's original packing material for in shipment, and insure the shipment for the value of the product. Please include your name, address, telephone number, a description of the problem, and the original, dated bill of sale with the returned unit and print the Return Merchandise Authorization Number on the outside of the box below the shipping address.

This warranty does not apply if the equipment has been damaged by accident, abuse, misuse, or misapplication; has been modified without the written permission of MOTU, or if the product serial number has been removed or defaced.

ALL IMPLIED WARRANTIES, INCLUDING IMPLIED WARRANTIES OF MERCHANTABILITY AND FITNESS FOR A PARTICULAR PURPOSE, ARE LIMITED IN DURATION TO TWO (2) YEARS FROM THE DATE OF THE ORIGINAL RETAIL PURCHASE OF THIS PRODUCT.

THE WARRANTY AND REMEDIES SET FORTH ABOVE ARE EXCLUSIVE AND IN LIEU OF ALL OTHERS, ORAL OR WRITTEN, EXPRESS OR IMPLIED. No MOTU/S&S dealer, agent, or employee is authorized to make any modification, extension, or addition to this warranty.

MOTU/S&S ARE NOT RESPONSIBLE FOR SPECIAL, INCIDENTAL, OR CONSEQUENTIAL DAMAGES RESULTING FROM ANY BREACH OF WARRANTY, OR UNDER ANY LEGAL THEORY, INCLUDING LOST PROFITS, DOWNTIME, GOODWILL, DAMAGE OR REPLACEMENT OF EQUIPMENT AND PROPERTY AND COST OF RECOVERING REPROGRAMMING, OR REPRODUCING ANY PROGRAM OR DATA STORED IN OR USED WITH MOTU/S&S PRODUCTS.

Some states do not allow the exclusion or limitation of implied warranties or liability for incidental or consequential damages, so the above limitation or exclusion may not apply to you. This warranty gives you specific legal rights, and you may have other rights which vary from state to state.

MOTU, AudioDesk, Mark of the Unicorn and the unicorn silhouette logo are trademarks of Mark of the Unicorn, Inc.

This equipment has been type tested and found to comply with the limits for a class B digital device, pursuant to Part 15 of the FCC Rules. These limits are designed to provide reasonable protection against harmful interference in a residential installation. This equipment generates, uses, and can radiate radio frequency energy and, if not installed and used in accordance with the instruction manual, may cause harmful interference to radio communications. However, there is no guarantee that interference will not occur in a particular installation. If this equipment does cause interference to radio or television equipment reception, which can be determined by turning the equipment off and on, the user is encouraged to try to correct the interference by any combination of the following measures:

- Relocate or reorient the receiving antenna
- Increase the separation between the equipment and the receiver
- Plug the equipment into an outlet on a circuit different from that to which the receiver is connected

If necessary, you can consult a dealer or experienced radio/television technician for additional assistance.

PLEASE NOTE: only equipment certified to comply with Class B (computer input/output devices, terminals, printers, etc.) should be attached to this equipment, and it must have shielded interfacable cables in order to comply with the Class B FCC limits on RF emissions.

WARNING: changes or modifications to this unit not expressly approved by the party responsible for compliance could void the user's authority to operate the equipment.



Contents

5	Quick Reference: 896mk3 Front Panel
6	Quick Reference: 896mk3 Rear Panel
7	Quick Reference: MOTU Audio Setup
9	About the 896mk3
15	Packing List and Mac System Requirements
17	Installing the 896mk3 Hardware
33	Installing the 896mk3 Mac Software
35	MOTU Audio Setup
43	896mk3 Front Panel Operation
53	Digital Performer
57	AudioDesk
61	Other Mac OS X Audio Software
69	Reducing Monitoring Latency
75	CueMix Console
103	MOTU SMPTE Console
107	Troubleshooting
109	Index

Quick Reference: 896mk3 Front Panel

These 10-segment level meters are dedicated to the 896mk3's eight analog inputs. The top red 'HOLD' LED illuminates when the signal reaches full scale—for even just one sample—and remains illuminated until you clear it in the software. The CLIP LED below only lights up momentarily so that you can continue to adjust level even after clipping has just occurred. The remaining LEDs provide two different scales for operation with or without V-Limit™, which provides hardware limiting and clip prevention for signal levels as high as +12dB over zero. Without V-Limit, the LED scale goes up to -1.48 dB and clips at zero. With V-Limit, the LED scale goes up to +12 dB and clips when the input signal goes over +12 dB.

The light that is illuminated here tells you which bank you are monitoring with the programmable meter bank to the left.

This bank of level meters can be programmed to display any input or output bank: analog, optical (ADAT or TOSLINK), or digital (AES/EBU and S/PDIF). Use MOTU Audio Setup or the METERS knob below to choose which bank you'd like to view with these meters. The LEDs to the right show which bank you are currently monitoring.

These meters display the level for the 896mk3's main outs.

This section controls the 896mk3's built-in CueMix FX mixer and effects. There are eight stereo mix buses; each bus mixes all inputs (or any subset you wish) to a stereo output of your choice. You can apply EQ and compression to inputs and outputs, plus reverb to ins, outs and mixes. The four knobs below the LCD correspond directly to the four labeled sections of the LCD. Use the CHANNEL knob to choose the input, output or mix you wish to edit. Push it to switch among inputs, outputs and buses; then turn it to choose the desired channel or bus. Use the PAGE, PARAM and VALUE knobs to access the settings for the chosen channel.

The CLOCK LEDs indicate the global sample rate at which the MOTU 896mk3 is operating. Use MOTU Audio Setup to set the sample rate or to choose an external clock source, from which the sample rate will be set. When no sample clock is currently present, these lights flash. For example, if you've set the MOTU 896mk3 to slave to an external clock, such as ADAT, but there is no clock signal currently being detected, these lights will flash.



These toggle switches provide phantom power for a condenser mic plugged into this input and a -20dB pad. For 48V power, up is on. To engage the pad, flip the PAD switch up.

These eight trim knobs provide over +60 dB of preamp gain adjustment for each analog input (not including the pad). Trim applies to either the XLR mic input or the quarter-inch TRS input.

The phone jack labeled (MAIN OUT) is a standard quarter-inch stereo headphone jack. Its output is hard-wired to mirror the XLR main outs on the rear panel. From the factory, the MASTER VOL knob above it controls the main outs and this jack, but MASTER VOL can be programmed to control any combination of outputs. See "The Monitor Group" on page 97 for details. Push the knob once to view the current volume setting in the LCD display; push it again to mute the monitor group; push a third time to return to the previous volume. Note: if the Monitor group is programmed to not include the main outs, the MASTER VOL knob will no longer control the volume of this phone jack, either.

From the factory, the PHONES jack is a discrete output (at 44, 1/48 KHz), but it can mirror any other output pair (digital or analog). For example, at 88.2/96 KHz, it defaults to mirroring the main outs. As the primary phone jack, it has its own dedicated volume knob.

Connect a standard foot switch here for hands-free punch-in and punch-out during recording. For details about how to set this up, see "Enable Pedal" on page 41.

Push the CHANNEL knob repeatedly to cycle among the four main sections of the mixer: mix buses, inputs, outputs and the reverb module. Push the PARAM knob to enter the SETUP menu, which provides global 896mk3 settings, such as the global sample rate, etc.

Use this knob to choose which audio bank you are viewing with the programmable meters above.

FireWire is a "plug-and-play" protocol that means that you can turn off the MOTU 896mk3 and turn it back on (or even unplug it) without restarting your computer. Keep in mind, however, that if you wish to change the MOTU 896mk3's settings in MOTU Audio Setup, the MOTU 896mk3 needs to be plugged in and switched on.

Quick Reference: 896mk3 Rear Panel

These AES/EBU connectors can handle any supported sample rate up to 96 kHz, and they are also equipped with a sample rate converter so you can input or output at a different rate than the 896mk3. For details see "Syncing AES/EBU devices" on page 25. At the 4x sample rates, (176.4 and 192kHz), AES/EBU is disabled.

These two XLR jacks serve as the MOTU 896mk3's main analog outputs. You can connect them to a set of powered studio monitors and then control the volume from the front panel MASTERVOL knob. These jacks are always mirrored by the MAIN OUT headphone jack on the front panel.

To hear disk tracks in your audio software on these main outs, assign the disk tracks (and master fader) to these main outs. Also make sure the Main Out Assign option is set to *Main Out 1-2*. See "Main Out Assign" on page 39. You can also use CueMix FX to monitor live 896mk3 inputs here as well.

The MOTU 896mk3's eight analog outputs are XLR connectors referenced to +19 dBu. They are equipped with 24-bit D/A converters capable of 192kHz.



The 896mk3 is equipped with an auto-switching international power supply.

These jacks provide stereo, 24-bit S/PDIF digital input and output at all supported sample rates (up to 96 kHz).

Connect the 896mk3 to the computer here using the standard 1394 FireWire cable provided with your MOTU 896mk3. Use the extra FireWire port to daisy-chain up to four 896mk3's to a single FireWire bus. You can also connect a MOTU 828, FireWire hard drive or other FireWire device. For details, see "Connecting multiple MOTU FireWire interfaces" on page 29.

These XLR/TFS combo jacks accept either a mic cable or a quarter-inch guitar cable. Both the low-impedance XLR jack and the high-impedance TFS jack are equipped with a preamp (so don't connect a +4 line level XLR cable). 48V phantom power and 20 dB pad can be applied via the switches provided on the front panel. The trim knob provides over 60 dB of gain.

Use the word clock input and output for digital transfers with devices that cannot slave to the clock supplied by their digital I/O connection with the 896mk3.

These optical I/O connectors can be connected either to an ADAT-compatible "lightpipe" device (such as a digital mixer) or to a S/PDIF optical ("TOSLINK") compatible device, such as an effects processor or DAT machine. Be sure to set the format in the MOTU Audio Setup software (or using the front panel LCD). (See "Optical Input/output" on page 39 for details.) ADAT optical supplies eight channels of 24-bit digital I/O per bank (4 channels per bank at 96kHz). TOSLINK is stereo at sample rates up to 96 kHz.

One special note: you can choose independent formats for each bank, A and B, as well as IN and OUT within each bank. For example, you could choose ADAT for the optical A IN (for, say, eight channels of input from your digital mixer) and stereo TOSLINK for the optical A OUT (for, say, your DAT machine).

Quick Reference: MOTU Audio Setup

Determines the clock source for your 896mk3. If you're just using the analog ins and outs, set this to 'Internal'. The other settings are for digital transfers via AES/EBU, S/PDIF or optical ports, or for slaving the 896mk3 to word clock.

This menu lets you choose what you will hear from the PHONES jack. To mirror the main outs, choose *Main Out 1-2*. Or you can mirror any other output pair. To hear the phones as their own independent output, choose *Phones 1-2* (at 44.1 or 48 kHz). At higher sample rates, the phones must mirror any other available output pair.)

The 896mk3 driver provides a stereo return back to the computer. This return feeds the signal on any 896mk3 output pair directly back to the computer, where you can record, process, monitor or otherwise use it. This is a great way to "bounce" full mixes, complete with live audio routed through the 896mk3 only, back into the computer.

Provides several options for the 896mk3's AES/EBU sample rate conversion. See, "Syncing AES/EBU devices" on page 25.

The *Clip Hold Time* controls how long the top-most red LED remains illuminated after clipping. Choose 'Infinite' if you want to be able to clear the LED from Digital Performer. The *Peak Hold Time* controls how long the highest illuminated LED remains lit before going dark.

Click the General tab to access these settings.

Check this option if you would like the MOTU Audio Setup icon to appear in the application dock as soon as a MOTU FireWire interface is detected (switched on, plugged in, etc.)

This button opens another dialog that lets you assign your own customized names to each 896mk3 input and output. For example, if you have a lead vocal mic plugged into input 1, you could name it "Lead Vox." Your customized names then appear in your host audio application (if it supports Core Audio input naming).

If you have a foot switch connected to the 896mk3, these settings let you map the foot switch to any computer keyboard key for both the up and down position. For details about how to set this up, see "Enable Pedal" on page 41.

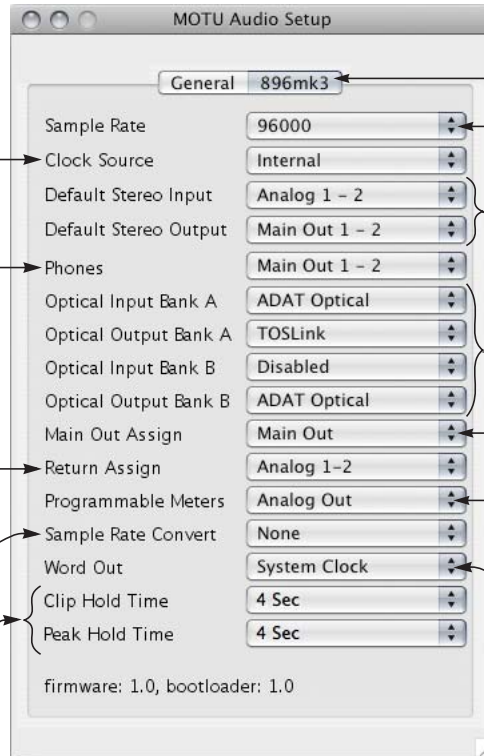

Click the tabs to access general MOTU FireWire interface settings or settings specific to the 896mk3 (or other connected interface.)

Choose the global sample rate for the system here.

Specifies the stereo input and output pair when the 896mk3 is chosen for Mac OS X audio I/O.

Each optical bank can be configured independently ADAT or TOSLINK. Disable them when not in use to conserve DSP and FireWire bus bandwidth.

Choose the output pair you would like the main outs to mirror, or choose *Main Outs* to operate them as their own independent pair.

Lets you choose what to monitor with the 896mk3's programmable front panel meters.

If you are running an 896mk3 interface at a high sample rate (88.2, 96, 176.4 or 192 kHz), this option appears in the interface tab. It lets you choose a word clock output rate that either matches the global sample rate (e.g. 96kHz) or reduces it to the corresponding 1x rate (e.g. 48kHz instead of 192 kHz).

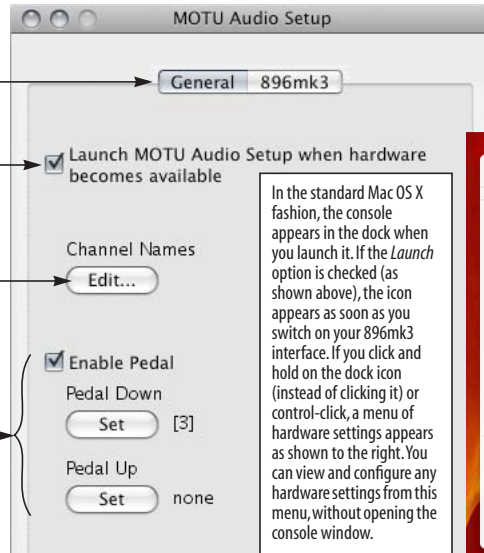

In the standard Mac OS X fashion, the console appears in the dock when you launch it. If the *Launch* option is checked (as shown above), the icon appears as soon as you switch on your 896mk3 interface. If you click and hold on the dock icon (instead of clicking it) or control-click, a menu of hardware settings appears as shown to the right. You can view and configure any hardware settings from this menu, without opening the console window.

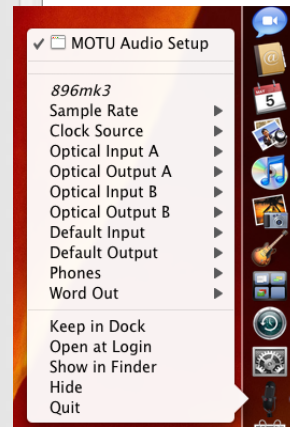

CHAPTER 1 About the 896mk3

Overview	9
The 896mk3 rear panel	10
The 896mk3 front panel	12
16-bit and 24-bit recording	12
CueMix FX 32-bit floating point mixing and effects..	13
AudioDesk	13
Digital Performer	13
Other host audio software	13

OVERVIEW

The 896mk3 is a FireWire audio interface for Mac and Windows that provides 28 separate inputs and 32 separate outputs (at 44.1 or 48kHz). Both analog and digital I/O are offered at sample rates up to 96 kHz, and analog recording and playback is offered at rates up to 192 kHz. All inputs and outputs can be accessed simultaneously. The 896mk3 consists of a standard 19-inch, double space, rack-mountable I/O unit that connects directly to a computer via a standard IEEE 1394 FireWire™ cable.

The 896mk3 offers the following main features:

- Eight 24-bit XLR analog outputs
- Eight 24-bit c analog inputs equipped with XLR/TRS “combo” jacks
- Eight mic preamps (one on each input)
- Independent 48V phantom power and 20 dB pad for each mic input
- Independent front-panel trim for each input
- Two extra XLR analog main outs
- Operation on all analog I/O at standard sample rates up to 192 kHz
- Two banks of optical digital I/O that provide 16 channels of ADAT optical at 48 kHz, 8 channels of S/MUX optical I/O at 96 kHz or two banks of stereo TOSLINK at rates up to 96 kHz
- AES/EBU digital I/O at samples rates up to 96 kHz with sample rate conversion
- RCA S/PDIF at sample rates up to 96 kHz
- Word clock input and output
- On-board SMPTE synchronization via any analog input and output
- Two FireWire jacks for chaining multiple units
- Foot switch input for hands-free punch-in/out
- Two phone jacks with independent volume control
- Programmable master volume knob
- CueMix™ FX no-latency mixing, monitoring and effects processing
- Front-panel LCD programming for the mixer and all other settings
- Dedicated 10-segment LED level meters for all eight analog inputs
- Dedicated 10-segment level meters for main outs
- Programmable 10-segment LED level meters that display levels for any 8-channel input or output bank, as well as AES/EBU or S/PDIF digital I/O
- Auto-switching international power supply
- Stand-alone operation
- Mac and Windows drivers for multi-channel operation and across-the-board compatibility with any audio software on both platforms

- AudioDesk™, full-featured audio workstation software for Mac OS that supports both 16-bit and 24-bit recording

With a variety of I/O formats, mic preamps, no-latency mixing and processing of live input and synchronization capabilities, the 896mk3 is a complete, portable “studio in a box” when used with a Mac or Windows computer.

THE 896MK3 REAR PANEL

The 896mk3 rear panel has the following connectors:

- Eight 24-bit 192 kHz XLR analog outputs
- Eight 24-bit 192 kHz “combo” (XLR + balanced quarter-inch) analog inputs, each equipped with a mic preamp, front-panel 48V phantom power, front-panel pad switch and front-panel trim knob
- Two XLR main analog outputs with volume knob (on the front panel)
- Two sets of optical connectors (in and out), individually switchable among ADAT optical “lightpipe”, 96 kHz S/MUX optical or S/PDIF “TOSLINK”
- AES/EBU input and output
- RCA S/PDIF in/out
- BNC word clock input and output
- Two 1394 FireWire jacks

28 inputs and 32 outputs

All 896mk3 inputs and outputs can be used simultaneously, for a total of 28 inputs and 32 outputs at 44.1/48kHz:

Connection	Input	Output
24-bit 192kHz XLR analog	8	8
24-bit 192kHz XLR main outputs	-	stereo
Headphone output*	-	stereo
ADAT optical digital†	16	16
AES/EBU 24-bit 96kHz digital	stereo	stereo
RCA S/PDIF 24-bit 96kHz digital	stereo	stereo
Total	28	32

* The phone jack below the MASTER VOL knob is hard-wired to (mirrors) the XLR main outs. The PHONES output can operate as an independent output pair, or it can mirror any other 896mk3 output pair, such as the main outs.

† The 896mk3 optical connectors support several standard optical I/O formats, which provide varying channel counts. See “Optical input/output” on page 39 for details about optical bank operation.

With the exception of the phone jack on the front panel labeled “(MAIN OUT)”, all inputs and outputs are discrete. For example, using the main outs does not “steal” an output pair from the bank of eight XLR analog outputs. The same is true for the headphone outs.

Analog

All 10 analog inputs and outputs are equipped with 24-bit 192 kHz A/D converters. All audio is carried to the computer in a 24-bit data stream.

Mic/guitar preamps

All eight analog inputs are equipped with a preamp on a combo-style connector that accepts either an XLR or quarter-inch (guitar) plug. Individual 48V

phantom power and 20 dB pad are supplied by separate front panel switches for each input. In addition, each input has its own trim knob, which provides over 60 dB of gain.

Analog input overload protection

All eight mic inputs are equipped with V-Limit™, a hardware limiter that helps prevent digital clipping from overloaded input signals. With V-Limit enabled, signals can go above zero dB (with limiting applied) to as high as +12 dB above zero with no distortion due to digital clipping.

Additional or alternative protection can be applied to the mic/guitar inputs by enabling the 896mk3's Soft Clip feature, which engages just before clipping occurs and helps reduce perceptible distortion.

Main Outs

The main outs are equipped with 24-bit 192kHz D/A converters and serve as independent outputs for the computer or for the 896mk3's on-board CueMix FX mixes. The main out volume can be controlled with the front panel volume knob.

Optical

The two optical banks provide 16 channels of ADAT optical at 44.1 or 48 kHz, 8 channels of S/MUX optical I/O at 96 kHz or two banks of stereo TOSLINK at rates up to 96 kHz. The banks operate independently, including input and output, allowing you to mix and match any optical formats. For example, you could receive 4 channels of 96 kHz S/MUX input on Bank A while at the same time sending 96 kHz stereo optical S/PDIF ("TOSLINK") from the Bank A output.

AES/EBU with sample rate conversion

The 896mk3 rear panel provides a standard AES/EBU digital input and output that supports digital I/O at 44.1, 48, 88.2 and 96 kHz. In addition, input or output can be sample-rate converted to any of these sample rates in situations that call for a

different rate than the 896mk3's global sample rate. The AES/EBU jacks are disabled at the 4x sample rates (176.4 and 192kHz).

S/PDIF

The 896mk3 rear panel provides S/PDIF input and output in two different formats: RCA "coax" and optical "TOSLINK". The RCA jacks are dedicated to the S/PDIF format. The TOSLINK jacks can be used either for either TOSLINK or ADAT optical, as discussed earlier.

Word clock

The 896mk3 provides standard word clock that can slave to any supported sample rate. In addition, word clock can resolve to and generate "high" and "low" sample rates. For example, if the 896mk3 global sample rate is set to 96 kHz, the word clock input can resolve to a "low" rate of 48 kHz. Similarly, when the 896mk3 is operating at 192 kHz, MOTU Audio Setup lets you choose a word clock output rate of 48 kHz (the *Force 44.1/48kHz* setting).

On-board SMPTE synchronization

The 896mk3 can resolve directly to SMPTE time code via any TRS analog input, without a separate synchronizer. The 896mk3 can also generate SMPTE time code via any XLR analog output. The 896mk3 provides a DSP-driven phase-lock engine with sophisticated filtering that provides fast lockup times and sub-frame accuracy.

The included MOTU SMPTE Console™ software provides a complete set of tools for generating and regenerating SMPTE time code, which allows you to slave other devices to the computer. Like CueMix FX, the synchronization features are cross-platform and compatible with all audio sequencer software that supports the ASIO2 sample-accurate sync protocol.

1394 FireWire

The two 1394 FireWire jacks accept a standard IEEE 1394 FireWire cable to connect the 896mk3 to a FireWire-equipped Mac or Windows computer. The second jack can be used to daisy chain multiple interfaces — up to four MOTU FireWire interfaces — on a single FireWire bus. It can also be used to connect other FireWire devices without the need for a FireWire hub. Keep in mind, however, that the 896mk3 uses more FireWire bus bandwidth when one or both optical banks are enabled, or when it operates at higher sample rates. These operating configurations will limit the number of devices you can daisy chain on a single FireWire bus.

THE 896MK3 FRONT PANEL

Metering

The front panel of the MOTU 896mk3 displays two eight-channel banks of 10-segment ladder LEDs. The left-hand bank always shows the eight analog inputs. The right-hand bank shows any other bank you choose with the Meters knob: Analog out, optical I/O (ADAT or TOSLINK) or digital I/O (AES/EBU and S/PDIF). A status LED to the right shows which bank you are currently viewing. You can also adjust this setting in the MOTU Audio Setup software.

The 896mk3 front panel also displays stereo meters for the main analog outs.

The *Clock* lights indicate the global sample rate (as chosen in the MOTU Audio Setup software). The Rate Convert LEDs indicate if sample rate conversion is being applied to the AES/EBU input or output, and if so, the rate being converted to.

Input trim knobs, phantom power & 20 dB Pad

The front-panel input trim knobs provide independent trim for the eight analog inputs.

The phantom power switch for each input provides 48V phantom power. Up is on; down is off.

The -20 dB pad switch for each input reduces the mic input signal going to the A/D converter by 20 dB. Up is on (pad engaged); down is off.

Headphone output and main volume control

The 896mk3 front panel provides two independent headphone jacks with independent volume knobs, one of which also controls the XLR main outs on the rear panel. Alternately, this MASTER VOL knob can be programmed to control any combination of outputs (analog and/or digital). For example, it can control monitor output for an entire 5.1 or 7.1 surround mix.

Foot switch

The quarter-inch Foot Switch jack accepts a standard foot switch. When you push the foot switch, the 896mk3 triggers a programmable keystroke on the computer keyboard. For example, you could program the foot switch to toggle recording in your host software. The MOTU Audio Setup software lets you program any keystroke you wish.

Programmable backlit LCD display

Any 896mk3 setting, including the powerful CueMix FX on-board 16-bus mixer with effects, can be accessed directly from the front panel using the four rotary encoders and the 2x16 backlit LCD display.

16-BIT AND 24-BIT RECORDING

The 896mk3 system handles all data with a 24-bit signal path, regardless of the I/O format. You can record and play back 16-bit or 24-bit audio files at any supported sample rate via any of the 896mk3's analog or digital inputs and outputs. 24-bit audio files can be recorded with any compatible host application that supports 24-bit recording.

CUEMIX FX 32-BIT FLOATING POINT MIXING AND EFFECTS

All 896mk3 inputs and outputs can be routed to the on-board CueMix FX 16-bus (8 stereo) digital mixer driven by hardware-based DSP with 32-bit floating point precision. The mixer allows you to apply no-latency effects processing to inputs, outputs or busses directly in the 896mk3 hardware, independent of the computer. Effects can even be applied when the 896mk3 is operating stand-alone (without a computer) as a complete rack-mounted mixer. Input signals to the computer can be recorded wet, dry, or dry with a wet monitor mix (for musicians during recording, for example).

Effects include reverb, parametric EQ and compression/limiting. The 896mk3's Classic Reverb™ provides five different room types, three frequency bands with adjustable crossover points, shelf filtering and reverb lengths up to 60-seconds.

Two forms of compression are supplied: a standard compressor with conventional threshold/ratio/attack/release/gain controls and the Leveler™, an accurate model of the legendary LA-2A optical compressor, which provides vintage, musical automatic gain control.

CueMix FX also provides 7-band parametric EQ modeled after British analog console EQs, featuring 4 filter styles (gain/Q profiles) to effectively cover a wide range of audio material. Low-pass and high-pass filters are also supplied with slopes that range from 6 to 36 dB. The EQ employs extremely high precision 64-bit floating point processing.

The 838mk3's flexible effects architecture allows you to apply EQ and compression on every input and output (a total of 58 channels), with enough DSP resources for at least one band of parametric EQ and compression on every channel at 48 kHz. However, DSP resources are allocated dynamically and a DSP meter in the CueMix FX software allows

you to keep tabs on the 896mk3's processing resources. Each input, output and mix bus provides a send to the Classic Reverb processor, which then feeds reverb returns to mix busses and outputs, with a selectable split point between them to prevent send/return feedback loops.

AUDIODESK

AudioDesk is a full-featured, 24-bit audio workstation software package included with the 896mk3 system (for Mac only). AudioDesk provides multi-channel waveform editing, automated virtual mixing, graphic editing of ramp automation, real-time effects plug-ins with 32-bit floating point processing, crossfades, support for many third-party audio plug-ins, background processing of file-based operations, sample-accurate editing and placement of audio, and more.

DIGITAL PERFORMER

The 896mk3 system is fully integrated with MOTU's award-winning Digital Performer audio sequencer software package.

OTHER HOST AUDIO SOFTWARE

The 896mk3 system includes a standard Mac OS X CoreAudio driver for multichannel I/O with any audio application that supports CoreAudio.

CHAPTER 2 **Packing List and Mac System Requirements**

PACKING LIST

The 896mk3 ships with the items listed below. If any of these items are not present in your 896mk3 box when you first open it, please immediately contact your dealer or MOTU.

- One 896mk3 I/O rack unit
- One 6-pin to 6-pin IEEE 1394 “FireWire” cable
- Power cord
- One 896mk3 Mac/Windows manual
- One AudioDesk manual
- One cross-platform installer CD
- Product registration card

MAC SYSTEM REQUIREMENTS

The 896mk3 system requires the following Mac system:

- A G4/500MHz Power Mac or faster equipped with at least one FireWire port
- At least 256MB (megabytes) of RAM (512MB or more is recommended)
- Mac OS X (version 10.4.9 or later)
- A large hard drive (preferably at least 100GB)

PLEASE REGISTER TODAY!

Please register your 896mk3 today. There are two ways to register.

- Visit www.motu.com/register

OR

- Fill out and mail the included product registration card

As a registered user, you will be eligible to receive technical support and announcements about product enhancements as soon as they become available. Only registered users receive these special update notices, so please register today.

Be sure to do the same for the included AudioDesk software, which must be registered separately. You can do so online or by filling out and mailing the included software registration card found at the beginning of your AudioDesk manual. Please be sure to register AudioDesk as well, so that you will be eligible to receive technical support and announcements about AudioDesk software enhancements as soon as they become available.

Thank you for taking the time to register your new MOTU products!

CHAPTER 3 Installing the 896mk3 Hardware

OVERVIEW

Here's an overview for installing the 896mk3:

Connect the 896mk3 interface.....	17
Connect the 896mk3 to the computer.	
Connect audio inputs and outputs	18
Make optical and analog connections as desired.	
Connect a foot switch.....	19
Connect a footswitch to trigger any keystroke.	
A typical 896mk3 setup.....	20
An example setup for computer-based mixing/FX.	
Making sync connections.....	21
If you need to resolve the 896mk3 with other devices, make the necessary sync connections.	
Syncing to SMPTE time code directly	22
Syncing to video and/or SMPTE time code using a synchronizer.....	23
Syncing S/PDIF devices	24
Syncing optical devices	25
Syncing AES/EBU devices	25
Syncing word clock devices.....	28
Connecting multiple MOTU FireWire interfaces	29

CONNECT THE 896MK3 INTERFACE

1 Plug one end of the 896mk3 FireWire cable (included) into the FireWire socket on the computer as shown below in Figure 3-1.

☛ You can connect the 896mk3 to an 800Mbit “FireWire B” port using a 9-pin to 6-pin FireWire B cable (not shown). However, the 896mk3 will still operate at its specified 400Mbit (FireWire A) data rate.

2 Plug the other end of the FireWire cable into the 896mk3 I/O as shown below in Figure 3-1.



Figure 3-1: Connecting the 896mk3 to the computer.

CONNECT AUDIO INPUTS AND OUTPUTS

The 896mk3 audio interface has the following audio input and output connectors:

- 8 combo-style XLR/quarter-inch analog inputs
- 8 XLR analog outputs
- 2 XLR main outs
- AES/EBU input/output
- S/PDIF input/output
- ADAT optical input/output

Here are a few things you should keep in mind as you are making these connections to other devices.

Analog inputs

Connect a microphone, guitar, instrument or other analog input to any XLR/quarter-inch combo jack with either a standard mic cable or a balanced cable with a quarter-inch plug.

Phantom power

If you are connecting a condenser microphone or other device that requires phantom power, flip up the 48V switch on the front panel to engage phantom power.

Trim

Both the low-impedance XLR mic input and the high-impedance quarter-inch guitar input are equipped with over 60 dB gain. Use the corresponding front panel trim knob to adjust the input level as needed for each input.

20 dB pad

If the input signal is too hot with the trim turned all the way down, engage (flip up) the 20dB pad switch for the input on the front panel.

Analog outputs

For the XLR outputs, use high-quality shielded cables. These outputs are referenced to +19 dBu.

Main outs

The XLR main outputs serve as independent outputs. From the factory, the main out volume is controlled by the MASTER VOL knob on the front panel, although this knob can be programmed to control any combination of outputs. For details, see “The Monitor Group” on page 97. In a standard studio configuration, the main outs are intended for a pair of studio monitors, but they can also be used as additional outputs for any purpose.

ADAT optical

The 896mk3 rear panel provides two sets of ADAT optical (“lightpipe”) connectors: Bank A and B (Figure 3-3). Each bank provides an input and output connector. All four connectors can operate independently and offer two different optical formats: ADAT optical or TOSLINK (optical S/PDIF). For example, you could connect 8-channel ADAT optical input from your digital mixer and stereo TOSLINK output to an effects processor.

Figure 3-2: the 896mk3 front panel.



The 896mk3 supplies +12dB of digital trim (boost) for each optical input, which can be adjusted from CueMix FX (“Input trim” on page 81) or the front panel (“The IN (inputs) menu” on page 48).

Below is a summary of optical formats:

Format	44.1 or 48 kHz	88.2 or 96 kHz
ADAT optical	8 channels	4 channels
TOSLINK	stereo	stereo

Optical operation at 44.1 or 48 kHz

When configured for ADAT “lightpipe”, an optical connector provides 8 channels at 44.1 and 48 kHz.

ADAT optical operation at 88.2 or 96 kHz

When configured for ADAT “lightpipe”, an optical connector provides four channels at 88.2 or 96 kHz (2x sample rates). When using the ADAT lightpipe format at a 2x rate, be sure to choose either Type I or Type II operation, as explained in “ADAT SMUX Type” on page 47.

ADAT optical operation at 88.2 or 96 kHz

When configured for ADAT “lightpipe”, an optical connector provides four channels at 88.2 or 96 kHz (2x sample rates). When using the ADAT lightpipe format at a 2x rate, be sure to choose either Type I or Type II operation, as explained in “ADAT SMUX Type” on page 47.

Choosing a clock source for optical connections

Be sure to review the digital audio clocking issues, as explained in “Syncing optical devices” on page 25.

S/PDIF

If you make a S/PDIF digital audio connection to another device, be sure to review the digital audio clocking issues, as explained in “Syncing S/PDIF devices” on page 24.

The 896mk3 supplies +12dB of digital trim (boost) for the S/PDIF input pair, which can be adjusted from CueMix FX (“Input trim” on page 81) or the front panel (“The IN (inputs) menu” on page 48).

AES/EBU

Connect standard AES/EBU input and output. 2x sample rates (88.2 & 96 kHz) are supported; 4x samples rates (176.4 or 192kHz) are not supported.

Be sure to review the digital audio clocking issues, as explained in “Syncing AES/EBU devices” on page 25.

The 896mk3 supplies +12dB of digital trim (boost) for the AES/EBU input pair, which can be adjusted from CueMix FX (“Input trim” on page 81) or the front panel (“The IN (inputs) menu” on page 48).

CONNECT A FOOT SWITCH

If you would like to use a foot switch with your 896mk3, connect it to the FOOT SWITCH jack. See “Quick Reference: MOTU Audio Setup” on page 7 for information about how to program the foot switch to trigger any computer keystroke you wish.

Figure 3-3: the 896mk3 rear panel.



A TYPICAL 896MK3 SETUP

Here is a typical 896mk3 studio setup. This rig can be operated without a conventional mixer. All mixing and processing can be done either in the 896mk3, in the computer with audio software, or both. During recording, you can use the 896mk3's

CueMix™ FX mixer to apply reverb, EQ and compression to what you are recording and monitor it via the main outs, headphone outs, or any other output pair. You can control everything from the included CueMix Console software.

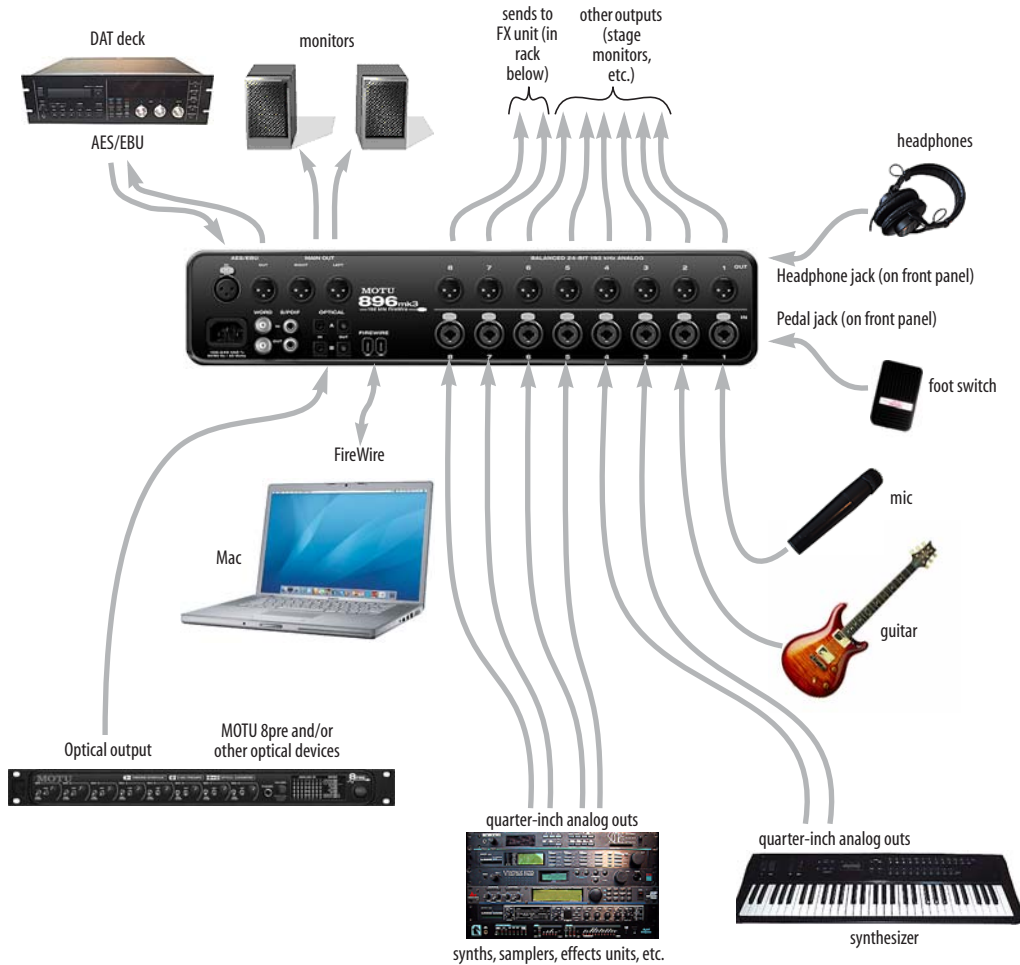

Figure 3-4: A typical 896mk3 studio setup.

MAKING SYNC CONNECTIONS

If you connect devices digitally to the 896mk3, or if you need to synchronize the 896mk3 with an outside time reference such as SMPTE time code, you must pay careful attention to the synchronization connections and clock source issues discussed in the next few sections.

Do you need to synchronize the 896mk3?

If you will be using only the 896mk3's analog inputs and outputs (and none of its digital I/O), and you have no plans to synchronize your 896mk3 system to SMPTE time code or other external clock source, you don't need to make any sync connections. You can skip this section and proceed to chapter 4, "Installing the 896mk3 Mac Software" (page 33). After you install the 896mk3 software, you'll open MOTU Audio Setup and set the *Clock Source* setting to *Internal* as shown below. For details, see chapter 5, "MOTU Audio Setup" (page 35).

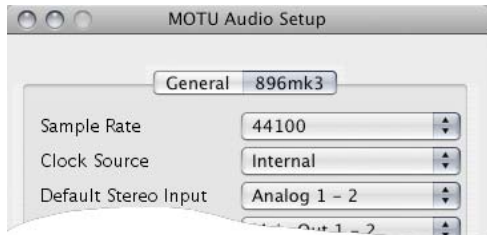

Figure 3-5: You can run the 896mk3 under its own internal clock when it has no digital audio connections and you are not synchronizing the 896mk3 system to an external time reference such as SMPTE time code.

Situations that require synchronization

There are three general cases in which you will need to resolve the 896mk3 with other devices:

- Synchronizing the 896mk3 with other digital audio devices so that their digital audio clocks are *phase-locked* (as shown in Figure 3-6)
- Slaving the 896mk3 system to SMPTE time code from a video deck, analog multi-track, etc.
- Both of the above

Synchronization is critical for clean digital I/O

Synchronization is critical in any audio system, but it is especially important when you are transferring audio between digital audio devices. Your success in using the 896mk3's digital I/O features depends almost entirely on proper synchronization. The following sections guide you through several recommended scenarios.

Be sure to choose a digital audio clock master

When you transfer digital audio between two devices, their audio clocks must be in phase with one another — or *phase-locked*. Otherwise, you'll hear clicks, pops, and distortion in the audio — or perhaps no audio at all.

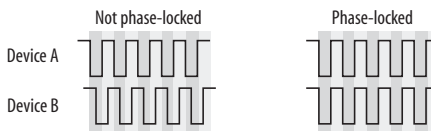

Figure 3-6: When transferring audio, two devices must have phase-locked audio clocks to prevent clicks, pops or other artifacts.

There are two ways to achieve phase lock: slave one device to the other, or slave both devices to a third master clock. If you have three or more digital audio devices, you need to slave them all to a single master audio clock.

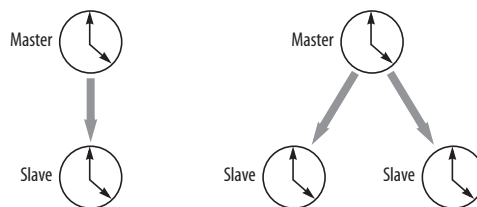
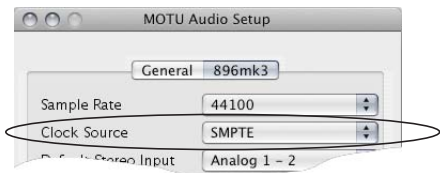

Figure 3-7: To keep the 896mk3 phase-locked with other digital audio devices connected to it, choose a clock master.

Also remember that audio phase lock can be achieved independently of time code (location). For example, one device can be the time code master while another is the audio clock master. But only one device can be the audio clock master. If you set things up with this rule in mind, you'll have trouble-free audio transfers with the 896mk3.

SYNCING TO SMPTE TIME CODE DIRECTLY

The 896mk3 system can resolve directly to SMPTE time code. It can also generate time code and word clock, under its own clock or while slaving to time code. Therefore, the 896mk3 can act both as an audio interface and as a digital audio synchronizer to which you can slave other digital audio devices. You can use the 896mk3 to slave your audio software to SMPTE as well, as long as your software supports sample-accurate sync, which is the means by which the software follows the 896mk3. The accuracy may not be sample-accurate, but in most cases it will be very close.



First, choose *SMPTE* as the clock source in AudioDesk, Digital Performer, or MOTU Audio Setup. This setting can also be made in the MOTU SMPTE Console (shown below).

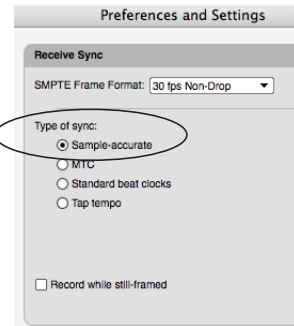

In AudioDesk or Digital Performer:

1. Choose *Receive Sync* from the Setup menu.
2. Choose the *Sample-accurate* option. (If this option is grayed out, choose *SMPTE* as the clock source setting first, as shown above.)
3. Make sure that *Slave to External Sync* mode is enabled.

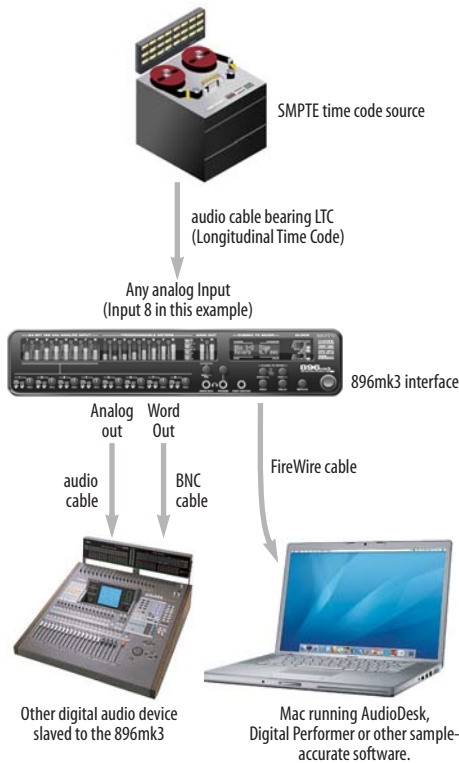

Use this setup if you have:

- ✓ A SMPTE time code source, such as a multitrack tape deck.
- ✓ An 896mk3 by itself, OR with another slaved device (such as a digital mixer).
- ✓ Host software that supports sample-accurate sync.

This setup provides:

- ✓ Continuous sync to SMPTE time code.
- ✓ Sub-frame timing accuracy.
- ✓ Transport control from the SMPTE time code source.



Launch the MOTU SMPTE Console to specify the time code frame rate and amount of freewheel. Also, confirm that the *Clock Source/Address* is *SMPTE/SMPTE*. For details about the other settings, see chapter 12, "MOTU SMPTE Console" (page 103).

Figure 3-8: Connections for synchronizing the 896mk3 directly to SMPTE time code.

SYNCING TO VIDEO AND/OR SMPTE TIME CODE USING A SYNCHRONIZER

If your host audio software does not support the 896mk3's on-board SMPTE sync features (because your software does not support sample-accurate sync), you need a universal synchronizer, such as a MOTU MIDI Timepiece AV or Digital Timepiece. These dedicated sync boxes can read video and SMPTE time code and then convert it into word clock and MIDI Time Code (MTC). The word clock goes to the 896mk3 to resolve the audio hardware, and MIDI Time Code is fed to your host audio software, which locks to it, as shown below in Figure 3-9.

Use this setup if you have:

- ✓ Video and/or a SMPTE time code source.
- ✓ A Digital Timepiece, MIDI Timepiece AV or other universal synchronizer.
- ✓ Host software that does not support sample-accurate sync (although you can use this setup even if it does).

This setup provides:

- ✓ Continuous sync to SMPTE time code.
- ✓ Sub-frame timing accuracy.
- ✓ Transport control from the SMPTE time code source.

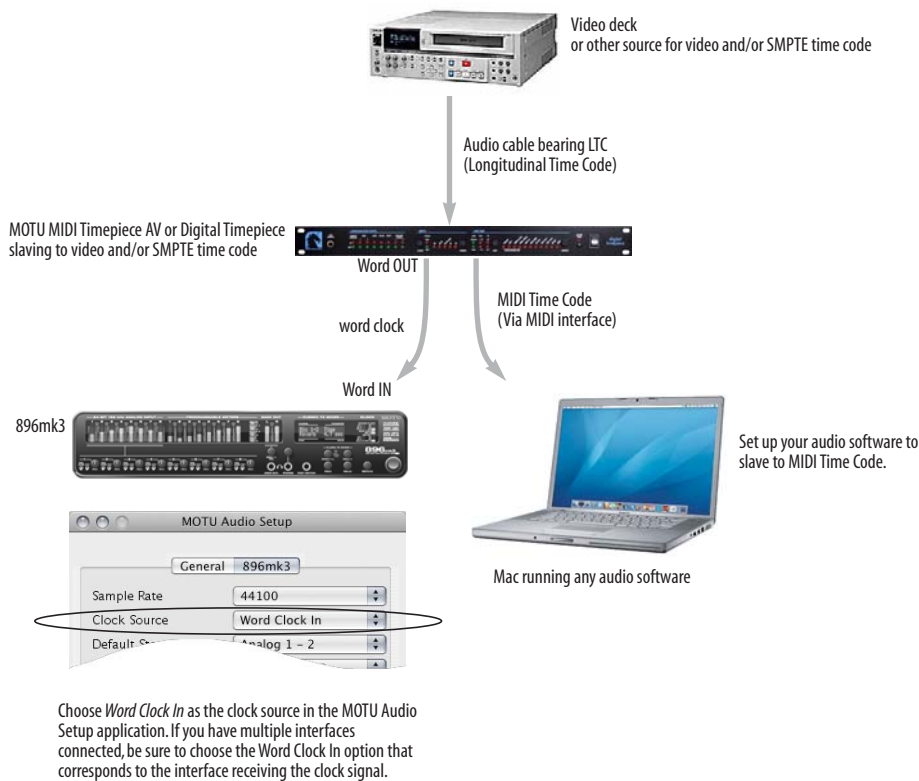

Figure 3-9: If your host audio software does not support sample-accurate sync and the 896mk3's built-in SMPTE sync features, use a universal synchronizer such as the MOTU MIDI Timepiece AV or Digital Timepiece.

SYNCING S/PDIF DEVICES

S/PDIF devices will sync to the 896mk3 in one of two ways:

- Via the S/PDIF connection itself
- Via word clock

S/PDIF devices with no word clock

If your S/PDIF device has no word clock sync connectors, just connect it to the 896mk3 via the S/PDIF connectors. When the device records S/PDIF audio (from the 896mk3), it will simply synchronize to the clock provided by the audio input.

On the other hand, when you transfer audio from the S/PDIF device into the 896mk3, you'll have to slave the 896mk3 to its S/PDIF input. If you have other digital audio devices connected to the 896mk3, and they are not slaved directly to the 896mk3 itself, you may hear clicks and pops resulting from their unsynchronized audio clock. If so, just turn them off during the transfer.

S/PDIF devices with word clock

If your S/PDIF device has a Word Clock input, slave the S/PDIF device to the 896mk3 via their word clock connection. You can then freely transfer audio between the 896mk3 and the S/PDIF device.

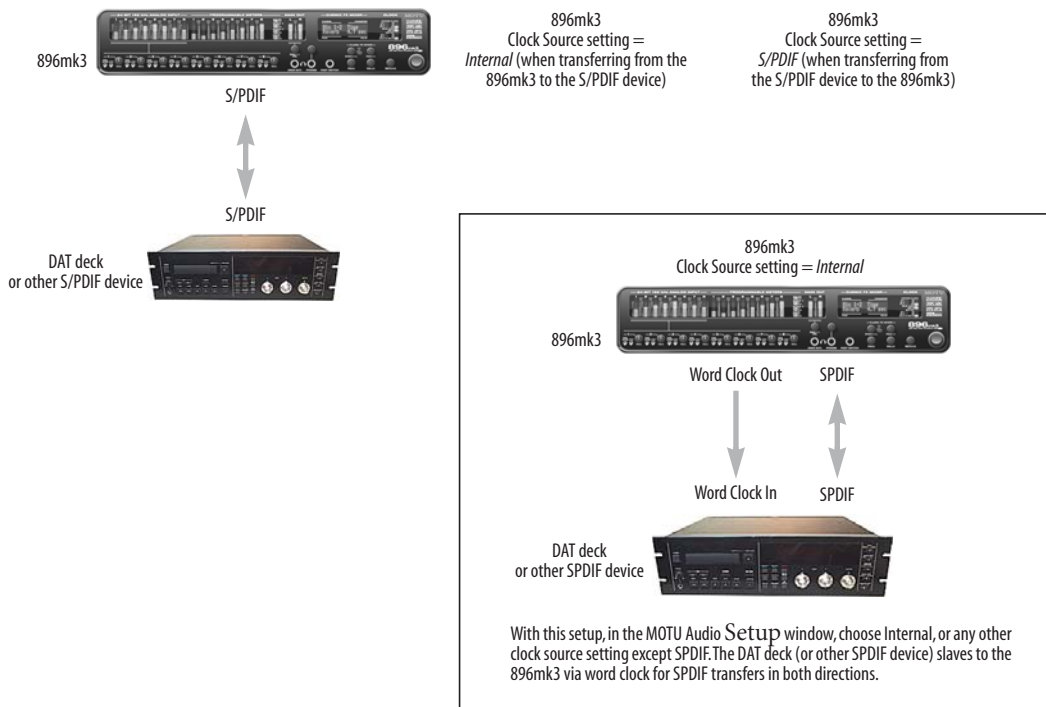

Figure 3-10: Two setups for synchronizing an S/PDIF device with the 896mk3. In the top diagram, sync is achieved via the S/PDIF connection itself. In this case, you have to choose S/PDIF as the 896mk3's clock source when recording from the S/PDIF device. If you don't want to have to worry about switching the Clock Source setting depending on the direction of the S/PDIF transfer, you can slave the S/PDIF device to word clock from the 896mk3 or vice versa (not shown). The Word Clock connection maintains sync, regardless of the direction of the transfer.

SYNCING OPTICAL DEVICES

When connecting an optical device, make sure that its digital audio clock is phase-locked (in sync with) the 896mk3, as explained in “Making sync connections” on page 21. There are two ways to do this:

1. Resolve the optical device to the 896mk3
2. Resolve the 896mk3 to the optical device

For 1), choose *Internal* (or any other clock source except *ADAT optical*) as the clock source for the 896mk3 in MOTU Audio Setup.

For 2), choose either *ADAT Optical A* or *ADAT Optical B* as the 896mk3’s clock source (Figure 3-11). Be sure to choose the optical port that the device is connected to.

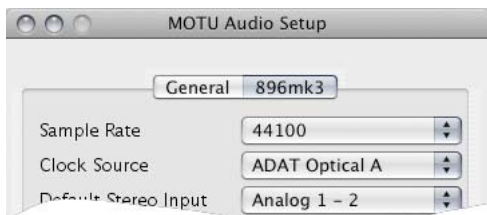

Figure 3-11: Resolving the 896mk3 to an optical device.

For details about using the clock source setting and the MOTU Audio Setup software in general, see chapter 5, “MOTU Audio Setup” (page 35).

Using word clock to resolve optical devices

If the optical device you are connecting to the 896mk3 has word clock connectors on it, you can use them to resolve the device to the 896mk3, similar to the diagram shown in Figure 3-10 on page 24 for S/PDIF devices with word clock. Also see “Syncing word clock devices” on page 28.

SYNCING AES/EBU DEVICES

If you would like to transfer stereo audio digitally between the 896mk3 and another device that has AES/EBU I/O, connect it to the 896mk3’s AES/EBU jacks with balanced, AES/EBU grade audio cables.

AES/EBU clock and sample rate conversion

The 896mk3 AES/EBU section is equipped with a real-time sample rate converter that can be used for either input or output. This feature provides a great deal of flexibility in making digital transfers. For example, you can:

- Transfer digital audio into the 896mk3 at a sample rate that is completely different than the 896mk3 system clock rate.
- Transfer digital audio into the 896mk3 without the need for any external synchronization arrangements.
- Transfer digital audio out of the 896mk3 at double or half the 896mk3 system clock rate.

Rate conversion does not add any appreciable noise to the audio signal (under -120 dB).

Digital audio phase lock

Without sample rate conversion, when you transfer digital audio between two devices, their audio clocks must be in phase with one another — or *phase-locked* — as discussed earlier in “Be sure to choose a digital audio clock master” on page 21 and Figure 3-7 on page 21. Otherwise, you’ll hear clicks, pops, and distortion in the audio, or perhaps no audio at all. Phase lock ensures a clean digital audio transfer.

Another benefit of direct master/slave clocking (without sample rate conversion) is that each slaved device remains continuously resolved to the master, which means that there will be no gradual

drift over time. This form of synchronization is best for audio that needs to remain resolved to film, video, etc.

Sample rate conversion

With sample rate conversion (SRC), an extra level of master/slave clocking is added to the equation, as demonstrated below in Figure 3-12, which shows the clocking going on when you transfer digital audio from the 896mk3 (AES/EBU OUT) to a DAT deck (AES/EBU IN) using SRC. Notice that with SRC, the DAT deck is not slaved to the 896mk3's system clock. Instead, their clocks are running completely independently of one another. But also notice that the DAT deck must still slave to the sample-rate-converted output from the 896mk3 for a clean digital audio transfer (unless it has its own sample rate converter on its AES/EBU input).

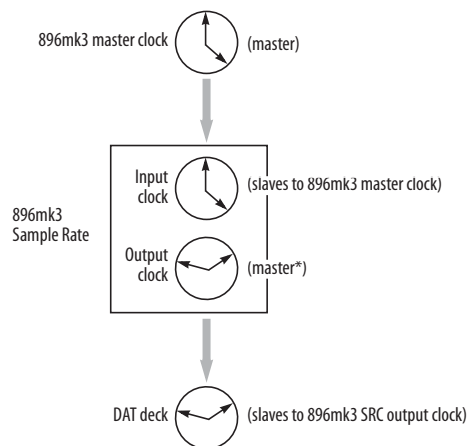

Figure 3-12: Clock relationships when sending audio from the 896mk3 to a DAT deck using sample rate conversion. The DAT deck needs to be slaving to its AES/EBU input. *Note: the 896mk3 AES/EBU output can actually be clocked from a number of different sources. In this example, it is resolved to the 896mk3 system clock. For details about other possible clock sources, see “Clocking scenarios for AES/EBU output” on page 27.

System clock, AES clock & rate convert settings

When you are setting up AES/EBU input and output with the 896mk3, pay careful attention to the following settings in MOTU Audio Setup (see the quick reference overview on page 7):

- Clock source
- Sample rate conversion

These options are mentioned briefly in the following sections. For further details, see “Clock Source” on page 37 and “Sample Rate Convert” on page 40.

Clocking scenarios for AES/EBU input

There are three possible clocking scenarios for the 896mk3 AES/EBU input:

1. Simple transfer (slave the 896mk3 system clock to the AES/EBU input signal — no sample rate conversion).
2. Sample rate convert the AES/EBU input.
3. Use word clock to resolve the 896mk3 system clock and the other AES/EBU device with each other.

These three AES/EBU input scenarios are summarized below.

	Scenario 1	Scenario 2	Scenario 3
Description	Simple transfer	Rate convert	Use word clock
896mk3 clock source setting	AES/EBU	Any setting except AES/EBU	Word Clock
Sample rate conversion setting	None	AES In	None
Required 896mk3 cable connections	AES/EBU In	AES/EBU In	AES/EBU In and Word Clock In
Are the devices continuously resolved?	Yes	No	Yes
Is the signal being sample rate converted?	No	Yes	No
Example application	Simple digital transfer into the 896mk3 from DAT deck or digital mixer.	Transfer from digital mixer running at a different sample rate.	Both the 896mk3 and other AES/EBU device are slaved to "house" word clock.

Some example scenarios are demonstrated below.

Simple AES/EBU input transfer (no rate convert)

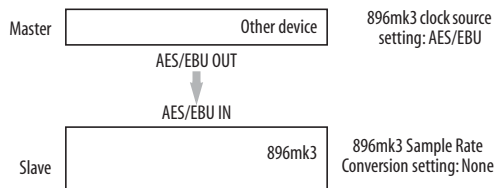

Figure 3-13: Slaving the 896mk3 to an AES/EBU device. For the 896mk3's clock source, choose 'AES/EBU'.

AES/EBU input with rate conversion

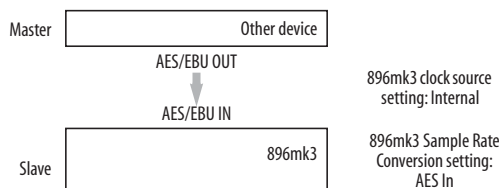

Figure 3-14: Rate-converting AES/EBU input.

AES/EBU input with word clock

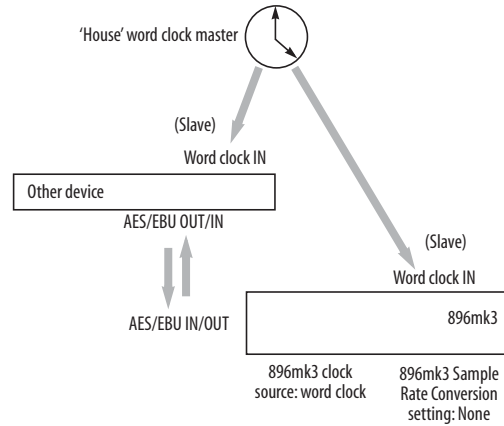

Figure 3-15: In this scenario, the 896mk3 and other AES/EBU device are both resolved to one another via a third master word clock source.

Clocking scenarios for AES/EBU output

The 896mk3 AES/EBU output can also employ sample rate conversion. The output options, shown below in Figure 3-16, are briefly summarized in the following sections. For further details, see "Sample Rate Convert" on page 40.

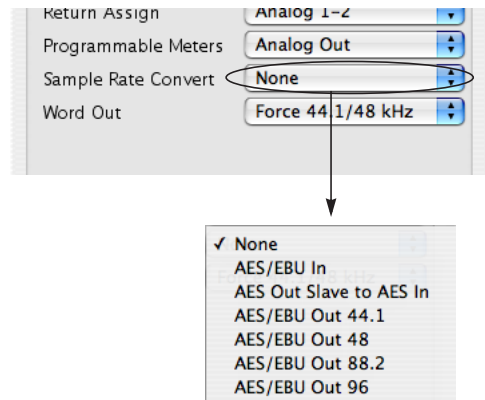

Figure 3-16: The Sample Rate Conversion option in MOTU Audio Setup gives you access the AES/EBU output clock options.

None

To make the AES/EBU output sample rate match the System sample rate, choose *None* (Figure 3-16). No sample rate conversion occurs when this setting is chosen.

AES Out slave to AES In

To make the AES/EBU output sample rate match the sample rate currently being received by the 896mk3's AES/EBU input, choose *AES Out Slave to AES In* (Figure 3-16). This setting requires a connection to the 896mk3's AES/EBU input from a device that is transmitting an AES/EBU clock signal.

☛ Be careful when both the 896mk3's AES/EBU input and output are connected to the same external device: this option is likely to create a clock loop.

AES/EBU Out options

Choose the desired *AES/EBU Out* sample rate options (Figure 3-16) when the desired AES/EBU output rate needs to be completely different than the system clock rate or the AES In clock rate.

SYNCING WORD CLOCK DEVICES

The 896mk3 word clock connectors allow you to synchronize it with a wide variety of other word clock-equipped devices.

For standard word clock sync, you need to choose an audio clock master (as explained in “Be sure to choose a digital audio clock master” on page 21). In the simplest case, you have two devices and one is the word clock master and the other is the slave as shown below in Figure 3-17 and Figure 3-18.



Figure 3-17: Slaving another digital audio device to the 896mk3 via word clock. For the 896mk3 clock source, choose any source besides word clock, as it is not advisable to chain word clock.

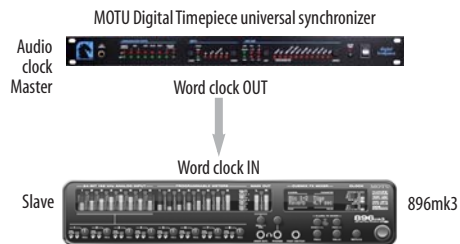

Figure 3-18: Slaving the 896mk3 to word clock. For the 896mk3 clock source, choose 'Word Clock In'.

Don't chain word clock

If you have three or more digital audio devices that you need to synchronize, avoid chaining their word clock connections (OUT to IN, OUT to IN, etc.), as this causes problems. Instead, use a dedicated synchronizer like the Digital Timepiece or a word clock distribution device of some kind.

Slaving to a 2x and 1/2x word clock

All MOTU FireWire audio interfaces that support 96 kHz operation have the ability to slave to a word clock signal running at either one half or one quarter of their current clock rate. For example, the 896mk3 could be running at 96 kHz while slaving to a 48 kHz word clock signal. Similarly, the 896mk3 could run at 88.2 kHz and slave to 44.1 kHz word clock.

Remember, the word clock signal must be one of the following:

- the same as the 896mk3 clock

- half of the 896mk3 clock

Forcing a 1x word out rate

The 896mk3 can generate a word clock output signal that either matches the current system clock rate (any rate between 44.1 and 192kHz) or the corresponding 1x rate. For example, if the 896mk3 is operating at 192kHz, you can choose to generate a word out rate of 48kHz. For details on how to make this word clock output setting, see “Word Out” on page 40.

CONNECTING MULTIPLE MOTU FIREWIRE INTERFACES

You can daisy-chain up to four MOTU FireWire interfaces on a single FireWire bus, with the restrictions described in the following sections. Most computers have only one built-in FireWire bus (even if it supplies multiple FireWire sockets). Connect them as follows:

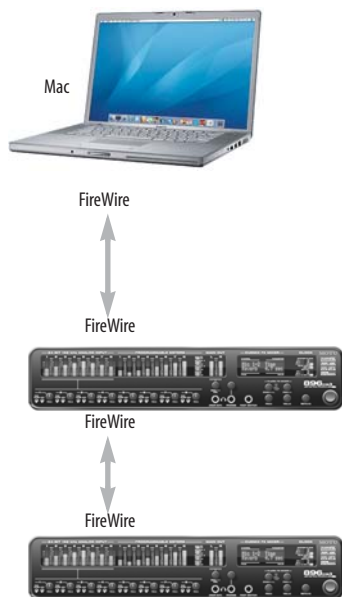

Figure 3-19: Connecting multiple 896mk3's (or other MOTU FireWire audio interfaces) to a computer.

Multiple interfaces cannot be bus-powered

Do not run the Traveler, UltraLite or other bus-powered interfaces under bus power when connecting them with other devices on the same FireWire bus.

Multiple interfaces in MOTU Audio Setup

MOTU Audio Setup displays the settings for one interface at a time. To view the settings for an interface, click its tab as shown below in Figure 3-20.

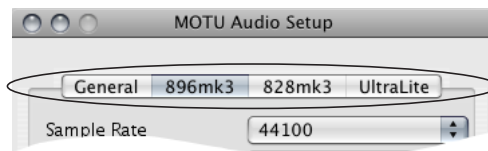

Figure 3-20: To view the settings for an interface, click its tab.

Synchronizing multiple interfaces

Mac OS X provides an advanced, flexible driver model that allows multiple Core Audio drivers to be active at one time, accessed by multiple applications simultaneously. For example, you can run both FireWire and PCI audio interfaces at the same time, accessing all of their inputs and outputs from your host audio application — even multiple applications — simultaneously.

A by-product of this more flexible model is that multiple devices must be synchronized to one another in order to remain resolved to each other. Without synchronization, the audio streams going to each interface might drift with respect to one another. For example, the audio tracks playing back through the 896mk3 might drift out of sync with the audio tracks playing back through your 2408mk3 PCI interface. Synchronizing them to each other ensures that they remain as tightly and continuously phase-locked as if they were one unified interface.

There are two ways to synchronize the 896mk3 with other devices, as discussed in the following sections: via the driver or via word clock.

Resolving to other Core audio drivers

The MOTU FireWire driver has the ability to resolve to other Core Audio drivers. This allows the 896mk3, and other MOTU FireWire interfaces, to resolve to other audio interfaces running simultaneously on the same computer, such as the Mac's built-in audio, a PCI-424 core system, or even 3rd-party interfaces, without the need for external word clock connections between the devices. Doing so ensures that audio tracks being played or recorded by your MOTU FireWire interface will not drift apart from tracks on the other device during long playback or recording passes.

To synchronize multiple devices via the MOTU FireWire driver, choose one device (PCI, FireWire or otherwise) as the master clock and then slave the 896mk3 and other FireWire devices to it. All interfaces will remain resolved to each other via the master interface.

Make the Clock Source settings for each interface as follows:

- For the master interface, click its tab in the FireWire Console and choose any clock source you wish (except any of the slave interfaces, of course).
- For each slave interface, click its tab and choose the master interface from the *Clock Source* menu, as demonstrated below in Figure 3-21. This causes the slave interfaces to resolve to the master interface.

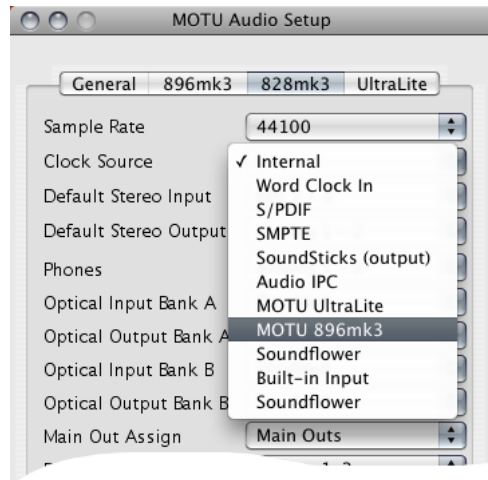

Figure 3-21: To resolve a MOTU FireWire interface to another Core Audio device, choose the other device from the Clock Source menu in the MOTU FireWire Audio Console. In this example, the 828mk3 will slave to the 896mk3.

If you have multiple 896mk3s, choose one as the master, and set its Clock Source to *Internal*. Then, click the tab of the other 896mk3s and set their Clock Source to the first 896mk3.

Resolving to word clock

To resolve two 896mk3 FireWire interfaces with each other via word clock, choose one as the word clock master and then slave the second interface to the first, as shown in Figure 3-19 on page 29. For three interfaces, you can probably get away with daisy-chaining them via their word clock connectors, but this may not always produce the most reliable results. For three or more devices, a word clock distribution device is highly recommended. In this case, the distribution box is the master, and all FireWire interfaces slave directly to it (instead of to each other).

Connecting other MOTU FireWire interfaces

You can add an original MOTU 828 to the end of a FireWire daisy chain (because the 828 has only one FireWire port), or you can mix and match multiple 896mk3s with other MOTU FireWire interfaces using a standard FireWire hub. You can also add

828mk3s, 828mkIIs, 896HDs, Travelers and UltraLites, which have two FireWire ports convenient for daisy-chaining.

Operating multiple FireWire interfaces at high sample rates

Four MOTU FireWire interfaces can operate at 44.1 or 48kHz on a single FireWire bus, although you may have to disable optical banks to conserve FireWire bus bandwidth. At the 2x sample rates (88.2 or 96kHz) and 4x sample rates (176.4 and 192kHz), you can operate no more than two FireWire interfaces on a single FireWire bus.

Adding additional interfaces with a second FireWire bus

Third-party FireWire bus expansion products in the form of a cardbus (“PC card”) adapter or PCI card allow you to add a second FireWire bus to your computer. It may be possible to add additional MOTU FireWire interfaces connected to such a third-party product, depending on their performance with your host computer.

CHAPTER 4 Installing the 896mk3 Mac Software

OVERVIEW

Software installation.....	33
CueMix FX	34
MOTU SMPTE Console	34
AudioDesk workstation software	34

SOFTWARE INSTALLATION

Install the 896mk3 software as follows:

- 1 Insert the MOTU FireWire Installer disc and launch the installer.
- 2 Follow the directions that the installer gives you.

What does the installer do?

The installer checks the computer to make sure it satisfies the minimum system requirements for your MOTU interface. If so, the installer proceeds with the OS X installation. Drivers are installed, along with the MOTU Audio Setup, CueMix FX, and several other applications, summarized in the following table:

Software component	Location	Purpose	For more information
MOTU FireWire Audio driver.kext	/System/Library/Extensions	Provides 896mk3 multi-channel audio input and output with all Mac OS X audio software	“The 896mk3 CoreAudio driver” on page 33
MOTU Audio Setup	Applications folder	Provides access to all of the settings in the 896mk3 and other MOTU interfaces. Required for 896mk3 operation.	chapter 5, “MOTU Audio Setup” (page 35)
CueMix FX	Applications folder	Gives you complete control over the 896mk3’s CueMix FX on-board mixer, which provides no-latency monitoring, mixing and processing of live inputs through your 896mk3.	chapter 11, “CueMix Console” (page 75)
MOTU SMPTE Setup	Applications folder	Provides access to the 896mk3 system’s SMPTE time code sync features.	chapter 12, “MOTU SMPTE Console” (page 103)
AudioDesk	Applications/MOTU AudioDesk	Provides complete multi-track recording, mixing and processing. Optional.	AudioDesk User Guide
AudioDesk Demo Project	Anywhere you want	Provides a multi-track mix that you can open, play, and mix in AudioDesk. Optional.	AudioDesk User Guide

The 896mk3 CoreAudio driver

CoreAudio is a term that refers to the software technology built into Mac OS X that provides all of its standardized audio features. More specifically, we use *CoreAudio* to refer to Mac OS X’s standard audio driver model. A *CoreAudio driver* allows the 896mk3 to establish audio input and output with any Mac OS X CoreAudio-compatible software.

Once the 896mk3’s CoreAudio driver has been successfully installed (by the installer), and you have chosen it for use in your host audio software, the 896mk3 will appear as a choice for audio inputs and outputs in your software.

All MOTU audio hardware, including our PCI systems and other FireWire and USB interfaces, ships with CoreAudio drivers that allow them to operate successfully with virtually all Mac OS X audio software.

CUEMIX FX

This program provides a mixing console that gives you control over the 896mk3's on-board mixing and effects processing. For details, see chapter 11, “CueMix Console” (page 75).

MOTU SMPTE CONSOLE

The MOTU SMPTE Console software provides a complete set of tools to resolve the 896mk3 to SMPTE time code, and to generate SMPTE for striping, regenerating or slaving other devices to the computer. For details, see chapter 12, “MOTU SMPTE Console” (page 103).

AUDIODESK WORKSTATION SOFTWARE

AudioDesk is an advanced workstation software package for the 896mk3 that lets you record, edit, mix, process, bounce and master multi-track digital audio recording projects. Advanced features include real-time 32-bit effects processing, 24-bit recording, and much more.

See the AudioDesk manual included with your 896mk3 system for details.



Figure 4-1: AudioDesk for Mac OS X.

CHAPTER 5 MOTU Audio Setup

OVERVIEW

MOTU Audio Setup gives you access to basic 896mk3 hardware settings, such as sample rate, clock source, optical format and more.

Accessing the 896mk3 settings	35
'896mk3' tab settings	36
Sample Rate	36
Clock Source	37
Default Stereo Input/Output	39
Phones	39
Optical input/output	39
Main Out Assign	39
Return Assign	39
Programmable Meters	40
Sample Rate Convert	40
Word Out	40
Clip Hold Time	40
Peak Hold Time	41
'General' tab settings	41
Launch MOTU Audio Setup when hardware becomes available	41
Edit Channel Names	41
Enable Pedal	41

ACCESSING THE 896MK3 SETTINGS

There are several ways to access MOTU Audio Setup settings:

- Click the MOTU Audio Setup icon in the dock
- Press on the MOTU Audio Setup dock icon to open the menu shown below, or control-click it to open the menu immediately



- From within AudioDesk™ or Digital Performer™, choose *Setup menu > Configure Audio System > Configure Hardware Driver* (Note: this dialog only provides access to basic settings such as sample rate and clock source. For access to all settings, use one of the techniques above.)
- In Cubase or Nuendo, open the Device Setup window, click *VST Audio System* and choose *MOTU Audio ASIO* from the *ASIO Driver* menu. Then click the *MOTU Audio ASIO* item in the list and click the *Control Panel* button.

- From the front panel LCD as explained in chapter 6, “896mk3 Front Panel Operation” (page 43).

896mk3 tab settings

The 896mk3 tab (Figure 5-1) provides settings that apply to a specific 896mk3 interface. If you have several 896mk3 (or other MOTU) interfaces connected, you’ll see a separate tab for each one.

General tab settings

The General tab provides settings that apply globally to all connected MOTU FireWire interfaces.

‘896MK3’ TAB SETTINGS

Sample Rate

Choose the desired *Sample Rate* for recording and playback. The 896mk3 can operate at 44.1 (the standard rate for compact disc audio), 48, 88.2, 96, 176.4 or 192KHz. If you are operating at a sample rate between 44.1 and 96kHz, make absolutely sure that all of the devices connected digitally to the 896mk3 match the 896mk3’s sample rate. Also make sure that your Digital Timepiece, MIDI Timepiece AV or other digital audio synchronizer matches it as well. At the 4x sample rates (176.4 or 192kHz), all digital I/O on the 896mk3 is disabled.

⚠ Mismatched sample rates cause distortion and crackling. If you hear this sort of thing, check the sample rate settings in your hardware and here in MOTU Audio Setup.

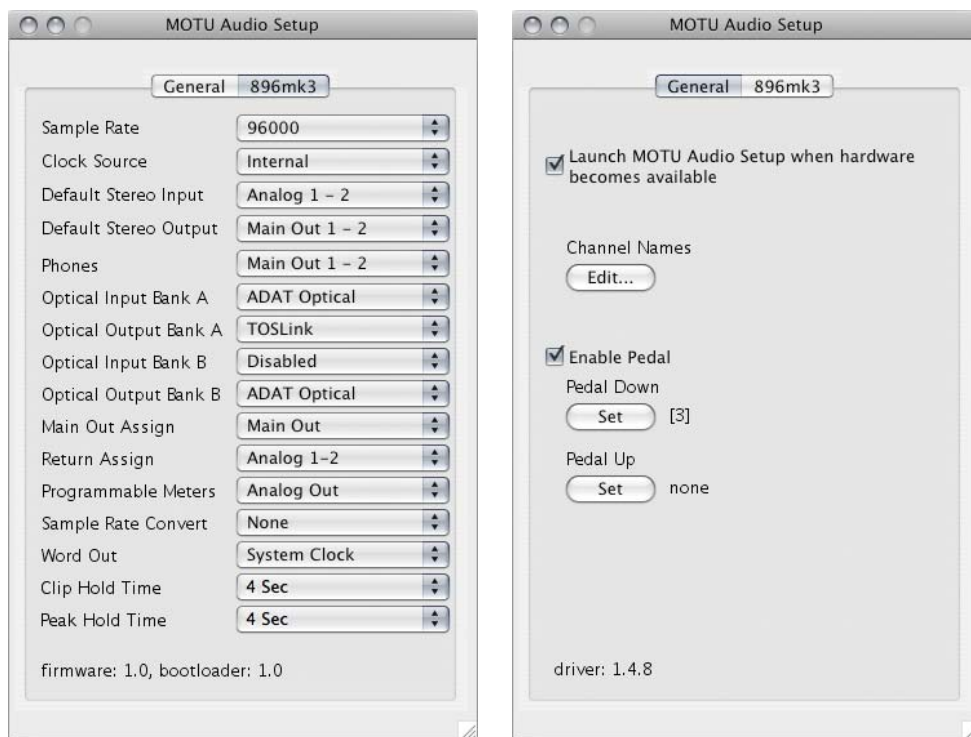

Figure 5-1: MOTU Audio Setup gives you access to all of the settings in the 896mk3 hardware.

Operation at 4x sample rates (176.4 or 192kHz)

At the 4x sample rates (176.4 or 192kHz) the 896mk3 provides eight channels of analog input and eight channels of analog output, simultaneously. However, operation of the 896mk3 is restricted, due to the higher audio bandwidth demands, as follows:

- All digital I/O is disabled (there is no optical, S/PDIF or AES/EBU input/output).
- The *stereo return* bus, as described in “Return Assign” on page 39, can only be assigned to one of the four available analog output pairs or main outs.
- The PHONES jack can only be assigned to one of the four available analog output pairs.
- The MAIN OUT jack can only be assigned to one of four analog output pairs or the main outs.

Clock Source

The *Clock Source* determines the digital audio clock that the 896mk3 will use as its time base. For a complete explanation of synchronization issues, see “Making sync connections” on page 21. The following sections briefly discuss each clock source setting.

Internal

Use the *Internal* setting when you want the 896mk3 to operate under its own digital audio clock. For example, you may be in a situation where all you are doing is playing tracks off hard disk in your digital audio software on the computer. In a situation like this, you most often don't need to reference an external clock of any kind.

Another example is transferring a mix to DAT. You can operate the 896mk3 system on its internal clock, and then slave the DAT deck to the 896mk3 via the AES/EBU connection (usually DAT decks slave to their AES/EBU input when you choose the AES/EBU input as their record source) or via the 896mk3's word clock output (if your DAT deck has a word clock input).

If you would like help determining if this is the proper clock setting for your situation, see “Making sync connections” on page 21.

Word Clock In

The *Word Clock In* setting refers to the Word Clock In BNC connector on the 896mk3 rear panel. Choosing this setting allows the 896mk3 to slave to an external word clock source, such as the word clock output from a digital mixer or another MOTU FireWire interface.

S/PDIF

The *S/PDIF* clock source setting refers to the S/PDIF RCA input jack on the 896mk3. This setting allows the 896mk3 to slave to another S/PDIF device.

Use this setting whenever you are recording input from a DAT deck or other S/PDIF device into the 896mk3. It is not necessary in the opposite direction (when you are transferring from the 896mk3 to the DAT machine).

For further details about this setting, see “Syncing S/PDIF devices” on page 24.

AES/EBU

The *AES/EBU* clock source setting refers to the AES/EBU input connector on the 896mk3. This setting allows the MOTU 896mk3 to slave to another AES/EBU device.

Use this setting whenever you are recording input from a DAT deck or other AES/EBU device into the 896mk3. It is not necessary in the opposite direction (when you are transferring from the 896mk3 to the DAT machine).

For further details about this setting, see “Syncing AES/EBU devices” on page 25.

ADAT optical A / B

The *ADAT optical* clock source settings (*ADAT Optical A* and *ADAT Optical B*) refer to the clock provided by the 896mk3's two optical inputs, when either one is connected to another optical device. These two settings only appear in the Clock Source menu when their corresponding optical bank input is enabled and set to the *ADAT Optical* format, as explained in "Optical input/output" on page 39.

This setting can be used to resolve the 896mk3 directly to the optical input connection. Most of the time, you can set up a better operating scenario that uses one of the other synchronization options. However, there may be occasions when you have an optical device that has no way of synchronizing digitally to the 896mk3 or an external synchronizer. In this case, the *ADAT Optical* clock source setting lets you slave the 896mk3 to the device itself via its digital input to the 896mk3.

This setting is also useful if you just need to make a simple, click-free digital transfer between the 896mk3 and another device — where a time code reference and shared transport control are not needed — without having to set up an elaborate synchronization scenario.

For further details about this setting, see "Syncing optical devices" on page 25.

TOSLINK A / B

The *TOSLINK* clock source settings (*TOSLINK A* and *TOSLINK B*) refer to the clock provided by the 896mk3's two optical inputs, when either one is connected to another optical device. These two settings only appear in the Clock Source menu with their corresponding optical bank input is enabled and set to the *TOSLINK* format, as explained in "Optical input/output" on page 39.

The *TOSLINK* clock source setting refers to the clock provided an optical S/PDIF device connected to the 896mk3's optical input. This setting can be

used to slave the 896mk3 directly to the optical input connection. Most of the time, you can set up a better operating scenario that uses one of the other synchronization options. However, there may be occasions when you have an TOSLINK-compatible device that has no way of synchronizing digitally to the 896mk3 or an external synchronizer such as the Digital Timepiece. In this case, the *TOSLINK* clock source setting lets you slave the 896mk3 to the other device via the 896mk3's optical input.

This setting is also useful if you just need to make a simple, click-free digital transfer between the 896mk3 and another device — where a time code reference and shared transport control are not needed — without having to set up an elaborate synchronization scenario.

For further details, see "Syncing optical devices" on page 25.

SMPTE

Choose this setting to resolve the 896mk3 directly to SMPTE time code (LTC) being received via the 896mk3's quarter-inch SMPTE input jack. For details, see "Syncing to SMPTE time code directly" on page 22 and chapter 12, "MOTU SMPTE Console" (page 103).

Built-in Audio

Choose this setting to resolve the 896mk3 to your Mac's built-in audio. Doing so will ensure that audio streams playing back from or recorded by the 896mk3 will not drift apart from audio streams simultaneously played or recorded by the Mac's built-in mic, speakers or audio output.

Other audio devices (drivers)

You may see other devices in the Clock Source list, such as another MOTU FireWire interface, a MOTU PCI-424 system, the Mac's built-in audio, or perhaps even another third-party audio interface. The 896mk3 can resolve to these other

audio devices via their CoreAudio driver. This allows you to play and record audio with your host audio software via both interfaces at the same time without their audio streams drifting apart from one another over long recording or playback passes. No external synchronization connections are required for this setting, as the two devices are entirely resolved via the software driver.

Default Stereo Input/Output

In the System Preferences window, Mac OS X lets you choose third-party hardware such as the 896mk3 for your Mac sound input and output. The system input and output can be used for alert sounds and general audio I/O for applications like iTunes, iMovie, etc.



Figure 5-2: The Mac OS X sound preferences let you use the 896mk3 for general stereo audio input and output for your Mac.

The *Default Stereo Input* and *Default Stereo Output* settings in MOTU Audio Setup (Figure 5-1 on page 36) let you specify the stereo input and output on the 896mk3 to be used when it is chosen as the audio I/O device in the system preferences.

Phones

The *Phones* setting lets you choose what you will hear from the headphone jack. Choose *Main Outs* if you'd like to route the Main Out stereo pair to the PHONES jack. Choose *Phones* if you would like the headphones to serve as their own independent output, which you can access as an independent output destination in your host audio software and as an output destination for the four on-board CueMix FX mix busses.

Optical input/output

The *Optical input* and *Optical output* settings let you choose between ADAT optical ('lightpipe') and S/PDIF optical ('TOSLINK') as the format for the 896mk3's two banks of optical input and output (Bank A and Bank B). Choose the format that matches the device connected. If you are not using the optical connections, it is recommended that you turn them off (by choosing *Disabled* from the menu) to reduce bandwidth and processing overhead. Note that you can operate each optical port independently. For example, you could use the ADAT optical format on the Bank A input (with a digital mixer, for example) and optical S/PDIF on the Bank A output (with a DAT deck, for example).

Main Out Assign

Choose *Main Outs* from the *Main Out Assign* menu to treat the Main Outs as their own independent output pair. Choose any other output pair to cause the MAIN OUT jacks to mirror (duplicate) the output pair you choose.

Return Assign

The *Return Assign* menu lets you choose any pair of 896mk3 audio outputs. The audio signal from this output pair is then sent back to the computer via

the *Stereo Return 1-2* bus. This stereo return bus from the 896mk3 appears in your host software alongside all other 896mk3 inputs, wherever your host software lists them.

The 896mk3 stereo return bus can be used for a variety of purposes. For example, you could use it to send a final mix being played through the 896mk3 back to the computer, where you could record it for mastering or archiving purposes.

As another example, you could use the stereo return bus to capture tracks played from your host software, along with live inputs being routed directly through the 896mk3 hardware via CueMix FX (with or without CueMix effects processing on the live inputs).

Programmable Meters

This option lets you choose which bank you wish to monitor with the eight programmable meters on the MOTU 896mk3 front panel. Your choices are: Analog Out, Optical A In, Optical A Out, Optical B In, Optical B Out, or Digital In/Out. This last option displays AES/EBU input, S/PDIF input, AES/EBU output and S/PDIF output, in order from left to right. You can also adjust this setting by turning the METERS knob on the 896mk3 front panel.

Sample Rate Convert

The Sample Rate Convert option (Figure 3-16 on page 27) lets you control AES/EBU sample rate conversion. Sample rate conversion is available when the 896mk3 is operating at the 1x sample rates (44.1 and 48kHz) or the 2x sample rates (88.2 or 96kHz). AES/EBU is disabled entirely at the 4x samples rates (176.4 and 192kHz). Each option is explained below.

None

To make the AES/EBU output sample rate match the System sample rate, choose *None* (Figure 3-16 on page 27). No sample rate conversion occurs when this setting is chosen.

AES Out slave to AES In

To make the AES/EBU output sample rate match the sample rate currently being received by the 896mk3's AES/EBU input, choose *AES Out Slave to AES In* (Figure 3-16 on page 27). This setting requires a connection to the 896mk3's AES/EBU input from a device that is transmitting an AES/EBU clock signal.

☛ Be careful when both the 896mk3's AES/EBU input and output are connected to the same external device: this option is likely to create a clock loop.

AES/EBU Out options

Choose the desired *AES/EBU Out* sample rate options (Figure 3-16 on page 27) when the desired AES/EBU output rate needs to be completely different than the system clock rate or the AES In clock rate. For further details about this option, see "Sample Rate Convert" on page 40.

Word Out

The *Word Out* menu appears when the 896mk3 is operating at a 2x sample rate (88.2 or 96kHz) or 4x sample rate (176.4 or 192kHz). This menu lets you set the word clock output either to match the current sample rate (*System Clock*) or force it to the corresponding 1x rate (either 44.1 or 48kHz). For example, if the 896mk3 were operating at 176.4kHz, choosing the *Force 44.1/48kHz* option would produce word clock output at 44.1kHz.

Clip Hold Time

The *Clip Hold Time* option controls how long the top red LED on the front panel metering remains illuminated after clipping occurs.

If you want the ability to clear the LED manually from your host audio software or the Cue Mix Console, Choose *Infinite* from the *Clip Hold Time* menu. In Digital Performer or AudioDesk, you can clear the 896mk3 clip LEDs by choosing Audio menu>Clear All Clipping Indicators.

Peak Hold Time

The 896mk3 front-panel level meters support standard peak/hold metering, where the LED for the highest level recently measured on the channel remains illuminated for a brief period of time while the rest of the LEDs below it remain fully dynamic. The *Peak Hold Time* controls how long the peak-hold LED remain illuminated before going dark again.

‘GENERAL’ TAB SETTINGS

Launch MOTU Audio Setup when hardware becomes available

Check this option if you would like the MOTU Audio Setup icon to appear in the application dock as soon as a MOTU interface is detected (switched on, plugged in, etc.)

Edit Channel Names

Click the *Edit Channel Names* button to open the Channel Names window (Figure 5-3). This window lets you edit the names of the 896mk3 inputs and outputs, as they appear in your host audio software. For example, when you click on a menu that displays the 896mk3 inputs (or outputs), you will see the names you specify in this window (e.g. “vocal mic”, “lead guitar”, etc.), instead of the default generic names (“Analog 1”, “Analog 2”, etc.)

☛ Not all Mac OS X audio software supports channel names. If not, you’ll see generic port names in your host audio software.

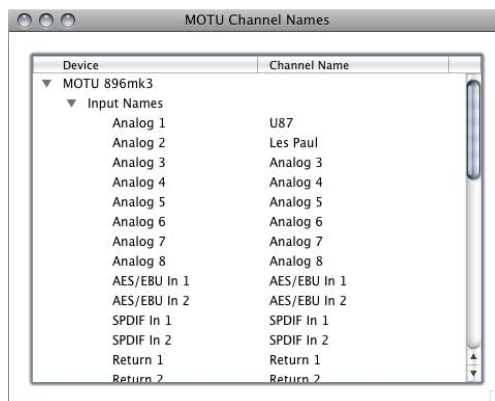

Figure 5-3: The Edit Channel Names window.

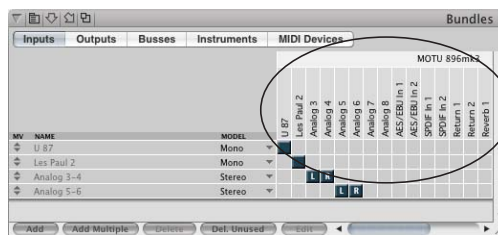

Figure 5-4: 896mk3 channel names as they appear in Digital Performer.

Enable Pedal

Check the Enable Pedal option if a foot switch is connected to the 896mk3 and you would like to trigger recording punch in/out (or other software functions) with it. Use the Set buttons to determine what keystroke is triggered by the pedal-up and pedal-down positions. You can assign the pedal to any two keystrokes you wish. (You are not restricted to punch in/out.)

CHAPTER 6 896mk3 Front Panel Operation

OVERVIEW

The 896mk3 is the first FireWire audio interface to offer complete front-panel programming via six rotary encoders and a 2x16 backlit LCD display. All 896mk3 settings can be accessed via these front-panel controls.

Analog input controls.....	43
Master vol and “(MAIN OUT)” phone jack	44
Phones.....	44
Analog input meters with V-Limit™ compression ...	44
Programmable meters.....	45
Push-button rotary encoders	45
Multi-function LCD display	45
896mk3 Setup menu	46
Audio menu	47
CueMix menu.....	47
Inputs menu	51
Outputs menu	51
Mixes menu.....	52
Reverb menu	52
Stand-alone operation.....	52

ANALOG INPUT CONTROLS

The 896mk3 front panel analog input controls (Figure 6-1) allow to work with a wide variety of recording situations.

For information about connections and settings, see “Analog inputs” on page 18 in the installation chapter.

For information about the many settings available for the mic/guitar inputs, see:

- “The Inputs tab” on page 80
- “The channel settings section” on page 84
- “The Channel tab” on page 84
- “The EQ tab” on page 86
- “The Dynamics tab” on page 93



Figure 6-1: The 896mk3 front panel mic/guitar inputs and phone jacks.

MASTER VOL AND “(MAIN OUT)” PHONE JACK

From the factory, the MASTER VOL knob controls the main outs (analog 1-2), but MASTER VOL can be programmed to control any combination of outputs. See “The Monitor Group” on page 97 for details. Push the knob once to view the current volume setting in the LCD display; push it again to mute the monitor group; push a third time to return to the previous volume.



Figure 6-2: the phone jacks.

PHONES

From the factory, the PHONES jack (Figure 6-2) is a discrete output at 44.1/48 kHz, but it can mirror any other output pair (digital or analog) or serve as its own independent output. For example, at 88.2/96 kHz, it defaults to mirroring the XLR main outs. At 176.4/192 kHz, it defaults to mirroring analog outputs 1-2.

As the primary phone jack, it has its own dedicated volume knob.

The LCD provides detailed feedback as you turn the knob (Figure 6-7). To view the current setting without changing it, just push the knob (without turning it).

If you would like the (MAIN OUT) phone jack and the PHONES jack to output the same signal, assign the PHONES output to mirror the main outs. In this configuration, both the MASTER VOL and the PHONES volume knobs control the PHONES volume.

ANALOG INPUT METERS WITH V-LIMIT™ COMPRESSION

All eight inputs are equipped with V-Limit™, a hardware limiter. With the limiter turned off, signals that hit zero or above will clip (a hard digital clip). However, with V-Limit enabled, signals can go as high as +12 dB above zero with no digital clipping. If the signal then goes above +12 dB, it will clip, even with V-Limit engaged. In either case, the clip LED (above +12) will illuminate.

Two input level scales

To accommodate these two scenarios, the eight analog input meters (Figure 6-3) are labeled with two different input level scales: from -42 to -1 (when V-Limit is disabled) and -42 to +12 dB (when V-Limit is engaged).

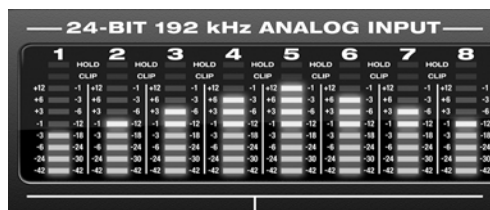

Figure 6-3: Analog input metering.

For further information about V-Limit, as well as another feature called *Soft Clip*, see “Overload protection (mic/guitar inputs only)” on page 85.

CLIP and HOLD LEDs

The CLIP and HOLD LEDs indicate when clipping has occurred (either with or without V-Limit). You can set the amount of time for the HOLD LED. See “Clip Hold Time” on page 40.

PROGRAMMABLE METERS

The programmable meter bank (Figure 6-4) lets you view the levels of any input or output bank (except analog input, which has its own bank): Analog Out, Optical A In, Optical A Out, Optical B In, Optical B Out, or Digital In/Out. This last option displays AES/EBU input, S/PDIF input, AES/EBU output and S/PDIF output, in order from left to right, as shown below.

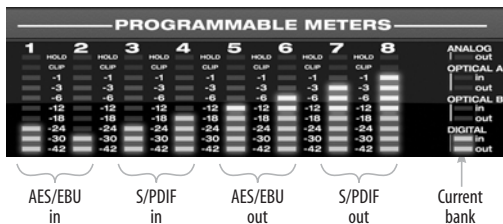

Figure 6-4: The programmable meter bank. The “Digital I/O” bank shows the AES/EBU and S/PDIF input and output as indicated above.

Choose the desired bank by turning the METERS knob on the 896mk3 front panel (Figure 6-5). The current bank is indicated by the LEDs to the right of the programmable meter bank (Figure 6-4). You can also push the METERS knob to view the currently selected bank in the LCD.

You can also specify the bank in MOTU Audio Setup. See “Programmable Meters” on page 40.



Figure 6-5: the phone jacks.

PUSH-BUTTON ROTARY ENCODERS

All of the knobs shown in Figure 6-6 are push-button digital rotary encoders. In many cases, you can either push the knob or turn it to make a setting or toggle the LCD display (depending on the encoder and setting).

MULTI-FUNCTION LCD DISPLAY

The multi-function LCD (Figure 6-6) provides access to the many 896mk3 settings, as well as visual feedback of the current parameter being modified.

Parameter “zooming”

For many settings, the LCD temporarily “zooms in” to display a long-throw meter and alphanumeric display to give you precise, real-time feedback as you adjust the setting. For example, if you change the headphone volume, the LCD will display a level meter and gain reduction reading that updates as you turn the volume knob (Figure 6-7). After a brief time-out, the display returns to its previous state before you turned the volume knob.



Figure 6-7: The LCD provides feedback as you adjust volume.

Three global menus

Push the PARAM knob (Figure 6-6) to cycle the LCD among three global menus, described in the rest of this chapter:

- 896mk3 SETUP
- AUDIO (settings)
- CUEMIX (mixer)

896MK3 SETUP MENU

To access the 896mk3 *SETUP* menu, push the *PARAM* knob until you see *896mk3 SETUP* displayed in the LCD. This menu provides basic features for managing the 896mk3 hardware. Turn the *PARAM* knob to access each setting, explained briefly below.

LCD Contrast

Turn the *VALUE* knob to adjust the LCD contrast.



Figure 6-8: In setup mode, the LCD displays a setup parameter in the top row of the LCD and the current setting in the bottom row.

Save/Name Preset

An 896mk3 preset holds all current CueMix FX mix settings (everything in the *CUEMIX* menu). *SETUP* menu and *AUDIO* menu parameters are not included. Turn the *VALUE* knob to move from character to character in the preset name. Turn *PAGE* to change the currently flashing letter. Once you've named the preset, push *VALUE* to save it, turn it again to choose the desired preset slot you wish to save it to (1-16), and the push again to confirm the save. To cancel the save operation at any time by turning the *PARAM* knob.

Load Preset

Turn *VALUE* to choose the preset you wish to load (1-16) and push *VALUE* to load it.

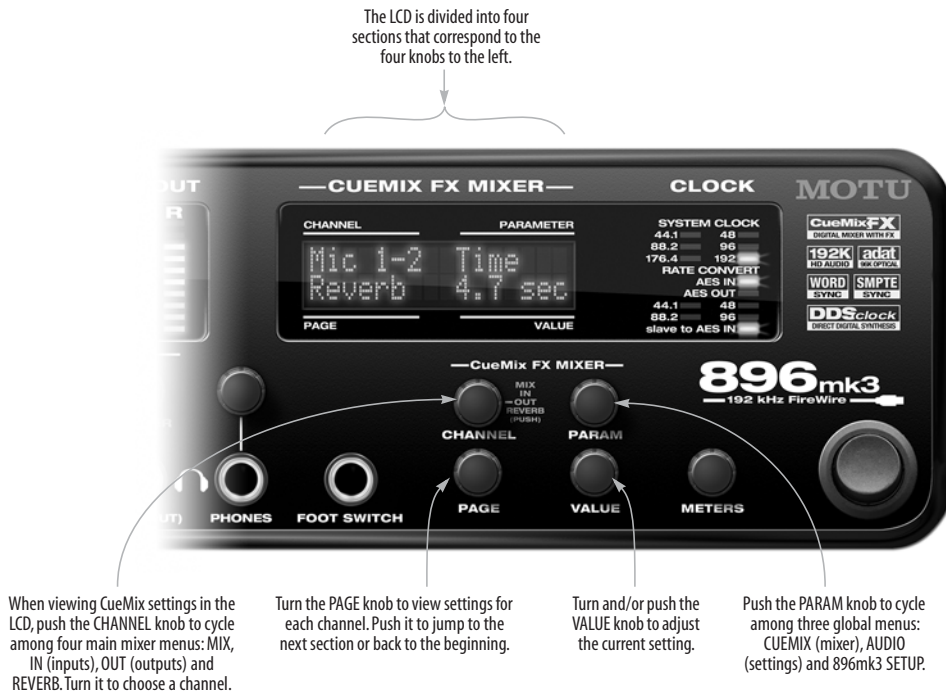

Figure 6-6: The 896mk3 front panel controls.

Factory Defaults

Push VALUE to restore the 896mk3 hardware to its factory default settings. Push VALUE again to confirm, or turn PARAM to cancel.

AUDIO MENU

To access the AUDIO menu, push the PARAM knob until you see *AUDIO* displayed in the LCD. This menu provides basic settings such as sample rate, clock source, optical bank format (ADAT versus TOSLINK), and so on. These settings have corresponding settings in the MOTU Audio Setup software, as shown below:

Audio menu item	Where to find more information
Clock Source*	“Clock Source” on page 37
Sample rate*	“Sample Rate” on page 36
Phones Assign	“Phones” on page 39
Main Out Assign	“Main Out Assign” on page 39
Return Assign	“Return Assign” on page 39
Return Assign	“Return Assign” on page 39
Rate Convert	“Sample Rate Convert” on page 40
Optical In/Out A/B*	“Optical input/output” on page 39
ADAT SMUX Type	See below. This menu item is only available when the 896mk3 is operating at 88.2 or 96 kHz.
Word Clock Out	“Word Out” on page 40
Clip Hold Time	“Clip Hold Time” on page 40
Peak Hold Time	“Peak Hold Time” on page 41

** If the 896mk3 is currently connected to a computer, this setting cannot be changed from the front-panel LCD. It must be changed in MOTU Audio Setup instead. Or, you can disconnect the 896mk3 from the computer to change the Clock Source from the front panel.*

ADAT SMUX Type

When the 896mk3 is operating at either 88.2 or 96 kHz, the AUDIO menu includes an item called *ADAT SMUX Type*.

This setting lets you configure the optical ports for ADAT format operation at the 2x sample rates only (88.2 or 96 kHz).

There are two choices:

- Type I — for 2x optical connection to 3rd-party SMUX-compatible hardware products
- Type II — for 2x optical connection to MOTU products that are equipped with optical ports and support 2x operation

Turn the VALUE knob to select an optical port and push the knob to toggle between the Type I and Type II setting.

CUEMIX MENU

To access the CUEMIX menu, push the PARAM knob until you see *CUEMIX* displayed in the LCD. This menu displays the settings for the 896mk3 CueMix FX mixer.

CueMix mixer basics

It is much easier to navigate the CUEMIX menu in the LCD if you have a general understanding of the CueMix FX mixer. We strongly recommend that you review chapter 11, “CueMix Console” (page 75) before learning the LCD, especially “CueMix FX basic operation” on page 77.

CUEMIX menu organization

Mixer settings are divided into four sub-menus, which correspond to the Inputs, Mixes, Outputs and Reverb tabs in the CueMix FX software:

- IN (inputs)
- OUT (outputs)
- MIX (Mixes)
- REVERB (reverb processor)

Navigating the four main menus

To access the four main menus above, push the CHANNEL knob repeatedly. Then turn the CHANNEL knob to select the desired channel or mix.

The IN (inputs) menu

Push the CHANNEL button repeatedly until you see “I:” in the channel section of the LCD (Figure 6-9). This is similar to accessing the Inputs tab in CueMix FX console (“The Inputs tab” on page 80).

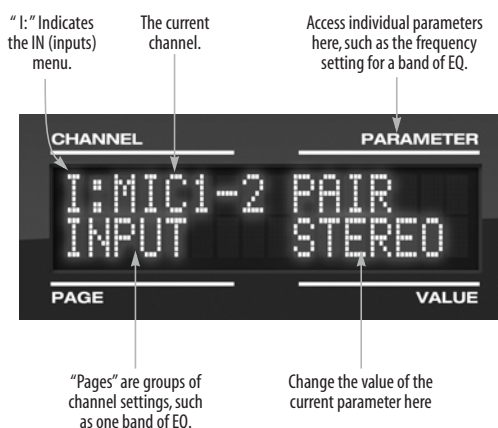

Figure 6-9: The IN (inputs) menu.

Choosing a channel

Once you see the Inputs menu (Figure 6-9) in the LCD, turn the CHANNEL knob to select the desired input that you wish to edit. This is roughly equivalent to specifying an input channel strip to work with in the Inputs tab in CueMix FX software (Figure 11-3 on page 80).

Choosing a setting to modify

Once you’ve selected an input channel, you can access the various settings for that channel using the PAGE knob and PARAMETER knobs.

Turn the PAGE knob to scroll through channel settings such as individual bands of EQ, the compressor, reverb sends, etc. Push the PAGE knob

to jump to the next “section” of parameters or to jump back to the beginning of the list. This is roughly the equivalent of moving through the various channel controls in an individual input channel strip in CueMix FX (Figure 11-3 on page 80), as well as the settings in the Channel tab (Figure 11-8 on page 84).

Turn the PARAMETER knob to scroll through individual parameters, such as the frequency for the current band of EQ. This is roughly equivalent to the parameters in the EQ tab (Figure 11-10 on page 86), Dynamics tab (Figure 11-21 on page 93) and Reverb tab (Figure 11-23 on page 96) in the CueMix FX software.

Adjusting the value of a parameter

Turn the VALUE knob to adjust the value of the current PARAMETER. Some parameters have default values. If so, push the VALUE knob to cycle through them.

Inactive items

If a menu item is inactive for some reason (perhaps it doesn’t currently apply or it is disabled), it is displayed in parentheses.

Copying and pasting

EQ, dynamics and Mix Assign settings allow you to copy and paste settings between EQ bands and/or channels. Push the VALUE knob to copy, scroll to the other item and then push again to paste.

Summary of Inputs menu settings

For a summary of Inputs menu settings, see “Inputs menu” on page 51.

The OUT (Outputs) menu

Push the CHANNEL button repeatedly until you see “O:” in the channel section of the LCD (Figure 6-10). This is similar to accessing the Outputs tab in CueMix FX console (“The Outputs tab” on page 82).

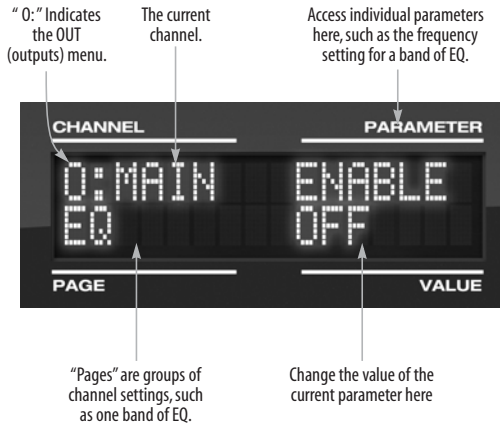

Figure 6-10: The OUT (outputs) menu.

Choosing a channel

Once you see the Outputs menu (Figure 6-10) in the LCD, turn the CHANNEL knob to select the desired output that you wish to edit. This is roughly equivalent to specifying an output channel strip to work with in the Outputs tab in CueMix FX software (Figure 11-6 on page 83).

Working with outputs in the LCD

Once you've selected an output channel, you can access the various settings for that channel using the PAGE knob and PARAMETER knobs. The knobs function the same as described for inputs in "Choosing a setting to modify" on page 48 and "Adjusting the value of a parameter" on page 48.

Summary of Output menu settings

For a summary of Inputs menu settings, see "Outputs menu" on page 51.

The MIX (Mixes) menu

Push the CHANNEL button repeatedly until you see "MIX 1" (or "MIX 2", etc.) in the channel section of the LCD (Figure 6-11). This is similar to accessing the Mixes tab in CueMix FX console ("The Mixes tab" on page 78).

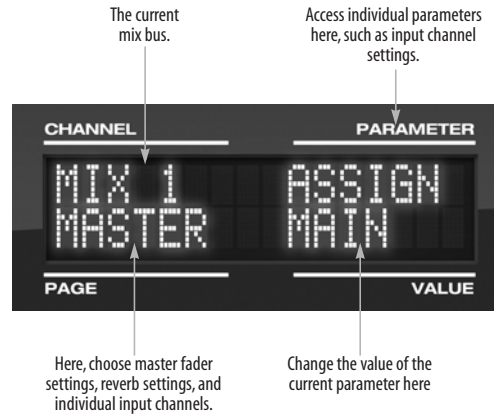

Figure 6-11: The MIX (Mixes) menu.

Choosing a mix bus

Once you see the MIX menu (Figure 6-11) in the LCD, turn the CHANNEL knob to select the desired mix that you wish to edit. This is roughly equivalent to choosing a mix in the Mixes tab in CueMix FX software (Figure 11-2 on page 78).

Working with mix busses in the LCD

Once you've selected a mix, you can access the various settings for that mix using the PAGE knob and PARAMETER knobs. The knobs function the same as described for inputs in "Choosing a setting to modify" on page 48 and "Adjusting the value of a parameter" on page 48. The PAGE knob scrolls through the following mix bus settings:

- MASTER — these are master fader settings, such as the master fader output assignment, master mute on/off, and the master fader volume. Access them with the PARAMETER knob.

REVERB — these are the reverb send and return controls for the bus master fader. Access them with the PARAMETER knob. Note: if the reverb processor is currently disabled, reverb is displayed in parentheses. If you are running the 896mk3 at 88.2 kHz or higher, the Reverb processor is disabled, and therefore the REVERB setting does not appear in the LCD as an option.

- Individual channels — once you scroll past MASTER and REVERB, the PAGE knob then scrolls through all available inputs for the mix bus. Once you choose an input, access its channel settings using the PARAM knob and VALUE knob.

Summary of Mix menu settings

For a summary of Mix menu settings, see “Mixes menu” on page 52.

The REVERB menu

Push the CHANNEL button repeatedly until you see “REVERB” in the channel section of the LCD (Figure 6-12). This is similar to accessing the Reverb tab in CueMix FX (“The Reverb tab” on page 96).

☞ The REVERB processor is not available at sample rates above 48 kHz. Therefore, when the 896mk3 is operating at 88.2 kHz or higher, the REVER menu does not appear in the LCD.

Working with reverb settings in the LCD

Once you’ve selected the REVERB menu, you can access all settings using the PARAMETER and VALUE knobs. The PAGE knob is not needed and is therefore disabled when editing reverb settings.

Summary of Reverb menu settings

For a summary of Reverb menu settings, see “Reverb menu” on page 52.

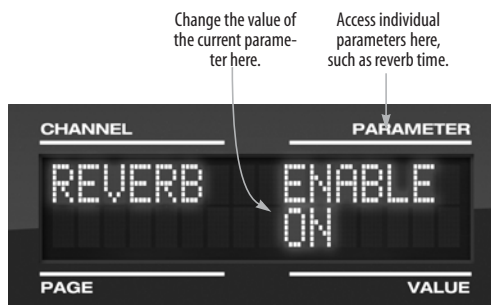

Figure 6-12: The REVERB menu.

INPUTS MENU

CHANNEL	PAGE	PARAM
INPUTS Analog 1-2 Analog 3-4 etc.	INPUT	PAIR PHASE L-R/M-S (stereo or M/S) SWAP WIDTH TRIM LIMITER LOOKAHEAD SOFTCLIP
	EQ (global)	ENABLE COPY PASTE RESET
	HPF (High-pass)	ENABLE SLOPE FREQ
	LF (Low w/shelf)	ENABLE TYPE FREQ GAIN WIDTH
	LMF (Low-mid)	ENABLE TYPE FREQ GAIN WIDTH
	MF (Mid)	ENABLE TYPE FREQ GAIN WIDTH
	HMF (High-mid)	ENABLE TYPE FREQ GAIN WIDTH
	HF (High w/shelf)	ENABLE TYPE FREQ GAIN WIDTH
	LPF (Low-pass)	ENABLE SLOPE FREQ
	DYN (Dynamics)	ENABLE COPY PASTE RESET
	COMP (Compressor)	ENABLE MODE THRESH RATIO ATTACK RELEASE TRIM
	LEVELER	ENABLE MODE REDUCE MAKEUP
	REVERB	SEND SEND PAN (mono only)

OUTPUTS MENU

CHANNEL	PAGE	PARAM
OUTPUTS Main Analog 1-2 Analog 3-4, etc.	EQ (global)	ENABLE COPY PASTE RESET
	HPF (High-pass)	ENABLE SLOPE FREQ
	LF (Low w/shelf)	ENABLE TYPE FREQ GAIN WIDTH
	LMF (Low-mid)	ENABLE TYPE FREQ GAIN WIDTH
	MF (Mid)	ENABLE TYPE FREQ GAIN WIDTH
	HMF (High-mid)	ENABLE TYPE FREQ GAIN WIDTH
	HF (High w/shelf)	ENABLE TYPE FREQ GAIN WIDTH
	LPF (Low-pass)	ENABLE SLOPE FREQ
	DYN (Dynamics)	ENABLE COPY PASTE RESET
	COMP (Compressor)	ENABLE MODE THRESH RATIO ATTACK RELEASE TRIM
	LEVELER	ENABLE MODE REDUCE MAKEUP
	REVERB	SEND RETURN
	MASTER	MONITOR TALKBACK LSNBACK

MIXES MENU

CHANNEL	PAGE	PARAM
MIXES Mix 1 Mix 2 etc.	MASTER	ASSIGN MUTE FADER COPY PASTE RESET
	REVERB	SEND RETURN
	ANALOG 1-2 (if stereo)	MUTE SOLO BAL/WID BALANCE/WIDTH FADER
	ANALOG 1 ANALOG 2 etc. (if mono)	MUTE SOLO (BAL/WID) - n/a PAN FADER
	AES 1-2	MUTE SOLO BAL/WID BALANCE/WIDTH FADER
	SPDIF	MUTE SOLO BAL/WID BAL FADER
	ADAT A1-2 ADAT A3-4 etc.	MUTE SOLO BALD/WID BALANCE/WIDTH FADER
	ADAT B1-2 ADAT B3-4 etc.	MUTE SOLO BALD/WID BALANCE/WIDTH FADER

REVERB MENU

CHANNEL	PAGE	PARAM
REVERB	---	ENABLE TIME PREDELAY WIDTH CUT Hz CUT dB ROOM REFSIZE REF LEV LO % MID % HI % LO XOVR HI XOVR SPLIT

STAND-ALONE OPERATION

All settings, including all mix settings and global settings, are saved in the 896mk3's memory, and they remain in effect even when the 896mk3 is not connected to a computer. This allows you to use the 896mk3 as a stand-alone 8-bus mixer. You can make adjustments to any setting at any time from the front panel.

CHAPTER 7 Digital Performer

OVERVIEW

This chapter provides a brief overview of Digital Performer’s basic I/O and synchronization operation with the 896mk3 hardware.

Setting up your system	53
The 896mk3 settings	53
Working with 896mk3 inputs and outputs	55
24-bit operation	55
Processing live inputs with DP plug-ins	55
Working with CueMix FX mixing and effects	55
Synchronization	56
Using a foot switch	56
Exchanging projects with AudioDesk	56

SETTING UP YOUR SYSTEM

As described in chapter 4, “Installing the 896mk3 Mac Software” (page 33), the Digital Performer and MOTU 896mk3 software installers will properly install and update everything for you.

If you are using a MIDI Timepiece AV or Digital Timepiece for synchronization, be sure they are present in Audio MIDI setup.

THE 896MK3 SETTINGS

Choose the 896mk3 as your audio input output device by choosing *Configure Audio System* > *Configure Hardware Driver* from the Setup menu. This window shows some of the 896mk3 settings, such as sample rate and clock source, but to access all of the 896mk3 settings, open MOTU Audio Setup, as shown in Figure 5-1 on page 36.

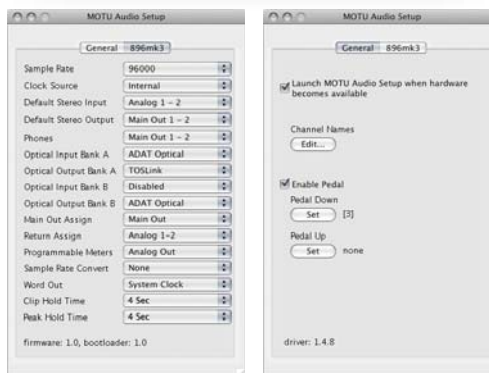
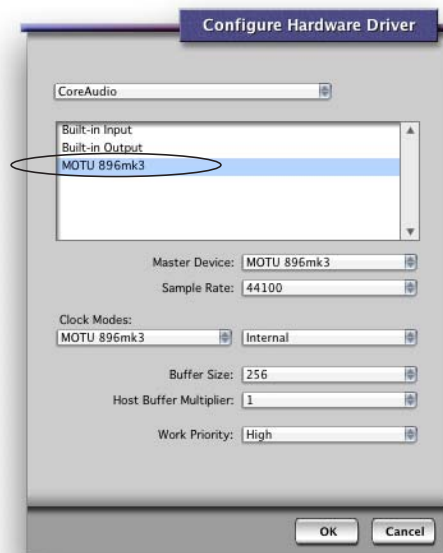

Figure 7-1: Choose Setup menu > Configure Audio System > Configure Hardware Driver to open the dialog shown above and access the 896mk3 CoreAudio driver. To access the rest of the 896mk3 settings, open MOTU Audio Setup.

For complete details about the 896mk3 settings, see chapter 5, “MOTU Audio Setup” (page 35). The following sections provide a brief explanation of each 896mk3 setting for use with Digital Performer.

Sample rate

Choose the desired overall sample rate for the 896mk3 system and Digital Performer. Newly recorded audio in Digital Performer will have this sample rate. Imported audio or soundbites in existing files that do not match this sample rate will be displayed in the Soundbites window with a red 'X' on their move handles to indicate that they cannot be played.

Clock Source

This setting is very important because it determines which audio clock the 896mk3 will follow.

If you do not have any digital audio connections to your 896mk3 (you are using the analog inputs and outputs only), and you will not be slaving Digital Performer to external SMPTE time code, choose *Internal*.

If you have digital audio devices connected to the 896mk3, or if you are not sure about the clock source of your setup, be sure to read “Choosing a clock source for optical connections” on page 19 and “Clock Source” on page 37.

If you are slaving the 896mk3 and Digital Performer to SMPTE time code via the 896mk3 itself, choose *SMPTE* and follow the directions in “Syncing to SMPTE time code directly” on page 22.

Buffer Size

The *Buffer Size* setting can be used to reduce the delay — or *monitoring latency* — that you hear when live audio is patched through Digital Performer. For example, you might have MIDI instruments, samplers, microphones, and so on connected to the analog inputs of the 896mk3. If so, you will often be mixing their live input with audio material recorded in Digital Performer. See chapter 10, “Reducing Monitoring Latency” (page 69) for complete details.

Phones

This 896mk3 setting lets you choose what you'll hear from the headphone jack. For example, if you choose *Main Out 1-2*, the headphones will duplicate the main outs. Or you can choose any other output pair. If you choose *Phones 1-2*, this setting makes the headphone jack serve as its own independent output pair. As a result, you'll see *Phones 1-2* as an additional audio destination in Digital Performer's audio output menus. When operating at high sample rates, the phones must mirror one of the other output pairs.

Optical input and output

To make an 896mk3's optical inputs and/or outputs available in Digital Performer, choose *ADAT Optical* or *TOSLINK* from the optical input and/or output menus. If you won't be using the optical connectors, turn them off.

Main Outs Assign

Use the Main Outs Assign setting to determine what audio you will hear on the XLR main outs of the 896mk3. If you would like to treat them as their own separate output pair, choose *Main Outs*.

Return Assign

In Digital Performer's audio input menus and the Bundles window, you'll see an 896mk3 input called *Return 1-2* (Figure 7-2). This is a stereo feed from the 896mk3 that matches the output of one of its output pairs. Use the Return Assign menu in MOTU Audio Setup to choose which output pair you would like to hear on this return. This can be used, for example, to record back a final stereo mix that includes effects processing from the 896mk3 DSP (such as the Leveler) for reference and archiving purposes.

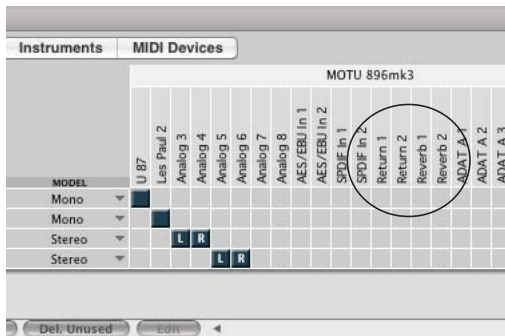

Figure 7-2: The stereo return and reverb return busses from the 896mk3 in Digital Performer's Bundles window.

Warning: the Return inputs can cause feedback loops! DO NOT assign this input to a track that shares the same 896mk3 output pair as the returns.

Reverb return

The 896mk3 also supplies a return to Digital Performer that carries the output of its reverb processor (Figure 7-2). This return can be used for any purpose you wish.

WORKING WITH 896MK3 INPUTS AND OUTPUTS

Once you've enabled the MOTU FireWire Audio driver as explained earlier in "The 896mk3 settings" on page 53, 896mk3 audio inputs and outputs will appear in Digital Performer's audio input and output menus, as well as the Bundles window (Figure 7-2). If you don't see the optical inputs and/or outputs, check MOTU Audio Setup to make sure they are turned on. If you don't plan to use either optical bank, turn them off to conserve computer bandwidth.

Trimming the analog inputs

The 896mk3 analog inputs provide trim knobs on the front panel. To calibrate an audio input:

- 1 Record-enable a track in Digital Performer.
- 2 Choose the desired 896mk3 input for the track.

3 Open the Audio Monitor window.

4 As you feed signal to the input, adjust the input's corresponding trim knob on the front panel of the 896mk3 until peaks in the level meter are as high as possible without clipping (hitting zero dB).

Phones 1-2

If you've chosen to treat the 896mk3 headphones as an independent output, you'll see *Phones 1-2* in Digital Performer's output menus. Audio tracks assigned to this output pair will be heard on the headphone jack only. For further explanation, see "Phones" on page 39.

24-BIT OPERATION

Your 896mk3 hardware fully supports Digital Performer's 24-bit recording capabilities, including both analog and digital 24-bit recording. If you would like to record and play back 24-bit audio files, go to the Audio Options in the Digital Performer Preferences (Digital Performer menu), and choose 24-bit recording as the sample format. This setting is saved with the Digital Performer project.

PROCESSING LIVE INPUTS WITH DP PLUG-INS

If you patch a live input (such as MIDI synthesizer) through a plug-in effect in Digital Performer, you might hear a slight delay. There are several ways to reduce this delay. For details, see chapter 10, "Reducing Monitoring Latency" (page 69).

WORKING WITH CUEMIX FX MIXING AND EFFECTS

The 896mk3 provides powerful external mixing, EQ, compression and reverb, which you can operate hand-in-hand with Digital Performer's complete mixing environment. For example, the 896mk3 can serve as a monitor mixer routing channels to musicians, or it can serve as an integrated extension of your Digital Performer mixing environment. If you program an 896mk3

mixing and processing configuration that goes hand in hand with your DP project, be sure to use the file save features in CueMix FX to save the 896mk3 settings as a file in your DP project folder for instant recall of all settings. See chapter 11, “CueMix Console” (page 75) for complete details. You can even set up your 896mk3 configuration file as a DP startup clipping so that it automatically loads when you open the project. See your DP manual for details.

SYNCHRONIZATION

As you read through the following sections to decide what form of synchronization you might need with other devices in your studio, be sure to consult “Making sync connections” on page 21 for the proper hardware connections. Use the synchronization diagrams to be clear about how you will be synchronizing Digital Performer and the 896mk3 to the other components of your system.

Synchronizing digital audio connections

If you have devices connected to the 896mk3 digital inputs (optical or RCA S/PDIF), you need to be concerned with the synchronization of the 896mk3’s digital audio clock with other devices connected to it digitally (if any). For example, if you have a digital mixer connected to the 896mk3 via an ADAT optical light pipe cable, you need to make sure that their audio clocks are phase-locked. For details, see “Choosing a clock source for optical connections” on page 19 and “Making sync connections” on page 21. If you don’t have any digital audio devices connected to the 896mk3, digital audio phase-lock does not apply to you.

Resolving directly to time code (with no synchronizer)

If you need to slave Digital Performer and the 896mk3 to SMPTE time code, you can do so with or without a dedicated synchronizer.

To resolve your 896mk3 directly to SMPTE time code with no additional synchronization devices, use the setup shown in “Syncing to SMPTE time code directly” on page 22.

Resolving to video and/or time code with a dedicated synchronizer

To resolve your 896mk3 to video and/or SMPTE time code using an additional synchronization device, use the setup shown in “Syncing to video and/or SMPTE time code using a synchronizer” on page 23.

USING A FOOT SWITCH

Use a foot switch connected to the 896mk3 to trigger recording punch-in and punch-out, or any other feature in Digital Performer that is assigned to a computer keystroke. By default, the foot switch triggers the 3 key on the computer keypad (which toggles Digital Performer’s record button.) To trigger a different set of keystrokes with the foot switch, visit the MOTU Audio Setup. (See “Enable Pedal” on page 41.)

EXCHANGING PROJECTS WITH AUDIODESK

Digital Performer can exchange projects with AudioDesk. To open an AudioDesk project in Digital Performer, open it in same way you would a DP project. To export a project to AudioDesk, use DP’s Save As command and choose the AudioDesk 2.0 file format.

CHAPTER 8 AudioDesk

OVERVIEW

This chapter provides a brief overview of AudioDesk's basic I/O and synchronization operation with the 896mk3 hardware. For complete information about all of AudioDesk's powerful workstation features, see the AudioDesk manual included with your 896mk3 system.

Setting up your system	57
The 896mk3 settings	57
Working with 896mk3 inputs and outputs	59
24-bit operation	59
Processing live inputs through AudioDesk plug-ins ..	59
Working with CueMix FX mixing and effects.....	59
Synchronization	60
Using a foot switch	60
Exchanging projects with Digital performer	60
AudioDesk and MIDI sequencing	60

SETTING UP YOUR SYSTEM

As described in chapter 4, “Installing the 896mk3 Mac Software” (page 33), the AudioDesk and MOTU 896mk3 software installers will properly install and update everything for you.

If you are using a MIDI Timepiece AV or Digital Timepiece for synchronization, be sure they are present in Audio MIDI setup.

THE 896MK3 SETTINGS

Choose the 896mk3 as your audio input output device by choosing *MOTU Audio System options>Configure Hardware Driver* from the Setup menu. This window shows some of the 896mk3 settings, such as sample rate and clock source, but to access all of the 896mk3 settings, open MOTU Audio Setup, as shown in Figure 5-1 on page 36.

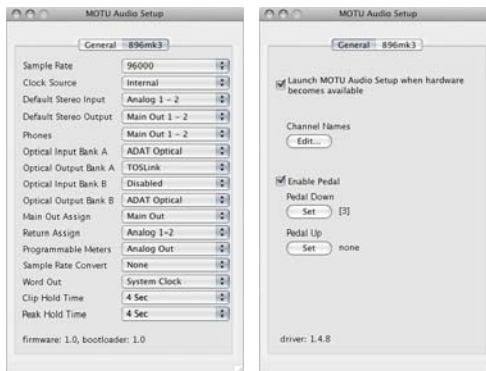
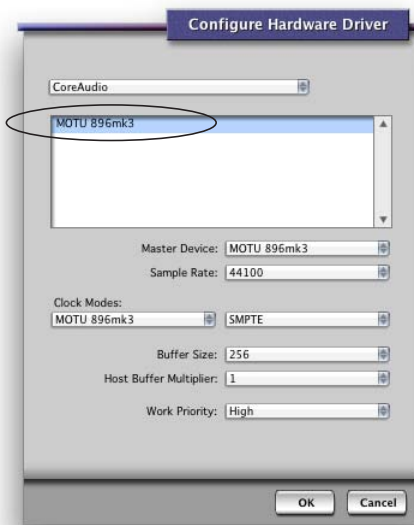

Figure 8-1: Choose Setup menu> Configure Audio System> Configure Hardware Driver to open the dialog shown above and access the 896mk3 CoreAudio driver. To access the rest of the 896mk3 settings, open MOTU Audio Setup.

For complete details about the 896mk3 settings, see chapter 5, “MOTU Audio Setup” (page 35). The following sections provide a brief explanation of each 896mk3 setting for use with AudioDesk.

Sample rate

Choose the desired overall sample rate for the 896mk3 system and AudioDesk. Newly recorded audio in AudioDesk will have this sample rate. Imported audio or soundbites in existing files that do not match this sample rate will be displayed in the Soundbites window with a red 'X' on their move handles to indicate that they cannot be played.

Clock Source

This setting is very important because it determines which audio clock the 896mk3 will follow.

If you do not have any digital audio connections to your 896mk3 (you are using the analog inputs and outputs only), and you will not be slaving AudioDesk to external SMPTE time code, choose *Internal*.

If you have digital audio devices connected to the MOTU 828, or if you are not sure about the clock source of your setup, be sure to read “Making sync connections” on page 21 and “Clock Source” on page 37.

If you are slaving the 896mk3 and AudioDesk to SMPTE time code via the 896mk3 itself, choose *SMPTE* and follow the directions in “Syncing to SMPTE time code directly” on page 22.

Buffer Size

The *Buffer Size* setting can be used to reduce the delay — or *monitoring latency* — that you hear when live audio is patched through your 896mk3 hardware and AudioDesk. For example, you might have MIDI instruments, samplers, microphones, and so on connected to the analog inputs of the 896mk3. If so, you will often be mixing their live input with audio material recorded in AudioDesk. See chapter 10, “Reducing Monitoring Latency” (page 69) for complete details.

Phones

This 896mk3 setting lets you choose what you'll hear from the headphone jack. For example, if you choose *Main Out 1-2*, the headphones will duplicate the main outs. Or you can choose any other output pair. If you choose *Phones 1-2*, this setting makes the headphone jack serve as its own independent output pair. As a result, you'll see *Phones 1-2* as an additional audio destination in AudioDesk's audio output menus. Note that when operating at high sample rates, the phones must mirror one of the other output pairs.

Optical input and output

To make an 896mk3's optical inputs and/or outputs available in AudioDesk, choose *ADAT Optical* or *TOSLINK* from the optical input and/or output menus. If you won't be using the optical connectors, turn them off. Note: these settings can only be accessed in the MOTU Audio Setup application. For details, see “Optical input/output” on page 39.

Main Outs Assign

Use the Main Outs Assign setting to determine what audio you will hear on the XLR main outs of the 896mk3. If you would like to treat them as their own separate output pair, choose *Main Outs*.

Return Assign

In AudioDesk's audio input menus and the Bundles window, you'll see an 896mk3 input called *Return 1-2* (Figure 8-2). This is a stereo feed from the 896mk3 that matches the output of one of its output pairs. Use the Return Assign menu in MOTU Audio Setup to choose which output pair you would like to hear on this return. This can be used, for example, to record back a final stereo mix that includes effects processing from the 896mk3 DSP (such as the Leveler) for reference and archiving purposes.

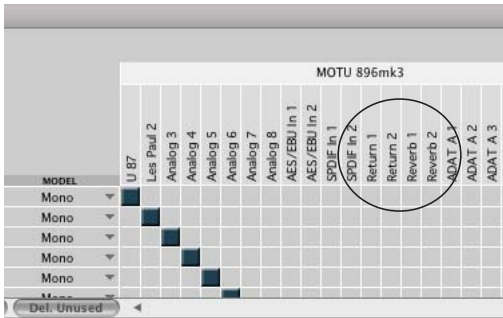

Figure 8-2: The stereo return and reverb return busses from the 896mk3 in AudioDesk's Bundles window.

Warning: the Return inputs can cause feedback loops! DO NOT assign this input to a track that shares the same 896mk3 output pair as the returns.

Reverb return

The 896mk3 also supplies a return to AudioDesk that carries the output of its reverb processor (Figure 8-2). This return can be used for any purpose you wish.

WORKING WITH 896MK3 INPUTS AND OUTPUTS

Once you've enabled the MOTU FireWire Audio driver as explained earlier in "The 896mk3 settings" on page 57, 896mk3 audio inputs and outputs will appear in AudioDesk's audio input and output menus. If you don't see the optical inputs and/or outputs, check the MOTU Audio Setup to make sure they are turned on and set to the format you require. If you don't plan to use either optical bank, turn it off to conserve computer bandwidth.

Trimming the analog inputs

The 896mk3 analog inputs provide trim knobs on the front panel. To calibrate an audio input:

- 1 Record-enable a track in AudioDesk.
- 2 Choose the desired 896mk3 input for the track.
- 3 Open the Audio Monitor window.

4 As you feed signal to the input, adjust the input's corresponding trim knob on the front panel of the 896mk3 until peaks in the level meter are as high as possible without clipping (hitting zero dB).

Phones 1-2

If you've chosen to treat the 896mk3 headphones as an independent output, you'll see *Phones 1-2* in AudioDesk's output menus. Audio tracks assigned to this output pair will be heard on the headphone jack only. For further explanation, see "Phones" on page 58.

24-BIT OPERATION

Your 896mk3 hardware fully supports AudioDesk's 24-bit recording capabilities, including both analog and digital 24-bit recording. If you would like to record and play back 24-bit audio files, go to the Audio Options in the AudioDesk Preferences (AudioDesk menu), and choose 24-bit recording as the sample format for the project. This setting is saved with the AudioDesk project.

PROCESSING LIVE INPUTS THROUGH AUDIODESK PLUG-INS

If you patch a live input (such as MIDI synthesizer) through a plug-in effect in AudioDesk, you might hear a slight delay. There are several ways to reduce this delay. For details, see chapter 10, "Reducing Monitoring Latency" (page 69).

WORKING WITH CUEMIX FX MIXING AND EFFECTS

The 896mk3 provides powerful external mixing, EQ, compression and reverb, which you can operate hand-in-hand with AudioDesk's complete mixing environment. For example, the 896mk3 can serve as a monitor mixer routing channels to musicians, or it can serve as an integrated extension of your AudioDesk mixing environment. If you program an 896mk3 mixing and processing configuration that goes hand in hand with your AudioDesk project, be sure to use the file save features in CueMix FX to save the 896mk3 settings

as a file in your AudioDesk project folder for instant recall of all settings. See chapter 11, “CueMix Console” (page 75) for complete details.

SYNCHRONIZATION

As you read through the following sections to decide what form of synchronization you might need with other devices in your studio, be sure to consult “Making sync connections” on page 21 for the proper hardware connections. Use the synchronization diagrams to be clear about how you will be synchronizing AudioDesk and the 896mk3 to the other components of your system.

Synchronizing digital audio connections

If you have devices connected to the 896mk3 digital inputs (optical or RCA S/PDIF), you need to be concerned with the synchronization of the 896mk3’s digital audio clock with other devices connected to it digitally (if any). For example, if you have a digital mixer connected to the 896mk3 via an ADAT optical light pipe cable, you need to make sure that their audio clocks are phase-locked. For details, see “Choosing a clock source for optical connections” on page 19 and “Making sync connections” on page 21. If you don’t have any digital audio devices connected to the 896mk3, digital audio phase-lock does not apply to you.

Resolving directly to time code (with no synchronizer)

If you need to slave AudioDesk and the 896mk3 to SMPTE time code, you can do so with or without a dedicated synchronizer.

To resolve your 896mk3 directly to SMPTE time code with no additional synchronization devices, use the setup shown in “Syncing to SMPTE time code directly” on page 22.

Resolving to video and/or time code with a dedicated synchronizer

To resolve your 896mk3 to video and/or SMPTE time code using an additional synchronization device, use the setup shown in “Syncing to video and/or SMPTE time code using a synchronizer” on page 23.

USING A FOOT SWITCH

Use a foot switch connected to the 896mk3 to trigger recording punch-in and punch-out, or any other feature in AudioDesk that is assigned to a computer keystroke. By default, the foot switch triggers the 3 key on the computer keypad (which toggles AudioDesk’s record button.) To trigger a different set of keystrokes with the foot switch, visit the MOTU Audio Setup. (See “Enable Pedal” on page 41.)

EXCHANGING PROJECTS WITH DIGITAL PERFORMER

To open AudioDesk Version 2 (or Version 1) files in Digital Performer, just use DP’s Open command. (No conversion is required beforehand in AudioDesk.) To export a Digital Performer project to AudioDesk, use Save As in Digital Performer’s File menu and choose the *AudioDesk 2.0* file format. Then open the resulting AudioDesk 2.0 document in AudioDesk.

AUDIODESK AND MIDI SEQUENCING

AudioDesk can play audio as a background application, allowing you to run a sequencer at the same time in the foreground. However, there is no way to continuously synchronize — or *resolve* — a sequencer with AudioDesk, so the two programs will eventually drift out of sync, even if you manage to start them at the same time. If you’d like to do integrated MIDI sequencing, your best bet is Digital Performer, which offers pretty much all of the same features as AudioDesk, along with powerful, state-of-the-art MIDI sequencing. Talk to your authorized MOTU dealer for details about upgrading from AudioDesk to Digital Performer.

CHAPTER 9 Other Mac OS X Audio Software

OVERVIEW

The 896mk3 provides multichannel audio and MIDI input and output for all Mac OS X audio applications, including Apple’s Logic Pro, Logic Express, SoundTrack Pro and GarageBand. Other third-party software applications are also supported, such as Ableton Live, Propellerhead Reason, Steinberg Cubase and others.

Installing the 896mk3 Mac OS X drivers	61
Preparing MIDI input and output	61
Run MOTU Audio Setup	61
Choosing the MOTU FireWire Core Audio driver	62
Working with 896mk3 inputs and outputs	64
Audio Input and output names	64
Number of channels	66
Processing live inputs with host plug-ins	66
Working with CueMix FX mixing and effects.....	66
Synchronization	66
Using a foot switch	67

INSTALLING THE 896MK3 MAC OS X DRIVERS

To install the 896mk3’s Mac OS X audio and MIDI drivers, just run the installer on the MOTU Audio installer CD as detailed in chapter 4, “Installing the 896mk3 Mac Software” (page 33).

PREPARING MIDI INPUT AND OUTPUT

If you will be using the 896mk3’s MIDI input and output ports, be sure to follow the procedure in “Preparing MIDI input and output” on page 61.

RUN MOTU AUDIO SETUP

Before you run your host audio software, launch MOTU Audio Setup to configure your 896mk3 hardware. MOTU Audio Setup lets you configure your audio interface, and it lets you enable the desired inputs and outputs. Only enabled inputs

and outputs will be available to your software, so this is an important step. For complete details see chapter 5, “MOTU Audio Setup” (page 35).

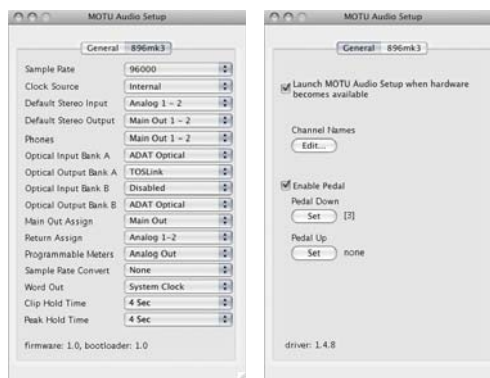

Figure 9-1: MOTU Audio Setup.

For complete details about the 896mk3 settings, see chapter 5, “MOTU Audio Setup” (page 35). The following sections provide a brief explanation of each 896mk3 setting for use with Logic and other Mac OS X audio software.

Sample rate

Choose the desired overall sample rate for the 896mk3 system and your host audio software. Newly recorded audio will have this sample rate.

Clock Source

This setting is very important because it determines which audio clock the 896mk3 will follow.

If you do not have any digital audio connections to your 896mk3 (you are using the analog inputs and outputs only), and you will not be slaving your host software to external SMPTE time code, choose *Internal*.

If you have digital audio devices connected to the 896mk3, or if you are not sure about the clock source of your setup, be sure to read “Making sync connections” on page 21 and “Clock Source” on page 37.

If you are slaving the 896mk3 and your host software to SMPTE time code, follow the directions in “Syncing to video and/or SMPTE time code using a synchronizer” on page 23.

Phones

This 896mk3 setting lets you choose what you’ll hear from the headphone jack. For example, if you choose *Main Out 1-2*, the headphones will duplicate the main outs. Or you can choose any other output pair. If you choose *Phones 1-2*, this setting makes the headphone jack serve as its own independent output pair. As a result, you’ll see *Phones 1-2* as an additional audio destination in your host’s audio output menus. When operating at high sample rates, the phones must mirror one of the other output pairs.

Optical input and output

To make a 896mk3 optical input or output available in your host software, choose the appropriate format (*ADAT optical* or *TOSLINK*) from the optical input and/or output menu. If you won’t be using the optical connectors, turn them off.

Main Outs Assign

Use the Main Outs Assign setting to determine what audio you will hear on the XLR main outs of the 896mk3. If you would like to treat them as their own separate output pair, choose *Main Outs*.

Return Assign

In your OS X host audio software audio input menus, you’ll see an 896mk3 input called *Return 1-2*. This is a stereo feed from the 896mk3 that matches the signal of one of its output pairs. Use the Return Assign menu in MOTU Audio Setup to choose which output pair you would like to hear on

this return. This can be used, for example, to record back a final stereo mix that includes effects processing from the 896mk3 DSP (such as the Leveler) for reference and archiving purposes.

 **Warning:** the Return inputs can cause feedback loops! DO NOT assign this input to a track that shares the same 896mk3 output pair as the returns.

Reverb return

The 896mk3 also supplies a return to your host software that carries the output of its reverb processor. This return can be used for any purpose you wish.

CHOOSING THE MOTU FIREWIRE CORE AUDIO DRIVER

Once you’ve made the preparations described so far in this chapter, you’re ready to run your audio software and enable the MOTU 896mk3 Core Audio driver. Check the audio system or audio hardware configuration window in your software. There will be a menu there that lets you choose among various drivers that may be in your system. Choose the MOTU 896mk3 from this menu.

Logic Pro and Logic Express

In Logic Pro and Logic Express, go to the Preferences window, click the *Audio* tab, click the *Drivers* tab and click the *Core Audio* tab as shown in Figure 9-2. Choose the *MOTU 896mk3* from the Driver menu. For information about the *I/O Buffer Size* setting, see “Adjusting the audio I/O buffer” on page 71.

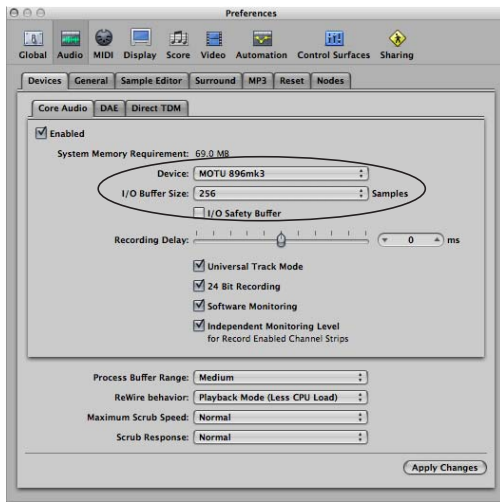

Figure 9-2: Enabling the 896mk3 in Logic Pro or Logic Express.

Soundtrack Pro

In Soundtrack Pro, access the preferences window, click the Recording tab and choose *MOTU 896mk3* from the *Input* and *Monitor* menu as shown below in Figure 9-3.

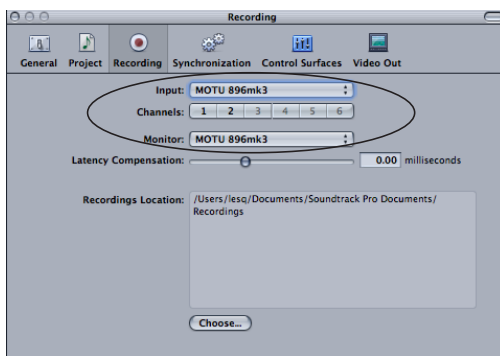

Figure 9-3: Enabling the 896mk3 in Soundtrack Pro.

Garage Band

In Garage Band, go to the *Audio/MIDI* preferences and choose *MOTU 896mk3* from the *Audio Output* and *Audio Input* menus as shown below in

Figure 9-4. For information about the *Optimize for* setting, see “Adjusting the audio I/O buffer” on page 71.

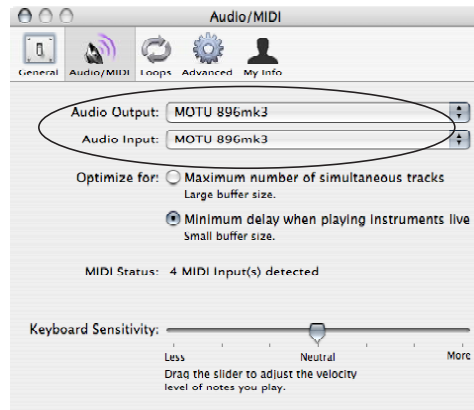

Figure 9-4: Enabling the 896mk3 in Garage Band.

Live

In Ableton Live, access the preferences window and click the *Audio* tab. Choose *CoreAudio* from the *Driver Type* menu. Choose the *MOTU 896mk3* from the *Input Audio Device* and *Output Audio Device* menus as shown below in Figure 9-5. For information about the *Buffer Size* setting, see “Adjusting the audio I/O buffer” on page 71.

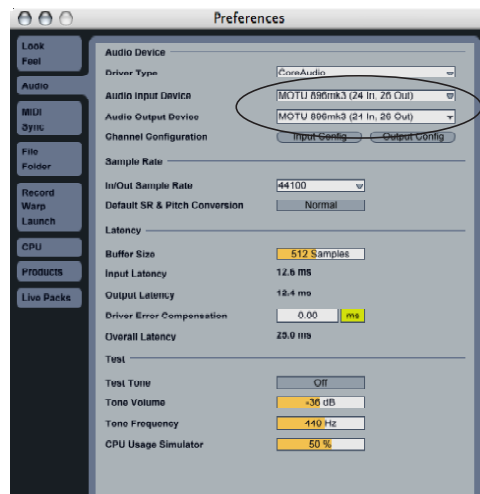

Figure 9-5: Enabling the 896mk3 in Live.

Reason

In Propellerhead Reason, go to the Preferences window, choose *Audio* preferences from the menu and choose *MOTU 896mk3* from the *Audio Output* menu as shown below in Figure 9-6. For information about the *Buffer Size* setting, see “Adjusting the audio I/O buffer” on page 71.

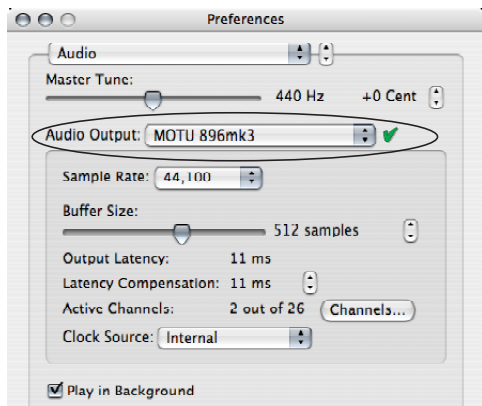

Figure 9-6: Enabling the 896mk3 in Reason.

Cubase and Nuendo

Go to the Devices menu and choose *Device Setup*. Click the *VST Audio System* item in the Devices list and choose *MOTU 896mk3* from the *Master ASIO Driver* menu as shown below in Figure 9-7. Activate the inputs and outputs within Cubase or Nuendo as usual. For information about the *Audio Buffer Size* setting, see “Adjusting the audio I/O buffer” on page 71.

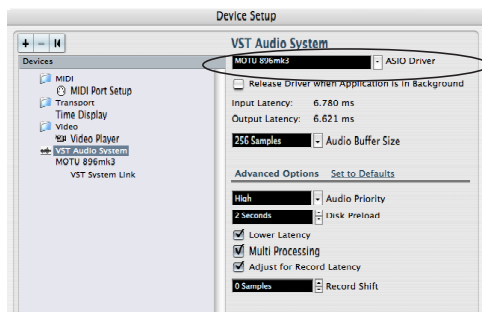

Figure 9-7: Enabling the 896mk3 audio driver in Cubase.

Other audio software

For other audio applications, the procedure is similar to that shown above. Consult your owner’s manual for further information.

WORKING WITH 896MK3 INPUTS AND OUTPUTS

Once you’ve enabled the 896mk3’s Core Audio driver, 896mk3 audio inputs and outputs will appear in your host software wherever audio inputs and outputs are listed. If you don’t see the optical inputs and/or outputs, check MOTU Audio Setup to make sure they are turned on. If you don’t plan to use either optical bank, turn it off to conserve computer bandwidth.

AUDIO INPUT AND OUTPUT NAMES

The 896mk3 Core Audio driver supplies text string labels for its inputs and outputs to clearly identify each one, but some applications do not display these labels. For example, in Cubase, the 896mk3 outputs are numbered like this:

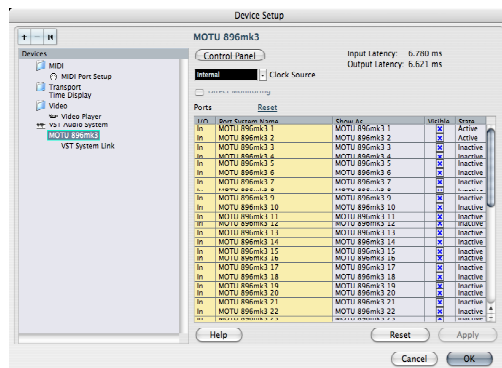

Figure 9-8: Some applications number the 896mk3 inputs and outputs, but don’t display which outputs they refer to.

The following sections show how you can identify each input and output in a numbered list like this.

Inputs at 1x sample rates

Inputs are always listed in the same order as follows, when operating the 896mk3 at 1x sample rates (44.1 or 48 kHz):

Input 44.1/48 kHz	Channels	List position	Comment
Analog	8	1-8	-
AES/EBU	2	9-10	-
SPDIF	2	11-12	-
Stereo return	2	13-14	See “Return Assign” on page 62.
Reverb return	2	15-16	See “Reverb return” on page 62.
Optical A	8 ADAT 2 TOSLINK	17-24 17-18	-
Optical B	8 ADAT 2 TOSLINK	25-32 19-20	These starting channel numbers assume that optical A is operating with the same format.

Inputs at 2x sample rates

When operating the 896mk3 at a 2x sample rate (88.2 or 96 kHz), inputs are listed as follows:

Input 88.2/96 kHz	Channels	List position	Comment
Analog	8	1-8	-
AES/EBU	2	9-10	-
SPDIF	2	11-12	-
Stereo return	2	13-14	See “Return Assign” on page 62.
Reverb return	not available	not available	not available
Optical A	4 ADAT 2 TOSLINK	15-18 15-16	-
Optical B	4 ADAT 2 TOSLINK	19-22 17-18	These starting channel numbers assume that optical A is operating with the same format.

Inputs at 4x sample rates

When operating the 896mk3 at a 4x sample rate (176.4 or 192 kHz), inputs are listed as follows:

Input 176.4/192 kHz	Channels	List position	Comment
Analog	8	1-8	-
Stereo return	2	9-10	See “Return Assign” on page 62.
Reverb return	not available	not available	not available
SPDIF	not available	not available	not available
AES/EBU	not available	not available	not available
Optical A	not available	not available	not available
Optical B	not available	not available	not available

Outputs at 1x sample rates

Outputs are always listed in the same order as follows, when operating the 896mk3 at 1x sample rates (44.1 or 48 kHz):

Output 44.1/48 kHz	Channels	List position	Comment
Main outs	2	1-2	-
Analog	8	3-10	-
AES/EBU	2	11-12	-
SPDIF	2	13-14	-
Phones	2	15-16	-
Optical A	8 ADAT 2 TOSLINK	17-24 17-18	-
Optical B	8 ADAT 2 TOSLINK	25-32 19-20	These channel number ranges assume that optical A is operating with the same format.

Outputs at 2x sample rates

When operating the 896mk3 at a 2x sample rate (88.2 or 96 kHz), outputs are listed as follows:

Output 88.2/ 96 kHz	Channels	List position	Comment
Main outs	2	1-2	-
Analog	8	3-10	-
AES/EBU	2	11-12	-
SPDIF	2	13-14	-
Phones	Mirror only	--	-
Optical A	4 ADAT 2 TOSLINK	15-18 15-16	-
Optical B	4 ADAT 2 TOSLINK	19-22 17-18	These channel number ranges assume that optical A is operating with the same format.

Outputs at 4x sample rates

When operating the 896mk3 at a 4x sample rate (176.4 or 192 kHz), outputs are listed as follows:

Output 176.4/ 192 kHz	Channels	List position	Comment
Main outs	2	1-2	-
Analog	8	3-10	-
Phones	Mirror only	--	-
SPDIF	Not available	--	-
AES/EBU	Not available	--	-
Optical A	Not available	--	-
Optical B	Not available	--	-

NUMBER OF CHANNELS

If your host audio software requires that you specify the number of audio voices or channels you will be using, be sure to choose enough channels to cover the 28 inputs and 32 outputs provided by your 896mk3 — although the number of channels may depend on how your 896mk3 is configured.

PROCESSING LIVE INPUTS WITH HOST PLUG-INS

If you patch a live input (such as a MIDI synthesizer) through a plug-in effect in your host software, you might hear a slight delay. There are several ways to reduce this delay. For details, see chapter 10, “Reducing Monitoring Latency” (page 69).

WORKING WITH CUEMIX FX MIXING AND EFFECTS

The 896mk3 provides powerful external mixing, EQ, compression and reverb, which you can operate hand-in-hand with your host’s mixing environment. For example, the 896mk3 can serve as a monitor mixer routing channels to musicians, or it can serve as an integrated extension of your host’s mixing environment. If you program an 896mk3 mixing and processing configuration that goes hand in hand with your host project, be sure to use the file save features in CueMix FX to save the 896mk3 settings as a file in your host project folder for instant recall of all settings. See chapter 11, “CueMix Console” (page 75) for complete details.

SYNCHRONIZATION

As you read through the following sections to decide what form of synchronization you might need with other devices in your studio, be sure to consult “Making sync connections” on page 21 for the proper hardware connections. Use the synchronization diagrams to be clear about how you will be synchronizing your audio software and the 896mk3 to the other components of your system.

Synchronizing digital audio connections

If you have devices connected to the 896mk3 digital inputs (optical or RCA S/PDIF), you need to be concerned with the synchronization of the 896mk3’s digital audio clock with other devices connected to it digitally (if any). For example, if you have a digital mixer connected to the 896mk3

via an ADAT optical light pipe cable, you need to make sure that their audio clocks are phase-locked. For details, see “Choosing a clock source for optical connections” on page 19 and “Making sync connections” on page 21. If you don’t have any digital audio devices connected to the 896mk3, digital audio phase-lock does not apply to you.

Resolving directly to time code (with no synchronizer)

If your host audio software supports Core Audio’s sample-accurate positioning protocol, then it can resolve to the 896mk3’s built-in time code synchronization feature. To resolve your 896mk3 directly to SMPTE time code with no additional synchronization devices, use the setup shown in “Syncing to SMPTE time code directly” on page 22.

Resolving to video and/or time code with a dedicated synchronizer

If your host software has the ability to synchronize to SMPTE time code but does not support Core Audio’s sample-accurate positioning protocol, you can slave your host software and the 896mk3 to video and/or SMPTE time code using a dedicated synchronization device. To do so, use the setup shown in “Syncing to video and/or SMPTE time code using a synchronizer” on page 23.

USING A FOOT SWITCH

Use a foot switch connected to the 896mk3 to trigger recording punch-in and punch-out, or any other feature in your host audio software that is assigned to a computer keystroke. By default, the foot switch triggers the 3 key on the computer keypad. To trigger a different set of keystrokes with the foot switch, visit MOTU Audio Setup. (See “Enable Pedal” on page 41.)

CHAPTER 10 Reducing Monitoring Latency

OVERVIEW

Monitoring latency is that slight delay you hear when you run an input signal through your host audio software. For example, you might hear it when you drive a live guitar input signal through an amp modeling plug-in running in your audio sequencer.

This delay is caused by the amount of time it takes for audio to make the entire round trip through your computer, from when it first enters an 896mk3 input, passes through the 896mk3 hardware into the computer, through your host audio software, and then back out to an 896mk3 output.

If you don't need to process a live input with plug-ins, the easiest way to avoid monitoring latency is to use the 896mk3's CueMix FX digital mixer to patch the input directly to your monitor outs via the 896mk3 audio hardware. The 896mk3 even provides effects processing (EQ, compression and reverb), which can be applied on input, output, or even at the bussing stage, just like a conventional mixer. For details, see "CueMix FX hardware monitoring" on page 73.

If you *do* need to process a live input with host software plug-ins, or if you are playing virtual instruments live through your 896mk3 audio hardware, you can significantly reduce latency — and even make it completely inaudible, regardless of what host audio application software you use. This chapter explains how.

It is important to note that monitoring delay has no effect on when audio data is recorded to disk or played back from disk. Actual recording and playback is extremely precise.

Monitoring live input.....	70
Adjusting the audio I/O buffer	71
Lower latency versus higher CPU overhead	72
Transport responsiveness	73
Effects processing and automated mixing	73
CueMix FX hardware monitoring.....	73
Two methods for controlling CueMix FX	73
Using CueMix FX	73
Controlling CueMix FX from your audio software	74

MONITORING LIVE INPUT

There are two ways to monitor live audio input with an 896mk3: 1) through the computer or 2) via the 82mk3 CueMix FX hardware mixer.

Figure 10-1 shows method 1, which allows you to apply host-based effects processing via plug-ins in your audio software. See the next section, “Adjusting the audio I/O buffer” for details about how to reduce — and possibly eliminate — the audible monitoring delay that the computer introduces.

Figure 10-2 shows how to use CueMix FX hardware-based monitoring, which lets you hear what you are recording with no monitoring delay and no computer-based effects processing. Instead, input is routed directly to an output, either with or without 896mk3-based effects processing (EQ, compression or reverb). See “CueMix FX hardware monitoring” later in this chapter for details on how to use CueMix FX with your audio software, or with the included CueMix FX software.



Figure 10-1: There are two ways to monitor live audio inputs with an 896mk3: 1) through the computer or 2) via CueMix FX hardware monitoring. This diagram shows method 1 (through the computer). When using this method, use your host software's buffer setting to reduce the slight delay you hear when monitoring the live input, but don't lower it too much, or your computer might get sluggish.

If the material you are recording is suitable, there is a third way to monitor live input: use both methods (Figure 10-1 and Figure 10-2) at the same time. For example, you could route guitar to both the computer (for an amp model effect) and mix that processed signal on the main outs with dry guitar from CueMix FX — or perhaps with a touch of 896mk3 Classic Reverb.

ADJUSTING THE AUDIO I/O BUFFER

A *buffer* is a small amount of computer memory used to hold data. For audio interfaces like the 896mk3, buffers are used for the process of transferring audio data in and out of the computer. The size of the buffers determines how much delay you hear when monitoring live inputs through your audio software: larger buffers produce more delay; smaller buffers produce less.

Under Mac OS X, audio I/O buffer size is handled by the host audio application (not the 896mk3 Core Audio driver). Most audio software applications provide an adjustable audio buffer setting that lets you control the amount of delay you'll hear when monitoring live inputs or processing them with software plug-ins. Below are a few examples.

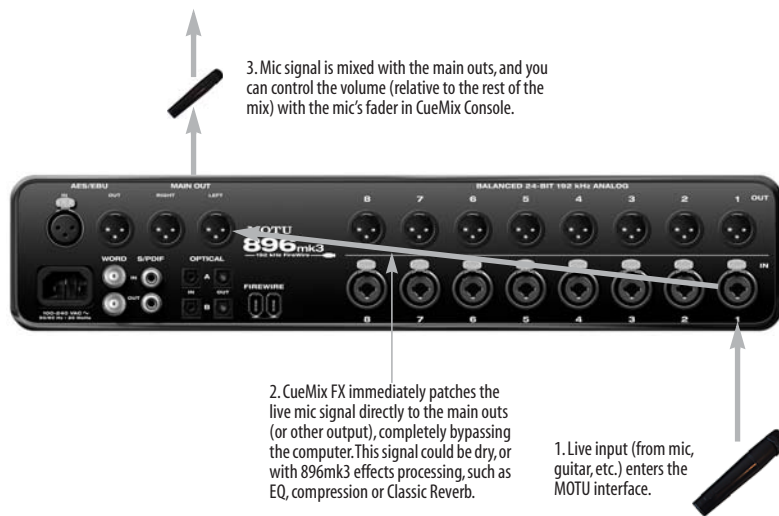

Figure 10-2: This diagram shows the signal flow when using CueMix FX no-latency monitoring. Notice that this method does not process the live input with plug-ins in your audio software. Instead, you can apply 896mk3 effects, such as the reverb, EQ and/or compression.

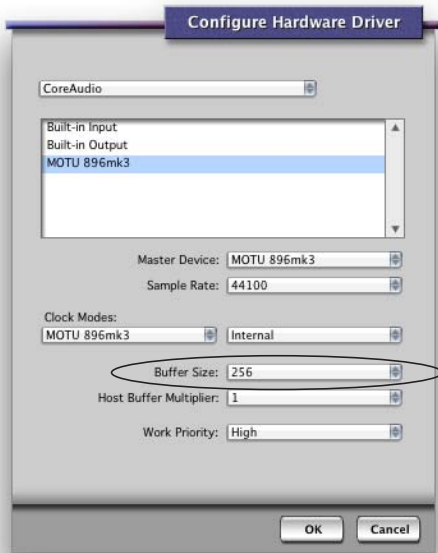

Figure 10-3: In Digital Performer and AudioDesk, choose Setup menu > Configure Audio System > Configure Hardware Driver to open the dialog shown above and access the Buffer Size setting. Refer to your Digital Performer or AudioDesk manual for information about the Host Buffer Multiplier setting.

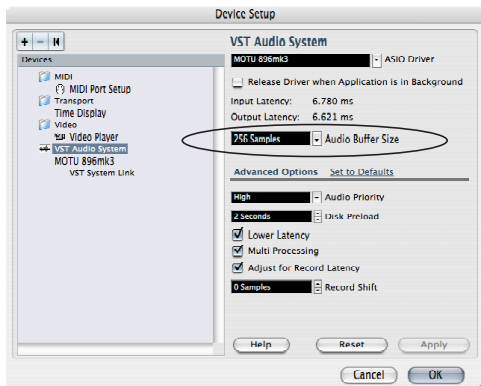

Figure 10-4: In Cubase or Nuendo, choose Devices menu > Device Setup and click VST Audio System to access the window above and the Audio Buffer Size setting.

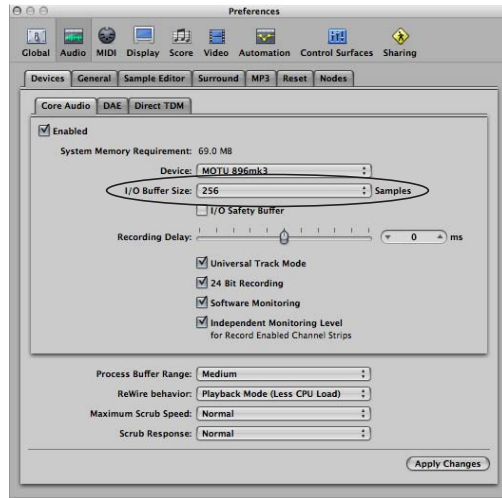

Figure 10-5: In Logic Pro or Logic Express, go to the Audio Driver preferences to access the Buffer Size option shown above.

Lower latency versus higher CPU overhead

The buffer setting has a large impact on the following things:

- Patch thru latency
- The load on your computer's CPU
- Possible distortion at the smallest settings
- How responsive the transport controls are in AudioDesk, Digital Performer or other audio software

The buffer setting presents you with a trade-off between the processing power of your computer and the delay of live audio as it is being patched through your software. If you reduce the size, you reduce patch thru latency, but significantly increase the overall processing load on your computer, leaving less CPU bandwidth for things like real-time effects processing. On the other hand, if you increase the buffer size, you reduce the load on your computer, freeing up bandwidth for effects, mixing and other real-time operations.

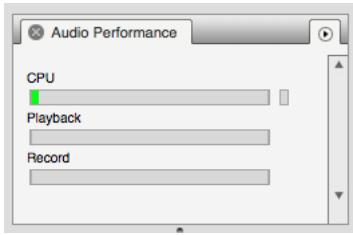

Figure 10-6: When adjusting the buffer size to reduce monitoring latency, watch the 'processor' meter in Digital Performer or AudioDesk's Performance Monitor. If you hear distortion, or if the Performance meter is peaking, try raising the buffer size.

If you are at a point in your recording project where you are not currently working with live, patched-thru material (e.g. you're not recording vocals), or if you have a way of externally processing inputs, choose a higher buffer size. Depending on your computer's CPU speed, you might find that settings in the middle work best (256 to 1024).

Transport responsiveness

Buffer size also impacts how quickly your audio software will respond when you begin playback, although not by amounts that are very noticeable. Lowering the buffer size will make your software respond faster; raising the buffer size will make it a little bit slower, but barely enough to notice.

Effects processing and automated mixing

Reducing latency with the buffer size setting has another benefit: it lets you route live inputs through the real-time effects processing and mix automation of your audio software.

CUEMIX FX HARDWARE MONITORING

The 896mk3 has a more direct method of patching audio through the system. This method employs the 896mk3's *CueMix FX* digital mixer. When enabled, CueMix activates hardware patch-thru in the 896mk3 itself. CueMix FX has two important benefits:

- First, it completely eliminates the patch thru delay (reducing it to a small number of samples — about the same amount as one of today's digital mixers).
- Secondly, CueMix FX imposes no strain on the computer.

The trade-off, however, is that CueMix FX bypasses your host audio software. Instead, live audio inputs are patched directly through to outputs in the 896mk3 itself and are mixed with disk tracks playing back from your audio software. This means that you cannot apply host-based plug-ins, mix automation, or other real-time effects that your audio software provides. But for inputs that don't need these types of features, CueMix FX is the way to go.

On the other hand, if you really need to use the mixing and processing provided by your audio software, you should not use CueMix FX. Instead, reduce latency with the buffer setting (as explained earlier in this chapter).

TWO METHODS FOR CONTROLLING CUEMIX FX

There are two ways to control CueMix FX:

- With CueMix FX
- From within your host audio software (if it supports direct hardware monitoring)

You can even use both methods simultaneously.

Using CueMix FX

If your host audio software does not support direct hardware monitoring, you run the CueMix FX software side-by-side with your audio software and manage your monitor mix in CueMix FX.

CueMix FX allows you to create up to eight separate 896mk3 stereo mixes, or any other desired routing configurations. These routings are

independent of your host audio software. For complete details, see chapter 11, “CueMix Console” (page 75).

Controlling CueMix FX from your audio software

Some audio applications allow you to control CueMix FX monitoring from within the application (without the need to use CueMix FX). In most cases, this support consists of patching an 896mk3 input directly to an output when you record-arm a track. Exactly how this is handled depends on the application.

The following applications are among those that support direct control over CueMix FX:

- Digital Performer
- AudioDesk

CueMix FX routings that are made via host applications are made “under the hood”, which means that you won’t see them in CueMix FX. However, CueMix FX connections made inside your host audio software dovetail with any other mixes you’ve set up in CueMix FX. For example, if your host application routes audio to an output pair that is already being used in CueMix FX for an entirely separate mix bus, both audio streams will simply be merged to the output.

Controlling CueMix FX from within AudioDesk or Digital Performer

To turn on CueMix FX in AudioDesk and Digital Performer:

- 1 From the Setup menu, choose *Configure Audio System* > *Input Monitoring Mode*.
- 2 Choose the *Direct hardware playthrough* option, as shown below in Figure 10-7.
- 3 From the Studio menu, choose *Audio Patch Thru*, and choose any monitoring mode except *Off*.

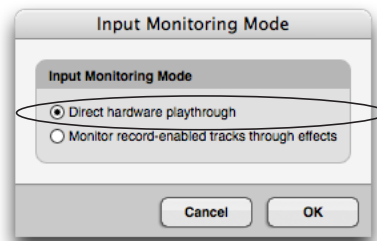

Figure 10-7: Enabling CueMix FX in AudioDesk or Digital Performer. Note: the ‘Only during recording...’ and ‘Always’ options are for AudioDesk 2 and DP4 only. Later versions of DP have expanded input monitoring features. Consult your documentation.

Once enabled, CueMix FX monitoring is tied with Digital Performer or AudioDesk’s *Audio Patch Thru* feature: when you record-enable a track, the track’s input is routed directly to its output (via CueMix FX in the 896mk3 hardware). For example, if you record-enable a track called *guitar* in your DP or AudioDesk project, and its audio input assignment is *Analog in 2*, and its audio output assignment is optical channels 7-8, CueMix FX no-latency hardware monitoring will automatically be set up from analog in 2 to optical outputs 7-8.

Controlling CueMix FX from within other software

Consult the manual for your software.

CHAPTER 11 CueMix Console

OVERVIEW

CueMix FX is a cross-platform software application that provides graphic, on-screen control for the 896mk3's flexible CueMix FX on-board mixer and effects processing.

CueMix FX can be used independently of host audio software, or together with it. CueMix dovetails with the direct monitoring features of your host audio software, allowing you to seamlessly mix in both environments.

For information about programming the 896mk3's on-board mixing and effects using the front panel LCD, see chapter 6, "896mk3 Front Panel Operation" (page 43).

A 16-bus mixer with EQ, compression and reverb....	75
Advantages over host-based mixing and processing	76
CueMix FX software installation	76
CueMix FX basic operation	77
The Mixes tab	78
The Inputs tab	80
The Outputs tab	82
The channel settings section.....	84
The Monitor Group	97
DSP meter	98
Solo light	98
Talkback and listenback	98
Shortcuts	99
File menu	100
Edit menu.....	100
Devices menu.....	100
Configurations menu	100
Talkback menu	101
Phones menu	101
Control Surfaces menu	101

A 16-BUS MIXER WITH EQ, COMPRESSION AND REVERB

All 896mk3 inputs and outputs can be routed to the on-board CueMix FX 16-bus (8 stereo bus) digital mixer driven by hardware-based DSP with 32-bit floating point precision.

The CueMix FX mixer allows you to apply no-latency effects processing to inputs, outputs or busses directly in the 896mk3 hardware, independent of the computer. Effects can even be applied when the 896mk3 is operating stand-alone (without a computer) as a complete rack-mounted mixer. Input signals to the computer can be recorded wet, dry, or dry with a wet monitor mix (for musicians during recording, for example).

Effects include:

- Classic Reverb with tail lengths up to 60 seconds
- 7-band parametric EQ modeled after British analog console EQs
- A standard compressor with conventional threshold/ratio/attack/release/gain controls
- The Leveler™, an accurate model of the legendary LA-2A optical compressor, which provides vintage, musical automatic gain control

The 838mk3's flexible effects architecture allows you to apply EQ and compression on every input and output (a total of 60 channels), with enough DSP resources for at least one band of parametric EQ and compression on every channel at 48 kHz. DSP resources are allocated dynamically and a DSP meter in the CueMix FX software allows you to keep tabs on the 896mk3's processing resources.

Each input, output and mix bus provides a send to the Classic Reverb processor, which then feeds reverb returns to mix busses and outputs, with a selectable split point between them to prevent send/return feedback loops.

ADVANTAGES OVER HOST-BASED MIXING AND PROCESSING

CueMix FX provides several major advantages over mixing and processing in your host audio software:

- CueMix has no buffer latency. Thanks to the 896mk3's DSP chip, CueMix provides the same throughput performance as a digital mixer.

- CueMix mixing and effects processing imposes no processor drain on the computer's CPU.

- CueMix routing can be maintained independently of individual software applications or projects.

- CueMix routing can operate without the computer, allowing the 896mk3 to operate as a portable, stand-alone mixer with effects.

CUEMIX FX SOFTWARE INSTALLATION

CueMix FX is an application installed with the rest of your 896mk3 software that lets you control the 896mk3 CueMix FX on-board mixer from your computer.

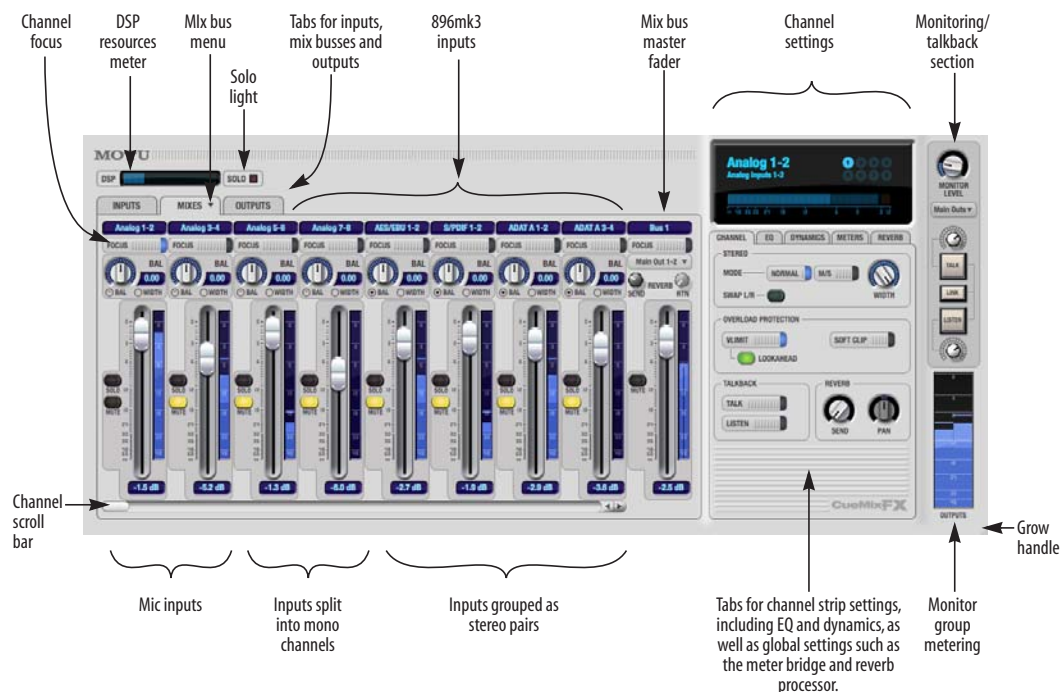

Figure 11-1: CueMix FX is a virtual mixer that gives you control over the 896mk3's on-board mixing features.

CUEMIX FX BASIC OPERATION

Here is a brief overview of the CueMix FX mixer.

Eight stereo mix busses

CueMix provides eight stereo mix busses: Bus 1, Bus 2, Bus 3, and so on. Each mix bus can take any number of inputs and mix them down to any 896mk3 output pair that you choose. For example, Bus 1 could go to the headphones, Bus 2 could go to the main outs, Bus 3 could go to a piece of outboard gear connected to analog outputs 7-8, etc.

Many inputs to one output pair

It might be useful to think of each mix bus as some number of inputs all mixed down to a stereo output pair. CueMix FX lets you choose which inputs to include in the mix, and it lets you specify the level, pan and other input-specific mix controls for each input being fed into the mix.

Viewing one mix bus at a time

CueMix FX displays one mix bus at a time in the *Mixes* tab (Figure 11-2 on page 78). To select which mix you are viewing, choose it from the mix bus menu (Figure 11-2). The mix name appears above the mix bus master fader (Figure 11-2), where you can click the name to change it.

Each mix bus is independent

Each mix bus has its own settings. Settings for one bus will not affect another. For example, if an input is used for one bus, it will still be available for other busses. In addition, inputs can have a different volume, pan, mute and solo setting in each bus.

Input channels

The *Inputs* tab (Figure 11-3 on page 80) gives you access to settings for individual 896mk3 inputs (or input pairs), such as phase, trim, EQ and dynamics processing. Each input also includes a send to the 896mk3's global reverb processor. These settings are applied to the signal before it goes anywhere else (to a mix bus or the computer).

Output channels

The *Outputs* tab (Figure 11-6 on page 83) gives you access to settings for each 896mk3 output pair, including EQ, dynamics processing and send/return controls for feeding and returning the output signal to/from the 896mk3's global reverb processor. These settings are applied to the signal just before it is sent to the output.

Channel focus and settings

Click the focus button for a channel (Figure 11-1) to view channel-specific parameters in the Channel Settings section of the CueMix FX window (Figure 11-1). Separate tabs are provided for channel-specific settings (channel strip, EQ and dynamics), plus the global meter bridge and reverb processor.

Global reverb processor

The 896mk3 has a global reverb module (Figure 11-23 on page 96). Once it has been activated, you can feed signals to the reverb processor from various points in the 896mk3 mix matrix via input sends, bus sends and output sends. Stereo output from the reverb processor can then be fed back to mix busses or output pairs using reverb returns.

Other features

CueMix offers many additional features, discussed in this chapter, such as talkback/listenback, extensive metering, graphic editing of certain effects parameters, monitor grouping and more.

Widening the CueMix FX window

To view more input faders at once, drag the grow box (Figure 11-1) to the right.

THE MIXES TAB

Click the *Mixes* tab (Figure 11-2) to gain access to the 896mk3's eight stereo mix busses. The Mixes tab displays one mix bus at a time.

Viewing a mix

Choose the mix you wish to view from the mix bus menu (in the Mixes tab itself, as shown in Figure 11-2). The menu shows all mixes by name, followed by the 896mk3 output pair to which each bus master fader is currently assigned, if any.

Naming a mix

Click the mix name at the top of the mix bus master fader (Figure 11-2) to edit the name.

Assigning a mix bus output

Choose the desired output pair for the mix bus from the bus output menu (Figure 11-2). The bus output menu displays all current available (enabled) 896mk3 output pairs. If a bus is already assigned to an output pair, the bus name appears next to the output pair name to indicate that the output pair is already taken by a bus. Only one bus can be assigned to any given output pair. If you choose an output already assigned to another bus, that bus output will become disabled.

Bus fader

The bus fader (Figure 11-2) controls the overall level of the mix (its volume on its stereo output). Use the individual input faders to the left to control individual input levels.

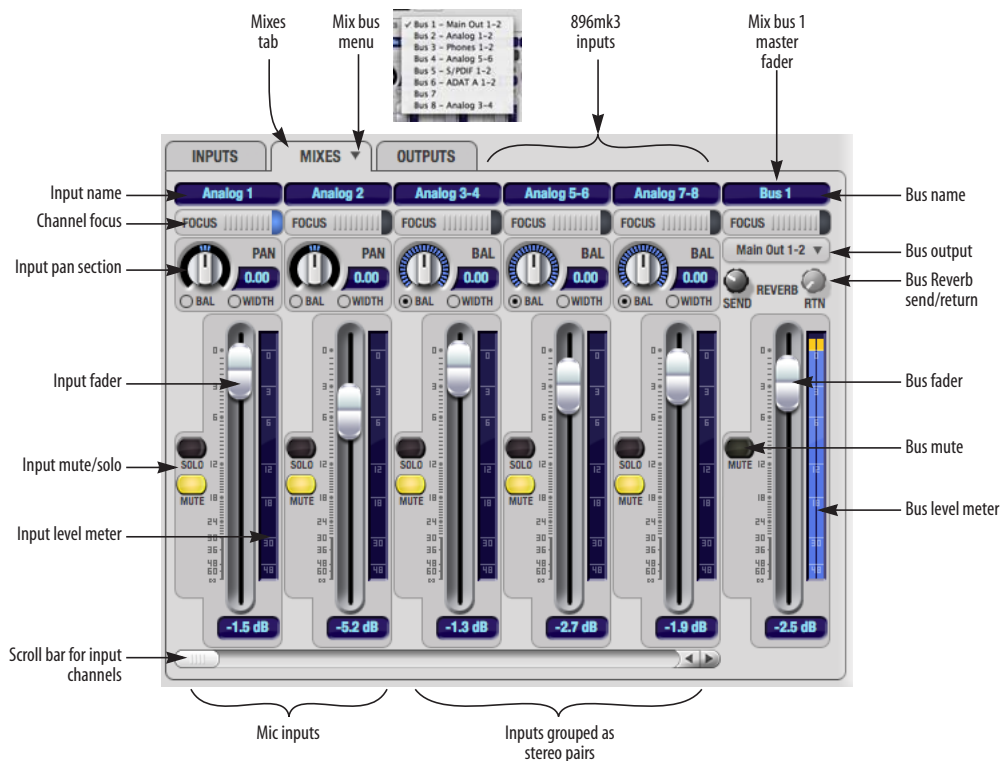

Figure 11-2: The Mixes tab.

Bus mute

The bus mute button (Figure 11-2) disables (silences) the mix.

Bus level meter

The bus level meter, which is post-fader, shows you the output for the mix's output.

Bus reverb send/return

The bus reverb send (Figure 11-2) feeds the output of the mix bus, pre-fader, to the 896mk3's global reverb processor, where it is merged with any other signals being fed to the reverb. The reverb's output can then be fed back into the mixer at various return points, including the bus return (discussed below).

The bus reverb *return* (Figure 11-2) feeds the output of the 896mk3's global reverb processor into the mix bus, pre-fader. This includes any other signals currently being fed to the reverb. The bus reverb return is disabled (grayed out) when the reverb *Split Point* is set to *Output* to eliminate the possibility for feedback loops created by reverb send/return loops. See "Split point" on page 96.

Input section

The horizontally scrolling area in the Mix tab to the left of the master fader (Figure 11-2) displays channel strips for all currently enabled 896mk3 inputs.

Naming an input

Click the input name at the top of the input channel strip (Figure 11-2) to edit the name. Input names are global across all mixes. This name also appears in host audio software on the computer (if the software supports channel names).

Input channel focus

Click the channel focus button (Figure 11-3) to view and edit parameters in the channel settings section of the CueMix FX window (Figure 11-7 on

page 84). Clicking the mix bus master fader focus button brings the assigned output into focus, if there is one.

Input pan section

The input pan knob (Figure 11-2) pans the input across the bus stereo outputs. If the input itself is grouped as a stereo pair (in the Inputs tab), two forms of panning control are provided:

Balance

Balance works like the balance knob on some radios: turn it left and the right channel dims, turn it right and left channel dims. But the left channel always stays left and the right channel stays right.

Width

Width spreads the left and right channels across the stereo image, depending on the knob position. Maximum value (turning the pan knob all the way up) maintains the original stereo image: the left channel goes entirely left and right goes entirely right, without attenuation. The minimum value (turning the knob all the way down) creates a mono effect: equal amounts of left and right are combined and sent to both outputs. In between, the left out is a mixture of the left input and some of the right input (and vice-versa) with the effect of narrowing the field.

Input fader and mute/solo

To add an input to a mix, or remove it, click its Mute button. To solo it, use its Solo button. Use the input fader (Figure 11-2) to adjust the level for the input in the mix. Note that an input can have different level, pan, mute and solo settings for different mixes. Input channel level meters are post-fader.

If any solo button on the current (active) bus is enabled, the Solo Light (Figure 11-1) will illuminate.

THE INPUTS TAB

The 896mk3 provides many features for managing analog and digital input signals. Some of these features, such as the front panel trim knobs, are implemented in the analog domain; others are implemented in the digital domain as DSP applied to the digital signal (after the A/D converter on analog inputs). Click the *Inputs* tab (Figure 11-3) to access and control all of these input channel settings for each 896mk3 input or input pair.

Input tab settings are global

Except for the reverb send, all settings you make in the Input tab are applied to the input signal before it goes anywhere else (to a mix bus or the computer). For example, if you apply EQ and compression to the input signal, you will record the processed version of the signal in your host audio software running on the computer. If you need to record a completely unprocessed input signal, do

not apply any changes to it in the Input tab. The only exception to this is the reverb send, which simply splits the input signal and feeds a copy of it to the 896mk3's reverb processor.

Signal flows from top to bottom

Settings in each Input tab channel strip are generally applied to the signal in order from top to bottom. Input channel signal flow is as follows: front-panel trim, overload protection, phase, stereo versus M/S decoding, width, L/R swap, EQ, dynamics and reverb send.

Input name

Click the input name at the top of the input channel strip (Figure 11-3) to edit the name. Input names are global across all mixes. This name also appears in host audio software on the computer (if the software supports channel names).

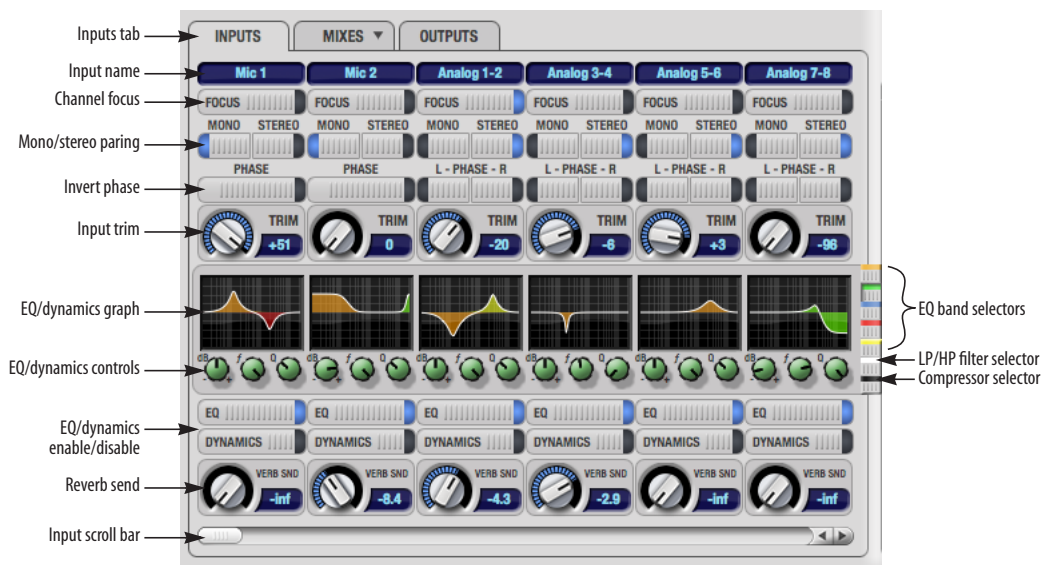

Figure 11-3: The Inputs tab.

Input channel focus

Click the channel focus button (Figure 11-3) to view and edit parameters in the channel settings section of the CueMix FX window (Figure 11-7 on page 84).

Mono/stereo pairing

Click the *Mono* button (Figure 11-3) if you would like an input to be treated as a mono channel. If you would like to work with it as one channel of a linked stereo pair, click the *Stereo* button. Inputs are grouped in odd/even pairs (Analog 1-2, 3-4, etc.) Stereo pairs appear as a single channel strip in the CueMix FX mixer (in all tabs).

Invert phase

Click the *Phase* button (Figure 11-3) to invert the phase of the input signal. For stereo pairs, you can invert the phase for the left and right channels independently.

Input trim

All 896mk3 inputs, both analog and digital, offer continuously variable input trim. For analog inputs, trim is handled in the analog domain. For digital inputs, trim level can be controlled digitally in 1 dB increments. Here is a summary of input trim ranges for each type of 896mk3 input:

Input	Trim cut	Trim boost	Trim Range
Analog inputs	0 dB	+60 dB	60 dB
AES/EBU	0 dB	+12 dB	12 dB
S/PDIF (RCA)	0 dB	+12 dB	12 dB
ADAT optical	0 dB	+12 dB	12 dB
S/PDIF (TOSLINK)	0 dB	+12 dB	12 dB

Once you adjust the trim levels, you can save them as a file on disk for future instant recall. See “Saving and loading hardware presets” on page 100 and “Configurations menu” on page 100.

Input EQ and dynamics

The 896mk3 lets you apply 7-band parametric EQ and dynamics processing (DSP) to any input, analog or digital.

The controls in the EQ/Compression section of the Inputs tab (Figure 11-3) let you edit EQ and compression settings within the context of the channel strip. This is ideal when you are comparing settings among neighboring channels, or perhaps even applying the same setting across all inputs. However, for more detailed editing of EQ and compression settings for an input channel, you can click its Focus button and view the settings in the Channel Section of the CueMix FX window (Figure 11-1). This section even provides graphical editing of EQ curves and the compressor graph, allowing you to click and drag directly on the graphic. For details see “The channel settings section” on page 84.

The EQ/Dynamics graph

The EQ/Dynamics graph for each input channel strip (Figure 11-3) provides a thumbnail view of the EQ curves or Compressor graph for the channel. This graphic is for display purposes only; it cannot be edited directly. To change the EQ settings in this graph, use the two or three knobs below, as explained in the following sections. If, however, you would like to edit the EQ curves graphically, you can do so in the EQ tab (Figure 11-10 on page 86).

EQ/Dynamics selectors

The EQ/Dynamics selector buttons along the right-hand edge of the EQ/Dynamics section (Figure 11-3) allow you to choose what you are viewing and editing in the EQ/Dynamics section.

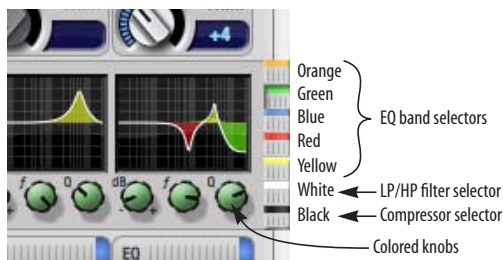

Figure 11-4: The EQ/Dynamics selectors.

Click the selector (Figure 11-4) for the desired EQ band, low-pass (LP) filter, high pass (HP) filter or compressor to view it across all channels.

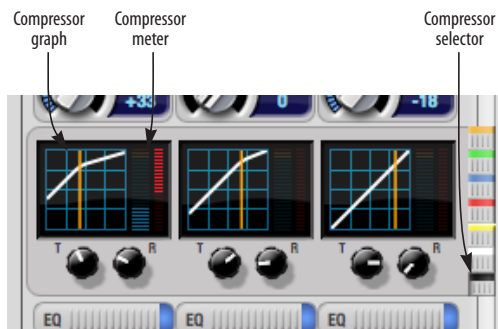

Figure 11-5: The Compressor controls.

☞ **Shortcut:** hold down the option key while clicking an EQ selector button to show just that band of EQ in the graphs. Click any selector again to return to viewing all bands.

Using the EQ/Dynamics knobs

Once you have chosen the desired EQ band, or the compressor, you can modify its settings using the two or three knobs below the graph. The knobs match the color of the currently selected effect, to help remind you of which effect you are currently editing.

☞ **Important:** before you can modify the settings of an EQ band using the three knobs below the graph, the EQ band must be enabled. This is done in the EQ tab (Figure 11-10), as explained in “Enabling EQ” on page 87.

EQ/Dynamics enable/disable buttons

Click the EQ or Dynamics button at the bottom of the input channel (Figure 11-3) to toggle the effect on or off. Note that you can program EQ and compressor settings, even when the effect is currently disabled. (You just won't hear the result until you enable it.)

Reverb send

The input reverb *send* (Figure 11-3) feeds the input signal to the 896mk3's global reverb processor, where it is merged with any other signals being fed to the reverb. The reverb's output can then be fed back into a mix or output pair. The send occurs after all other settings in the input channel strip (phase invert, EQ, compression, etc.)

THE OUTPUTS TAB

The Outputs tab (Figure 11-6) lets you apply EQ, dynamics and reverb to any output pair, just before the signal leaves the 896mk3. This is processing that occurs at the very end of the signal flow, after everything else (host based effects, 896mk3 input or bus processing, mixing, and so on). Processing is done in the digital domain, just before the signal goes analog through the D/A converter. Output tab processing is applied to the entire output mix (all signals being mixed to the output from various sources).

Signal flows from top to bottom

Settings in each Output tab channel strip are applied to the signal in order from top to bottom. For example, EQ occurs before Dynamics, which is applied before the reverb send and return.

Naming an output

Click the output name at the top of the output channel strip (Figure 11-6) to edit the name. Output names are global and will also appear in host audio software on the computer (if the software supports channel names).

Output channel focus

Click the channel focus button (Figure 11-6) to view and edit parameters in the channel settings section of the CueMix FX window (Figure 11-7 on page 84).

Output EQ and Dynamics

The EQ/Dynamics section in the Outputs tab (Figure 11-6) works identically to the EQ/Dynamics section for the Inputs tab (Figure 11-3). See “Input EQ and dynamics” on page 81.

Output reverb send/return

The output reverb *send* (Figure 11-6) feeds the signal for the output to the 896mk3’s global reverb processor, where it is merged with any other signals being fed to the reverb. The reverb’s output can then be fed back into the mixer at various return points, including the same output from which it was sent (discussed below). The output reverb send is disabled (grayed out) when the reverb *Split*

Point is set to *Mix* to eliminate the possibility for feedback loops created by reverb send/return loops. See “Split point” on page 96.

The output reverb *return* (Figure 11-6) feeds the output of the 896mk3’s global reverb processor directly to the output. This includes any other signals currently being fed to the reverb.

Both the send and return occur after EQ and dynamics processing, but before listenback and talkback.

Talkback/Listenback

Click the *Talkback* or *Listenback* buttons (Figure 11-6) to toggle whether the output pair is included in the Talkback or Listenback group. See “Talkback and listenback” on page 98.

Monitor group assign

Click the Monitor buttons (Figure 11-6) to toggle whether the output pair is included in the Monitor group. See “The Monitor Group” on page 97.

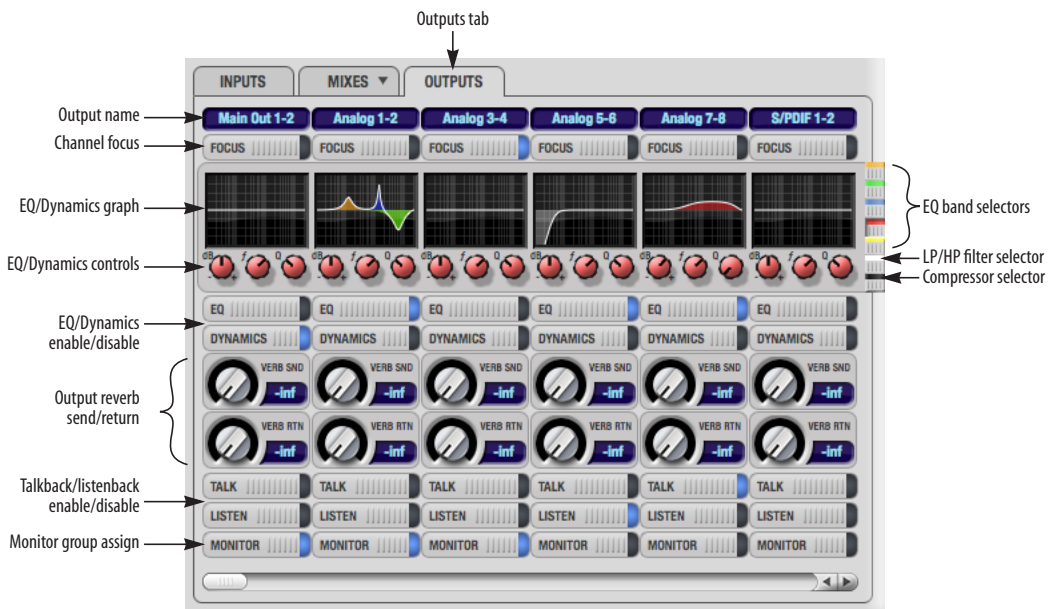

Figure 11-6: The Outputs tab.

THE CHANNEL SETTINGS SECTION

The channel settings section in the CueMix FX window (Figure 11-1) displays three tabs for Channel, EQ and Dynamics settings for the channel with the current focus. There are also two global tabs: the Meter Bridge and the Reverb Processor, as shown below.

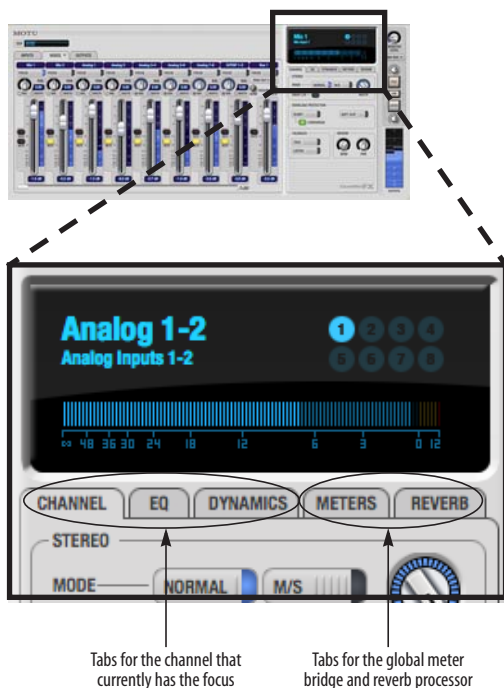

Figure 11-7: The Channel Settings section.

The Channel tab

The Channel tab (Figure 11-8) displays settings for input channels. Click any focus button in the Inputs tab to view the Channel tab settings for the channel.



Figure 11-8: The Channel tab.

Signal flow

Settings in the Channel tab occur just before the EQ, dynamics and reverb sends in the Input tab channel strip (Figure 11-3 on page 80). Input channel signal flow is as follows: trim, overload protection, phase, stereo versus M/S decoding, width, L/R swap, EQ, dynamics and reverb send.

Stereo settings

Inputs that have been grouped as stereo pairs in the Inputs tab (Figure 11-3) provide two stereo modes (Figure 11-8): *Normal* and *M/S*. M/S mode provides decoding for a mid-side microphone configuration.

The *Width* knob (Figure 11-8) provides control over the stereo imaging, going from a full stereo image to mono (both channels panned equally). See “Width” on page 79.

The *Swap L/R* button (Figure 11-8) lets you switch the left and right channels.

Overload protection (mic/guitar inputs only)

The Overload Protection section (Figure 11-8) provides two features that help prevent digital clipping on the eight mic/guitar inputs. These options are only available on these preamp-equipped inputs.

V-Limit[™] (Figure 11-8) is a hardware limiter that helps prevent digital clipping from overloaded input signals. With *V-Limit* engaged, signals can go above zero dB (with limiting applied) to as high as +12 dB above zero with no distortion due to digital clipping. Click the *Lookahead* option for even better protection against sharp transients.

🔊 *Lookahead* adds a 1.5 millisecond delay to the input signal. Therefore, when you enable *lookahead* for one or more inputs, all analog inputs (even ones without the limiter and *lookahead* enabled) are delayed together by 1.5 ms so that all eight inputs remain perfectly in phase with each other.

Additional or alternative protection can be applied to the mic/guitar inputs by enabling *Soft Clip* (Figure 11-8). When enabled, *Soft Clip* engages just before clipping occurs and helps further reduce perceptible distortion. When *V-Limit* is turned off, *Soft Clip* begins to engage around -2 dB (just below zero); when *V-Limit* is turned on, *Soft Clip* begins to engage around +10 dB (just below +12 dB).

Talkback section

Click the *Talkback* or *Listenback* button (Figure 11-8) to toggle whether the input is the *Talkback* or *Listenback* input. Only one input can be the *talkback* input, and only one input can be the *listenback* input. See “Talkback and listenback” on page 98.

Reverb section

The *Send* in the reverb section (Figure 11-8) is the same control as the reverb *send* in the *Input* tab channel strip (Figure 11-3). See “Reverb send” on page 82. If the input is currently not grouped as a stereo pair in the *Input* tab (it is operating as a mono input), use the reverb *Pan* knob (Figure 11-8) to pan the mono signal for the stereo reverb processor.

Input meter and bus activity LEDs

When the *Channel* tab is active (Figure 11-8), the display above the tab provides a horizontal level meter and eight *bus activity LEDs* (Figure 11-9).

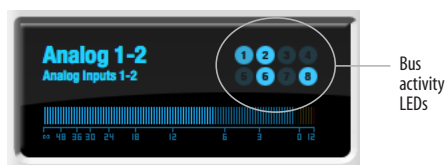

Figure 11-9: Input meter and bus activity LEDs.

The *input level meter* (Figure 11-9) is the same as the input meters in the *Meters* tab (Figure 11-22 on page 95) with the *Pre FX* button engaged, which shows the input level on the physical input itself, before any processing of any kind occurs within the 896mk3. This meter gives you the most accurate reading of the actual signal level hitting the input, regardless of any other settings (such as *V-Limit*, *Soft Clip* and so on). The clip indicator, however, happens after *V-Limit* and/or *Soft Clip*. This allows you to see when clipping occurs, even with these overload protection features engaged.

The *Bus Activity LEDs* (Figure 11-9) show you which mix busses the input signal is being fed to. For example, LED #6 will glow under the following conditions: the input is unmuted in mix bus 6, its fader is up, and there is signal activity from the input going into the mix bus.

The EQ tab

The EQ tab (Figure 11-10) displays the EQ settings for the input or output channel that currently has the focus. Click any focus button in the Inputs or Outputs tab to view the EQ tab settings for the channel.

Vintage EQ

Inspired by legendary British large console EQs, the 896mk3 *Vintage EQ section* (Figure 11-10) gives you the look, feel and sound of the most sought-after classic equalizers. Five bands of center frequency parametric EQ filtering are provided, each with four EQ types that provide current popular EQ styles and vintage analog EQ styles alike. Two bands include shelf filtering. Two additional bands of variable slope low pass and

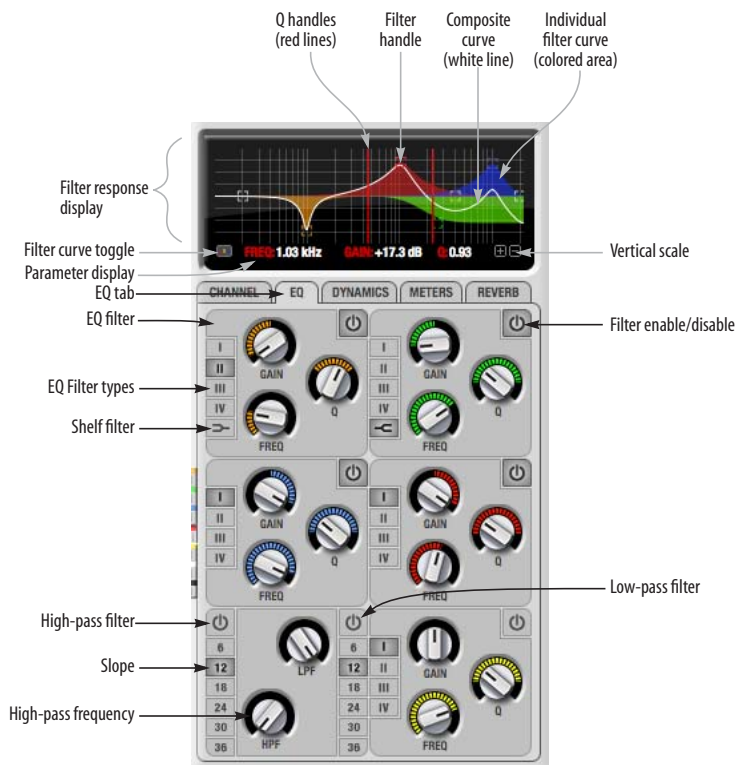

Figure 11-10: The EQ tab.

high pass filtering are provided. The filter response display provides comprehensive control and visual feedback of the EQ curve being applied. With 64-bit floating point processing, the 896mk3 Vintage EQ has been carefully crafted and meticulously engineered to produce musical results in a wide variety of applications.

Enabling EQ

Each input and output channel has a global *EQ enable/disable* button (Figure 11-3 and Figure 11-6). This button enables or disables all bands of EQ for the channel. In addition, each individual band of EQ has a *Filter enable/disable* switch (Figure 11-10), allowing you to enable as few or as many bands as needed for each individual channel.

Vintage EQ Quick reference

Filter response display: Shows the response curve for the current settings.

Vertical scale: Lets you zoom the vertical scale of the filter response display.

Parameter display: Shows the precise numbers of the parameter you are adjusting (or hovering over with the arrow cursor). The labels (*frequency, gain, etc.*) match the color of the filter being displayed. When a filter handle is not selected and when the cursor is not hovering over the display, the parameter display shows the name of the current channel being edited (the channel that currently has the focus), as shown below:

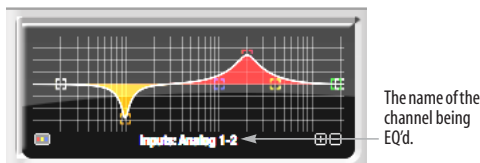

Figure 11-11: When a filter handle is not selected and when the cursor is not hovering over the display, the parameter display shows the name of the current channel being edited (the channel that currently has the focus).

EQ filter: one of five center bands of EQ that can be independently enabled and programmed.

Filter type: Lets you choose from one of four or five EQ styles for each independent band of EQ.

Low/High Pass filter: Both a low pass and high pass filter are supplied with six different slope settings.

Slope: Lets you choose the slope (fall off) characteristics of the low pass and high pass filter.

Q handle: Drag the Q handle lines to graphically adjust the Q setting for the currently selected filter. To select the filter, click its filter handle.

Filter handle: Drag this handle to graphically adjust the filter's boost/cut and/or frequency.

Composite curve (white line): shows the overall response curve of the current settings in the window.

Individual filter curve: Each filter has a color (indicated by its knobs). When filter curves are being displayed (the filter curve option is turned on), each individual filter's response curve is displayed in the filter's color.

Filter curve toggle: Shows/hides the colored filter curves in the display.

Filter enable/disable: Turns the filter on or off.

How the vintage EQ works

The Vintage EQ operates like a standard EQ filter, but with much more sophisticated processing algorithms “under the hood”. There are five bands of EQ, each with their own unique knob color, plus additional low pass and high pass filters. Each filter can be set to any center frequency you wish.

Each filter can be independently turned on or off with the enable/disable button (Figure 11-10).

Each filter can be set to one of four different filter

types (I, II, III or IV). The two top-most filters (orange and green) provide an extra low and high shelf setting, in addition to the four standard band settings. The additional low pass and high pass filters (lower left) have gray cutoff frequency knobs and six settings for slope (in octaves/dB).

Frequency response display

The frequency response display at the top of the window displays the response curve of the current settings in the window. The (horizontal) frequency range is from 10 hertz to 20 KHz. The (vertical) amplitude scale is in dB and is adjustable between 3 and 24 dB using the *vertical scale* buttons (Figure 11-10).

Showing and hiding filter curves

To view a filter in the display, turn on the filter. The shape of the filter, according to its current settings, is shaded in the same color as the filter's knob(s). Use the *filter curve toggle* (Figure 11-10) to show or hide them in the display.

Adjusting filters in the display

Each filter has a handle, displayed as shown below in Figure 11-12 (in the filter's color), for adjusting its boost/cut and/or frequency:

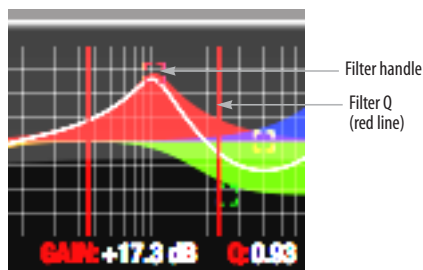

Figure 11-12: Drag the filter handle to adjust its frequency and/or boost/cut. Drag the Filter Q handles to adjust the Q.

For the EQ filters, when you click the handle, you'll also see lines on either side for adjusting the Q parameter, as shown above.

EQ filters

The EQ filters have three parameters:

Control	unit	range
Gain	dB	-20.00 to +20.00
Frequency	Hertz	20 Hz to 20 kHz
Q	n/a - see note below	0.01 to 3.00

Q

The Q setting does not have a unit of measurement. Rather, it is the ratio of the filter's center frequency to the bandwidth of the filter. In addition, the actual Q value for the EQ curve being applied is dependent on three factors: the gain setting, the filter style, and the Q setting.

Filter types

Each filter can be independently set to one of four different filter types: I, II, III and IV. These, and the additional shelf filters for the LMF and HMF band, are discussed in the section "EQ filter styles".

Returning to zero (or nominal frequency)

To return a knob to zero, or its nominal frequency, double-click it.

EQ filter styles

EQ is one of the most widely used processing tools and can be applied to many different situations, from minor corrective tasks to highly creative applications. Over the years, many EQs have been engineered for specific applications or to achieve a certain sound. The Vintage EQ has been designed to be flexible enough to cover a broad range of applications. To that end, several different filter types are supplied, varying mostly in the way they handle the dynamic interaction between Gain and Q. This crucial relationship has been modeled to emulate the smooth and musical character of classic analog EQ circuits, in which the Gain/Q dependency was dictated by the actual circuit design and electrical components used.

The following sections describe the character of each type of EQ filter and their suggested applications. In the illustrations for each filter style (Figure 11-13 through Figure 11-16), the settings for the three example curves are the same for the purpose of comparison:

- Frequency = 1.00 kHz
- Q = 1
- Gain = +3, +10 and +20 dB

Type I

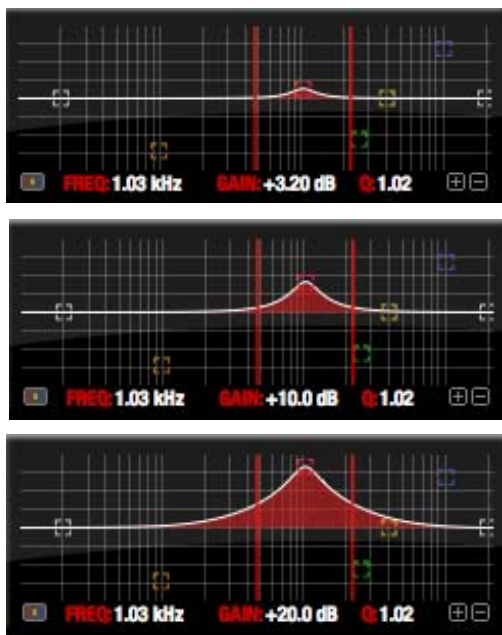

Figure 11-13: Type I EQ filter style.

The *Type I* EQ filter has the least amount of Gain/Q interaction, providing the most precision and control of all the EQ filter types. Even small adjustments in gain or reduction produce relatively high Q. This EQ style is best for situations that call for precise EQ adjustments requiring the maximum amount of individual parameter control. For more general shaping (e.g. full mixes) or subtle control (e.g. vocals), the other styles

discussed in the following sections might be more appropriate. This filter type is the most similar to a standard parametric EQ.

Type II

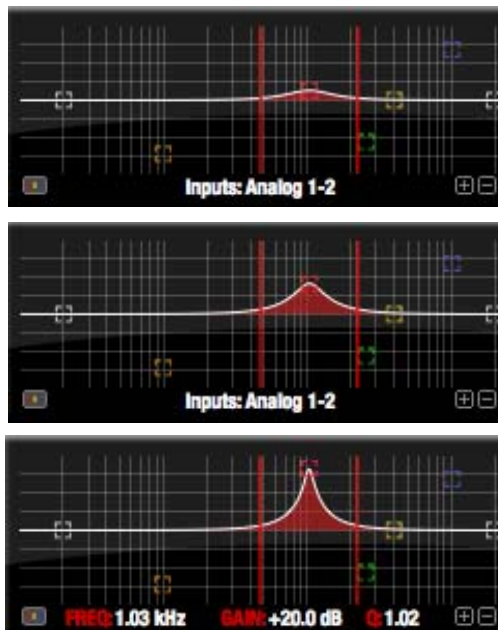

Figure 11-14: Type II EQ filter style.

The *Type II* EQ filter produces constant Q response during boost or cut. The *Type II* style emulates several classic legacy EQs and produces good results for resonance control on drums and percussion because it provides relatively high Q values with more extreme gain or cut settings.

Type III

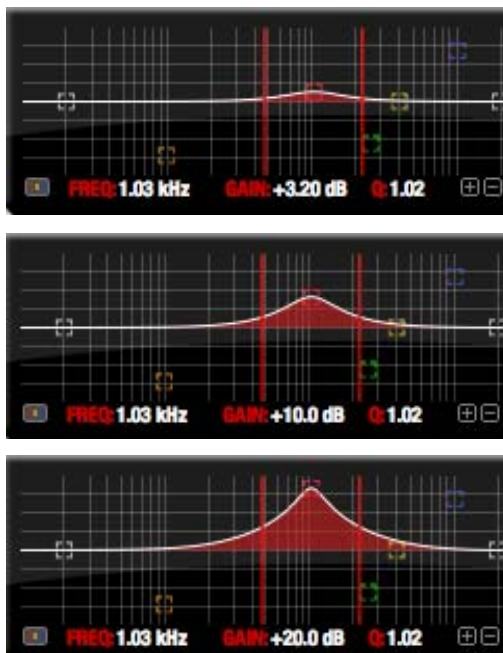

Figure 11-15: Type III EQ filter style.

The *Type III* EQ filter increases Q as boost is applied. Therefore, lower amounts of boost provide a softer, “wider” EQ effect (since the affected frequency range widens), while higher boost tends to sound louder and more “up front”, due to the increase in Q as the gain is increased. The more gentle Q curve at lower settings is well suited for overall EQ fills and more subtle corrections in instrument and vocal sources. Boosting or cutting by small amounts will seem to produce the effect that your ear expects, without the need to adjust Q. As a result, this filter style, and similar EQs with this characteristic behavior, are often referred to as being more “musical”. More specifically, this style emulates the classic Neve EQs, their modern derivatives and later SSL G series EQs. Many current popular outboard “boutique” EQs exhibit this same gain/Q relationship.

Type IV

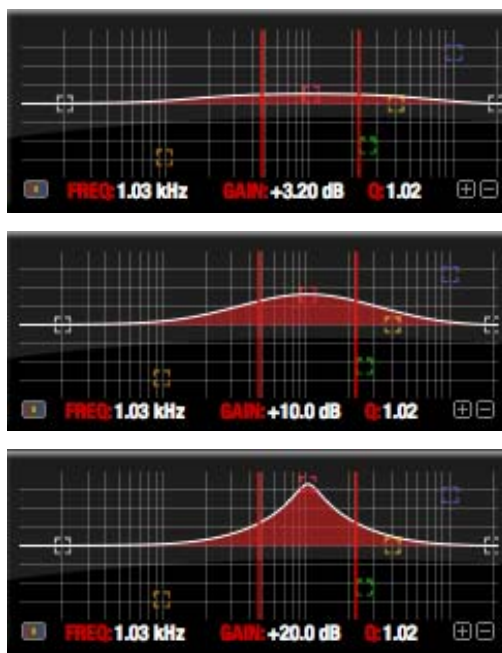

Figure 11-16: Type IV EQ filter style.

The *Type IV* EQ filter is a more extreme form of the *Type III* filter. It exhibits a high degree of interaction between Q and gain in order to maintain as closely as possible an equal amount of area under the response curve as gain is adjusted. *Type IV* is the most gentle of the four EQ styles and is ideal for large scale EQ adjustments, especially on sub-mixes and complete mixes. This EQ style is also ideal for any applications where subtle changes in the overall character of the sound are desired. For example, it can be used for mastering applications, such as the overall adjustments that must often be applied to entire tracks to match other tracks on the album.

Shelf filters

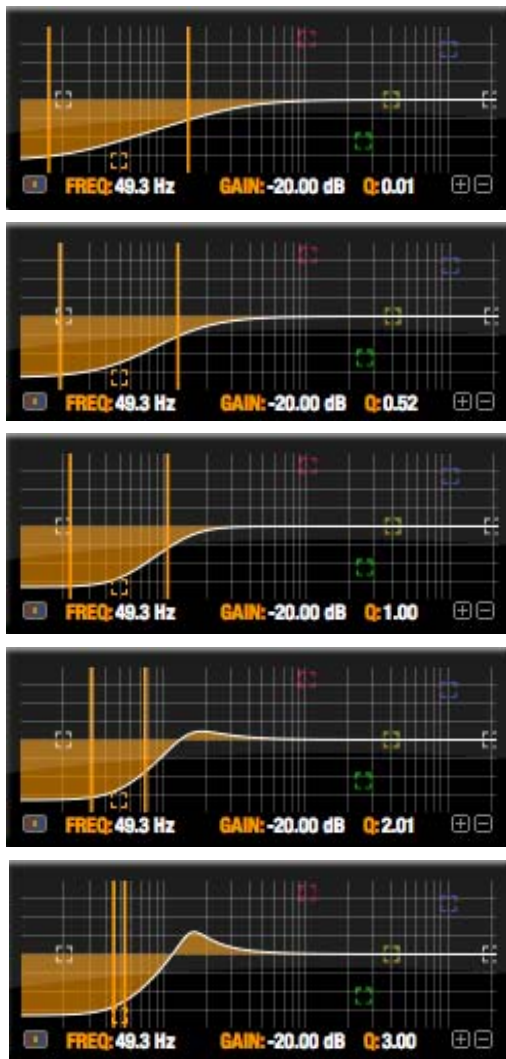

Figure 11-17: Shelf filter Q parameter overshoot.

When two top-most bands in the EQ tab are set to their *shelf filter* setting (Figure 11-10), the Q parameter controls the amount of overshoot applied to the response curve, as illustrated in Figure 11-17. When $Q = 0.01$ (the lowest setting), normal shelving is applied with no overshoot. This produces the response provided by a first order shelf. When $Q = 1.0$ (the default setting), the

response corresponds to a second order shelf, still with no overshoot. This is the same response as conventional parametric EQs. In some situations, this form of accurate, clean shelving can sound harsh, especially when compared to legacy analog EQs. To soften the results, the overshoot is increased as Q is increased, as shown Figure 11-17 for Q values of 1.00, 2.00 and 3.00. This overshoot region produces a boost in frequencies just above the cutoff, which compensates in a smooth, more pleasing fashion for the perceived drop in low frequencies being cut.

Conversely, when shelving boost is being applied, overshoot cuts frequencies just above the cutoff to again compensate in a smooth and pleasing fashion for the perceived boost in low frequencies:

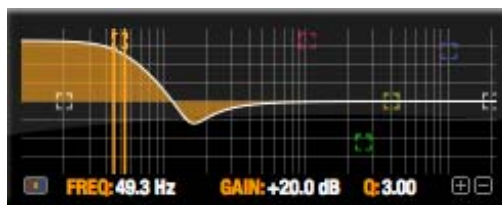

Figure 11-18: Overshoot when low shelf boost is applied.

Overshoot is also applied to high shelf boost and cut:

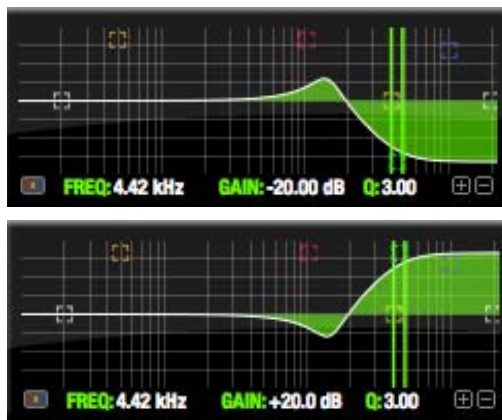

Figure 11-19: Overshoot when high shelf cut and boost is applied.

Overshoot tends to produce more of what one would expect to hear when applying shelving and is therefore considered to be more musical than shelving without overshoot. This effect, which has gained tremendous popularity among audio engineers, was first made popular in original Neve series EQs and later in the SSL G series.

At maximum the maximum Q setting of 3.00, the overshoot peaks at half the total boosted (or cut) gain. For example, with a maximum gain setting of +20dB, the loss in the overshoot region is -10 dB.

Overshoot curves are symmetrical for both cut and boost.

Low pass and high pass filters

The Vintage EQ low and high pass filters are similar to those found in most conventional parametric EQs (which usually have a fixed slope of 12 dB per octave), except that Vintage EQ provides six different slope (roll off) settings: 6, 12, 18, 24, 30 and 36 dB per octave. This control over the shape of the “knee” gives you a great deal flexibility and control for a wide variety of applications.

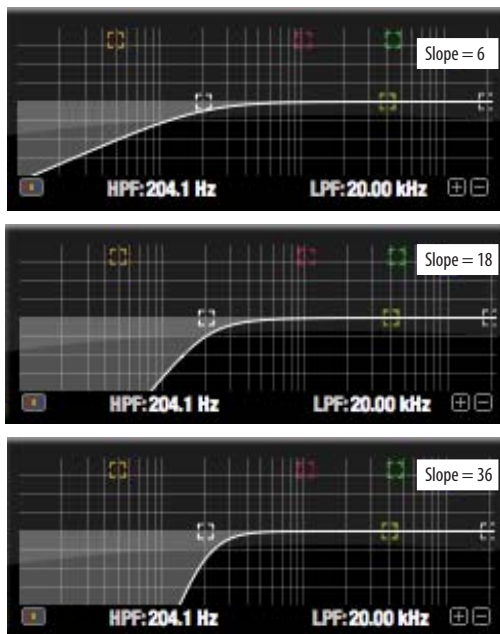

Figure 11-20: The low pass filter with three example slope settings.

The Dynamics tab

The Dynamics tab (Figure 11-21) displays the Dynamics processing settings for the input or output channel that currently has the focus. Click any focus button in the Inputs or Outputs tab to view the Dynamics tab settings for the channel.

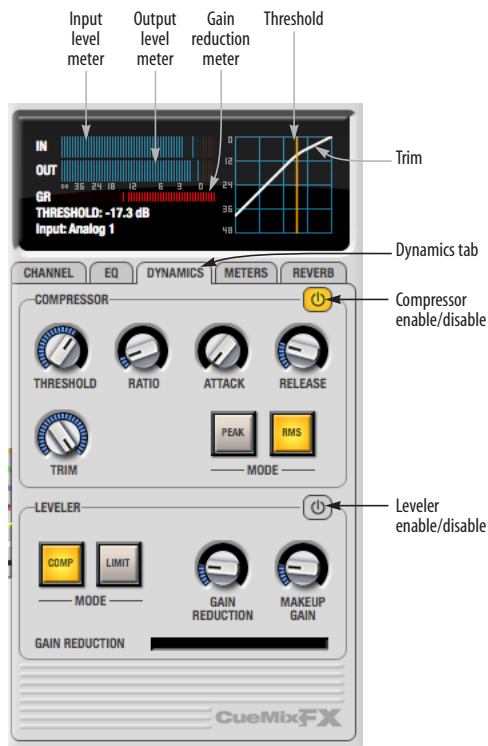

Figure 11-21: The Dynamics tab.

Enabling Dynamics

Each input and output channel has a global *Dynamics enable/disable* button (Figure 11-3 and Figure 11-6). This button enables or disables all dynamics processing for the channel. In addition, the Dynamics tab has two different dynamics processors, the Compressor and Leveler, which can be individually enabled or disabled (Figure 11-21) for the channel.

Compressor

The *Compressor* (Figure 11-21) lowers the level of the input when it is above the threshold. The amount of attenuation is determined by the *Ratio* and the input level. If the input is 6 dB above the *Threshold* and the Ratio is 3:1, then the output will be 2 dB above the Threshold. When the input level goes above the threshold, the attenuation is added gradually to reduce distortion. The rate at which the attenuation is added is determined by the *Attack* parameter. Likewise, when the input level falls below the Threshold, the attenuation is removed gradually. The rate at which the attenuation is removed is determined by the *Release* parameter. Long Release times may cause the audio to drop out briefly when a soft passage follows a loud passage. Short Release times may cause the attenuation to pump when the average input level quickly fluctuates above and below the Threshold.

These sorts of issues can be addressed by applying the Leveler instead.

Graphic adjustment of the Threshold

The Threshold can be adjusted by turning the Threshold knob or by dragging the Threshold line directly in the compressor graph (Figure 11-21).

Input level meter

The *Input Level* meter (Figure 11-21) shows the level of the input signal before it enters the compressor. It shows either the peak level or the RMS level, depending on which mode is currently chosen.

Gain reduction (GR) meter

The Gain reduction (*GR*) level meter (Figure 11-21) displays the current amount of attenuation applied by the compressor.

Output level

The *Output Level* meter (Figure 11-21) displays the peaks of the output signal. Trim is applied before the Output Level meter.

Peak/RMS modes

In *RMS mode* the compressor uses RMS values (a computational method for determining overall loudness) to measure the input level. In *Peak mode*, the compressor uses signal peaks to determine the input level. RMS mode will let peaks through because the detector sidechain is only looking at the average signal level. Peak mode will react to brief peaks. Peak mode is generally used for drums, percussion and other source material with strong transients, while RMS mode is mostly used for everything else.

The input meters show either the peak level or the RMS level, depending on the mode.

Leveler

The Leveler™ (Figure 11-21) provides an accurate model of the legendary Teletronix™ LA-2A® optical compressor, known for its unique and highly sought-after Automatic Gain Control (AGC) characteristics. The 896mk3 Leveler faithfully models the LA-2A using the on-board DSP with 32-bit floating point precision.

A model of an optical compressor

The simplest description of an optical leveling amplifier device is a light shining on a photoresistor. The intensity of the light source is proportional to the audio signal, and the resistance of the photoresistor is in turn inversely proportional to the intensity of the light. Photoresistors respond quite quickly to increases in light intensity, yet return to their dark resistance very slowly. Thus, incorporation of the photoresistor into an attenuator followed by an amplifier which provides make-up gain produces a signal which maintains a constant overall loudness.

Automatic gain control using light

The the Automatic Gain Control (AGC) circuit of the LA-2A uses a vintage opto-coupler known by its model number (T4). The T4 contains an electroluminescent panel (ELP) and photoresistor mounted so that the emission of the panel modulates the resistance. An ELP consists of a thin layer of phosphorescent material sandwiched between two insulated electrodes to form a capacitor. Making one of the electrodes transparent allows the light to escape. These devices are essentially glow-in-the-dark paint on a piece of foil covered by metalized glass or plastic, and are the same devices used in low-power night lights. Unfortunately, these devices need high voltages to operate, and are best driven by tube circuits which can supply voltage swings of several hundred volts.

Response characteristics

Once the light has faded away, the photoresistor then decays back to its dark state. The shape of the decay curve varies depending on how bright the light was, and how long the light lasted. A general rule of thumb is that the louder the program, the slower the release. Typically, the release can take up to and over one minute. One thing to keep in mind when using these types of devices is that the typical concepts of compression ratio, attack, release, and threshold do not apply. The light intensity is determined by the highly non-linear interactions of the input signal, AGC circuit, and ELP, and thus exhibit a strong program dependence that is impossible to describe without the mind-numbing mathematics of statistical mechanics. The actual results, however, can be almost mystical: even when you feed the same material (a loop perhaps) through the Leveler twice, you'll often see a new response the second time through a loop, complete with unique attack times, release times and compression ratios. Furthermore, two different input signals with the same RMS levels may be leveled in a drastically different manner.

It is precisely this self-adjusting behavior that makes optical compressors the tool of choice for smoothing out vocals, bass guitar and full-program mixes without destroying perceived dynamics.

Compressor/Limit buttons

The *Comp* and *Limit* buttons (Figure 11-21) model the original LA-2A Limit/Compress mode switch. The effect is very subtle, with the Limit option behaving only slightly more like a limiter than a compressor. The switch increases the level of the input to the AGC model and runs the attenuator at a slightly lower level. The Leveler then responds more strongly to transients, but otherwise still behaves like a leveling amplifier.

Gain Reduction

Gain Reduction (Figure 11-21) sets the strength of the signal sent to the AGC model.

Makeup Gain

Makeup gain (Figure 11-21) amplifies the output signal to make up for gain reduction.

Enabling or disabling the Leveler

The Leveler models the LA-2A so closely, it also models the time it takes for an actual LA-2A to “warm up” after it is turned on. Therefore, when you enable the Leveler, give it a moment to “settle” before you begin processing signals with it.

The Meters tab

The *Meters* tab (Figure 11-22) serves as a comprehensive meter bridge for all inputs, outputs and mix busses in the 896mk3. This tab gives you a “bird’s-eye” view of all signal activity in the 896mk3; it is ideal for confirming your signal routing programming and for troubleshooting.

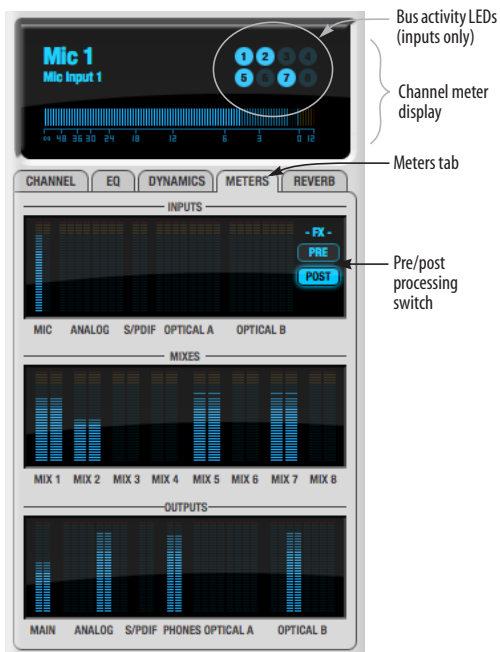

Figure 11-22: The Meters tab.

Channel meter display

The *channel meter display* (Figure 11-22) provides a long-throw meter for the input or output that currently has the focus in the Input/Output tabs.

Bus activity LEDs (inputs only)

The *Bus activity LEDs* (Figure 11-22) are present only for inputs. See “Input meter and bus activity LEDs” on page 85.

Pre/post processing switch

The *pre/post processing* switch (Figure 11-22) affects all input meters (and the meter in the channel meter display above the tab, if this area is displaying an input meter). Click *Pre* to view levels *before* any input channel processing besides trim; click *Post* to view levels *after* all channel processing (EQ, compression, M/S decoding, L/R swap, etc.)

The Reverb tab

The *Reverb* tab (Figure 11-23) provides access to the 896mk3's single, global reverb processor, which provides high-fidelity reverberation and graphic control over its parameters.



Figure 11-23: The Reverb tab.

Enabling reverb

Use the enable/disable button (Figure 11-23) to turn the reverb processor on or off. Since reverb uses considerable DSP resources, it is best to leave it off when you are not using it.

Routing inputs, busses and outputs to the reverb processor

The reverb processor is a single, independent unit that provides stereo reverb. You can route multiple signals to it from various points (sends) in the CueMix FX mixer, but all incoming signals to the reverb processor are merged and processed

together. The resulting stereo output from the reverb can then be inserted into a mix bus or output using stereo returns.

Reverb sends

The following signals can be sent to the reverb processor via their corresponding sends (discussed earlier in this chapter):

- Mono or stereo inputs (Figure 11-3 on page 80)
- Mix bus output (Figure 11-2 on page 78)
- Outputs (Figure 11-6 on page 83)

Reverb returns

The stereo output from the reverb processor can be sent to the following destinations via their corresponding returns (discussed earlier in this chapter):

- Mix bus outputs
- Outputs
- The computer (via the Reverb Return bus)

Split point

The *Split Point* (Figure 11-23) prevents feedback loops that would be caused by a signal being sent to the reverb processor and then returned to the same signal path.

Mix

When the Split Point is set to *Mix*, the returns in the Mix bus tab become active and the sends in the Output tab gray out. This allows you to send from inputs and mixes and return to mixes and outputs.

Output

When the Split Point is set to *Output*, the sends in Output tab become active and the returns in the Mix bus tab gray out. This allows you to send from inputs, mixes and outputs and return to outputs.

Primary controls

The Primary Controls section (Figure 11-23) in the Reverb tab provides the following basic parameters for programming the reverb.

Reverb Time

Reverb time determines the length of decay, or *tail*, of the reverb. This is a global setting for the reverb processor. You can further refine the tails by independently setting the reverb time of three separate frequency bands, as discussed below in the Reverb Design section.

PreDelay

PreDelay is the amount of time before you hear the very first reflections. If you are in a large room, it takes a while before the first reflections return. PreDelay is useful for clarifying the original sound. For example, with vocals, the reflections won't start until after the initial sound of a word has been sung.

Shelf Filter

The *Shelf Filter* is a low-pass filter that controls the high frequency characteristics of the overall effect. *Frequency* sets the cutoff frequency for the filter and *Cut* sets the amount of signal attenuation applied by the filter.

Early reflections

Initial reflections give a space its unique sound. The shape of the room, the angles of the walls, even furniture in the room will produce a series of Initial Reflections. Think of the early reflections and room type as the “flavor” of the reverb. You can choose between several types of rooms. These are acoustic models for simulating these different types of spaces. The *Size* and *Level* parameters let you control the size of the room and the strength of the initial reflections.

☞ Here's a tip: try using initial reflections without any subsequent reverb (turn the reverb time down as far as it will go). You'll hear interesting and unusual effects.

Reverb design

The Reverb Design section allows you to independently control the reverb time for three separate frequency bands (*Low*, *Mid* and *High*) with adjustable cross-over points between them (*Low* and *High*). The *reverb time* for each band is specified in percent of the overall reverb time in the Primary Controls section at the top of the tab.

You can edit these parameters graphically by dragging the handles in the graphic display (Figure 11-23).

Width does what its name implies: if you turn this control all the way up, the result is maximum stereo imaging. A position of 12 o'clock produces essentially a mono image. Turning the control all the way down completely swaps the stereo image.

THE MONITOR GROUP

The *monitor group* is a set of 896mk3 outputs that can be controlled with the master Monitor Level knob in upper right corner of the CueMix FX mixer window (Figure 11-24), as well as the MASTER VOL knob on the 896mk3 front panel.

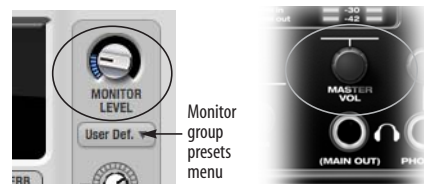

Figure 11-24: Monitor group volume control from CueMix FX and the front panel MASTER VOL knob.

Assigning outputs to the monitor group

Any combination of outputs can be assigned to the monitor group. To include an output pair in the monitor group, click its Monitor button in the Outputs tab (Figure 11-6 on page 83).

Monitor group presets menu

The *monitor group presets menu* (Figure 11-24) provides several presets for commonly used monitor groups:

Monitor group preset	Output assignment
Main Outs	Main Out 1-2
Stereo	Analog Out 1-2
Quad	Analog Out 1-4
5.1	Analog Out 1-6
7.1	Analog Out 1-8

If you program your own monitor output group, the presets menu displays the words *user def.* (user defined).

Monitor group meters

The monitor group meters (Figure 11-1 on page 76) show levels for any/all output pairs that are currently included in the monitor group. The width of the meters scales proportionally so that all current monitor group outputs will fit within the prescribed space for the meters. If many outputs are included, then the meters will look fairly thin, but they will all be included in the meter.

DSP METER

The DSP meter (Figure 11-1) shows how much of the available DSP processing power is currently being used by the 896mk3 for effects processing. DSP resources are allocated in channel order from the first input to the last output. If there aren't enough DSP resources for all effects to be enabled on a channel, none of them are allocated on that channel or any following channel.

EQ on a stereo channel requires approximately twice the DSP resources as the same EQ on a mono channel. The Compressor (2.5 x 1 EQ band) and Leveler (4 x 1 EQ band) require about the same DSP resources for a mono or stereo channel.

SOLO LIGHT

The Solo light (Figure 11-1) illuminates when any input in the current (active) mix bus is soloed (even if it is currently scrolled off-screen).

TALKBACK AND LISTENBACK

CueMix FX provides *Talkback* and *Listenback* buttons. Talkback allows an engineer in the control room to temporarily dim all audio and talk to musicians in the live room. Conversely, Listenback allows musicians to talk to the control room.

Hardware setup

Figure 11-25 below shows a typical hardware setup for Talkback and Listenback. For Talkback, set up a dedicated mic in your control room and connect it to a mic input on your MOTU audio interface. For Listenback, set up a dedicated listenback mic in the live room for the musicians and connect it to another mic input (or just use one of the mics you are recording from). For talkback output, set up a headphone distribution amp or set of speakers in the live room, and connect it to any 896mk3 output, as demonstrated below in Figure 11-25.

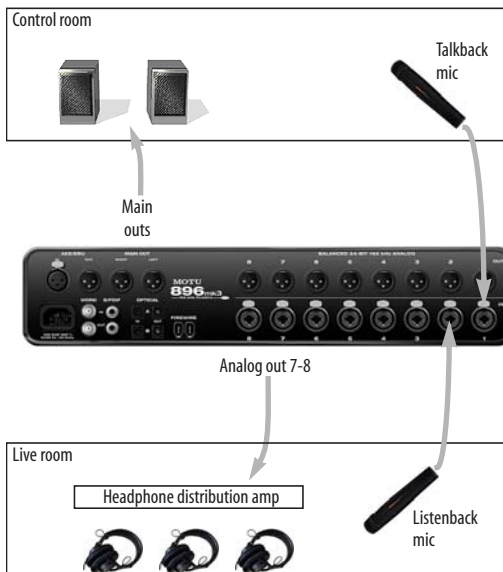

Figure 11-25: Typical hardware setup for Talkback and Listenback.

Talkback / Listenback Mic Input

To configure the talkback mic in CueMix FX, go to the Inputs tab (Figure 11-3 on page 80) and click the Focus button for the input that the talkback mic is connected to. Click the Channel tab (Figure 11-8 on page 84) and enable the *Talk* button.

Repeat this procedure for the Listenback mic, except click the *Listen* button in the Channel tab.

Talk / Listen output

To configure the talkback and listen back outputs, go to the Outputs tab (Figure 11-6 on page 83) and enable the *Talk* button for any output pair on which you'd like to hear the talkback mic. Similarly, enable the *Listen* button for any output pair on which you'd like to hear the listenback mic.

Talkback / Listenback Monitor Dim

Use the knobs next to the Talk and Listen buttons (Figure 11-26) to determine the amount of attenuation you would like to apply to all other audio signals (besides the talkback/listenback signal) when Talkback and/or Listenback is engaged. To completely silence all other CueMix audio, turn them all the way down. Attenuation only occurs when talkback or listenback is engaged. Audio playing back from disk (your host software) is not affected.



Figure 11-26: The Talkback/Listenback controls.

Engaging/disengaging Talkback and Listenback

To engage Talk back or Listenback, press on the Talk or Listen buttons (Figure 11-26) and then release to disengage. Talkback and/or Listenback is engaged for as long as you hold down the mouse button. Option-click to make the buttons “sticky” (stay engaged until you click them again — so you don’t have to hold down the mouse). Or use the Talkback menu items.

If you would like to engage both Talkback and Listenback at the same time, enable the *Link* button (Figure 11-26).

Controlling Talkback and Listenback volume

To control the volume of the Talkback and/or Listenback mics, adjust their input trim in CueMix FX.

SHORTCUTS

Hold down the following general modifier keys as shortcuts:

Shortcut	Result
Shift key	Applies your action to all inputs or all outputs in the mix.
Command key	Applies your action to the stereo input pair, even when it is currently configured as mono.
Option key	Applies your action to all busses.
Shift-Option	Applies your action to all inputs and mixes.
Double-click	Returns the control to its default value (pan center, unity gain, etc.)

Hold down the following modifier keys as shortcuts for the EQ tab and controls:

Shortcut	Result
Shift click	Applies EQ button change to all input or outputs.
Option-click	Applies EQ enable button changes to all bands in that input or output.
Shift-Option-click	Applies EQ enable button changes to all bands and all inputs or outputs.

FILE MENU

Saving and loading hardware presets

The 896mk3 can store up to 16 presets in its on-board memory. A preset includes of all CueMix FX settings for all for mix busses, but it excludes global settings like clock source and sample rate.

The Load Hardware Preset and Save Hardware Preset commands in the CueMix FX file menu let you name, save and load presets in the 896mk3.

Peak/hold time

In CueMix FX, a peak indicator is a line (representing a virtual LED) displayed in a level meter that indicates the maximum signal level registered by the meter. The *Peak/hold time* setting (File menu) determines how long this indicator remains visible before it disappears (or begins to drop). To disable peak/hold indicators altogether, choose Off from this sub-menu.

Mix1 Return Includes Computer

The *Mix1 return includes computer* File menu item applies to other MOTU interfaces products and has no effect on the 896mk3.

Hardware follows CueMix Stereo Settings

This File menu item applies to other MOTU interfaces products and has no effect on the 896mk3.

Show meter in dock icon

This CueMix FX File menu item applies to other MOTU interfaces and has no effect on the 896mk3.

EDIT MENU

Undo/Redo

CueMix FX supports multiple undo/redo. This allows you to step backwards and forwards through your actions in the software.

Copying & pasting (duplicating) entire mixes

To copy and paste the settings from one mix to another:

- 1 Select the source mix (Figure 11-1) and choose Copy from the Edit menu (or press command-C).
- 2 Choose the destination mix and choose Paste from the Edit menu (or press command-V).

Clear Peaks

Choose *Clear Peaks* from the Edit menu to clear all peak indicators in all CueMix FX meters.

DEVICES MENU

If you are working with more than one MOTU audio interface product, this menu displays all interfaces that are currently on line. Choose any device from the menu to edit its settings using the CueMix FX software.

CONFIGURATIONS MENU

A configuration is just like a hardware preset (a “snapshot” of all settings in CueMix FX and therefore the 896mk3 hardware itself), except that it can be created and managed using the CueMix FX software on your computer, completely independently of the 896mk3 hardware. The commands in the Configurations menu let you create, save, load, import, export and otherwise manage as many configurations as you wish.

Here is a summary of Configurations menu operations:

Configurations Menu item	What it does
Create New	Lets you name and save a new configuration, which appears at the bottom of the Configurations menu.
Save	Overwrites the current configuration (checked in the list at the bottom of the menu) with the current settings in CueMix FX.
Save To	Same as Save above, except that it lets you first choose the configuration you wish to save to (instead of the current one).
Delete	Lets you choose a configuration to permanently remove from the menu.
Import	Loads all configurations from a configuration file on disk.
Export	Saves all current configurations as a file on disk.
Configuration list	Choose any configuration to load it. The current (last loaded or saved) configuration has a check mark next to it.

Modifying a configuration

The name of the current configuration is displayed in the CueMix FX window title bar. If you make any changes to the settings in CueMix FX, an asterisk appears in front of the name to remind you that the current state of CueMix FX doesn't match the saved configuration. If you wish to update the saved configuration with the new changes, use the Save command. To save the current state of CueMix FX to another configuration, use Save To. To save as a new, separate configuration, use Create New.

Saving a CueMix FX configuration as a hardware preset

To save a CueMix FX configuration as a hardware preset:

- 1 Choose the configuration from the Configurations menu to make it the current active configuration.
- 2 Choose *File menu*> *Save Hardware Preset*.

- 3 Type in a name, choose a preset slot and click OK.

Saving a hardware preset as a CueMix FX configuration

To save a hardware preset as a CueMix FX configuration:

- 1 Choose *File menu*> *Load Hardware Preset* to make it the current active preset.
- 2 Choose *Configuration menu*> *Create New* (or *Save To*) to save it as a configuration.

TALKBACK MENU

Choose the commands in the Talkback menu to engage or disengage Talkback or Listenback.

PHONES MENU

The Phones menu allows you to choose what you will hear on the headphone output, just like the Phones setting in MOTU Audio Setup. However, this menu provides one extra option that is exclusive to CueMix FX: *Follow Active Mix*. This menu item, when checked, causes the headphone output to mirror the output of the current mix being viewed in CueMix FX. For example, if you are currently viewing mix bus 3, the headphones will mirror the mix bus 3 output (whatever it is assigned to).

CONTROL SURFACES MENU

CueMix FX can be controlled from an automated control surface such as the Mackie Control™. Use the commands in the *Control Surfaces* menu to enable and configure this feature.

Application follows control surface

When checked, the *Application follows control surface* menu command makes the CueMix FX window scroll to the channel you are currently adjusting with the control surface, if the channel is not visible when you begin adjusting it. The same is true for the bus tabs: if you adjust a control in a bus

that is not currently being displayed, CueMix FX will jump to the appropriate tab to display the control you are adjusting.

Share surfaces with other applications

When the *Share surfaces with other applications* menu command is checked, CueMix FX releases the control surface when you switch to another application. This allows you to control your other software with the control surface. Here's a simple way to understand this mode: the control surface will always control the front-most application. Just bring the desired application to the front (make it the active application), and your control surface will control it. When you'd like to make changes to CueMix FX from the control surface, just bring CueMix FX to the front (make it the active application).

When this menu item is unchecked, your control surface will affect CueMix FX all the time, even when CueMix FX is not the front-most application. In addition, you will not be able to control other host audio software with the control surface at any time (because CueMix FX retains control over it at all times). This mode is useful when you do not need to use the control surface with any other software.

CueMix Control Surfaces

CueMix FX includes support for the following control surface products:

- Mackie Control™
- Mackie HUI™
- Mackie Baby HUI™

Use the sub-menu commands in the *CueMix Control Surfaces* menu item to turn on and configure control surface support, as described briefly below.

Enabled

Check this menu item to turn on control surface operation of CueMix FX. Uncheck it to turn off control surface support.

Configure...

Choose this menu item to configure your control surface product. Launch the on-line help for specific, detailed instructions on configuring CueMix FX for operation with your control surface product.

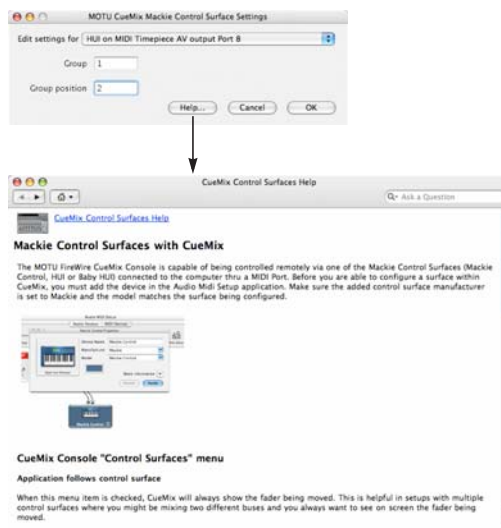

Figure 11-27: Refer to the extensive on-line help for details about configuring CueMix FX for operation with your control surface product.

Other HUI-compatible control surfaces

Any control surface that has the ability to emulate a HUI should be compatible with CueMix FX. Just add a Mackie HUI to Audio MIDI Setup and put the control surface hardware into HUI emulation mode. Consult the control surface manual for details about how put it into HUI emulation mode.

Other control surface hardware products

If you install other control surface drivers written for CueMix FX, they will appear as separate menu items at the bottom of the Control Surfaces menu, with the same sub-menu items described above.

CHAPTER 12 MOTU SMPTE Console

OVERVIEW

The 896mk3 can resolve directly to SMPTE time code via any analog input, without a separate synchronizer. The 896mk3 can also generate time code via its Time Code output. The 896mk3 provides a DSP-driven phase-lock engine with sophisticated filtering that provides fast lockup times and sub-frame accuracy. Direct time code synchronization is supported by AudioDesk and Digital Performer on Mac OS X.

MOTU SMPTE Setup	103
Clock/Address	103
Frame Rate	103
Reader section	104
Generator section	105
Setting up for SMPTE time code sync	105
Resolving DP or AudioDesk to SMPTE time code ...	105
Resolving Cubase or Nuendo to SMPTE time code..	106

MOTU SMPTE SETUP

The included MOTU SMPTE Setup™ software provides a complete set of tools to generate SMPTE for striping, regenerating or slaving other devices to the computer.

CLOCK/ADDRESS

The *Clock/Address* menu (Figure 12-1) provides the same global *Clock Source* setting as in MOTU Audio Setup (“Clock Source” on page 37), but it includes additional information: each setting shows both the clock and the address (time code or sample location), separated by a forward slash (/). To resolve the 896mk3 to SMPTE time code, choose the *SMPTE / SMPTE* setting in the *Clock/Address* menu. This means that the system will use SMPTE as the clock (time base) and SMPTE as the address.

FRAME RATE

This setting should be made to match the SMPTE time code frame rate of the time code that the system will be receiving. The 896mk3 can auto-

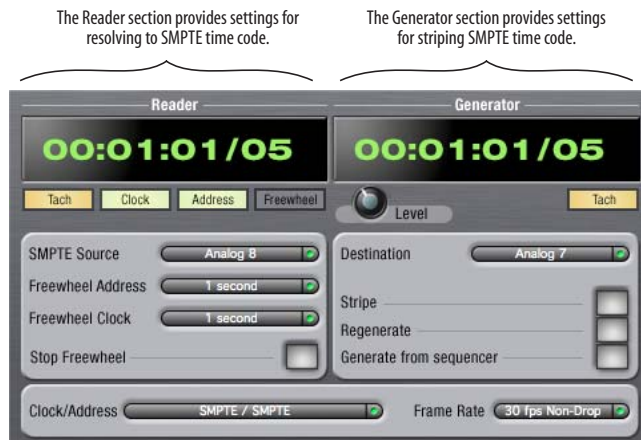

Figure 12-1: SMPTE Setup gives you access to your 896mk3's on-board SMPTE time code synchronization features.

detect and switch to the incoming frame rate, except that it cannot distinguish between 30 fps and 29.97 fps time code, or 23.976 and 24 fps time code. So if you are working with either of these rates, make sure you choose the correct rate from this menu. The 896mk3 driver updates the frame rate setting in Digital Performer and AudioDesk for you.

READER SECTION

The Reader section (on the left-hand side of the window in Figure 12-1) provides settings for synchronizing the 896mk3 to SMPTE time code.

Status lights

The four status lights (Tach, Clock, Address and Freewheel) give you feedback as follows.

Tach

The Tach light blinks once per second when the 896mk3 has successfully achieved lockup to SMPTE time code and SMPTE frame locations are being read.

Clock

The Clock light glows continuously when the 896mk3 has successfully achieved lockup to an external time base, such as SMPTE time code or the optical input.

Address

The Address light glows continuously when the 896mk3 has successfully achieved lockup to SMPTE time code.

Freewheel

The Freewheel light illuminates when the 896mk3 is freewheeling address (time code), clock or both. For details about Freewheeling, see “Freewheel Address” and “Freewheel clock” below.

SMPTE source

Choose the analog input that is connected to the time code source. This is the input that the 896mk3 “listens” to for time code.

Freewheel Address

Freewheeling occurs when there is a glitch or drop-out in the incoming time code for some reason. The 896mk3 can freewheel past the drop-out and then resume lockup again as soon as it receives readable time code. Choose the amount of time you would like the 896mk3 to freewheel before it gives up and stops altogether.

The 896mk3 cannot freewheel address without clock. Therefore, the *Freewheel Address* setting will always be lower than or equal to the *Freewheel Clock* setting, and both menus will update as needed, depending on what you choose.

Keep in mind that freewheeling causes the system to keep going for as long as the duration you choose from this menu, even when you stop time code intentionally. Therefore, if you are starting and stopping time code frequently (such as from the transports of a video deck), shorter freewheel times are better. On the other hand, if you are doing a one-pass transfer from tape that has bad time code, longer freewheel times will help you get past the problems in the time code.

The ‘Infinite’ freewheel setting

The *Infinite* freewheel setting in the *Freewheel Address* menu causes the 896mk3 to freewheel indefinitely, until it receives readable time code again. To make it stop, click the *Stop Freewheeling* button.

Freewheel clock

Freewheeling occurs when there is glitch or drop-out in the incoming SMPTE time code for some reason. The 896mk3 can freewheel past the drop-out and then resume lockup again as soon as it receives a stable, readable clock signal.

The 896mk3 cannot freewheel address without clock. Therefore, the *Freewheel Address* setting will always be lower than or equal to the *Freewheel Clock* setting, and both menus will update as needed, depending on what you choose.

The ‘Infinite’ freewheel setting

The *Infinite* freewheel setting in the *Freewheel Clock* menu causes the 896mk3 to freewheel indefinitely, until it receives readable time code again. To make it stop, click the *Stop Freewheeling* button.

Stop Freewheeling

The Stop Freewheeling button stops the system if it is currently freewheeling.

GENERATOR SECTION

The Generator section (on the right-hand side of the window in Figure 12-1) provides settings for generating SMPTE time code.

Level

Turn the level knob to adjust the volume of the SMPTE time code being generated by the 896mk3. The level knob disappears when the Destination is set to *None*.

Tach light

The Tach light blinks once per second when the 896mk3 is generating SMPTE time code.

Destination

In the *Destination* menu, choose either *SMPTE* (to generate time code) or *None* (to turn it off).

Stripe

Click this button to start or stop time code. To set the start time, click directly on the SMPTE time code display in the Generator section and type in the desired start time. Or drag vertically on the numbers.

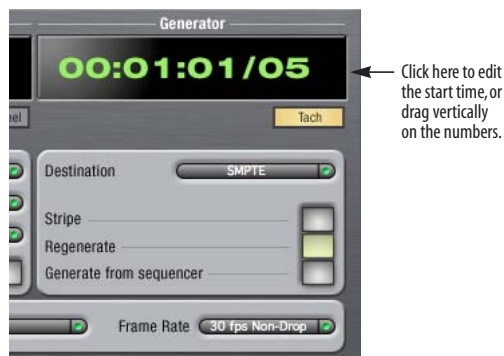

Figure 12-2: Setting the time code start time.

Regenerate

This option, when enabled, causes the generator to generate time code whenever the 896mk3 is receiving SMPTE time code.

Generate from sequencer

This option, when enabled, causes the generator to generate time code whenever you are running AudioDesk or Digital Performer. Time code begins at the time specified by the AudioDesk or Digital Performer main transport.

SETTING UP FOR SMPTE TIME CODE SYNC

To set up direct SMPTE time code synchronization, see “Syncing to SMPTE time code directly” on page 22.

RESOLVING DP OR AUDIODESK TO SMPTE TIME CODE

To resolve your Digital Performer/896mk3 system directly to SMPTE time code with no additional synchronization devices, use the setup shown in Figure 3-8 on page 22. Choose *Receive Sync* from the Setup menu and choose the *Sample accurate* option. Then make sure that the *Slave to External Sync* command in the Studio menu is checked. Make sure the *Clock Source* setting in the MOTU Audio Setup window is set to *SMPTE*. Also, make sure that you’ve connected an LTC input signal to the 896mk3 Time Code input, and that you’ve specified that input in the SMPTE Setup.

RESOLVING CUBASE OR NUENDO TO SMPTE TIME CODE

To resolve your 896mk3 and Cubase or Nuendo to SMPTE time code, use the setup shown in Figure 3-8 on page 22.

CHAPTER 13 Troubleshooting

Slaving directly to time code in AudioDesk or Digital Performer

To slave Digital Performer or AudioDesk directly to time code, be sure to go to the Receive Sync dialog in Digital Performer or AudioDesk and switch from “MTC” to “Sample-accurate.”

896mk3 inputs and outputs are not visible in Cubase

You probably need to enable them in Cubase.

Can't authenticate AudioDesk

When installing software off the CD-ROM, the OK button does not become active until you have entered in your name and a valid keycode. Your name must contain at least 3 characters, and you must enter the keycode exactly as it appears in your AudioDesk manual (on the inside of the back cover).

Clicks and pops under word clock sync

Many problems result from incorrect word clocking. It is essential that all digital devices in the system be word locked. Consult “Making sync connections” on page 21 for detailed information on how to word clock your gear. Whenever there is any weird noise or distortion, suspect incorrect word lock.

Clicks and pops due to hard drive problems

If you have checked your clock settings and you are still getting clicks and pops in your audio, you may have a drive related problem. Set your Clock Source to *Internal* and try recording just using the analog inputs and outputs of the 896mk3. If you encounter the same artifacts you may want try using another drive in your computer. Clicks and pops can also occur when the drive is severely fragmented, the disk drivers are outdated, or other drive-related issues. If you are using a FireWire

drive on the same bus as the 896mk3, it could be that the FireWire bus is overloaded (too many devices on the same bus). Try removing all devices except the 896mk3.

Connecting or powering gear during operation

It is not recommended that you connect/disconnect, or power on/off devices connected to the 896mk3 while recording or playing back audio. Doing so may cause a brief glitch in the audio.

No optical inputs or outputs are available in host audio application

Check to make sure you have the desired optical inputs and/or outputs enabled in the MOTU Audio Setup.

Monitoring - How to monitor inputs?

Please refer to the documentation for the audio application that you are using. If your application does not support input monitoring, you will need to use the 896mk3's hardware-based CueMix FX monitoring feature. Please see chapter 10, “Reducing Monitoring Latency” (page 69).

Controlling monitoring latency

See chapter 10, “Reducing Monitoring Latency” (page 69).

CUSTOMER SUPPORT

We are happy to provide customer support to our registered users. If you haven't already done so, please take a moment to register on line at motu.com, or fill out and mail the registration card included with your 8pre. Doing so entitles you to technical support and notices about new products and software updates.

REPLACING DISKS

If your 896mk3 software installer CD becomes damaged and fails to provide you with fresh, working copies of the software, our Customer Support Department will be glad to replace it. You can request a replacement disc by calling our business office at (617) 576-2760 and asking for the customer service department. In the meantime, you can download the latest drivers from www.motu.com.

TECHNICAL SUPPORT

If you are unable, with your dealer's help, to solve problems you encounter with the 896mk3 system, you may contact our technical support department in one of the following ways:

- Tech support hotline: (617) 576-3066 (Monday through Friday, 9 AM to 6 PM EST)
- Tech support 24-hour fax line: (617) 354-3068
- Online support: www.motu.com/support

Please provide the following information to help us solve your problem as quickly as possible:

- The serial number of the 896mk3 system. This is printed on a sticker placed on the bottom of the 896mk3 rack unit. You must be able to supply this number to receive technical support.
- A brief explanation of the problem, including the exact sequence of actions which cause it, and the contents of any error messages which appear on the screen.
- The pages in the manual which refer to the parts of the 896mk3 or AudioDesk with which you are having trouble.
- The version of your computer's operating system.

We're not able to solve every problem immediately, but a quick call to us may yield a suggestion for a problem which you might otherwise spend hours trying to track down.

If you have features or ideas you would like to see implemented, we'd like to hear from you. Please write to the 896mk3 Development Team, MOTU Inc., 1280 Massachusetts Avenue, Cambridge, MA 02138.

- 02R mixer 25
- 1394 connector 6, 12, 17
- 192kHz
 - multiple interfaces 31
 - operation 37
- 20 dB pad 12
- 2408mk3
 - Word Clock In setting 37
- 24-bit
 - AudioDesk 59
 - Digital Performer 55
 - optical 6, 11
 - recording 12
- 24i/o
 - Word Clock In setting 37
- 48V phantom power 12
- 828/828mkII
 - connecting to 896mk3 30
- 896HD
 - connecting to 896mk3 30
- 896mk3
 - connecting multiple interfaces 30
 - expansion 29
 - input/output summary 10
 - installing 17
 - rear panel overview 10
 - SMPTE setting 38
 - summary of features 9
- 896mk3 tab 36

A

- Ableton Live 63
- ADAT
 - metering 5
- ADAT IN/OUT LEDs 5
- ADAT lightpipe 25
- ADAT optical 6, 11
 - clock source setting 38
 - connecting 18
 - SMUX Type 47
- adjusting bus levels 5
- AES Out x 2 / AES Out ÷ 2 28, 40
- AES/EBU 6, 11
 - clock source setting 37
 - clocking 26
 - connecting to 19
 - metering 40
 - Meters 7
 - Out slave to AES in option 28, 40
 - synchronization 25
- Analog
 - input meters 5
 - input/output summary 10
 - inputs/outputs 6
 - making connections to 18
 - metering 12
 - out LED 5
 - output metering 5
- Analog inputs/outputs
 - trimming in AudioDesk 59
 - trimming in Digital Performer 55
- Apple

- GarageBand 63
- Logic Pro/Express 62
- Soundtrack Pro 63
- Application follows control surface 101
- Attack
 - compressor 93
- Audio menu (LCD) 47
- Audio Setup software 33
- AudioDesk 13, 33, 34, 57
 - accessing 828 settings 35
 - Main Out Assign 58
 - optical input/output 58
 - reverb return 59
 - synchronization 60

B

- Balance 79
- Balanced analog 18
- Buffer Size 54, 58
- Built-in Audio (clock source setting) 38
- Bus
 - activity LEDs 85, 95
 - fader 78

C

- Channel tab 84
 - reverb settings 85
- Clear Peaks 100
- Clip Hold Time 7, 40
- Clipping 5
- Clock
 - 192kHz operation 37
- Clock source 7, 21, 37
 - AudioDesk 58
 - other audio interfaces 38
 - SMPTE setting 38
- Clock status LEDs 5
- Coax 11
- Comp button 95
- Compressor 93
 - enabling 93
- Condenser mic input 5
- Configurations menu 100
- Configure Hardware Driver 35
- Configure interface 29
- Connecting multiple 896mk3s 29
- Control Surfaces menu 101
- Copy/Paste 100
- Core Audio
 - defined 33
- Cubase 35
 - Audio Buffer Size 64
 - clock source 61
 - Mac OS X 64
 - Main Out Assign 62
 - optical I/O 62
 - phones 62
 - Return Assign 62
 - reverb return 62
 - sample rate 61
 - syncing to time code 106
 - troubleshooting 107
- CueMix

- menu 47
- CueMix FX 5, 73, 75-102
 - Application follows control surface 101
 - AudioDesk 59
 - Configurations menu 100
 - control surfaces 102
 - Control Surfaces menu 101
 - CueMix control surfaces 102
 - Devices menu 100
 - Digital Performer 55
 - Edit Channel Names 7
 - Edit menu 100
 - File menu 100
 - focus 77
 - installation 76
 - Listenback explained 98
 - listenback settings 99
 - Mac OS X software 66
 - Mixer 43
 - output jacks 6, 18
 - overview 75, 77
 - Phones menu 101
 - Share surfaces with other applications 102
 - shortcuts 99
 - signal flow 80
 - stand-alone operation 76
 - Talkback menu 101
 - talkback settings 98, 99

Customer support 107

D

- Daisy-chaining 30
- DAT
 - connecting 20
- Default Stereo Input/Output 7, 39
- Devices menu 100
- Digital Performer 13, 53
 - accessing 828 settings 35
 - clock source 54
 - Main Out Assign 54
 - Optical input/output 54
 - phones 54
 - reverb return 55
 - sample rate 54
 - synchronization 56
- Disc
 - replacing 108
- Drivers
 - installing USB drivers 33
- DSP
 - meter 76, 98
 - resources 76, 98
- Dynamics
 - enabling 82, 93
 - graph 81
 - inputs 81
 - outputs 83
 - tab 93

E

Early reflections 97
Edit Channel Names 7
EQ

enabling 82, 87
filter types 88
frequency 88
gain 88
graph 81
inputs 81
outputs 83
Q 88
tab 86

Expansion 29

F

Factory defaults 47
Feedback loops 55, 59, 62
File menu

Clear Peaks 100
Copy/Paste 100
Hardware Follows CueMix Stereo
Settings 100
Load Hardware Preset 100
Mix1 return includes computer 100
Peak Hold Time 100
Save Hardware Preset 100
Show meter in dock icon 100
undo/redo 100

FireWire 12

connecting 17
connector 6

Focus 77

Inputs tab 81
Mixes tab 79
Outputs tab 83

Follow Active Mix 101

Foot pedal

connecting 19

Foot switch 12, 41

3rd party OS X software 67

AudioDesk 60

configuring 7

connecting 19

Digital Performer 56

jack 5

Force 1x word out rate 29

Force 44.1/48kHz 11

Freewheel

address 104

clock 104

infinite 104, 105

Frequency

EQ 88

Front panel 5, 43

G

Gain

EQ 88

reduction 93

reduction (Leveler) 95

GarageBand 63

clock source 61

Main Out Assign 62

optical I/O 62

phones 62

Return Assign 62

reverb return 62

sample rate 61

General tab 36

Generate from sequencer 105

GR (gain reduction) 93

Guitar

connecting 20

Guitar/mic inputs/connecting 18

H

Hardware Follows CueMix Stereo Settings
100

Hardware reset 47

HD192

Word Clock In setting 37

Headphone jack 5, 12

Headphone output 12

Headphones

connecting 20

controlling output 39

HUI 102

I

iMovie

audio input/output 39

In menu (LCD) 48

Infinite freewheel 104, 105

Input gain 12

Input level meters 5

Inputs

analog 6

naming 79, 80

optical 6

pan 79

reverb send 82

S/PDIF (RCA) 6

tab 80

trim 81

Installation

hardware 17

Installer CD

replacing 108

Internal (sync setting) 37

Invert phase 81

iTunes

audio input/output 39

L

Latency 69, 72, 76

lookahead 85

Launch MOTU Audio Setup when hard-
ware becomes available option
41

LCD

contrast 46

LCD display 45

LEDs 12

Level meter

bus 79

monitor group 98

Level meters

configuring 40

Leveler 93, 94

Lightpipe 25

2x mode 47

Limit button 95

Listenback

button (channel tab) 85

button (Outputs tab) 83

explained 98

Live 63

Load Hardware Preset 100

Logic Pro/Express 62

clock source 61

Main Out Assign 62

optical I/O 62

phones 62

Return Assign 62

reverb return 62

sample rate 61

Lookahead 85

M

M/S 84

Mac OS X 61

3rd party software sync 66

input and output names 64

sound input/output 7, 39

Mackie Control 102

Main Out Assign 39

AudioDesk 58

Digital Performer 54

Mac OS X audio software 62

Main outs 11

jacks 6

making connections to 18

metering 5

volume 5, 44

Makeup gain 95

Master fader

mix busses 78

Master volume 5, 44, 97

Metering 12

Metering options 40

Meters

knob 5, 12, 40, 45

monitor group 98

Meters tab 95

Mic inputs

connecting 20

phantom power 5

Mic preamps 10

Mic/guitar inputs 43

connecting 18

V-Limit 44

Mic/line inputs 18

Mid-side micing 84

Mix bus

activity LEDs 85, 95

level meter 79

master fader 78

mute 79

Mix1 return includes computer 100

- Mixes tab 78
- Monitor group 97
 - assigning outputs 97
 - assigning outputs to 83
 - level 97
 - meters 98
 - presets menu 98
- Monitor Level knob 5
- Monitoring 70
 - thru main outs 18
- Mono button 81
- MOTU Audio Setup 33, 35
- MOTU SMPTE Setup 103

N

- Naming
 - inputs 80
 - outputs 82
- Normal 84
- Nuendo 35
 - clock source 61
 - Mac OS X 64
 - Main Out Assign 62
 - optical I/O 62
 - phones 62
 - Return Assign 62
 - reverb return 62
 - sample rate 61
 - syncing to time code 106

O

- Optical
 - 2x mode 47
 - choosing format (ADAT or TOSlink) 39
 - connectors 6, 18
 - metering 40
 - overview 11
 - sync 25
- Optical converter mode 47
- Optimization 72
- OS X audio software
 - clock source 61
 - Main Out Assign 62
 - optical I/O 62
 - phones 62
 - Return Assign 62
 - reverb return 62
 - sample rate 61
- Output level (meter in Dynamics plug-in) 94
- Outputs
 - analog 6
 - dynamics 83
 - EQ 83
 - naming 82
 - optical 6
 - reverb send/return 83
 - S/PDIF (TOSLINK) 6
 - signal flow 82
 - tab 82
- Over LEDs 5
- Overload Protection 85

P

- Packing list 15
- Pad 12, 18
- Paste 100
- Patch thru
 - latency 72
- Peak Hold Time 7, 41, 100
- Peak mode 94
- Pedal 12, 19, 41
 - 3rd party OS X software 67
 - AudioDesk 60
 - configuring 7
 - Digital Performer 56
 - jack 5
- Performance 72
- Phantom power 5, 10, 12, 18
- Phase 81
- Phase-lock 21
- Phones 5, 39, 44, 65, 66
 - AudioDesk 58
 - Digital Performer 54
 - menu 101
- Phones 1-2 output
 - 3rd party software 62
 - AudioDesk 59
 - Digital Performer 55
- Pre/post FX buttons 85, 95
- PreDelay 97
- Presets
 - naming/saving in LCD 46
- Programmable meters 7, 40
- Propellerhead Reason 64
- Punch in/out 12

Q

- Q 88

R

- Ratio
 - compressor 93
- Reason 64
- Regenerate 105
- Registration 15
- Release
 - Dynamics 93
- Return Assign 39
 - AudioDesk 58
 - Digital Performer 54
 - Mac OS X audio software 62
- Reverb 77
 - design section 97
 - early reflections 97
 - enabling/disabling 96
 - input sends 82
 - mix bus send/return 78, 79
 - outputs send/return 83
 - predelay 97
 - returns 96
 - routing to/from 96
 - send (channel tab) 85
 - sends 96
 - shelf filter 97
 - tab 96

- time 97
- trim (channel tab) 85
- width 97

Reverb return 96

- AudioDesk 59
- Digital Performer 55
- OS X audio software 62

RMS mode 94

S

- S/MUX 47
- S/PDIF 11
 - clock source setting 37
 - connection 19
 - metering 40
 - optical 6, 11
 - RCA 6
 - sync 24
- Sample rate 7, 36
 - 192kHz operation 37
 - AudioDesk 58
 - LEDs 5
- Sample rate convert 7, 26, 40
- Samplers
 - connecting 20
- Save Hardware Preset 100
- Setup menu (LCD) 46
- Share surfaces with other applications 102
- Shelf Filter 97
- Shortcuts 99
- Show meter in dock icon 100
- Signal flow (CueMix FX mixer) 80
- SMPTE
 - overview 103
 - Setup application 103
 - source setting 104
 - sync 21, 22, 103
- Soft Clip 11, 44, 85
- Solo
 - light 79, 98
- Soundtrack Pro 63
 - clock source 61
 - Main Out Assign 62
 - optical I/O 62
 - phones 62
 - Return Assign 62
 - reverb return 62
 - sample rate 61
- Split Point 96
- Stand-alone operation 43, 52, 76
- Stereo button 81
- Stereo settings (Channel tab) 84
- Stop Freewheeling 104
- Stripe button 105
- Studio setup (example) 20
- Swap L/R 85
- Synchronization 21
 - AudioDesk 60
 - Digital Performer 56
 - Mac OS X software 66
 - multiple interfaces 29
- Synths
 - connecting 20

System preferences
 sound input/output 7, 39
System requirements
 minimum 15
 recommended computer 15

T

TACH
 light (SMPTE Setup Console) 104
Talkback
 button (Channel tab) 85
 button (Outputs tab) 83
 explained 98
 menu 99, 101
 settings 99
Technical support 107, 108
Threshold
 dynamics 93
Time code sync 22, 103
TOSLINK 6, 11
 clock source setting 38

 connecting 18
Trim 18, 81
Trim (input) 12
Troubleshooting
 EQ knobs don't work 82
 feedback loop 55, 59, 62
Type I, II optical mode 47

U

UltraLite
 connecting to 896mk3 30
Unbalanced analog 18
Undo/Redo 100
USB
 installing drivers 33
User def. (monitor group menu) 98

V

Video sync 21, 103
V-Limit 11, 44, 85
Volume
 headphone 12

 knob 12

W

Width 79
 knob 85
 reverb 97
Word clock 11, 21, 24, 28
 2x or one-half x 28
 connectors 6
 sync setting 37
 Synchronization
 word clock 30
Word Clock In setting 37
Word Out 40

X

XLR connectors 18

Y

Yamaha 02R mixer 25