

MANUAL NO. 993-040749-001

PRICE \$20.00

9.50



# Taurus

## Pedal Synthesizer

### OWNERS and SERVICE MANUAL

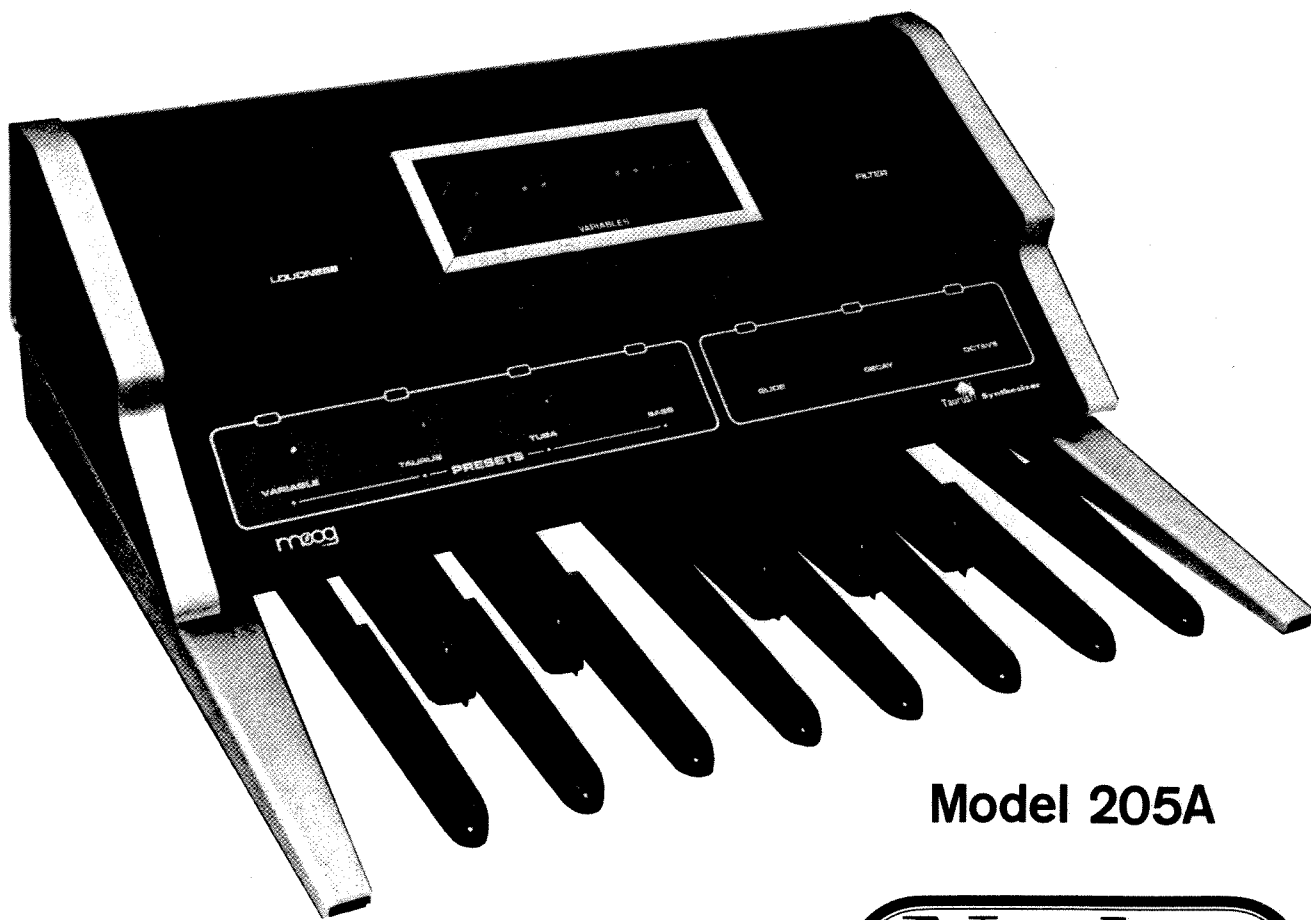

Model 205A

**Norlin**<sup>TM</sup>

NORLIN MUSIC  
(716) 681-7242

2500 Walden Ave.  
Buffalo, N.Y. 14225

# contents

Introduction .....	1
Description .....	1
Simplified block diagram .....	2
Specifications .....	4
Initial setup.....	5
Operating controls .....	6
Operation.....	8
Setting up variable preset .....	9
Maintenance and service .....	10
Technical section .....	11

THESE DRAWINGS AND SPECIFICATIONS ARE THE PROPERTY OF MOOG MUSIC INC. AND SHALL NOT BE REPRODUCED OR COPIED IN WHOLE OR IN PART AS THE BASIS FOR MANUFACTURE OR SALE OF THE ITEMS.

# Introduction

THE MOOG TAURUS IS A FOOT-CONTROLLED PEDAL SYNTHESIZER COMBINING THE FEATURES OF A SYNTHESIZER—GOOD SOUND AND VERSATILITY—WITH FOOT CONTROLLED SOUND MODIFIERS AND PRESETS.

THIS VERSATILE MUSICAL INSTRUMENT OFFERS THE CAPABILITY OF PRODUCING TRADITIONAL OR NEW SOUNDS, INSTANTLY SELECTABLE FROM THE FOOT-CONTROLLED PRESETS. ONE OF THESE PRESETS IS FULLY PROGRAMMABLE SO THAT THE PLAYER MAY SET UP A "SOUND" AND GET TO IT INSTANTLY.

TO PROVIDE MAXIMUM PROTECTION, THE UNIT IS ASSEMBLED IN A RUGGED WOOD AND METAL HOUSING.

## Description

The basic functions of the Taurus Synthesizer (see accompanying block diagram) are programmable. That is, values of the various parameters that are used to control the details of a sound are determined either by the internally fixed values (for the three fixed presets) or set by the player accessible controls (for the VARIABLE preset). In normal usage, the VARIABLE preset is set up prior to performance using the VARIABLES controls in the control box. During actual performance, the player selects one of the four presets instantly by depressing one of the four PRESETS foot-buttons. These four PRESETS are mutually exclusive, that is, only one preset may be ON at any one time.

The basic tone sources are two voltage controlled oscillators (A and B). Two basic pitch controls are used for fine tuning the instrument. First, the TUNE control is used to set the pitch of both oscillators to the desired reference, such as another instrument being used simultaneously. The BEAT control is used to make fine adjustments in the relative pitch of the two tone oscillators (by modifying the "B" tone source pitch). In addition to these basic tuning controls, the "B" tone oscillator pitch in the VARIABLE preset mode may be varied over a greater than one octave range by adjusting the OSC B FREQ control. The relative pitches of the two tone sources are internally set for the three fixed presets.

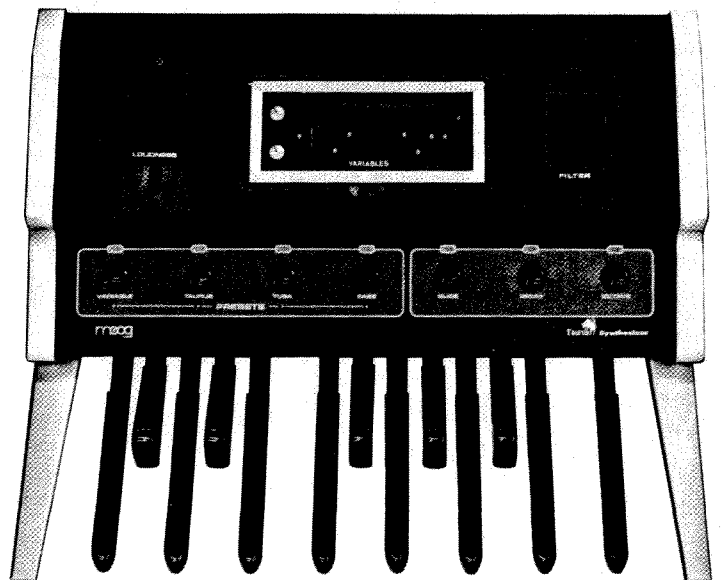

# Description contd

The entire instrument may be shifted either up or down one octave by use of the OCTAVE foot-button. As the OCTAVE foot-button is successively depressed, the instrument tuning changes by one octave; an indicator light shows that the instrument tuning is in high range. For the three fixed presets, the OCTAVE button switches the instrument between the 16' and 8' ranges. When the instrument is in the VARIABLE mode, a manual OCTAVE slide switch in the VARIABLES control box may be used to select three pitch range positions (LO-MED-HI). These three positions correspond to a 16' or 8' range for the LO position, an 8' or 4' range for the MED position, and a 4' or 2' range for the HI position. The "B" oscillator range extends to 1' with the OSC B FREQ control positioned all the way up.

## simplified block diagram

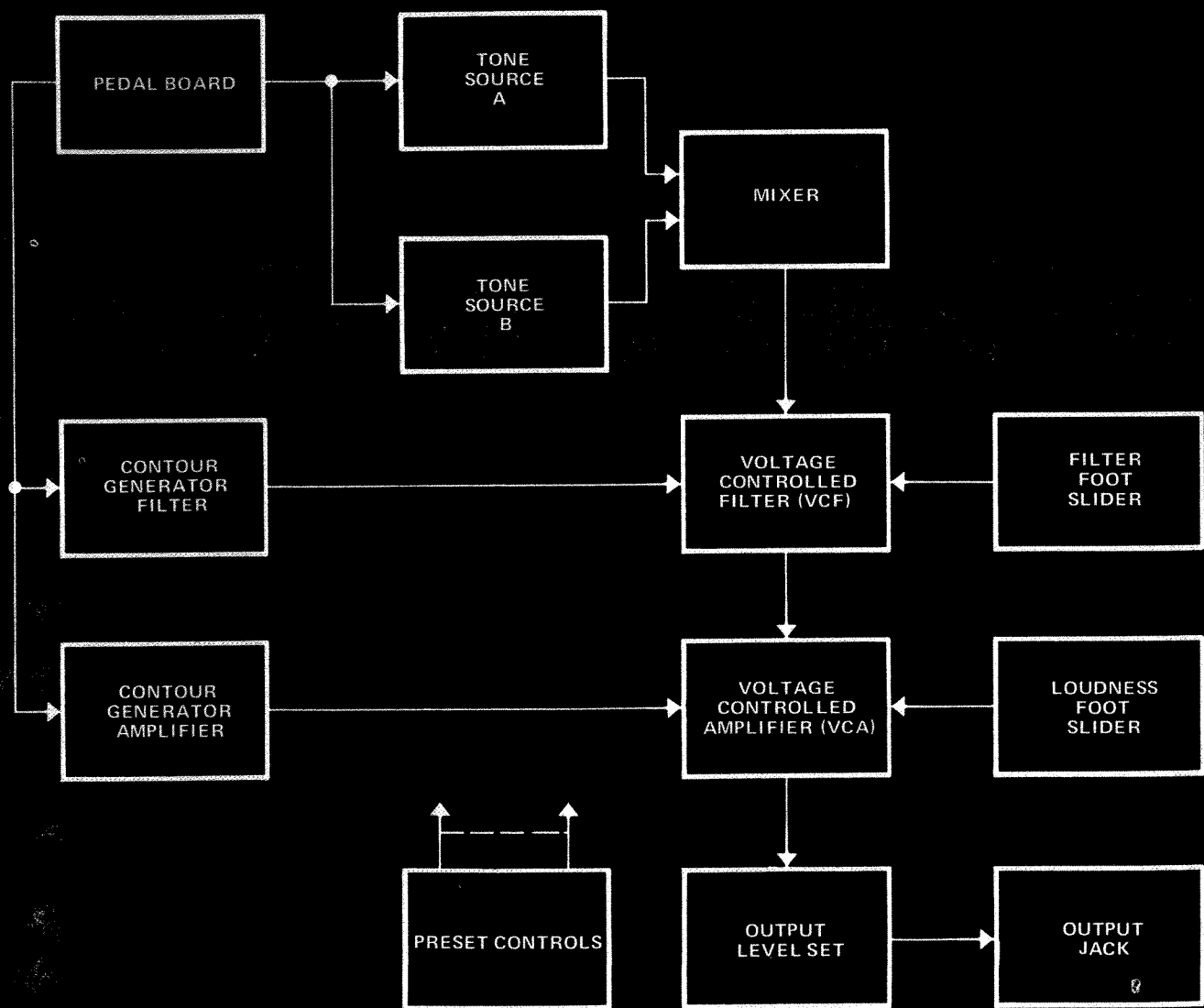

The instantaneous pitch of the instrument is controlled not only by the OCTAVE and fine tuning controls, but also by a GLIDE control and GLIDE foot-button. The glide effect is a smooth transition in pitch between successive notes. The GLIDE foot-button operates in a manner similar to the OCTAVE foot-button in that the glide effect can be alternately turned ON and OFF, the ON state indicated by the GLIDE light being ON. The amount of glide effect is determined by the GLIDE slider in the VARIABLES control box. The player may thus set up the amount of desired glide effect using the GLIDE slider and then use the GLIDE foot-button to switch the effect in or out.

The two tone sources are combined in different amounts in the mixer. In the three fixed presets the amounts are internally set, while in the VARIABLE MODE the relative amounts of the "A" and "B" tone sources appearing in the final output are determined by the B-MIX-A control in the VARIABLES control box.

The output of the mixer is applied to the voltage controlled filter which may be used to provide either dynamic or fixed timbre modification. Whenever a note is depressed, a filter contour signal is generated, successively opening and closing the filter. The amount of opening and closing the filter is determined by the CONTOUR AMOUNT slider. The rate at which the filter is opened is determined by the CONTOUR ATTACK control slider while the rate at which the filter is closed is determined by the CONTOUR DECAY slider. These contour controls determine the characteristics of the dynamic aspect of the filter function.

The effect of the filter is determined by the settings of the contour controls and by two other controls (CUT-OFF and EMPHASIS). The cutoff frequency is the filter characteristic which is "moved" by the contour signal. The initial cutoff frequency is determined by the FILTER foot-slider and by internally preset values for the three fixed presets. For the VARIABLE preset, this initial filter cutoff frequency is determined by the FILTER foot-slider and by the CUT-OFF control in the VARIABLES control box. For example, using the VARIABLE preset with the CONTOUR AMOUNT control set all the way down, the tone color may be changed but not dynamically, by either the FILTER foot-slider or the CUT-OFF slider.

The EMPHASIS control varies the amount of peaking of the filter. That is, the intensity of the frequency components of the tone generators which lay near the filter cutoff frequency is emphasized to a degree determined by the EMPHASIS control.

The output signal from the voltage controlled filter is applied to the voltage controlled amplifier (VCA). The VCA serves the function of "turning on and turning off" the sound. This articulation of the signal is caused by the VCA contour generator. The rate at which the sound is "turned on" is called the attack time. This attack time is internally set for the three fixed presets and is set by the ATTACK control in the VARIABLES control box for the VARIABLE preset. The sustained loudness of a preset is called the SUSTAIN LEVEL. The SUSTAIN LEVEL is determined by an internally preset value for the three fixed presets, and by the SUSTAIN LEVEL control for the VARIABLE preset. In addition, the overall loudness is determined by the LOUDNESS foot-slider. The manner in which the sound dies out or decays is determined by two functions. If the DECAY light is ON, the sound dies out at a rate determined by the DECAY control in the VARIABLES control box for the VARIABLE preset. If the DECAY light is OFF, the sound dies out immediately when the note is released (no decay).

The output of the VCA is applied to the OUTPUT LEVEL rotary control on the inset rear panel. The OUTPUT LEVEL control is used to match the signal level of the Taurus to the amplifier. Generally, the OUTPUT LEVEL control will be set so that the maximum desired loudness for any preset is achieved when both the LOUDNESS and the FILTER foot-sliders are in their uppermost positions. When using the TAURUS with a bass amplifier or similar musical instrument amplifier, plug the TAURUS into a high level amplifier input, and set the amplifier volume control one-third to one-half of the way up. Then set the OUTPUT LEVEL control on the Taurus rear panel for the desired volume range.

The Taurus may be operated using either a 115 or 230 volt line voltage.

# Specifications

## POWER REQUIREMENTS

- 95-130/190-260 VAC, 50-60 Hz, 9VA

## SIZE

- Length - 24-3/16 inches (592.7mm)
- Width - 19-7/8 inches (487.7mm)
- Height - 8-5/16 inches (203.9mm)

## WEIGHT

- 26 pounds (13 kg)

## OSCILLATORS

- Range A - 16' - 2'
- Range B - 16' - 1' (+10%, -10%)
- Stability -  $\pm 0.1\%$  short term (5 minute warm-up)  
 $\pm 0.3\%$  long term
- Waveshape - Sawtooth (both oscillators)
- Pitch Accuracy - Error less than  $\pm 2$  percent (0.12%)
- Glide Rate - 0 - 0.5 second time constant
- Fine Tune Range -  $\pm 8\%$

## FILTER

- Type - 24dB/octave (VCF)
- Emphasis (Peaking) - Flat to oscillation
- Foot Slider Control Range - 3 octaves
- Variable Preset Control Range - 7 octaves
- Contour Control Range - 7 octaves

## FILTER CONTOUR

- Attack Time - 5-56 msec (1 time-constant)
- Decay Time - 50 msec - 2.8 seconds (1 time-constant)

## LOUDNESS CONTOUR

- Attack Time - 5-560 msec (1 time-constant)
- Decay Time - 50 msec - 2.8 seconds (1 time-constant)

## POWER SUPPLY

- $\pm 15$  VDC, +5 VDC

## ACCESSORIES

- External VARIABLES control box is available from Moog Custom Engineering Services
- Viking road case

# Initial setup

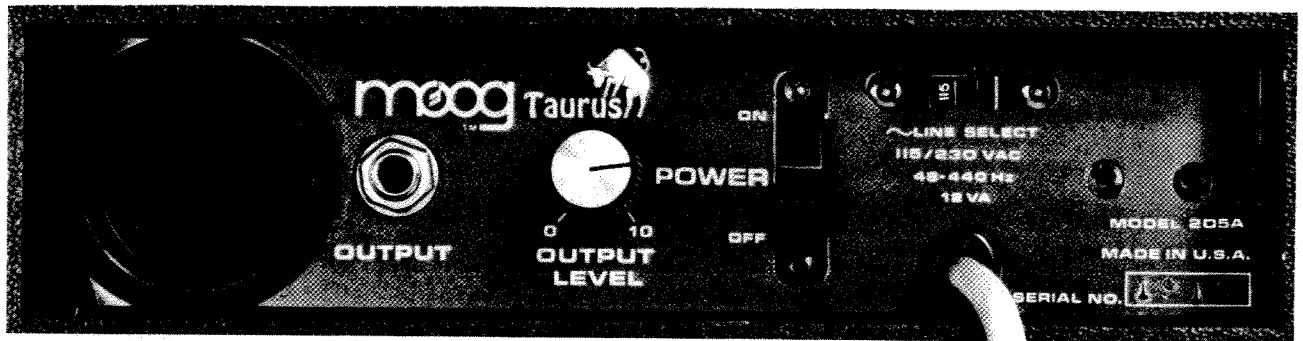

- Use a flat bladed screwdriver and set LINE SELECT 115/230 switch to match line voltage being used.
- Plug in power cable, connect audio OUTPUT jack to power amplifier input and place POWER switch on.
- Set OUTPUT LEVEL control to match output signal level to the particular power amplifier and speaker being used so that the loudest desired signal occurs with LOUDNESS foot-slider all the way up.
- Check operation of three fixed presets by depressing the relevant PRESET foot-buttons and playing the instrument. Turn OCTAVE, GLIDE, and DECAY foot-buttons off (lights OFF).
- Check operation of OCTAVE foot-button. Light ON is 8' range; light OFF is 16' range.
- Check operation of DECAY foot-button using TAURUS PRESET: long decay after note release will result when light is ON; no decay is present after note release when light is OFF.
- Check operation of GLIDE foot-button using TAURUS preset. Set GLIDE slider in VARIABLES control box to mid-position and note pitch glide effect when playing different notes in succession.
- Check operation of LOUDNESS and FILTER foot-sliders using TAURUS preset.

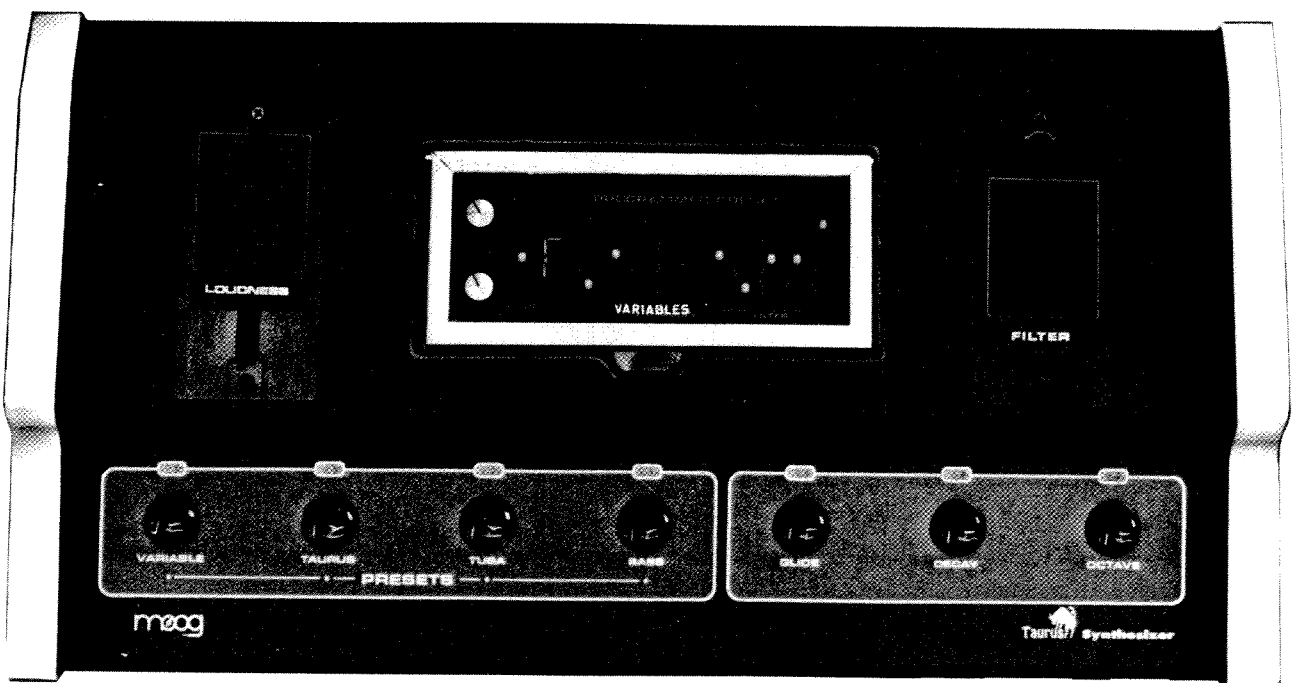

# Operating controls

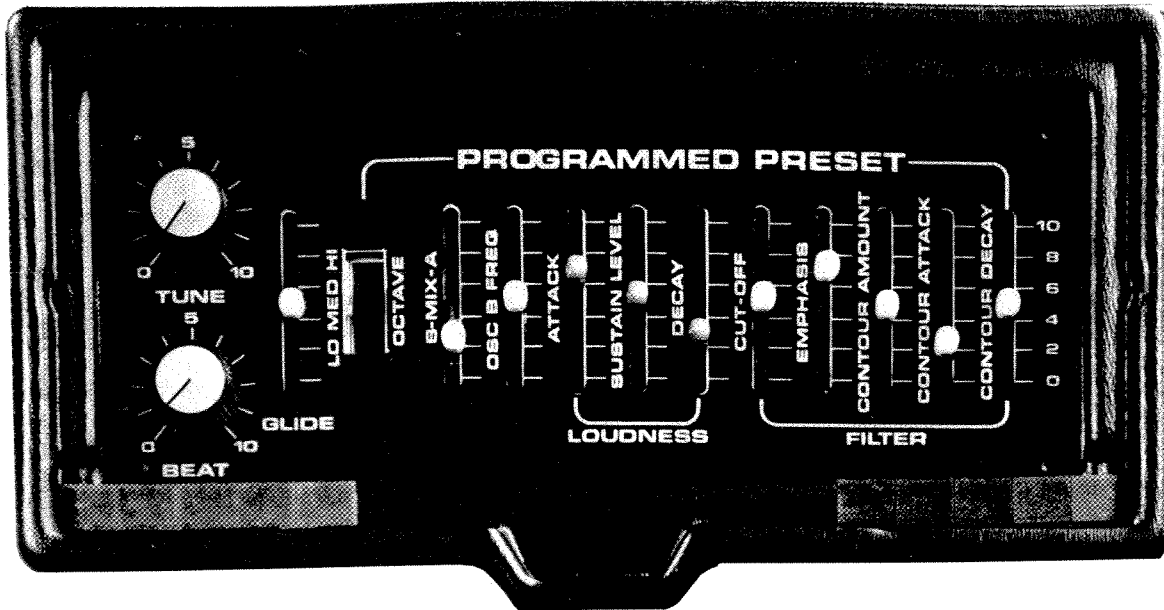

- PRESETS (4) . . . . . Momentary foot-button with electronic interlock (1 variable and 3 fixed)
- GLIDE (On-Off) . . . . . Momentary foot-button, toggle (alternate) on-off
- GLIDE (Amount) . . . . . Slider in VARIABLES control box
- DECAY (On-Off) . . . . . Momentary foot-button, toggle on-off
- OCTAVE . . . . . Momentary foot-button, toggle high-low
- FILTER . . . . . Brightness foot slider
- LOUDNESS . . . . . Foot slider
- Fine TUNE ( $\pm 1\text{-}1/2$  Semitones) . . . . . Rotary potentiometer in VARIABLES control box
- BEAT RATE ( $\pm 2\%$ ) . . . . . Rotary potentiometer in VARIABLES control box
- OUTPUT LEVEL Adjust . . . . . Rotary potentiometer on rear panel

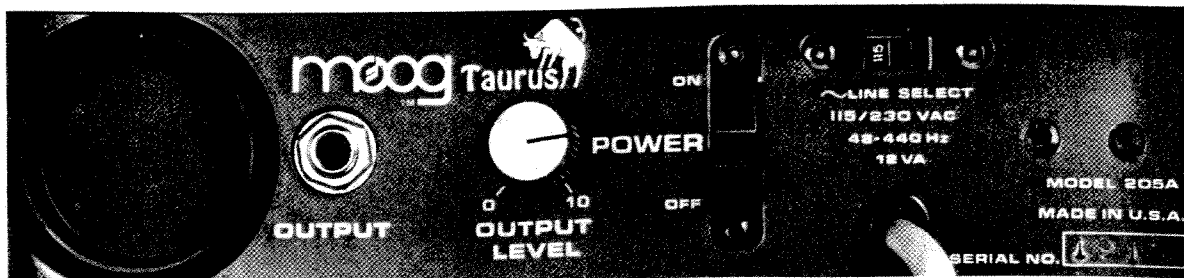



● PROGRAMMED PRESET Controls in VARIABLES Control Box

OCTAVE (LO-MED-HI) .....	3-Position slide switch
Oscillator B-MIX-A .....	Slide control
OSC B FREQ .....	Slide control
LOUDNESS ATTACK .....	Slide control
LOUDNESS DECAY .....	Slide control
FILTER CONTOUR ATTACK .....	Slide control
FILTER CONTOUR DECAY .....	Slide control
FILTER CONTOUR AMOUNT .....	Slide control
FILTER EMPHASIS .....	Slide control
FILTER CUT-OFF Frequency (Brightness) .....	Slide control
LOUDNESS SUSTAIN LEVEL .....	Slide control
● POWER (On-Off) .....	Rocker switch, rear panel
● 115/230 V LINE SELECT .....	Slide switch, rear panel

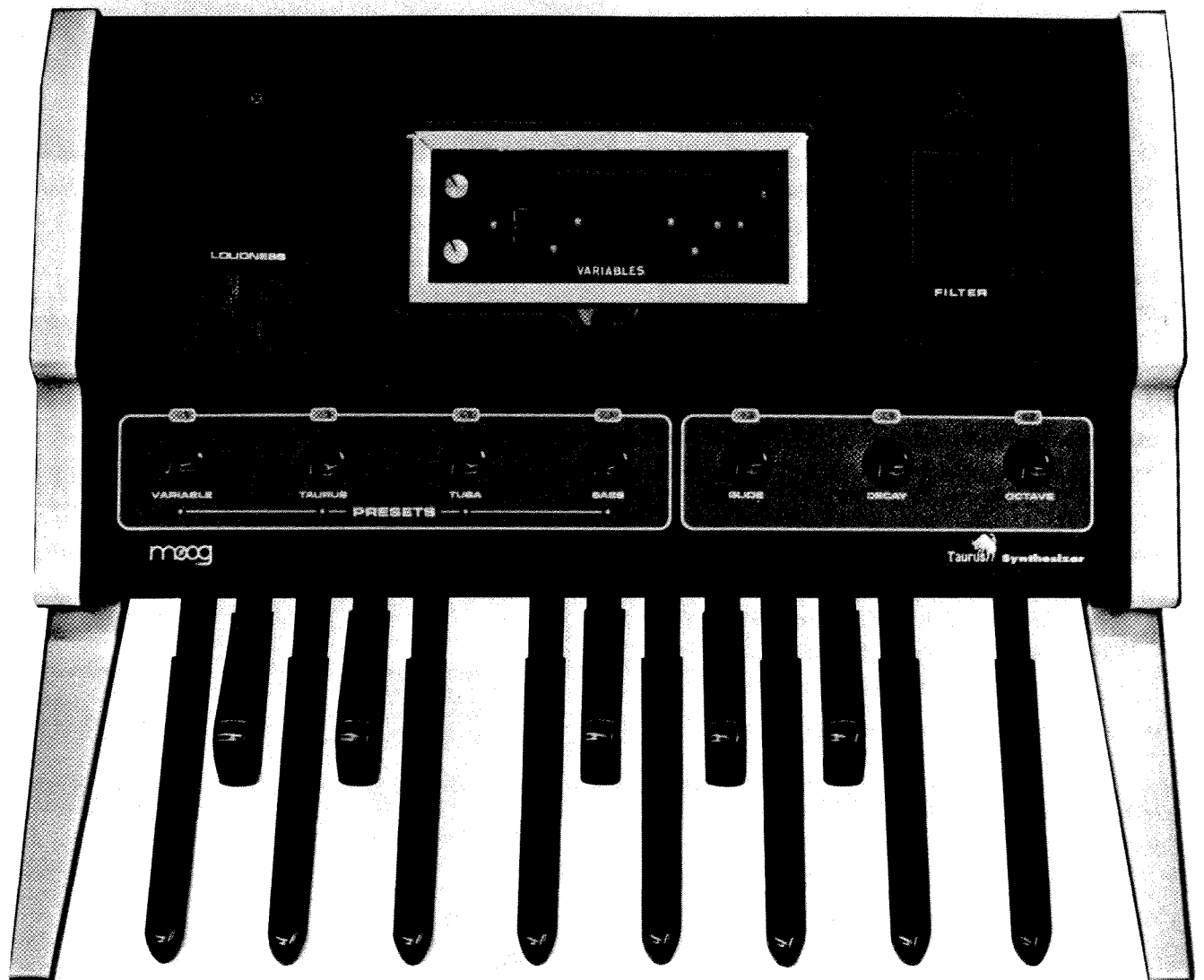

# Operation

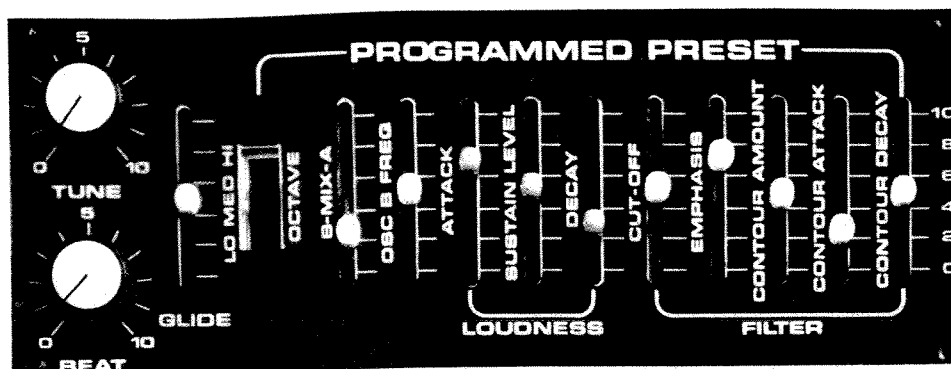

- Place the Taurus on a flat smooth surface.
- The tone sources are very pitch stable and will require tuning only if adjustments are required to tune to other instruments. Turn Taurus ON and fine tune using the TUNE control in the VARIABLES control box (use TUBA preset).
- Set desired beat rate of second oscillator using the BEAT control in VARIABLES control box (use TAURUS preset).
- Set desired amount of glide effect using GLIDE slider in VARIABLES control box.
- Set up VARIABLE PRESET to the desired sound and octave using the PROGRAMMED PRESET controls in VARIABLES control box. For details, see "Setting up the Variable Preset."
- Select desired preset using PRESET foot-button.
- GLIDE, DECAY, and OCTAVE selections may be switched using the relevant foot-buttons.
- FILTER and LOUDNESS may be varied using foot-sliders.

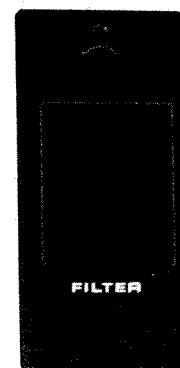
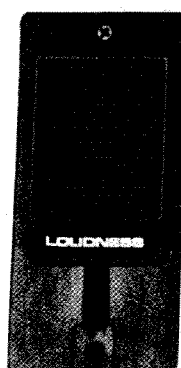
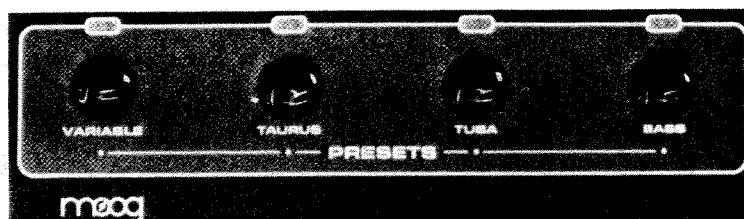

# Setting up variable preset

The VARIABLE PRESET is programmed using ten slide controls and one selector switch located in the VARIABLES control box. One basic procedure for setting up the VARIABLE PRESET is to proceed with the sound synthesis in the following manner.

- Set the controls as follows:

OCTAVE .....	Medium	CUT-OFF .....	Up
B-MIX-A .....	Center	EMPHASIS .....	Down
OSC B FREQ .....	Center	CONTOUR AMOUNT .....	Down
ATTACK .....	Down	CONTOUR ATTACK .....	Down
SUSTAIN LEVEL .....	Up	CONTOUR DECAY .....	Up
DECAY .....	Down		

- Choose the desired octave range by setting the OCTAVE switch to LO (16' - 8'), MED (8' - 4') or HI (4' - 2').

**NOTE: THE FOLLOWING STEPS SHOULD BE PERFORMED WHILE HOLDING DOWN A NOTE AND LISTENING TO THE SOUND.**

- Adjust the relative pitch of the two tone sources by adjusting the OSC B FREQ slider; with the slider all the way down the "B" oscillator will be about one-half step lower than the "A" oscillator, while with the slider all the way up, the "B" oscillator will be about one octave plus a half step above the "A" oscillator. (If the "B" oscillator is not used as determined in the next step, then this "B" tuning is not necessary.)
- Select the relative amount of the two oscillators using the B-MIX-A slider.
- Select the desired envelope shape using the three sliders subtitled LOUDNESS. With the ATTACK slider all the way down, a rapid attack is produced, while with the slider all the way up, a slow attack is produced. The SUSTAIN LEVEL control is used to balance the loudness level of the VARIABLE preset while the note is being held and should be left in the uppermost position until several later adjustments have been completed, at which time a final adjustment of this ATTACK slider may be desired. The DECAY slider is used to determine the rate at which a sound dies away when the pedal is released if the DECAY foot switch is on. With the DECAY slider all the way down, a very short decay results, while long decays occur with the slider up.
- Adjust the voltage controlled filter sliders subtitled, FILTER, to achieve the desired "timbre." First the CUT-OFF and EMPHASIS controls should be adjusted to achieve the basic desired tone color. At this point there will be no dynamic timbre changes. Dynamic timbre changes are accomplished via the CONTOUR AMOUNT, the CONTOUR ATTACK, and the CONTOUR DECAY. Dynamic filtering is initiated when a note is depressed. In order to observe this dynamic filtering, a note should be repeatedly depressed and released. After the cutoff frequency has been adjusted, put the CONTOUR AMOUNT slider all the way up, depress a note, and observe that the filter opens up and then closes down. (The DECAY slider may need to be in the UP position to observe this.) Set the three contour adjustments to achieve the desired amount of dynamic filter control, the desired attack of the dynamic filtering, and the desired decay of the dynamic filter.
- Adjust the SUSTAIN LEVEL to achieve relative balance of the VARIABLE preset with the other presets.

# Maintenance and Service

In general, the Taurus Foot-Pedal Synthesizer should require very little maintenance. The Taurus electronics have been designed with a fixed musical scale and, unlike most other synthesizers, it cannot be adjusted externally or internally. All necessary tuning controls are accessible to the player and, if for some reason the instrument cannot be tuned properly, an internal defect is indicated. There are no user serviceable parts inside.

Because there are no user serviceable parts inside, the unit should be returned to the factory or the nearest Moog dealer in its original shipping carton, or referred to qualified personnel for any service.

Any cleaning of the Taurus should be done with warm soapy water using a damp cloth. Care should be exercised to prevent any cleaning solution from entering the interior of the instrument. If any of the plastic foot-pedal caps should break, replacement caps are available.

**CAUTION: THE SERVICE INFORMATION PROVIDED IN THIS MANUAL IS FOR EMERGENCY SERVICE AS PERFORMED BY LOCAL COMPETENT TECHNICIANS. THE OWNER SHOULD NEVER ATTEMPT TO GAIN ENTRY INTO THE TAURUS OR SERIOUS SHOCK MAY RESULT.**

Depending on the atmospheric environment, the foot pedal electrical contacts may require cleaning on a periodic basis. If the instrument is used in areas where there is considerable smoke, these contacts may need cleaning every six months. Foot pedal electrical contact cleaning as performed by authorized service centers is accomplished using ethyl alcohol on cotton swabs and a soft typewriter eraser on heavily corroded areas.

# TECHNICAL SERVICE SECTION for

## **moog** TAURUS PEDAL SYNTHESIZER

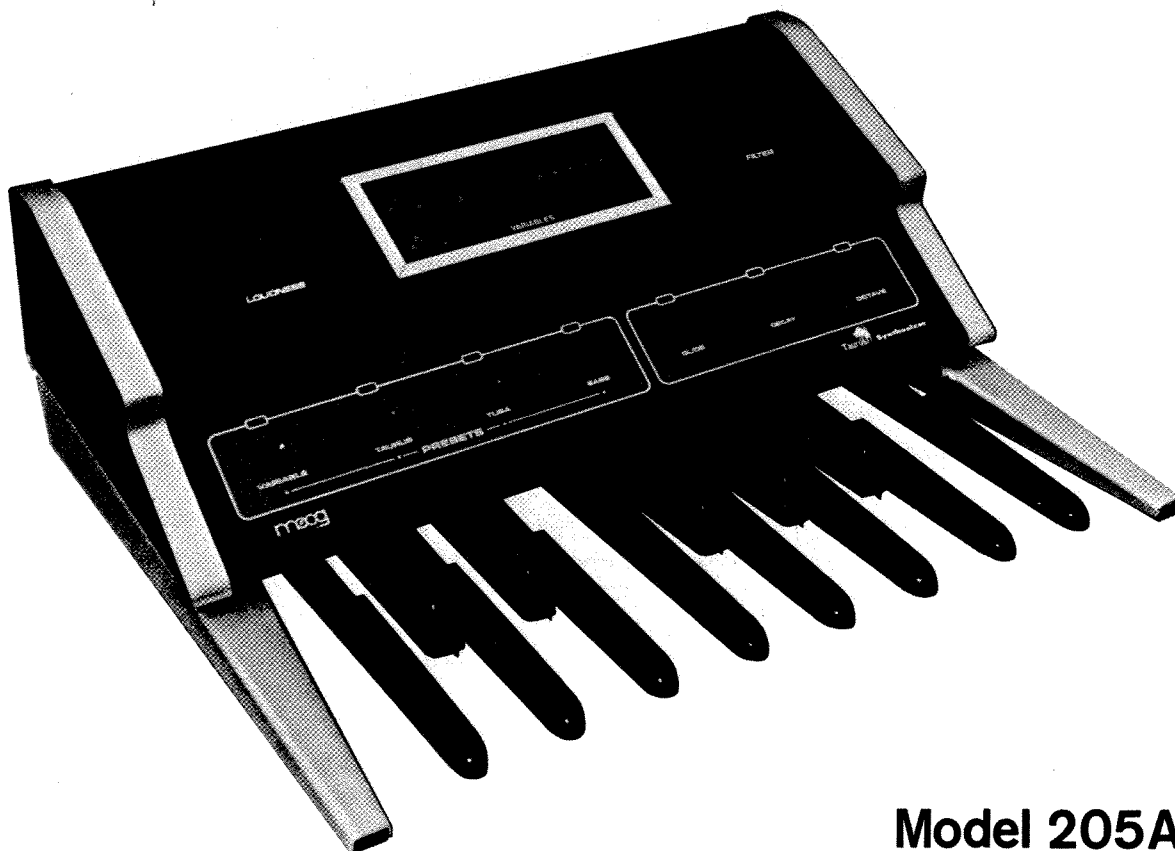

Model 205A

**Norlin**<sup>™</sup>

2500 Walden Ave.  
Buffalo, N.Y. 14225

NORLIN MUSIC  
(716) 681-7242

THESE DRAWINGS AND SPECIFICATIONS ARE THE PROPERTY  
OF MOOG MUSIC INC. AND SHALL NOT BE REPRODUCED OR  
COPIED IN WHOLE OR IN PART AS THE BASIS FOR MANUFAC-  
TURE OR SALE OF THE ITEMS.

COPYRIGHT — 1978  
MOOG MUSIC INC.

# CONTENTS

SECTION		PAGE NO.
1	INTRODUCTION AND CIRCUIT DESCRIPTION .....	15
	1.1 GENERAL .....	15
	1.2 CIRCUIT DESCRIPTION .....	15
	1.3 KEYBOARD .....	15
	1.3.1 Mechanical .....	15
	1.3.2 Electrical .....	15
	1.4 KEYBOARD CIRCUITRY .....	15
	1.4.1 Specifications .....	15
	1.4.2 Description .....	15
	1.5 LOUDNESS CONTOUR GENERATOR .....	17
	1.5.1 Specifications .....	17
	1.5.2 Description .....	17
	1.6 FILTER CONTOUR GENERATOR .....	19
	1.6.1 Specifications .....	19
	1.6.2 Description .....	19
	1.7 OSCILLATORS .....	19
	1.7.1 Specifications .....	19
	1.7.2 Description .....	19
	1.8 FILTER .....	21
	1.8.1 Specifications .....	21
	1.8.2 Description .....	21
	1.9 LOUDNESS MODULATOR (VCA) .....	23
	1.9.1 Specifications .....	23
	1.9.2 Description .....	23
	1.10 CONTROL CIRCUITRY .....	23
	1.10.1 Description .....	23
	1.10.2 Preset Control .....	23
	1.10.3 Octave Control .....	24
	1.10.4 Decay Control .....	25
	1.10.5 Glide Control .....	25
	1.10.6 External Accessory Control .....	25
	1.11 POWER SUPPLY .....	25
	1.11.1 Specifications .....	25
	1.11.2 Description .....	26
2	QUICK REFERENCE TROUBLE ANALYSIS GUIDE .....	28
3	DISASSEMBLY .....	29
	3.1 HOUSING DISASSEMBLY .....	29
	3.2 PRINTED CIRCUIT BOARD DISASSEMBLY .....	29
	3.3 PRINTED CIRCUIT BOARD REASSEMBLY .....	30
	3.4 FOOT PEDAL CONTACT REMOVAL .....	30
	3.5 VARIABLES CONTROL COVER REMOVAL .....	31
4	TUNING AND ADJUSTMENTS .....	32
	4.1 GENERAL .....	32
	4.2 SCALE ADJUSTMENT .....	32

## CONTENTS (Continued)

SECTION		PAGE NO.
4	4.3 FET BALANCE (OCTAVE TUNING) .....	33
	4.4 OSCILLATOR "A" TUNING .....	33
	4.5 OSCILLATOR "B" TUNING .....	33
	4.6 FILTER TUNING .....	34
	4.7 VCA TUNING .....	34
5	REPLACEMENT PARTS LIST .....	35
	5.1 ORDERING .....	35
6	MODIFICATIONS .....	41
	6.1 MAIN PRINTED CIRCUIT BOARD .....	41
	6.1.1 Mounting .....	41
	6.1.2 Potentiometer Replacements .....	41
7	SCHEMATIC DIAGRAMS AND PRINTED CIRCUIT BOARDS .....	43

## LIST OF ILLUSTRATIONS

FIGURE		PAGE NO.
1-1	Simplified Block Diagram .....	27
3-1	Taurus with Foot Pedal and Shell Housing Separated .....	29
3-2	Bottom View .....	30
3-3	Programmed Preset Cover .....	31
4-1	Rear Panel .....	32
4-2	Front Panel .....	33
4-3	Front Panel Variables Control .....	34
6-1	Potentiometer Replacements .....	42
7-1	Power Supply Printed Circuit Board .....	43
7-2	Power Supply Schematic Diagram .....	43
7-3	Overall Printed Circuit Board .....	44
7-4	Overall Schematic Diagram .....	45,46
7-5	Matching Transistor Circuits .....	47



# SECTION 1

## INTRODUCTION AND CIRCUIT DESCRIPTION

### 1.1 GENERAL

This portion of the manual (for use by qualified service personnel), Sections 1 through 7, provides servicing and parts information for the Taurus Pedal Synthesizer, Model 205A, manufactured by Moog Music Inc., 2500 Walden Avenue, Buffalo, New York 14225.

Section 1 provides an introduction and an overall circuit description; Section 2, troubleshooting guide which isolates trouble to a specific part; Section 3, gives a step-by-step procedure for housing disassembly and removal and replacement of the main printed circuit board; Section 4, internal and external tuning and adjustment procedures; Section 5, replacement parts list; Section 6, schematic diagrams and printed circuit board component location diagrams.

### 1.2 CIRCUIT DESCRIPTION

(Refer to Figure 4-1)

### 1.3 KEYBOARD

#### 1.3.1 MECHANICAL

13 Note Pedalboard, "Z" Switching Configuration.

#### 1.3.2 ELECTRICAL

Contacts - Precious metal, plated.

Circuit - Connectable in "Z" pattern, low note priority. When lower note is depressed, upper buss section is isolated and lowest note is connected to keyboard resistor string.

### 1.4 KEYBOARD CIRCUITRY

#### 1.4.1 SPECIFICATIONS

Voltage output of keyboard circuitry is proportional to  $V+$  and control voltage range is 600mV to 12V. Control voltage linearity is  $\pm 1\text{mV}$  or 0.1%, whichever is greater, for the octave switch stops. Control voltage accuracy for all notes within the octave is  $\pm 3\%$ . Sample and Hold charging time constant is less than 0.2 msec. Sample and Hold drift rate is less than 1mV per second. Total offset of the keyboard circuit is less than  $\pm 2\text{mV}$ .

#### 1.4.2 DESCRIPTION

The keyboard circuit provides two control voltages, namely, the oscillator control voltage and the trigger signal. The keyboard voltage is generated by an octave divider consisting of resistors R101 through R112, which drives a note divider chain comprised of resistors R118 through R131. The octave divider consists of a series string of resistors whose ratio, starting from the bottom, is 1-1-2-4-4. The positive supply potential is applied to the top of this divider chain resulting in a potential of approximately 10V at the junction of R108 and R109. This 10V potential in connection with the highest frequency to be produced by oscillator A (526Hz) determines the basic keyboard scale factor which is approximately 23mV per cycle. The voltage taps corresponding to the four octave ranges (16' through 2') are applied to the analog multiplexer IC103, which routes the selected octave control voltage to the voltage follower A101 via R114. The voltage follower A101 prevents loading of the octave divider chain by the note divider chain. R114 provides an AC impedance block for the high frequency carrier signal, which is applied to the keyboard buss via the note divider chain, when a note is depressed. R115 provides correction for input bias current change. The buffered octave voltage appearing at the output of A101 is applied to the note divider chain which

consists of a series of resistors whose ratios are  $12\sqrt{2}$  except for the resistance R130 and R131, which is equal to the sum of resistances R118 through R129. Thus, the voltage at the top of the chain is twice that appearing at the junction of R129 and R130, providing an octave of control voltage. R131 provides a trim adjust to provide the aforementioned equality (to within 0.1%). The tolerances of the individual resistors R118 through R130 is  $\pm 0.5\%$ . The selection of the desired octave control voltage via IC103 is accomplished with the control lines labeled 2' through 16', which are driven by digital circuitry to be explained later. R113 provides isolation for the CMOS circuit IC103, so that if this pack becomes internally shorted (to ground), a means will be available for determining whether this particular CMOS package or some other one has failed. If this resistor were not here (as would be the case for the other CMOS 4016 packs), then any failure of a 4016 pack would reduce the supply potential to all CMOS packs equally and there would be no way of knowing which pack had failed without removing the packs one at a time.

The high frequency carrier signal used for trigger generation is generated by CMOS gates G1 and G2 in IC104. These two gates, in conjunction with C102 and R116, comprise a conventional multivibrator whose frequency is approximately 35kHz. C101 provides decoupling of the positive supply potential. The 35kHz carrier is applied to the note divider driver A101 via C103 and R117. C104 rolls off the high frequency components of the square wave carrier signal. The carrier level (15V p-p) at the output of the multivibrator is divided down by R117 and R114 in series with the octave divider impedance (approximately 1K) so that the amplitude of the carrier signal appearing at the output of A101 is about 300mV. This carrier signal is also shunted to the center and the lower end of the note divider chain via C105 and C106, so that the carrier signal finally seen by the detector amplifier when a pedal is depressed does not vary more than a factor of 30%.

When a pedal is depressed on KB101, the buss is broken for all pedal notes higher than the one depressed and the remaining continuous buss is connected to the desired point of the note divider chain. This buss then carries the oscillator control voltage,

proportional to frequency, and the high frequency carrier signal used to generate a trigger signal.

If more than a single octave (+1 note) is desired for this type of exponential keyboard, the tap at the junction of R129 and R130 can be applied to a buffer amplifier which would in turn drive a note divider chain identical to the original one. In this fashion, any number of octaves can be derived by successive tandem connections. The note divider chain consisting of R118 through R130 is a special single cermet resistor dip package, which will provide a high degree of temperature tracking of the note divider resistances. Since these resistors are in a voltage divider configuration, changes in their absolute value will not generate errors as long as they track.

The keyboard buss signal is applied to the trigger generator, consisting of amplifier A102 and gate G3 plus associated circuitry, and to the keyboard sample and hold and glide section, consisting of IC106, C101, A103A and associated circuitry. The output of these two sections provide the basic keyboard control signals, namely, the trigger signal and the frequency control signal. The addition of C107 to the buss prevents pickup of the 35kHz while none of the keys are depressed.

The trigger section consists of a single amplifier (OTA) A102 driven from the keyboard buss which acts as an amplifier and a charge pump for a capacitor which in turn drives the CMOS gate G3. Capacitor C109 decouples the positive supply potential from the 3080 to prevent 35kHz spikes from appearing on the supply line which could cause audio oscillator synchronization. The high frequency carrier on the keyboard buss is coupled to the negative input of A102 via R132 and C108. R132, in conjunction with CR101 and CR102, provides protection for the 3080 against transients which could damage the input stages of A102. C108 couples only high frequency signals to A102 and blocks the static keyboard voltage (which would imbalance A102). The positive input of the A102 is biased at +5 VDC by R135 and R136 with bypass capacitor C111 while the negative input is biased at +5 VDC minus a potential of 14mV by R133 and R134. The output of A102 is coupled to the charging capacitor C110 via diode CR103.

When there is no carrier signal applied to the negative input of A102, the output of A102 is essentially V+ since the load resistance presented by CR103 to ground is essentially infinite. A102 is operated at a bias current of approximately 0.4mA, determined by resistor R138. Thus, with no carrier signal applied to the negative input of A102, the output of A102 is a potential of V+ and the signal applied to G3 through G4 via CR103 is approximately V+ because of the pull-up resistor R139. When a high frequency signal is applied to the negative input of A102, the output of A102 swings negative, supplying charge to C110. CR103, C110 and R139 act as a conventional detector with a time constant of 2msec, which is approximately 70 carrier time constants. In this case, the signal applied to G3 and G4 is approximately 1V (rather than 0) because of the drop across CR103 and output stage of A102 which is enough to fully switch the CMOS gates G3 and G4. When the input to G3 goes negative, the output of G3 goes from 0 to V+. This output is the trigger signal. The second input to G3 via R141 from P4-7 provides an external S-trigger input port. R140 provides pull up to the gate input to allow G3 to operate properly in the absence of an external S-trigger input.

The keyboard buss signal is applied to the glide potentiometer R142 via the CMOS gate protection resistor R137. This glide potentiometer feeds the keyboard buss signal to the Sample and Hold capacitor C112 via gate T2 and gate T4, IC106. Gate T2 is used to open up the Sample and Hold capacitor feed when an external accessory glide potentiometer is to be used. This external potentiometer, when used, feeds the Sample and Hold capacitor via gate T3, IC106. Gate T4 is driven by the trigger signal generated by G3 which provides isolation against leakage via the attached keyboard buss. When a note is depressed, the trigger signal goes on, turning on gate T4, IC106, which connects the keyboard buss to the Sample and Hold capacitor C112 via the glide potentiometer (or the bypass gate T1, IC106). Gate T1, IC106 provides a signal path to bypass either the internal or external glide potentiometers. This glide bypass gate is controlled by a foot switch and its associated digital logic to be explained later. Thus, with glide on, the buss signal is applied via R137 and R142, gate T2 and gate T4. With glide off, the signal path is via R137, gate T1 and gate T4. The charging

time constant of the Sample and Hold is determined by the impedance at the contacted point of the note divider chain in series with R137 (R142, if glide is on) T1 and T4. The worst case series impedance of the note divider chain occurs at the junction of R129 and R130 with a value of 25K. This resistance in series with the other resistances presents a total worst case charging path resistance of approximately 12K, giving a charge time constant of about 1.2msec.

The voltage appearing on C112 is applied to the dual FET pair Q101, which in conjunction with A103A, R144 and R146 comprise a high input impedance voltage follower. R146 provides a means of compensating the FET pair imbalance by varying the ratio of the currents in the two FETs. The worst case drift of the voltage on C112 is determined by leakage through gate T4, IC106 and the input gate current to Q101. This value is approximately 100pA. This results in a worst case drift of 1mV per second which results in a 1/23Hz per second drift, for oscillator A. The output of A103A is the keyboard control voltage.

## 1.5 LOUDNESS CONTOUR GENERATOR

### 1.5.1 SPECIFICATIONS

Maximum Output	12 ± 1V peak
Attack Time	5 to 560 msec ± 40%
Decay Time	50 msec to 2.8 seconds ± 30%

### 1.5.2 DESCRIPTION

The trigger signal appearing on the output of G3 is applied to the Darlington transistor, Q201, which provides current drive to charge the contour capacitor C201. The input to the Darlington is a 0 to V+ step (15VDC). The output of the drive Darlington Q201 is applied to the contour capacitor C201 via a voltage divider, a series attack control resistor, a diode, one of the CMOS gates in IC201, and a protection resistor, R215. The selection of a particular network for the charging path is determined by the preset control lines A, B, C and D, which are driven by digital control circuitry that determines which of

the presets A, B, C, or D, is active. Only one of the control lines A, B, C or D is active (on) at any particular time and thus, only one of the four analog switch gates in IC201 is on at a time. The A preset is the so called programmable preset in which parameters for a number of functions are controlled by slide potentiometers. In particular, we consider the case where the A preset is on, turning on Gate T1 in IC201. When Q201 is driven positive by a trigger signal, a fraction of the trigger signal determined by the setting of R202 is fed to the attack resistor R201. This trigger signal charges C201 via CR201 and gate T1 of IC201. The diodes CR201 through CR208 provide isolation between the various attack and decay sections in the following manner. When the anode (and cathode) of CR201 goes positive, CR202 also goes positive pulling up the junction of resistors R209 through R213. If, for example, gate T1 in IC201 is active and the contour capacitor C201 is being charged via R201 and CR201, diode CR202 prevents charging current from flowing through diodes CR203 through CR208 and R210 through R212, then back through R209. Resistors R202 through R208 determine the various preset loudnesses. R202 is a continuous panel adjustment for the programmable preset.

When the trigger signal goes positive, transistor Q203 is turned off, (base pulled positive) which eliminates any discharge current from flowing out of the contour capacitor C201 through R215, the relevant gate in IC201 and CR202, R209, R213, CR209 and Q203. The attack time for the programmable preset is determined by R201 whose maximum resistance value gives an attack time constant of 0.56 seconds. The attack time for the remaining presets, B, C and D, is determined by the parallel resistance of the loudness contour amount divider. For example, the attack time for preset B is determined by the parallel resistance of R203 and R204. Since there is no discharge path as long as there is a trigger, there is always "key sustain".

When the trigger signal at gate G3, IC104 goes off (ground), the emitter of Q201 goes to ground and diodes CR203, CR205 and CR207 become reverse biased. At the same time, the return of the trigger signal to ground pulls the emitter of Q203 to one

diode drop above ground. The contour capacitor C201 can now discharge toward ground through the path R215, a gate in IC201, CR202, R209, R213 and CR209. This discharge path contains three diode drops (including  $V_{BE}$  of Q203) which compensate for the buffer and current converter transistor diode drops which follow the contour capacitor C201. These three diode drops in the follower consist of the two diode drops in Q202 and the diode drop in the current converter transistor Q301. The discharge path, outlined above, contains the "minimum decay time" resistor R213, whose value is 10K, allowing a minimum decay time of about 56msec. The discharge paths for presets B, C and D occur through diodes CR204, CR206, CR208 and resistors R210 through R212. In addition to the discharge paths described above, there is another return path for current to override the first path. This path is via R216 and CR210 and gate G4 in IC104. This path is the "no decay" path which is active when both inputs to G4 are positive, namely, if the trigger and the "no decay" line come from G34 in IC904. The value of R216 sets a "no decay" time constant to about 56msec. When the decay is on, the output of G34 in IC904 is off (ground) which holds the output of G4 positive which in turn causes CR210 to be reversed biased eliminating any current flow through this path.

Thus, the voltage appearing on the contour capacitor C201 goes to some positive potential above ground and then decays to within three diode drops of ground after key release. This voltage is followed by the Darlington buffer Q202 which drives the voltage to current converter, driving the resistor string comprised of R301 and the foot controlled loudness slider R302. Thus, the current supplied to the emitter of the current source transistor Q301 is proportional to the product of the loudness contour voltage appearing on the capacitor C201 and the conductance of the loudness control R302. The ratio of R301 to R302 determines the loudness control range which, in this case, is 18dB. The maximum contour voltage appearing at the top of R301 is equal to the trigger signal drive voltage ( $V_+$ ) minus five diode drops or approximately 12.5V. There is another diode drop in Q301 which sets the maximum current delivered to the emitter Q301 to about 0.8mA. The current converter transistor Q301

delivers its output collector current to the loudness modulator A301 via R308. Capacitor C302 prevents spurious high frequency signals from coupling into the current drive applied to A301. Resistor R215 limits the maximum charge current which must be handled by the gates of IC201 to prevent possible gate damage.

## 1.6 FILTER CONTOUR GENERATOR

### 1.6.1 SPECIFICATIONS

Maximum Output:	12 ± 1V peak
Attack Time:	5 to 56 msec ± 40%
Decay Time:	50 msec to 2.8 seconds ± 40%
Filter Contour Range:	7 octaves

### 1.6.2 DESCRIPTION

The trigger signal appearing at the output of G3 is dynamically coupled to the Darlington transistor Q401 via C401 and R401. This dynamic coupling provides a non-sustain filter contour. The time constant of 100msec, provided by the drive network C401 and R401, is sufficiently long to allow the contour capacitor C402 to reach nearly full level even when the attack time constant is set to its maximum value of 56msec. The resistors R402 through R410 and diodes CR401 through CR409 serve exactly the same function as resistors R201 through R213 and diodes CR201 through CR209 in the loudness contour generator. This is also true for IC401, R416, C402 and Q402 versus IC201, R215, C201 and Q202. Since the filter modulator does not contain the corresponding diode junction of Q203 of the loudness contour, an additional diode, CR410, is used in a manner so that the two diode drops appearing in Q402 are compensated by the two diode drops of CR409 and CR410. The voltage appearing at the emitter output of the Darlington buffer, Q402, is applied to the filter summing resistor R512 via R506 whose value of 100K provides a total filter contour range of approximately 7 octaves.

## 1.7 OSCILLATORS

### 1.7.1 SPECIFICATIONS

#### OSCILLATOR A

Scale Factor	23mV/cycle nominal
Zero Voltage Input Frequency	Less than ± 1/10Hz (less than 2mV offset)
Linearity	Better than 0.05% (less than 0.2Hz error at 526Hz)
Reset Time	20usec ± 10% at 100Hz
Output	Sawtooth 0 to -5 ± 0.2VDC

#### OSCILLATOR B

Scale Factor	12mV/cycle nominal
Zero Voltage Input Frequency	Less than ± 1/5Hz
Linearity	Better than 0.05% (less than 0.2Hz error at 526Hz)
Reset Time	20usec ± 10% at 100Hz
Output	Sawtooth 0 to -5 ± 0.2VDC

### 1.7.2 DESCRIPTION

The two oscillators are identical except for their scale factors determined by input resistors, which differ by a factor of two. The master oscillator A is driven directly from the keyboard control voltage appearing at the output of A103A. This oscillator covers range of 33Hz to 526Hz. The second oscillator B has a scale factor of one-third that with the voltage applied determined by the presets. For preset A,

oscillator B is driven via gate T1 in IC701. This gate is in turn driven from the voltage divider R707. The voltage divider R707 has the keyboard voltage applied to its top and the additional divider resistors R708, R709, to its bottom. Oscillator B is adjusted to its center frequency value by varying the series potentiometer R711 in such a manner that when the wiper on R707 is at full keyboard voltage, the frequency of Oscillator B is equal to an octave + 1-1/2 semitones (2.09x) above that of Oscillator A. Potentiometer R709 is adjusted so that when the wiper of R707 is at the lower end of the potentiometer, the frequency of Oscillator B is lower than that of Oscillator A by 1-1/2 semitones (0.91x).

For presets B through D, the frequency of Oscillator B is controlled by varying the series resistors R702 through R706. In addition, a fine tuning (beat rate) control for Oscillator B is provided by R710 which varies the frequency of Oscillator B by  $\pm 2\%$ .

A reference voltage is supplied to both oscillators from the output of A103B which, in conjunction with resistors R147 through R151, provides overall supply sensitivity cancellation for the combined keyboard and oscillator circuitry. This occurs in the following manner: Since the octave divider string R101 through R112 is fed directly from the V+ supply, the keyboard voltage appearing at the output of A103A is directly proportional to V+. Amplifier A103B is a conventional operational amplifier inverter circuit which provides a potential of -5V, whose magnitude is directly proportional to V+. The oscillators are designed so that their output frequency is directly proportional to V+ and inversely proportional to the -5V reference provided by A103B. In this manner, the first order changes in the V+ supply are cancelled by the inverse sensitivities. The input resistor to the reference inverter is R147. The feedback resistors are R149 and R150. Potentiometer R150 provides fine tuning control for both oscillators with a control range of  $\pm 8\%$ . Capacitor C113 provides bypassing for spurious signals which might be introduced in the leads that run to the fine tune potentiometer R150. Resistor R148, which is connected to the external accessory connector, provides a means of external frequency modulation or external fine tuning. Resistor R151

provides input bias current offset drift cancellation.

The following description for Oscillator A is adequate to cover Oscillator B by noting that the only difference between these two are the input resistors R601 and R602 (IC601) versus R711, R712 (IC705) and R710.

The oscillator consists of two basic sections. First, an integrate section which is a conventional operational amplifier integrator and second, a comparator one-shot circuit which resets the integrator. The keyboard control voltage is applied to the current conversion resistors R601 and R602. The output feed to A601 is integrated by capacitor C601, a temperature stable (polycarbonate) capacitor. R603 provides input bias current offset cancellation. The output of the integrator A601 is applied to the comparator comprised of resistors R606 through R611 and A602. The ramp applied to the comparator is divided down to 0.5V maximum by R606 through R607. In addition, the -5 reference voltage is divided down by R608 and R609 to provide a reference voltage of 0.5V at the input to the comparator A602. This comparator is run at a current of 1mA as determined by R611. C602 and C603 prevent spikes from appearing on the supply lines which might cause synchronization between the two oscillators. R610 and C605 provide regenerative feedback to the comparator. When the voltage appearing on the negative input of A602 reaches -0.5V, the output of A602 swings from -15V to +11V. C604 slows this transition to approximately 3usec, which is adequately fast for a total reset period of 20usec, but slow enough to prevent serious oscillator coupling problems. Since the output of the A602 is negative during the integration process, CR601 is forward biased holding the reset FET Q601 off. When the comparator A602 swings positive, CR601 becomes reverse biased and the gate potential of Q601 goes to the output level of A601, turning on Q601. Q601 shunts the integration capacitor C601 with a time constant of about 3.5 usec. When A602 switches positive, the positive input to A602 is driven more positive than the negative input, and since the output of A602 is a current output, the potential appearing on the positive input of A602 stays at a constant positive potential until A602 reaches +15V. As charge is bled via R610 from C605, the potential appearing on

positive input of A602 begins to return toward -0.5V. In the meantime, the output of A601 has returned to approximately 0V. Eventually, the potential at the positive input of A602 reaches OVDC, at which time A602 switches regeneratively in a negative fashion, which forward biases CR601 and turns off Q601. The time during which the output of A602 stays positive is determined basically by the time constant of R610 and C605. Thus, A602 acts both as a predictable one-shot and a comparator. It should be noted that the reset time of this circuit is not negligible compared to the total period, namely, 20usec. In order to compensate for this, the series resistance of Q601 and R604 are chosen so that, as the input drive voltage is increased to the integrator via R601 and R602 (IC601), the output of A601 resets to a value whose magnitude is increasingly greater than 0. In this case, the increased drive (higher frequency) to A601 dictates that the time required for the integration process to reach the threshold value decreases proportional to the input drive. Since the output of A601 does not reset exactly to 0 but rather to a value increasing negatively, a result of A601 acting as a conventional inverting amplifier whose input resistor is R601 and R602 (IC601), and whose feedback resistance is the sum of R604 and the on resistance of Q601. Mathematically, the desired relationship is as follows:

$$(R_{FET} + R604) C601 = RESET = 20usec$$

The first order relationship is actually modified by a second more complex one because the reset time provided by R610 and C605 is not exactly constant. This changes because the reset value of A601 is not a constant, therefore the time at which the comparator A602 resets is delayed because the potential, which must be reached at the positive input of A602 for the end of reset period, is not 0 but increasingly negative at increasing frequencies. Thus, the reset period increases in a second order fashion as the frequency is increased. This increasing reset period with increasing frequency means that the effective resistance of Q601 and R604 must be increased by approximately 20% from the value indicated by the relationship given above.

The inputs to the comparator A602 are divided down by resistors R606 and R607 so that the total

input differential range of A602 (5V) is not exceeded. The outputs of the two oscillators are applied to the voltage dividers, R801 through R807, which determine the oscillator balance for the four presets. The various mixes of oscillators A and B are applied to the gates of IC801 and driven by the preset drive lines A through D. The CMOS analog gate IC801 has a substrate bias of -7.5V, determined by resistors R808 and R809. This biasing is necessary since the oscillator outputs swing from 0 to -5V. The common output of IC801 is applied to the filter through R513 and C501 so that maximum RMS value of 50mV is applied to the filter.

## 1.8 FILTER

### 1.8.1 SPECIFICATIONS

Low Cutoff (Foot Slider down, Programmable Preset down) - 40Hz  $\pm$  20%

High Cutoff (Foot Slider up, Programmable Preset up) - 5000Hz  $\pm$  20%

Filter Cutoff Slope - 24dB/octave

### 1.8.2 DESCRIPTION

This filter is the patented transistor ladder type first used in the Minimoog. The cutoff frequency is controlled from five different sources.

- a) Preset Control
- b) Contour Control
- c) Foot Slider Control
- d) Cutoff Frequency Trim
- e) Keyboard

The control signals from these five sources are fed to the summing resistor R512, via the resistors R502 through R506, R508 and R510. Preset control of the filter is accomplished via R502 through R505. R502 is the feed resistor for the programmable preset whose filter control is the slide potentiometer R501. The value of 82K for R502 provides approximately 7 octaves of programmable preset control of the filter.



Resistors R503 through R505 are selected for the desired fixed presets. The filter contour signal is applied via R506 providing maximum of 7 octaves of filter contouring. Potentiometer R507 is the foot slider that controls the cutoff frequency via R508, and permits approximately 4 octaves of control. R509 is the center frequency trim adjust which compensates for variations in the follower transistor Q501 and the exponentiating transistor Q512. R511 feeds the keyboard voltage to the filter summing node and provides approximately 2-1/2 octaves of filter control over the 16' through 2' range. It should be noted that the oscillator frequency is linearly proportional to the keyboard voltage while the filter cutoff frequency will be exponentially related to the keyboard voltage.

The sum of the five control voltages that appear at the base of Q501 are applied to the exponentiating transistor Q512 through the emitter follower comprised of Q501 and R514. This emitter follower provides compensation for base-to-emitter voltage changes of Q512 due to temperature variation. Capacitor C503 prevents high frequency spurious oscillations. The voltage drive applied to the base of Q512 causes a collector current proportional to the exponentiated value of the base voltage with a scale factor of about 18mV per octave. The collector current of Q512 is applied to the transistor ladder comprised of Q502 through Q511 via R522 whose presence permits easy measurement of the ladder current. The ladder transistors are biased at increasingly positive potentials by the divider string comprised of R515 through R519 and R521. The bottom pair of transistors in the ladder, namely Q510 and Q511, are a matched pair (in IC502) which split the current provided by Q512 into equal parts when no audio signal is applied via C501 and R513. When a low level AC signal is applied, C501 (whose bias point is set by the divider chain and applied via R520, providing AC isolation) the standing current in the right and left side are modulated inversely. As the standing current in the ladder is increased, the effective collector impedance seen by the transistors are decreased providing a higher cutoff frequency by way of the effective collector load and the ladder capacitors C505 thru C507. The modulation of the standing currents by the audio signal is non-linear, but this factor is reversed by the current-to-voltage converter transistors Q502, Q503 at the

top of the ladder. These two converter transistors provide a voltage which is essentially the log of the ladder current. The push-pull voltages at the top of the ladder are applied to the differencing and level shifting amplifier A501. A501 is operated at bias current of approximately 32uA or a transconductance of approximately 640. The DC load resistor for A501 is R526 which sets the output voltage of A501 near ground. C508 prevents oscillation of A501. The AC load resistor for the voltage signal fed to the emitter follower, comprised of Q513 and R527 is the sum of R304 and R306 in parallel with R526, namely, 33K. Thus the gain from the filter ladder to the base of Q513 is approximately 16. Because of the AC coupling provided by C301, the effective dynamic load resistor for A501 increases at low frequencies (corner frequency of approximately 20Hz). Thus, the voltage appearing on the output of the emitter transistor, Q513, rises at low frequencies. This signal is applied to the regeneration feed circuit comprised of C509, R529 through R532, R523, R524 and IC503. This feedback loop must be dynamically coupled via C509 because the bias point of the ladder transistor Q511 is different from that of the follower transistor Q513. The regeneration feedback path is selected by the analog multiplexer IC503, controlled by the preset lines A, B, C, and D. In the programmable preset state A, the slide potentiometer R529 feeds the regeneration signal to the base of Q511 via the regeneration trim adjust potentiometer R524. R524, in conjunction with R523, sets the regeneration level applied to Q511 so that the filter oscillates "linearly" when full regeneration signal is applied by setting potentiometer R529 to "0" resistance. The bias potential for the ladder input transistors, Q510 and Q511, is AC bypassed by C502. The regeneration signal applied to the base of Q511 begins to roll off at low frequencies with a corner frequency of approximately 20Hz when the regeneration control R529 is at "zero". The increasing voltage drive appearing at the output of A501, which also has a corner frequency of approximately 20Hz, compensates to first order the roll-off caused by C509. This compensation technique provides for uniform regeneration level in the filter to well below 30Hz.

The final filter output is the output of A501 which is fed to the VCA A301. The transconductance of A501 is 600 umhos. The overall gain, as seen from



the output of filter ladder to the input of the VCA A301 is approximately unity.

## 1.9 LOUDNESS MODULATOR (VCA)

### 1.9.1 SPECIFICATIONS

Maximum Drive Current - 1mA

Input Signal Level - 20mV (RMS)

Balance - Output level to change less than 50mV with maximum contour applied

### 1.9.2 DESCRIPTION

The loudness modulator is a conventional OTA modulator circuit utilizing the RCA CA3080. As previously described, the audio signal is applied to the negative input of the OTA A301, via C301, R304 and R306. The positive input is driven by a DC balance circuit comprised of R305, R507 and R303, which provides a total offset balance range of  $\pm 14\text{mV}$ .

The current drive for A301 is applied through R308 which allows easy measurement of the current being fed to A301. R309 provides turn-off of the modulator of A301 at extremely low contour levels (namely, when the contour signal has gone off).

With the signal level at the negative input of A301, the CA3080 is approximately 20mV, RMS. With full contour (1.2mA) applied, the transconductance of A301 is about 20,000 which, in conjunction with the 12K load resistor R310 of A301, provides an overall gain of 240, giving a maximum output level of 4.8V RMS applied to the emitter follower comprised of Q302, R311 and R312. C305 prevents oscillation of A301. The modulated output appearing at the emitter of Q302 is AC coupled via C306 to the output divider potentiometer R313 (rear panel). This RC network has a low frequency cut off of about 10Hz. R311 provides Miller degeneration to prevent possible oscillation of the emitter follower Q302. The divided down output voltage appearing at the wiper R313 is applied to the output jack, J301, via the protection resistor R314.

## 1.10 CONTROL CIRCUITRY

### 1.10.1 DESCRIPTION

The Taurus has five switch functions, which have digital memory and control. These five sections are as follows:

- a) Preset Control
- b) Octave Control
- c) Sustain Control
- d) Glide Control
- e) External Accessory Control

### 1.10.2 PRESET CONTROL

The preset control section consists of switches SW901 through SW904, gates G5 through G12, resistors R901 through R913 and light emitting diodes, CR901 through CR904. Gates G5 through G8 are interconnected to form a multi-flop latch. The operation of this latch is most easily understood by observing that if the output of any gate, for instance G5, is a 0 (ground), then the remaining gate's outputs (G6 through G8) are all positive. Since the inputs to each one of the gates are connected to the outputs of the other three gates, the inputs to G5 are all positive forming a self-consistent logic condition. When any one of the switches, SW901 through SW904 connects the output of its associated gate (for example, SW901 G5) momentarily to ground, the outputs of the remaining three gates go positive and the multi-flop latch locks in this condition. The only requirements of the switches SW901 through SW904 is that this shorting-to-ground condition exists for sufficient time for the multi-flop to latch, which is the propagation time of a single 7410 gate, approximately 20nsec. Switch bounce is therefore not a problem.

The outputs of the multi-flop latch drive the light emitting diodes (LEDs) CR901 through CR904 which provide panel indication of the active preset.

Since only one of the LEDs is on at any given time, a single current limiting resistor R901 can be used. This resistor limits the LED current to approximately 22mA. The outputs of the multi-flop latch also drive the high voltage open collector interface gates G9 through G12 which, in conjunction with the pull-up resistors, R902 through R905, provide 15V drive levels for the preset control lines A, B, C and D. These lines drive the CMOS analog gates, mentioned previously. In addition, the A, B, C and D points drive the resistor dividers, comprised of R906 through R913, which provide switching levels of -7.5 (OFF) to 0V (ON) drive levels for the oscillator mix feed gates in IC801.

The pull-up potential for R902 (A preset) is driven from point H, a point which may be controlled by a signal applied to the external accessory connector P4-9. The point H is a V+ potential when no accessory is applied. This will be explained in detail in a later section. In addition to driving the CMOS analog gates, this section provides a control for the octave control section, which informs this section whether preset A is active or inactive. This control signal is the output of gate G5 and is applied to gate G13.

### 1.10.3 OCTAVE CONTROL

The octave control section determines whether the instrument is in the 16', 8', 4' or 2' range. This octave control section consists of switches SW905, SW908, gates G13 through G30, resistors R918 through R925 and LED CR905.

There are two distinct modes of operation of the octave control section related to whether or not the A preset is active.

When preset A is not active, only 8' and 16' ranges are possible. The 8' and 16' selection is controlled by SW905 and G28 through G30. If the output of G5 (the A preset section of the multi-flop latch) is HIGH (positive) the output of G13 (a flip-flop connected as an inverter) is LOW (ground) deactivating gate G14 and SW908 via Q902. The output of G14 is therefore HIGH enabling G20 and G23. Also, gates G16 through G20 are deactivated since SW908 is deactivated. The remaining inputs of G20 and G23

are tied directly to the Q and  $\bar{Q}$  outputs of G28, a flip-flop which toggles (alternates) each time switch SW905 is depressed. Thus, with successive depressions of SW905, the Q and  $\bar{Q}$  outputs alternate HIGH and LOW, turning ON and OFF, gates G20 and G23. Thus, the outputs of the gates, G20 and G23, alternately go HIGH and LOW, turning ON and OFF the high voltage interface gates, G26 and G27 which, in connection with the pull-up resistors R920 and R921, provide alternate 15V drive signals for the 8' and 16' control lines. These 15V drive signals are applied to the CMOS analog gates in IC103, which connect the note divider chain to various octave voltage taps as described in the keyboard section.

The toggle action of G28 is caused by SW905, which causes the corresponding coupled inverter gates G29 and G30 (which act as a two state version of the multi-flop described previously) to flop back and forth as SW905 goes down and then returns. This configuration provides a clean negative going transition to the clock line of G28, whose Q output is applied to the data input (D) so that successive negative transitions of the clock signal cause G28 (an edge triggered flip-flop) to toggle. C903 provides protection against the condition where SW905 causes a negative going transition on the clock line but where the switch may bounce off the contact in a time shorter than the latch time of G29 and G30. In this case, the clock line may see several negative transitions within the span of the latch time due to the propagation delays of G29 and G30 (20nsec). C903 slows down G28 so that it does not respond to these possible extremely short transitions. The  $\bar{Q}$  output of G28 drives the LED CR905 via the current limit resistor R925.

When preset A is active, gate G14 and SW908 are active, driven by the positive  $\bar{Q}$  output of G13. SW908, in its three successive positions from left to right, activates control sections which drive the 2'-4', 4'-8' and the 8'-16' respectively. For example, in the left-most position of SW908, gates G16 and G17 are active; gates G18, G19, G20 and G23 are all OFF. When the Q output of G28 is positive, the output of G16 goes to 0 providing a +15V drive signal to the 2' line via G24 and R918. When the  $\bar{Q}$  output of G28 is positive, G16's output is positive while the output of G17 goes HIGH providing a LOW to G25

through G21 which, in turn, provides a 15V drive signal to the 4' line via G25 and R919. In similar fashion, the other two positions of SW908 provide for either 4'-8' or 8'-16' range, the selection within each pair determined by the octave switch SW908 and its associated toggle flip-flop, G28.

#### 1.10.4 DECAY CONTROL

The decay control section is comprised of switch SW906, gates G31 through G34, R926, R929, CR906 and C904. Gates G32 and G33 operate in a manner identical to the foot switch controlled toggle described previously for G29, G30 and SW905. Visual indication of the sustain status is provided by the LED CR906 which is driven via the current limit resistor R926. The output of the toggle flip-flop G31 is applied to the high voltage interface gate G34 which provides a +15V signal in the "No-Sustain" mode.

#### 1.10.5 GLIDE CONTROL

The glide control section is comprised of gates G35 through G38 whose action is precisely the same as the sustain section. In this case, visual indication of the glide status is provided by the LED CR907 whose current limit resistor is R930. A +15V output of G38 corresponds to the "No Glide" mode.

#### 1.10.6 EXTERNAL ACCESSORY CONTROL

The connector P4-9 provides a means of switch interaction between an external accessory device and the internal control sections. This control interaction is accomplished via Q901 through Q903 and R914 through R917.

If there is no signal applied to pin P4-9, Q903 is held ON because of base current supplied through R915, and Q901 is also held ON via base current supplied by R916. Q902 is a floating switch which, when Q901 is on, transmits the output of G13 to SW908 (point "K"). If pin P4-9 is shorted to ground, point "L" goes positive, point "H" goes to ground and point "K" is isolated from the output of G13.

These actions shut down the drive for the A and  $\bar{A}$  preset control lines and also defeat any control of octave switching by SW908. In addition, the reversal of the logic levels of "H" and "L", which drive the glide control gates in IC106 provide for the insertion in the keyboard circuit line of a glide control. The control exercised by pin P4-9 does not affect the fixed presets B, C and D.

### 1.11 POWER SUPPLY

#### 1.11.1 SPECIFICATIONS

##### OVERALL

Input Voltage Range - 85-135 or 170-270 VAC

Input Frequency - 50-60 Hz

Power Consumption - 12 VA maximum

##### $\pm 15V$ SUPPLY

Output Voltage -  $15 \pm 0.5V$

Line Regulation (85-135VAC) -  $\pm 20mV$

Load Regulation (0-100mA) - 30mV

Noise and Ripple - Less than 1mV RMS

Operating Temperature Range - 0 to 75°C

Protection - Current limit, thermal shutdown, short circuit (to ground) proof

##### + 5V SUPPLY

Output Voltage -  $5.0 \pm 0.2V$

Line Regulation (85-135VAC) - 50mV

Noise and Ripple - Less than 10mV RMS

Protection - Current limit, thermal shutdown, short circuit (to ground) proof

### 1.11.2 DESCRIPTION

The Taurus power supply consists of two regulator sections, namely,  $\pm 15$  tracking supply and a +5V supply.

The nominal 115 or 230VAC power is applied to the POWER switch SW1001, 115/230 switch SW1002 and then to the split primary of the step-down transformer TF1001. One line of each half of the split primary is fused inside the unit to provide for 115/230V fusing. The secondary of TF1001 is a single center-tap winding, which provides raw supply voltages of  $\pm 26$ V nominal for the  $\pm 15$ V regulators. Diodes CR1003 through CR1006 are the rectifiers for  $\pm 15$  supply whose smoothing capacitors are C1007 and C1008 respectively. The 470uf capacitance of C1007 and C1006 gives approximately 1/2V ripple peak-to-peak on the raw supply voltages for the  $\pm 15$ V regulators. Line voltage variations over the range of 95-135VAC cause these raw supply voltages to vary from 18 to 30VDC. The 18V level is the minimum required for the  $\pm 15$ V regulator circuits to operate properly. The 30V level is the maximum supply voltage permitted for the dual monolithic tracking regulator IC1001. Raw supply voltages are applied to the emitters of the power pass transistors Q1001 and Q1002 (via R1005) and to the raw supply inputs (pins 7 and 8) of the 1468 regulator via resistors R1003 and R1004. The function of R1005 is to provide overvoltage protection for the negative side of the 1468 due to a substantially lower current load on the negative raw supply. The basic regulating circuit, consisting of transistors Q1001, Q1002, IC1001 and current limit resistors R1001 and R1002 operates as specified in the paragraphs that follow.

The idling current of IC1001 is approximately 10mA. This current generates a base-to-emitter drop across Q1001 and Q1002 of about 0.5V. If very small currents are drawn from the output supply (P1001-1 or P1001-3), this current will be supplied from pin 5 or pin 10 of IC1001 directly, via R1001 or R1002. This happens because the drop across R1003 and R1004 which supply current to the regulator IC1001 is not sufficiently large to turn on Q1001 or Q1002 appreciably. As larger currents are drawn from the output points, the drop across

R1003 begins to increase in such a fashion that the current flowing out of the base of Q1001 into the regulator is  $1/h_{FE}$  of the current out of the collector of Q1001. Thus, for significant current drain from Q1001, the transistor Q1001 supplies (beta) x (increased regulator current). The output current for the positive supply passes through the current sense resistor R1001. The positive supply output voltage sense point is pin 4 of IC1001. If the output voltage begins to drop, the regulator IC1001 attempts to deliver more output current via pin 5, which in turn, causes more current to be drawn into pin 7 turning on Q1001 harder. The same reasoning applies to the negative regulator and its associated transistor Q1002.

If the voltage drop across R1001 or R1002 exceeds 0.6V (package cool) or 0.4V (package hot), the regulator IC1001 goes into current limit. The value of R1001 and R1002 provides a current limit of 100mA to 150mA depending upon package temperature. Capacitors C1003 through C1006 are used to prevent high frequency oscillation. Capacitors C1001 and C1002 provide low output impedance at moderate frequencies. Diodes CR1001 and CR1002 provide protection against supply voltage reversal (which might be caused by both short circuits or by power supply malfunction) which would be disastrous for the CMOS circuits.

The worst case power dissipations for Q1001, Q1002 and IC1001 occur when the output is short circuited and IC1001 goes into current limit and when the line voltage is maximum. In this case, the pass transistor Q1001 and IC1001 see a raw supply voltage of 30V. The pass transistor Q1001 has a minimum beta of 50 at a current of 100mA (package hot), the current limit point. In this case, the total current into pin 7 of IC1001 will be 12mA resulting in a package dissipation of about 360mW (390mW at 150mA current limit) substantially less than the free air maximum of 600mW. Thus, as far as power dissipation is concerned, IC1001 is short circuit proof. The pass transistor Q1001 in this short circuit condition, will have a dissipation of 3 watts. This transistor is mounted on the printed circuit board with two square inches of copper on the reverse side of a 0.062 inch thick glass-epoxy board. The measured tab temperature of this transistor mounted as indicated above, is  $66^{\circ}$  above ambient or about

22°C/watt. Using an ambient temperature of 50°C and the figure of 3°C/watt for the junction-to-tab thermal resistance of Q1001, a junction temperature of 125°C is indicated, which is adequately lower than the specified maximum junction temperature of 150°C. This same reasoning applies to the negative regulation section and its associated pass transistor Q1002.

The +5 VDC is provided by the monolithic regulator IC1002. The peak current draw for this regulator by the Taurus circuitry is approximately 300mA. This regulator is specified for a maximum output current of 0.5 ampere. The current to this regulator is supplied via the voltage dropping resistor R1006, which is used to reduce the dissipation in IC1002. At the nominal current of 300mA, the drop

across R1006 is 11V, which sets the input voltage to IC1002 at 19V when the line voltage is a maximum (30V raw DC). In this case, the drop across IC1002 is 14V implying a dissipation of 4.2 watts maximum. If we assume an ambient temperature of 50°C, a junction to package thermal resistance of 2°C/watt, a mounting screw thermal resistance of 5°C/watt and a printed circuit board with heat sink thermal resistance of 10°C/watt, a maximum junction temperature of 121°C is indicated, which is less than the specified maximum of 125°C.

The power supply for the Taurus is self-contained and mounted on a separate subassembly, which also carries the input power components SW1001, SW1002, F1001, F1002 and TF1001.

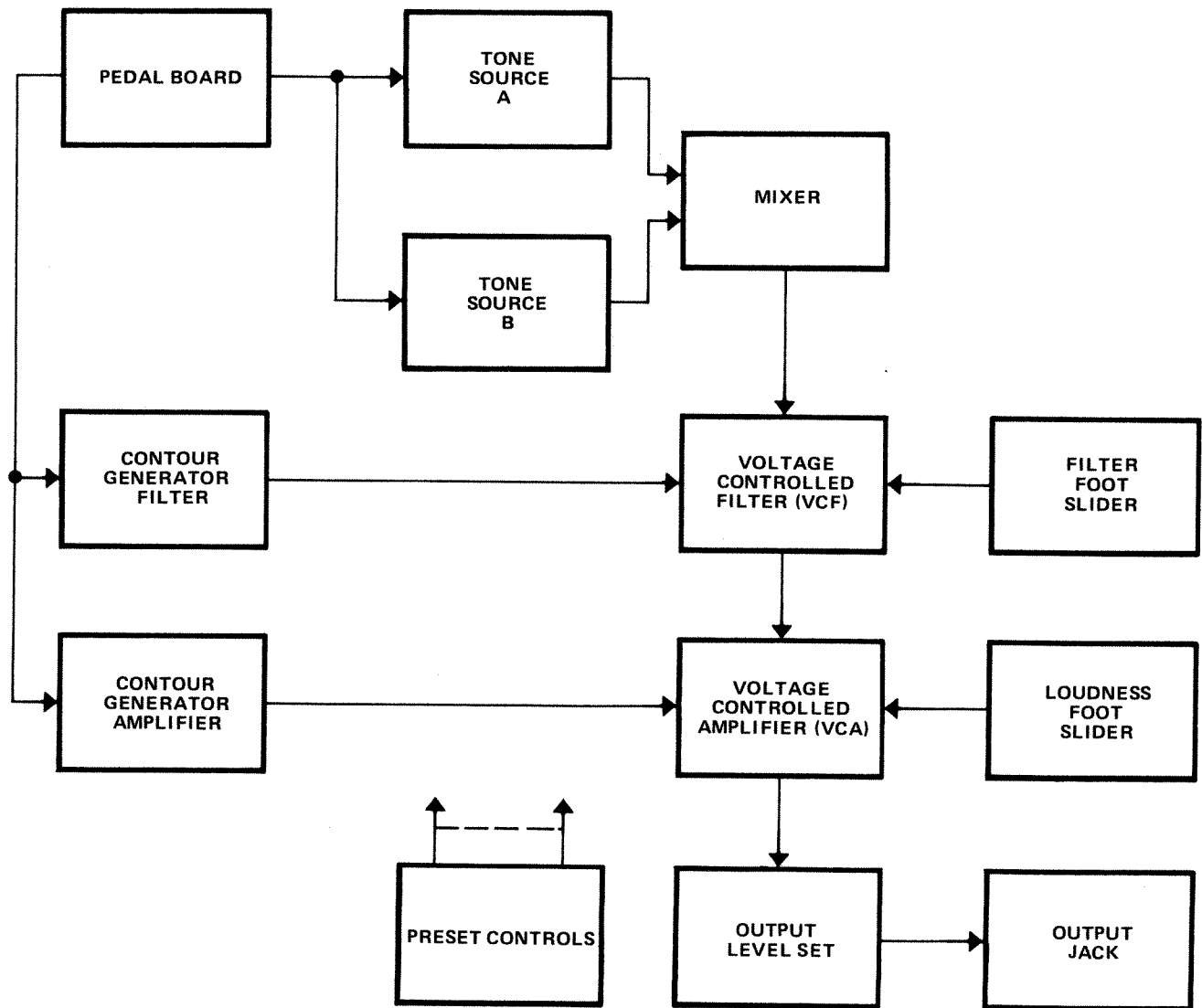

FIGURE 1-1 SIMPLIFIED BLOCK DIAGRAM

## SECTION 2

### QUICK REFERENCE TROUBLE ANALYSIS GUIDE

SYMPTOM	PROBABLE CAUSE
<b><u>GENERAL MALFUNCTIONS</u></b>	
No output.	A301, A501 or IC801.
Output, but distorted and no tuba.	Oscillator "A" not functioning.
Output, but one or more presets distorted or not functioning properly.	IC702, IC703, IC704.
All outputs distorted; glitch on output.	IC801 or change R809 from 47K to 33K.
<b><u>FILTER MALFUNCTIONS</u></b>	
Noisy.	A501.
High frequency oscillation in filter.	A701 or A601 (741's in oscillator oscillating).
Filter cut-off will not adjust to 40 Hz.	Resistor bank IC501 or transistor Q402.
Filter clips.	A501 or IC502.
No filter loudness control.	Foot slider out of socket, Q501, IC301, Q202 or IC201.
No foot filter control.	Foot slider out of Q501, Q402.
<b><u>TRACKING MALFUNCTION</u></b>	
Offset dc voltage is not within 2.0mV between pins 2 and 3 of A701 and pins 2 and 3 of A601.	IC701; replace with another 4016 or 4066.

## SECTION 3 DISASSEMBLY

### 3.1 HOUSING DISASSEMBLY

a) Lift Taurus up and lay it on its left side with the base pedals toward you.

b) Remove the 4 (four) large Phillips screws located on the legs of the unit with a No. 3 Phillips screwdriver.

c) With foot pedal and shell housing now separated, open unit and lean both parts together to form a "L" shape as shown on Figure 3-1.

d) All testing now can be performed on the Taurus with easy access to the electronic parts.

### 3.2 PRINTED CIRCUIT BOARD DISASSEMBLY (Figure 3-1)

With Taurus disassembled, the main board may be removed for the replacement of any electronic or mechanical part as follows:

a) With 5/16 nut driver, remove the 4 (four) nuts located between the large push button switches.

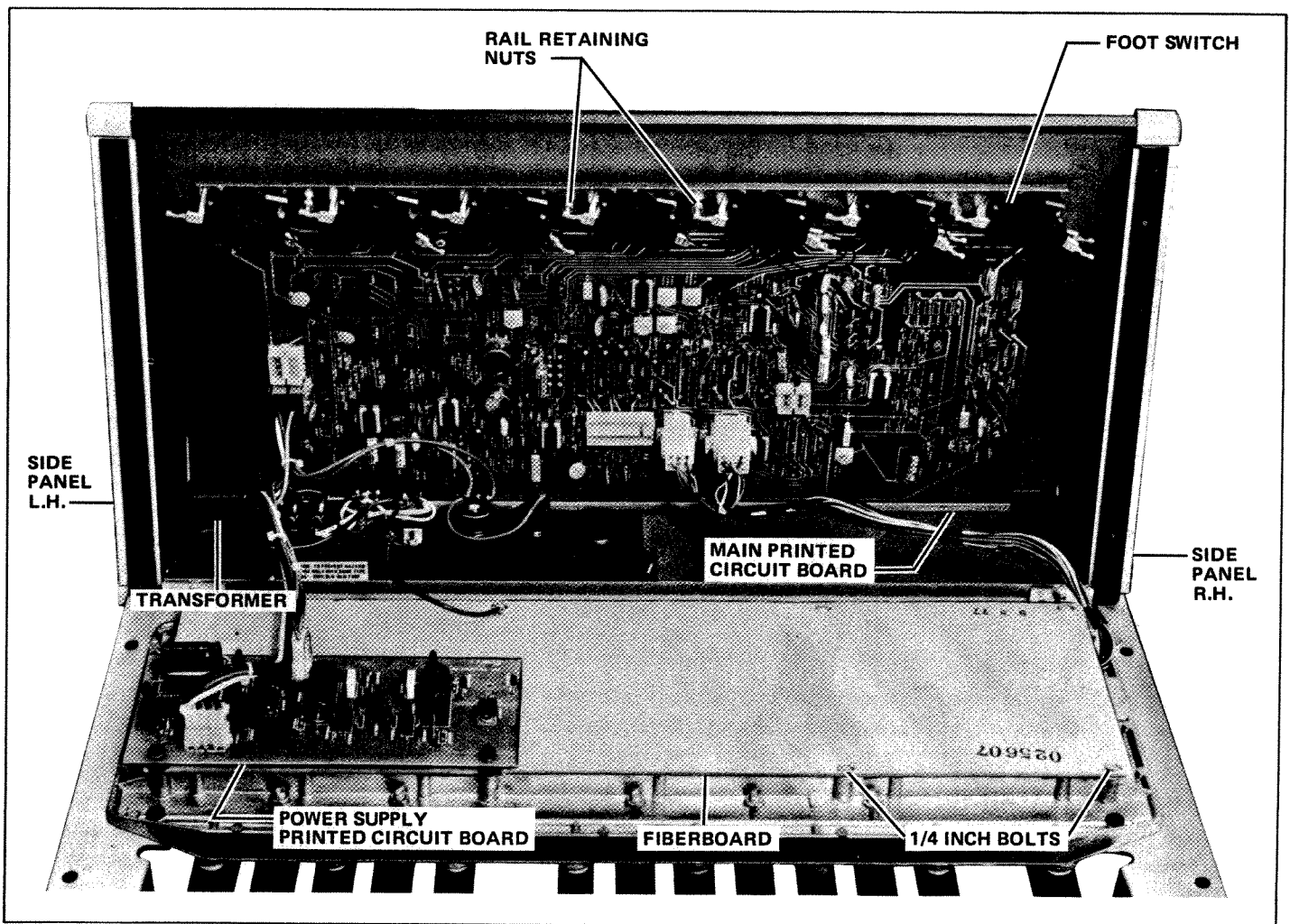

FIGURE 3-1 TAURUS WITH FOOT PEDAL AND SHELL HOUSING SEPARATED

b) With the 4 (four) nuts and washers removed, a slight prying force with a blunt screwdriver between the push button rail and the shell will allow the board to pop out.

c) Refer to Section 6 for printed circuit board modifications.

### 3.3 PRINTED CIRCUIT BOARD REASSEMBLY

a) With the Taurus on its left side as indicated in paragraph 3-1, insert the board into the track slot on the bottom of the shell.

b) With the board now inserted in the track slot, line up the foot sliders (LOUDNESS and FILTER) with the board sliders, align holes in pushbutton rail with screws and gently push board back into the shell.

c) Replace all washers and nuts previously removed and tighten until secure.

### 3.4 FOOT PEDAL CONTACT REMOVAL (Figure 3-1 and 3-2)

a) Remove the six 1/4 inch (6.33mm) bolts on the fiberboard and the two Phillips screws on the power supply printed circuit board to gain access to the key contacts.

b) Remove the two 1/4 inch (6.33mm) bolts that fasten the key contact printed circuit board and lift board up (not shown).

c) Clean the key contacts and the key metal buss bars (gold plated and L-shape) using cotton swabs and isopropyl alcohol.

d) To replace a key contact, unsolder the 2 (two) U-shape support brackets and lift the key contact out. (Note general location of key contacts on Figure 3-2).

e) Insert the new contact and solder in place.

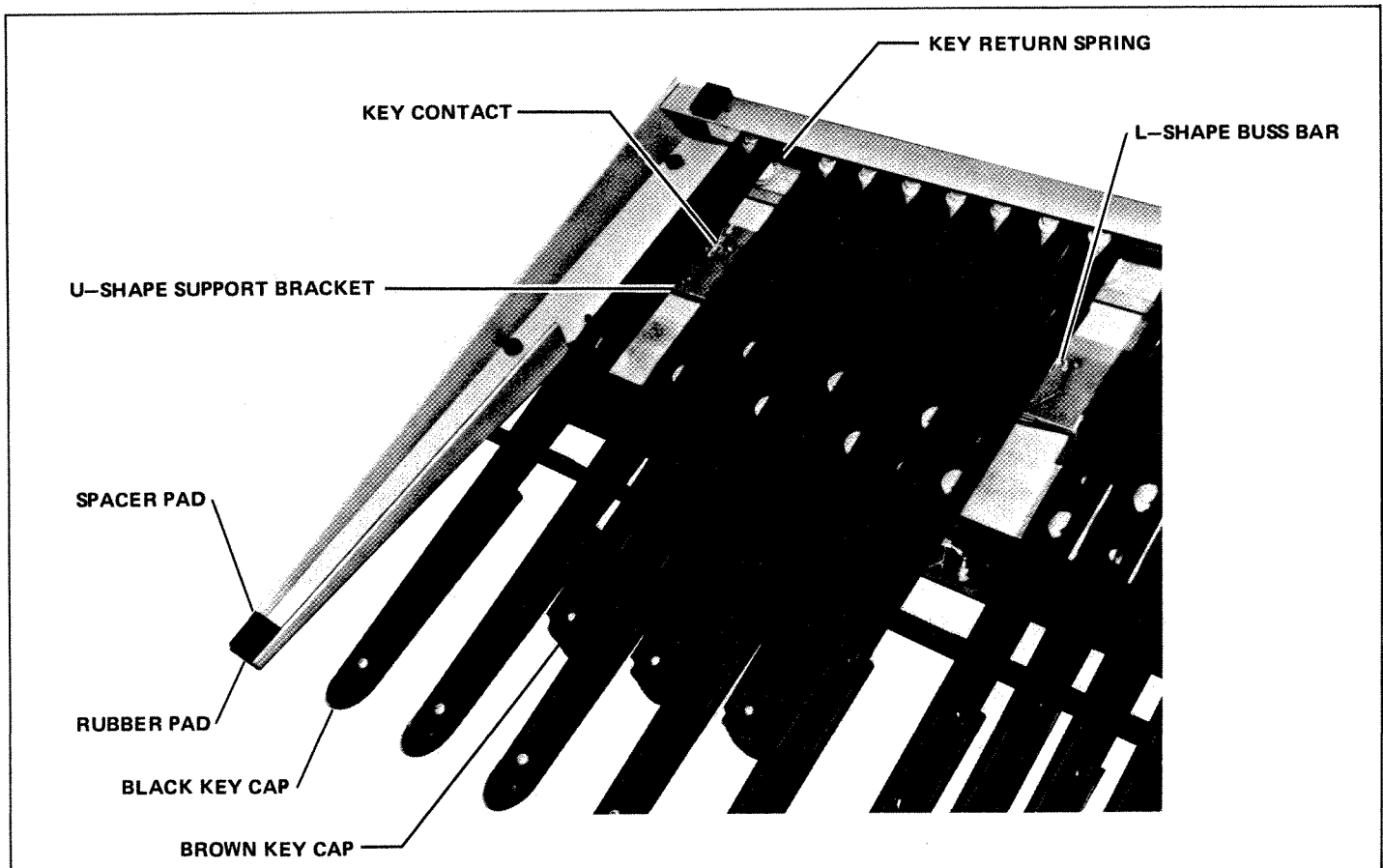

FIGURE 3-2 BOTTOM VIEW



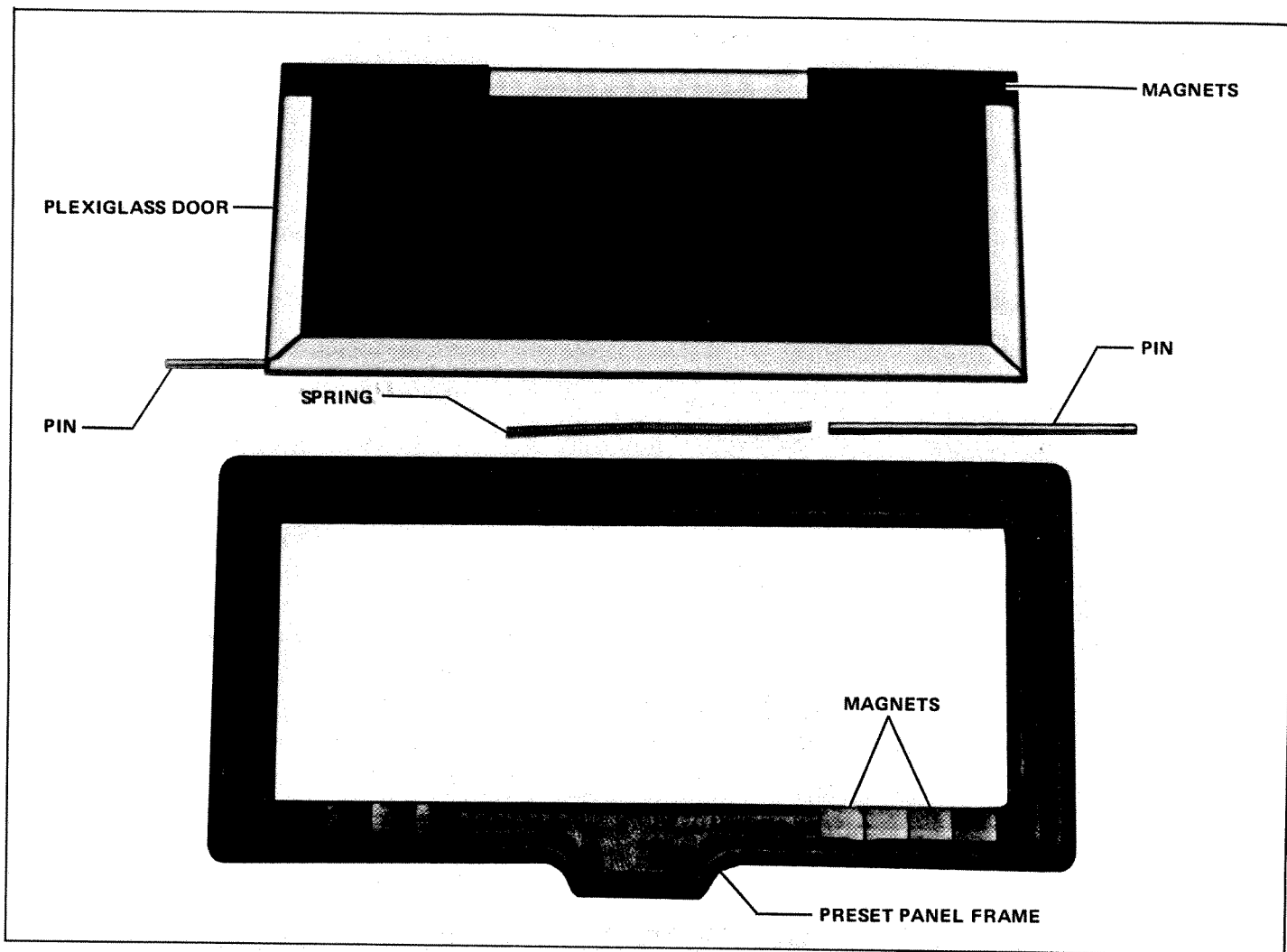

FIGURE 3-3 PROGRAMMED PRESET COVER

f) Reassemble the boards in the reverse order of disassembly.

### 3.5 VARIABLES CONTROL COVER REMOVAL (Figure 3-3)

Remove the plexiglass door and the preset door frame covering the VARIABLES control box section in the following manner:

a) Remove the door frame and the door assembly as a unit by lifting the lip of the frame in an upward direction.

b) Depress door frame pin using a stiff piece of steel wire and lift that side of the plexiglass door slightly.

**CAUTION**  
Both right and left pins are spring loaded. Retain pressure on the pin to prevent ejection.

c) Remove the disengaged pin.

d) Shift glass assembly to the right (or left as the case may be) sufficiently to expose the remaining pin.

e) Grasp pin to prevent ejection and remove plexiglass door. Remove pin.

f) A compression spring is located in the center of the top plexiglass door frame and now may be removed.

## SECTION 4 TUNING AND ADJUSTMENTS

### 4.1 GENERAL

a) Disassembly housing as described in paragraph 3.1.

b) Insert 1/4 inch phone plug jack into rear panel (Figure 4-1) OUTPUT jack and rotate OUTPUT LEVEL control to "0".

c) Turn POWER switch "ON" and note that some button indicator lights on front panel glow.

d) Ensure proper power supply operation by measuring:

+15V  $\pm$  0.5VDC

-15V  $\pm$  0.5VDC

+ 5V  $\pm$  0.2VDC

+15V to -15VDC - Balance within 300mV of each other.



FIGURE 4-1 REAR PANEL

### 4.2 SCALE ADJUSTMENT

(Figures 4-2, 4-3 and 7-1 through 7-4)

a) Press GLIDE button (LED OFF).

b) Press VARIABLE button (LED ON).

c) Press DECAY button (LED OFF).

d) Set OCTAVE slider to "HI".

e) Connect DC probe to R137.

f) Hold down high C foot pedal and note voltage.

g) Hold down low C foot pedal and note voltage.

h) Repeat steps f and g and adjust "Scale" trimpot R131 for a 2:1 voltage variation  $\pm$  1mV.

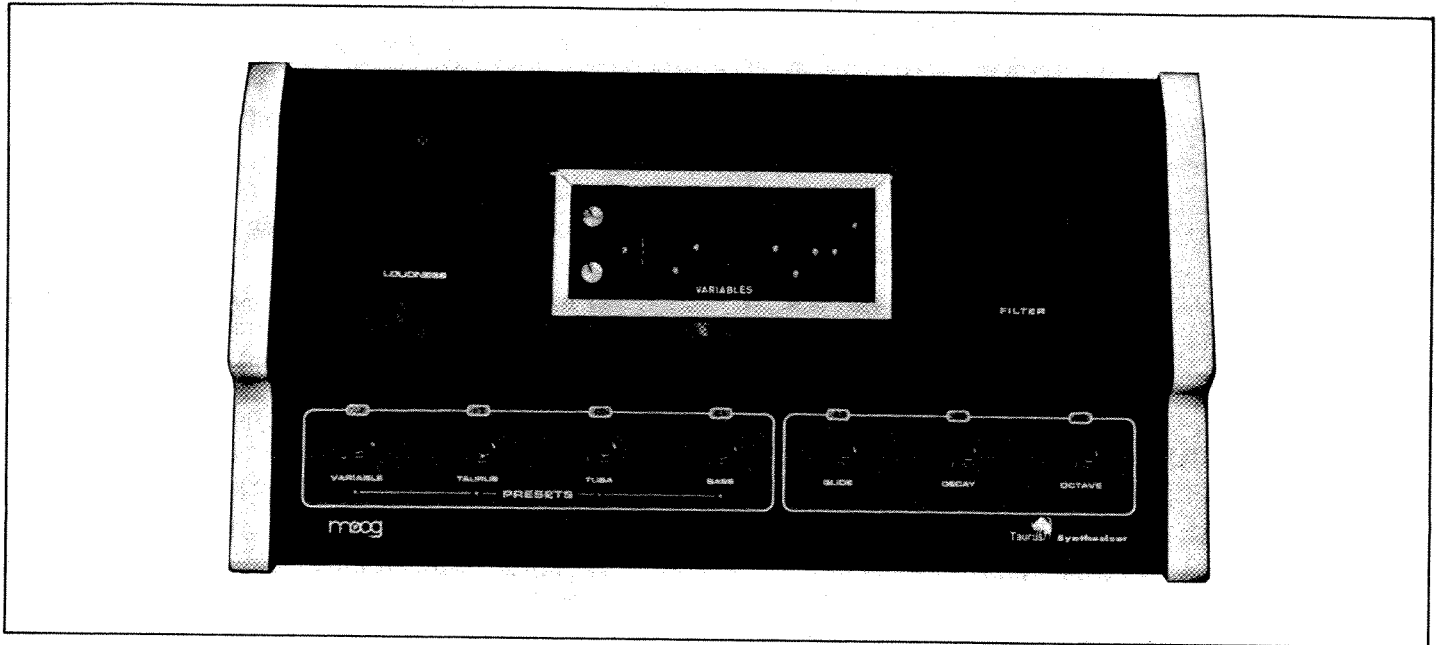

FIGURE 4-2 FRONT PANEL

**4.3 FET BALANCE (OCTAVE TUNING)**  
(Figures 4-2, 4-3 and 7-1 through 7-4)

- a) Press GLIDE button (LED OFF).
- b) Press VARIABLE button (LED ON).
- c) Press DECAY button (LED OFF).
- d) Set OCTAVE slider to "HI".
- e) Press OCTAVE button (LED ON).
- f) Connect DC probe to A103A, pin 6 and note voltage.
- g) Hold down high C foot pedal.
- h) Measure voltage on A103A, pin 5, and note voltage difference, if any.
- i) Adjust "FET Balance" trimpot R146 for the same voltage on pins 5 and 6 of A103A by repeating steps f, g and h.

TUNE	5.0 ± 0.5	SUSTAIN LEVEL	10
BEAT	2.5 ± 1.0	DECAY	0
GLIDE	0	CUT-OFF	10
OCTAVE	Medium	EMPHASIS	0
B-MIX-A	10	CONTOUR AMOUNT	10
OSC B FREQ	0	CONTOUR ATTACK	0
ATTACK	0	CONTOUR DECAY	0

- b) Push VARIABLE button (LED ON).
- c) Push OCTAVE button (LED ON).
- d) All other buttons off (LED OFF).
- e) Hold down high C foot pedal.
- f) Adjust "Frequency A" trimpot R601 (IC601) for 523 Hz ± 1 Hz.

**4.4 OSCILLATOR "A" TUNING**  
(Figures 4-2, 4-3 and 7-1 through 7-4)

- a) Set the controls located in VARIABLES control box as follows:

**4.5 OSCILLATOR "B" TUNING**  
(Figures 4-2, 4-3 and 7-1 through 7-4)

- a) Set the controls located in VARIABLES control box as follows:

TUNE	5.0 ± 0.5	SUSTAIN LEVEL	10
BEAT	2.5 ± 1.0	DECAY	0
GLIDE	0	CUT-OFF	10
OCTAVE	Medium	EMPHASIS	0
B-MIX-A	0	CONTOUR AMOUNT	10
OSC B FREQ	10	CONTOUR ATTACK	0
ATTACK	0	CONTOUR DECAY	0

b) Push VARIABLE and OCTAVE buttons (LED ON).

c) Hold down “A” foot pedal.

d) Adjust “Frequency B” trimpot R711 (IC705) for 484Hz ± 2Hz.

e) Set OSC B FREQ slider to “0”.

f) Adjust “Range B” trimpot R709 (IC704) for 198Hz ± 2Hz.

g) Repeat steps d through f.

h) Press TAURUS button (LED ON) and adjust “Taurus Frequency” trimpot R703 (IC702) for zero beat (no change in pitch).

i) Press TUBA button (LED ON) and adjust “Tuba Frequency” trimpot R704 for zero beat at +1 octave (oscillator “B” at twice the frequency of oscillator “A”).

j) Press BASS button (LED ON) and adjust “Bass Frequency” trimpot R706 (IC703) for zero beat.

#### 4.6 FILTER TUNING

(Figures 4-2, 4-3 and 7-1 through 7-4)

a) Press VARIABLE button (LED ON).

b) Set EMPHASIS slider to “8”, CUT-OFF slider to “0” and set foot FILTER to maximum (up).

c) Adjust “Regeneration” trimpot R524 for threshold of oscillation.

d) Set foot FILTER to minimum (down).

e) Set EMPHASIS slider to “10”.

f) Adjust “Filter Frequency” trimpot R509 for 40Hz ± 2Hz.

#### 4.7 VCA TUNING

(Figures 4-2, 4-3 and 7-1 through 7-4)

a) Push VARIABLE and OCTAVE buttons (LED ON).

b) Set OCTAVE slider to “HI”.

c) Set all sliders to “0” except set SUSTAIN LEVEL to “10”.

d) Set foot LOUDNESS and foot FILTER to minimum (down).

e) Connect DC Oscilloscope to base of transistor Q302.

f) Press a foot pedal and adjust “VCA Balance” trimpot R303 for identical readings when pedal is pressed and released.

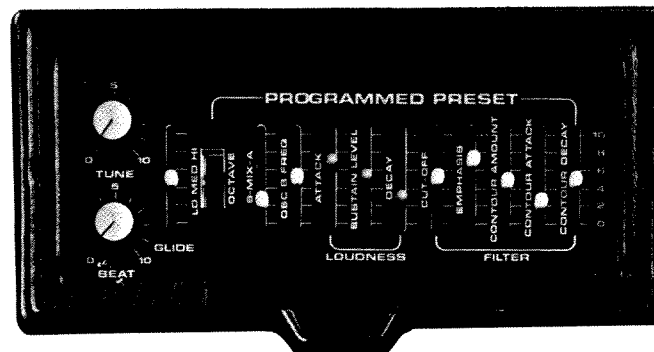

FIGURE 4-3 FRONT PANEL VARIABLES CONTROLS

# SECTION 5 REPLACEMENT PARTS LIST

## 5.1 ORDERING

The following lists specify parts available from Moog Music Inc., Customer Service Department, 2500 Walden Avenue, Buffalo, New York 14225, (716) 681-7242. Please specify the unit name, model, serial number, part description, electrical reference designator if applicable and part number when ordering.

### REPLACEMENT PARTS LIST

PART NUMBER	DESCRIPTION	QTY
<b><u>SUBASSEMBLIES</u></b>		
996-041091-001	Power Supply Printed Circuit Board Assembly .....	1
996-042112-001	Main Printed Circuit Board Assembly .....	1
978-041683-001	Side Panel, Assembly, L H .....	1
978-041683-002	Side Panel, Assembly, R H .....	1
997-040899-001	Foot Pedal Assembly, 13 Note .....	1
<b><u>CAPACITORS</u></b>		
945-040209-001	Capacitor, 10 uf, 25 VDC .....	3
945-040209-007	Capacitor, 470 uf, 35 VDC .....	3
945-040209-003	Capacitor, Aluminum, Electrolytic, 0.220 uf, 6 VDC .....	1
946-013181-683	Capacitor, Polystyrene, 0.068 uf .....	2
946-040190-102	Capacitor, Mylar, 0.001 uf .....	2
946-040190-104	Capacitor, Mylar, 0.1 uf .....	10
946-040190-224	Capacitor, Mylar, 0.22 uf .....	2
946-040231-002	Capacitor, Tantalum, 10 uf, 125 VDC .....	1
946-040231-005	Capacitor, Tantalum, 5.6 uf, 35 VDC .....	2
947-040200-103	Capacitor, Disc, 0.1 uf .....	23
947-042020-101	Capacitor, Disc, 100 Pf .....	3
947-042020-102	Capacitor, Disc, 0.001 uf .....	3
947-042020-501	Capacitor, Disc, 500 Pf .....	3
947-042020-680	Capacitor, Disc, 68 Pf .....	1
<b><u>DIODES</u></b>		
919-041075-001	Diode, 1N4148 or 1N914 .....	25
919-042019-004	Diode, 1N4004 .....	8
939-040875-001	Diode, LED, Red .....	7
<b><u>HEADERS, HOUSINGS, TERMINALS AND SOCKETS</u></b>		
910-041716-003	Header, Printed Circuit Board, 3 Pin .....	1
910-041716-004	Header, Printed Circuit Board, 4 Pin .....	1

## REPLACEMENT PARTS LIST

PART NUMBER	DESCRIPTION	QTY
<b>HEADERS, HOUSINGS, TERMINALS AND SOCKETS (Continued)</b>		
910-041717-003	Housing, Socket, 3 Pin	1
910-041717-004	Housing, Socket, 4 Pin	1
910-041721-006	Header, Printed Circuit Board, 6 Pin	2
910-041721-008	Header, Printed Circuit Board, 8 Pin	1
910-041721-016	Header, Printed Circuit Board, 16 Pin	1
910-041722-006	Housing, Socket, 6 Pin	1
910-041723-006	Housing, Amp, 6 Pin	1
910-041723-009	Housing, Amp, 9 Pin	1
910-041725-001	Pins, (For 6 and 9 Pin Housings)	15
910-041737-001	Tab, Ground	2
910-041738-001	Terminal, 250 Series, Faston	17
910-042049-001	Sockets, (For 3, 4 and 6 Pin Housings)	13
911-041351-002	Solder Lug, No. 4, Locking	1
906-040307-007	Socket, Integrated Circuit, SIL, 7 Pin	16
<b>INTEGRATED CIRCUITS</b>		
991-041087-001	Integrated Circuit, CD4016AE	7
991-041088-001	Integrated Circuit, CD4011AE	1
991-042547-001	Integrated Circuit, CD4066BE	1
991-041089-001	Integrated Circuit, CA3080	5
991-041094-001	Integrated Circuit, SN7410	2
991-041096-001	Integrated Circuit, SN7426N	3
991-041099-001	Integrated Circuit, SN7474N	2
991-041102-001	Integrated Circuit, MC1458CP-1	1
991-041104-001	Integrated Circuit, LM3046	1
991-041111-001	Integrated Circuit, SG1468N, $\pm 15$ VDC	1
991-041112-001	Integrated Circuit, 78MO5UC, $\pm 15$ VDC, Reg	1
991-041113-001	Integrated Circuit, SN74L04N	1
991-041114-001	Integrated Circuit, SN7451N	1
991-041119-001	Integrated Circuit, 741A	3
<b>JACK, LABELS AND OVERLAYS</b>		
910-041306-001	Jack, Phone, 1/4 in.	1
913-040825-001	Label, Patent	1
913-040882-001	Overlay, Loudness	1
913-040883-001	Overlay, Filter	1
913-040892-001	Overlay, Power	1
913-040906-001	Overlay, Preset Panel	1
913-040913-001	Overlay, Switch Panel	1
913-040932-001	Moog Logo	1
913-040934-001	Tag, Voltage, Red	AR
913-040936-001	Tag, Quick Setup, Green	AR
914-040878-001	Filter, Strip, Pedal	2
<b>PLASTICS, RUBBER AND KEY PARTS</b>		
915-040524-002	Tip, Vinyl, 0.125 x 3/8 in., White	8

## REPLACEMENT PARTS LIST

PART NUMBER	DESCRIPTION	QTY
<b><u>PLASTICS, RUBBER AND KEY PARTS (Continued)</u></b>		
915-041918-001	Knob, 3/4 in. Dia., with Hex Socket Setscrew . . . . .	2
915-041921-001	Knob, Push-On Type. . . . .	1
916-040885-001	Pad, Rubber . . . . .	4
916-040885-003	Pad, Spacer, 1/8 in. thick . . . . .	2
959-040895-001	Pedal, Top, Rubber . . . . .	2
961-041853-001	Plug, Cap, Flush Hd. . . . .	1
976-040793-001	Tie Wrap, Small Cable . . . . .	8
977-041637-003	Grommet, Strain Relief, Power Cord . . . . .	1
915-043301-001	Key Cap, Brown, Natural . . . . .	8
915-043302-001	Key Cap, Black, Sharp and Flat . . . . .	5
975-043303-001	Spring, Key Return . . . . .	13
917-043304-001	Contact, Key switch . . . . .	13
904-040065-015	Tip, Vinyl, 0.125 x 3/8 in., Red . . . . .	3
932-040761-001	Bag, Plastic, Taurus . . . . .	1
932-040762-001	Carton, Shipping, Taurus . . . . .	1
957-041790-001	Patch Cord, 5 foot . . . . .	1
<b><u>PRESET PANEL AND DOOR PARTS</u></b>		
961-040905-001	Preset Panel . . . . .	1
962-040879-001	Mag, Strip, W/PSA, 3-1/2 W x 1/16 in. Th. . . . .	4
962-040889-001	Spacer, Trim . . . . .	2
909-040880-001	Pin, Door Frame . . . . .	2
922-040894-001	Door, Plexiglass . . . . .	1
967-040891-001	Side, Door Frame, Right and Left . . . . .	2
967-040891-003	Side, Door Frame, Top and Bottom. . . . .	2
975-040884-001	Spring, Compression, Door Frame . . . . .	1
<b><u>POWER SUPPLY AND FUSES</u></b>		
906-041619-001	Fuse Block, Dual . . . . .	1
939-041620-001	Fuse, Slow Blow, 1/8 Amp, 3AG. . . . .	2
954-041647-001	Transformer, 130/250V, 250 Ma. . . . .	1
962-040890-001	Bracket, Transformer . . . . .	1
957-041789-001	Power Cord, 8 ft, 18GA, 3 Connector, Gray . . . . .	1
<b><u>PEDESTAL AND FRAME PARTS</u></b>		
962-040896-001	Cover, Pedal Keyboard Assembly, Mod. . . . .	1
963-040900-001	Plate, Rear Cover . . . . .	1
964-040897-001	Guide, Printed Circuit Board . . . . .	1
964-040907-001	Frame, Preset Panel . . . . .	1
964-040908-001	Frame, Slide Panel . . . . .	2
967-040881-001	Bracket, Clip, Rear Cover Support . . . . .	2
967-040888-001	Bracket, Rear Pad. . . . .	2
967-040910-001	Bracket, Switch . . . . .	1
967-040911-001	Pedestal, R H . . . . .	1
967-040911-002	Pedestal, L H . . . . .	1
967-040912-001	Shell . . . . .	1

## REPLACEMENT PARTS LIST

PART NUMBER	DESCRIPTION	QTY
<b>PEDESTAL AND FRAME PARTS (Continued)</b>		
967-040935-001	Heat Sink .....	1
970-040902-001	Control Chassis .....	1
973-040513-017	Spacer, No. 6, Clear, 1/4 in. OD x 3/8 in. long .....	2
973-040518-006	Spacer, 4-40 x 5/8 in. long, (3/16 Hex.) .....	4
975-040893-001	Spacer Bar .....	2
976-040765-002	Clamp, Cable, 3/16 in. ....	1
<b>RESISTORS</b>		
852-312039-001	Resistor, 3.9 Ohm, $\pm 5\%$ , 1/4W .....	2
852-312101-001	Resistor, 100 Ohm, $\pm 5\%$ , 1/4W .....	2
852-312102-001	Resistor, 1K Ohm, $\pm 5\%$ , 1/4W .....	9
852-312103-001	Resistor, 10K Ohm, $\pm 5\%$ , 1/4W .....	9
852-312104-001	Resistor, 100K Ohm, $\pm 5\%$ , 1/4W .....	6
852-312105-001	Resistor, 1 Megohm, $\pm 5\%$ , 1/4W .....	1
852-312114-001	Resistor, 110K Ohm, $\pm 5\%$ , 1/4W .....	1
852-312122-001	Resistor, 1.2K Ohm, $\pm 5\%$ , 1/4W .....	1
852-312123-001	Resistor, 12K Ohm, $\pm 5\%$ , 1/4W .....	3
852-312151-001	Resistor, 150 Ohm, $\pm 5\%$ , 1/4W .....	7
852-312153-001	Resistor, 15K Ohm, $\pm 5\%$ , 1/4W .....	3
852-312183-001	Resistor, 18K Ohm, $\pm 5\%$ , 1/4W .....	1
852-312185-001	Resistor, 1.8 Megohm, $\pm 5\%$ , 1/4W .....	1
852-312203-001	Resistor, 20K Ohm, $\pm 5\%$ , 1/4W .....	1
852-312222-001	Resistor, 2.2K Ohm, $\pm 5\%$ , 1/4W .....	2
852-312223-001	Resistor, 22K Ohm, $\pm 5\%$ , 1/4W .....	11
852-312224-001	Resistor, 220K Ohm, $\pm 5\%$ , 1/4W .....	3
852-312225-001	Resistor, 2.2 Megohm, $\pm 5\%$ , 1/4W .....	2
852-312272-001	Resistor, 2.7K Ohm, $\pm 5\%$ , 1/4W .....	2
852-312273-001	Resistor, 27K Ohm, $\pm 5\%$ , 1/4W .....	3
852-312274-001	Resistor, 270K Ohm, $\pm 5\%$ , 1/4W .....	2
852-312304-001	Resistor, 300K Ohm, $\pm 5\%$ , 1/4W .....	1
852-312331-001	Resistor, 330 Ohm, $\pm 5\%$ , 1/4W .....	3
852-312333-001	Resistor, 33K Ohm, $\pm 5\%$ , 1/4W .....	1
852-312364-001	Resistor, 360K Ohm, $\pm 5\%$ , 1/4W .....	1
852-312395-001	Resistor, 3.9 Megohm, $\pm 5\%$ , 1/4W .....	1
852-312433-001	Resistor, 43K Ohm, $\pm 5\%$ , 1/4W .....	1
852-312470-001	Resistor, 47 Ohm, $\pm 5\%$ , 1/4W .....	8
852-312472-001	Resistor, 4.7K Ohm, $\pm 5\%$ , 1/4W .....	9
852-312473-001	Resistor, 47K Ohm, $\pm 5\%$ , 1/4W .....	4
852-312474-001	Resistor, 470K Ohm, $\pm 5\%$ , 1/4W .....	2
852-312512-001	Resistor, 5.1K Ohm, $\pm 5\%$ , 1/4W .....	2
852-312513-001	Resistor, 51K Ohm, $\pm 5\%$ , 1/4W .....	2
852-312515-001	Resistor, 5.1 Megohm, $\pm 5\%$ , 1/4W .....	3
852-312562-001	Resistor, 5.6K Ohm, $\pm 5\%$ , 1/4W .....	1
852-312563-001	Resistor, 56K Ohm, $\pm 5\%$ , 1/4W .....	4
852-312683-001	Resistor, 68K Ohm, $\pm 5\%$ , 1/4W .....	1



## REPLACEMENT PARTS LIST

PART NUMBER	DESCRIPTION	QTY
<b><u>RESISTORS (Continued)</u></b>		
852-312823-001	Resistor, 82K Ohm, $\pm 5\%$ , 1/4W	1
852-312912-001	Resistor, 9.1K Ohm, $\pm 5\%$ , 1/4W	1
853-221502-031	Resistor, 15K Ohm, $\pm 1\%$ , 1/10W	1
853-224752-031	Resistor, 47.5K Ohm, $\pm 1\%$ , 1/10W	1
924-040187-002	Resistor, 35 Ohm, 5 W, with Axial Lead	1
925-040265-002	Resistor, Rotary, Carbon, Audio, 100K Ohm.	1
925-040266-001	Resistor, Trim, 10K Ohm, Cermet	1
925-040270-001	Resistor, Carbon, Slide, Linear, 100K Ohm	1
925-040270-002	Resistor, Carbon, Slide, Audio, 100K Ohm	1
925-040270-003	Resistor, Carbon, Slide, Rev. Audio, 500K Ohm.	2
925-040270-004	Resistor, Carbon, Slide, 10K Ohm	2
925-040270-005	Resistor, Carbon, Slide, 10K Ohm	1
925-040270-006	Resistor, Carbon, Slide, Rev. Audio 50K Ohm	1
925-040270-007	Resistor, Carbon, Slide, Audio Glide, 5 Megohm.	1
925-040270-008	Resistor, Carbon, Slide, Linear, 1K Ohm	2
925-040271-001	Resistor, Carbon, Slide, Linear, 100K Ohm	2
925-040275-002	Resistor, Carbon, Trim, 1K Ohm.	2
925-040275-003	Resistor, Carbon, Trim, 50K Ohm	1
925-040276-001	Resistor, Cermet, Rotary, 1K Ohm	1
925-040276-002	Resistor, Cermet, Rotary Linear, 2.5K Ohm	1
925-040276-003	Resistor, Carbon, Trim, 100K Ohm	2
949-040876-001	Frequency Divider Network	5
949-040877-001	VCO Divider, Internal Circuit, CTS Series 760	2
949-040887-001	Keyboard Resistor String (13 Resistors)	1
949-040918-001	Resistor Package, Cermet, 1K Ohm	3
949-041120-001	Resistor Package, Cermet, 100K Ohm	1
964-040898-001	Potentiometer, Pedal Slide	2
<b><u>SWITCHES</u></b>		
960-041303-001	Switch, Slide, 115/230V	1
960-041755-001	Switch, Rocker, DPDT	1
960-041757-001	Switch, Slide, 2P3T	1
960-041759-001	Switch, Foot, SPDT	7
<b><u>TRANSISTORS</u></b>		
991-041049-001	Transistor, NPN, TIP29	1
991-041050-001	Transistor, PNP, TIP30	1
991-041052-001	Transistor, PNP, 2N3906	4
991-041053-001	Transistor, NPN, DI6P1, Darlington.	4
991-041054-001	Transistor, E402, Dual FET	1
991-041055-001	Transistor, E112	2
991-042017-001	Transistor, NPN, 2N3392	10

**REPLACEMENT PARTS LIST**

PART NUMBER	DESCRIPTION	QTY
<b><u>WASHERS, NUTS, SCREWS AND RIVETS</u></b>		
801-045331-000	Nut, 6-32 .....	4
801-065541-000	Nut, 10-32 .....	4
806-023039-006	Screw, Machine, Pan Hd., 4-40 x 3/8 in. ....	8
806-045039-004	Screw, Pan Hd., 6-32 x 1/4 in. ....	14
806-045039-008	Screw, Pan Hd., 6-32 x 1/2 in. ....	8
806-065039-012	Screw, Pan Hd., 10-32 x 3/4 in. ....	4
811-040039-008	Screw, Self Tap, Pan Hd., No. 6 x 1/2 in. ....	20
811-040039-010	Screw, Self Tap, Truss Hd., Type A, No. 6 x 5/8 in. ....	2
811-040239-008	Screw, Self Tap, Flat Hd., No. 6A x 1/2 in. ....	4
812-078039-006	Screw, Pan Hd., 1/4 - 20 x 3/8 in. ....	4
902-017448-001	Insert, Tap Lock, 6-32 .....	8
902-040500-001	Nut, Speed, Type U, No. 6. ....	4
902-040504-001	Nut, 3/8 in. ....	5
903-040439-052	Screw, Truss Hd., 6-32 x 3/8 in. ....	4
904-040495-016	Washer, Lock, No. 6 .....	18
904-040495-018	Washer, Lock, No. 10, Int. ....	4
904-040495-021	Washer, Lock, 3/8 in. ....	4
904-040507-003	Spacer, 6 x 1/4 x 1/16 in. ....	2
904-041390-017	Washer, Flat, No. 6 .....	1
904-041391-001	Washer, Flat, No. 6 .....	4
904-041392-040	Washer, Flat, No. 10 .....	4
904-041395-048	Washer, Lock, Spring, No. 4 .....	4
904-041546-005	Washer, Fiber, No. 4 .....	4
904-042026-001	Washer, Flat, 3/8 in. ....	4
905-040498-001	Rivet, Pop, 1/8 in. Dia. ....	4
905-040498-002	Rivet, Pop, 1/8 in. Dia. ....	25
905-050498-013	Rivet, Pop, 5/32 Dia. x 0.530 in. lg. ....	13
905-040525-002	Clip, 1/4, Printed Circuit Board .....	2

## SECTION 6 MODIFICATIONS

### 6.1 MAIN PRINTED CIRCUIT BOARD

#### 6.1.1 MOUNTING

In the event that the main printed circuit board becomes dislodged during shipment, perform the following modification. This allows adjustment within the Taurus shell to correct for tolerance buildup. The parts required to perform this procedure are tabulated below:

PART NO.	DESCRIPTION	QTY
806-045239-008	Flat Head Machine Screw, Black Oxide, 6-32 x 1/2 in.	4
902-041394-003	Nut, 6-32	8
904-040495-016	Washer, Lock	8

a) Remove the main printed circuit board as described in Section 3, paragraph 3.2.

b) Drill out the four pop rivets that are used to attach the main printed circuit board to the metal pushbutton subassembly frame with a 1/8 inch (3.175mm) drill bit.

c) Enlarge the printed circuit board mounting with a 3/16 inch (4.77mm) drill bit.

d) Insert four machine screws, 6-32 x 1/2 inch (12.7mm) long part number 806-045239-008, in the beveled side of the metal pushbutton subassembly frame. Secure each screw in place with a lock washer,

part number 904-040495-016, and a nut, 6-32, part number 902-041394-003.

#### NOTE

When installed, the four screws project sufficiently to permit printed circuit board mounting.

e) Place the main printed circuit board on the four screws projecting from the pushbutton frame and loosely attach with four lock washers and 6-32 nuts.

f) Gently push the main printed circuit board into the plastic rail on the rear of the Taurus shell.

#### NOTE

Ensure that the foot sliders are correctly fitted in the foot slider track, Section 3, paragraph 3.3.

g) Tighten the four nuts securing the board to the pushbutton frame after board is fitted snugly in place.

h) Reassemble the metal pushbutton subassembly frame as described in Section 3, paragraph 3.3.

### 6.1.2 POTENTIOMETER REPLACEMENTS

Replace old potentiometers for improved reliability and oscillator stability (refer to Figure 6-1).

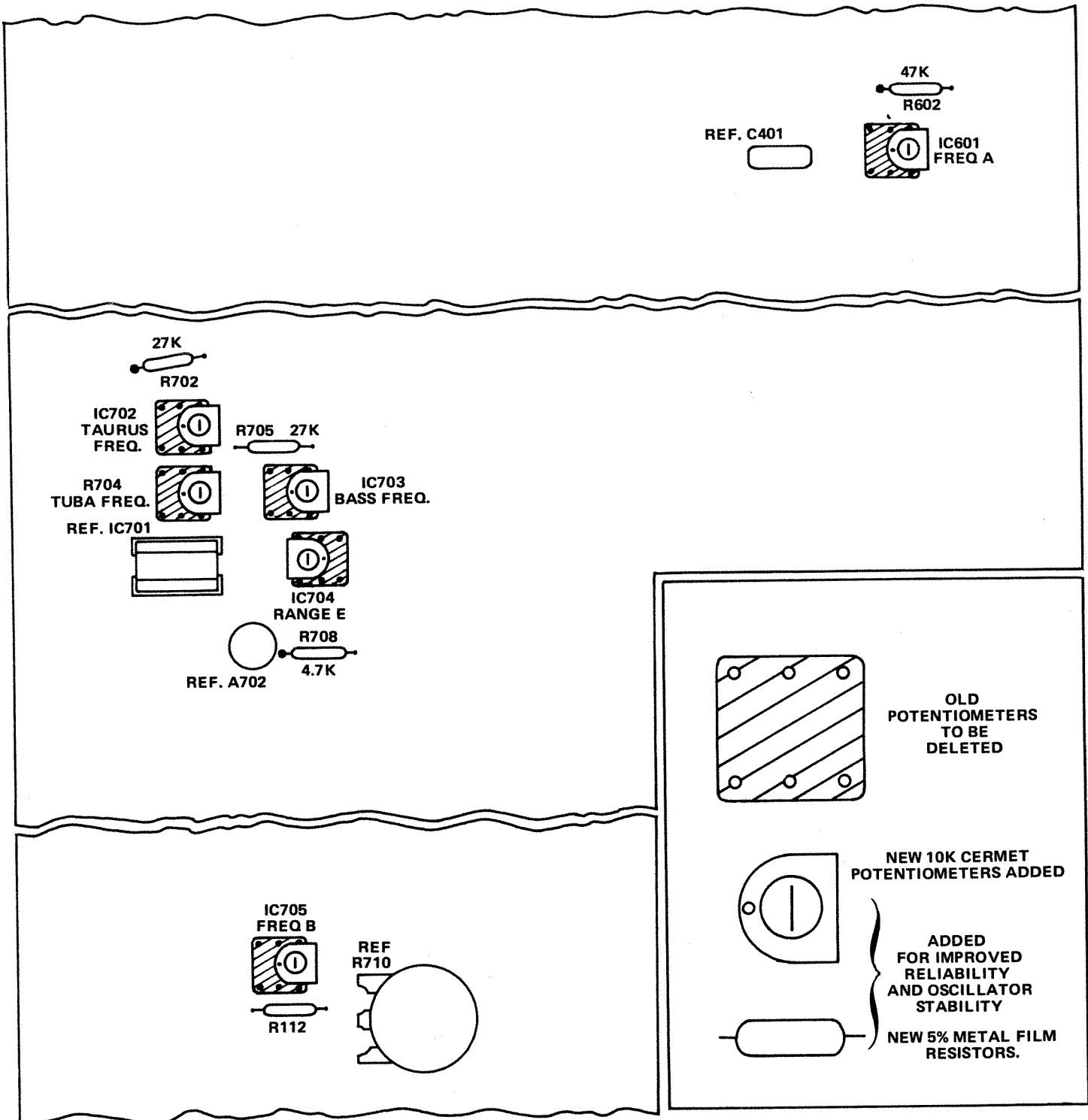
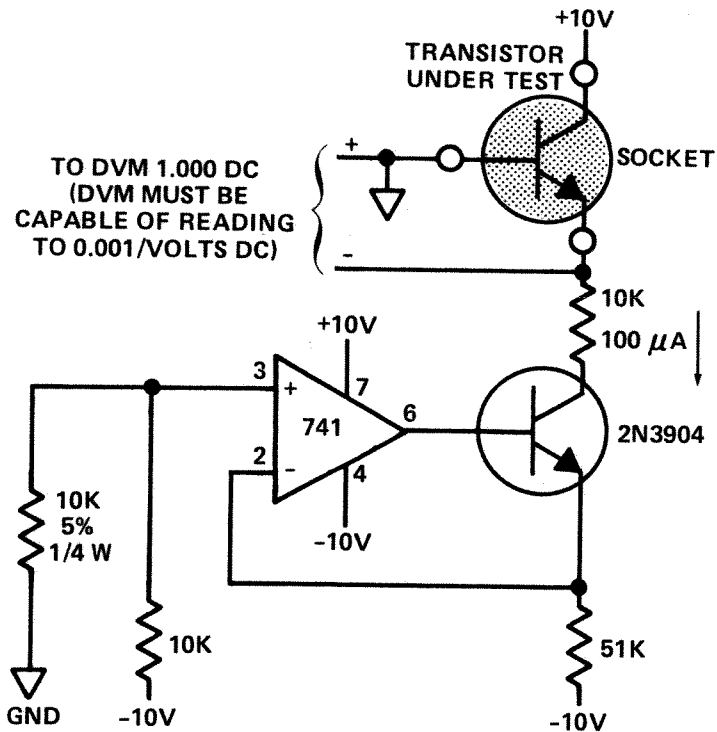

FIGURE 6-1 POTENTIOMETER REPLACEMENTS

# MATCHING TRANSISTOR CIRCUITS

## NPN TRANSISTORS 2N3904, 2N3902 (ETC.)



## PNP TRANSISTORS 2N3906, (ETC.)

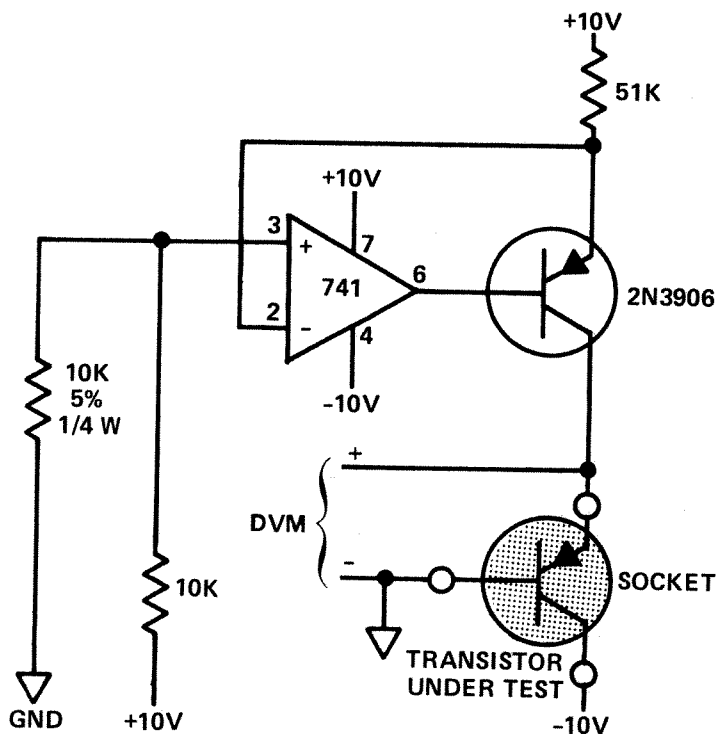

### MATCHING PROCEDURE

1. SETUP  $\pm 10V$  SUPPLIES TO  $\pm 10.00 V$  OR  $\pm 15.00 V$ .
2. TAKE TRANSISTORS (APPROXIMATELY 20) AND PLACE THEM IN STYROFOAM TO STABILIZE AT ROOM TEMPERATURE.
3. PLACE TRANSISTORS INTO SOCKET, ONE AT A TIME, AND MEASURE BASE TO EMITTER VOLTAGE. DO NOT USE YOUR FINGERS. USE GLOVES OR PLIERS WITH INSULATING JAWS. YOUR FINGER HEAT WILL CAUSE THE READINGS TO VARY.
4. MARK DOWN THE  $V_{be}$  FROM THE DVM AND FIND TWO TRANSISTORS THAT THE  $V_{be}$  MATCHES TO  $\pm 2 MV$ .
5. EXAMPLE:

$$\begin{aligned} \text{TRANSISTOR 1} &= 0.600 \\ \text{TRANSISTOR 2} &= \frac{0.598}{0.002} \end{aligned}$$

FIGURE 7-5 MATCHING TRANSISTOR CIRCUITS

# **Taurus**

## **Pedal Synthesizer**

Another Quality Product from Norlin

**MOOG MUSIC INC.**

2500 Walden Avenue, Buffalo, New York 14225

**NORLIN MUSIC**

7373 N. Cicero Avenue, Lincolnwood, Illinois 60646

**NORLIN MUSIC INSTRUMENTS LIMITED**

51 Nantucket Blvd., Scarborough, Ontario, Canada M1P 2N6

**NORLIN MUSIC LIMITED**

114 Charing Cross Road, London, England

**NORLIN MUSIC SERVICES B.V.**

Waalhaven, Z. Z. 48, Rotterdam, The Netherlands

PRINTED IN U.S.A.  
993-040749-001  
T.G. - 8/78 - 1M

COPYRIGHT - 1978  
MOOG MUSIC INC.

**Norlin**<sup>TM</sup>