

®
MAC

SWA2801z
ACTIVE SUBWOOFER
SYSTEM USER'S MANUAL

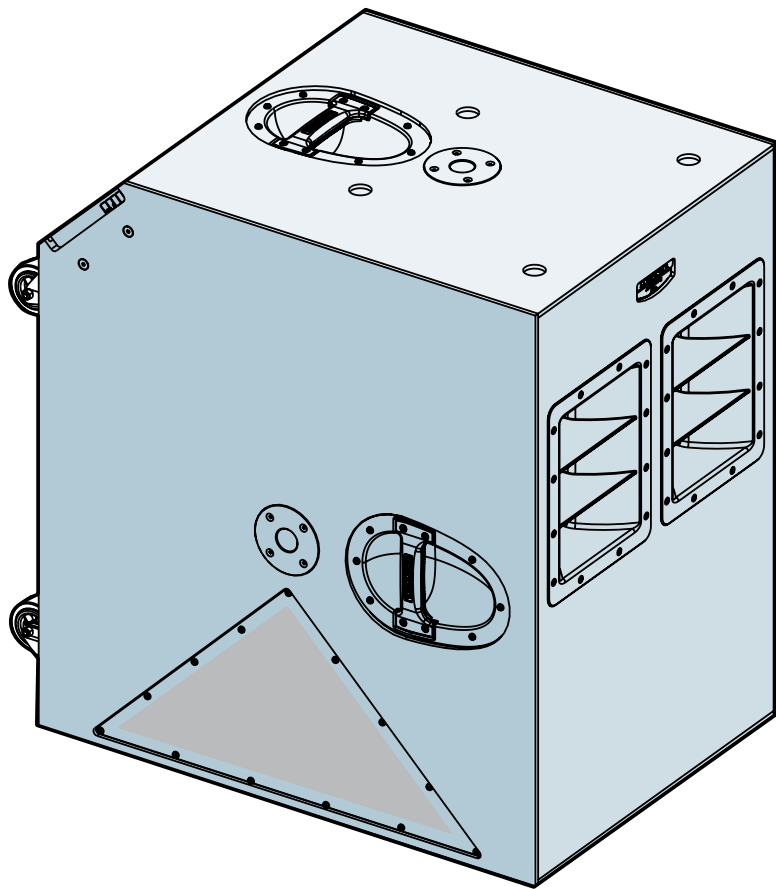

IMPORTANT SAFETY INSTRUCTIONS

1. Read these instructions.
2. Keep these instructions.
3. Heed all warnings.
4. Follow all instructions.
5. Do not use this apparatus near water.
6. Clean only with dry cloth.
7. Do not block any ventilation openings. Install in accordance with the manufacturer's instructions.
8. Do not install near any heat sources such as radiators, heat registers, stoves, or other apparatus (including amplifiers) that produce heat.
9. Do not defeat the safety purpose of the polarized or grounding-type plug. A polarized plug has two blades with one wider than the other. A grounding-type plug has two blades and a third grounding prong. The wide blade or the third prong are provided for your safety. If the provided plug does not fit into your outlet, consult an electrician for replacement of the obsolete outlet.
10. Protect the power cord from being walked on or pinched particularly at plugs, convenience receptacles, and the point where they exit from the apparatus.
11. Only use attachments/accessories specified by the manufacturer.
12. Use only with a cart, stand, tripod, bracket, or table specified by the manufacturer, or sold with the apparatus. When a cart is used, use caution when moving the cart/apparatus combination to avoid injury from tip-over.
13. Unplug this apparatus during lightning storms or when unused for long periods of time.
14. Refer all servicing to qualified service personnel. Servicing is required when the apparatus has been damaged in any way, such as power-supply cord or plug is damaged, liquid has been spilled or objects have fallen into the apparatus, the apparatus has been exposed to rain or moisture, does not operate normally, or has been dropped.
15. This apparatus shall not be exposed to dripping or splashing, and no object filled with liquids, such as vases or beer glasses, shall be placed on the apparatus.
16. This apparatus has been designed with Class-I construction and must be connected to a mains socket outlet with a protective earthing connection (the third grounding prong).
17. This apparatus has been equipped with an all-pole, rocker-style AC mains power switch. This switch is located on the rear panel and should remain readily accessible to the user.
18. This apparatus does not exceed the Class A/Class B (whichever is applicable) limits for radio noise emissions from digital apparatus as set out in the radio interference regulations of the Canadian Department of Communications.

ATTENTION — Le présent appareil numérique n'émet pas de bruits radioélectriques dépassant les limites applicables aux appareils numériques de class A/de class B (selon le cas) prescrites dans le règlement sur le brouillage radioélectrique édicté par les ministere des communications du Canada.

19. Exposure to extremely high noise levels may cause permanent hearing loss. Individuals vary considerably in susceptibility to noise-induced hearing loss, but nearly everyone will lose some hearing if exposed to sufficiently intense noise for a period of time. The U.S. Government's Occupational Safety and Health Administration (OSHA) has specified the permissible noise level exposures shown in the following chart.

According to OSHA, any exposure in excess of these permissible limits could result in some hearing loss. To ensure against potentially dangerous exposure to high sound pressure levels, it is recommended that all persons exposed to equipment capable of producing high sound pressure levels use hearing protectors while the equipment is in operation. Ear plugs or protectors in the ear canals or over the ears must be worn when operating the equipment in order to prevent permanent hearing loss if exposure is in excess of the limits set forth here.

| Duration Per Day In Hours | Sound Level dBA, Slow Response | Typical Example |
|------------------------------|-----------------------------------|---|
| 8 | 90 | Duo in small club |
| 6 | 92 | |
| 4 | 95 | Subway Train |
| 3 | 97 | |
| 2 | 100 | Very loud classical music |
| 1.5 | 102 | |
| 1 | 105 | Dave screaming at Steve about deadlines |
| 0.5 | 110 | |
| 0.25 or less | 115 | Loudest parts at a rock concert |

PORTABLE CART WARNING



Carts and stands - The Component should be used only with a cart or stand that is recommended by the manufacturer. A Component and cart combination should be moved with care. Quick stops, excessive force, and uneven surfaces may cause the Component and cart combination to overturn.



CAUTION AVIS

RISK OF ELECTRIC SHOCK
DO NOT OPEN

RISQUE DE CHOC ELECTRIQUE
NE PAS OUVRIR



CAUTION: TO REDUCE THE RISK OF ELECTRIC SHOCK DO NOT REMOVE COVER (OR BACK) NO USER-SERVICEABLE PARTS INSIDE REFER SERVICING TO QUALIFIED PERSONNEL

ATTENTION: POUR EVITER LES RISQUES DE CHOC ELECTRIQUE, NE PAS ENLEVER LE COUVERCLE. AUCUN ENTRETIEN DE PIECES INTERIEURES PAR L'USAGER. CONFIER L'ENTRETIEN AU PERSONNEL QUALIFIE.

AVIS: POUR EVITER LES RISQUES D'INCENDIE OU D'ELECTROCUTION, N'EXPOSEZ PAS CET ARTICLE A LA PLUIE OU A L'HUMIDITE

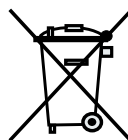



The lightning flash with arrowhead symbol within an equilateral triangle is intended to alert the user to the presence of uninsulated "dangerous voltage" within the product's enclosure, that may be of sufficient magnitude to constitute a risk of electric shock to persons.

Le symbole éclair avec point de flèche à l'intérieur d'un triangle équilatéral est utilisé pour alerter l'utilisateur de la présence à l'intérieur du coffret de "voltage dangereux" non isolé d'ampèreur suffisante pour constituer un risque d'électrocution.



The exclamation point within an equilateral triangle is intended to alert the user of the presence of important operating and maintenance (servicing) instructions in the literature accompanying the appliance.

Le point d'exclamation à l'intérieur d'un triangle équilatéral est employé pour alerter les utilisateurs de la présence d'instructions importantes pour le fonctionnement et l'entretien (service) dans le livret d'instruction accompagnant l'appareil.

WARNING — To reduce the risk of fire or electric shock, do not expose this appliance to rain or moisture.

WARNING — The cabinet has no rigging points and is not suitable for flying. Never attempt to suspend the cabinet by its handles.



The SWA2801z can produce a maximum SPL of 130 dB @ 1m

CONTENTS

| | |
|--|-----------|
| IMPORTANT SAFETY INSTRUCTIONS | 2 |
| INTRODUCTION..... | 3 |
| REAR PANEL DESCRIPTION | 4 |
| HOOKUP DIAGRAMS..... | 5 |
| CONNECTIONS..... | 6 |
| PLACEMENT..... | 6 |
| AC POWER | 7 |
| THERMAL CONSIDERATIONS..... | 7 |
| SERVICE INFORMATION..... | 7 |
| Troubleshooting | 7 |
| Repair..... | 9 |
| SWA2801z SPECIFICATIONS | 10 |
| SWA2801z LIMITED WARRANTY..... | 11 |

INTRODUCTION

Thank you for choosing Mackie's active sound reinforcement speaker systems.

The SWA2801z is a high-output active subwoofer system. It features two high-precision 18" transducers combined with application-specific amplifier technology. The system is composed of a single, compact subwoofer cabinet with built-in control and amplifier electronics.

Connecting and setting up the SWA2801z is a breeze, even for your brother-in-law. It accepts a stereo or mono line-level signal via female XLR input jacks. Male XLR Thru jacks are provided for daisy-chaining the signal to additional SWA2801z cabinets. The built-in crossover separates the low frequencies from the high frequencies, and routes the high frequencies to the male XLR high-pass output jacks. Connect these to the inputs of full-range active speakers, or to an amplifier powering a pair of passive speakers.

A Phase switch gives you the option of reversing the polarity of the signal to the subwoofer by 180°. A Subwoofer Level control allows you to adjust the balance between the subwoofer and the full-range speakers.

The built-in amplifier produces 800 watts of continuous power. The amplifier module sits on a heatsink that eliminates the need for fans, dramatically extending the amplifier's life expectancy, and eliminating maintenance cycles. A tremendous benefit of having the amplifier located within the subwoofer cabinet is that the SWA2801z functions as a system, optimizing acoustic, electronic, and mechanical designs to achieve the highest level of performance and value.

The cabinet is constructed with 15 mm thick multi-layered birch plywood. Carrying handles are integrated into each side for easy loading, and casters are attached for easy transport.

Don't forget to visit our website at www.mackie.com for more information about this and other Mackie products.

REAR PANEL DESCRIPTION

1. POWER Switch

Use this switch to turn the SWA2801z on and off. Make sure the signal source's level control is turned down before you turn it on.

2. AC Receptacle

This is where you connect the AC linecord to provide AC power to the SWA2801z's built-in power amplifier. Plug the linecord into an AC socket properly configured for your particular model.

3. LIMIT Indicator

The SWA2801z has a built-in limiter that prevents the amplifier outputs from overdriving the transducers. The LIMIT indicator lights when the limiter is activated. It's okay for the LIMIT indicator to blink occasionally, but if it blinks frequently or lights continuously, turn down the level control until the LIMIT indicator only blinks occasionally.

4. SIGNAL Present Indicator

This LED illuminates whenever there is a signal present at the FULL RANGE INPUT connector on the rear panel.

5. THERMAL Indicator

The SWA2801z has a thermal protection circuit that monitors the internal temperature of the amplifiers and heatsink. If the internal temperature should exceed a safe operating level, this indicator lights and the signal is muted to allow the amplifier to cool. When the temperature cools to a safe level once again, the thermal protection circuit deactivates and normal operation resumes.

Note: Activation of the thermal protection circuit is an indication that you should take steps to avoid continued thermal problems. See "Thermal Considerations" on page 7.

6. POWER Indicator

When the POWER switch is turned on and the linecord is connected to an active AC power supply, this indicator lights green to let you know that you're ready to rock and roll. The cool blue LED on the front of the cabinet works in the same way.

7. FULL RANGE INPUT

These are female XLR-type connectors that accept a balanced line-level signal from a mixing console or other signal source.

8. THRU (FULL RANGE OUTPUT)

These are male XLR-type connectors that produce exactly the same signal that is connected to the FULL RANGE INPUT jack. Use it to daisy-chain several SWA2801z's together off the same signal source.

9. HIGH PASS (MID/HIGH FREQ) OUTPUT

These are male XLR-type connectors that produce the frequencies above 120 Hz. Connect these to a pair of full-range active speakers or to an amplifier/passive speaker combination. The SWA2801z reproduces the frequencies below 120 Hz.

10. SUBWOOFER LEVEL Control

This adjusts the subwoofer level. The center detent position provides 15 dB of headroom with a nominal +4 dBu input signal. Use this as a starting point for setting the balance between the subwoofer and the main speakers.

11. PHASE

This switch reverses the polarity of the subwoofer output. Depending on the placement of the SWA2801z subwoofer relative to the full-range speakers, you may get a better low-frequency response in the room if you reverse the polarity of the subwoofer's signal. Experiment with this switch to determine which position sounds best.

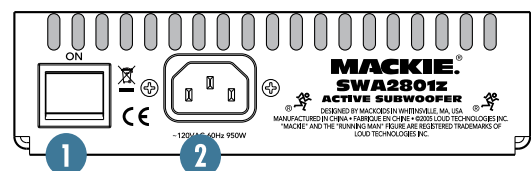
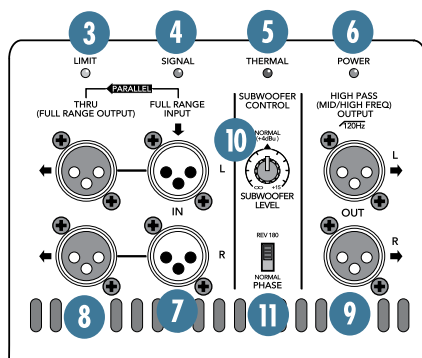

HOOKUP DIAGRAMS

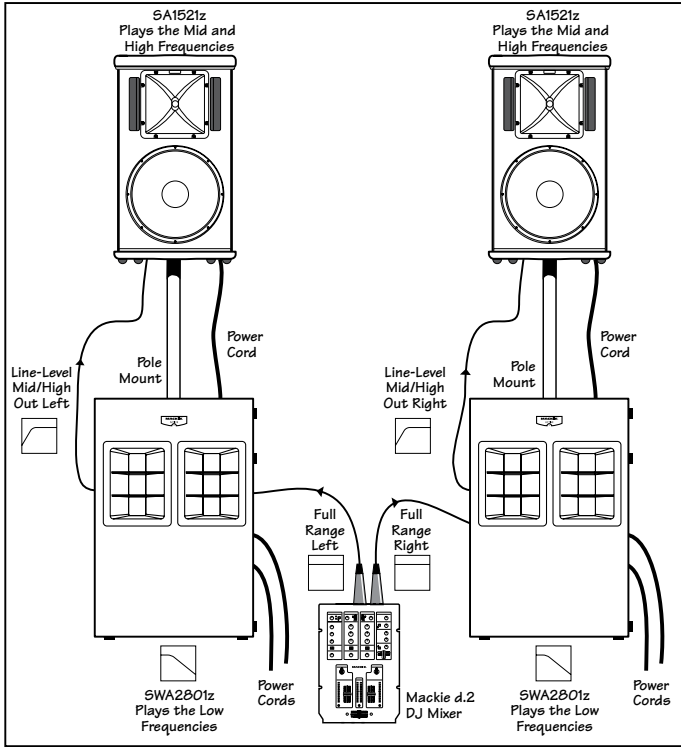

SWA2801z WITH SA1521z

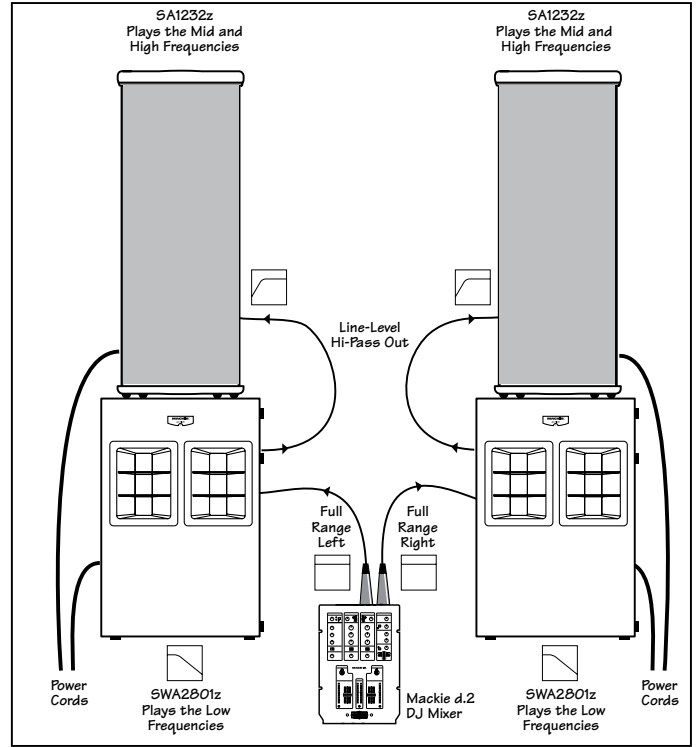

SWA2801zs WITH SA1232z

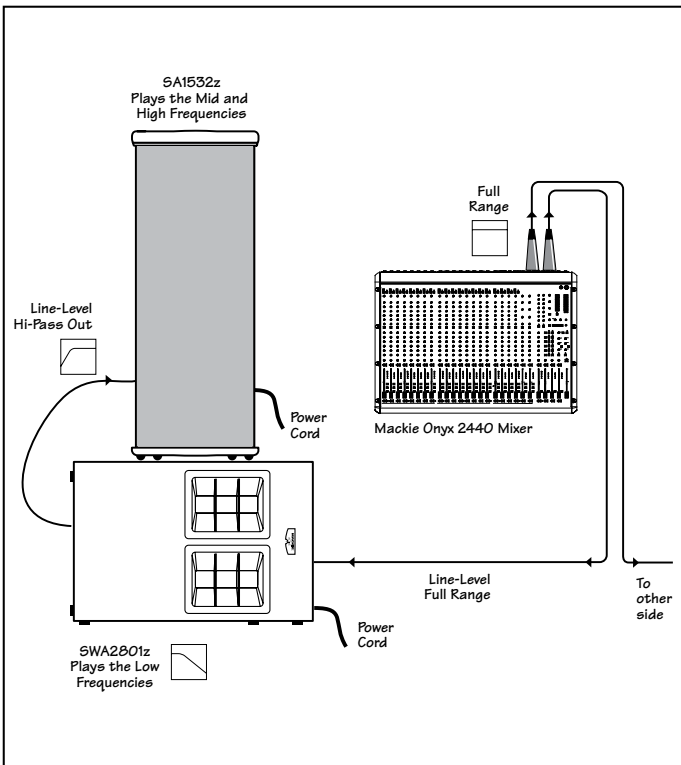

SWA2801z WITH SA1532z

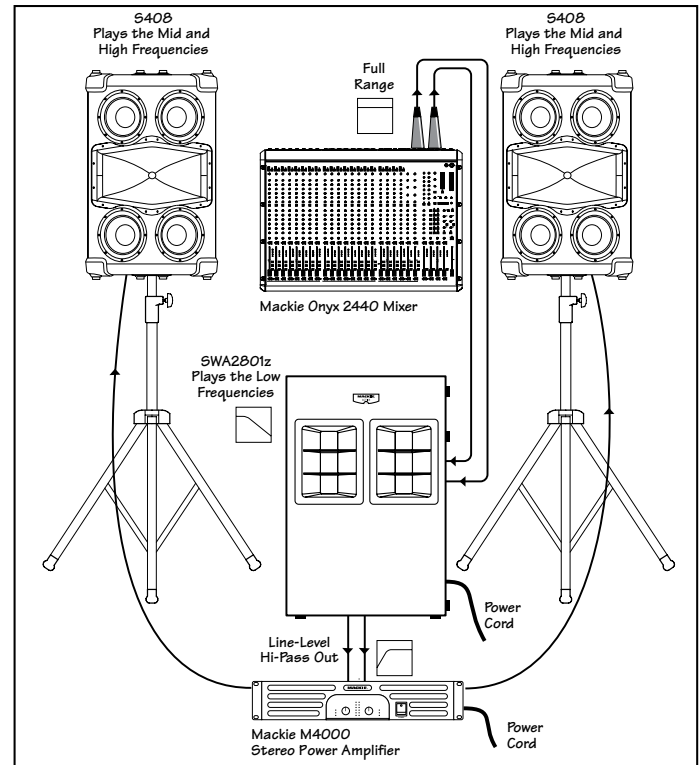

SWA2801z WITH S408 (PASSIVE)

CONNECTIONS

The SWA2801z has two female XLR inputs that accept a balanced line-level signal. When connecting a balanced signal, be sure it's wired per AES (Audio Engineering Society) standards:

| | XLR |
|-----------------|------------|
| Hot (+) | Pin 2 |
| Cold (-) | Pin 3 |
| Shield (Ground) | Pin 1 |

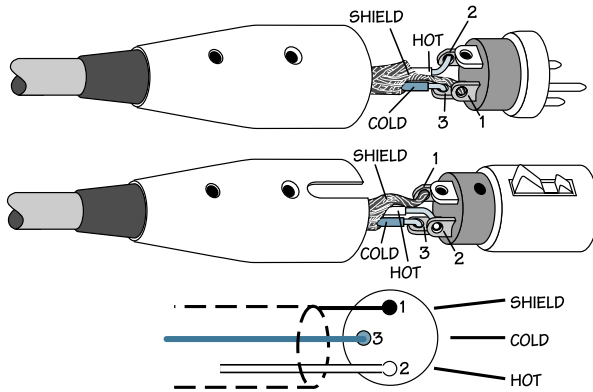

Balanced XLR Connectors

If connecting an unbalanced signal to the SWA2801z balanced input, be sure that the signal high (hot) connection is wired to Pin 2 and the unbalanced ground connection is wired to the low *and* the ground connections of the balanced input (Pins 3 and 1). If there are ground-loop problems, try connecting the unbalanced ground connection only to the input low connection (Pin 3), and leaving the input ground connection disconnected.

There are also two male XLR connectors labeled THRU (FULL RANGE OUTPUT) and two labeled HIGH PASS (MID/HIGH FREQ) OUTPUT. These are also wired according to the AES standard.

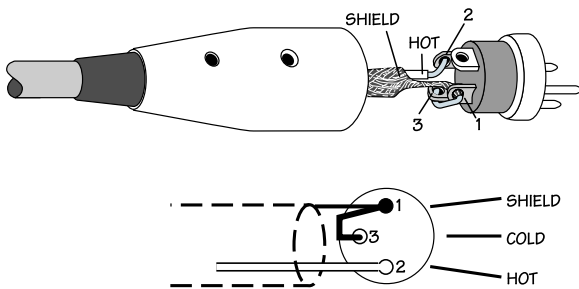

Unbalanced Male XLR Connector

The THRU output connectors allow you to connect more than one SWA2801z to your system. Simply plug the signal source (i.e., mixer output) into the first speaker's FULL RANGE INPUT jacks, and patch that speaker's THRU jacks to the next speaker's INPUT jacks, and so on, daisy-chaining multiple speakers.

The THRU jack is wired straight from the FULL RANGE INPUT connector — there is no electronic circuitry between — so the signal coming out of the THRU jack is exactly the same as the signal going in.

The HIGH PASS OUTPUT jacks provide a line-level signal of the frequencies above 120Hz that you connect to a pair of active speakers (or to a stereo amplifier powering a pair of passive speakers).

PLACEMENT

The SWA2801z subwoofer is designed to sit on the floor, either upright or on its side. (Feet are provided on the bottom and on one side.) A socket is provided on the top and one side of the SWA2801z for mounting the Mackie SA1521z or SRM450 active speakers. Use the optional Mackie speaker mounting pole (SPM100) to mount them on the SWA2801z (see Hookup Diagram on page 5).

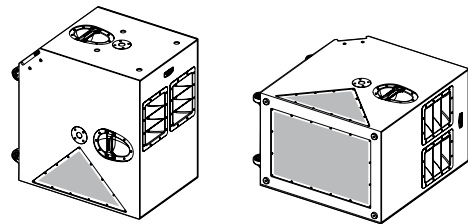

As with any powered components, protect the SWA2801z from exposure to moisture. If you are setting them up outdoors, make sure they are under cover if you expect rain.



WARNING: The cabinet has no rigging points and is not suitable for rigging. **NEVER** attempt to suspend the SWA2801z by its handles.

AC POWER

Be sure the SWA2801z is plugged into an outlet that is able to supply the correct voltage specified for your model. If the voltage should drop below 97 % of the specified line voltage, the built-in amplifiers will no longer be able to supply rated power. (They will continue to operate down to 80 % of the rated line voltage, but won't reach full power, resulting in lower headroom.)

Be sure the electrical service can supply enough amperage for all the components connected to it.

We recommend that a stiff (robust) supply of AC power be used because the amplifiers place high current demands on the AC line. The more power that is available on the line, the louder the speakers will play and the more peak output power will be available for cleaner, punchier bass. A suspected problem of “poor bass performance” is often caused by a weak AC supply to the amplifiers.



Never remove the ground pin on the power cord of the SWA2801z or any other component. This is very dangerous.

THERMAL CONSIDERATIONS

The SWA2801z has a powerful amplifier built-in. As amplifiers produce heat, it is important to dissipate the heat as quickly as possible. This results in increased reliability and longevity for the amplifier.

The amplifier module is mounted on a large heatsink, which is cooled by convection where cool air is drawn through its fins, carrying the heat away. In order for this convection cooling to work efficiently, it is important to provide adequate airspace behind the loudspeaker. When you position the SWA2801z, we recommend leaving at least six inches of air space behind it.

In the unlikely event of the amplifier overheating, a built-in thermal switch will activate, which mutes the signal. When the amplifier has cooled down to a safe operating temperature, the thermal switch resets itself, and the SWA2801z resumes normal operation.

If the thermal switch activates frequently, try turning down the level control a notch or two on the mixing console (or other signal source) or on the subwoofer itself to avoid overheating the amplifiers.

If the temperature in the room is too high, it could cause the amplifier to overheat. In this case, you should try aiming a fan at the rear panel to move more air across the heatsink panel.

SERVICE INFORMATION

If you think your Mackie product has a problem, please check out the following troubleshooting tips and do your best to confirm the problem. Visit the Support section of our website (www.mackie.com/support) where you will find lots of useful information such as FAQs, documentation, and user forums. You may find the answer to the problem without having to send your Mackie product away.

Troubleshooting

No power

- Our favorite question: Is it plugged in? Make sure the AC outlet is live (check with a tester or lamp).
- Our next favorite question: Is the POWER switch on? If not, try turning it on.
- Is the POWER LED on the rear panel glowing green? If not, make sure the AC outlet is live. If so, refer to “No sound” next.
- The internal AC line fuse may be blown. This is not a user serviceable part. If you suspect the AC line fuse is blown, please see the “Repair” section on page 9.

No sound

- Is the input LEVEL control for the input source or the subwoofer turned all the way down? Verify that all the volume controls in the system are properly adjusted.
- Is the signal source working (and making union scale)? Make sure the connecting cables are in good repair and securely connected at both ends. Make sure the output volume (gain) control on the mixing console is turned up sufficiently to drive the inputs of the speaker.

- Make sure the mixer does not have a Mute on or a Processor loop engaged. If you find something like this, make sure the volume/gain is turned down before disengaging the offending switch.
- Is the thermal protection circuit activated? Make sure there is at least six inches of free space behind the SWA2801z.

Poor bass performance

- Check the polarity of the connections between the mixer and the loudspeakers. You may have your positive and negative connections reversed at one end of one cable, causing one loudspeaker to be out-of-phase.
- Try switching the PHASE switch on the rear panel. This affects the polarity between the full-range speakers and the SWA2801z and may improve the low-frequency response.

Poor sound

- Is it loud and distorted? Make sure that you're not overdriving a stage in the signal chain. Verify that all level controls are set properly.
- Is the input connector plugged completely into the jack? Be sure all connections are secure. It's a good idea to periodically clean all electrical connections with a non-lubricating electrical contact cleaner.

Noise

- Make sure all connections to the active loudspeakers are good and sound.
- Make sure none of the signal cables are routed near AC cables, power transformers, or other EMI-inducing devices.
- Is there a light dimmer or other SCR-based device on the same AC circuit as the SWA2801z? Use an AC line filter or plug the SWA2801z into a different AC circuit.

Hum

- Try disconnecting the cable connected to the INPUT jack. If the noise disappears, it could be a "ground loop," rather than a problem with the SWA2801z. Try some of the following troubleshooting ideas:
- Use balanced connections throughout your system for the best noise rejection.
- Whenever possible, plug all the audio equipment's linecords into outlets which share a common ground. The distance between the outlets and the common ground should be as short as possible.

Repair

For warranty repair or replacement, refer to the warranty information on page 11.

Non-warranty repair for Mackie products is available at a factory-authorized service center. To locate your nearest service center, visit www.mackie.com, click “Support” and select “Locate a Service Center.” Service for Mackie products living outside the United States can be obtained through local dealers or distributors.

If you do not have access to our website, you can call our Tech Support department at 1-800-898-3211, Monday-Friday, 7 am to 5 pm Pacific Time, to explain the problem. Tech Support will tell you where the nearest factory-authorized service center is located in your area.

Need Help?

**You can reach a technical support representative
Monday through Friday
from 7 AM to 5 PM PST at:
1-800-898-3211**

**After hours, visit www.mackie.com and click Support,
or email us at: techmail@mackie.com**

SWA2801z SPECIFICATIONS

System Specifications

| | |
|----------------------|-----------------------------------|
| Freq range (-3 dB) | 43 Hz – 120 Hz |
| Freq range (-10 dB) | 33 Hz – 200 Hz |
| Maximum SPL @ 1m | 130 dB |
| Peak Output SPL @ 1m | 136 dB |
| Crossover frequency | 120 Hz |
| Input type | Balanced differential |
| Input protection | Level protected |
| Thermal protection | Input stage muting, auto-reset |

Input/Output

| | |
|-------------------|--|
| Input: | Stereo bal/unbal. female XLR |
| Input Impedance: | 50 kΩ |
| Loop Through: | Stereo bal/unbal. male XLR |
| High-Pass Output: | Stereo bal/unbal. male XLR |
| Level Control: | Rotating knob, center detent, off to +15 dB |
| Phase Control: | (0–180 degrees) Recessed Sliding Switch |

Transducer Specifications

| | |
|---------------------|--------------|
| Diameter | 18" (457 mm) |
| Voice coil diameter | 4" (102 mm) |

Power Amplifier

| | |
|-------------|---|
| Rated Power | 800 watts continuous 1000 watts peak |
| Rated THD | < 0.03% |
| Cooling | Passive |

Line Input Power

| | |
|----------------|---|
| US Model | 120 VAC, 60 Hz Recommended Amperage Service: 15A |
| European Model | 230 VAC, 50 Hz Recommended Amperage Service: 8A |

Physical Properties

| | |
|------------------|--|
| Height | 37.00 in/939.8 mm |
| Width | 24.62 in/625.3 mm |
| Depth | 34.00 in/863.8 mm |
| Weight | 154 lb/70 kg |
| Enclosure | 15 mm thick multi-layer Baltic birch wood |
| Mounting Methods | Floor mount only |

WARNING: The cabinet has no rigging points and is not suitable for rigging. NEVER attempt to suspend the SWA2801z by its handles.

Disclaimer

Since we are always striving to make our products better by incorporating new and improved materials, components, and manufacturing methods, we reserve the right to change these specifications at any time without notice.

“Mackie” and the “Running Man” figure are registered trademarks of LOUD Technologies Inc.

All other brand names mentioned are trademarks or registered trademarks of their respective holders, and are hereby acknowledged.

©2006-2008 LOUD Technologies Inc.
All Rights Reserved.

Dimensions

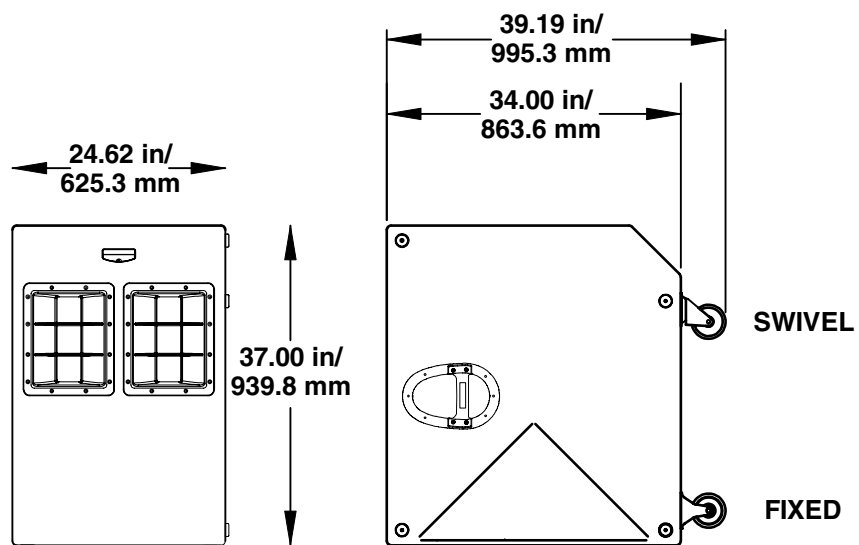

SWA2801z LIMITED WARRANTY

Please keep your sales receipt in a safe place.

A. LOUD Technologies Inc. warrants all materials, workmanship and proper operation of this product for a period of **three years** from the original date of purchase. You may purchase an additional 24-month Extended Warranty (for a total of 60 months of coverage). Visit our website and follow the “Product Registration” links for details (www.mackie.com). If any defects are found in the materials or workmanship or if the product fails to function properly during the applicable warranty period, LOUD Technologies, at its option, will repair or replace the product. **This warranty applies only to equipment sold and delivered within the U.S. and Canada by LOUD Technologies Inc. or its authorized dealers.**

B. For faster processing (not to mention a free gift), register online or mail in the product registration card.

C. Unauthorized service, repairs, or modification of Mackie products will void this warranty. To obtain repairs or replacement under warranty, you must have a copy of your sales receipt from the authorized Mackie dealer where you purchased the product. It is necessary to establish purchase date and determine whether your Mackie product is within the warranty period.

D. To obtain warranty repair or replacement:

1. Call Mackie Technical Support at 800/898-3211, 7 AM to 5 PM Monday through Friday (Pacific Time) to get authorization for repair or replacement. Alternately, go to the Mackie website, click “Support” (www.mackie.com/support), and follow the instructions for reporting a warranty issue and submitting a request for an advance replacement.

2. **Advance Replacement:** Mackie will ship a replacement unit to you along with an invoice for the suggested retail price of the replacement unit. You must return the defective unit immediately to cancel the invoice. If you do not return the defective unit within 30 days, you must pay the full amount stated in the invoice to satisfy your debt.

3. **Repair:** When you call Mackie Technical Support, explain the problem and obtain a Service Request Number. Have your Mackie product's serial number ready. **You must have a Service Request Number before you can obtain factory-authorized service.**

- Pack the product in its original shipping carton. Also include a note explaining exactly how to duplicate the problem, a copy of the sales receipt with price and date showing, your daytime phone number and return street address (no P.O. boxes or route numbers, please!), and the Service Request Number. If we cannot duplicate the problem or establish the starting date of your Limited Warranty, we may, at our option, charge for service time and parts.

- Ship the product in its original shipping carton, **freight prepaid** to the authorized service center. Write the Service Request Number in **BIG PRINT** on top of the box. The address of your closest authorized service center will be given to you by Technical Support, or it may be obtained from our website. Once it's repaired, the authorized service center will ship it back by ground shipping, pre-paid (if it qualified as a warranty repair).

Note: Under the terms of the warranty, you must ship or drop-off the unit to an authorized service center. The return ground shipment is covered for those units deemed by us to be under warranty.

Note: You must have a sales receipt from an authorized Mackie dealer for your unit to be considered for warranty repair.

IMPORTANT: Make sure that the Service Request Number is plainly written on the shipping carton. No receipt, no warranty service.

E. LOUD Technologies reserves the right to inspect any products that may be the subject of any warranty claims before repair or replacement is carried out. LOUD Technologies may, at our option, require proof of the original date of purchase in the form of a dated copy of the original dealer's invoice or sales receipt. Final determination of warranty coverage lies solely with LOUD Technologies.

F. Any products returned to one of the LOUD Technologies factory-authorized service centers, and deemed eligible for repair or replacement under the terms of this warranty will be repaired or replaced. LOUD Technologies and its authorized service centers may use refurbished parts for repair or replacement of any product. Products returned to LOUD Technologies that do not meet the terms of this Warranty will not be repaired unless payment is received for labor, materials, return freight, and insurance. Products repaired under warranty will be returned freight prepaid by LOUD Technologies to any location within the boundaries of the USA or Canada.

G. LOUD Technologies warrants all repairs performed for 90 days or for the remainder of the warranty period. This warranty does not extend to damage resulting from improper installation, misuse, neglect or abuse, or to exterior appearance. This warranty is recognized only if the inspection seals and serial number on the unit have not been defaced or removed.

H. LOUD Technologies assumes no responsibility for the timeliness of repairs performed by an authorized service center.

I. This warranty is extended to the original purchaser. This warranty may be transferred to anyone who may subsequently purchase this product within the applicable warranty period for a nominal fee. A copy of the original sales receipt is required to obtain warranty repairs or replacement.

J. This is your sole warranty. LOUD Technologies does not authorize any third party, including any dealer or sales representative, to assume any liability on behalf of LOUD Technologies or to make any warranty for LOUD Technologies Inc.

K. THE WARRANTY GIVEN ON THIS PAGE IS THE SOLE WARRANTY GIVEN BY LOUD TECHNOLOGIES INC. AND IS IN LIEU OF ALL OTHER WARRANTIES, EXPRESS AND IMPLIED, INCLUDING THE WARRANTIES OF MERCHANTABILITY AND FITNESS FOR A PARTICULAR PURPOSE. THE WARRANTY GIVEN ON THIS PAGE SHALL BE STRICTLY LIMITED IN DURATION TO THREE YEARS FROM THE DATE OF ORIGINAL PURCHASE FROM AN AUTHORIZED MACKIE DEALER. UPON EXPIRATION OF THE APPLICABLE WARRANTY PERIOD, LOUD TECHNOLOGIES INC. SHALL HAVE NO FURTHER WARRANTY OBLIGATION OF ANY KIND. LOUD TECHNOLOGIES INC. SHALL NOT BE LIABLE FOR ANY INCIDENTAL, SPECIAL, OR CONSEQUENTIAL DAMAGES THAT MAY RESULT FROM ANY DEFECT IN THE MACKIE PRODUCT OR ANY WARRANTY CLAIM. Some states do not allow exclusion or limitation of incidental, special, or consequential damages or a limitation on how long warranties last, so some of the above limitations and exclusions may not apply to you. This warranty provides specific legal rights and you may have other rights which vary from state to state.

MACKIE®

16220 Wood-Red Road NE • Woodinville, WA 98072 • USA
United States and Canada: 800.898.3211
Europe, Asia, Central and South America: 425.487.4333
Middle East and Africa: 31.20.654.4000
Fax: 425.487.4337 • www.mackie.com
E-mail: sales@mackie.com