

[®]**MACKE**

**SR1522z
2-WAY ACTIVE
LOUDSPEAKER SYSTEM
USER'S MANUAL**

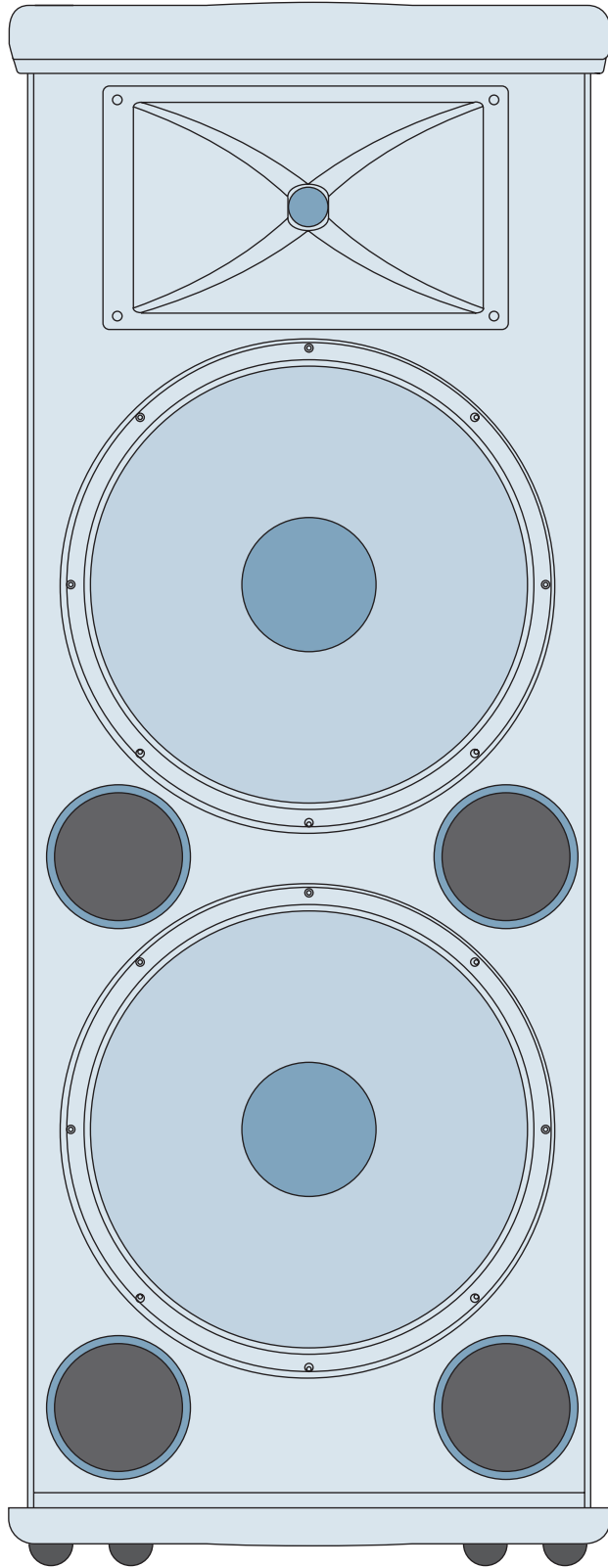

IMPORTANT SAFETY INSTRUCTIONS

1. Read these instructions.
2. Keep these instructions.
3. Heed all warnings.
4. Follow all instructions.
5. Do not use this apparatus near water.
6. Clean only with dry cloth.
7. Do not block any ventilation openings. Install in accordance with the manufacturer's instructions.
8. Do not install near any heat sources such as radiators, heat registers, stoves, or other apparatus (including amplifiers) that produce heat.
9. Do not defeat the safety purpose of the polarized or grounding-type plug. A polarized plug has two blades with one wider than the other. A grounding-type plug has two blades and a third grounding prong. The wide blade or the third prong are provided for your safety. If the provided plug does not fit into your outlet, consult an electrician for replacement of the obsolete outlet.
10. Protect the power cord from being walked on or pinched particularly at plugs, convenience receptacles, and the point where they exit from the apparatus.
11. Only use attachments/accessories specified by the manufacturer.
12. Use only with a cart, stand, tripod, bracket, or table specified by the manufacturer, or sold with the apparatus. When a cart is used, use caution when moving the cart/apparatus combination to avoid injury from tip-over.
13. Unplug this apparatus during lightning storms or when unused for long periods of time.
14. Refer all servicing to qualified service personnel. Servicing is required when the apparatus has been damaged in any way, such as power-supply cord or plug is damaged, liquid has been spilled or objects have fallen into the apparatus, the apparatus has been exposed to rain or moisture, does not operate normally, or has been dropped.
15. This apparatus shall not be exposed to dripping or splashing, and no object filled with liquids, such as vases, shall be placed on the apparatus.
16. This apparatus has been designed with Class-I construction and must be connected to a mains socket outlet with a protective earthing connection (the third grounding prong).
17. This apparatus has been equipped with an all-pole, rocker-style AC mains power switch. This switch is located on the rear panel and should remain readily accessible to the user.
18. This apparatus does not exceed the Class A/Class B (whichever is applicable) limits for radio noise emissions from digital apparatus as set out in the radio interference regulations of the Canadian Department of Communications.

ATTENTION — *Le présent appareil numérique n'émet pas de bruits radioélectriques dépassant les limites applicables aux appareils numériques de class A/de class B (selon le cas) prescrites dans le règlement sur le brouillage radioélectrique édicté par les ministere des communications du Canada.*

19. Exposure to extremely high noise levels may cause permanent hearing loss. Individuals vary considerably in susceptibility to noise-induced hearing loss, but nearly everyone will lose some hearing if exposed to sufficiently intense noise for a period of time. The U.S. Government's Occupational Safety and Health Administration (OSHA) has specified the permissible noise level exposures shown in the following chart.

According to OSHA, any exposure in excess of these permissible limits could result in some hearing loss. To ensure against potentially dangerous exposure to high sound pressure levels, it is recommended that all persons exposed to equipment capable of producing high sound pressure levels use hearing protectors while the equipment is in operation. Ear plugs or protectors in the ear canals or over the ears must be worn when operating the equipment in order to prevent permanent hearing loss if exposure is in excess of the limits set forth here.

Duration Per Day In Hours	Sound Level dBA, Slow Response	Typical Example
8	90	Duo in small club
6	92	
4	95	Subway Train
3	97	
2	100	Very loud classical music
1.5	102	
1	105	Tami screaming at Adrian about deadlines
0.5	110	
0.25 or less	115	Loudest parts at a rock concert

PORTABLE CART WARNING



Carts and stands - The Component should be used only with a cart or stand that is recommended by the manufacturer. A Component and cart combination should be moved with care. Quick stops, excessive force, and uneven surfaces may cause the Component and cart combination to overturn.

CAUTION AVIS

RISK OF ELECTRIC SHOCK
DO NOT OPEN
RISQUE DE CHOC ELECTRIQUE
NE PAS OUVRIR

CAUTION: TO REDUCE THE RISK OF ELECTRIC SHOCK
DO NOT REMOVE COVER (OR BACK)
NO USER-SERVICEABLE PARTS INSIDE
REFER SERVICING TO QUALIFIED PERSONNEL

ATTENTION: POUR EVITER LES RISQUES DE CHOC
ELECTRIQUE, NE PAS ENLEVER LE COUVERCLE. AUCUN
ENTRETIEN DE PIECES INTERIEURES PAR L'USAGER. CONFIER
L'ENTRETIEN AU PERSONNEL QUALIFIE.

AVIS: POUR EVITER LES RISQUES D'INCENDIE OU
D'ELECTROCUTION, N'EXPOSEZ PAS CET ARTICLE
A LA PLUIE OU A L'HUMIDITE

The lightning flash with arrowhead symbol within an equilateral triangle is intended to alert the user to the presence of uninsulated "dangerous voltage" within the product's enclosure, that may be of sufficient magnitude to constitute a risk of electric shock to persons.

Le symbole clair avec point de fl che l'int rieur d'un triangle qu'il est utilis pour alerter l'utilisateur de la pr sence l'int rieur du coffret de "voltage dangereux" non isol d'ampleur suffisante pour constituer un risque d' l ctrocution.

The exclamation point within an equilateral triangle is intended to alert the user of the presence of important operating and maintenance (servicing) instructions in the literature accompanying the appliance.

Le point d'exclamation l'int rieur d'un triangle qu'il est utilis pour alerter les utilisateurs de la pr sence d'instructions importantes pour le fonctionnement et l'entretien (service) dans le livret d'instruction accompagnant l'appareil.

WARNING — To reduce the risk of fire or electric shock, do not expose this apparatus to rain or moisture.

INTRODUCTION

Thank you for choosing Mackie's active sound reinforcement loudspeaker systems.

The SR1522z is a high-efficiency, high output, horn-loaded, 2-way, wide-dispersion, active sound reinforcement system. The SR1522z benefits from the integration of 400 watts of amplifier power, complete active control electronics, and precision transducer components. These elements together form a speaker system with unprecedented output, resolution, and clarity.

The 1.75-inch neodymium high-frequency compression driver features a low-distortion optimized symmetric phase plug.

The low frequencies are produced by two high-output 15-inch woofers featuring high-temperature voice coils.

Connecting and setting up the SR1522z is a breeze. It accepts a line-level signal via a female XLR input jack. A male XLR Thru jack is provided for daisy-chaining the signal to additional SR1522z cabinets.

Two built-in power amplifiers provide 100 watts rms for the high-frequency driver and 400 watts rms for the low-frequency driver. The amplifier modules sit on a mammoth aluminum heatsink that eliminates the need

for fans. A tremendous benefit of having the amplifiers located within the loudspeaker cabinet is that the SR1522z functions as a system, optimizing acoustic, electronic, and mechanical designs to achieve the highest level of performance and value.

The rear mounted amplifier assembly features separate signal and AC power panels separated by the heatsink. The signal input panel contains:

- an input XLR and loop-through XLR
- a volume level control
- Power ON indicator
- Signal Present indicator
- Limit indicator
- Thermal Protection indicator

The cabinet is constructed using both 18 mm multi-layered plywood and pressure injected structural resin. A carrying handle is integrated into each side for easy loading and transport.

CONTENTS

IMPORTANT SAFETY INSTRUCTIONS	2
INTRODUCTION	3
REAR PANEL DESCRIPTION	4
HOOKUP DIAGRAM	5
CONNECTIONS	5
PLACEMENT	5
Room Acoustics	6
THERMAL CONSIDERATIONS	6
AC POWER	6
SERVICE INFORMATION	7
Warranty Service	7
Troubleshooting	7
Repair	8
CARE AND MAINTENANCE	8
SR1522z SPECIFICATIONS	9
SR1522z LIMITED WARRANTY	11

Don't forget to visit our website at www.mackie.com
for more information about this and other Mackie products.

REAR PANEL DESCRIPTION

1. MAIN INPUT

This is a female XLR-type connector that accepts a balanced line-level signal from a mixing console or other signal source.

2. LOOP OUT

This is a male XLR-type connector that produces exactly the same signal that is connected to the MAIN INPUT jack. Use it to daisy-chain several SR1522z's together off the same signal source.

3. Level Control

This controls the overall signal level at the input to the built-in power amplifiers. It ranges from -15 dB to $+5$ dB of gain. The center detent is 0 dB (unity gain).

4. Power ON Indicator

When the POWER switch is turned on, and the linecord is connected to an active AC power supply, this indicator lights green to let you know that you're ready to rock and roll. The cool blue LED on the front of the cabinet works in the same way.

5. SIGNAL Present Indicator

This LED illuminates whenever there is a signal present at the MAIN INPUT connector on the rear panel. It senses the signal just after the level control, so if the level control is turned down, the SIGNAL Present indicator turns off.

6. LIMIT Indicator

The SR1522z has a built-in limiter that prevents the amplifier outputs from clipping or overdriving the transducers. The LIMIT indicator lights when the limiter is activated. It's okay for the LIMIT indicator to blink occasionally, but if it blinks frequently or lights continuously, turn down the level control until the LIMIT indicator only blinks occasionally.

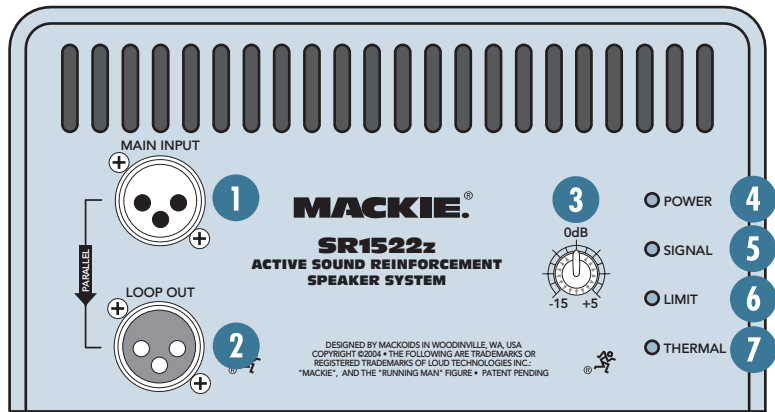

7. THERMAL Indicator

There is also a thermal protection circuit that monitors the internal temperature of the amplifiers and heatsink. If the temperature should exceed a safe operating level, this indicator lights and the signal is muted to allow the amplifiers to cool. When the temperature cools to a safe level once again, the thermal protection circuit deactivates and normal operation continues.

Note: Activation of the thermal protection circuit is an indication that you should take steps to avoid continued thermal problems. See “Thermal Considerations” on page 6.

8. POWER Switch

Use this switch to turn the SR1522z on and off. Make sure the level control is turned down before you turn it on.

9. AC Receptacle

This is where you connect the AC linecord to provide AC power to the SR1522z's built-in power amplifiers. Plug the linecord into an AC socket properly configured for your particular model.

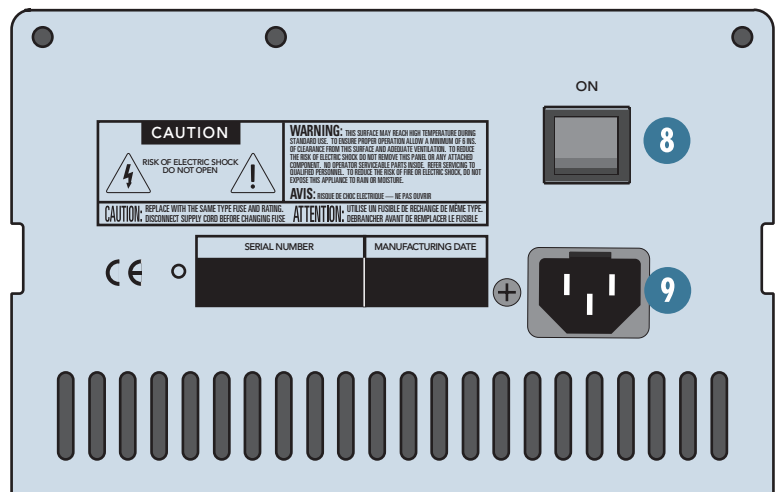

HOOKUP DIAGRAM

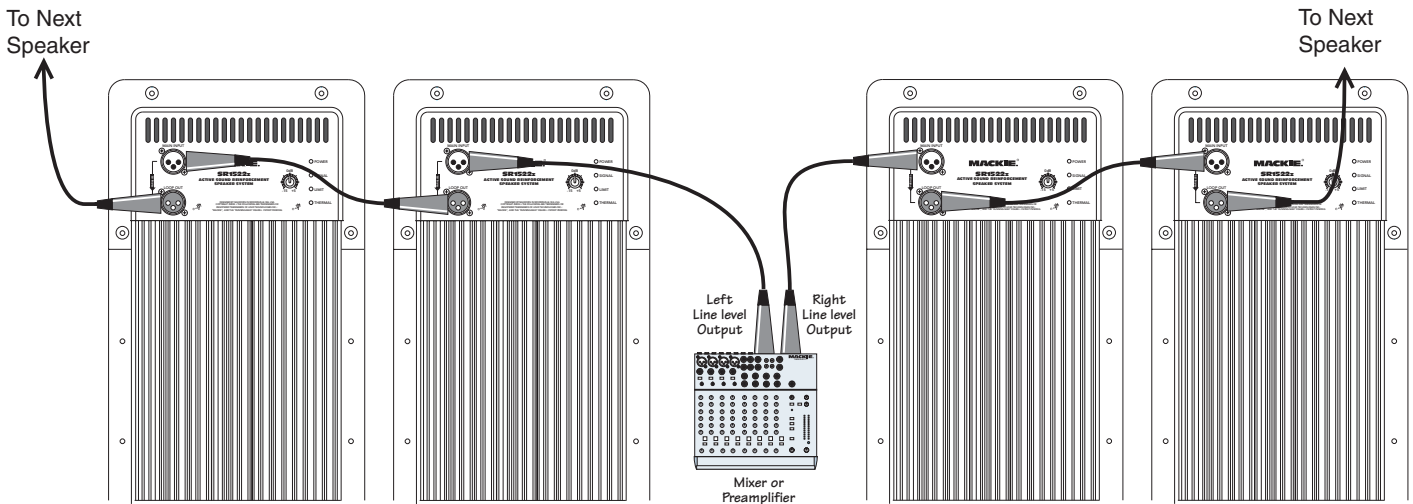

DAISY-CHAINING MULTIPLE SR1522z's

CONNECTIONS

The SR1522z has one female XLR input that accepts a balanced line-level signal. When connecting a balanced signal, be sure it's wired per AES (Audio Engineering Society) standards:

	<u>XLR</u>
Hot (+)	Pin 2
Cold (-)	Pin 3
Shield (Ground)	Pin 1

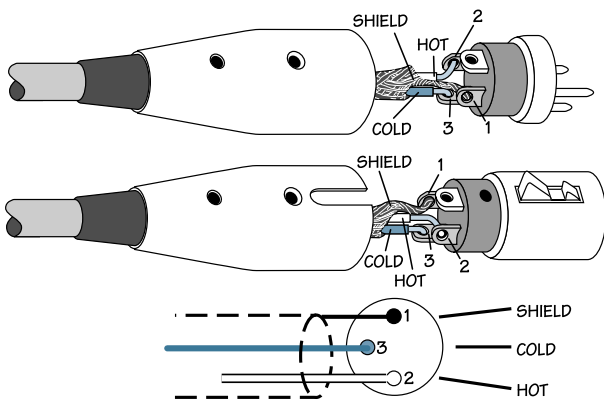

Balanced XLR Connectors

There is also a male XLR connector labeled LOOP OUT. This is also wired according to the above AES standard.

The LOOP OUT connector allows you to connect more than one SR1522z to your system. Simply plug the signal source (i.e., mixer output) into the first MAIN INPUT jack, and patch that speaker's LOOP OUT jack to the next MAIN INPUT jack, and so on, daisy-chaining multiple speakers.

The LOOP OUT jack is wired straight from the MAIN INPUT connector — there is no electronic circuitry between — so the signal coming out of the LOOP OUT jack is exactly the same as the signal going in.

PLACEMENT

The SR1522z speaker is designed to sit on the floor or stage.



WARNING: The cabinet has no rigging points and is not suitable for rigging. **NEVER** attempt to suspend the SR1522z by its handles. *The SR1522z should never be pole-mounted.*

You can create a horizontal array by placing the cabinets side-by-side. However, you should have a good understanding of the relationship between the splay angle (the angle between the facing sides of the cabinets), the on-axis power, and frequency cancellation effects between cabinets.

When two cabinets are placed side-by-side, the actual splay angle is 20° (determined by a 10° angle on each cabinet side). As the splay angle increases toward the angle of horizontal coverage (90° for the SR1522z), the on-axis power decreases, but the frequency response becomes smoother as the comb-filtering effects (caused by the interaction in the area of double-coverage) decrease.



As with any powered components, protect them from moisture. If you are setting them up outdoors, make sure they are under cover if you expect rain.

Room Acoustics

The SR1522z loudspeakers are designed to sound as neutral as possible; that is, to reproduce the input signal as accurately as possible.

Room acoustics play a crucial role in the overall performance of a sound system. Here are some additional placement tips to help overcome some typical room problems that might arise:

- Avoid placing loudspeakers in the corners of a room. This increases the low frequency output and can cause the sound to be muddy and indistinct.
- Avoid placing loudspeakers against a wall. This, too, increases the low frequency output, though not as much as corner placement. However, if you do need to reinforce the low frequencies, this is a good way to do it.
- Avoid placing the speakers directly on a hollow stage floor. A hollow stage can resonate at certain frequencies, causing peaks and dips in the frequency response of the room. It's better to place the loudspeakers on a sturdy table or stand designed to handle the weight of the SR1522z.
- Position the loudspeakers so the high-frequency drivers are 2 to 4 feet above ear level for the audience (make allowances for a standing/dancing in the aisles audience). High frequencies are highly directional and tend to be absorbed much easier than lower frequencies. By providing direct line-of-sight from the loudspeakers to the audience, you increase the overall brightness and intelligibility of the sound system.
- Highly reverberant rooms, like many gymnasiums and auditoriums, are a nightmare for sound system intelligibility. Multiple reflections off the hard walls, ceiling, and floor play havoc with the sound. Depending on the situation, you may be able to take some steps to minimize the reflections, such as putting carpeting on the floors, closing draperies to cover large glass windows, or hanging tapestries or other materials on the walls to absorb some of the sound.

However, in most cases, these remedies are not possible or practical. So what do you do? Making the sound system louder generally doesn't work because the reflections become louder, too. The best approach is to provide as much direct sound coverage to the audience as possible. The farther away you are from the speaker, the more prominent will be the reflected sound.

Use more speakers strategically placed so they are closer to the back of the audience. If the distance between the front and back speakers is more than about 100 feet, you should use a delay processor to time-align the sound. (Since sound travels about 1 foot per millisecond, it takes about 1/10 of a second to travel 100 feet.)

THERMAL CONSIDERATIONS

The SR1522z has two powerful built-in amplifiers capable of producing a combined 500 watts of power. As amplifiers produce heat, it is important to dissipate the heat as quickly as possible. This results in increased reliability and longevity for the amplifier.

The amplifier module is mounted on a large heatsink, which is cooled by convection where cool air is drawn through it's fins, carrying the heat away. In order for this convection cooling to work efficiently, it is important to provide adequate airspace behind the loudspeaker. When you position the SR1522z, we recommend leaving at least six inches of air space behind it.

In the unlikely event of the amplifier overheating, a built-in thermal switch will activate, which mutes the signal and lights the THERMAL LED. When the amplifier has cooled down to a safe operating temperature, the thermal switch resets itself, and the SR1522z resumes normal operation.

If the thermal switch activates frequently, try turning down the level control a notch or two on the mixing console (or the back of the SR1522z) to avoid overheating the amplifier.

If the temperature in the room is too high, it could cause the amplifier to overheat. In this case, you should try aiming a fan at the rear panel to move more air through the heatsink fins.

AC POWER

Be sure the SR1522z is plugged into an outlet that is able to supply the correct voltage specified for your model. If the voltage should drop below 97% of the specified line voltage, the built-in amplifiers will no longer be able to supply rated power. (They will continue to operate down to 80% of the rated line voltage, but won't reach full power, resulting in lower headroom.)

Be sure the electrical service can supply enough amperage for all the components connected to it.

We recommend that a stiff (robust) supply of AC power be used because the amplifiers place high current demands on the AC line. The more power that is available on the line, the louder the speakers will play and the more peak output power will be available for cleaner, punchier bass. A suspected problem of "poor bass performance" is often caused by a weak AC supply to the amplifiers.



Never remove the ground pin on the power cord of the SR1522z or any other component. This is very dangerous.

SERVICE INFORMATION

Warranty Service

Details concerning warranty service are spelled out on page 11 of this manual.

If you think your loudspeaker has a problem, please do everything you can to confirm it before calling for service, including reading through the following Troubleshooting section. Doing so might save you from being deprived of your Mackie loudspeaker.

Of all Mackie products returned for service (which is hardly any at all), many are coded “CND” — Could Not Duplicate— which usually means the problem lay somewhere else in the system. The following troubleshooting tips may sound obvious, but here are some things you can check:

Troubleshooting

No power

- Our favorite question: Is it plugged in? Make sure the AC outlet is live (check with a tester or lamp).
- Our next favorite question: Is the POWER switch on? If not, try turning it on.
- Is the POWER LED on the rear panel glowing green? If not, make sure the AC outlet is live. If so, refer to “No sound” below.
- The internal AC line fuse may be blown. This is not a user serviceable part. If you suspect the AC line fuse is blown, please see the "Repair" section next.

No sound

- Is the input level control for the input source turned all the way down? Verify that all the volume controls in the system are properly adjusted.
- Is the signal source working (and making union scale)? Make sure the connecting cables are in good repair and securely connected at both ends. Make sure the output volume (gain) control on the mixing console is turned up sufficiently to drive the inputs of the speaker.
- Make sure the mixer does not have a Mute on or a Processor loop engaged. If you find something like this, make sure the volume/gain is turned down before disengaging the offending switch.
- Is the THERMAL indicator lit red on the rear panel? Make sure there is at least six inches of free space behind the SR1522z.

Poor bass performance

- Check the polarity of the connections between the mixer and the loudspeakers. You may have your positive and negative connections reversed at one end of one cable, causing one loudspeaker to be out-of-phase.

Poor sound

- Is it loud and distorted? Make sure that you're not overdriving a stage in the signal chain. Verify that all level controls are set properly.
- Is the input connector plugged completely into the jack? Be sure all connections are secure. It's a good idea to periodically clean all electrical connections with a non-lubricating electrical contact cleaner.

Noise

- Make sure all connections to the active loudspeakers are good and sound.
- Make sure none of the signal cables are routed near AC cables, power transformers, or other EMI-inducing devices.
- Is there a light dimmer or other SCR-based device on the same AC circuit as the SR1522z? Use an AC line filter or plug the SR1522z into a different AC circuit.

Hum

- Try disconnecting the cable connected to the MAIN INPUT jack. If the noise disappears, it could be a “ground loop,” rather than a problem with the SR1522z. Try some of the following troubleshooting ideas:
 - ◇ Use balanced connections throughout your system for the best noise rejection.
 - ◇ Whenever possible, plug all the audio equipment's linecords into outlets which share a common ground. The distance between the outlets and the common ground should be as short as possible.

Repair

Service for Mackie products is available at a factory-authorized service center. Service for Mackie products outside the United States can be obtained through local dealers or distributors.

If your SR1522z needs service, please follow these instructions:

1. Review the preceding troubleshooting suggestions. Please.
2. Call Tech Support at 1-800-898-3211, 7 am to 5 pm PST, to explain the problem in detail. They will ask you all sorts of impertinent questions in the hope of sorting out the problem. If it appears that the SR1522z needs repair, you will be given a Service Request Number. Have your loudspeaker's serial number ready. *You must have a Service Request Number before you can obtain service at a factory-authorized service center.*
3. Keep this user's manual and the detachable line-cord. We don't need them to repair the loudspeaker.
4. *Pack the loudspeaker in its original packaging, including protective wrap, endcaps, and box. This is VERY IMPORTANT.* When you call for the Service Request Number, please let Tech Support know if you need new packaging. *Mackie is not responsible for any damage that occurs due to non-factory packaging.*
5. Include a legible note stating your name, shipping address (no P.O. boxes), daytime phone number, Service Request Number, and a detailed description of the problem, including how we can duplicate it.
6. Write the Service Request Number in **BIG PRINT** on top of the box. Product shipped without the Service Request Number will be refused.
7. Tech Support will tell you where to ship the loudspeaker for repair. We suggest insurance for all forms of cartage.

8. We'll try to fix the loudspeaker within five business days. Once it is repaired, we'll ship it back the same way in which it was received. This paragraph does not necessarily apply to non-warranty service.

Note: You must have a sales receipt from an Authorized Mackie Dealer to qualify for a warranty repair.

CARE AND MAINTENANCE

Your Mackie loudspeakers will provide many years of reliable service if you follow these guidelines:



Avoid exposing the loudspeakers to moisture. If they are set up outdoors, be sure they are under cover if you expect rain.

- Avoid exposure to extreme cold (below freezing temperatures). If you must operate the loudspeakers in a cold environment, warm up the voice coils slowly by sending a low-level signal through them for about 15 minutes prior to high-power operation.
- Use a slightly damp cloth with a mild soap solution to clean the cabinets. Only do this when the power is turned off. Avoid getting moisture into any of the openings of the cabinet, particularly where the drivers are located.

Need Help?

**You can reach a technical support representative
Monday through Friday
from 7 AM to 5 PM PST at:**

1-800-898-3211

**After hours, visit www.mackie.com and click Support,
or email us at: techmail@mackie.com**

SR1522z SPECIFICATIONS

Acoustic Performance

<i>Frequency Range (-10 dB)</i>	43 Hz–20 kHz
<i>Frequency Response (-3 dB)</i>	56 Hz–18 kHz
<i>Horizontal Coverage Angle (-6 dB)</i>	90° averaged 2 kHz to 10 kHz
<i>Vertical Coverage Angle (-6 dB)</i>	40° averaged 2 kHz to 10 kHz
<i>Directivity Factor; DI (Q)</i>	12.1 (16.4) averaged 2k Hz to 10 kHz
<i>Max SPL long-term</i>	130 dB @ 1m
<i>Max SPL peak</i>	133 dB @ 1m
<i>Crossover Point</i>	1300 Hz

Input/Output

<i>Input Type</i>	Female XLR Balanced/Unbalanced
<i>Input Impedance</i>	50 kohms balanced
<i>Loop-Through</i>	Male XLR Balanced/Unbalanced (parallel with input)
<i>Level Control</i>	Rotating knob (-15 to +5 dB), center detent at 0 dB

High-Frequency Section

<i>Voice Coil Diameter</i>	1.75 in/44 mm
<i>Horn Exit Diameter</i>	1.0 in/25 mm
<i>Phase Plug</i>	Optimized geometry
<i>Diaphragm Material</i>	Titanium
<i>Magnet Material</i>	Ferrite

Low-Frequency Section

<i>Number of Drivers</i>	2
<i>Woofers Diameter</i>	15.0 in/381 mm
<i>Voice Coil Diameter</i>	2.5 in/63 mm
<i>Diaphragm Material</i>	Epoxy-reinforced cellulose
<i>Magnet Material</i>	Ferrite

Power Amplifiers

Low-Frequency Power Amplifier

<i>Rated Power</i>	400 watts rms
<i>Rated THD</i>	< 0.03%
<i>Design</i>	Class G, Hybrid

High-Frequency Power Amplifier

<i>Rated Power</i>	100 watts rms
<i>Rated THD</i>	< 0.03%
<i>Design</i>	Class AB

Line Input Power

<i>US</i>	120V, 60Hz	
	Recommended Amperage Service:	13 amps
<i>Europe</i>	230V, 50Hz	
	Recommended Amperage Service:	7 amps
<i>AC Connector</i>	3-pin IEC 250 VAC	

Safety Features

<i>Input Protection</i>	Low frequency dynamic bass protection, rms limiting, power supply and amplifier thermal protection
<i>Display LEDs</i>	Power ON, Signal Present, Limit, Thermal (cool down auto-reset)

Construction Features

<i>Basic Design</i>	Trapezoidal, 10° side angles
<i>Material</i>	18 mm multi-layered plywood, resin end caps
<i>Finish</i>	Wear-resistant textured black PVC vinyl
<i>Handles</i>	One on each side, one top, one bottom
<i>Grille</i>	Perforated metal with weather-resistant coating

Physical Properties

<i>Height</i>	50.0 in/127.0 cm
<i>Front Width</i>	19.1 in/48.5 cm
<i>Rear Width</i>	13.9 in/35.3 cm
<i>Depth</i>	18.1 in/46.0 cm
<i>Weight</i>	132 lb/60 kg

Mounting Methods

Floor mount only.

The SR1522z should never be pole-mounted. The cabinet has no rigging points and is not suitable for flying. Never attempt to suspend the cabinet by its handles.

Disclaimer

Since we are always striving to make our products better by incorporating new and improved materials, components, and manufacturing methods, we reserve the right to change these specifications at any time without notice.

“Mackie” and the “Running Man” figure are registered trademarks of LOUD Technologies Inc.

All other brand names mentioned are trademarks or registered trademarks of their respective holders, and are hereby acknowledged.



SR1522z Frequency Response On-Axis

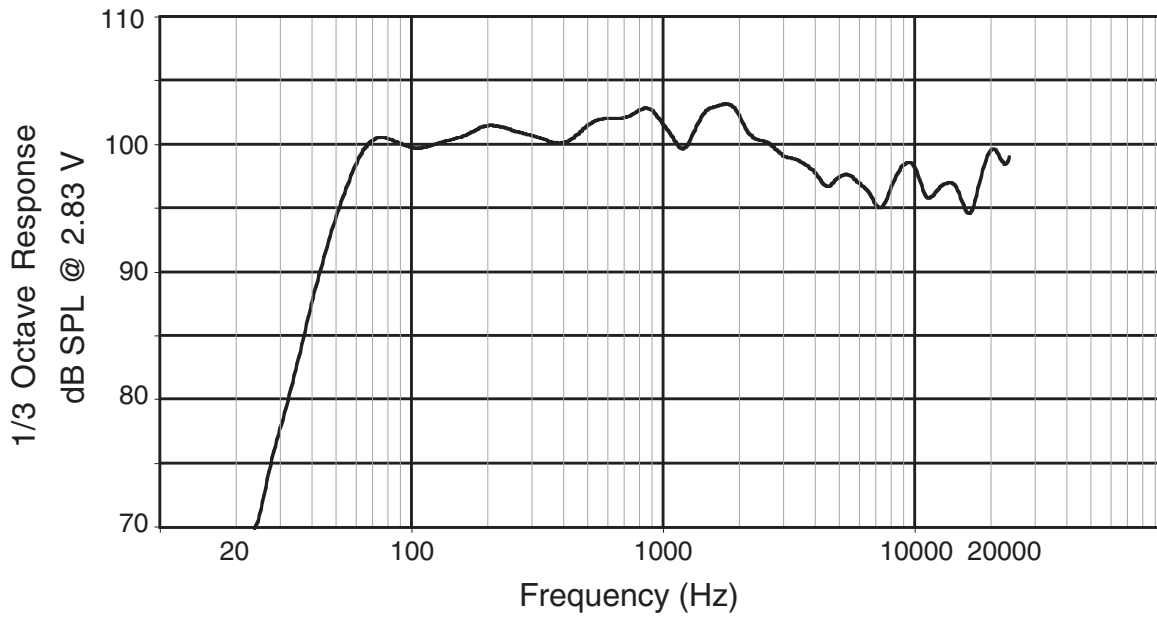

SR1522z Beamwidth vs. Frequency

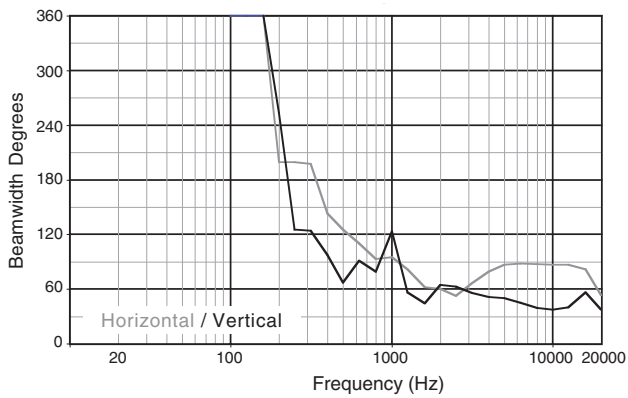

SR1522z Directivity vs. Frequency

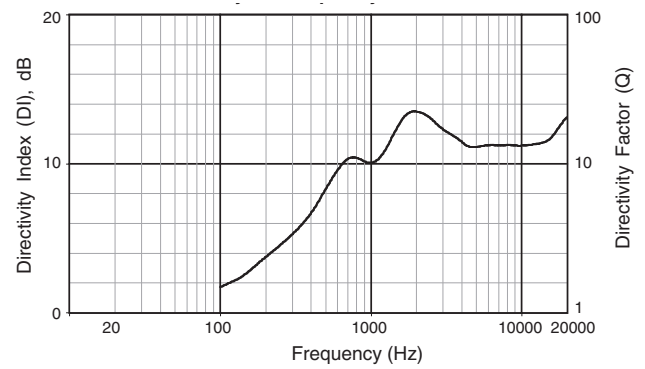

SR1522z Dimensions

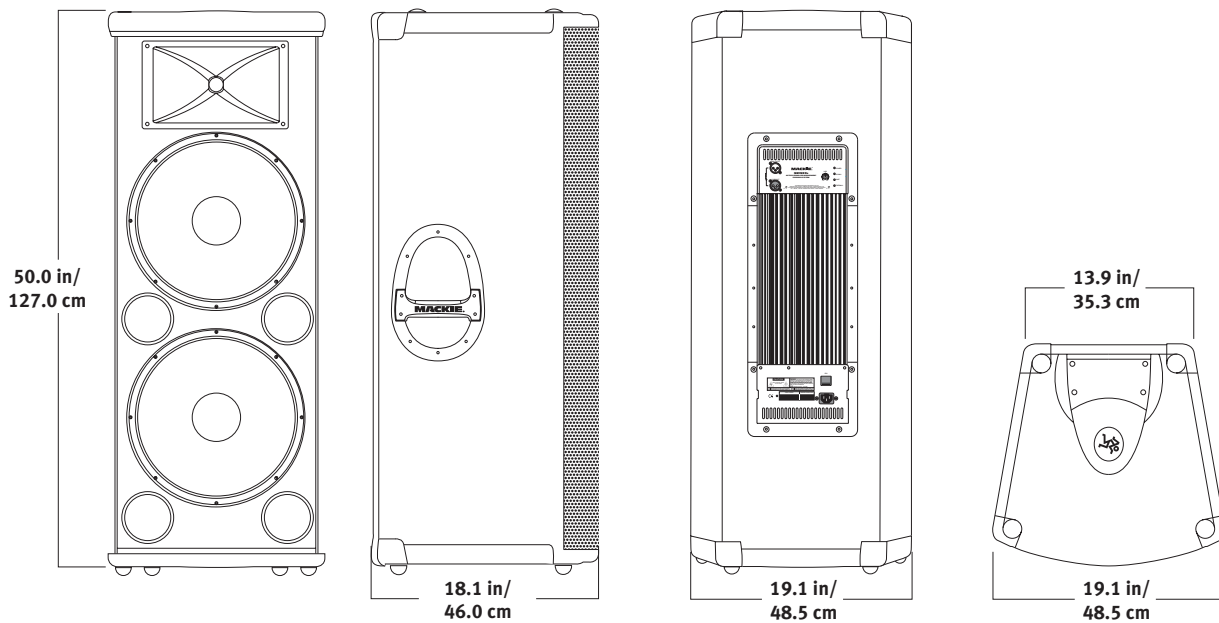

SR1522z LIMITED WARRANTY

Please keep your sales receipt in a safe place.

A. LOUD Technologies Inc. warrants all materials, workmanship and proper operation of this product for a period of **five years** from the original date of purchase with the following exception: warranty on all its loudspeaker components including woofers and compression drivers are only warranted for two years. If any defects are found in the materials or workmanship or if the product fails to function properly during the applicable warranty period, LOUD Technologies, at its option, will repair or replace the product. **This warranty applies only to equipment sold and delivered within the U.S. by LOUD Technologies Inc. or its authorized dealers.**

B. Failure to register online or return the product registration card will not void the five-year warranty.

C. Service and repairs of Mackie products are to be performed **only** at a factory-authorized facility (see D below). Unauthorized service, repairs, or modification will void this warranty. To obtain repairs under warranty, you must have a copy of your sales receipt from the authorized Mackie dealer where you purchased the product. It is necessary to establish purchase date and determine whether your Mackie product is within the warranty period.

D. To obtain factory-authorized service:

1. Call Mackie Technical Support at 800/898-3211, 7 AM to 5 PM Monday through Friday (Pacific Time) to get a Service Request Number. Products returned without a Service Request Number will be refused.
2. Pack the product in its original shipping carton. Also include a note explaining exactly how to duplicate the problem, a copy of the sales receipt with price and date showing, and your return street address (no P.O. boxes or route numbers, please!). If we cannot duplicate the problem or establish the starting date of your Limited Warranty, we may, at our option, charge for service time.
3. Ship the product in its original shipping carton, **freight prepaid** to the authorized service center. The address of your closest authorized service center will be given to you by Technical Support.

IMPORTANT: Make sure that the Service Request Number is plainly written on the shipping carton.

E. LOUD Technologies reserves the right to inspect any products that may be the subject of any warranty claims before repair or replacement is carried out. LOUD Technologies may, at our option, require proof of the original date of purchase in the form of a dated copy of the original dealer's invoice or sales receipt. Final determination of warranty coverage lies solely with LOUD Technologies.

F. Any products returned to one of the LOUD Technologies factory-authorized service centers and deemed eligible for repair or replacement under the terms of this warranty will be repaired or replaced within thirty days of receipt. LOUD Technologies and its authorized service centers may use refurbished parts for repair or replacement of any product. Products returned to LOUD Technologies that do not meet the terms of this Warranty will be not be repaired unless payment is received for labor, materials, return freight, and insurance. Products repaired under warranty will be returned freight prepaid by LOUD Technologies to any location within the boundaries of the USA.

G. LOUD Technologies warrants all repairs performed for 90 days or for the remainder of the warranty period. This warranty does not extend to damage resulting from improper installation, misuse, neglect or abuse, or to exterior appearance. This warranty is recognized only if the inspection seals and serial number on the unit have not been defaced or removed.

H. LOUD Technologies assumes no responsibility for the quality or timeliness of repairs performed by an authorized service center.

I. This warranty is extended to the original purchaser and to anyone who may subsequently purchase this product within the applicable warranty period. A copy of the original sales receipt is required to obtain warranty repairs.

J. This is your sole warranty. LOUD Technologies does not authorize any third party, including any dealer or sales representative, to assume any liability on behalf of LOUD Technologies or to make any warranty for LOUD Technologies Inc.

K. THE WARRANTY GIVEN ON THIS PAGE IS THE SOLE WARRANTY GIVEN BY LOUD TECHNOLOGIES INC. AND IS IN LIEU OF ALL OTHER WARRANTIES, EXPRESS AND IMPLIED, INCLUDING THE WARRANTIES OF MERCHANTABILITY AND FITNESS FOR A PARTICULAR PURPOSE. THE WARRANTY GIVEN ON THIS PAGE SHALL BE STRICTLY LIMITED IN DURATION TO FIVE YEARS FROM THE DATE OF ORIGINAL PURCHASE FROM AN AUTHORIZED MACKIE DEALER. UPON EXPIRATION OF THE APPLICABLE WARRANTY PERIOD, LOUD TECHNOLOGIES INC. SHALL HAVE NO FURTHER WARRANTY OBLIGATION OF ANY KIND. LOUD TECHNOLOGIES INC. SHALL NOT BE LIABLE FOR ANY INCIDENTAL, SPECIAL, OR CONSEQUENTIAL DAMAGES THAT MAY RESULT FROM ANY DEFECT IN THE MACKIE PRODUCT OR ANY WARRANTY CLAIM. Some states do not allow exclusion or limitation of incidental, special, or consequential damages or a limitation on how long warranties last, so some of the above limitations and exclusions may not apply to you. This warranty provides specific legal rights and you may have other rights which vary from state to state.

MACKIE®



MACKIE.®

16220 Wood-Red Road NE • Woodinville, WA 98072 • USA

US and Canada: 800.898.3211

Europe, Asia, Central and South America: 425.487.4333

Middle East and Africa: 31.20.654.4000

Fax: 425.487.4337 • www.mackie.com

E-mail: sales@mackie.com