

Digital Systems

REMOTE 48

USER'S GUIDE

Digital Systems



Digital Systems

Digital Systems

Digital Systems

**PROFESSIONAL REMOTE CONTROL FOR THE
HDR24/96 HARD DISK RECORDER**

MACKIE.

Digital Systems



The lightning flash with arrowhead symbol within an equilateral triangle is intended to alert the user to the presence of uninsulated "dangerous voltage" within the product's enclosure, that may be of sufficient magnitude to constitute a risk of electric shock to persons.

Le symbole clair avec point de flèche à l'intérieur d'un triangle équilatéral est utilisé pour alerter l'utilisateur de la présence d'un voltage dangereux non isolé d'ampleur suffisante pour constituer un risque d'électrocution.



The exclamation point within an equilateral triangle is intended to alert the user of the presence of important operating and maintenance (servicing) instructions in the literature accompanying the appliance.

Le point d'exclamation à l'intérieur d'un triangle équilatéral est employé pour alerter les utilisateurs de la présence d'instructions importantes pour le fonctionnement et l'entretien (service) dans le livret d'instruction accompagnant l'appareil.

Important Safety Instructions

1. Read Instructions — Read, understand and follow all safety and operating instructions before using the Remote 48.
2. Retain Instructions — Keep these safety and operating instructions for future reference.
3. Heed Warnings — Follow all warnings on the Remote 48 and in these operating instructions.
4. Water and Moisture — Do not use the Remote 48 near water – for example, near a bathtub, kitchen sink, garden hose, incontinent poodle, sweaty drummer, etc. – or when condensation has formed on the unit.
5. Heat and Ventilation — Locate the Remote 48 away from heat sources such as radiators, campfires, compost pits, heliarc welders, magma flows, etc.
6. Power Sources — Connect the Remote 48 only to a power source of the type described in these operating instructions or as marked on the Remote 48.
7. Power Cord Protection — Route power supply cords so that they are not likely to be walked upon, tripped over, or abraded by items placed upon or against them. Pay particular attention to cords at plugs, convenience receptacles, and the point where they exit the Remote 48.
8. Object and Liquid Entry — Do not drop objects or spill liquids into the Remote 48. Clean only with a damp cloth; do not clean with liquid or aerosol cleaners.
9. Attachments — Use the Remote48 with only the accessories specified in this manual.
10. Damage Requiring Service — The Remote48 should be serviced only by qualified service personnel when:
 - A. The power supply cord or the plug has been damaged; or
 - B. Objects have fallen onto, or liquid has spilled into the unit; or
 - C. The unit has been exposed to rain or water; or
 - D. The unit does not appear to operate normally or exhibits a marked change in performance; or
 - E. The unit has been dropped, or its chassis damaged.

11. Servicing — Do not attempt to service the Remote 48. All servicing should be referred to the Mackie Service Department.
12. Lightning — Unplug the Remote 48 during lightning storms or when unused for long periods of time.
13. Grounding and Polarization — To prevent electric shock, do not use the Remote 48 polarized plug with an extension cord, receptacle or other outlet unless the blades can be fully inserted to prevent blade exposure. Do not defeat the Remote 48 grounding by plugging into an ungrounded receptacle or ground lift adapter.

This apparatus does not exceed the Class A/Class B (whichever is applicable) limits for radio noise emissions from digital apparatus as set out in the radio interference regulations of the Canadian Department of Communications.

ATTENTION — Le présent appareil numérique n'émet pas de bruits radioélectriques dépassant les limites applicables aux appareils numériques de class A/de class B (selon le cas) prescrites dans le règlement sur le brouillage radioélectrique édicté par les ministere des communications du Canada.

FCC Information

NOTE: This equipment has been tested and found to comply with the limits for a Class A digital devices, pursuant to Part 15 of the FCC Rules. These limits are designed to provide reasonable protection against harmful interference when the equipment is operated in a commercial installation. This equipment generates, uses, and can radiate radio frequency energy and, if not installed and used in accordance with the instruction manual, may cause harmful interference to radio communications. Operation of this equipment in a residential area is likely to cause harmful interference in which case the user will be required to correct the interference at his own expense.



This product has been tested and complies with the following standards and directives as set forth by the European Union:

- * EN 55022 Radiated and Conducted Emissions
- * EN 61000-4-2 Electrostatic Discharge Immunity
- * EN 61000-4-3 RF Electromagnetic Fields Immunity
- * EN 61000-4-4 Electrical Fast Transient/Burst Immunity
- * EN 60950/IEC 950 Electrical Safety

WARNING — To reduce the risk of fire or electric shock, do not expose this appliance to rain or moisture.

Contents

- Introduction ----- 4
- Installation ----- 5
 - Mount on Stand (Optional) ----- 5
 - Mount on Mic Stand (Optional) ----- 5
- Plug It In ----- 6
 - What About The Remote 24 ? ----- 6
- Footswitch ----- 6
- Operation ----- 7
 - Transport ----- 7
 - Stop ----- 7
 - Play ----- 7
 - Fast Forward/Rewind ----- 7
 - Record ----- 7
 - Transport Locate ----- 7
 - Numbered Locates ----- 8
 - Shuttle and Jog ----- 8
 - Shuttle and Jog Wheel ----- 8
 - Transport Modes ----- 9
 - Pre Roll ----- 9
 - Loop ----- 9
 - Punch ----- 9
 - Rehearse ----- 9
 - Auto Play ----- 9
 - Auto Take ----- 9
- Record/Monitor Controls ----- 10
 - Record Ready ----- 10
 - All Input ----- 10
 - Auto Input ----- 10
 - Record Safe ----- 10
 - Lock Out ----- 10
- System Controls ----- 11
 - Deck 2 ----- 11
 - Edit ----- 11
 - Vari ----- 11
 - ALT ----- 11
 - Control ----- 11
- Displays ----- 12
 - Tape Time ----- 12
 - Locate Time ----- 12
 - Vari ----- 12
 - Cue ----- 12
 - Rates ----- 12

- Autolocator ----- 13
 - Numeric Keypad ----- 13
 - Time Entry ----- 13
 - Time Units ----- 14
 - Edit Time ----- 14
 - +Next and -Prev ----- 14
 - Cues ----- 14
 - Capture ----- 14
 - Clear ----- 15
 - Enter ----- 15
 - Store ----- 15
 - Recall ----- 16
 - Time Code Calculator ----- 17
- Other Stuff ----- 18
 - Specifications ----- 18
 - Troubleshooting & Warranty Service --- 18

Thank you for adding the Remote 48 to your line of Mackie equipment. If you're familiar with the HDR24/96, you probably already know what most of this remote control does, but just in case, this guide will explain all those other buttons ... some of which are new or a little different from the Remote 24 and HDR24/96 front panel.

Note: *When this manual refers to the HDR24/96 recorder, the MDR24/96 recorder applies as well unless stated otherwise.*

Please write your serial number here for future reference:

Purchased at:

Date of Purchase:

Don't forget to visit our website at www.mackie.com for updates to this manual and additional information about this and other Mackie products.



Introduction

The Remote 48 is a professional remote controller for both the Mackie HDR24/96 and MDR24/96. It is used to control one or more HDR24/96 recorders. The Remote 48 offers all the functionality of the HDR24/96 front panel, along with several other features not found on the HDR24/96 or Remote 24, including:

- Weighted wheel for Jog/Shuttle transport operations and data entry
- Autolocator with numeric keypad
- Cue display with Cue Store and Recall
- Record Ready keys for 48 tracks
- System control for two HDR24/96 recorders
- Time code Calculator

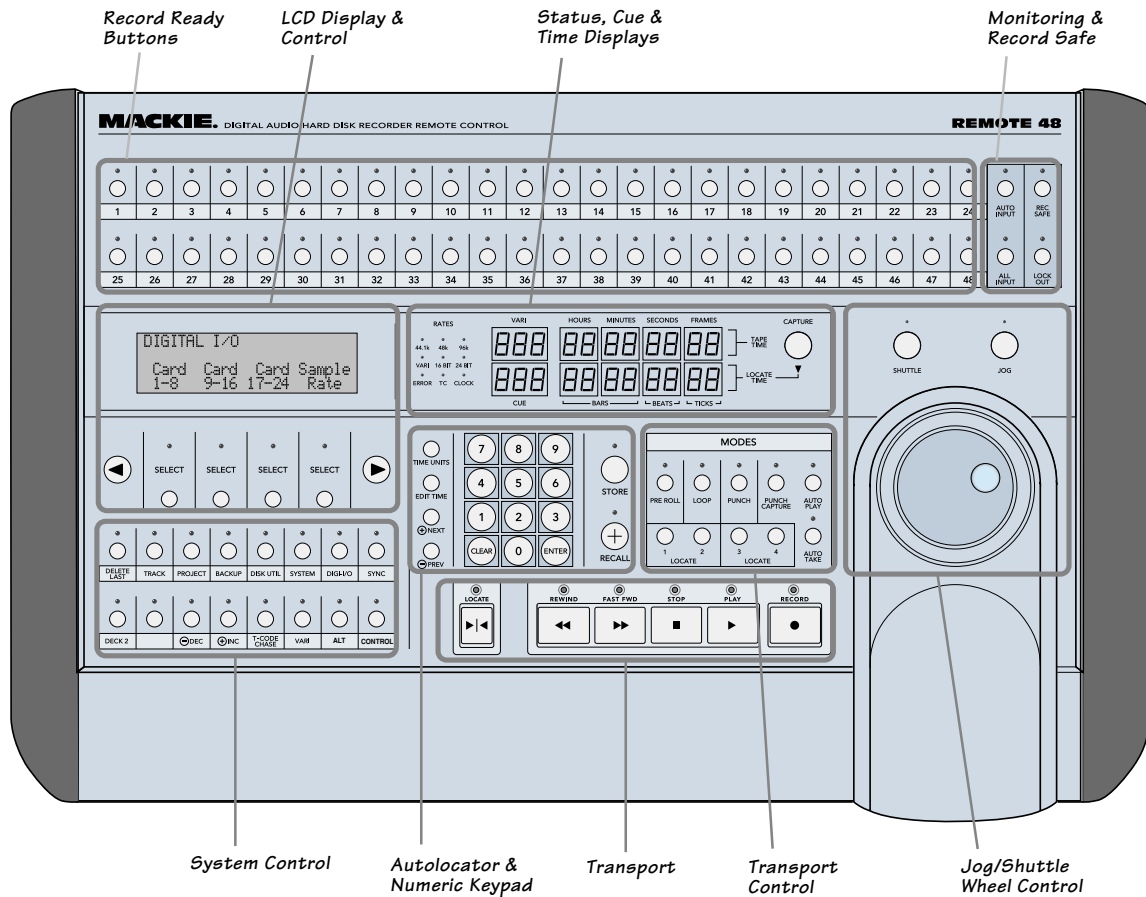

Installation

Mount on Stand (Optional)

The Remote 48 can be placed on any stable work surface, but for optimal support we recommend the Quik-Lok QL-406 stand. The QL-406 is a roll-around remote stand with height and tilt adjustment made specifically for the Remote 48. See www.quiklok.com for specifications.

Quik-Lok QL-406

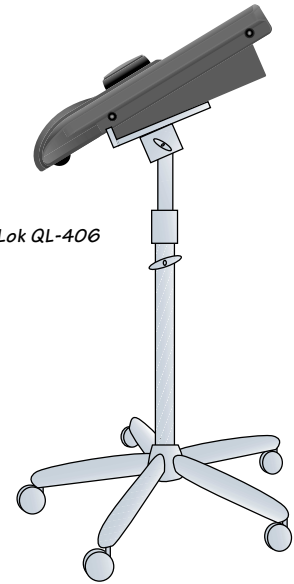

Mount on Mic Stand (Optional)

When mounting the Remote 48 on a standard 5/8" thread mic stand, we recommend the Omnimount 50-ST mounting plate and 5000-MA stand adaptor. Be sure the base of the stand is broad enough to adequately support the Remote 48.

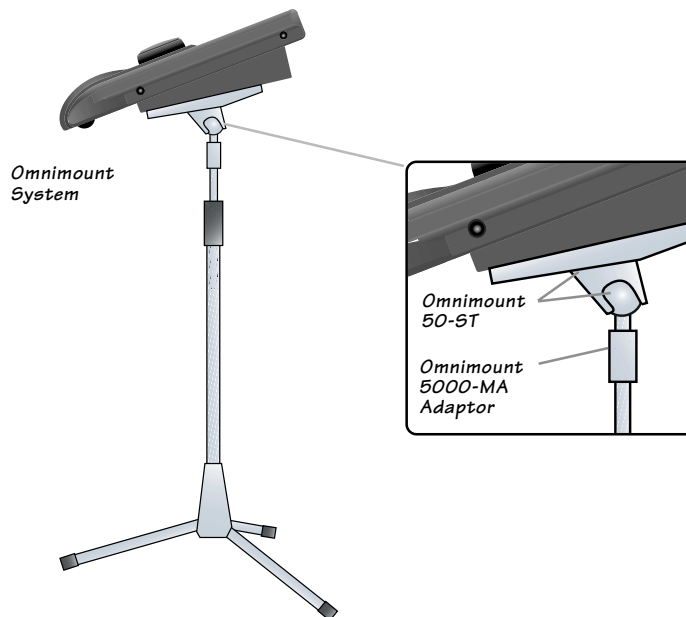



Note: Power-up the Remote 48 before powering the HDR24/96.



Note: When using two HDR24/96 recorders in a 48-track system, plug the Remote 48 into the Master HDR24/96 (Tracks 1-24)

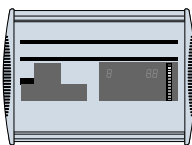

Plug It In

Setting up the Remote 48 is as easy as plugging in a telephone:

1. Plug the 25-foot remote cable (supplied with your unit) into the **TO HDR** jack on the back of the Remote 48, and the other end into the **REMOTE** jack on the back of the HDR24/96.
2. Plug the supplied IEC power cable into the power jack on the back of the Remote 48.

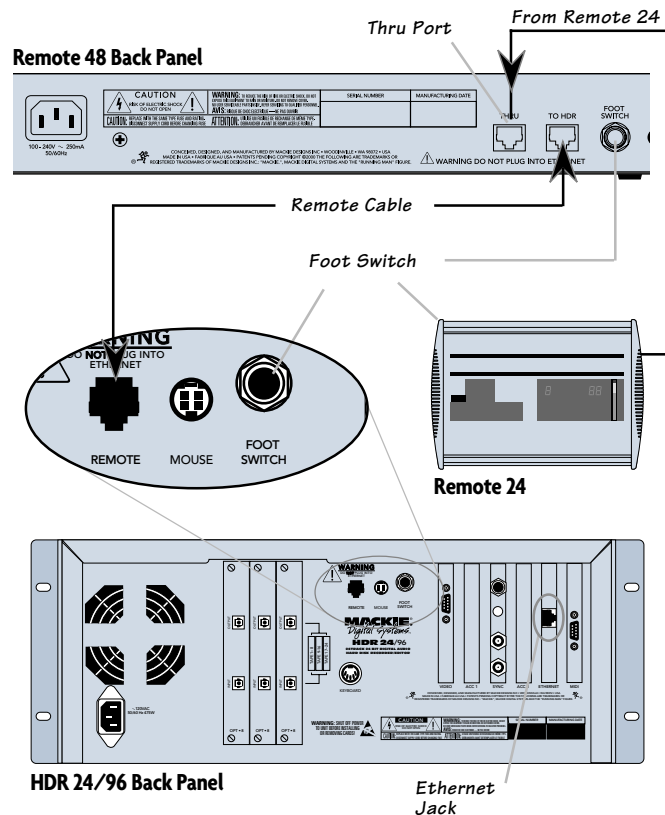

What About The Remote 24 ?

Good question! You can use the Remote 24 in parallel with the Remote 48. Simply connect it to the Remote 48's **THRU** port using the Remote 24's supplied cable. This is an especially useful configuration if, for example, you have an additional workstation or sound stage/booth located away from the Remote 48. We think there is a 'more than remote' possibility of you using this setup.

In this configuration the Remote 48 will remain fully operational. Of course, you will not have access to features unique to the Remote 48 such as arming tracks 25-48, when controlling from the Remote 24.

Footswitch

A must-have for performer-engineers: use a footswitch to punch-in and out on the fly, stop and start the transport, jump to the next cue, create new cues, or select the next take. The footswitch function is assigned in the HDR24/96 General Setup window. This TS 1/4" jack accepts a momentary, normally open footswitch—available at any reputable music store.



Operation

Many of the features, functions, and procedures of the Remote 48 mirror those of the HDR24/96 and Remote 24, and are therefore already defined in the HDR24/96 and Remote 24 user's manuals. Therefore keep your HDR24/96 Quick Start Guide, HDR24/96 Technical Reference Manual, and Remote 24 User Guide on hand for reference.

Transport

Stop

STOP brings the "tape" to an immediate halt. **STOP** also punches out of record and cancels master record standby.



Play

PLAY puts the HDR24/96 into play; it also punches out of record and cancels master record standby.

Fast Forward/Rewind

FAST FWD and **REWIND** put the HDR24/96 into fast wind mode from any state. They behave just like a large multitrack recorder. When **REWIND** or **FAST FWD** are pressed, the "tape" rolls slowly at first, then accelerates to 20X speed in a few seconds. Pressing either button a second or third time puts the transport into even faster wind speeds.



Record

Press **PLAY** and **RECORD** simultaneously to begin recording. Press any transport button except Record, Jog, or Shuttle to stop recording. The Record LED glows when recording, and blinks when **RECORD** is engaged with no tracks armed. In a 48-track system, the Record LED glows when either HDR24/96 is recording.

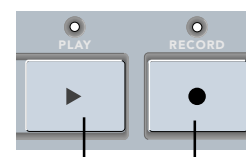

Transport Locate

Pressing the transport **LOCATE** button causes the transport to jump to the time displayed in the Locate Time window. The Locate LED glows whenever Tape Time = Locate Time, otherwise it is off. The Remote 48 **LOCATE** button corresponds to the **LOC** button in the GUI transport.



Numbered Locates

In addition to the transport locate point, there are four numbered **LOCATE** points to give you quick access to frequently used locations in your Project. Press one of the four numbered **LOCATE** buttons to jump to a Locate point. Numbered Locates are set using the store function (see **AUTOLOCATOR**).

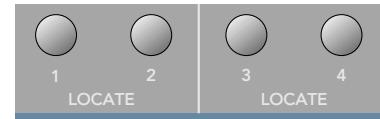

Shuttle and Jog

Both shuttle and jog allow you to play audio both forwards and backwards at non real-time speeds. Shuttle play speed is quantized to 1/32, 1/16, 1/8, 1/4, 1/2, 1, and 2x the normal play speed, and is proportional to how far the Wheel is rotated after **SHUTTLE** is engaged. **JOG** is similar to shuttle, except that the play speed varies continuously between 0x and 1x and is proportional to how fast you rotate the wheel. Both give you very precise control of the transport position for cueing to edit points.



Pressing **SHUTTLE** or **JOG** engages Shuttle/Jog, and pressing any transport button except Record disengages Shuttle/Jog. With either **SHUTTLE** or **JOG** engaged, rotating the wheel counterclockwise produces reverse transport movement, and clockwise produces forward movement. When the transport is not moving, the Play LED blinks; when the transport is moving, the Play LED glows and the Fast Forward or Rewind LED blinks to indicate the playback direction.



Note: Shuttle must be disabled to enter Record.

Shuttle and Jog Wheel

In addition to its use as a Shuttle/Jog controller, the wheel is used for data entry in certain autolocator operations, such as scrolling through the cue list or changing time values in edit time operations. Data entry mode is overridden whenever **SHUTTLE** or **JOG** is enabled. See **AUTOLOCATOR** for specific uses of the wheel in date entry mode.

Transport Modes

Pre Roll

PRE ROLL causes any Locate operation to jump to a time that is earlier than the stored Locate time by the amount of the Pre Roll time. For example, if you wish to locate to 00:05:00:00 and you enter a Pre Roll of 5 seconds, the transport will locate to 00:04:55:00. Pre Roll is handy for auto punching where you need to start playback a few seconds before the Punch In point.

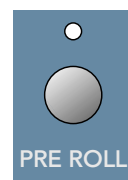

Loop

LOCATES 1 and **2** double as start and end points for looped playback. To enable loop play, press **LOOP**. Playback will loop from **LOCATE 1** to **LOCATE 2**. The order of the loop points does not matter.



Punch

LOCATES 3 and **4** double as in and out points for automated punching. To enable automated punching, press **PUNCH**. When you engage **RECORD**, the HDR24/96 automatically punches in at the first punch point, and punches out at the second. The order of the punch points does not matter.

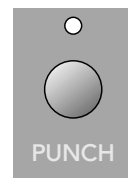

Rehearse

REHEARSE allows you to practice punching without actually recording anything to disk. In this mode the last Punch In and Punch Out points are automatically stored to Loc 3 and Loc 4 (respectively). If multiple punch ins and outs occur during a single pass, only the last punch points are stored. Punch points are not stored when punching with the track Record Ready buttons or when **PUNCH** and **REHEARSE** are both enabled.



Auto Play

AUTO PLAY puts the transport into play immediately after locating to a Cue or Locate point.

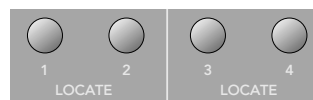

Auto Take

AUTO TAKE automatically increments the active Virtual Take number of all armed Tracks at the beginning of each record pass. After Take 8 is recorded, the take number jumps back to Take 1. You can set a track's take number from the Remote 48 Track Options menu.

Record/Monitor Controls

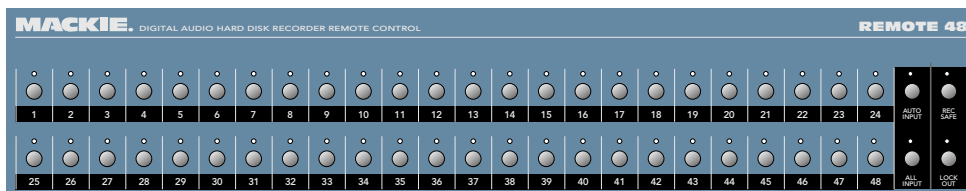

Record Ready

The Record Ready buttons arm tracks for recording. When **RECORD** is engaged, you can punch individual tracks in and out using the Record Ready buttons. Their LEDs blink in standby and glow in record. In a 48-track system, Record Readys 1-24 arm the Master HDR24/96, and Record Readys 25-48 arm the Slave HDR24/96.

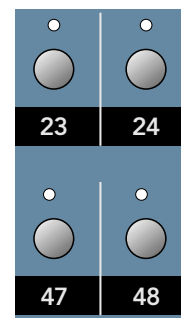

All Input

ALL INPUT is used for rehearsal and level setting. When **ALL INPUT** is on, both armed and unarmed tracks monitor their tape inputs, and the Auto Input setting has no effect.



Auto Input

AUTO INPUT is used for recording, and affects only armed tracks. When **AUTO INPUT** is off, armed tracks always monitor their tape inputs; this mode is used for tracking. When **AUTO INPUT** is on, armed tracks monitor their tape inputs in stop, fast forward, rewind, and record. In play, they monitor the playback of previously recorded audio; this mode is used for overdubbing. Unarmed tracks always monitor the playback of previously recorded audio.



Record Safe

REC SAFE disarms all tracks and disables all recording controls. When enabled, Record Safe prevents you from arming tracks and entering record.



Lock Out

LOCK OUT disables user input from all software and hardware controls while allowing the HDR24/96 to otherwise operate normally. To engage or disengage lock out on the Remote 48, hold down the **LOCK OUT** button for 1 second. The Lock Out LED blinks when enabled and is off when disabled. Use Lock Out to prevent someone from disturbing the HDR24/96 during critical operations, such as when recording live performances.



System Controls

The System Controls that are unique to the Remote 48 are described below. For more detail on System Controls that are common to both the HDR24/96 and Remote 48, see the HDR24/96 Technical Reference Manual or Quick-Start Guide.

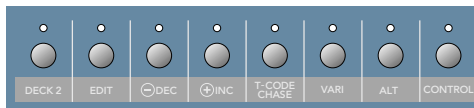

Deck 2

The **DECK 2** button toggles Remote 48 control of the LCD display, Rates display, and System Control buttons between the Master and Slave HDR24/96. The Remote 48 controls the Master HDR24/96 when the Deck 2 LED is off, and the Slave HDR24/96 when the Deck 2 LED is blinking.

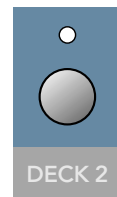

Edit

The Edit button is not presently implemented and is reserved for a future software upgrade.

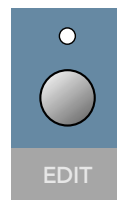

Vari

Varispeed is not presently implemented in the HDR24/96. This button is reserved for a future software upgrade.

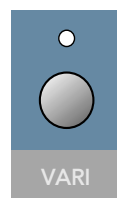

ALT

The **ALT** button modifies the functionality of another button. Specific uses of the **ALT** button are documented within the function(s) it modifies.

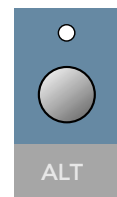

Control

The **CONTROL** button modifies the functionality of another button. Specific uses of the **CONTROL** button are documented within the function(s) it modifies.

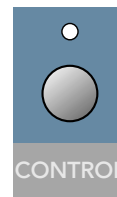

Displays

Tape Time

The **TAPE TIME** display always shows the current position of the HDR24/96 “play head” (Current Time). It is the same as the Current Time displays on the HDR24/96 front panel and GUI.

Locate Time

The **LOCATE TIME** displays the time that the Transport will locate to when the **LOCATE** button is pressed, and corresponds to the **LOCATE TIME** display in the GUI Cues List. Locate Time also acts as a scratchpad or working display from which you can preview and recall stored time values, manually enter and store specific times to these values, or display the result of time code addition/subtraction operations.

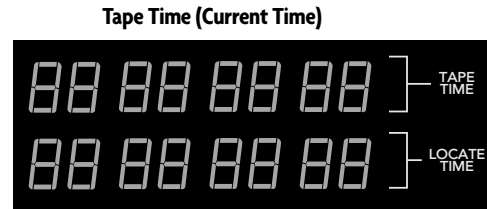

Vari

The **VARI** (Varispeed) display shows the transport speed whenever **SHUTTLE** or **JOG** is enabled. Depending on the speed, the Varispeed display shows quantized values of 0.0, 0.03, 0.06, 0.12, 0.25, 0.5, 1.0, and 2.0 in Shuttle, and contiguous values between 0.00 and 1.00 in Jog. The blinking Rewind LED indicates reverse motion (negative speeds).



Cue

The **CUE** number display shows the Cue number that was last entered, stored, or recalled. It also shows the names of other stored values (**Pre** for Pre-roll, **LOP** for loop length, **PCH** for Auto Punch, **L1 – L4** for Loc 1 through Loc 4, and **PLA** for the last play start position) during a Recall operation.



Rates

44.1k, 48k, 96k (Sample Rate)

The Sample Rate LEDs indicate the system sample rate setting. The 44.1k and 96k LEDs light simultaneously to indicate a sample rate setting of 88.2kHz.

Vari (Varispeed)

When the sample clock is set to either Word Clock or Video, the **VARI** LED lights when the actual sample rate differs from the sample rate setting by more than $\pm 0.2\%$.

16 Bit, 24 Bit (Bit Depth)

The **16 BIT** and **24 BIT** LEDs reflect the system bit depth setting.

Error

The **ERROR** LED blinks when there is a system error that requires user attention. Selecting Cancel from the LCD display clears the error message.

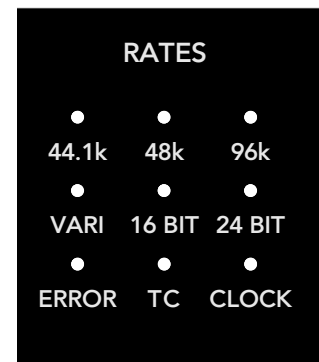

TC (Time Code)

The **TC** LED represents the status of the HDR24/96 with respect to received time code. When **T-CODE CHASE** is enabled, the **TC** LED blinks when either no time code is present or time code is unreadable, and glows when the HDR24/96 is locked to time code. The **TC** LED is off when **T-CODE CHASE** is disabled.

Clock

The **CLOCK** LED glows when the system is locked to the selected sample clock source, and blinks when the sample clock source is not present or out of range. The **CLOCK** LED always glows when the sample clock is set to Internal.

Autolocator

This section describes the Remote 48 Autolocator functions. Some Autolocator functions have many steps associated with them. The convention for describing an Autolocator operation is:

[<Step 1> → < Step 2> → < Step 3><Step n>].

where you perform step 1, then step 2, then step 3, and so forth until the last step in the sequence. Buttons presses are shown in bold, and numeric keypad entry with pound signs (###...). Some Autolocator operations require only one step, others up to four.

Numeric Keypad

The numeric keypad is used to enter time values into the Locate Time display or Cue numbers into the Cue display (see **TIME ENTRY**, **EDIT TIME**, **STORE**, **RECALL**, and **TIME CODE CALCULATOR**).

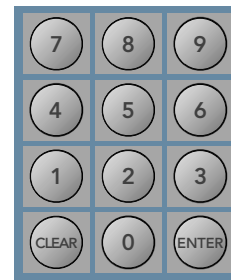

Time Entry

With no Autolocator operations pending, typing a time value on the Numeric Keypad clears the **LOCATE TIME** display and shifts the numbers left into the display. Pressing **ENTER** (as well as several other Autolocator functions) terminates the entry. Pressing **CLEAR** anytime while entering numbers acts as a backspace. Clearing the last digit out of the display cancels the operation, and restores the previous Locate Time value. You do not need to type all 8 digits each time you enter a time; the Remote 48 fills-in the blanks with zeros after time entry is terminated. The rightmost dot in **LOCATE TIME** display flashes when time entry is active.

The Remote 48 supports two basic time entry operations:

- [#####... → **ENTER**]

Stores the entered time into Locate Time.

- [#####... → **LOCATE**]

Locate to a specific time without overwriting the current Locate Time value; the previous value of Locate Time is restored after the operation is completed.

Time Units

The **TIME UNITS** button toggles the time units of the HDR24/96 between SMPTE and BBT display modes.



Edit Time

The **EDIT TIME** button allows you to edit specific fields within the **LOCATE TIME** display. Pressing **EDIT TIME** once selects the Frames/Ticks field (depending on display mode), a second time the Seconds/Beats field, and so on, until the selection wraps back around to the Frames/Ticks field. The rightmost dot in the selected field flashes to indicate that editing is active in that field.

Advancing the edit time field sets the value in the previous field. Pressing **ENTER** sets the Locate Time and cancels Edit Time editing.



You can enter time in three different ways:

- [**EDIT TIME** (one or more times) → ###... → **ENTER**] Enter the desired time directly from the numeric keypad. The numbers shift left continually until the field value is set by pressing **EDIT TIME** or **ENTER**.
- [**EDIT TIME** (one or more times) → **+NEXT** or **-PREV** (one or more times) → **ENTER**] Press the **+NEXT** and **-PREV** buttons to increment/decrement the value by 1.
- [**EDIT TIME** (one or more times) → **Wheel** → **ENTER**] Rotate the wheel clockwise/counterclockwise to increment/decrement the values continuously.

+Next and -Prev

The **+NEXT** and **-PREV** buttons increment and decrement Locate Time field values in Edit Time operations, act as math operators in time code calculator operations, and call up the next or previous Cue in the Cue List in specific Recall and Store operations (see **EDIT TIME**, **STORE**, **RECALL**, and **TIME CODE CALCULATOR**).

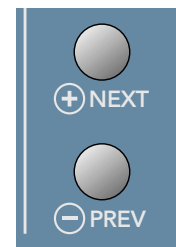

Cues

Cues are Locate points (not to be confused with Locates 1-4) that can be set anywhere in the Project. Up to 999 Cues can be stored and recalled from the Remote 48 (see **STORE** and **RECALL**).



Capture

CAPTURE copies the value of Tape Time into Locate Time. Tape Time can be captured when the transport is stopped or moving.

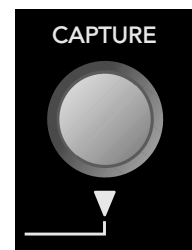

Clear

CLEAR deletes the last value entered into the **LOCATE TIME** or **CUE** display by shifting all of the numbers right by one character. When entering time into the **LOCATE TIME** display, pressing **CLEAR** after the last character is deleted cancels the operation and restores the previous Locate Time value.



Enter

The **ENTER** button terminates the entry of a string of numbers when entering a time in the **LOCATE TIME** display, and completes Time Entry, new Cue and Cue Store operations. It also completes Recall operations and acts as an "=" button in Time Code Calculator operations (see **TIME ENTRY, EDIT TIME, STORE, RECALL, and TIME CODE CALCULATOR**).



Store

STORE stores the value of the **LOCATE TIME** or **TAPE TIME** displays into Cues, Numbered Locates, Pre Roll time, and the Loop and Punch lengths. Pressing **STORE** once selects the Locate Time, and pressing **STORE** twice (or CTRL+Store) selects the tape time for the store operation. A flashing dot in the right of the tape or locate time display indicates the time selected for the store operation. Pressing the last key in the store sequence transfers the value of locate or tape time to the destination. The **STORE** LED blinks when Store is armed, and goes dim after Store is executed or canceled. In the text below, the convention "<Store>" is used to denote any of the following button sequences: [Store], [Store → Store], or [CTRL+Store].

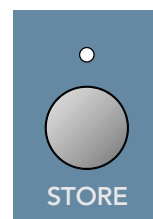

The Remote 48 supports the following Store operations:

- **[STORE → LOCATE n]**
Stores the selected time to a Numbered Locate
- **[STORE → PRE ROLL]**
Stores Locate Time to the Pre Roll time.
- **[STORE → LOOP]**
Sets the Loop End point (the later of Locates 1 and 2) by adding the Locate Time (Loop length) to the Loop Start point (the earlier of Locates 1 and 2).
- **[STORE → PUNCH]**
Sets the Punch End point (the later of Locates 3 and 4) by adding the Locate Time (Punch length) to the Punch Start point (the earlier of Locates 3 and 4).
- **[STORE → ENTER]**
Stores the selected time to the currently displayed Cue. This is a shortcut to save you from having to type in the Cue number again.
- **[STORE → CAPTURE]**
Stores the Tape Time to a New Cue. New Cues are sequentially numbered using the lowest number available in the Cue List. Note that you do not need to press **STORE** twice to store the Tape Time to a New Cue.

- [**STORE** → ###... → **ENTER**] Stores the selected time to a specific Cue.
- [**STORE** → +**NEXT** or -**PREV** (one or more times or hold to scroll), or **Wheel** → **Enter**] stores the Locate Time to a cue from the Cue List. Rotating the wheel or pressing +**NEXT** or -**PREV** allows you to scroll through the Cue List in chronological order until you find the desired cue.
- [**STORE** → **STORE** → **STORE**] or [**CTRL+Store** → **Store**] Cancels the store operation. You can also store a specific time to any stored value without overwriting the current Locate Time value; the previous value of Locate Time is restored after the operation is completed.
- [#####... → **STORE** → **LOCATE n**] Stores the directly entered time to a Numbered Locate.
- [#####... → **STORE** → **LOOP**] Stores the Loop End point (the later of Locates 1 and 2) by adding the directly entered (Loop length) to the Loop Start point (the earlier of Locates 1 and 2).
- [#####... → **STORE** → **PUNCH**] Stores the Punch End point (the later of Locates 3 and 4) by adding the directly entered time (Punch length) to the Punch Start point (the earlier of Locates 3 and 4).
- [#####... → **STORE** → **PRE ROLL**] Stores the directly entered time to Pre Roll.
- [#####... → **STORE** → ###... → **ENTER**] Stores the directly entered time to a specific Cue.

Recall

RECALL calls up the value of stored values into the Locate Time display. After pressing **RECALL**, you can preview any number of stored values (Cues, Numbered Locates, etc.) in any order without overwriting the current Locate Time value. At any time while previewing, the displayed value can be committed to Locate Time by pressing **ENTER**. Pressing **RECALL** a second time cancels the operation and restores the previous Locate Time value.



When **RECALL** is pressed, a dot flashes in the right of the Cue display to indicate that the **CUE** display is available for numeric entry. If a cue number is present in the **CUE** display before **RECALL** is pressed, then that cue's value is displayed in the **LOCATE TIME** display. If a non-existent cue number is entered, the **LOCATE TIME** displays dashes (" - - ") until a valid cue or other stored value is selected. The Recall LED blinks when Recall is active, and goes off after Recall is executed or canceled.

The Remote 48 supports the following Recall operations:

- [**RECALL** → **LOCATE n** → **ENTER**] Recalls Locate *n* to Locate Time.
- [**RECALL** → **LOOP** → **ENTER**] Recalls the Loop length (the time between Locates 1 and 2) to Locate Time.
- [**RECALL** → **PUNCH** → **ENTER**] Recalls the Punch length (the time between Locates 3 and 4) to Locate Time.

- **[RECALL → PRE ROLL → ENTER]** Recalls the Pre Roll Time to Locate Time.
- **[RECALL → PLAY → ENTER]** Recalls the time of the last Play command to Locate Time.
- **[RECALL → ###... → ENTER]** Recalls a specific Cue to Locate Time.
- **[RECALL → ENTER]** Recalls the currently displayed Cue to Locate Time. This is a shortcut to save you from having to type the Cue number.
- **[RECALL → +NEXT or -PREV (one or more times or hold to scroll), or Wheel → ENTER]** Recalls a Cue from the Cue List. Rotating the wheel or pressing +NEXT or -PREV allows you to scroll through the Cue List in chronological order until you find the desired Cue.
- **[RECALL → RECALL]** Cancels the recall operation. Using **RECALL**, you can also locate to any stored value without overwriting the current Locate Time value; the previous value of Locate Time is restored after the operation is completed.
- **[RECALL → PLAY → LOCATE]** Locates to the time of the last Play command.
- **[RECALL → ###... → LOCATE]** Locates to the time of the selected Cue.
- **[RECALL → +NEXT or -PREV (one or more times or hold to scroll), or Wheel → LOCATE]** Locates to a Cue from the Cue List. Rotating the wheel or pressing +NEXT or -PREV allows you to scroll through the Cue List in chronological order until you find the desired Cue.

Time Code Calculator

The Time Code Calculator adds or subtracts two time values entered into the **LOCATE TIME** display and stores the result back into Locate, making operations like adding 00:03:23:18 to 1:58:34:22 as easy as doing first grade arithmetic. The Time Code Calculator works in both SMPTE and BBT display modes. Using the Calculator is similar to using a pocket calculator, except that Enter is equivalent to the “=” button.

The Remote 48 supports the following Time Code Calculator operations:

- **[+NEXT → #####... → ENTER]** Adds the directly entered time to the current Locate Time value.
- **[-PREV → #####... → ENTER]** Subtracts the directly entered time from the current Locate Time value.
- **[#####... → +NEXT → #####... → ENTER]** Adds the first directly entered time values to the second.
- **[#####... → -PREV → #####... → ENTER]** Subtracts the second directly entered time value from the first.
- **[#####... → -PREV → #####... → ENTER]** Subtracts the second directly entered time value from the first.

Note: When the TC Frame rate is drop frame, the operands are first converted to non-drop frame, the operation performed, and the result converted back to non-drop frame.

Other Stuff

Specifications

Dimensions:

Width = 19.25" (48.90 cm)

Depth = 12.25" (31.12 cm)

Height = 3.50" (8.89 cm)

Weight:

12.1 lbs (5.49 kg)

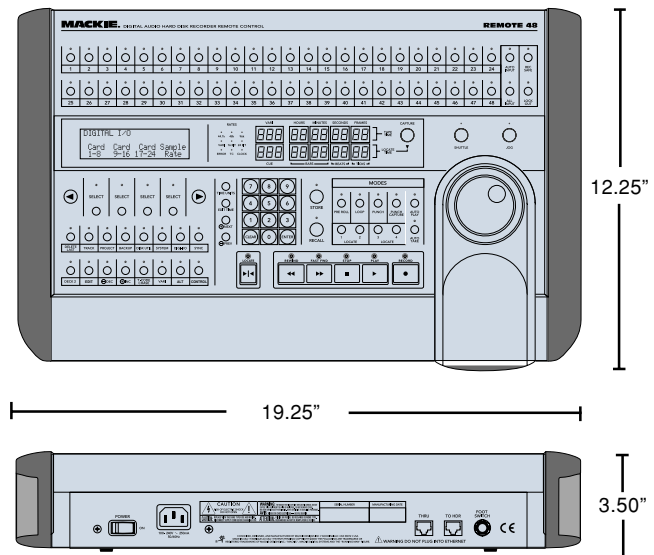

Troubleshooting & Warranty Service

If you think your Remote 48 has a problem, try the following:

Make sure the cable is plugged into the “Remote” jack on the rear panel of the HDR24/96—the “Remote” jack is easy to confuse with the Ethernet jack.

Remove and reinstall the cable, reboot the HDR24/96, and/or replace the Remote 48 cable (available at computer supply stores).

Be sure you are **not** using a CAT-5 crossover cable (usually known by its yellow color and always labeled “Crossover”).

Put the Remote 48 into self-test mode and test the function of the switches and LEDs.

- Place a blank floppy disk into the HDR24/96 and power up the unit while holding down **Record Ready** buttons 1 and 2 on the Remote 48.
- When the unit is first powered on, all LEDs will be lit, and the Remote 48 firmware version number is shown in the LCD display.
- Pressing a button associated with an LED turns the LED off.
- Pressing a **LOCATE** button lights the LED above it in the Locator section.

After all this, if it still doesn't work properly please contact Mackie Designs technical support at (800) 258-6883 (8:00 AM to 5:00 PM Pacific Time)—see the included Warranty Card for details.

“Mackie,” the “Running Man” figure, “HDR24/96”, “Remote 48” and “Remote 24” are trademarks or registered trademarks of Mackie Designs Inc. All other brand names mentioned are trademarks or registered trademarks of their respective holders, and are hereby acknowledged.

© 2001 Mackie Designs Inc.
All Rights Reserved.
Printed in the U.S.A.
Rev A 10/01

Notes:

Digital Systems

Digital Systems
Digital Systems

Digital Systems

Digital Systems
Digital Systems

MACKIE®
Digital Systems