



MACKIE HOOK-UP GUIDE



ACTIVE STUDIO MONITORS



**OUR [IN]FAMOUS PRODUCT
HOOKUPS IN BYTE-SIZED MORSELS**

Copyright © 2002 Mackie Designs Inc. All Rights Reserved.

PRINTING NOTE: These pages were built 21cm wide (8.26in) by 27.94cm (11in) tall to accommodate the printers of both our North American users and our users around the globe. This PDF will print at 100% on both “Letter” sized and “A4” sized paper (with room in the left margin for hole punching).

Hello and welcome to one of many downloadable web editions of Mackie’s Product Hook-Up Guide. Since 1992, we’ve been including these helpful “connection maps” in our ***In Your Face*** product guides, and we’ve been urged to continue doing so because they’re so gosh-darned helpful. Now, we’ve split our hook-ups into product families, and made them available to you over this new-fangled “Internet” thingy that everyone is talking about these days.

There will be documents that cover hooking up our compact VLZ® PRO Series, Analog 8•Bus Series consoles, CFX Series effects mixers, DFX Series compact effects mixers, the D8B digital console, the HDR24/96 hard disk recorder, PPM Series powered mixers, the FR Series amplifiers, SR Series front-of-house mixers, and our Active loudspeakers.

Inside you’ll find lots of useful information – most likely your questions will be answered here. We realize that there’s no possible way to cover every single question or application in so few pages because new ways to use Mackie products are invented every day. You may come up with some ideas on how to do what you want by looking at the various diagrams we’ve included here.

Keep in mind that a good half of the battle in hooking up our products is having the proper connections. Check the cables ’n’ plugs that you already have with the diagrams on the next page. We know it may look boring, but one of these drawings could save your life. Well, maybe not your life, but probably a lot of weeping and sorrow. And don’t forget to check out the tech tips/FAQs document also available for download on the web at www.mackie.com/techsupport

If you don’t find the answers you’re after, then why not give our mighty Tech Support gang a call? These folks have tons of experience in the real world, and they’ve got lots of equipment and mixers at their beck and call. They’re aching to share their knowledge with you. (And calling them would be a very humanitarian thing to do – they’re located in the dank sub-basement of our building and they rarely get visitors. Your call just may be the one that keeps their spirits alive.)

Call Mackie Tech Support toll-free (in the U.S.) at 800-258-6883 (Monday through Friday, 7 AM to 5 PM Pacific Time) with any Mackie product-question you can conjure. Put them through the wringer! We encourage it.

Incidentally, the Mackie Product Hook-Up Guide (Web Editions) were put together from within the confines of the Mackie Digital Mosh Pit – located on the second floor near the Area Of Refuge – by the well-meaning, super-preening Mackie Macintosh Department. We used Adobe InDesign®, Illustrator®, Photoshop®, and Acrobat® on a number of suped-up big daddy Macs.

Oh yeah: Copyright © 2002 Mackie Designs Inc. All Rights Reserved.

The following are trademarks or registered trademarks of Mackie Designs Inc.: “MACKIE.”, the “Running Man” figure, VLZ, XDR, D8B, HUI, CFX Series, FR Series, and HR Series.

TS Plug (mono)

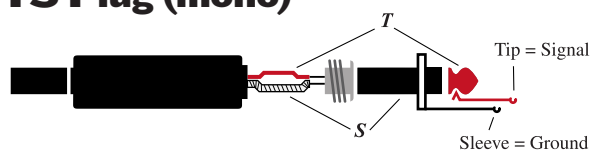

Standard mono/unbalanced phone plug used for most mixer connections.

TRS Plug (stereo)

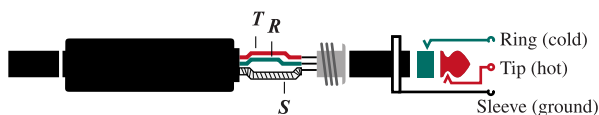

Standard stereo/balanced phone plug used for balanced connections on Mackie mixers.

Balanced XLR



Standard XLR microphone connector to be used with mic-level.

RCA/Phono Plug



Tape deck connections on most Mackie mixers.

Insert "Y" Cable

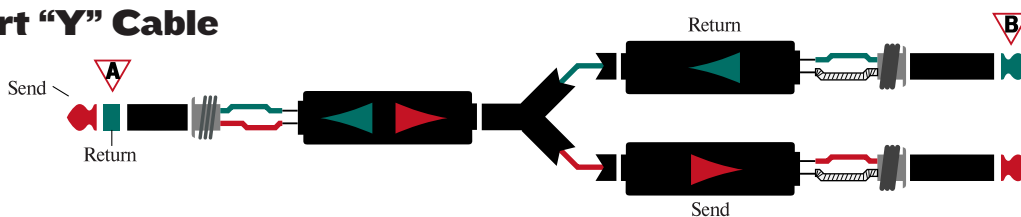

The "Y" Cable is used for connecting serial effects devices, such as graphic equalizers or compressors, to a Mackie mixer's Channel or Bus insert jacks. On one end is a standard Tip-Ring-Sleeve "stereo" plug. Its tip and ring are wired to separate mono Tip-Sleeve plugs. Note that the RING of the TRS plug (A) is actually wired to the TIP of one of the mono TS plugs (B). If you insert a TS (mono) 1/4" plug only partially (to the first click) into an insert jack, the plug will not activate the jack switch and will not break the insert connection in the circuit (thereby allowing the channel signal to continue on its merry way through

the mixer). See (C) in "Insert Points" below.

Partial insertion allows you to tap out of the channel or bus circuit at that point in the circuit without interrupting normal operation.

If you push the 1/4" TS plug in to the second click, you will open the jack switch and create a direct out, which does interrupt the signal in that channel or bus circuit. See (D) in "Insert Points" above. Note: Do not overload or short-circuit the signal you are tapping from the mixer. That will affect the internal signal of the mixer.

Insert Points

TS Plug (mono)



Direct out with no signal interruption to master. Insert only to first "click."

TS Plug (mono)



Direct out with signal interruption to master. Insert all the way in to the second "click."

TRS Plug (stereo)



For use as an effects loop. (TIP = SEND to effects RING = RETURN from effects)

Attention !



You may notice these effects unit hookups (Figure A) throughout this applications guide. These hookups utilize the Insert "Y" Cable (explained on the facing page).

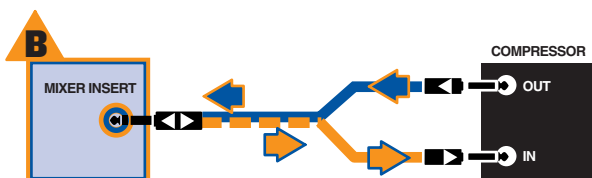

Figure B is a closeup of Figure A. The two colors represent the input and output traveling the length of the "Y" cable. The dotted line represents the two signals travelling alongside one another.



HR624/HR824

BASIC

SET IT UP, AND GO!



Note:
This configuration
also applies to
the HR624 as well
as HR824s

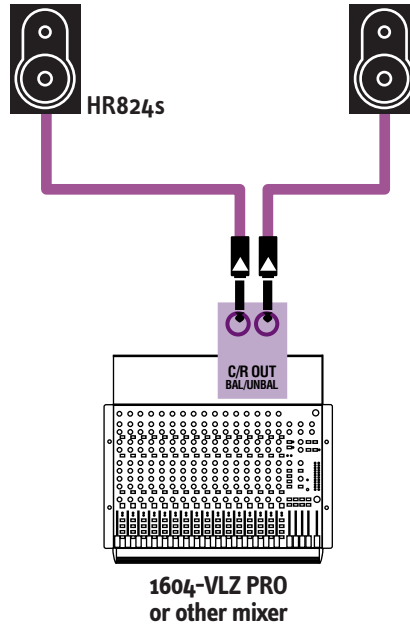

HR624/HRS120

SUB WITH FOOTSWITCH

SET IT UP, AND GO!

Note:
Switch in =
HR624s only
@ full range

Switch out =
HR624s + HRS120
Crossover engaged

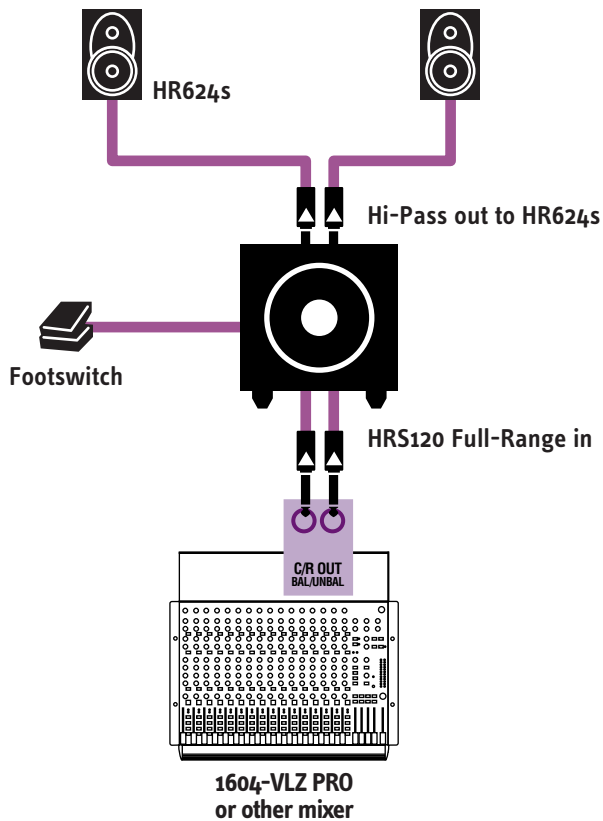



HR824/HRS120

DUAL SUBS

SET IT UP, AND GO!

Note:
Switch in =
HR824s only
@ full range

Switch out =
HR824s + HRS120s
Crossover engaged

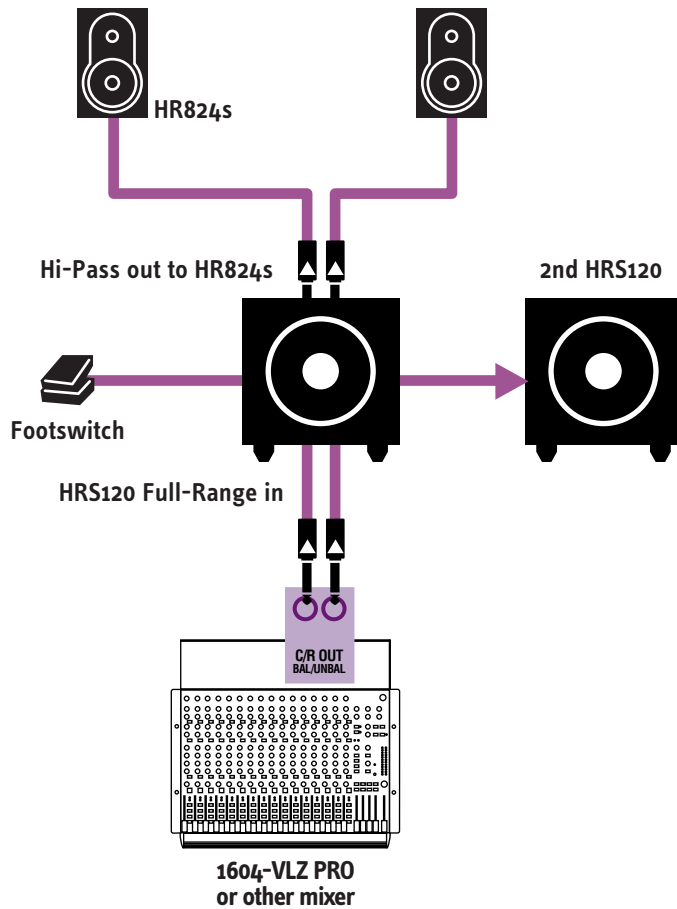



HR624/HRS120

5.1 SURROUND SYSTEM

SET IT UP, AND GO!

