

MINI

FUSSION 1800SA & 1800S ACTIVE SOUND REINFORCEMENT SUBWOOFER SYSTEM USER'S MANUAL

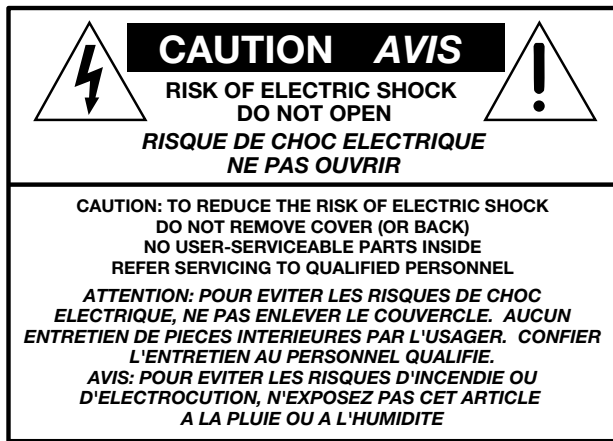



The lightning flash with arrowhead symbol within an equilateral triangle is intended to alert the user to the presence of uninsulated "dangerous voltage" within the product's enclosure that may be of sufficient magnitude to constitute a risk of electric shock to persons.

Le symbole éclair avec point de flèche à l'intérieur d'un triangle équilatéral est utilisé pour alerter l'utilisateur de la présence à l'intérieur du coffret de "voltage dangereux" non isolé d'ampleur suffisante pour constituer un risque d'électrocution.



The exclamation point within an equilateral triangle is intended to alert the user of the presence of important operating and maintenance (servicing) instructions in the literature accompanying the appliance.

Le point d'exclamation à l'intérieur d'un triangle équilatéral est employé pour alerter les utilisateurs de la présence d'instructions importantes pour le fonctionnement et l'entretien (service) dans le livret d'instruction accompagnant l'appareil.

SAFETY INSTRUCTIONS

- 1. Read Instructions** — All the safety and operation instructions should be read before this Mackie product is operated.
- 2. Retain Instructions** — The safety and operating instructions should be kept for future reference.
- 3. Heed Warnings** — All warnings on this Mackie product and in these operating instructions should be followed.
- 4. Follow Instructions** — All operating and other instructions should be followed.
- 5. Water and Moisture** — This Mackie product should not be used near water — for example, near a bathtub, washbowl, kitchen sink, laundry tub, in a wet basement, near a swimming pool, swamp or salivating St. Bernard dog, etc.
- 6. Ventilation** — This Mackie product should be situated so that its location or position does not interfere with its proper ventilation. For example, the Component should not be situated on a bed, sofa, rug, or similar surface that may block any ventilation openings, or placed in a built-in installation such as a bookcase or cabinet that may impede the flow of air through ventilation openings.

PORTABLE CART WARNING



Carts and stands - The Component should be used only with a cart or stand that is recommended by the manufacturer. A Component and cart combination should be moved with care. Quick stops, excessive force, and uneven surfaces may cause the Component and cart combination to overturn.

7. Heat — This Mackie product should be situated away from heat sources such as radiators, or other devices which produce heat.

WARNING: The heatsink may reach high temperatures during standard use. To ensure proper operation, allow a minimum of 6 inches of clearance from the heatsink surface and adequate ventilation.

8. Power Sources — This Mackie product should be connected to a power supply only of the type described in these operation instructions or as marked on this Mackie product.

9. Power Cord Protection — Power supply cords should be routed so that they are not likely to be walked upon or pinched by items placed upon or against them, paying particular attention to cords at plugs, convenience receptacles, and the point where they exit this Mackie product.

10. Object and Liquid Entry — Care should be taken so that objects do not fall into and liquids are not spilled into this Mackie product.

11. Damage Requiring Service — This Mackie product should be serviced only by qualified service personnel when:

- A.** The power-supply cord or the plug has been damaged; or
- B.** Objects have fallen, or liquid has spilled into this Mackie product; or
- C.** This Mackie product has been exposed to rain; or
- D.** This Mackie product does not appear to operate normally or exhibits a marked change in performance; or
- E.** This Mackie product has been dropped, or its chassis damaged.

12. Servicing — The user should not attempt to service this Mackie product beyond those means described in this operating manual. All other servicing should be referred to the Mackie Service Department.

13. To prevent electric shock, do not use this polarized plug with an extension cord, receptacle or other outlet unless the blades can be fully inserted to prevent blade exposure.

Pour prévenir les chocs électriques ne pas utiliser cette fiche polarisée avec un prolongateur, un prise de courant ou une autre sortie de courant, sauf si les lames peuvent être insérées à fond sans laisser aucune partie à découvert.

14. Grounding or Polarization — Precautions should be taken so that the grounding or polarization means of this Mackie product is not defeated.

15. This apparatus does not exceed the Class A/Class B (whichever is applicable) limits for radio noise emissions from digital apparatus as set out in the radio interference regulations of the Canadian Department of Communications.

ATTENTION — Le présent appareil numérique n'émet pas de bruits radioélectriques dépassant les limites applicables aux appareils numériques de class A/de class B (selon le cas) prescrites dans le règlement sur le brouillage radioélectrique édicté par les ministere des communications du Canada.

WARNING — To reduce the risk of fire or electric shock, do not expose this appliance to rain or moisture.



Lend Me Your Ears

Exposure to extremely high noise levels may cause permanent hearing loss. Individuals vary considerably in susceptibility to noise-induced hearing loss, but nearly everyone will lose some hearing if exposed to sufficiently intense noise for a period of time. The U.S. Government's Occupational Safety and Health Administration (OSHA) has specified the permissible noise level exposures shown in this chart.

According to OSHA, any exposure in excess of these permissible limits could result in some hearing loss. To ensure against potentially dangerous exposure to high sound-pressure levels, it is recommended that all persons exposed to equipment capable of producing these levels use hearing protectors while this unit is in operation. Ear plugs or protectors in the ear canals or over the ears must be worn when operating this amplification system in order to prevent a permanent hearing loss if exposure is in excess of the limits set forth here.

Duration Per Day In Hours	Sound Level dBA, Slow Response	Typical Example
8	90	Duo in small club
6	92	
4	95	Subway Train
3	97	
2	100	Very loud classical music
1.5	102	
1	105	Patrice screaming at Ron about deadlines
0.5	110	
0.25 or less	115	Loudest parts at a rock concert



The Fussion 1800SA and 1800S can produce a peak SPL of 139 dB @ 1m

CONTENTS

SAFETY INSTRUCTIONS	2	CONNECTIONS	6
INTRODUCTION	4	PLACEMENT	7
REAR PANEL DESCRIPTION	5	RIGGING	8
1 AC Receptacle	5	AC POWER	8
2 FUSE	5	SERVICE INFORMATION	9
3 POWER Switch	5	Warranty Service	9
4 POWER Indicator	5	Troubleshooting	9
5 MAIN INPUT	5	Repair	10
6 LOOP OUT	5	CARE AND MAINTENANCE	10
7 POWER OUT	5	FUSSION 1800SA/1800S SPECIFICATIONS	11

Don't forget to visit our website at www.mackie.com for more information about this and other Mackie products.



INTRODUCTION

Thank you for choosing Mackie Designs' active sound reinforcement speaker systems.

The FUSSION 1800SA and 1800S is an extreme output active subwoofer system. Designed to live on the road, this subwoofer system is a double 18" design broken down into two individual enclosures that make load-in and load-out quick and easy. It incorporates a 2500 watt high-efficiency amplifier system and two front-loaded, high-precision 18" woofers mounted within each cabinet. Connection and setup is a breeze. Just connect the SUB OUT line-level signal from a Fussion Series full-range active speaker, plug in the power cord, and you're ready to go.

The FUSSION 1800SA accepts a line-level signal via a female XLR input jack. All Fussion Series full-range active speaker systems include a SUB OUT signal via a male XLR that connects to the subwoofer system quickly and easily. The FUSSION 1800SA is specifically designed to work with the FUSSION 1800S. Power for the passive 1800S is provided by the 1800SA via a Neutrik™ female Speakon connector located on the rear panel.

Because the amplifier is located just inches away from the driver within its own protected enclosure, the amplifier enjoys several benefits. It sees a non-reactive load with a constant impedance, which substantially improves performance. It also sits on a mammoth heatsink that eliminates the need for fans, dramatically extending life expectancy, and eliminating maintenance cycles. A tremendous benefit of having the amplifier located within the subwoofer

cabinet is that the FUSSION 1800SA functions as a system, optimizing acoustic, electronic, and mechanical designs to achieve the highest level of performance and value.

Size was a paramount design objective during the development of the FUSSION 1800SA and 1800S. Double 18" subwoofer bins are typically very heavy, bulky, and difficult to handle. We spent over a year speaking with regional touring companies and gaining valuable insight from their experiences and suggestions. The result is an extremely compact system that is easy to transport and set up.

High-Efficiency, High-Current Design

The FUSSION 1800SA is the first subwoofer system to incorporate a passively cooled, high-efficiency, high-current design into an enclosure. The physical design is based on an amp-module philosophy that facilitates easy field service and repair. Reproduction of transients was the key goal when designing the amplifier, and to accomplish this we used an exorbitant quantity of high-voltage capacitors in the power supply to store the necessary energy. The result is a compact system that delivers concert-level, high-quality performance without the need of external amplification and processing.

The FUSSION 3000 can run on 115VAC or 230VAC and features soft-start circuitry that eliminates "pops" and precisely controls in-rush surges. The cabinet is constructed of 13-ply, 18mm thick baltic birch wood and is coated with high impact, black textured paint.

REAR PANEL DESCRIPTION

1 AC Receptacle

This is where you connect the AC linecord to provide AC power to the FUSSION 1800SA's built-in power amplifiers. Plug the linecord into an AC socket properly configured for your particular model.

The FUSSION 1800SA is shipped with a connector that mates with the AC receptacle on the rear panel. Use heavy gauge wire for the linecord to avoid power losses across the wire. (See page 8 for more info.)

The bar **1A** on the rear panel is there to secure the linecord and prevent it from accidentally getting pulled loose from the AC receptacle. Wrap the linecord through the bar and tie it in a knot to secure it.

Note: You can change the AC voltage configuration from 115V to 230V (or vice versa) internally by reconfiguring the transformer primary wiring on the power supply board. Contact Mackie Technical Support for instructions (1-800-258-6883).

2 FUSE

Always replace the fuse with the type indicated on the rear panel. Never replace the fuse with one of a higher value than indicated on the rear panel.



WARNING: Make sure you use the correct fuse relative to the AC operating voltage.

115VAC = 16A Slow-Blow
230VAC = 10A Slow-Blow

3 POWER Switch

Switch up to turn the FUSSION 1800SA on, and switch down to turn it off. Make sure the signal source's level control is turned down before you turn it on.

4 POWER Indicator

When the POWER switch is turned on, and the linecord is connected to an active AC Mains supply, this indicator lights green to let you know that you're ready to rock and roll.

5 MAIN INPUT

This is a female XLR-type connector that accepts a balanced line-level SUB OUT signal from a Fussion Series full-range active speaker system.

6 LOOP OUT

This is a male XLR-type connector that produces exactly the same signal that is connected to the MAIN INPUT jack. Use it to daisy-chain several FUSSION 1800SAs together off the same signal source.

8 POWER OUT

This is a female Neutrik™ Speakon connector that produces a speaker-level signal between the frequencies of 35Hz to 85Hz. Connect this to the FUSSION 1800S passive subwoofer. The signal at this connector comes from a 2000W amplifier identical to the one powering the FUSSION 1800SA.

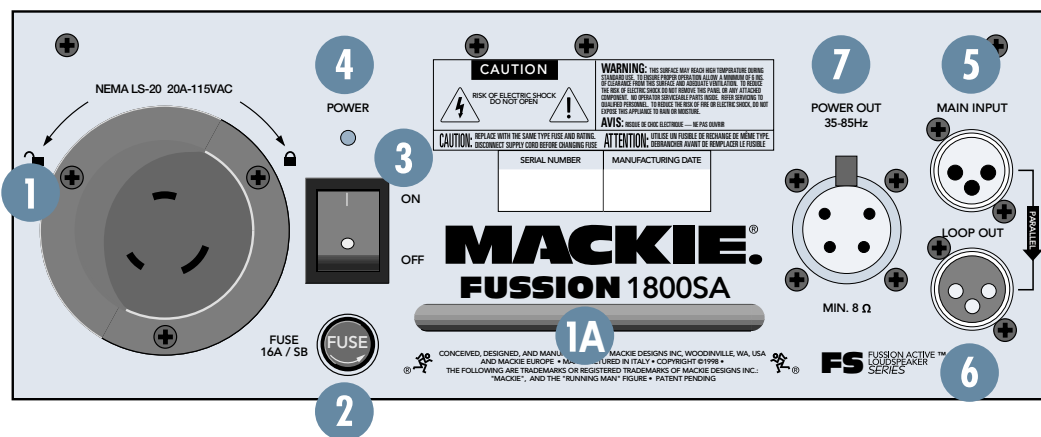

115VAC Version

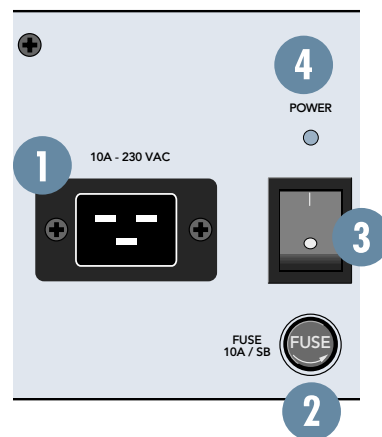

230VAC Version

CONNECTIONS

The FUSSION 1800SA has a female XLR input that accepts a balanced line-level signal. When connecting a balanced signal, be sure it's wired per AES (Audio Engineering Society) standards:

	XLR
Hot (+)	Pin 2
Cold (-)	Pin 3
Shield (Ground)	Pin 1

There is also a male XLR connector labeled LOOP OUT. This is also wired according to the above AES standard.

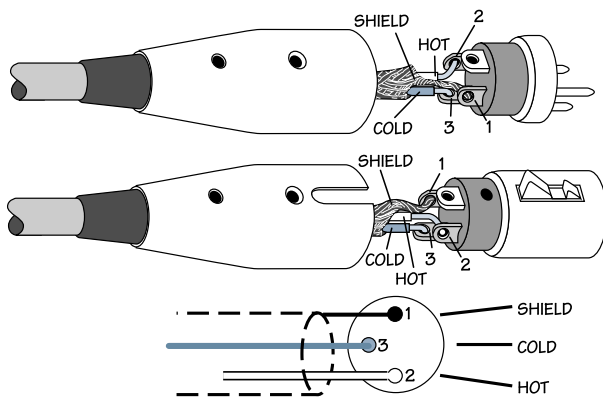

Balanced XLR Connectors

The LOOP OUT connector allows you to connect more than one FUSSION 1800SA to the SUB OUT connector from your FUSSION full-range active speaker system. Simply plug the SUB OUT into the first MAIN INPUT jack, and patch that speaker's LOOP OUT jack to the next MAIN INPUT jack, and so on, daisy-chaining multiple speakers.

The LOOP OUT jack is wired straight from the MAIN IN connector — there is no electronic circuitry between — so the signal coming out of the LOOP OUT jack is exactly the same as the signal going in.

The POWER OUT connector delivers a speaker-level signal to the FUSSION 1800S cabinet. Use 4-pin Neutrik™ Speakon connectors on heavy-gauge speaker wire. The connector is wired as follows:

	Neutrik
Hot (+)	Pins 3 and 4
Cold (-)	Pins 1 and 2

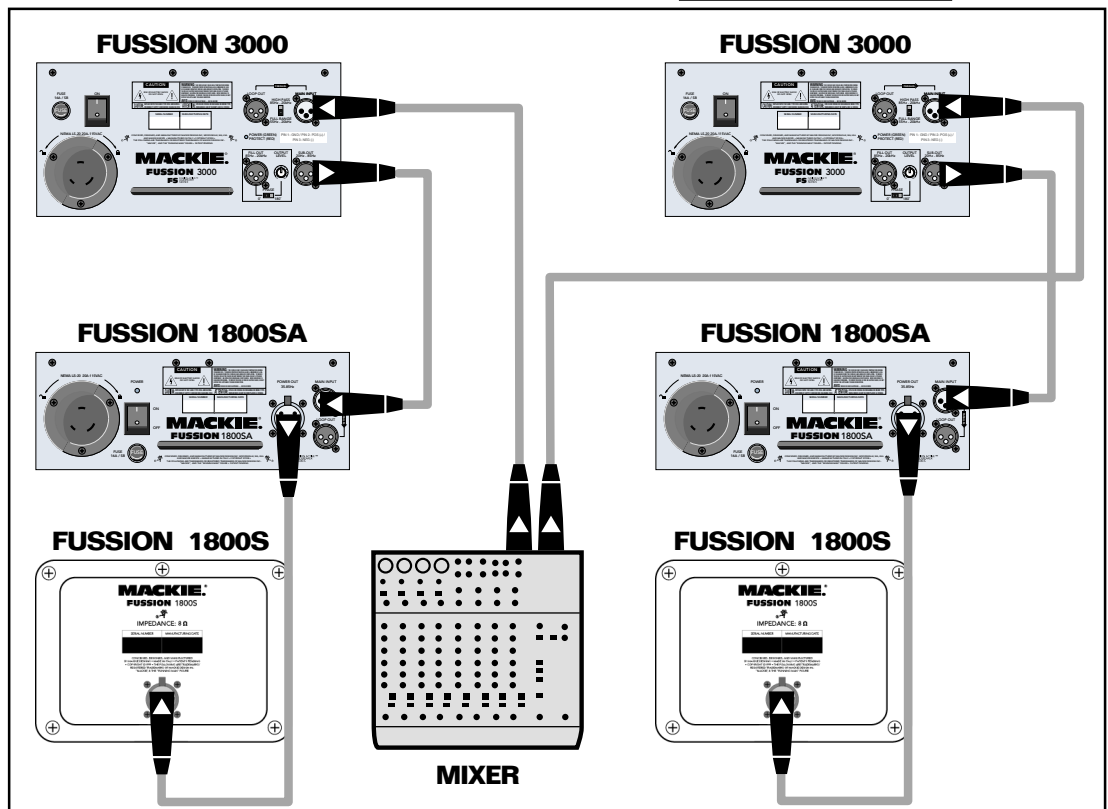
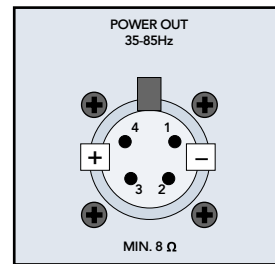

PLACEMENT

The FUSSION 1800SA and 1800S subwoofers are designed to sit on the floor or sturdy stands.

You can stack cabinets vertically. If you do, place the FUSSION 1800SA and 1800S on the bottom of the stack, side by side, and place the full-range active Fussion Series cabinets on top. If you stack two full-range cabinets, turn the upper cabinet upside down so the high-frequency driver is closest to the high-frequency driver in the lower cabinet.



As with any powered components, protect them from moisture. If you are setting them up outdoors, make sure they are under cover if you expect rain.

Room Acoustics

The Fussion Series loudspeakers are designed to sound as neutral as possible; that is, to reproduce the input signal as accurately as possible.

Room acoustics play a crucial role in the overall performance of a sound system. However, the wide high-frequency dispersion of the Fussion Series helps to minimize the problems that typically arise.

Here are some other placement tips:

- Avoid placing loudspeakers in the corners of a room. This increases the low-frequency output and can cause the sound to be muddy and indistinct.
 - Avoid placing loudspeakers against a wall. This, too, increases the low frequency output, though not as much as corner placement. However, if you do need to reinforce the low frequencies, this is a good way to do it.
 - Avoid placing the active loudspeakers directly on a hollow stage floor. A hollow stage can resonate at certain frequencies, causing peaks and dips in the frequency response of the room.
- Position the loudspeakers so the high-frequency drivers are 2 to 4 feet above ear level for the audience (make allowances for a standing/dancing in the aisles audience). High frequencies are highly directional and tend to be absorbed much easier than lower frequencies. By providing direct line-of-sight from the loudspeakers to the audience, you increase the overall brightness and intelligibility of the sound system.
 - Highly reverberant rooms, like many gymnasiums and auditoriums, are a nightmare for sound system intelligibility. Multiple reflections off the hard walls, ceiling, and floor play havoc with the sound. Depending on the situation, you may be able to take some steps to minimize the reflections, such as putting carpeting on the floors, closing draperies to cover large glass windows, or hanging tapestries or other materials on the walls to absorb some of the sound. However, in most cases, these remedies are not possible or practical. So what do you do? Making the sound system louder generally doesn't work because the reflections become louder, too. The best approach is to provide as much direct sound coverage to the audience as possible. The farther away you are from the speaker, the more prominent will be the reflected sound. Use more speakers strategically placed so they are closer to the back of the audience. If the distance between the front and back speakers is more than about 100 feet, you should use a delay processor to time-align the sound. (Since sound travels about 1 foot per millisecond, it takes about 1/10 of a second to travel 100 feet.)

RIGGING

The FUSSION 1800SA and 1800S cabinets are not designed for rigging or flying. The cabinets are for floor-mounting only.

WARNING: Never attempt to suspend the FUSSION 1800SA or 1800S loudspeakers by their handles.

AC POWER

The FUSSION 1800SA is shipped with a connector that mates with the AC receptacle on the rear panel. Use heavy gauge wire for the linecord to avoid power losses across the wire.

The following guide should be followed when wiring a linecord:

	North America 115VAC	International 230VAC
Hot	Black	Blue
Neutral	White	Brown
Earth (Ground)	Green w/ yellow stripe	Green

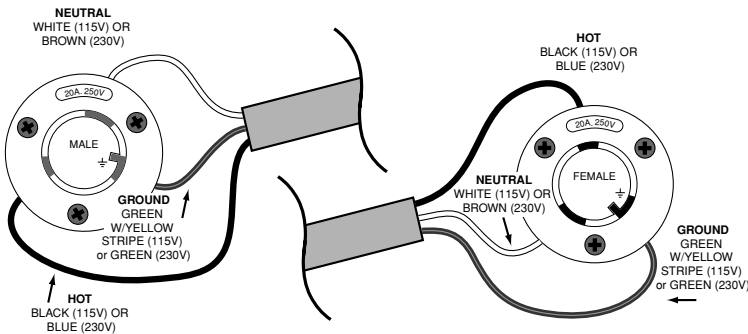

AC Power Connectors

Be sure the FUSSION 1800SA is plugged into an outlet that is able to supply the correct voltage specified for your model. If the voltage should drop below 97% of the

specified line voltage, the built-in amplifiers will no longer be able to supply rated power. (They will continue to operate down to 80% of the rated line voltage, but won't reach full power, resulting in lower headroom.)

Under maximum SPL conditions, where musical peaks are just clipping, the FUSSION 1800SA has the following current requirements:

	115V	230V
Max. Continuous RMS	10A	6A
Max. Peak	12A	8A

Be sure the electrical service can supply enough amperage for all the components connected to it.

We recommend that a stiff (robust) supply of AC power be used because the amplifiers place high current demands on the AC line. The more power that is available on the line, the louder the speakers will play and the more peak output power will be available for cleaner, punchier bass. A suspected problem of "poor bass performance" is often caused by a weak AC supply to the amplifiers.



Never remove the ground pin on the power cord of the FUSSION 1800SA or any other component. This is very dangerous.

SERVICE INFORMATION

Warranty Service

If you think your subwoofer has a problem, please do everything you can to confirm it before calling for service, including reading through the following Troubleshooting section. Doing so might save you from being deprived of your Mackie loudspeaker.

Of all Mackie products returned for service (which is hardly any at all), many are coded “CND” — Could Not Duplicate— which usually means the problem lay somewhere else in the system. The following troubleshooting tips may sound obvious, but here are some things you can check:

Troubleshooting

No power

- Our favorite question: Is it plugged in? Make sure the AC outlet is live (check with a tester or lamp).
- Our next favorite question: Is the POWER switch on? If not, try turning it on.
- Is the POWER LED on the rear panel glowing green? If not, make sure the AC outlet is live. If so, refer to “No sound” below.
- Check the AC line fuse to see if it is blown. If so, make sure you replace it with the same fuse rating as indicated on the rear panel next to the fuseholder.

No sound

- Is the input LEVEL control for the input source turned all the way down? Verify that all the volume controls in the system are properly adjusted.
- Is the signal source working (and making union scale)? Make sure the connecting cables are in good repair and securely connected at both ends. Make sure the output volume (gain) control on the mixing console is turned up sufficiently to drive the inputs of the speaker.
- Make sure the mixer does not have a Mute on or a Processor loop engaged. If you find something like this, make sure the volume/gain is turned down before disengaging the offending switch.

- Is the POWER/PROTECT LED lit red on the Fussion Series Active Speaker? Make sure there is at least six inches of free space behind the heatsinks.

Poor bass performance

- Check the polarity of the connections between the mixer and the loudspeakers. You may have your positive and negative connections reversed at one end of one cable, causing one loudspeaker to be out-of-phase.

Poor sound

- Is it loud and distorted? Make sure that you’re not overdriving a stage in the signal chain. Verify that all level controls are set properly.
- Is the input connector plugged completely into the jack? Be sure all connections are secure. It’s a good idea to periodically clean all electrical connections with a non-lubricating electrical contact cleaner.

Noise

- Make sure all connections to the active loudspeakers are good and sound.
- Make sure none of the signal cables are routed near AC cables, power transformers, or other EMI-inducing devices.
- Is there a light dimmer or other SCR-based device on the same AC circuit as the FUSSION 1800SA? Use an AC line filter or plug the FUSSION 1800Sa into a different AC circuit.

Hum

- Try disconnecting the cable connected to the MAIN INPUT jack. If the noise disappears, it could be a “ground loop,” rather than a problem with the FUSSION 1800SA. Try some of the following troubleshooting ideas:
- Use balanced connections throughout your system for the best noise rejection.
- Whenever possible, plug all the audio equipment’s linecords into outlets which share a common ground. The distance between the outlets and the common ground should be as short as possible.

REPAIR

Service for the FUSSION 1800SA and 1800S is available only from one of our authorized domestic service stations or at the factory service center, located in Whitinsville, Massachusetts. Service outside the United States can be obtained through local dealers or distributors.

If your FUSSION 1800SA or 1800S needs service, please follow these instructions:

1. Review the preceding troubleshooting suggestions. Please.
2. Call Tech Support at 1-800-258-6883, 7am to 5pm PST, to explain the problem in detail. They will ask you all sorts of impertinent questions in the hope of sorting out the problem. If it appears that the FUSSION 1800 needs repair, request an RA (Return Authorization) number. Have your subwoofer's serial number ready. You must have an RA number before you can obtain service at the factory or an authorized service center.
3. Keep this user's manual. We don't need it to repair the subwoofer.
4. Pack the subwoofer in its original packaging, including protective wrap, endcaps, box, and pallet. This is very important. When you call for the RA number, please let Tech Support know if you need new packaging. *Mackie is not responsible for any damage that occurs due to non-factory packaging.*
5. Include a legible note stating your name, shipping address (no P.O. boxes), daytime phone number, RA number, and a detailed description of the problem, including how we can duplicate it.
6. Write the RA number in **BIG PRINT** on top of the box.
7. Ship the subwoofer to us via ground freight. We suggest insurance for all forms of cartage. Ship to this address:

Mackie Designs
SERVICE DEPARTMENT
One Main Street
Whitinsville, MA 01588

8. We'll try to fix the subwoofer within three business days. Ask Tech Support for the latest turnaround times when you call for your RA number.

CARE AND MAINTENANCE

Your Mackie subwoofers will provide many years of reliable service if you follow these guidelines:

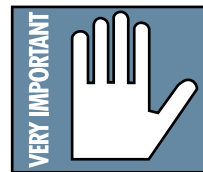

Avoid exposing the subwoofers to moisture. If they are set up outdoors, be sure they are under cover if you expect rain.

- Avoid exposure to extreme cold (below freezing temperatures). If you must operate the subwoofers in a cold environment, warm up the voice coils slowly by sending a low-level signal through them for about 15 minutes prior to high-power operation.
- Use a slightly damp cloth with a mild soap solution to clean the cabinets. Only do this when the power is turned off. Avoid getting moisture into any of the openings of the cabinet, particularly where the drivers are located.

FUSSION 1800SA/1800S SPECIFICATIONS

System Specifications

<i>Frequency Range (-10 dB):</i>	38Hz-160Hz
<i>Frequency Response (-3 dB):</i>	40Hz-150Hz
<i>Maximum SPL (long term):</i>	136 dB @ 1m (system)
<i>Maximum SPL (peak):</i>	139 dB @ 1m (system)
<i>Recommended Crossover Point:</i>	85Hz

Transducers

Low-Frequency Transducers—Two Each

<i>Cone Diameter:</i>	18" (457mm)
<i>Voice Coil Diameter:</i>	4.0" (100mm)
<i>Nominal Impedance:</i>	8 ohms
<i>Power Handling:</i>	800W rms (long term) ¹

Power Amplifiers

Low-Frequency Power Amplifier—Two Each

<i>Rated Power:</i>	2000W continuous @ 4Ω
	2500W peak @ 4Ω
<i>Rated THD:</i>	< 0.03 %

Audio Input/Output

<i>Input Impedance:</i>	20k ohms (F1800SA)
	4 ohms (F1800S)
<i>Input Type:</i>	Balanced differential
<i>Speaker Level Output (1800SA):</i>	EP4 female
<i>Speaker Level Input (1800S):</i>	EP4 male

Line Input Power

<i>US:</i>	115V, 60Hz
<i>Recommended Amperage Service:</i>	12A recommended
<i>AC Connector:</i>	3-pin Twistlock
	250VAC, 20A male
<i>Europe:</i>	230V, 50Hz
<i>Recommended Amperage Service:</i>	8A recommended
<i>AC Connector:</i>	3-pin IEC
	250VAC, 16A male
<i>In-rush Current Protection:</i>	Transistor-based

Safety Features

(Provided by FUSSION full-range or mid-high speaker systems only; no onboard controls in 1800SA)

<i>RMS Limiting:</i>	Monitoring and limiting of continuous RMS output of amplifiers
<i>Thermal Protection:</i>	Input stage shutdown, auto-reset

Physical Properties

<i>Enclosure:</i>	18mm multi-layered birch wood
<i>Enclosure Geometry:</i>	Rectangular
<i>Handles:</i>	4 each aluminum/rubber grips
<i>Mounting Methods:</i>	Floor mount only
<i>Height:</i>	32.9" (836mm)
<i>Width:</i>	23.6" (600mm)
<i>Depth:</i>	23.6" (600mm)
<i>Weight:</i>	
1800SA	145 lbs. (65.8kg)
1800S	106 lbs. (48.1kg)

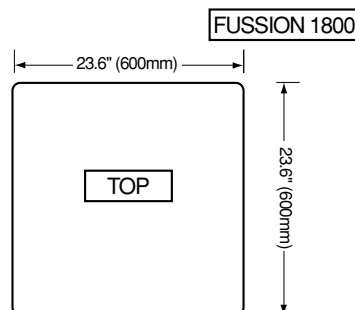
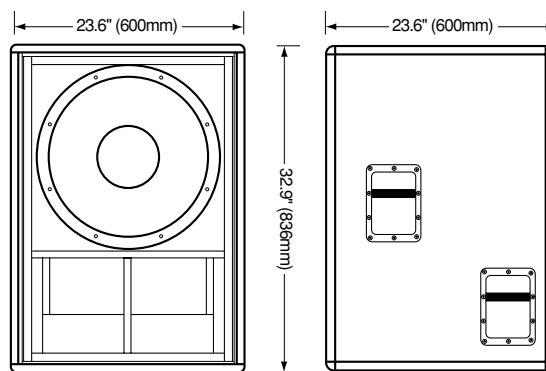

Disclaimer

Since we are always striving to make our products better by incorporating new and improved materials, components, and manufacturing methods, we reserve the right to change these specifications at any time without notice.

“Mackie,” the “Running Man” figure, and “FUSSION” are trademarks or registered trademarks of Mackie Designs Inc.

All other brand names mentioned are trademarks or registered trademarks of their respective holders, and are hereby acknowledged.

©2000 Mackie Designs Inc.
All Rights Reserved.
Printed in Italy.



¹ Power handling for transducers is based on an AES long term power testing standard conducted for 100 hours full power, free air.

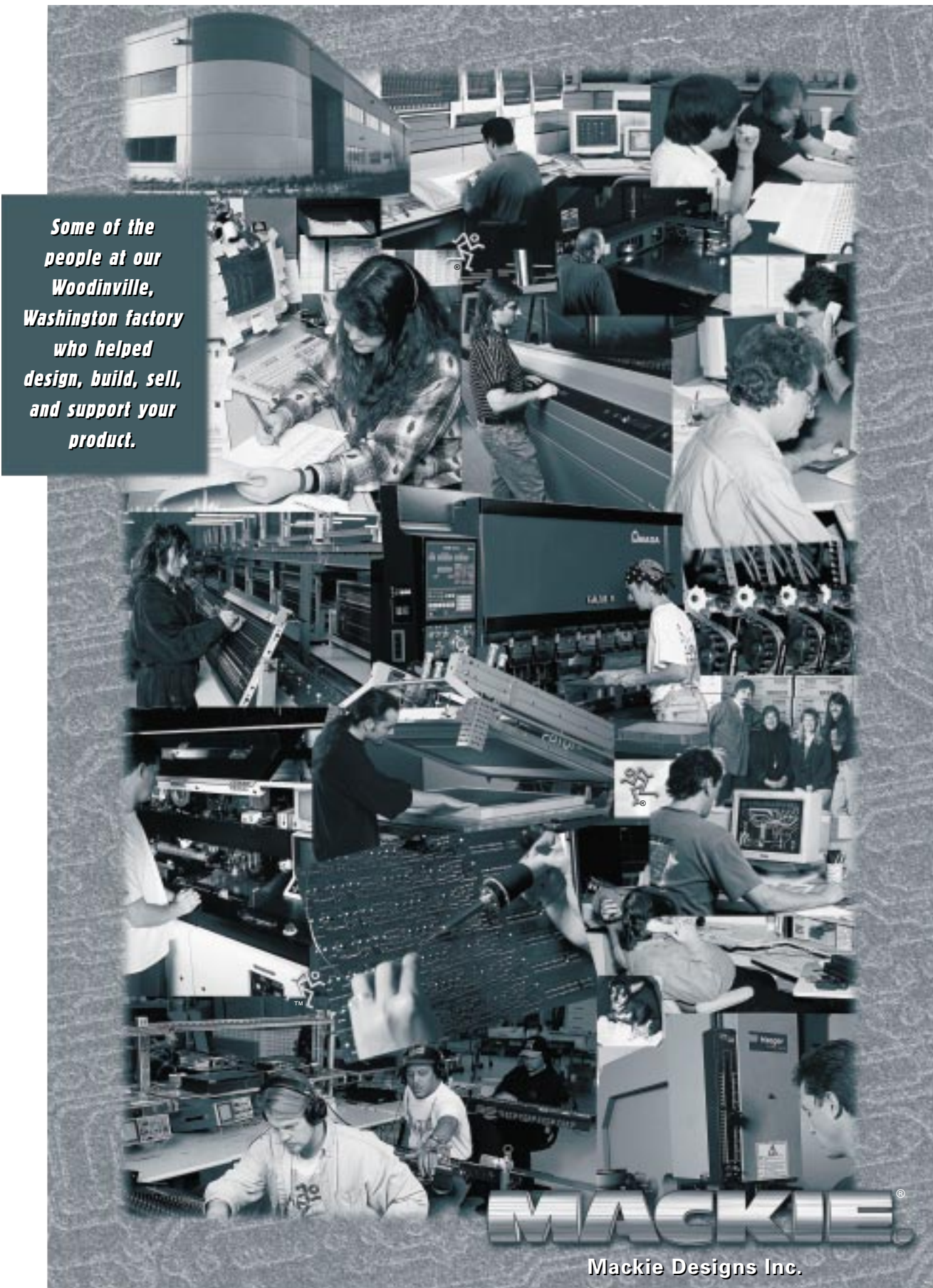

*Some of the
people at our
Woodinville,
Washington factory
who helped
design, build, sell,
and support your
product.*

MACKIE®

Mackie Designs Inc.

16220 Wood-Red Rd. NE • Woodinville, WA 98072 • USA
800/898-3211 • Outside the US: 425/487-4333
Fax: 425/487-4337 • www.mackie.com
E-mail: sales@mackie.com