

MACKIE®

PPM SERIES OWNER'S MANUAL

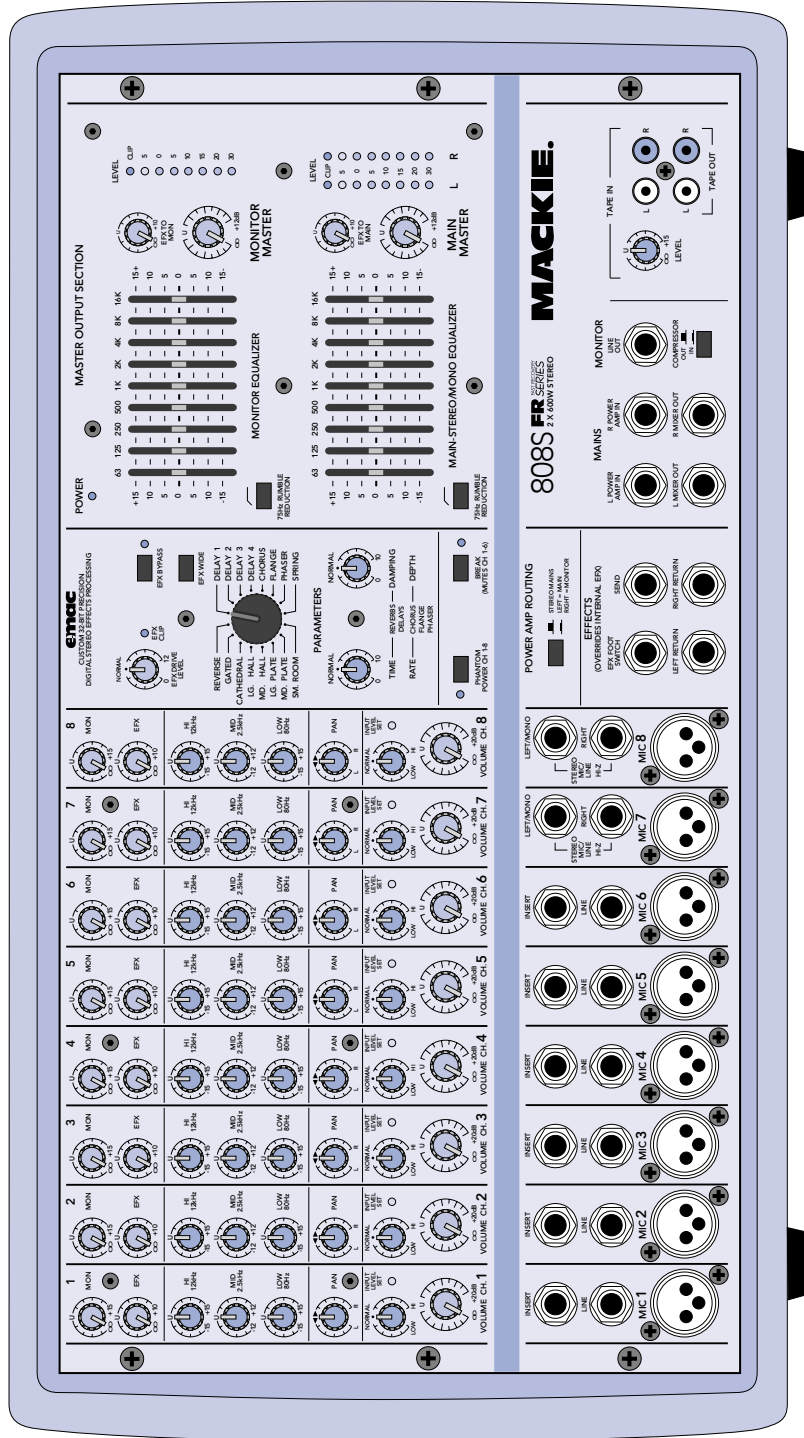

CAUTION AVIS

**RISK OF ELECTRIC SHOCK
DO NOT OPEN**

**RISQUE DE CHOC ELECTRIQUE
NE PAS OUVRIR**

**CAUTION: TO REDUCE THE RISK OF ELECTRIC SHOCK
DO NOT REMOVE COVER (OR BACK)
NO USER-SERVICEABLE PARTS INSIDE
REFER SERVICING TO QUALIFIED PERSONNEL**

**ATTENTION: POUR EVITER LES RISQUES DE CHOC
ELECTRIQUE, NE PAS ENLEVER LE COUVERCLE. AUCUN
ENTRETIEN DE PIECES INTERIEURES PAR L'USAGER. CONFIER
L'ENTRETIEN AU PERSONNEL QUALIFIE.**

**AVIS: POUR EVITER LES RISQUES D'INCENDIE OU
D'ELECTROCUTION, N'EXPOSEZ PAS CET ARTICLE
A LA PLUIE OU A L'HUMIDITE**



The lightning flash with arrowhead symbol within an equilateral triangle is intended to alert the user to the presence of uninsulated "dangerous voltage" within the product's enclosure, that may be of sufficient magnitude to constitute a risk of electric shock to persons.

Le symbole éclair avec point de flèche à l'intérieur d'un triangle équilatéral est utilisé pour alerter l'utilisateur de la présence à l'intérieur du coffret de "voltage dangereux" non isolé d'ampleur suffisante pour constituer un risque d'électrocution.



The exclamation point within an equilateral triangle is intended to alert the user of the presence of important operating and maintenance (servicing) instructions in the literature accompanying the appliance.

Le point d'exclamation à l'intérieur d'un triangle équilatéral est employé pour alerter les utilisateurs de la présence d'instructions importantes pour le fonctionnement et l'entretien (service) dans le livret d'instruction accompagnant l'appareil.

SAFETY INSTRUCTIONS

- 1. Read Instructions** — All the safety and operation instructions should be read before this Mackie product is operated.
- 2. Retain Instructions** — The safety and operating instructions should be kept for future reference.
- 3. Heed Warnings** — All warnings on this Mackie product and in these operating instructions should be followed.
- 4. Follow Instructions** — All operating and other instructions should be followed.
- 5. Water and Moisture** — This Mackie product should not be used near water — for example, near a bathtub, washbowl, kitchen sink, laundry tub, in a wet basement, near a swimming pool, swamp or salivating St. Bernard dog, etc.
- 6. Cleaning** — Clean only with a dry cloth.
- 7. Ventilation** — This Mackie product should be situated so that its location or position does not interfere with its proper ventilation. For example, the Component should not be situated on a bed, sofa, rug, or similar surface that may block any ventilation openings, or placed in a built-in installation such as a bookcase or cabinet that may impede the flow of air through ventilation openings.
- 8. Heat** — This Mackie product should be situated away from heat sources such as radiators, or other devices which produce heat.
- 9. Power Sources** — This Mackie product should be connected to a power supply only of the type described in these operation instructions or as marked on this Mackie product.
- 10. Power Cord Protection** — Power supply cords should be routed so that they are not likely to be walked upon or pinched by items placed upon or against them, paying particular attention to cords at plugs, convenience receptacles, and the point where they exit this Mackie product.
- 11. Object and Liquid Entry** — Care should be taken so that objects do not fall on, and liquids are not spilled into, this Mackie product.

12. Damage Requiring Service — This Mackie product should be serviced only by qualified service personnel when:

- A.** The power-supply cord or the plug has been damaged; or
- B.** Objects have fallen, or liquid has spilled into this Mackie product; or
- C.** This Mackie product has been exposed to rain; or
- D.** This Mackie product does not appear to operate normally or exhibits a marked change in performance; or
- E.** This Mackie product has been dropped, or its chassis damaged.

13. Servicing — The user should not attempt to service this Mackie product beyond those means described in this operating manual. All other servicing should be referred to the Mackie Service Department.

14. To prevent electric shock, do not use this polarized plug with an extension cord, receptacle or other outlet unless the blades can be fully inserted to prevent blade exposure.

Pour prévenir les chocs électriques ne pas utiliser cette fiche polarisée avec un prolongateur, un prise de courant ou une autre sortie de courant, sauf si les lames peuvent être insérées à fond sans laisser aucune partie à découvert.

15. Grounding or Polarization — Precautions should be taken so that the grounding or polarization means of this Mackie product is not defeated.

16. Power Precaution — Unplug this Mackie product during lightning storms or when unused for long periods of time. Note that this Mackie product is not completely disconnected from the AC mains service when the power switch is in the OFF position.

17. This apparatus does not exceed the Class A/Class B (whichever is applicable) limits for radio noise emissions from digital apparatus as set out in the radio interference regulations of the Canadian Department of Communications.

ATTENTION — Le présent appareil numérique n'émet pas de bruits radioélectriques dépassant les limites applicables aux appareils numériques de class A/de class B (selon le cas) prescrites dans le règlement sur le brouillage radioélectrique édicté par les ministere des communications du Canada.

18. Exposure to extremely high noise levels may cause permanent hearing loss. Individuals vary considerably in susceptibility to noise-induced hearing loss, but nearly everyone will lose some hearing if exposed to sufficiently intense noise for a period of time. The U.S. Government's Occupational Safety and Health Administration (OSHA) has specified the permissible noise level exposures shown in the following chart.

According to OSHA, any exposure in excess of these permissible limits could result in some hearing loss. To ensure against potentially dangerous exposure to high sound pressure levels, it is recommended that all persons exposed to equipment capable of producing high sound pressure levels use hearing protectors while the equipment is in operation. Ear plugs or protectors in the ear canals or over the ears must be worn when operating the equipment in order to prevent a permanent hearing loss if exposure is in excess of the limits set forth here.

Duration Per Day In Hours	Sound Level dBA, Slow Response	Typical Example
8	90	Duo in small club
6	92	
4	95	Subway Train
3	97	
2	100	Very loud classical music
1.5	102	
1	105	Patrice screaming at Ron about deadlines
0.5	110	
0.25 or less	115	Loudest parts at a rock concert

WARNING — To reduce the risk of fire or electric shock, do not expose this appliance to rain or moisture.



Lend Me Your Ears

Exposure to extremely high noise levels may cause permanent hearing loss. Individuals vary considerably in

susceptibility to noise-induced hearing loss, but nearly everyone will lose some hearing if exposed to sufficiently intense noise for a period of time. The U.S. Government's Occupational Safety and Health Administration (OSHA) has specified the permissible noise level exposures shown in this chart.

According to OSHA, any exposure in excess of these permissible limits could result in some hearing loss. To ensure against potentially dangerous exposure to high sound-pressure levels, it is recommended that all persons exposed to equipment capable of producing these levels use hearing protectors while this unit is in operation. Ear plugs or protectors in the ear canals or over the ears must be worn when operating this amplification system in order to prevent a permanent hearing loss if exposure is in excess of the limits set forth here.

Duration Per Day In Hours	Sound Level dBA, Slow Response	Typical Example
8	90	Duo in small club
6	92	
4	95	Subway Train
3	97	
2	100	Very loud classical music
1.5	102	
1	105	Lori screaming at Ron about deadlines
0.5	110	
0.25 or less	115	Loudest parts at a rock concert



INTRODUCTION

Thank you for choosing a Mackie Designs PPM Series™ Powered Mixer! These powerful, compact mixers are designed to meet the needs of almost any small to medium-sized

club/meeting room/sanctuary/outdoor gathering.

This chart illustrates the differences between the various models at a glance:

PPM Series Features					
	406M	408M	808M	408S	808S
6 Mono Channels	✓	✓	✓	✓	✓
2 Mono/Stereo Channels		✓*	✓*	✓	✓
Pan Controls				✓	✓
Effects Return(s)	1	1	1	2	2
Tape Inputs	✓*	✓*	✓*	✓	✓
Tape Outputs	✓**	✓**	✓**	✓	✓
Mixer Line Output(s)	1	1	1	2	2
Two 250W Amplifiers	✓	✓		✓	
Two 600W Amplifiers			✓		✓
* Summed to Main Bus					
** Mono Tape Outputs					

In addition, the PPM Series boast solid design features such as:

- Two FR Series™ (Fast Recovery) power amplifiers
808M/808S
1200 total watts (600 watts x 2 into 2 ohms)
406M/408M/408S
500 total watts (250 watts x 2 into 2 ohms)
- Built-in compressor to prevent clipping
- Two built-in graphic equalizers for Mains and Monitors
- Two switchable low-cut Rumble Reduction filters for Mains and Monitors
- EMAC™ custom 32-bit precision digital stereo effects processor
- Global phantom power switch
- Exclusive Break switch mutes channels 1-6 while break music is playing
- Power amp routing switch selects main out only or main on one output and monitor on the other output
- 3-band EQ on each channel
- Monitor and Effects send on each channel
- Balanced/unbalanced 1/4" and XLR inputs on each channel
- 1/4" Insert jacks on channels 1-6
- 1/4" Mixer line output(s) and Monitor line output
- 1/4" Power Amp line inputs
- Two 1/4" Speaker outputs per side
- RCA stereo Tape In and Tape Out
- Three year warranty

At Mackie, we know what it takes to be roadworthy. After all, our mixers have traveled all over the world under the worst of conditions, and we've applied what we've learned to the mechanical design of our powered mixers.

Reliability is paramount to sound reinforcement. That's why our engineers have subjected our powered mixers to the most rigorous and fiendish tests imaginable to fine-tune the design and extend its limits beyond those of ordinary mixers or amplifiers.

Our Fast Recovery (FR) amplifiers used in the Professional Powered Mixer Series perform better than conventional designs when presented with adverse conditions such as clipping. Conventional designs use lots of negative feedback to provide stability and lower distortion. When clipping occurs, this "feedback" causes high-frequency sticking, keeping the amplifier "latched" in the clipping state longer than necessary. This results in painfully audible distortion. The Fast Recovery design eliminates this high-frequency sticking and allows the amplifier to remain stable when powering highly reactive loads at high volume levels.

Please read the "Quick Start" section on page 6. It gives an overview of the powered mixer, and the rest of the manual explains the wealth of features and operating instructions in more detail.

Please write your serial number here for future reference (i.e., insurance claims, tech support, return authorization, etc.):

Purchased at:

Date of purchase:

CONTENTS

Lend Me Your Ears	3	MAKING THE CONNECTIONS	21
INTRODUCTION	4	Front Panel Connections	21
READ THIS PAGE!	6	Connecting Microphones ③③ and	
① QUICK START	6	Line-Level Signals ③④ ③⑤	21
② APPLICATION DIAGRAMS	7	③⑥ Channel Inserts	22
FEATURES AND CONTROLS	14	③⑦ EFFECTS SEND and RETURN	23
Channel Strip Description	14	③⑧ EFX FOOT SWITCH	23
③ INPUT LEVEL SET	14	③⑨ POWER AMP IN 1 and 2	23
④ VOLUME	14	④① MIXER LINE OUT	24
⑤ PAN	14	④② MONITOR LINE OUT	24
⑥ LOW EQ	14	④③ TAPE IN and TAPE OUT	24
⑦ MID EQ	14	Rear Panel Connections	25
⑧ HI EQ	14	④④ SPEAKER OUT	25
⑨ EFX Send	15	④⑤ IEC Socket	25
⑩ MON Send	15	GENERAL PRECAUTIONS AND CONSIDERATIONS .	26
EMAC Section Description	15	Thermal Considerations	26
⑪ EFX DRIVE LEVEL	15	AC Power Considerations	26
⑫ EFX CLIP	15	APPENDIX A: Service Info	27
⑬ EFX BYPASS	15	Warranty Service	27
⑭ EFX WIDE	16	Troubleshooting	27
⑮ Preset Select	16	Repair	28
Preset Effects Descriptions	16	APPENDIX B: Some Arcane Mysteries Illuminated	29
⑯ TIME/RATE PARAMETER	18	Balanced Lines	29
⑰ DAMPING/DEPTH PARAMETER	18	Unbalancing a Line	29
MASTER OUTPUT SECTION Description	18	Grounding	30
⑱ POWER LED	18	APPENDIX C: Technical Info	31
⑲ MONITOR EQUALIZER	18	Specifications	31
⑳ MAIN EQUALIZER	18	Block Diagrams	33
㉑ 75Hz RUMBLE REDUCTION	18	NOTES	35
㉒ EFX TO MON	19		
㉓ MONITOR MASTER	19		
㉔ EFX TO MAIN	19		
㉕ MAIN MASTER	19		
㉖ LEVEL Meters	19		
㉗ PHANTOM POWER Switch	19		
㉘ BREAK Switch	20		
㉙ POWER AMP ROUTING	20		
㉚ COMPRESSOR	20		
㉛ TAPE IN LEVEL	20		
㉜ POWER switch	21		



Don't forget to visit our website at www.mackie.com
for more information about these and other Mackie products.

READ THIS PAGE!

1 QUICK START



We know you can't wait to get your new mixer set up and working. Who has time to read the manual? But please, take a moment to read through this section at least to get the bare essentials.

The Mackie Designs powered mixers are designed to set up and operate quickly and easily. Just follow these simple directions.

Setup

Place the powered mixer in a position where it is easy to reach the controls. All the controls and input connection points are located on the front panel so you can make quick adjustments and connections onstage.



Make sure there is at least 6 inches of airspace behind the powered mixer for ventilation. There is no fan built into the Mackie PPM Series. It relies on convection cooling, which means the heatsink on the back is cooled by the natural flow of air through the heatsink fins.

Connections

1. Be sure the POWER switch on the back is OFF before making any connections.
2. Plug a balanced microphone into one of the MIC XLR (3-pin) connectors on the front panel. Or you can connect any line-level signal (keyboard, guitar preamp, DI box) to the LINE jack using a TS or a TRS 1/4" plug.
3. The INSERT jacks are used to connect an external effects or dynamics processor into the signal chain. See page 21 for more info.
4. Plug the speakers (2 ohms or greater) into the SPEAKER OUT jacks on the rear panel. If you plug two speakers into a side, each speaker must be 4 ohms or greater to maintain a 2-ohm minimum load on the amplifier. Use at least 18 gauge speaker cable with 1/4" TS plugs.



Don't use guitar cords for speaker cables! They're not designed to handle speaker-level signals and could overheat.

Level Setting

1. Turn down the channel MON, EFX, INPUT LEVEL SET, and VOLUME knobs (fully counterclockwise). Set all the EQ controls to center, including the graphic EQ sliders. Turn down the MAIN MASTER and MONITOR MASTER controls.
2. If your microphone is a condenser mic, push in the PHANTOM POWER switch. If you are using both condenser and dynamic mics, don't worry. Phantom power will not hurt most dynamic mics. Check the microphone's user manual if you're not sure.
3. Leave the POWER AMP ROUTING switch in the OUT position (MAIN/MAIN or STEREO MAINS).
4. Push the linecord securely into the IEC connector on the rear panel, and plug it into a 3-prong AC outlet properly configured for the type of plug supplied with your powered mixer. Turn on the POWER switch, which is located on the rear panel.
5. Play something into the selected input. This could be an instrument, a singing or speaking voice, or a line input such as a CD player or tape recorder output. Be sure that the volume of the input signal is the same as it would be during normal use. If it isn't, you might have to readjust these levels during the middle of the set.
6. Turn up the INPUT LEVEL SET control until the LED next to it begins to blink.
7. Turn up the channel VOLUME control to unity (center).
8. Slowly turn up the MAIN MASTER control until you can hear the signal in the speakers.
9. Repeat steps 5, 6, and 7 for the remaining channels.
10. Now you're ready to rock and roll!

Things You Must Remember:

- Never plug amplifier outputs into anything except speakers (unless you have an outboard box specifically designed to handle high-power speaker-level signals).
- Before making connections to an external amp or reconfiguring an amp's routing, turn the amp's level (gain) controls down, turn the power off, make the changes, turn the power back on, and then turn the level controls back up.
- When you shut down your equipment, turn off any external amplifiers first. When powering up, turn on the amplifiers last.
- **Save the shipping box and packing material!** You may need them someday, and you probably don't want to have to pay for them again.

2 APPLICATION DIAGRAMS

FOH Speaker



From MAIN SPEAKER OUT

Monitor Speaker

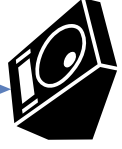

From MONITOR SPEAKER OUT

POWER AMP ROUTING
Button Pushed IN (MAIN/MONITOR)

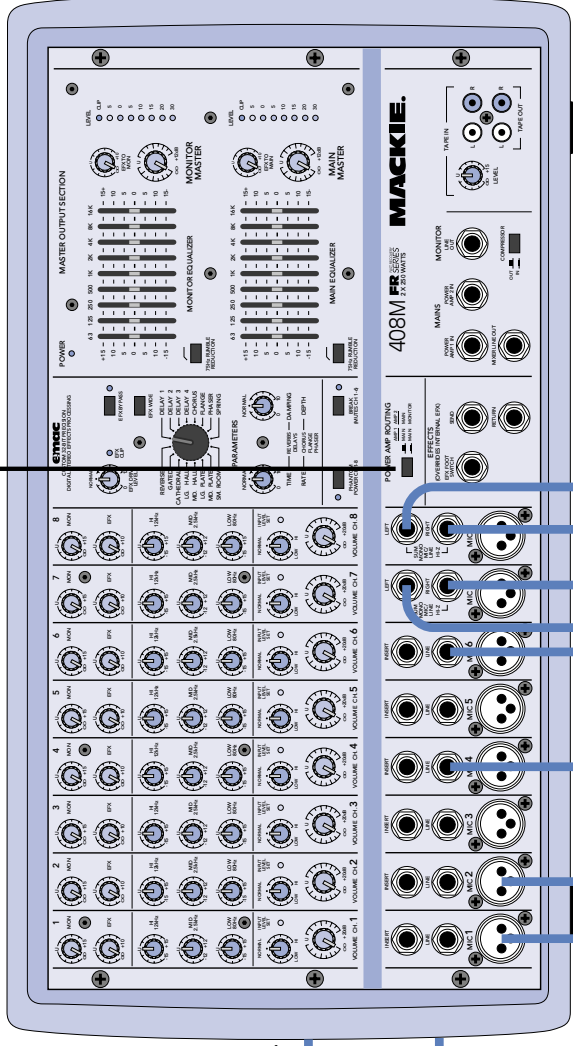

FOH Speaker

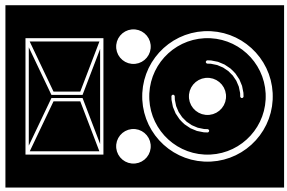

From MAIN SPEAKER OUT

Monitor Speaker



From MONITOR SPEAKER OUT

408M — Small Club Gig using a Mono PA System

This is how to power the Main Front of House (FOH) speakers and the monitor speakers with the built-in amplifiers.
Note: Since each amplifier is driving two speakers in parallel, each speaker must be 4 ohms or greater.

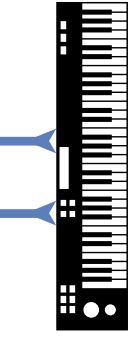

Stereo Processor

Direct Box

Processor

Vocal Mics

408S — Small Club Gig using a Stereo PA System

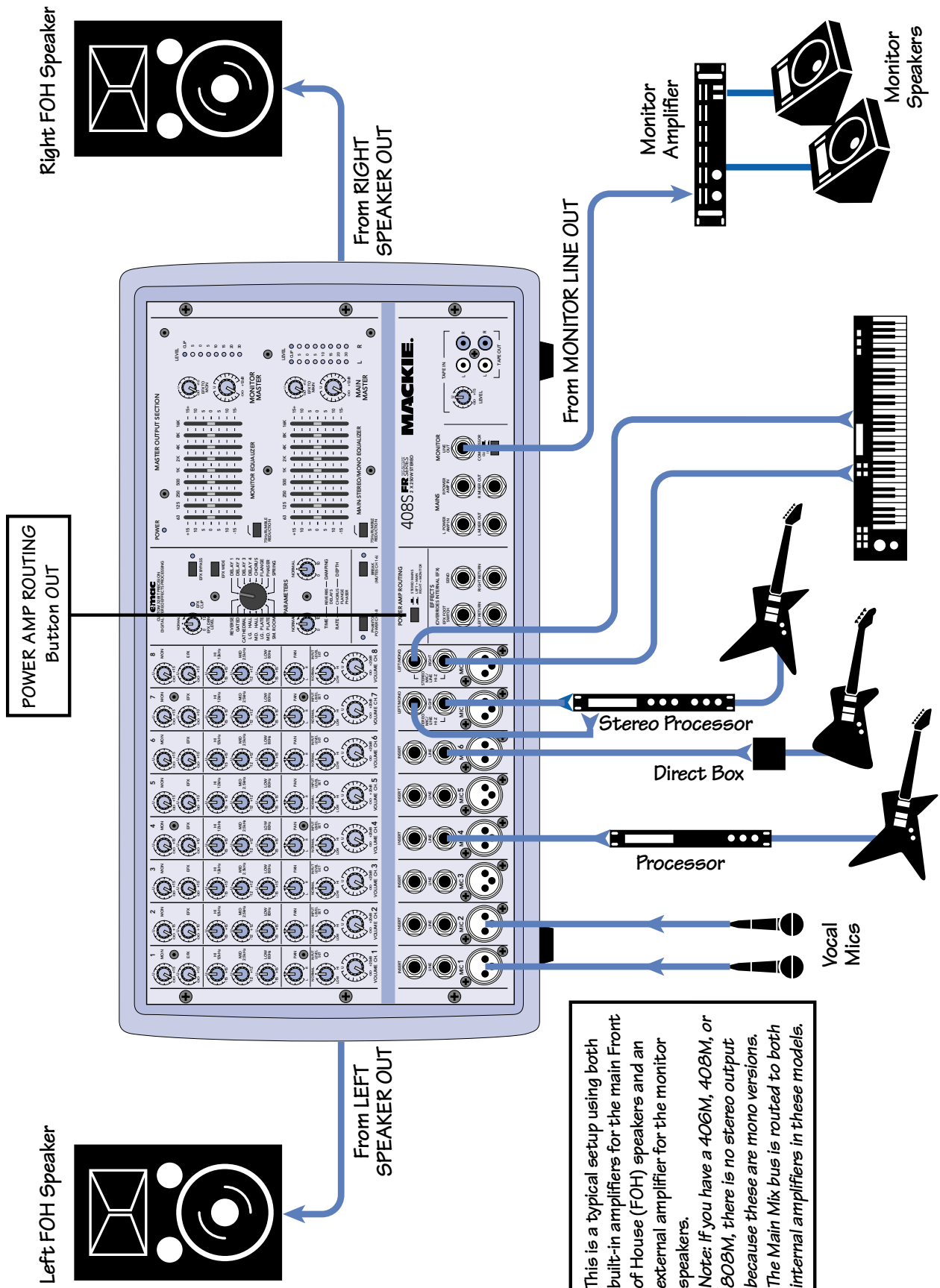

This is a typical setup using both built-in amplifiers for the main Front of House (FOH) speakers and an external amplifier for the monitor speakers.

Note: If you have a 406M, 408M, or 808M, there is no stereo output because these are mono versions. The Main Mix bus is routed to both internal amplifiers in these models.

808M — Large Club or Auditorium using a Mono PA System

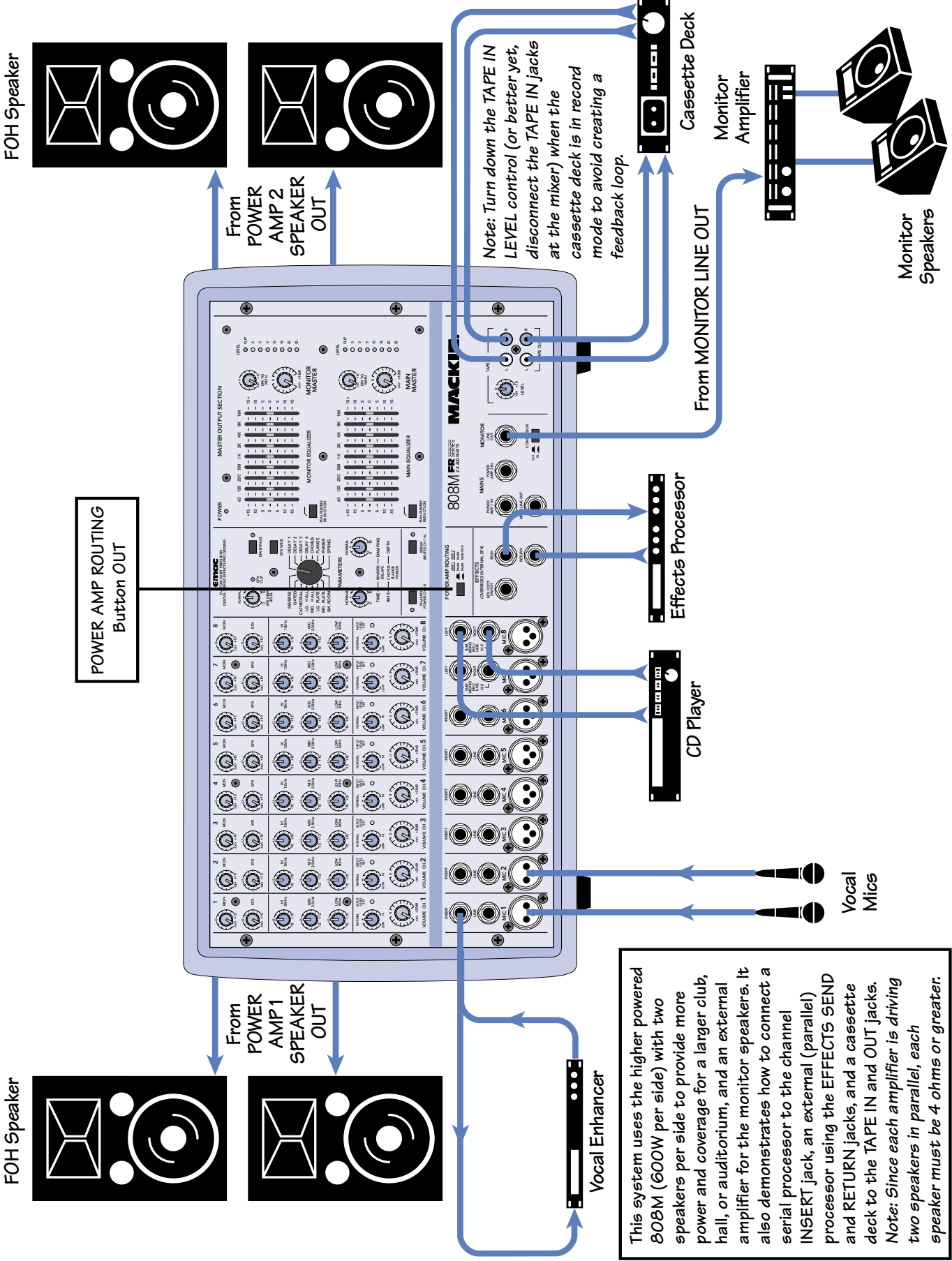

808S with Auxiliary Amplifier to Reinforce Front of House

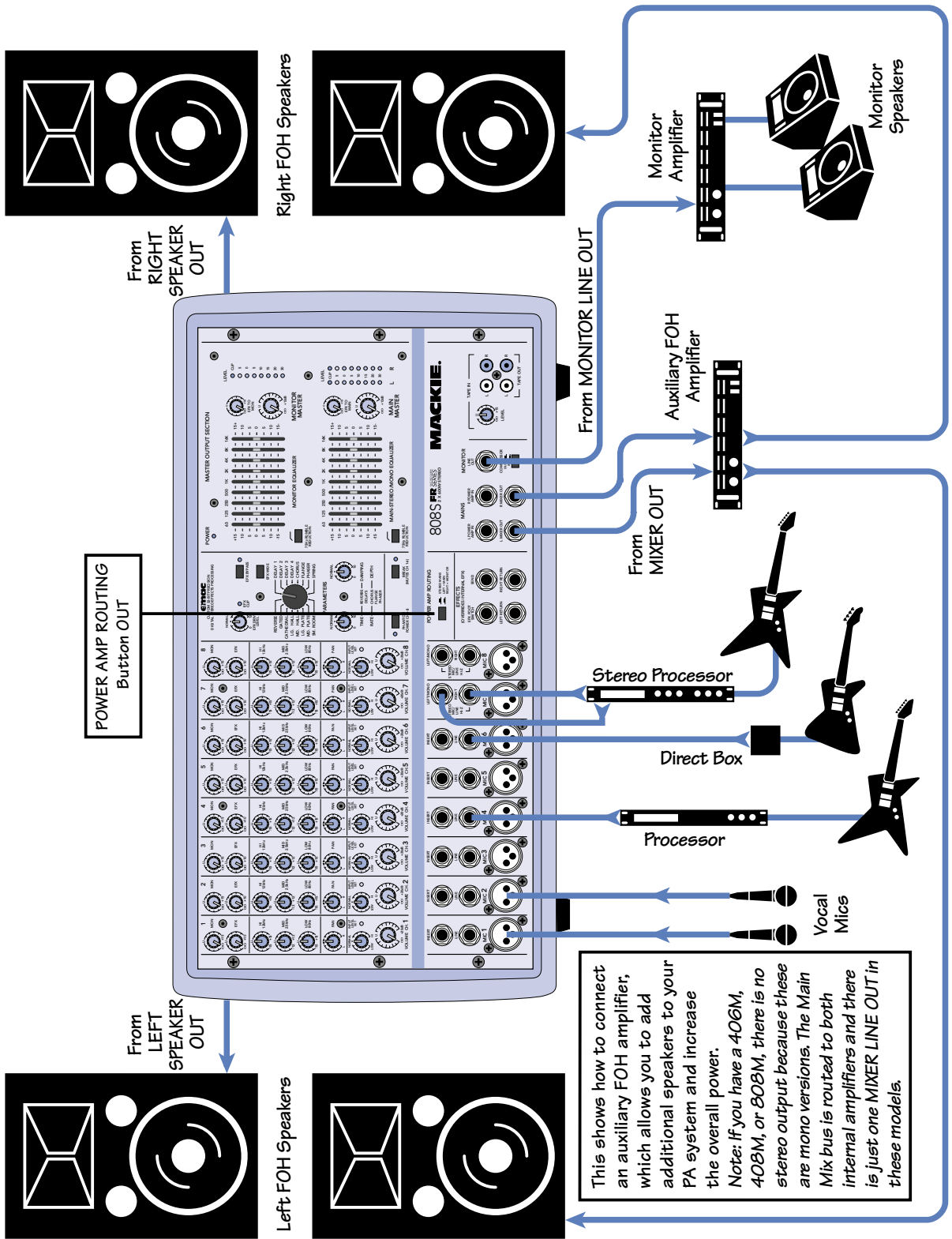

808S with Electronic Crossover and Subwoofers

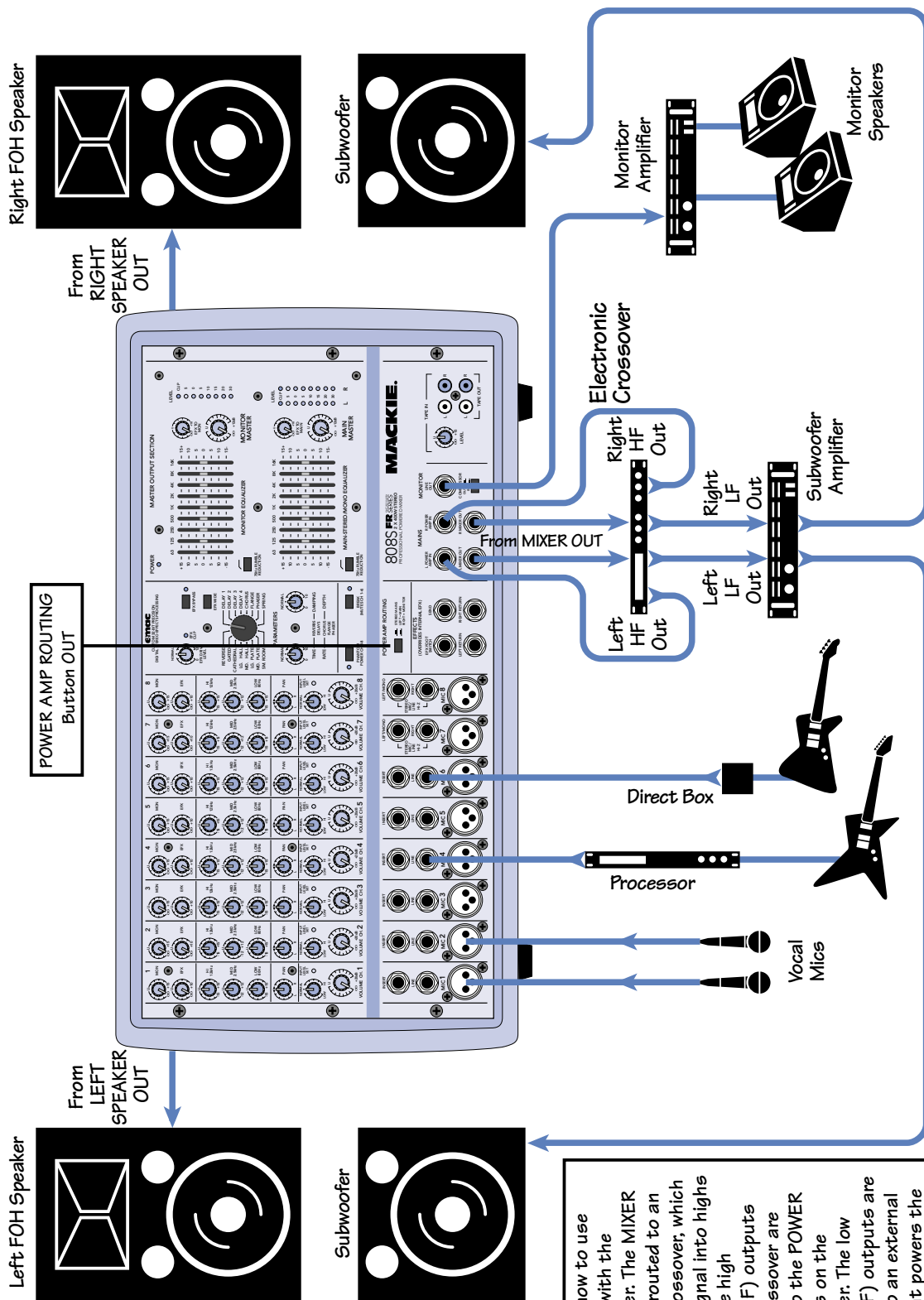

This shows how to use subwoofers with the powered mixer. The MIXER LINE OUT is routed to an electronic crossover, which splits the signal into highs and lows. The high frequency (HF) outputs from the crossover are connected to the POWER AMP IN jacks on the powered mixer. The low frequency (LF) outputs are connected to an external amplifier that powers the subwoofers.

Note: If you have a 406M, 408M, or 808M, there is no stereo output because these are mono versions. The Main Mix bus is routed to both internal amplifiers and there is just one MIXER LINE OUT in these models. Use a Y-cord to connect the HF Out from the crossover to both POWER AMP IN jacks on the powered mixer.

808S with External Mixer using PPM Amplifiers

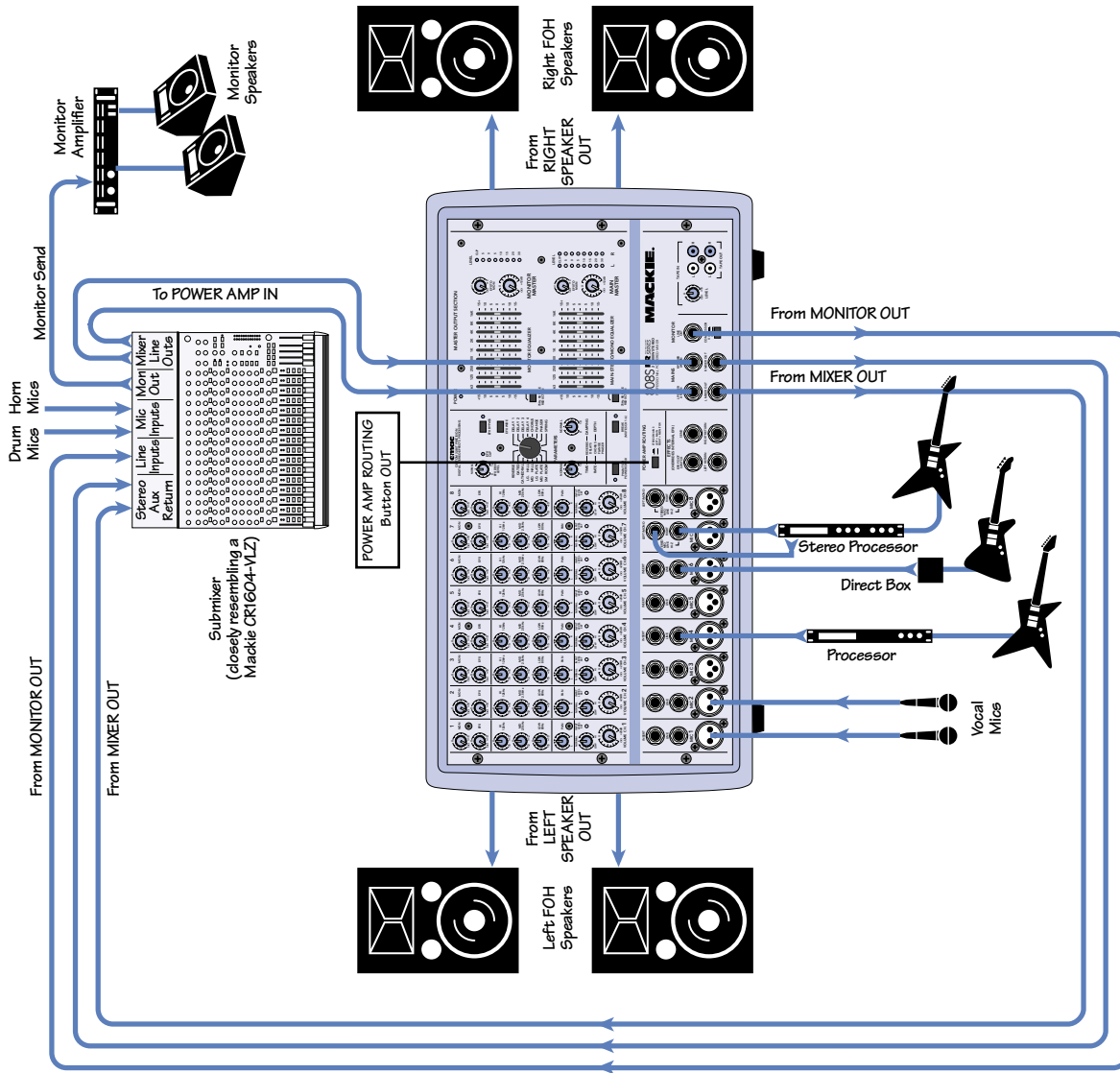

If you need more inputs than those provided by your PPM Series Powered Mixer, this setup shows how to use an external submixer to add additional inputs into the mix. The MIXER LINE OUT(s) from the powered mixer are routed to two mono or a stereo aux return on the submixer, where the signal is mixed with the additional inputs connected to the submixer. The final, overall mix is routed back to the POWER AMP IN jacks on the powered mixer, which powers the main FOH speakers.

Route the MONITOR LINE OUT on the powered mixer to an unused line input on the submixer. Leave that channel's volume control turned down, and set the channel's monitor send control to unity gain.

The monitor out on the submixer is routed to an external power amplifier, which drives the monitor speakers.

Note: Since each amplifier is driving two speakers in parallel, each speaker must be 4 ohms or greater.

External Warm-up Band's Mixer using 808S Amplifiers

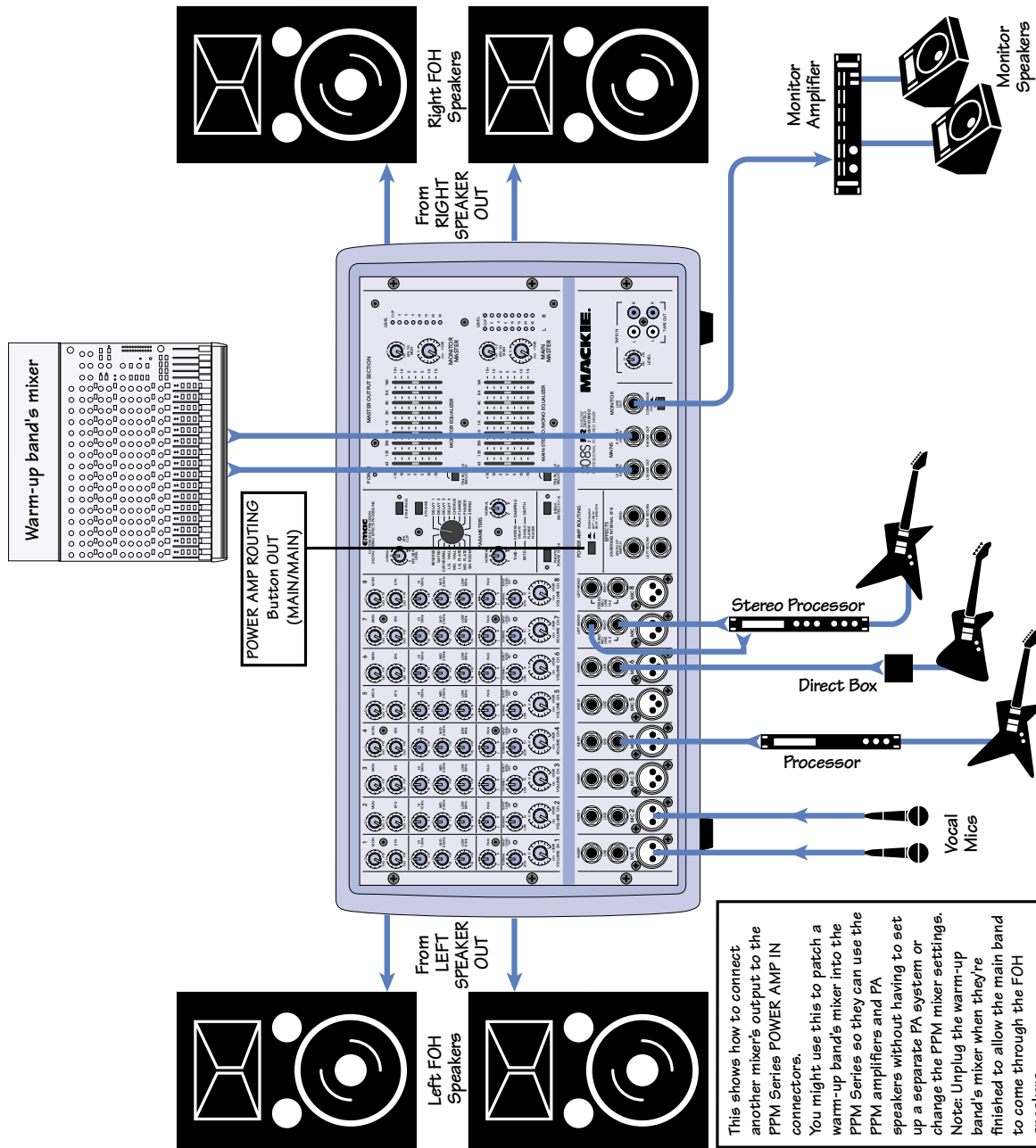

FEATURES AND CONTROLS

Channel Strip Description

3 INPUT LEVEL SET

If you haven't done so already, please read the "Level-Setting" procedure on page 6.

The **INPUT LEVEL SET** control adjusts the input sensitivity of the mic and line inputs (on channels 7 & 8 it affects only the mic input). This allows signals from the outside world to be adjusted to optimal internal operating levels.

To correctly adjust the **INPUT LEVEL SET** control, apply a signal to the channel and turn up the **INPUT LEVEL SET** control until the LED next to it just begins to blink. This provides the best signal-to-noise ratio for the channel.

4 VOLUME

The rotary **VOLUME** knob controls the channel's level... from off to unity gain at the center detent, on up to +20 dB of additional gain when turned all the way up. The **VOLUME** control is equivalent to a channel fader.

These are mono controls except on channels 7 and 8 of the 408S and 808S models, which use stereo controls.



Unity gain means there is no change in signal level. In other words, the signal entering the control is the same volume (or in this case, the same voltage level) as the signal leaving the control. Once you have adjusted the **INPUT LEVEL SET** controls on all the channels, you can set the remaining controls to their unity (U) positions and your signals will travel through the mixer at optimal levels. What's more, all the labels on our level controls are in decibels (dB), so you'll know what you're doing level-wise if you choose to change a control's settings.

5 PAN

This control appears on the stereo models (408S and 808S). **PAN** adjusts the amount of channel signal sent to the left versus the right outputs. On the mono channels 1-6 these controls act as true pan pots. On the stereo channels 7 and 8, the **PAN** knob acts like the balance control on your home stereo.

3-Band EQ

The PPM Series has 3-band equalization at carefully selected points — **LOW** shelving at 80Hz, **MID** peaking at 2.5kHz, and **HI** shelving at 12kHz. "Shelving" means that the circuitry boosts or cuts all frequencies past the specified frequency. For example, rotating the **LOW EQ** knob 15 dB to the right boosts bass starting at 80Hz and continuing down to the lowest note you ever heard. "Peaking" means that only a selected band of frequencies surrounding a center frequency is affected by the EQ control — the frequencies around 2.5kHz in this case.

6 LOW EQ

This control gives you up to 15 dB boost or cut at 80Hz and below. The circuit is flat (no boost or cut) at the center detent position. This frequency represents the punch in bass drums, bass guitar, fat synth patches, and some really serious male singers.

7 MID EQ

Short for "midrange," this knob provides 12 dB of boost or cut, centered at 2.5kHz, also flat at the center detent. Midrange EQ is often thought of as the most dynamic, because the frequencies that define any particular sound are almost always found in this range. You can create many interesting and useful EQ changes by turning this knob down as well as up.

8 HI EQ

This control gives you up to 15 dB of boost or cut at 12kHz and above, and it is also flat at the detent. Use it to add sizzle to cymbals, and an overall sense of transparency or edge to keyboards, vocals, guitar, and bacon frying. Turn it down a little to reduce sibilance, or to hide tape hiss.

Moderation during EQ

With EQ, you can also screw things up royally. We've designed a lot of boost and cut into each equalizer circuit because we know everyone will occasionally need that. But if you max the EQs on every channel, you'll get mix mush. Equalize subtly and use the left sides of the knobs (cut), as well as the right (boost).

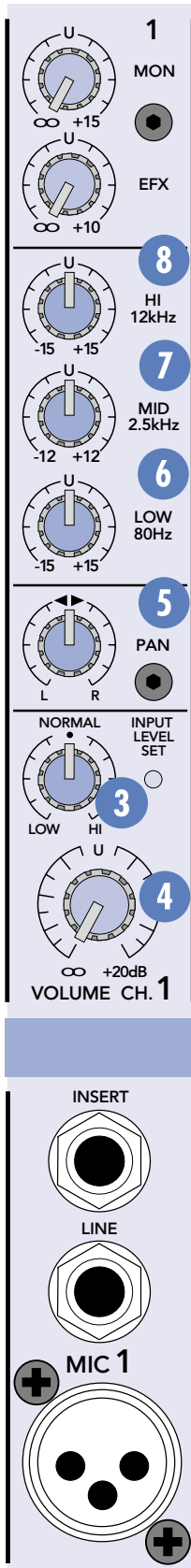

*Stereo Version
Channel Strip*

9 EFX Send

This taps the channel's signal out to either the internal EMAC Digital Stereo Effects Processor or to an external device via the EFFECTS SEND jack for parallel effects processing. Each channel's effects send signal is controlled by the channel's EFX knob, and the overall effects send level is controlled by the EFX DRIVE LEVEL 11 knob (located in the EMAC section).

The effects send signal is post-EQ and post-VOLUME, so these controls affect the signal going to the effects processor, be it internal or external.

Each EFX send control ranges from off through unity (the center detent position) on up to +10 dB of extra gain (when turned fully clockwise). Chances are you'll never need this much extra gain, but it's nice to know it's there if you do.

Normally the effects send signal is routed to the internal EMAC Digital Stereo Effects Processor (more on EMAC coming up). However, if you plug into the EFFECTS SEND 37 jack (located just below the EMAC section) you can send the effects signal to an external effects device. You can return the signal from the external effects device by plugging its output into the EFFECTS RETURN jack(s) just below the SEND jack. *This disconnects the EMAC from the internal effects bus.*

You mix the amount of effects you want returned to the main mix by adjusting the EFX TO MAIN 24 control located just above the MAIN MASTER 25. You can also add effects to the monitor mix by adjusting the EFX TO MON 22 control located just above the MONITOR MASTER 23.

Note: See "Effects Send and Return" on page 22 to see how to use EMAC and an external effects processor at the same time.

10 MON Send

This taps the channel's signal out to an external amplifier, which powers your monitor speakers, via the MONITOR LINE OUT jack. Each channel's monitor send signal is controlled by the channel's MON knob, and the overall monitor send level is controlled by the MONITOR MASTER 23 control.

The monitor send signal is pre-EQ and pre-VOLUME, so if you adjust these controls they will affect only the main mix and not the monitor mix.

Each MON send control ranges from off through unity (the center detent position) on up to +15 dB of extra gain.

EMAC Section Description

EMAC™ stands for Extended Multiply and Accumulate, which is a proprietary 32-bit digital stereo processor developed by our Digital Engineering Group. It provides 16 preset digital effects algorithms for you to select. In addition to the presets, there are two parameter controls 16 / 17 you can adjust to change the sound and make it unique for your particular application.

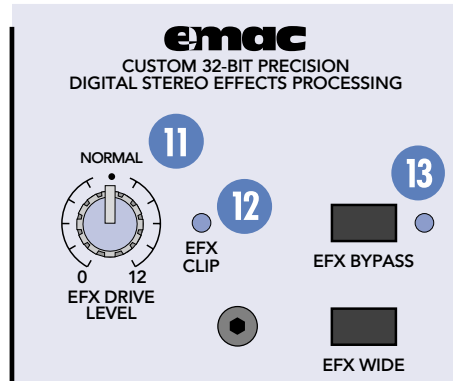

11 EFX DRIVE LEVEL

This controls the signal level being sent to the input of the EMAC module (and to the EFX SEND jack). Use the EFX controls on the individual channels to adjust the amount of each channel's signal you want to go to the EMAC. Leave the EFX DRIVE LEVEL set at the NORMAL position. If you find that you're not getting enough of the effect in the main mix, make sure that the EFX TO MAIN control is turned up at least to unity (the center detent position). It's okay to turn up the EFX DRIVE LEVEL some more if you need to. Just make sure the EFX CLIP LED never lights more than occasionally. Read on to find out why.

12 EFX CLIP

This indicates when the EMAC is 6 dB below clipping. This LED should only light occasionally. If it blinks frequently, you should turn down the EFX DRIVE LEVEL a little. Digital clipping is not pleasant to behold.

13 EFX BYPASS

Pushing in this button causes the EFX BYPASS indicator to light and mutes the effects signal. It affects both the internal EMAC effects and any external effects processor you may have connected to the EFFECTS RETURN jack.

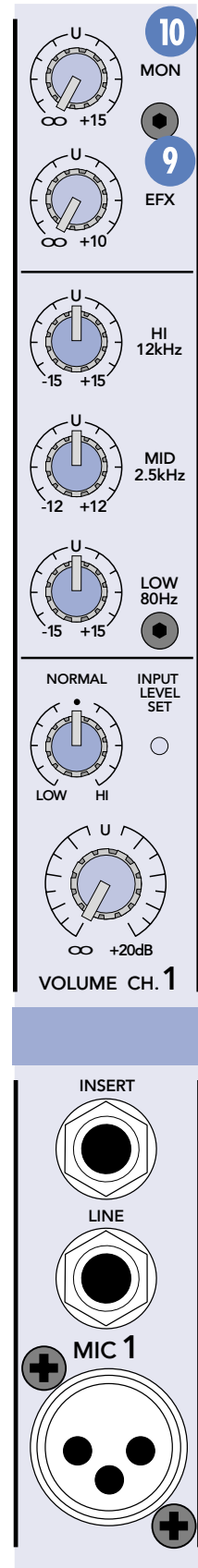

Mono Version
Channel Strip

14 EFX WIDE

Depending on the effect selected, this switch adds more width or depth to the effect. Note that it doesn't work with the DELAY and PHASER effects because they are monophonic.

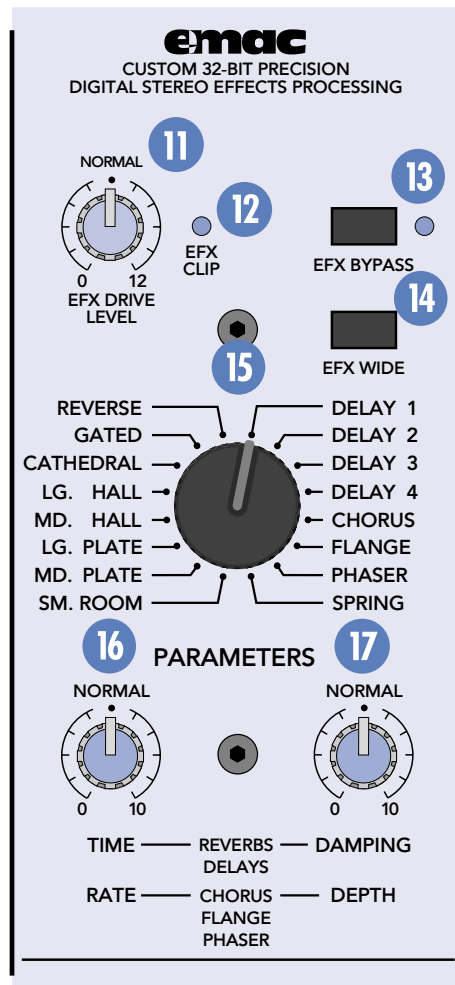

15 Preset Select

Rotate this detented switch to select the preset effect you want to use.

Preset Effects Descriptions

Reverbs

The reverbs are designed to provide a wide variety of reverb sounds for vocal and instrument applications. The TIME/RATE PARAMETER 16 controls the length of the tail, with the shortest tail at the 0 position and the longest tail at 10. The DAMPING/DEPTH PARAMETER 17 controls the damping, with the darkest tone at 0 and the brightest tone at 10. The EFX WIDE 14 switch is very effective at increasing the stereo image of the reverb effect in the stereo versions and enhancing reverb density in mono versions.

REVERSE: Standard reverse reverb, simulating a tail-first effect increasing to the original note. Decay range adjustable from 35ms to 515ms. No pre-delay.

GATED: Standard gated reverb where the reverb tail is cut off sharply after preset decay length. Decay range adjustable from 35ms to 515ms. No pre-delay.

CATHEDRAL: Dense, smooth reverb with very long tail, long pre-delay, and late reflections. Tails are very warm with some additional high-end reflections imitating the stone walls of a cathedral. A very dramatic effect that works well with wind instruments such as flute, slow finger picking on acoustic guitar, and quiet vocal group harmony and choirs. Also works well with keyboards and drums using short decay. Decay range adjustable from 2 seconds to 10 seconds. Pre-delay set at 75ms.

LG. HALL: Dense, smooth reverb with long tail, long pre-delay, and some early reflections. Tails are warm with more apparent high end. Works well with vocals and electric and acoustic guitar. Decay range adjustable from 1 second to 5 seconds. Pre-delay set at 75ms.

MD. HALL: Dense, smooth reverb with normal tail, normal pre-delay, and increased early reflections. Tails are warm with more apparent high end. Works well with vocals and electric and acoustic guitar. Decay range adjustable from 750ms to 2.5 seconds. Pre-delay set at 65ms.

LG. PLATE: Good early reflections and no pre-delay. Tails are normal and warm with strong high end for increased presence. Perfect for vocals and snare. Decay range adjustable from 1 second to 5 seconds. No pre-delay.

MD. PLATE: Good early reflections and no pre-delay. Tails are short and warm with strong high end for increased presence. Perfect for tight vocals and snare. Decay range adjustable from 750ms to 2.5 seconds. No pre-delay.

SM. ROOM: Reverb featuring very fast and scattered early reflections with a short pre-delay. Tails are very short and warm with normal high-end imitating absorbent wall materials and audience. Good for tight vocal effects. Decay range adjustable from 250ms to 1 second. Pre-delay set at 30ms.

SPRING: Mimics the vintage 60's-style wet spring reverb effect. Tails are normal with strong high end and a slight waver imitating the slow flutter of the mechanical spring system. Very good with acoustic guitar. Decay range adjustable from 1 second to 5 seconds. No pre-delay.

Delays

There are four delays available. Delay 1 has one repeat after the original note. Delay 2 has two repeats, Delay 3 has three, and Delay 4 has four. The TIME/RATE PARAMETER controls the time between repeats, with the fastest repeats at the 0 position and the slowest repeats at 10. The DAMPING/DEPTH PARAMETER controls the damping, with the darkest tone at 0 and the brightest tone at 10. For an analog tape delay sound, use a darker setting so that each subsequent repeat is darker than the prior one. For a crisp digital delay sound, use a brighter setting so the tone retains its high end on each subsequent repeat. Since the delay effect is not stereo, it is not affected by the EFX WIDE switch.

DELAY 1: One repeat. Works best for slapback delay used in country and swing guitar, and for rockabilly and some country vocals. Delay range adjustable from 5ms to 524ms.

DELAY 2: Two repeats. Provides a fuller, more dramatic effect for rock and gospel vocals, acoustic guitar, and wind instruments such as flute. Especially effective for some finger-picking styles. Delay range adjustable from 5ms to 524ms.

DELAY 3: Three repeats. An excellent delay for slow, bluesy vocals and melodic flute music. This delay usually works best when the channel EFX send is set at less than halfway. Delay range adjustable from 5ms to 524ms.

DELAY 4: Four repeats. This is for very dramatic delay effects, particularly for enhancing long vocal notes and dramatic instrumental note-chopping effects. Be sure to set the channel EFX send at about halfway. Delay range adjustable from 5ms to 524ms.

Modulation Effects

These include Chorus, Flange and Phaser, and are generally used for enhancement of instrumental music. However, Chorus adds a dramatic effect to vocals as well. The EFX WIDE switch is very effective at dramatically increasing the strength and thickness of a modulation effect. For example, using the EFX WIDE on Chorus mimics a multi-voiced chorus effect.

The TIME/RATE PARAMETER controls the effect Rate, which is the speed of the sweeping effect. Fully counter-clockwise produces the slowest sweeps and fully clockwise produces the fastest. DAMPING/DEPTH PARAMETER controls the effect depth, which is the strength of the sweeping effect. Fully counter-clockwise produces the lightest sweeping effect and fully clockwise produces the thickest.

CHORUS : Provides a soft, ethereal sweeping effect. Perfect for enhancement of electric and acoustic guitar and bass. Also adds a dramatic effect to vocals, particularly group harmonies and choirs. The channel EFX send should be set halfway or higher. Rate adjustable from 0.5Hz to 30Hz. Depth adjustable from 0% to 100%.

FLANGE : Creates a strong sweeping effect, particularly effective on rock electric guitar, lead and rhythm. The channel EFX send should be set halfway or higher. Rate adjustable from 0.5Hz to 20Hz. Depth adjustable from 0% to 100%.

PHASER : This effect is perfect for enhancing strummed acoustic guitar or electric guitar power chords. The PHASER effectively duplicates the popular 70's phase shift effect used for guitar. Rate adjustable from 0.5Hz to 35Hz. Depth adjustable from 50% to 100%.

EMAC SELECTIONS		
Name	Parameters	Typical Applications
<i>Reverbs</i>	<i>Decay/Pre-delay</i>	
REVERSE	35ms-515ms/none	Special effects on instruments or drums
GATED	35ms-515ms/none	Special effects on instruments or drums
CATHEDRAL	2sec-10sec/75ms	Wind instruments; acoustic guitar; choir
LG. HALL	1sec-5sec/75ms	Vocals; electric and acoustic guitar
MD. HALL	750ms-2.5sec/65ms	Vocals; electric and acoustic guitar
LG. PLATE	1sec-5sec/none	Vocals; snare
MD. PLATE	750ms-2.5sec/none	Tight vocals; snare
SM. ROOM	250ms-1sec/30ms	Tight vocals
SPRING	1sec-5sec/none	Acoustic guitar
<i>Delays</i>	<i>Delay/No. of Repeats</i>	
DELAY 1	5ms-524ms/1	Country, swing guitar; rockabilly vocals
DELAY 2	5ms-524ms/2	Rock, gospel vocals; acoustic guitar; wind instruments
DELAY 3	5ms-524ms/3	Slow, bluesy vocals; melodic flute
DELAY 4	5ms-524ms/4	Long vocal notes
<i>Chorus/Flange/Phase</i>	<i>Modulation/Depth</i>	
CHORUS	0.5Hz-30Hz/0%-100%	Electric, acoustic guitars; bass; choir
FLANGE	0.5Hz-20Hz/0%-100%	Rock electric guitar
PHASER	0.5Hz-35Hz/50%-100%	Strummed acoustic guitar, electric guitar power chords

16 TIME/RATE PARAMETER

If you have a reverb effect selected, this control adjusts how long the reverberation lasts, with 0 being a short reverb time and 10 being the longest.

If you have a delay effect selected, this adjusts the amount of time between the original signal and the delayed signal, with 0 being a short delay time and 10 being the longest delay time.

If you have a chorus, flange, or phaser effect selected, this control adjusts the rate or speed of the modulation of the effect.

17 DAMPING/DEPTH PARAMETER

If you have a reverb or delay effect selected, this control adjusts how fast the higher frequencies roll off in the reverberation or delay, with 0 having no roll off and 10 having the most roll off.

If you have a chorus, flange, or phaser effect selected, this control adjusts the depth of the modulation of the effect.

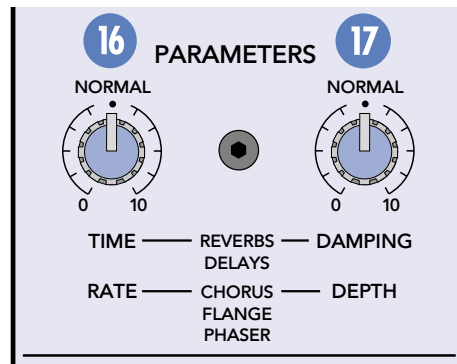

MASTER OUTPUT SECTION Description

18 POWER LED

This indicator lights up whenever the POWER switch is turned on and the PPM Series is plugged into a live outlet, just to let you know you're ready for action.

19 MONITOR EQUALIZER

The MONITOR EQUALIZER is used to shape the overall frequency response for the monitor speakers on stage. This is called a graphic equalizer because the position of the sliders provides a graphic display of the frequency response at its output. The equalizer is the last thing in the signal chain prior to being routed to the MONITOR LINE OUT ⁴¹ (and the power amplifier if the POWER AMP ROUTING ²⁹ switch is pushed in).

20 MAIN EQUALIZER

The MAIN EQUALIZER is used to shape the overall frequency response for the main speakers. The equalizer is the last thing in the chain prior to the signal being routed to the power amplifiers and the MIXER LINE OUT.

How to Adjust the Graphic Equalizers:

Note: These instructions are written on the top of the PPM Series cabinet, but we'll repeat them here because they are so important.

Reducing Feedback (Do monitor first)

1. Set the MIC channels to working volume levels (see "Level Setting" on page 6).
2. Set the Graphic EQ sliders to zero (center).
3. Slowly turn up the MAIN MASTER volume until feedback just begins to occur. BE CAREFUL! Feedback can occur quickly and become very LOUD, very fast.
4. Cut the appropriate slider until feedback stops.

Suggestions for Better Sound

1. For better vocal sound, set the 125, 250, and 16K sliders to +5.
Note: Make sure the singer is within 3 to 6 inches of the microphone. No amount of EQ can save a vocal when the singer is too far away from the microphone.
2. For more presence, set the 4K and 8K sliders to +5.
3. To warm up the overall sound, set the 2K slider to -5.
4. Use the RUMBLE REDUCTION switch to reduce the noise floor.
5. REMEMBER, LESS IS BETTER.

21 75Hz RUMBLE REDUCTION

There are two of these switches; one for the monitor output and one for the main output. Pushing in this switch places a low-cut filter into the circuit path, rolling off the frequencies below 75Hz.

Use the RUMBLE REDUCTION switch on the main output to reduce stage rumble (low-frequency noise from footsteps picked up by microphones on stage) and microphone-handling noise. Use the RUMBLE REDUCTION switch on the monitor output to reduce the muddiness caused by the lows feeding back into the main output through the stage microphones.

Note: This filter is separate from the graphic equalizer. The main RUMBLE REDUCTION switch affects only channels 1-6 and not the stereo channels 7 & 8, EFX TO MAIN, or TAPE IN. The monitor RUMBLE REDUCTION switch does affect the EFX TO MON signal.

22 EFX TO MON

Use this control to add the EMAC internal effects (or external effects, if connected) to the monitor mix. The effects signal is added to the monitor signal path just prior to the RUMBLE REDUCTION switch and the MONITOR MASTER control.

The EFX TO MON control ranges from off through unity (the center detent position) on up to +10 dB of extra gain.

23 MONITOR MASTER

This controls the overall signal level at the MONITOR LINE OUT. The control ranges from off through unity on up to +12 dB of extra gain.



Turning up the MONITOR MASTER too much can cause feedback. To reduce the possibility of feedback, try to position the microphones so they are pointing away from the stage monitors. This will minimize the amount of monitor signal that is picked up by the microphones.

24 EFX TO MAIN

Use this control to add the EMAC internal effects (or external effects, if connected) to the main mix. The effects signal is added to the main signal path just after the RUMBLE REDUCTION switch and just prior to the MAIN MASTER control.

The EFX TO MAIN control ranges from off through unity (the center detent position) on up to +10 dB of extra gain.

25 MAIN MASTER

This controls the overall signal level at the MIXER LINE OUT(s) 40 and at the input to the power amplifiers. The control ranges from off through unity on up to +12 dB of extra gain.

26 LEVEL Meters

These 8-segment LED meters indicate the

signal level at the MONITOR LINE OUT 41 and the MIXER LINE OUT 40. To attain the best signal-to-noise ratio while still maintaining adequate headroom, set the MONITOR MASTER and MAIN MASTER controls so the 0 dB indicator on the LEVEL meters blinks frequently. It's okay for the +5 dB indicator to blink occasionally, but avoid allowing the CLIP indicator to light. Clipping occurs at a +20 dBu output level.

27 PHANTOM POWER Switch

Push in this switch to provide phantom power to the XLR MIC input connectors. All of the XLR mic inputs are capable of providing phantom power. Phantom power is required to operate most condenser microphones (some condenser microphones are battery-powered). The PPM Series provide +15V DC phantom powering on pins 2 and 3 of the XLR connectors.

If you are using condenser microphones, or any mic that requires phantom power, engage the PHANTOM POWER switch (located just below the EMAC section). If you have dynamic, ribbon, or tube mics that do not require phantom power, leave the PHANTOM POWER switch out. If you are using both condenser and dynamic mics, don't worry. Phantom power will

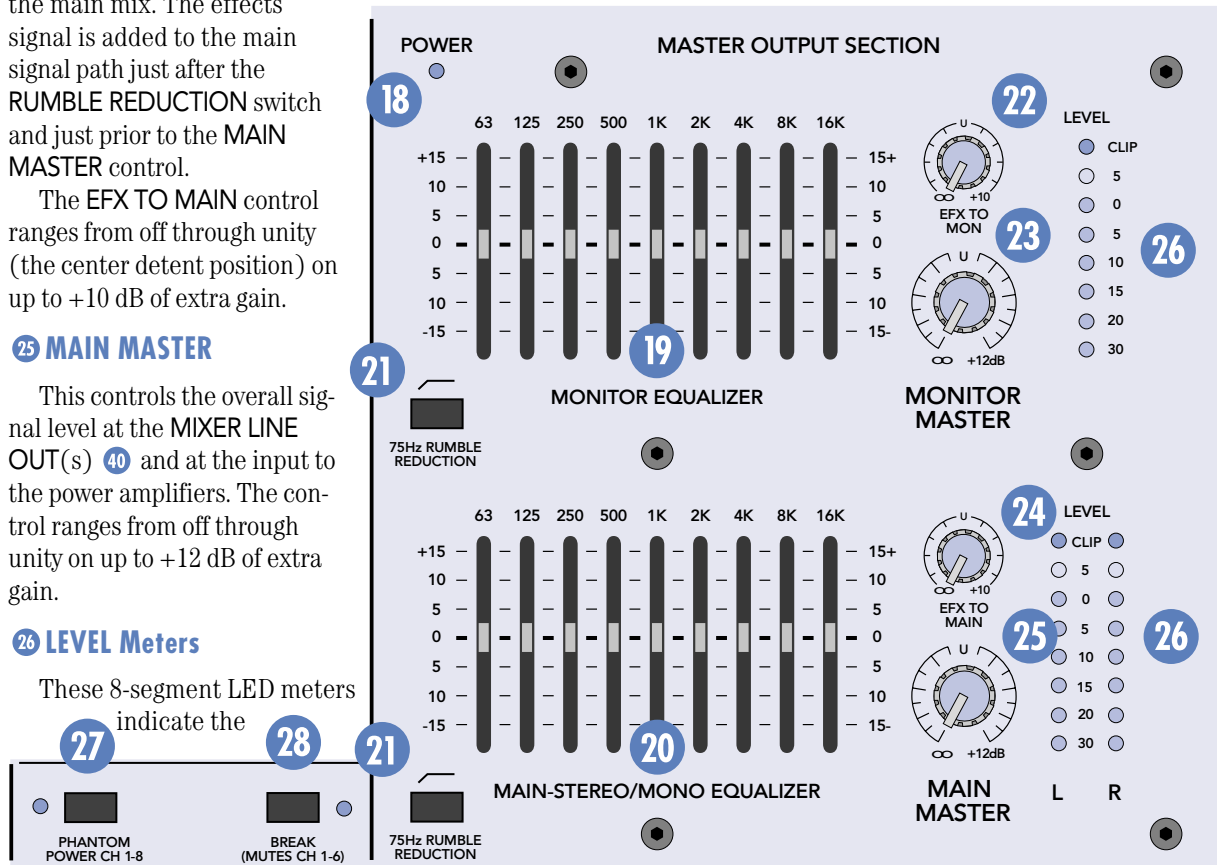

not hurt most dynamic mics. Check the microphone's user manual if you're not sure.



Caution: Turn all output levels down before operating this switch to avoid the possibility of a “pop” in your speakers.

Connecting a line-level input to an XLR input connector with the phantom power switched on could damage the output of the source device. We recommend using the 1/4" jacks for line-level inputs.

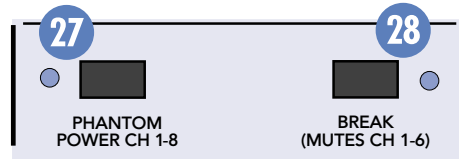

28 BREAK Switch

As in “take a break.” Push this switch in during your breaks and the mono channels (1-6), monitor send, and effects send are muted so you don't run the danger of something going haywire during your break, like having your system start feeding back or having some would-be poet jump up on stage and start reciting his latest epic.

This switch doesn't affect the TAPE IN or the stereo channels (7&8) so you can go ahead and run your cassette or CD player while you are on break.

29 POWER AMP ROUTING

This handy switch provides the flexibility to use the internal power amplifiers to power both the main and monitor outputs, or to power two main speakers with the internal amplifiers and use a separate power amplifier to power the monitor speakers.

When the switch is in the OUT position, the main mix is routed to the inputs of both amplifiers. For the mono versions (406M, 408M, 808M), the same signal is routed to the inputs of both amplifiers. You must have another amplifier to power your monitor speakers.

When the switch is pushed IN, the main mix is routed to the input of the MAIN power amp, and the monitor mix is routed to the input of the MONITOR power amp. You can still connect up to two speakers to each amplifier output, since there are two parallel SPEAKER OUTPUT jacks for each amplifier on the back panel. Just remember to maintain a 2 ohm load or greater for each amplifier.

Note: On the stereo versions (408S, 808S), the left and right signals are summed together just prior to the MAIN power amp input when the POWER AMP ROUTING switch is pushed in.

30 COMPRESSOR

Pushing this switch in activates a circuit at the input to the power amplifiers that senses the signal level and reduces the possibility of driving the amplifier into clipping. Clipping creates distortion that not only sounds bad, but can actually damage your loudspeakers. We recommend that you leave this switch pushed in (unless you hate your speakers).

31 TAPE IN LEVEL

You can connect a tape deck or CD player to the PPM Series and play back prerecorded music during your breaks. The tape signal is added to the main signal path just after the RUMBLE REDUCTION switch and just prior to the MAIN MASTER control. This is a stereo control, but for the mono versions (406M, 408M, 808M), the left and right inputs are summed.

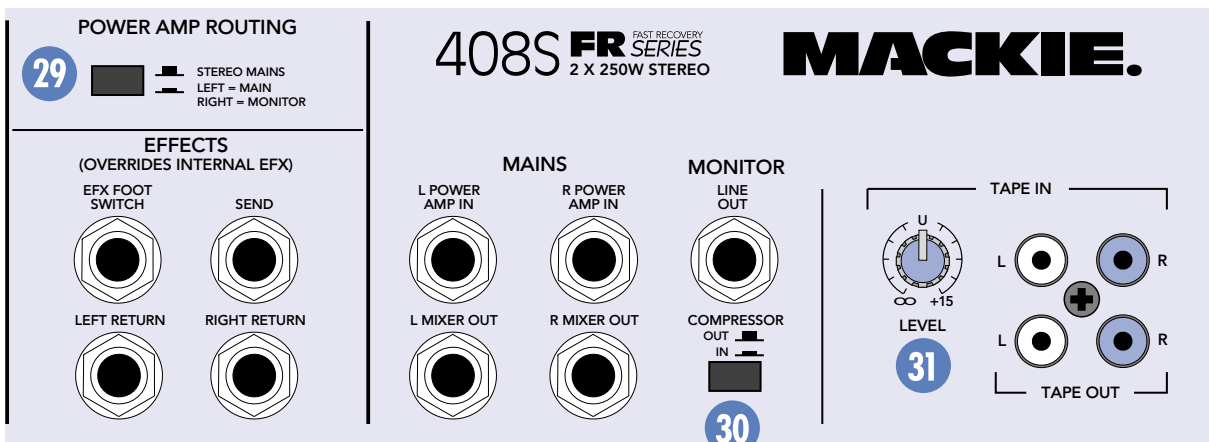

The TAPE IN LEVEL control ranges from off through unity (the center detent position) on up to +15 dB of extra gain. Note that this control only affects the TAPE IN level and not the TAPE OUT level (there is no tape out level control). The TAPE OUT level is pre-fader (actually pre-Master in this case) and is not affected by the MAIN MASTER control.



Caution: When using the TAPE OUT connectors for recording, don't connect the output of the tape deck to the TAPE IN connectors.

If you do, **MAKE SURE** the TAPE IN LEVEL control is turned all the way down or you will create a feedback loop that will suddenly make **you** the focus of attention.

32 POWER switch

The POWER switch is located on the rear panel of the mixer, near the linecord socket. Switch up to turn the mixer on, and switch down to turn it off.

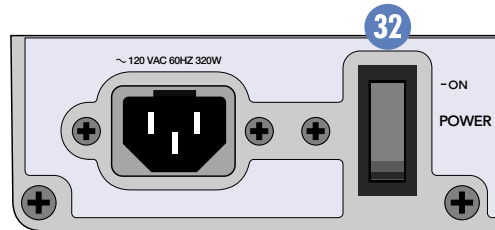

MAKING THE CONNECTIONS

Front Panel Connections

Connecting Microphones and Line-Level Signals

Each channel has both an XLR MIC **33** input and a 1/4" TRS LINE **34** input. In addition, the two stereo channels on the 408M, 408S, 808M, and 808S each have two 1/4" TRS line inputs, left and right **35**. These two inputs are summed together in the 408M and 808M, and are routed to the left and right buses respectively in the 408S and 808S. You can plug a mono signal into the LEFT stereo input and the signal is automatically routed to both the left and right inputs.

Mackie mixers have 3-pin female XLR connectors on all microphone inputs, so use a male XLR connector to connect to the mixer's mic preamps.

The XLR and 1/4" TRS inputs are balanced analog inputs. When connecting a balanced signal using the XLR or 1/4" jacks, be sure they're wired — per AES (Audio Engineering Society) standards — like this:

	XLR	TRS
Hot (+)	Pin 2	Tip
Cold (-)	Pin 3	Ring
Shield (Ground)	Pin 1	Shield

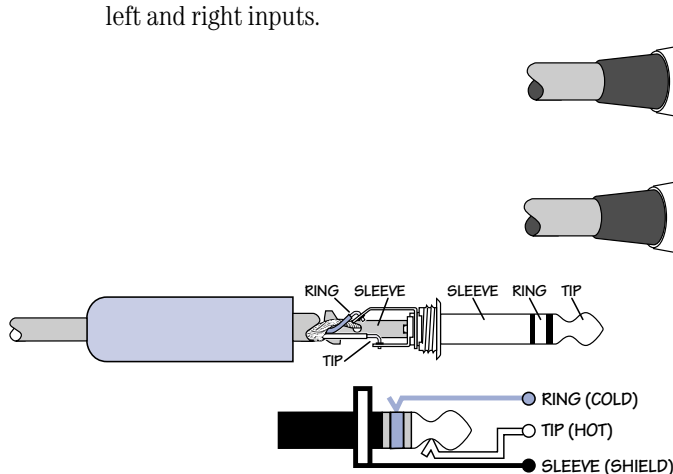

Balanced 1/4" TRS Plug

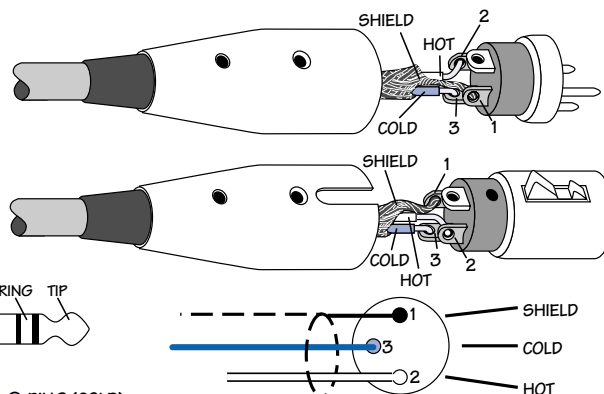

Balanced XLR Connectors

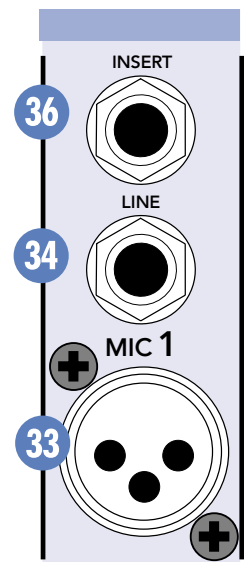

Mono Channel Strip

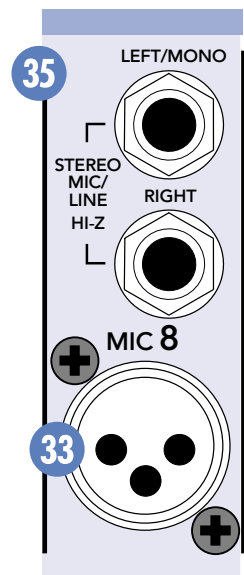

Stereo Channel Strip

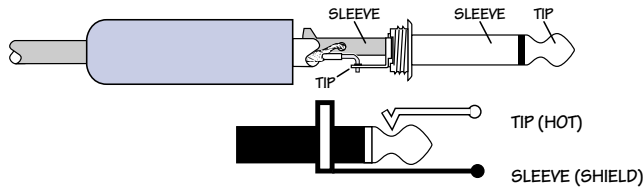

Unbalanced 1/4" TS Plug

Unbalanced TS (tip-sleeve) lines can be accommodated via the TRS jack. Make sure the cord terminates with a TS plug (like a guitar plug), or if it's a TRS plug (like a headphone plug), make sure the ring is tied to the shield, preferably at the source.

You can connect an input signal to both the MIC input and the LINE input. The signals are summed together prior to the INPUT LEVEL SET control so they are both affected by it. On the stereo channels 7 & 8, the inputs are summed after the INPUT LEVEL SET control and only the MIC input is affected by it.

36 Channel Inserts

The mono channels are equipped with INSERT jacks for connecting external processors into each channel's signal path. The insert point comes after the Mic/Line preamp's INPUT LEVEL SET control and just before the EQ controls.

This is a TRS jack specially configured as a combination Send/Return connection point. It is configured with the Tip = Send, Ring = Return, and Sleeve = Ground. This has become somewhat of a standard in the industry, and many cable manufacturers make cables especially for this purpose. With nothing plugged into the INSERT jack, the send signal is directly connected to the return pin via the normalling jack.

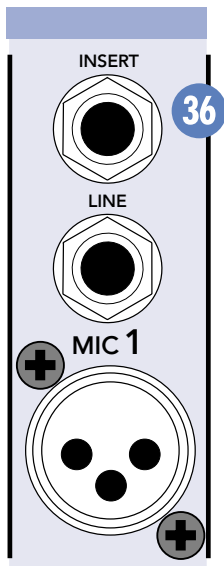

Mono Channel Strip

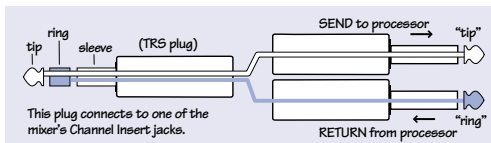

Tip = Send (output to effects device)

Ring = Return (input from effects device)

Sleeve = Common ground (connect shield to all three sleeves)

The INSERT jack can also be used as a direct out from the mic preamps to tape. If you insert a TS (mono) 1/4" plug halfway into the INSERT jack (to the first click), the plug will not activate the jack switch and will not open the insert loop in the circuit (thereby allowing the channel signal to continue on its merry way through the mixer). This allows you to tap the channel signal at that point in the circuit without interrupting normal operation.

If you push the 1/4" TS plug in to the second click, you will open the jack switch and create a direct out, which *does* interrupt the signal in that channel.

Do not overload or short-circuit the signal you are tapping from the mixer. Doing so will affect the internal signal.

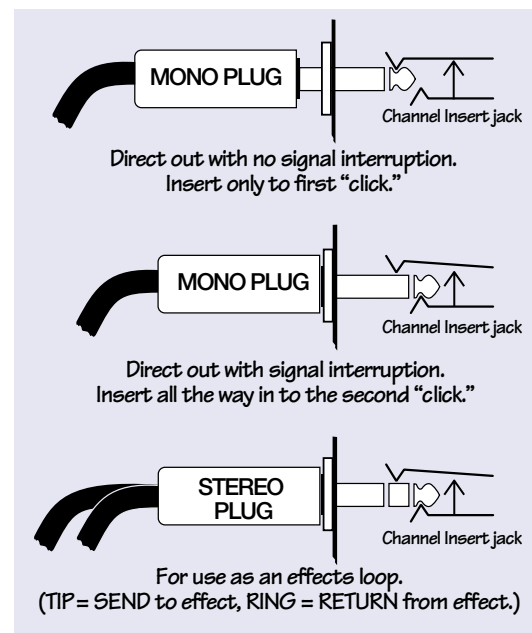

37 EFFECTS SEND and RETURN

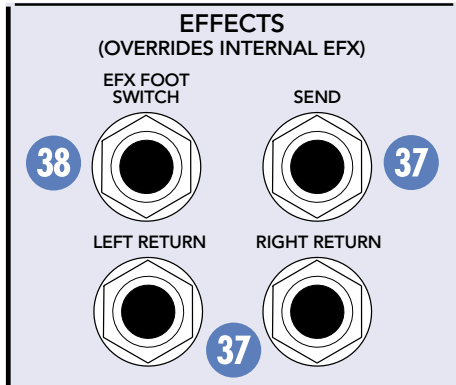

The EFFECTS SEND jack is a 1/4" connector that produces an unbalanced line-level signal. This signal is fed from the internal EFX bus, just after the EFX DRIVE LEVEL control.

Use a cable with 1/4" TS plugs to connect the EFFECTS SEND jack to the input of an external effects processor. Use a similar cable (or cables) to return the external effects processor's signal to the EFFECTS RETURN jack(s).

The mono versions (406M, 408M, 808M) have one EFFECTS RETURN jack and the stereo versions (408S, 808S) have two RETURN jacks. These are 1/4" connectors that accept an unbalanced line-level signal.

The EFFECTS SEND and RETURN are normalizing jacks, so with nothing plugged into the SEND or RETURN jacks, the internal effects signal from the EMAC is routed to the EFX TO MON and EFX TO MAIN controls. If you plug a 1/4" TS plug into the EFFECTS RETURN jack(s), the effects signal from the EMAC is disconnected from the signal path. Instead, the external effects signal is routed to the EFX TO MON and EFX TO MAIN controls.

Note: If you want to use the internal EMAC and an external effects processor at the same time, you have two options.

Serial effects device: The EFFECTS SEND jack is wired the same as the channel INSERT jacks, so you can use it to insert a processor in series with the EMAC effects. Refer to the "Channel Inserts" section 36 to see how to make this connection.

Parallel effects device: Plug a TS plug half-way into the EFFECTS SEND jack (to the first click). This allows you to use the EFFECTS SEND jack as a direct out without affecting the signal going to the EMAC. However, you must use one of the LINE inputs (or one of the stereo channel's stereo line inputs if it's a stereo processor) to return the signal from the external effects processor. If you plug into the EFFECTS RETURN jack, the signal from the EMAC is disconnected from the signal path.

38 EFX FOOT SWITCH

You can connect a normally-open foot switch to this connector to duplicate the function of the EFX BYPASS switch. Closing the switch connection causes the EFX BYPASS indicator to light and mutes the effects signal. This affects both the internal EMAC and an external effects processor (if connected) using the EFFECTS SEND and RETURN jacks.

Note: When a foot switch is plugged into the FOOT SWITCH jack, the EFX BYPASS switch is disabled.

39 POWER AMP IN 1 and 2

This is a 1/4" connector that accepts an unbalanced line-level signal. Whatever signal you plug into these jacks is routed to the power amplifier inputs. This provides the ability to insert a processor in the signal path between the MIXER OUT and the POWER AMP IN.

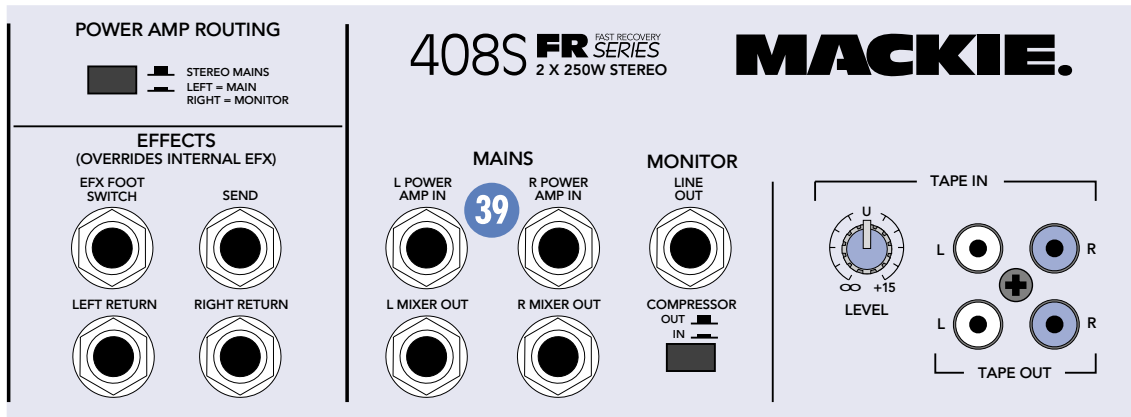

When a 1/4" plug is inserted in the POWER AMP IN jacks, the internal connection between the mixer section and the amplifier section is cut.

This completely separates the mixer from the amplifiers, and it allows you to connect an external equalizer, compressor or effects processor in-line between them as shown.

With a plug inserted in the POWER AMP IN jacks, the amplifiers will only play the external signals plugged into them. With no plug inserted, the mixer section and the amplifier section are joined and the amplifiers play the mixer signals as normal.

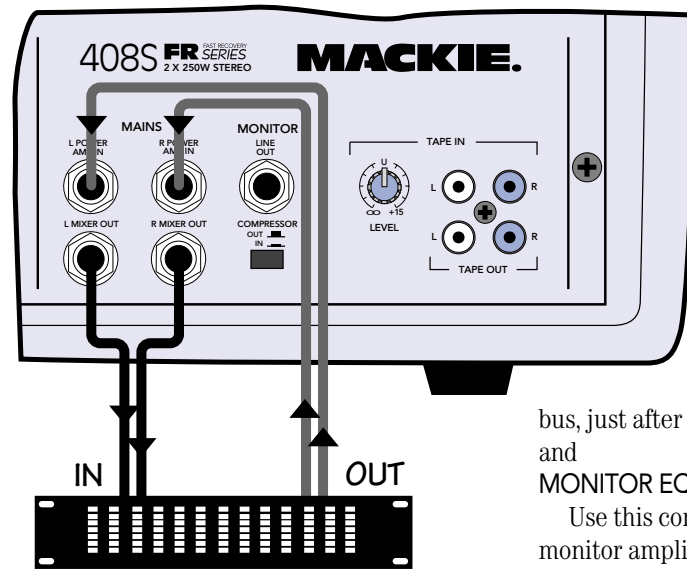

**External equalizer,
compressor, or processor**

If you have an external device in-line as shown in the diagram above, make sure it does not increase the signal gain too much, or it may overload the amplifier section. The PPM meters only show the signal level coming from the internal mixer section; they will not show any changes in gain due to the external device.

You might use these inputs to connect the outputs from the opening band's mixing board. This way you don't have to set up two sets of speakers; the other band can plug right into the PPM Series and use its amplifiers and connected speakers (see application diagram on page 13).

40 MIXER LINE OUT

This is a 1/4" connector that produces an unbalanced line-level signal. This signal is fed from the internal mixer bus, just after the MAIN MASTER control and MAIN EQUALIZER, and just before the POWER AMP IN jacks.

You can use the MIXER LINE OUTs to connect a second power amplifier, giving you the option of adding more power and more speakers (see application diagram on page 10).

41 MONITOR LINE OUT

This is a 1/4" connector that produces an unbalanced line-level signal. This signal is fed from the internal monitor bus, just after the MONITOR MASTER control and MONITOR EQUALIZER.

Use this connection to drive an external monitor amplifier and speakers, or to supplement the PPM Series' monitor amplifier (when the POWER AMP ROUTING switch 29 is pushed in) with another amplifier and speakers (see application diagram on page 8).

42 TAPE IN and TAPE OUT

These are unbalanced RCA-type connectors that match those typically used on tape decks and CD players. Use RCA-to-RCA patch cables to make these connections.

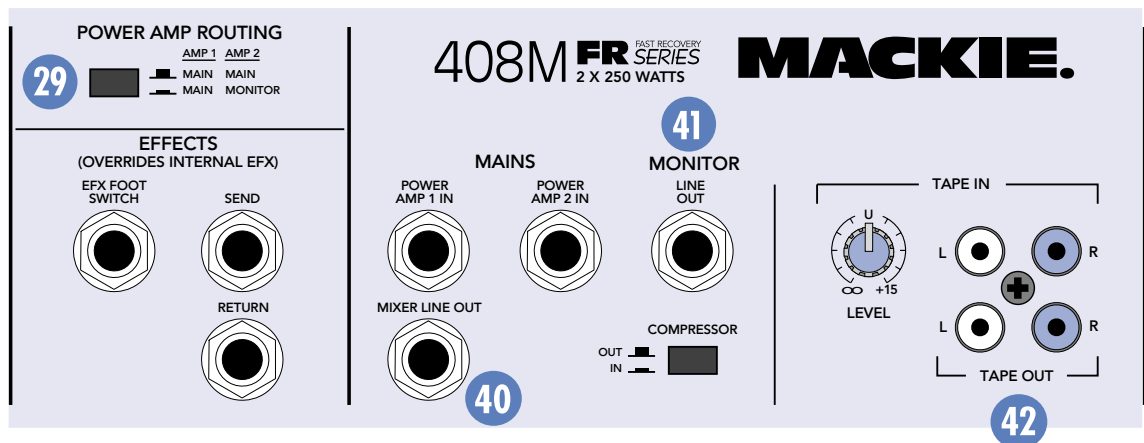

The TAPE IN signal is routed to the mixer bus just after the RUMBLE REDUCTION switch and just before the TAPE IN LEVEL control, MAIN MASTER control, and MAIN EQUALIZER. The TAPE OUT signal is tapped just after the RUMBLE REDUCTION switch, and before the MAIN MASTER control and MAIN EQUALIZER.



Caution: When using the TAPE OUT connectors for recording, don't connect the output of the tape deck to the TAPE IN connectors.

If you do, **MAKE SURE** the TAPE IN LEVEL control is turned all the way down or you will create a feedback loop that will cause great distress to you and everyone around you.

Rear Panel Connections

43 SPEAKER OUT

This is a 1/4" connector that produces an unbalanced speaker-level signal.

Use 1/4" TS speaker cables to connect the SPEAKER OUTs to the inputs of your speakers. Use at least 18 gauge (18AWG) speaker wire.



Caution: Don't use standard guitar cables to make these connections. Guitar cords are designed for line-level signals (millivolts and milliamps), not speaker-level signals (several volts and several amps).

There are two SPEAKER OUT jacks for each amplifier. The jacks are wired in parallel so if you connect two speakers to an amplifier, the load presented to the amplifier is the parallel impedance of both speakers. This impedance must be two ohms or greater.



For parallel connections:
 $8\text{ ohms} + 8\text{ ohms} = 4\text{ ohms}$
 $4\text{ ohms} + 4\text{ ohms} = 2\text{ ohms}$

44 IEC Socket

This is where you connect the supplied AC linecord to provide AC power to the PPM Series powered mixer. Plug the linecord into an AC socket properly configured for your particular model.

Note: If you happen to lose the AC linecord, replacements are easily available at any office/computer supply store or Radio Shack® (ask for part number 278-1257).

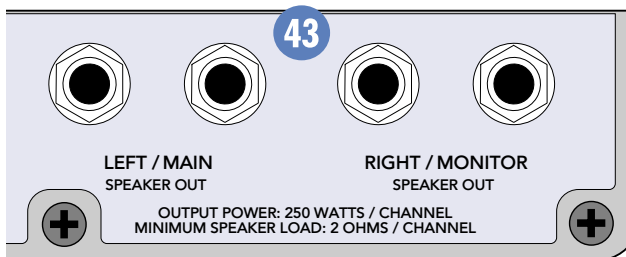
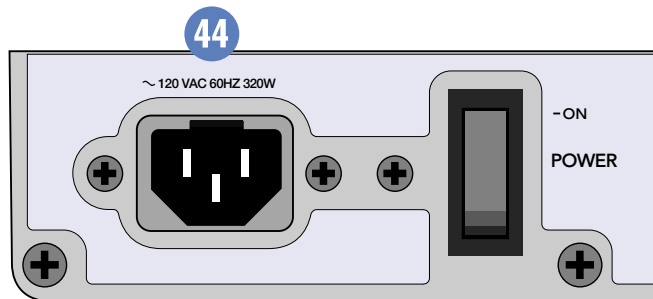

Stereo Version Speaker Connectors (408S)

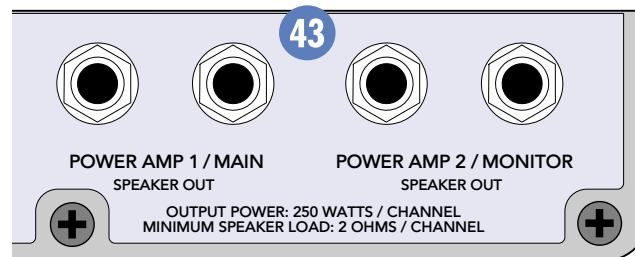

Mono Version Speaker Connectors (408M)

GENERAL PRECAUTIONS AND CONSIDERATIONS

Thermal Considerations

The PPM Series Powered Mixers contain two powerful built-in amplifiers. All amplifiers produce heat, and the more power it produces, the more heat is produced. It is important to dissipate the heat away from an amplifier as quickly as possible. This results in increased reliability and longevity for the amplifier. That's what the massive die-cast aluminum heatsink on the rear panel is for.

Heat from the output transistors is coupled to the heatsink, which draws the heat away from the transistors and out to the heatsink fins. Cool air is drawn through the fins due to a process called convection, warming the air and taking the heat away.

In order for this convection cooling to work efficiently, it is important to provide adequate airspace behind the mixer. We recommend leaving at least six inches of air space behind the mixer when you set it up.

In the unlikely event of the amplifier overheating, a thermal switch activates and shuts down the mixer until it cools off. Double-check the speaker load on each amplifier and make sure that the total impedance of each load is 2 ohms or greater. If the load impedance drops below 2 ohms, it can cause the amplifier to overheat. If the load impedance is okay, overheating may be caused by excessive ambient temperature (the room's too hot!). Try using a fan aimed at the heatsink to move air through the fins faster.

AC Power Considerations

Be sure the PPM Series Powered Mixer is plugged into an outlet that is able to supply the correct voltage specified for your model. If the voltage should drop below 97% of the specified line voltage, the built-in amplifiers will no longer be able to supply rated power. (They will continue to operate down to 75% of the rated voltage, but won't reach full power, resulting in lower headroom.)

Under typical conditions, reproducing music where musical peaks are just below clipping, the powered mixers draw the following average currents:

Amplifier Loading	Average Current	
	406M, 408M, 408S	808M, 808S
8Ω per side	2.0 A	2.2 A
4Ω per side	3.1 A	3.3 A
2Ω per side	4.8 A	5.0 A

(Above current based on using 120V AC line)



NEVER bypass the AC plug's ground pin. This is dangerous!

It is recommended that a stiff (robust) supply of AC power be used because the amplifiers place high momentary current demands on the AC line. The more power that is available on the line, the louder the amplifiers will play and the more peak output power will be available for cleaner, punchier bass. A suspected problem of "poor bass performance" is often caused by a weak AC supply to the amplifiers.

AC Power Distribution

The majority of AC outlets encountered in homes and clubs (in the U.S.) are served by a 240VAC center-tapped service entrance transformer. This provides two phases of AC power on either side of the center tap, at 120V each.

If lighting is used in a show, it is preferable to power the lights from one leg of the service, and power the audio equipment from the other leg. This will help minimize noise from the lights coupling into the audio (particularly if SCRs, or light-dimmer switches, are used).

In order to minimize ground loops, the safety grounds for all the outlets should be connected to a common ("star") grounding point, and the distance between the outlets and the common grounding point should be as short as possible.

When setting up for a show, oftentimes you are plugging into an AC power distribution system you know nothing about. You may even be faced with 2-wire outlets that are missing the third safety ground pin. It's a good idea to have a three-wire AC outlet tester in your toolbox so you can check the outlets yourself to make sure they are wired correctly. These testers will tell you if the polarity of the hot and neutral wires is reversed and if the safety ground is disconnected. *Don't use an outlet if it is wired improperly!* This is to protect yourself as well as your equipment.

If you find that you must plug into a two-wire outlet, you will need to use a two-wire to three-wire adapter (cheater plug). These come with a metal tab that you put underneath the center screw that holds the AC outlet faceplate in place. This center screw *must* be grounded. You can check it by connecting the adapter to the outlet and then plugging in your handy-dandy AC outlet tester.

APPENDIX A: Service Info

Warranty Service

If you think your powered mixer has a problem, please do everything you can to confirm it before calling for service, including reading through the following Troubleshooting section.

Of all Mackie products returned for service (which is hardly any at all), many are coded “CND” — Could Not Duplicate, which usually means the problem lay somewhere else in the system. Here are some things you can check:

Troubleshooting

No power!

- Our favorite question: Is it plugged in? Make sure the AC outlet is live (check with a tester or lamp).
- Our next favorite question: Is the POWER switch on? If not, try turning it on.
- Is the green POWER light on the front panel illuminated? If not, make sure the AC outlet is live. If so, refer to “No sound” below.
- The AC line fuse inside the mixer is blown. This is not a user-serviceable part. Refer to “Repair” on page 28 to find out how to proceed.

No sound!

- Are the INPUT LEVEL SET controls turned all the way down? Follow the procedures in the “Quick Start” section on page 6 to verify that all the level and volume controls are properly adjusted.
- Is the signal source working (and making union scale)? If it’s a microphone, make sure the mic cable is in good repair and securely connected at both ends. If it’s a condenser microphone, make sure the PHANTOM POWER switch is turned on. If it’s an instrument, again make sure the connecting cables are in good repair and securely connected at both ends. Make sure the output volume (gain) control for the instrument is turned up sufficiently to drive the inputs of the mixer. You should be able to see the INPUT LEVEL SET LED blink when you turn up the INPUT LEVEL SET control. If you’re monitoring the TAPE IN, make sure the tape deck’s Tape/Source switch is set to “Tape,” and make sure the TAPE IN LEVEL control on the powered mixer is turned up to unity (center position).

- Is the channel’s VOLUME control and the MAIN MASTER control properly set? Refer to the “Level Setting Procedure” on page 6.
- Is there something plugged into the channel’s INSERT jack? Plugging into the INSERT jack breaks the signal path for the channel. Try unplugging any INSERT devices. If that fixes the problem, make sure you’re using a properly wired send/return cable (see “Making the Connections” on page 21). Make sure the volume (gain) controls on the external processor connected to the INSERT jack are properly set.
- Is there something plugged into the POWER AMP IN jacks? Plugging into the POWER AMP IN jacks breaks the signal path between the mixer and the amplifier. However, the signal source you have plugged into the POWER AMP IN jacks should be heard over the speakers connected to the SPEAKER OUT jacks.
- Do you have any external equalizers, compressors or processors connected between the MIXER OUT and POWER AMP IN jacks? If so, make sure they are working correctly.
- Are there fuses in the speaker or in-line fuses in the speaker wire? Check ’em to see if they’re blown.
- Are the speakers working properly? If you have another amplifier that you know works, plug the speakers into it to make sure they work.

One side is way louder than the other!

For the 408S and 808S:

- Do the LEVEL meters read the same on both sides? If not, the PAN control on the signal source’s channel strip may be turned too far to one side. If you’re using a stereo signal source, it may be delivering an out-of-balance stereo signal.
- Try swapping sides: Turn off the powered mixer, swap the speaker cables at the SPEAKER OUT jacks, turn the mixer back on. If the same side is still louder, the problem is with your speakers or speaker cabling. If the other side is louder now, the problem is with the mixer, the amp, or the signal source.

The bass frequencies diminish when standing center, but get louder as you approach one side!

- Check the polarity of the speaker cable connections. You may have your positive and negative connections reversed at one end of one speaker cable.

As soon as the music gets loud, the mixer shuts down!

- Check the LEVEL meters. Be sure that the CLIP LED is not lighting up frequently or continuously.
- Make sure there is room behind the powered mixer to provide sufficient ventilation to the heatsink. If it gets too hot, it will shut down the show.
- Is the total speaker impedance connected to each amplifier 2 ohms or greater? If the impedance is too low, the amplifier may overheat and shut down.

It hurts when I touch my arm, or my leg, or even my head!

- You have a broken finger.

Bad sound!

- Is it loud and distorted? Follow the procedures described in the “Quick Start” section to verify that the levels are set properly.
- Is the input connector plugged completely into the jack? Check the speaker connections and verify that all connections are tight and that there are no stray strands of wire shorting across the speaker terminals.
- Keep practicing.

Noise/Hum

- Turn the channel VOLUME knobs down one by one. If the noise disappears, it's either that channel or whatever is plugged into it. If not, turn down the EFX TO MAIN control. If the noise disappears, it could be coming from an external effects device plugged into the EFFECTS RETURN jack(s).
- Make sure all connections to the powered mixer are good and sound.
- Make sure none of the signal cables are routed near AC cables, power transformers, or other EMI-inducing devices.
- Is there a light dimmer or other SCR-based device on the same AC circuit as the powered mixer? Use an AC line filter or plug the powered mixer into a different AC circuit.

- Is there an external processor or other electronic device connected to the powered mixer? Make sure it is plugged into the same AC circuit as the powered mixer to reduce the possibility of creating a ground loop.
- Refer to “Grounding” in Appendix B.

There's sound in the monitors even though all the channel MONitor controls are turned down!

- Make sure the EFX TO MON control is turned down. This control adds the “wet” effects signal to the monitor output even when there is no monitor signal present.

Repair

Service for the PPM Series Powered Mixers is available only from one of our authorized domestic service stations or at the factory, located in sunny Woodinville, Washington. Service for Mackie Powered Mixers living outside the United States can be obtained through local dealers or distributors.

If your powered mixer needs service, follow these instructions:

1. Review the preceding troubleshooting suggestions. Please.
2. Call Tech Support at 1-800-258-6883, 8am to 5pm PST, to explain the problem and request an RA (Return Authorization) number. Have your powered mixer's serial number ready. *You must have an RA number before you can obtain service at the factory or an authorized service center.*
3. Keep this owner's manual. We don't need it to repair the powered mixer.
4. Pack the powered mixer in its original package, including endcaps and box. This is *very important*. When you call for the RA number, please let Tech Support know if you need new packaging. *Mackie is not responsible for any damage that occurs due to non-factory packaging.*
5. Include a legible note stating your name, shipping address (no P.O. boxes), daytime phone number, RA number, and a detailed description of the problem, including how we can duplicate it.

6. Write the RA number in **BIG PRINT** on top of the box.
7. Ship the powered mixer to us. We suggest insurance for all forms of cartage. Ship to this address:

Mackie Designs
SERVICE DEPARTMENT
16140 Wood-Red Rd. NE, Ste. 5
Woodinville, WA 98072

8. We'll try to fix the mixer within three business days. Ask Tech Support for current turn-around times when you call for your RA number. We normally send everything back prepaid using UPS Orange (three-day air). However, if you rush your powered mixer to us by next-day air, we'll treat it in kind by shipping it back the same way in which it was received. This paragraph does not necessarily apply to non-warranty service.

APPENDIX B: Some Arcane Mysteries Illuminated

Balanced Lines

Balanced lines offer increased immunity to external noise (specifically, hum and buzz). Because a balanced system is able to minimize noise, it is the preferred interconnect method, especially in cases where very long lengths of cable are being used. A long unbalanced cable carries with it more opportunity for noise to get into a system — having balanced inputs means very little noise will enter the system via snakes and other cables that typically must run a long length.

A balanced line is a three-wire system where two wires carry the signal and the third is a ground wire that shields the inner conductors from EMI. The two inner conductors carry the same signal, but with opposite polarity. The balanced input amplifies only the difference between the two conductors. But a signal that is common to both conductors, and in phase, is rejected (canceled out) at the balanced input. This includes hum from AC lines or other EMI induced noise.

An unbalanced line does not have this noise-rejecting capability because it has only two conductors. One conductor carries the signal and the other is a ground wire that shields the inner conductor. Any hum or EMI noise that gets through the shield is added to the signal and amplified at the unbalanced input. Often the hum can be louder than the signal itself!

Unbalancing a Line

In most studio, stage, and sound reinforcement situations, there is a combination of balanced and unbalanced inputs and outputs on the various pieces of equipment. This usually will not be a problem in making connections.

- When connecting a balanced output to an unbalanced input, be sure the signal high (hot) connections are wired to each other, and that the balanced signal low (cold) goes to the ground (earth) connection at the unbalanced input. In most cases, the balanced ground will also be connected to the ground at the unbalanced input. If there are ground-loop problems, this connection may be left disconnected at the balanced end.

- When connecting an unbalanced output to a balanced input, be sure that the signal high (hot) connections are wired to each other. The unbalanced ground (earth) connection should be wired to the low and the ground connections of the balanced input. If there are ground-loop problems, try connecting the unbalanced ground connection only to the input low connection, and leaving the input ground connection disconnected.

- In some cases, you will have to make up special adapters to interconnect your equipment. For example, you may need a balanced XLR female connected to an unbalanced 1/4"

TS phone plug. The balanced-to-unbalanced connection has been anticipated in the wiring of Mackie jacks. A 1/4" TS plug inserted into a 1/4" TRS balanced input, for example, automatically unbalances the input and makes all the right connections. Conversely, a 1/4" TRS plug inserted into a 1/4" unbalanced input automatically ties the ring (low or cold) to ground (earth).

Grounding

Grounding exists in your audio system for two reasons: product safety and noise reduction. The third wire on the power cord exists for product safety. It provides a low-resistance path back to the electrical service to protect the users of the product from electrical shock. Hopefully, the resistance to ground through the safety ground (third wire) is lower than that through the user/operator to ground. If you remove this connection (by breaking or cutting the pin off, or by using a 'ground cheater'), this alternate ground path ceases to exist, which is a safety hazard.

The metal chassis of the product, the ground connections provided by the various connectors, and the shields within your connecting cables provide a low-potential point for noise signals. The goal is to provide a lower impedance path to ground for noise signals than through the signal wiring. Doing so helps minimize hum, buzz, and other extraneous non-audio signals.

Many "authorities" tell you that shields should be connected only at one end. Sometimes this can be true, but for most (99%) audio systems, it is unnecessary. If you do everything else correctly, you should be able to connect every component of your audio system using standard, off-the-shelf connecting cables that are available at any music store.

Here are some guidelines:

1. Use balanced lines if at all possible. They provide better immunity to induced noise and ground loops. Remember that you can balance a line by inserting in-line a piece of equipment that has a balanced output.
2. Avoid using three-phase power lines since they are usually used for air conditioning and other heavy power equipment. If using 240VAC single phase with center-ground power, connect all audio equipment to one side of the AC power, and all lighting and other equipment to the other side.
3. Be sure all AC outlet safety grounds are connected to one common point in a star ground arrangement. This common ground point should then tie back to earth ground at the service entrance by one heavy stranded wire, #2 gauge or larger.
4. Don't cut the third pin off the power cord. Carry some ground-lifter adapters and use them only if you have to plug into an ancient two-wire outlet.
5. Cables that are too long are less likely to pick up hum if you uncoil them in their entirety, and then find a place to stow the excess. Leaving the excess coiled only helps the cable pick up hum more efficiently.
6. If you bundle your cables together, don't bundle AC wiring and audio wiring together. Bundle them separately.
7. If your sound system insists on humming, you may want to teach it the words.

APPENDIX C: Technical Info

Specifications PPM Series Powered Mixers 406M, 408M, 408S, 808M, 808S

Mixer Section

Frequency Response

Mic Input to Main Mixer Output (Trim at 0 dB):
+0, -1 dB, 32Hz to 20kHz
+0, -3 dB, 16Hz to 80kHz
Mic Input to Power Amp Output @ rated power output:
+0, -1 dB, 32Hz to 20kHz
+0, -3 dB, 16Hz to 55kHz

Distortion

THD and SMPTE IMD; 20Hz to 20kHz

Mic Input to Main Mixer Output:
< 0.005% @ +4 dBu output
Mic Input to Power Amp Output:
< 0.15%, 250mW to rated power

Common Mode Rejection Ration (CMRR)

60 dB @ 1kHz, Trim @ 0 dB

Noise

20Hz to 20kHz BW (150Ω source impedance)

Equivalent Input Noise (EIN):
-127 dBu
Residual Output Noise:
Main Mixer, Monitor, & Effects outputs
Channel & Master levels off
-95 dBu
Main Mixer Output Noise:
Master @ nominal (-10 dB), all channels off
-92 dBu
Master & 1 input channel @ nominal
(-10 dB & -20 dB), Trim @ 0 dB
-85 dB

Crosstalk

Adjacent Inputs or Input to Output:
-90 dB @ 1kHz
Fader Off
-90 dB @ 1kHz
Break Switch Mute
-80 dB @ 1kHz

Input Level Trim Control Range

0 to -40 dB

Phantom Power

+15V DC

Equalization

Rumble Reduction:	75Hz, -18 dB/octave
Channel EQ:	
High	±15 dB @ 12kHz
Mid	±12 dB @ 2.5kHz
Low	±15 dB @ 80Hz
Graphic EQ (9 bands):	
Q = 1.414, ISO octave centers	
±15 dB @ 63, 125, 250, 500, 1k, 2k, 4k, 8k, 16k Hz	

Main Mixer Section Rated Output

Main Mixer, Monitor, & Effects:	+4 dBu
Maximum Main Mixer Section Output:	+20 dBu

Maximum Input Levels

Mic Input:	-20 dBu, Trim @ 0 dB (HI) +20 dBu, Trim @ -40 dB (LOW)
Line Input:	0 dBu, Trim @ 0 dB (HI) +40 dBu, Trim @ 40 dB (LOW)
Insert Input:	+20 dBu
Stereo Line Input:	+20 dBu
Tape Input:	+20 dBu
Effects Return:	+20 dBu
Power Amp In:	+22 dBu

Input Sensitivity

Minimum Input Level to produce +4 dBu @ Main Mixer Output	
Mic Input:	-68 dBu
Insert Input:	-28 dBu
Line Input:	-48 dBu
Stereo Line Input:	-28 dBu
Tape Input:	-18 dBu
Effects Return:	-18 dBu

Maximum Voltage Gain

Mic Input to	
Insert Output:	40 dB
Tape Output:	60 dB
Main Mixer Output:	72 dB
Line Input to	
Insert Output:	20 dB
Tape Output:	20 dB
Main Mixer Output:	52 dB
Stereo Line Input to	
Tape Output:	20 dB
Main Mixer Output:	32 dB
Tape Input to	
Tape Output:	10 dB
Main Mixer Output:	22 dB
Effects Return to	
Main Mixer Output:	22 dB
Monitor Output:	22 dB

Input Impedance

Mic Input:	3kΩ, balanced
Insert Input:	10kΩ, unbalanced
Line Input:	40kΩ, balanced
Stereo Line Input:	10kΩ, unbalanced
Tape Input:	10kΩ, unbalanced
Effect Return:	10kΩ, unbalanced
Power Amp In:	10kΩ, unbalanced

Output Impedance

Main Mixer Output:	150Ω
Insert Output:	150Ω
Tape Output:	150Ω
Monitor Output:	150Ω
Effects Send:	150Ω
Power Amp Out:	0.032Ω @ 1kHz

Digital Effects

Resolution:	16-bit, 2-channel
Sample Rate:	31.25kHz
Bandwidth:	15.6kHz

VU Meters

Main and Monitor
8 segments: Clip, +5, 0, -5, -10, -15, -20, -30

Power Amplifier Section

Maximum Power at 1% THD, midband, both channels driven

406M, 408M, 408S

250 watts per channel into 2Ω
200 watts per channel into 4Ω
125 watts per channel into 8Ω

808M, 808S

600 watts per channel into 2Ω
450 watts per channel into 4Ω
300 watts per channel into 8Ω

Continuous Sine Wave Average Output Power, both channels driven (rated power)

406M, 408M, 408S

180 watts per channel into 4Ω from 40Hz to 20kHz, with no more than 0.15% THD
110 watts per channel into 8Ω from 40Hz to 20kHz, with no more than 0.10% THD

808M, 808S

340 watts per channel into 4Ω from 40Hz to 20kHz, with no more than 0.15% THD
240 watts per channel into 8Ω from 40Hz to 20kHz, with no more than 0.10% THD

Power Bandwidth

< 10Hz to 30kHz (+0, -1 dB) @ rated power into 4Ω

Frequency Response

< 10Hz to 30kHz (+0, -1 dB)
< 10Hz to 55kHz (+0, -3 dB)

Distortion

THD, SMPTE IMD: < 0.10% @ 8Ω
< 0.15% @ 4Ω

Signal-to-Noise Ratio

> 105 dB below rated power into 8Ω

Channel Separation

> 75 dB @ 1kHz

Damping Factor

> 250 @ 1kHz

Amp Input Impedance

10kΩ unbalanced, 20kΩ balanced

Input Sensitivity

406M, 408M, 408S

1.35 volts (+4.8 dBu) for rated power into 4 ohms

808M, 808S

1.76 volts (+7.1 dBu) for rated power into 4 ohms

Gain (Amp In to Speaker Out)

26.4 dB (21V/V)

Maximum Input Level

9.75 volts (+22 dBu)

Rise Time

406M, 408M, 408S < 5μs
808M, 808S < 6.2μs

Slew Rate

406M, 408M, 408S > 40V/μs
808M, 808S > 50V/μs

Load Angle

8(±jx) time independent at 8Ω
4(1±jx) time dependent at 4Ω

High Frequency Overload and Latching:

No latch up at any frequency or level.

High Frequency Stability:

Unconditionally stable, driving any reactive or capacitive load

Turn On Delay:

3 seconds

AC Power Requirements

United States: 120VAC, 60Hz
Europe: 240VAC, 50Hz
Japan: 100VAC, 50/60Hz
Korea: 220VAC, 60Hz
(Capable of operation from 75% to 110% of rated line voltage)

Physical

Height: 11.7 inches (297mm)
Width: 20.5 inches (521mm)
Overall Depth: 13 inches (330mm)
Weight:
406M, 408M, 408S 32 pounds (14.5 kg)
808M, 808S 36 pounds (16.3 kg)

Disclaimer

Since we are always striving to make our products better by incorporating new and improved materials, components, and manufacturing methods, we reserve the right to change these specifications at any time without notice.

This product is sold by weight, not by volume.

Contributors and Colophon

This manual was written and laid out by David Franzwa at Mackie Galactic Headquarters overlooking the beautiful Sammamish Slough in sunny Woodinville, WA. Input was provided by the following Mackoids:

Steve Eborall, technical writer; Sara Delahan, Art Director; Paul Larson, Tech Support Maestro; Rick Bos, Powered Mixer Product Manager and on-staff tall person; Jeff Gilbert, long-time Mackoid and technical advisor; CJ Murray, project engineer. Proofreading provided by the ever-faithful Linn Compton. Additional tidbits provided by Rick Chinn and Ron Koliha.

Preliminary text was written on a Power Macintosh® 8100/100AV using Microsoft® Word 98. Typesetting was performed on the same Power Macintosh using Adobe® PageMaker® 6.5. Illustrations were created using Adobe® Illustrator® 7.0. Fonts used include ITC Century Light Condensed, Avenir Demi, and Tekton. Subheadings were made with Futura Condensed. Font management provided by Adobe® Type Manager® Deluxe 4.0 and Type Reunion® Deluxe 2.0.

"Mackie," the "Running Man" figure, "PPM Series," "FR Series," and "EMAC" are trademarks or registered trademarks of Mackie Designs Inc.

All other brand names mentioned are trademarks or registered trademarks of their respective holders, and are hereby acknowledged.

©2002 Mackie Designs Inc.
All Rights Reserved.



Block Diagrams

PPM Series Powered Mixers Stereo Versions (408S, 808S)

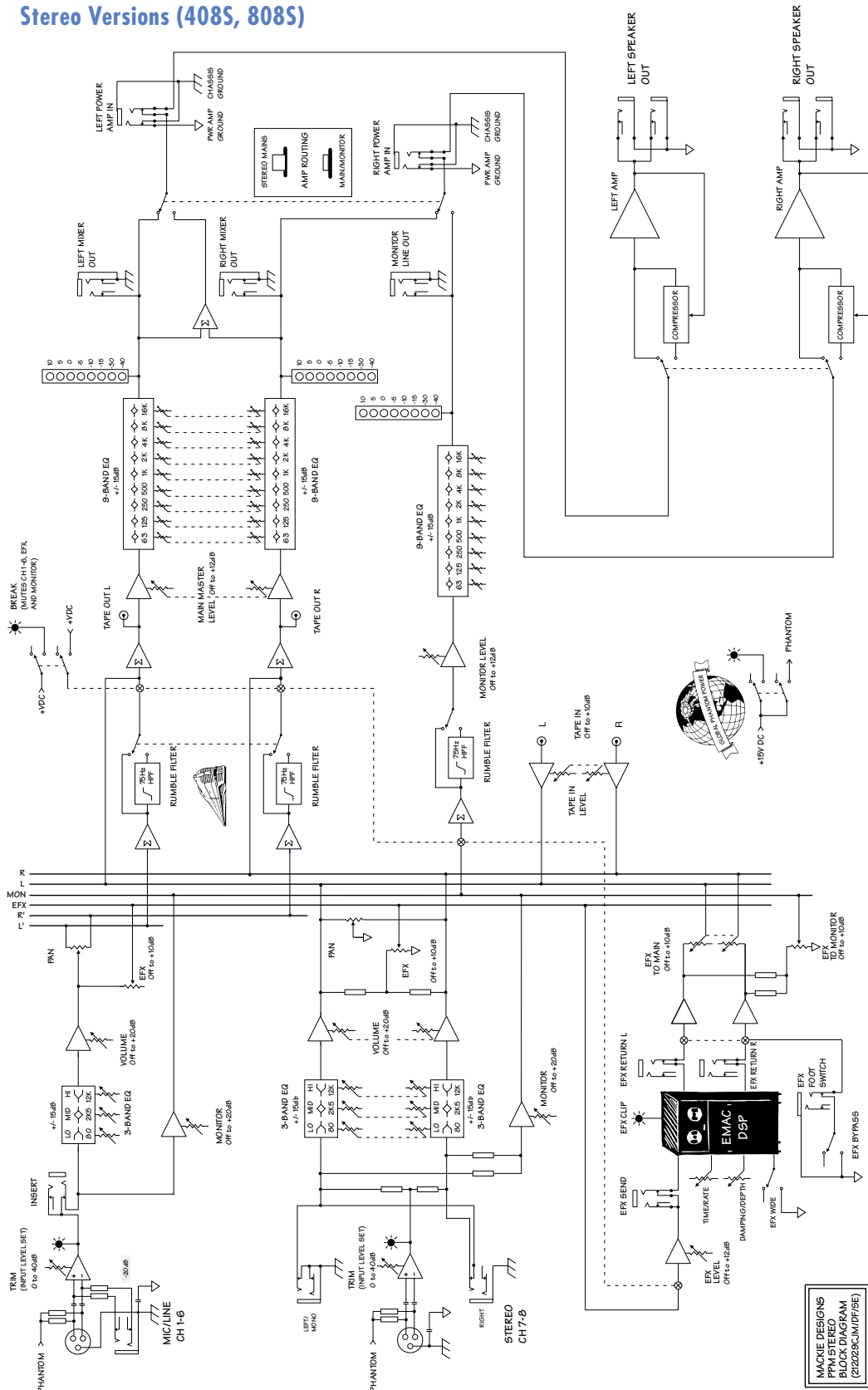

MACKIE DESIGN
PPM STEREO
BLOCK DIAGRAM
(210223CJ.MDF/SE)

Mono Versions (406M, 408M, 808M)

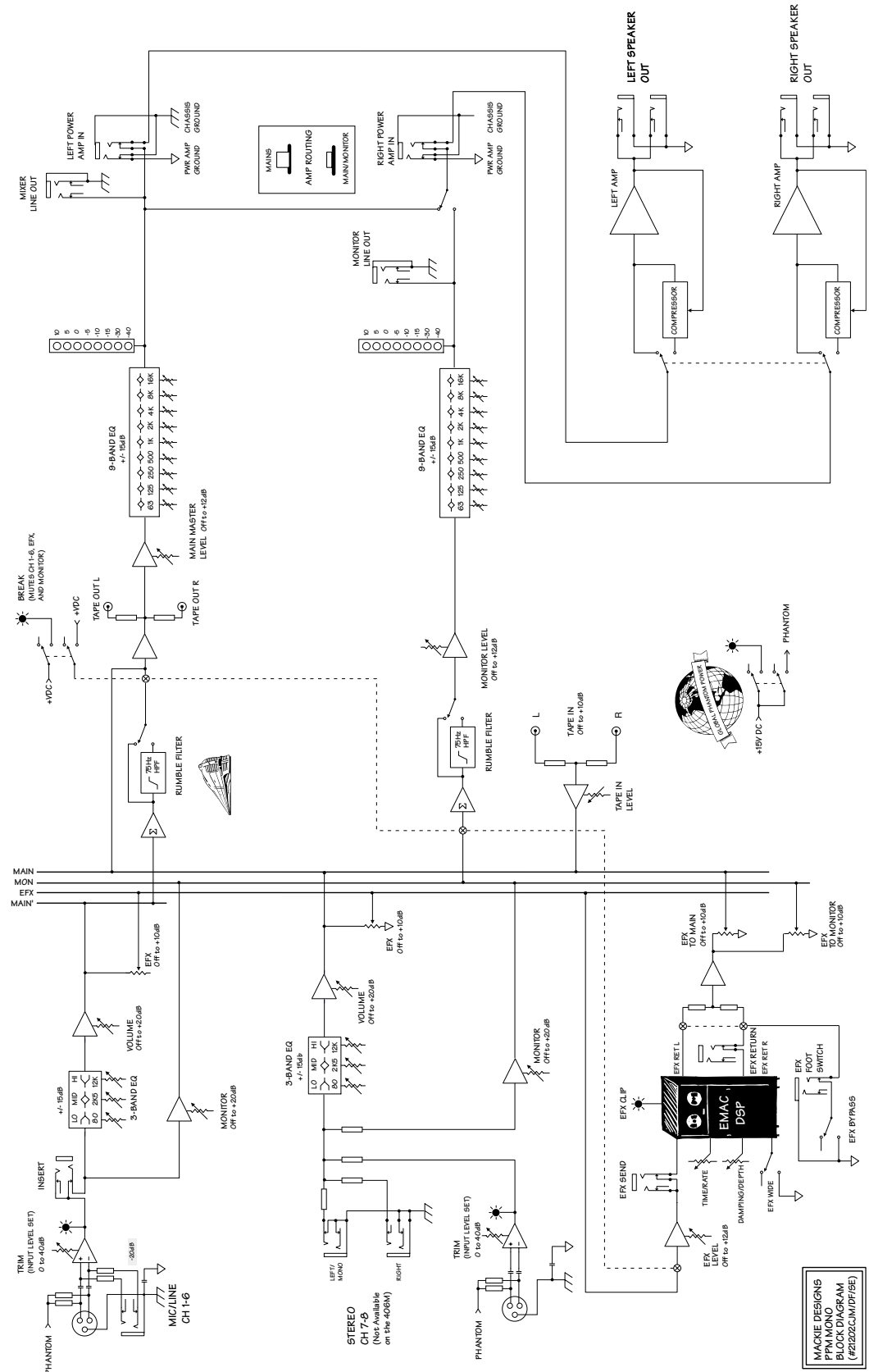

MACKIE DESIGNS
PPM MONO
BLOCK DIAGRAM
(#21202C/M/D/F/5E)



NOTES



*Some of the
people at our
factory who helped
design, build, sell,
and support your
product.*

MACKIE®

Mackie Designs Inc.

16220 Wood-Red Rd. NE • Woodinville, WA 98072 • USA
US & Canada: 800/898-3211

Europe, Asia, Central & South America: 425/487-4333

Middle East & Africa: 31-20-654-4000

Fax: 425/487-4337 • www.mackie.com

E-mail: sales@mackie.com