

User Guide

Signature 284

All Tube Class "A" Stereo Recording Amplifier and Direct Source



Unpacking and Inspection

After unpacking the Signature 284, save all packing materials in case you ever need to ship the unit. Thoroughly inspect the unit and packing materials for signs of damage. Report any shipment damage to the carrier at once; report equipment malfunction to your dealer.

Acknowledgement

The Signature 284 All Tube Class "A" Stereo Recording Amplifier and Direct Source was designed by John McIntyre, and is custom-manufactured for Lexicon by Actodyne General Inc.

Copyright ©1998 Lexicon Inc., All Rights Reserved.

Lexicon Inc. • 3 Oak Park • Bedford MA 01730-1441 USA • Tel: 781-280-0300 • Fax 781-280-0490 • www.lexicon.com

Lexicon Part # 070-12856

Contents

Introduction	1
Front Panel Controls	2
Power and Standby	2
Guitar Input	2
Gain	2
Getting the Feel of the Signature 284	3
Tone Controls (Bass, Midrange, Treble and Presence)	3
Volume	4
Getting the Tone You Want	5
Rear Panel Connections	6
Speaker Outputs	6
Slave Outputs	6
Recording Outputs	6
Effects Loop	7
Loop vs. Mixer Bus for Effects	7
Level Matching	7
Stereo Loop Examples	8
Dual Mono Effect	9
Mono Loop Example	9
Split Loop Examples	10
Rear Panel Guitar Input	10
Applications	11
General Notes	11
Direct Recording	11
Recording with Directs and Microphones	11
Low Volume Live Setup	12
High Volume Live Direct	12
High Volume Live Slave	12
Example Settings	13
Using the Signature 284 with non-Guitar Sources	15
Power Amp for Tube Warmth	15
Harp	15
Keyboards	15
Vocals	16
Acoustic Guitar	16
Digital Effects	16
Re-Amping	16
Precautions and Maintenance	17
Specifications	18

You know the moment — the one where the volume is cranked to the limit and the guitar player looks as though his guitar might be playing *him* — as though they're locked in some ritual combat in another zone entirely. Well, this trip doesn't require illicit drugs, a rare coincidence of zodiac signs, or even the rush of an audience — just you, your guitar and a fully cranked all-tube amp. If you've been there, you know. If you've seen it but never felt it, hold onto whatever's handy because the Signature 284 is your ticket to ride.

When a tube amp is turned way up, the amp's power section is pushed beyond the point where it's just making the preamp louder — the power tubes and transformer begin to add their own characteristic distortion and dynamic signatures to the sound.

This is where magic happens. The wide open amp becomes an expressive extension of the guitar, responding to your playing. You can control the amount of distortion and sustain simply by varying touch, or by making subtle adjustments to the guitar volume control. The bad news is that most tube amps are incredibly loud when they're turned up to this point. Larger amps (over 15 Watts or so) are so loud when you crank them up, that the loudness interferes with recording — the guitar sounds great, but it's bleeding into the drums, and the vocal mics — and you can forget about playing that loud at home.

The good news is that the Signature 284 was designed to solve this problem by delivering the touch and tone of a cranked up amp — without the bone crushing volume. It uses a low wattage power section — so when you crank it up to the point where the magic happens, the volume level is relatively low. The stereo power amp in the Signature 284 uses two EL 84s in a Class A configuration. Its output power is rated at 3 Watts (RMS) per side. (Don't be put-off by this seemingly small number. For recording or practicing at home, this amp is plenty loud — we measure >100dB SPL at 1 meter when used with our SB 210 cabinet.)

The low power design is the key to producing great sound at moderate volume levels —but it takes more than that to make a great amp. Other features include: high gain preamp (three 12AX7s), beautifully voiced tone controls, tube-driven stereo effects loop, balanced recording outputs, speaker simulators, and built-in passive loads for silent recording.

While it is designed primarily for recording, the Signature 284 is a great stage amp too. There are three ways to boost the volume: Mike the cabinet, use the recording outputs as a direct feed to the PA, or use the slave outputs to drive a larger power amp /guitar cabinet rig.

All of these applications, and more are described in this manual. Please take the time to look it over to make the most of your investment. We think that this is a great amp — and we hope you will too.



Front Panel Controls

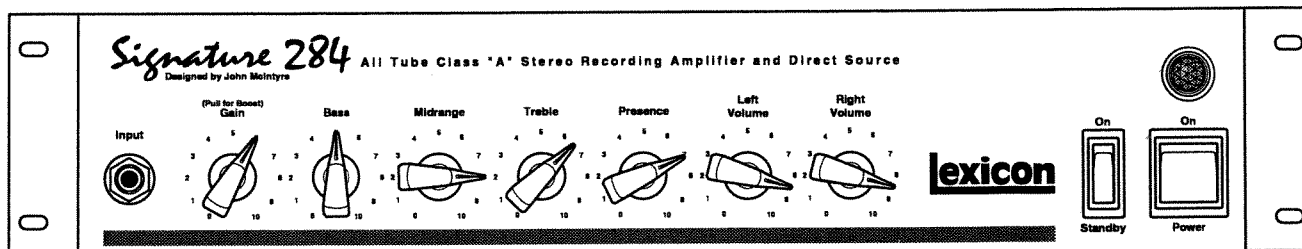

Power and Standby

As with any tube amp, you'll get the longest life from the tubes by using the Power and Standby controls properly.

The Standby switch should be in the standby position before turning the amp on with the Power switch. After switching the Power on, allow the amp to warm up for 30 seconds or so before switching Standby to On.

To protect speakers and other audio equipment connected to the Signature 284 (as well as your ears), switch the amp to Standby before inserting a guitar cord into the input jack. Do not switch out of Standby until all connections between the guitar and the amp (stomp boxes, etc.) have been made.

Switch to Standby whenever the amp will be idle for more than a few minutes (between sets, or when listening back to the mix). If the amp is not going to be used for an extended period of time (more than an hour or so), switch to Standby and turn Power off.

Guitar Input

Guitar Input jacks are provided at both the front and rear. Select *one* of these for your guitar input. (The rear panel input is provided as a convenience for custom installations — the input at the front panel overrides any input at the rear panel.)

Gain (Pull for Boost)

This is the preamp input sensitivity control. It controls the amount of preamp overload or distortion. For guitars with passive pickups, the cleanest tones can be found at settings from 1-4. As the knob is turned past 4, the amount of overload on your loudest notes will gradually increase.

The Gain knob is also a push/pull switch. Push the knob in for tones ranging from clean to vintage blues. Pull the knob out for tones that cover the range from vintage blues to modern, high gain distortion.

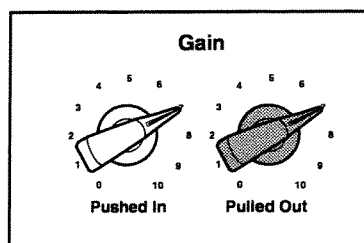

Throughout this manual, the drawings that represent the Gain control will be shaded to show the knob pulled OUT, unshaded to show it pushed IN.

Getting the Feel of the Signature 284

Like any classic tube amp, distortion is very dynamic in the Signature 284 — The amount of distortion is controlled by your playing style and dynamics. To get a cleaner sound, play a little lighter instead of changing the amp settings. To get more sizzle into a note or phrase, dig in as you pick it.

If you've never had the experience of working with a single channel tube amp before, the following may help you to get the hang of it. The basic idea is to use your guitar's volume control along with changes in your playing style to pull in any tone from clean to mean.

1. Switch to your loudest pickup and turn your guitar volume up to 10.
2. Set the Left and Right Volume controls to "7".
3. Play, and turn up the Gain control until you've got the amount of distortion or overdrive that fits your most aggressive style. (Pull out the knob for High Gain if that's your thing.)
4. Now, turn your guitar volume down to about 7 and experiment with varying your touch to get clean chords and lines. You'll find that you can cover the range of clean to bluesy overdrive just with touch.
5. Use the guitar volume control to "change channels." Use 7 as a clean/overdrive "rhythm channel" and 10 as an overdrive/distortion "solo channel".

Soon, you'll find you can set and forget the amp — and just focus on playing what you feel.

The tone controls on the Signature 284 are very powerful — even small adjustments can make big changes to the sound. There are no wrong settings. Whatever sounds good is right!

Each control covers a different band of frequencies. Bass, Midrange, and Treble are independent — changes made to one will not effect the others. The effect of the Presence setting is dependent upon the amount of Treble. If Treble is set to 0, Presence settings will have no effect. Increasing the Treble setting will increase the amount of Presence. (Note that the opposite is not true — changes to Presence have no effect on Treble.)

Here's a quick way to hear what each control contributes to the overall tone:

1. Set each of the tone controls to 0 and play. You will hear no sound. Now, turn Bass up and play. You will hear only the frequencies affected by the Bass control.
2. Turn Bass back to 0, turn up Midrange, and play. Now you hear only the frequencies controlled by Midrange. As Midrange controls the "meat" of guitar tones, this control has the most effect on the character of the sound.
3. Now, turn Midrange to 0, turn up Treble, and play to hear the frequencies affected by the Treble control.
4. Turn Treble to 0, turn up Presence and play. You won't hear anything, because the Presence control is dependent on the Treble control. Turn Treble back up, turn up Presence and play. Now you will hear the glassy top end added by this control.

Tone Controls (Bass, Midrange, Treble and Presence)

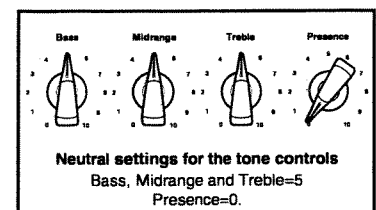

Volume The left and right volume controls are master input level controls for the Class “A” stereo power amp. These controls determine loudness, but, more importantly, they control the quality of the power amp’s contribution to the overall tone.

Many vintage amps have no master volume control — the input control sets both preamp sensitivity and the power amp level. Because of the fixed relationship of the preamp and power amp levels in vintage amps, the input control has to be turned up pretty high to reach the “sweet zone” where the power amp circuitry begins to sing. Also, the amount of preamp/power amp distortion at the sweet zone differs in many classic amps — giving each a distinct sonic signature. The Signature 284’s independent gain and left and right volume controls make it possible to dial-in a wide variety of classic and modern amp tones from a single guitar amplifier.

On a typical tube amp the sweet zone where this sonic magic happens doesn’t come in to play until the amp is cranked past 7 or so. Because the Signature 284 is designed with an extended sweet zone, you’ll find that even with clean preamp settings, the power amp begins to add it’s own character to the tone as the Volume controls are turned up past 5.

It is important to realize that the Volume controls of the Signature 284 should be used to dial in tone, not loudness.

The low power design is one of the main features that makes this a superb recording amp and direct source. When connected to a recording or PA mixer, loudness is determined at the console (fader settings, monitor send levels). When connected to guitar cabinets, the loudness is, of course, determined by the Left and Right Volume controls — but remember that, in the Signature 284, these are also powerful tone controls. Turning up to get louder, will also change the sonic character of the amp’s tone.

When connected to guitar cabinets, you’ll find that the Signature 284 has plenty of volume for home practice and recording overdubs. In fact, the essence of its design is to deliver the great tone of an big amp cranked up, without the bone crushing volume. This also means that, by itself, the Signature 284 cannot cover live drums or most club situations.

For more volume, you have several options:

- Mike the cabs connected to the Signature 284.
- Use the slave outs to drive a separate power amp/guitar cab rig.
- Use the recording to provide a direct feed to the PA.

Examples of each of these options are detailed in the **Applications** section of this manual.

Getting the Tone You Want

The sonic signatures of many different guitar sounds are based on power amp behavior as much as preamp gain and tone settings.

For modern high gain tones, use Gain Boost (pull out the Gain knob) to get lots of preamp distortion, but keep the power amps clean by setting the knob no higher than 4 or so. This will deliver a smooth, tight distortion with lots of definition.

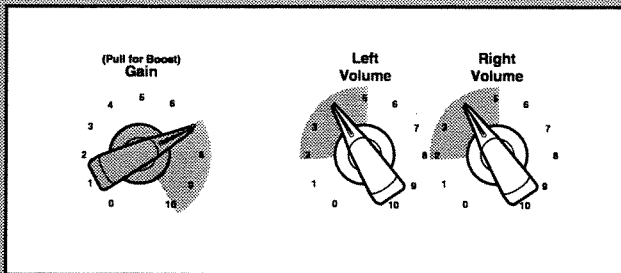

For vintage blues tones, keep the Gain in Normal mode (pushed in), but crank it up to 7 or so to push the power amps harder. You'll notice that the amount of "sag" (power amp compression) increases as you turn the Volume controls beyond 5. When set up this way, the Signature 284 is most responsive to nuances of touch and style — the tone is totally authentic, the voice is yours alone.

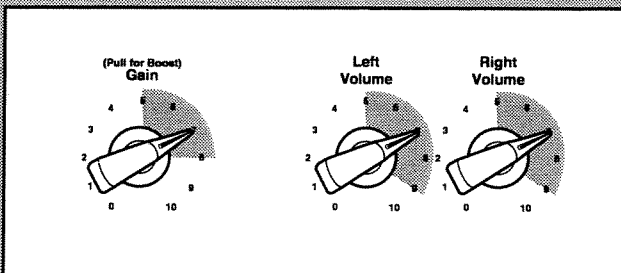

For tones that emphasize the Class "A" characteristics of the power amps, keep the Gain in Normal mode (pushed in) and set it below 5. Dial in some power amp distortion by setting the Volume controls above 5. Pushing the power amps this way creates a throaty quality — you'll also notice that the tone controls are very responsive when the amp is used this way.

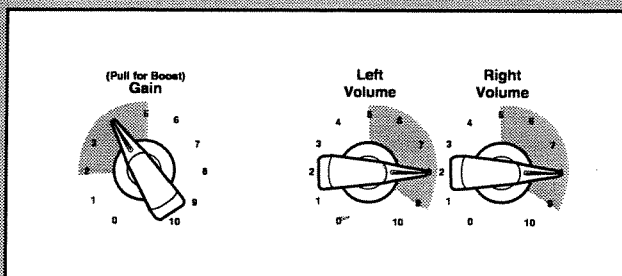

Rear Panel Connections

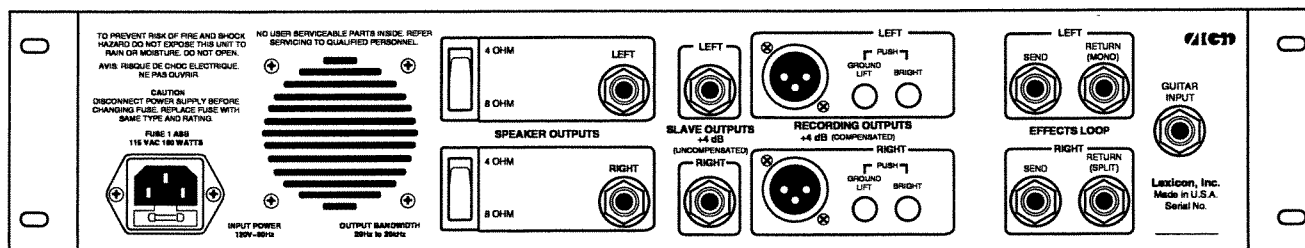

Speaker Outputs

You can drive any combination of 8 ohm and 4 ohm guitar cabinets from these connectors. Be sure that the ohm selector switch matches the rating for the connected cabinet. (You can, for example, connect an 8 Ohm cabinet to the left and a 4 Ohm cabinet to the right.)

Although the Signature 284 uses a low power design, it has plenty of power to drive any 1 or 2 speaker guitar cabinet rated at 4 or 8 Ohms. (4x12 half-stacks that can be split for stereo also sound great.) As the type of cabinet has a big effect on the overall sound, you can create many different tonal voices by changing cabinets. When using stereo effects, you will probably want to use matched cabinets for the left and right speakers, but be sure to experiment with using two different cabinets at once — a closed-back 10 and a open-back 12 can sound great together.

Disconnect speakers by removing the speaker cable from the amp, NOT the speaker cabinet.

The Signature 284 can be operated with either or both speakers disconnected. Independent passive loads are connected automatically when no jack is inserted into the speaker output.

Do NOT insert jacks into the rear panel speaker outputs when using the amp without speakers.

Slave Outputs

The slave outputs carry post power amp signals attenuated to line level (+4dB, unbalanced). Their primary purpose is to provide a means of getting more on-stage volume for live use by driving a stereo slave power amplifier connected to guitar cabinets. As these outputs are derived from the power amp outputs, they carry the voice and tone of the whole amp — exactly as sent to the speakers.

Connect the inputs of any high quality power amp (solid state or tube) to these outputs for a faithful (but louder) version of the Signature 284's sound.

Recording Outputs

These outputs are post power amp signals attenuated down to line level (+4dB, balanced) and run through a unique recording compensation circuit that simulates the sound of two different speakers. The primary function of these outputs is to provide a direct feed that is the sonic equivalent of a pair of well miked speaker cabs to a PA system or a recording console. A separate switch, provided for each recording output selects Smooth (think "4-12 cab") or Bright (think "2-10 cab"). A separate ground lift switch is provided for each recording output.

The Effects Loop is instrument level (-20dB instrument level) to allow use of stomp boxes or studio gear in the loop.

Effects Loop

The sends both carry the same signal ("y" cord from the preamp out). The returns are wired for stereo, mono, or parallel (split) operation:

- STEREO** For use with a single stereo effects processor or two mono effects processors (one on the left and the other on the right). Audio from two separate jacks can be routed independently to the left and right power amps via the left and right returns.
- MONO** For use with a mono effects processor feeding both left and right power amps. Audio from a single jack can be sent to both power amps at the same time. (Use the LEFT return only.)
- SPLIT** For use with a mono effects processor inserted in the right power amp and no effects in the left power amp. Audio from a single jack can be sent to the right while the left receives its signal directly from the preamp. (Use the RIGHT return only.)

In recording situations where you are tracking with effects, be sure to listen with the effects in the loop. There's a big sonic difference between inserting effects like delay, chorus, flange, reverb etc. in the effects loop of a guitar amp and adding them at the console. When inserted in the loop, the amp/speaker (or speaker simulators) add warmth, compression and some harmonic enhancement to the effects.

Loop vs. Mixer Bus for Effects

When using effects in the loop of any amp, it is very important to match the levels properly. A level mismatch can have a negative effect on the amps overall tone. As the Signature 284 is a stereo amp, you can match effects loop levels accurately by ear. Here's how:

Level Matching

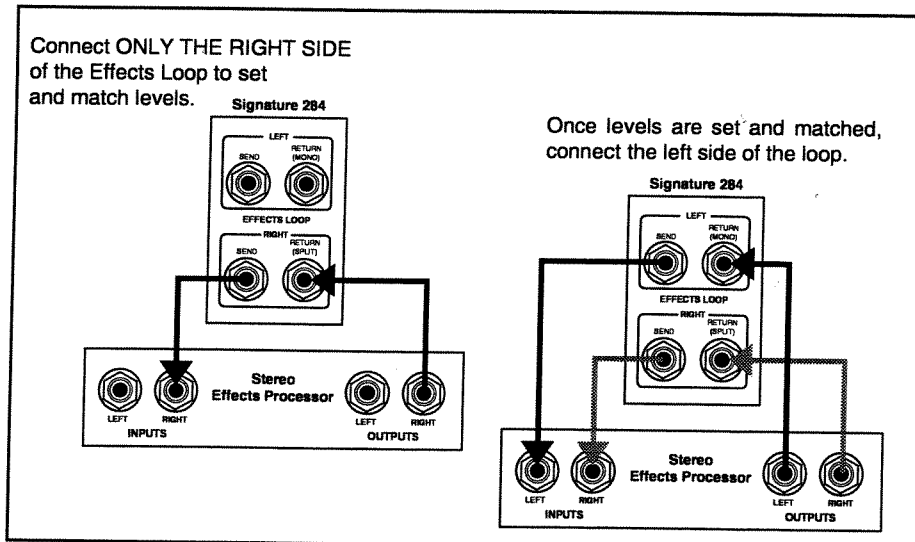

1. Turn both the input and output of the effect all the way down and bypass the effect.
2. Connect the right send of the Signature 284 to the mono (or right) input of the effect.

Rear Panel Connections

Lexicon

3. Connect the mono (or right) output of the effect to the right return of the Signature 284.
4. Set the guitar, preamp and the Left Volume control of the Signature 284 for your loudest playing.
5. Turn up the effect input control to optimum level.
6. Set the Right Volume control of the Signature 284 to the same position as the Left Volume. (No sound will be heard from the right side yet.)
7. Turn up the effect output control until the left level matches the right. (The effects unit is now properly set.)
8. Connect the second channel of the effect to left side of the loop.

Stereo Loop Examples

Stereo Effects Inserting a Stereo In-Stereo Out processor in the Signature 284 Effects Loop

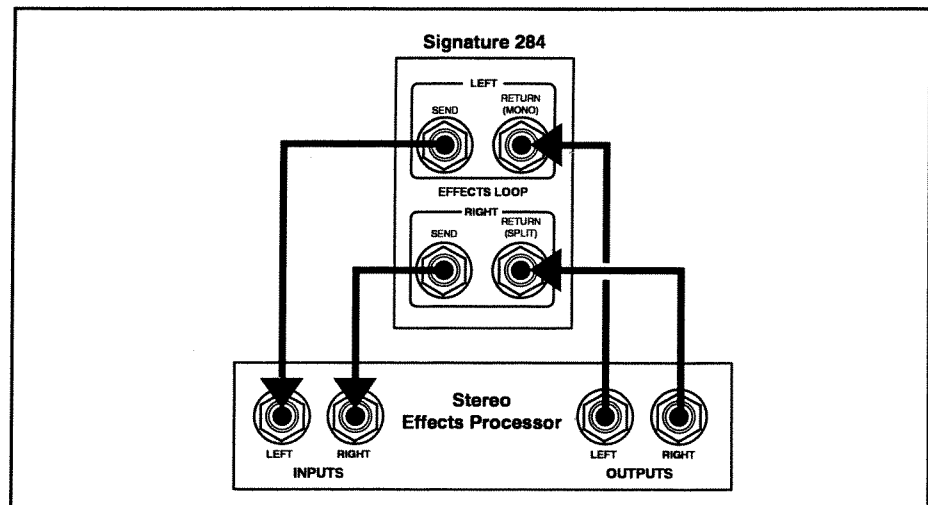

Inserting a Mono In-Stereo Out processor in the Signature 284 Effects Loop

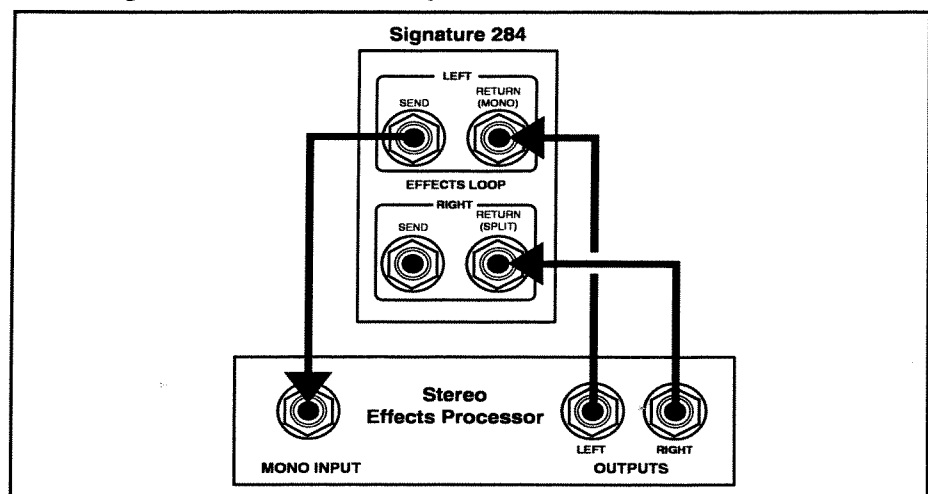

Inserting Two Mono Effects processors in parallel in the Signature 284 Effects Loop

Dual Mono Effects

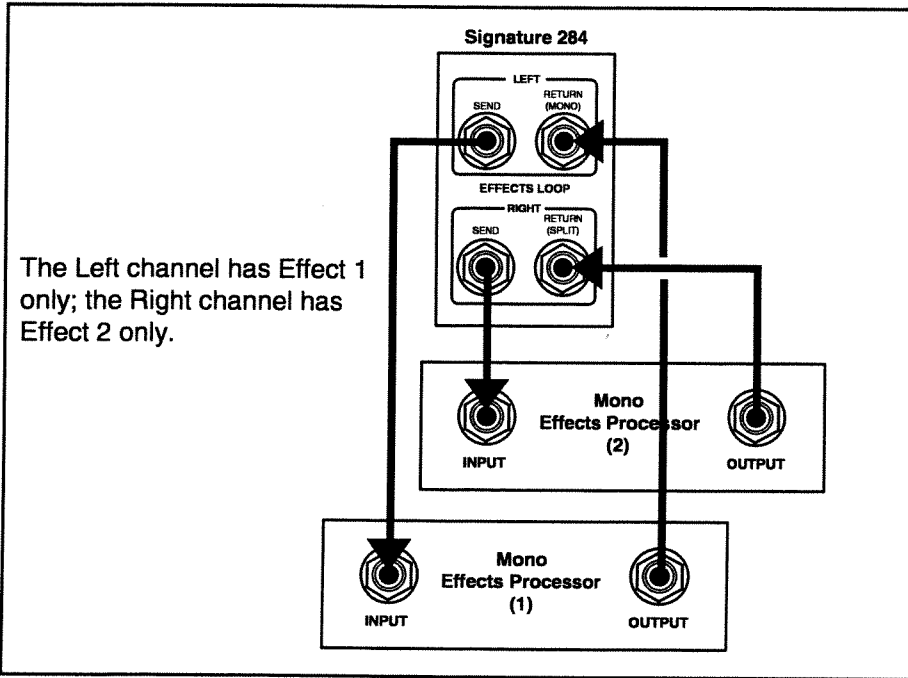

Inserting a Mono Effect in the Signature 284 Effects Loop

Mono Loop Example

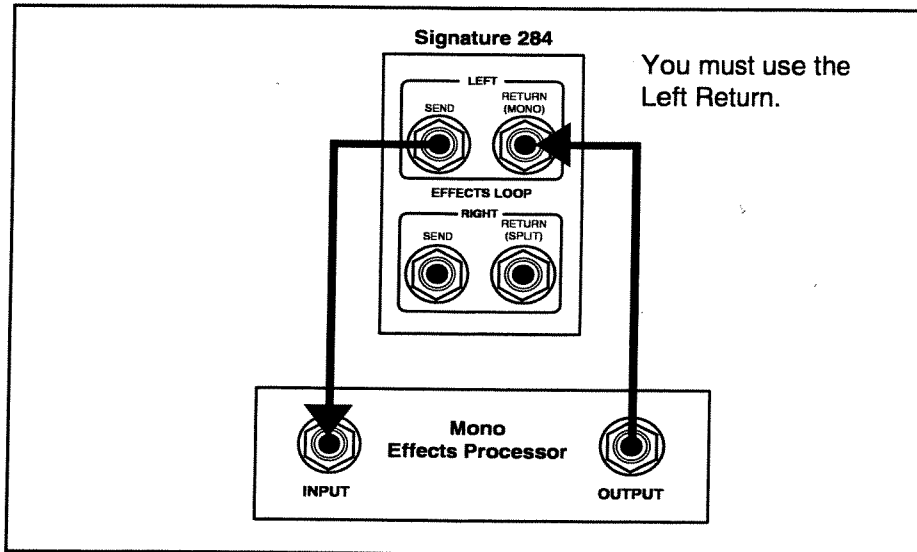

Rear Panel Connections

Lexicon

Split Loop Examples In a mono situation (live or laying down a mono track), try running the effects through only the right side (100% wet). This allows you to have two guitar feeds. The left is totally dry guitar, the right is guitar effects. In a live situation, this gives you the flexibility of adjusting the dry/effect balance from the console. When recording, it allows you to track with the effect and adjust the balance during the mix.

You can also think of this as a mono parallel loop. The right channel is unaffected guitar tone, the left channel is the effects level.

Creating a Split Loop with a Mono Effect inserted in the Signature 284 Effects Loop

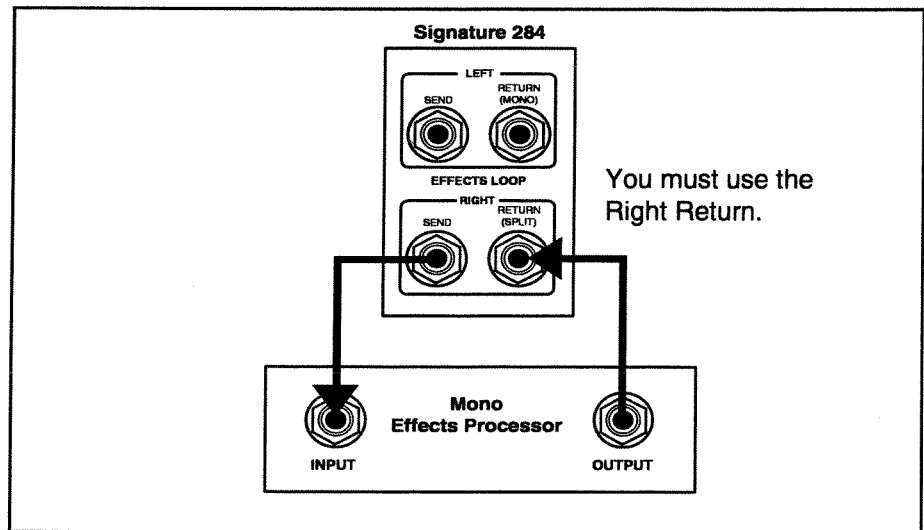

Rear Panel Guitar Input

Your guitar can be connected to the Signature 284 via either the front or rear panel input jacks. The rear panel input is provided as a convenience for custom installations. Plugging into the front panel input overrides any input connected at the rear panel input.

Applications

The Signature 284 is different from most amps in that it is optimized for recording vs. on-stage performance. Its low output power amp makes it possible to achieve great tone at low volume levels. Keep this in mind in situations where you need lots of on stage volume and remember to set the controls to produce the tone you want — not the loudness. Once you've dialed in the tone/distortion that you want, use a mixer or slave amp to create the volume level you need.

General Notes

When going direct, think of the left and right volume controls as additional tone controls rather than as volume controls. Use them to dial in the amount of power amp distortion you want in your sound. Set your levels at the channel fader(s) of the console.

In most live situations, you'll need to reinforce the loudness of the 284. The slave amp and recording outputs are provided for that purpose. Use the recording outputs to feed the mixing console. Reinforce the front-of-house and stage monitor mixes from the console (as you would with a miked guitar cabinet). Use the slave outs to feed a separate power amp and guitar cabs to get louder on-stage volume. Remember that the slave outs are post power amp — so all of the characteristics of the 284's class A power stage are present in the signal. You can get great results running into a solid state power amp/guitar cab rig.

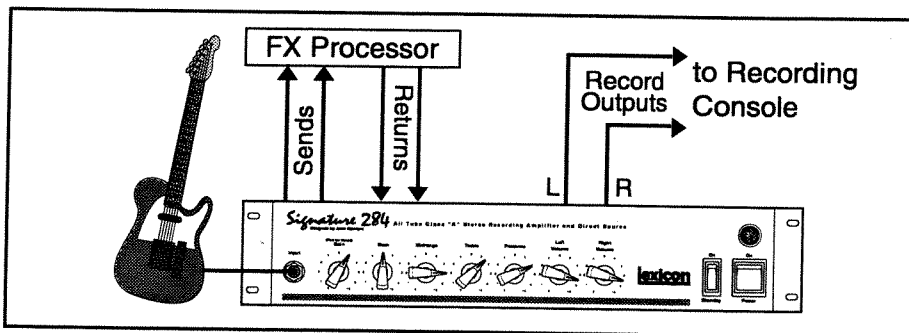

Direct recording

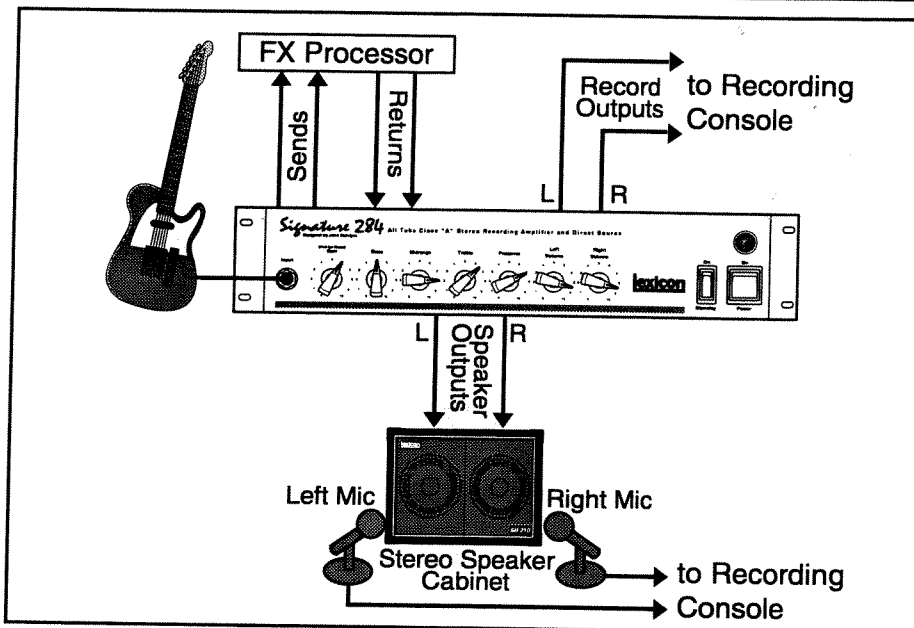

Recording with direct outputs and microphones

Applications

Lexicon

Low volume live setup

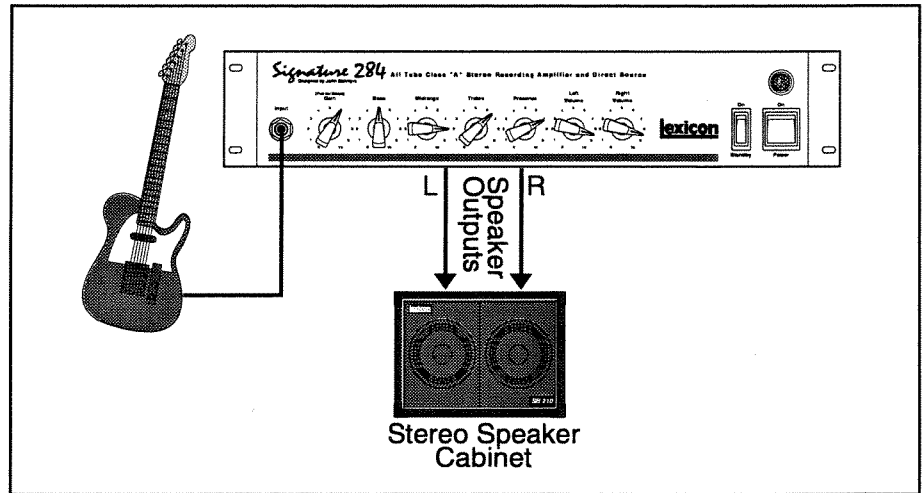

High volume live direct

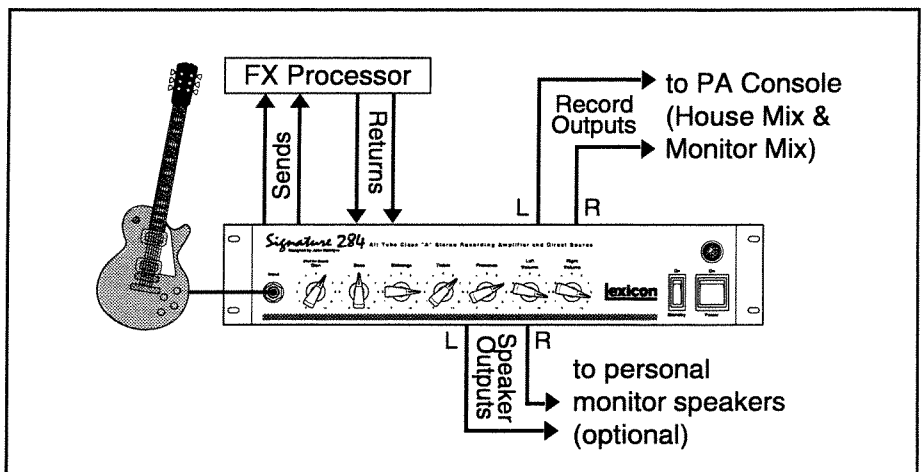

High volume live slave

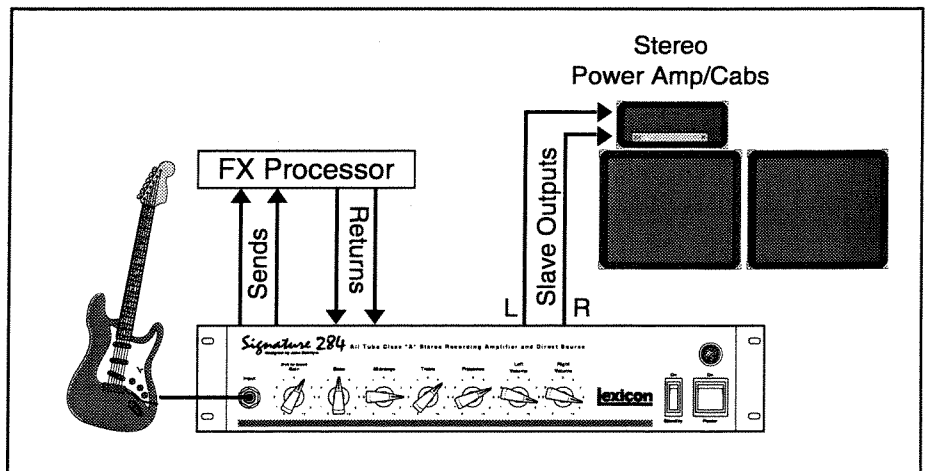

Here are some settings for you to try. Guitar and pickup types are shown if they contribute significantly to the sound.

Example Settings

1 Clean

Stratocaster/Neck pickup

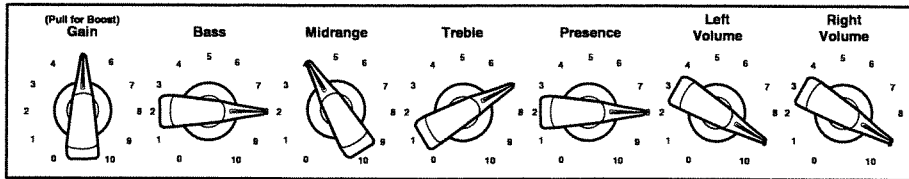

(Push) 5 8 4 7 8 9 9

2 Clean Funk

Stratocaster/Bridge and Neck pickups

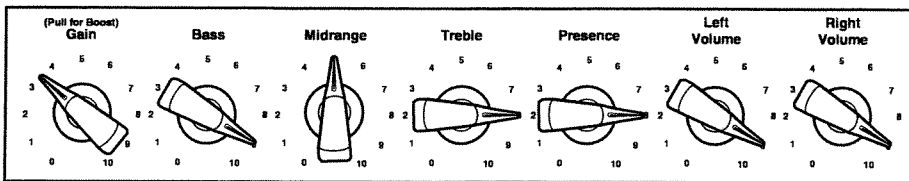

(Push) 3.5 9 5 8 8 9 9

3 Clean Country

Stratocaster, Telecaster

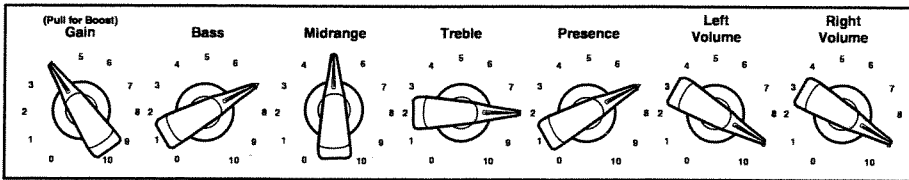

(Push) 4 7 5 8 7 9 9

4 Jazzy

Single-coil, Humbucker

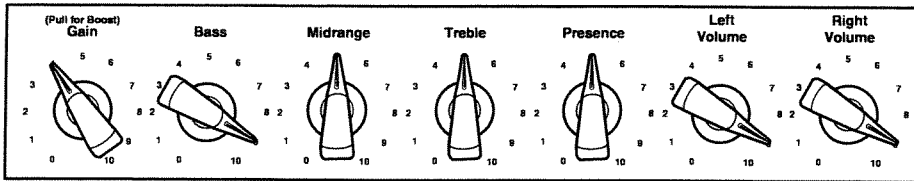

(Push) 4 9 5 5 5 9 9

5 60's Vox

Humbucker (Bridge)

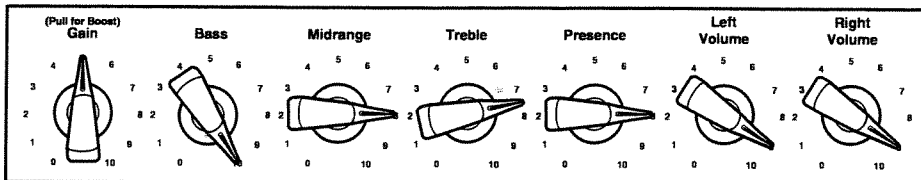

(Push) 5 10 8 7.5 8 9 9

6 Texas Blues Stratocaster/ Neck

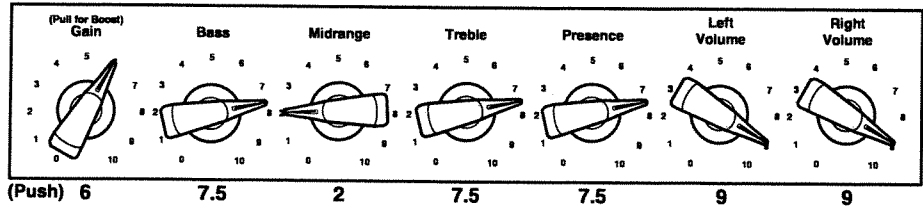

7 80's Marshall Humbucker (Bridge)

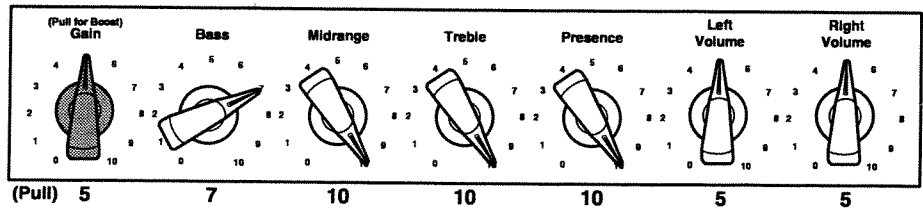

8 High Gain Humbucker (Neck and Bridge)

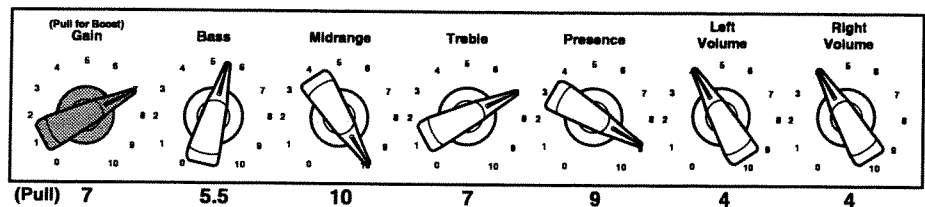

9 Singing Lead Stratocaster/Neck

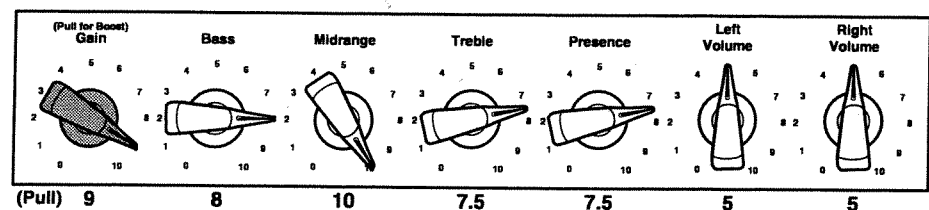

10 One Size Fits All

Any pickup, any type music

(Use guitar volume control to go from Clean to High Gain)

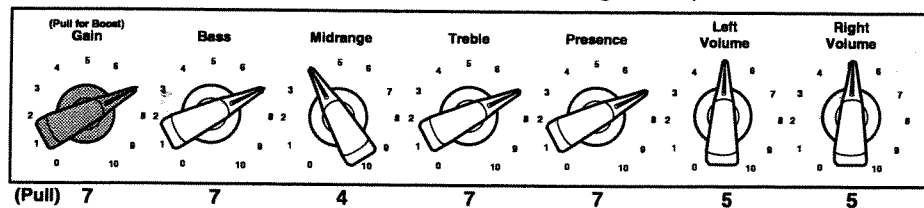

Although designed primarily for guitar, the Signature 284 can be quite useful for processing other sources. Its rack mount design, effects loop, multiple stereo outputs and the ability to operate with no speakers connected make it quite a versatile tube processor for stage or studio.

Using the Signature 284 with non-Guitar Sources

Once the Signature 284 is wired into your studio, you'll find that it can be pretty useful as a stereo tube processor. Use it to add warmth, compression, and the characteristic harmonic distortion of Class "A" tube amplification, to any source. Run stereo sources into the effects returns and use the Left and Right Volume controls to set the tone of the power amp. Unless you're pushing the power amps into distortion, you can use the Slave outputs as well as the Recording outputs for bringing audio back into the console. Each has its own characteristic sound (The Recording outputs have a compensation circuit that simulates the signatures of different speakers, while the Slave outputs have no compensation circuit and therefore a flatter overall signal response.)

Power Amp for Tube Warmth

The small size and big tone of the Signature 284 make it a perfect harp amp. In fact, the Signature 284 can be the center piece of the ultimate jamming rig. All you need are your harps, a high-impedance microphone and the Signature 284, and you're ready to sit in.

Harp

When using the Signature 284 as a harp amp, you'll find that it has more than enough gain for even the raunchiest tone. To start out, keep things pretty clean: Gain pushed in and set to 3-4, Left and Right Volume at around 5.

To add more grit and compression, experiment with the effect of raising either the Gain control (for more preamp distortion), or the Volume controls (for more power amp distortion). Both types of sound lend themselves well to harp.

For live performance, speaker cabs are optional. The recording outputs provide no-compromise direct feeds to the house PA and stage monitors.

In the studio, there's never been an easier way to get "the sound" onto tracks. As with guitar, you can go direct, mic cabinets, or use a combination of both. If you track with reverb or other effects, take advantage of the stereo effect loop to insert the reverb between the preamp and power amps.

Lead Synth

Need to add a searing edge to a lead synth track? One trick is to run the synth through a guitar amp. Go easy on the distortion at first - just running the synth through the Signature 284 set for "clean" will produce a dramatic effect. If you're tracking with effects, insert them in the effects loop.

Keyboards

Stereo Keyboards

Many digital keyboards can benefit from the addition of some tube warmth. One obvious candidate for "tubification" is any organ sound, particularly B-3 with rotary speaker. Run the stereo outputs of the synth into the effects returns of the Signature 284, connect the Recording outputs to the mixer and set the Volume controls to dial in an appropriate amount of "grind".

Vocals Looking for a more radical effect than can be obtained with a tube mic preamp? Depending on how drastic you want to be, run the vocal through either the Guitar input (easy on the gain!) or the effects return.

Acoustic Guitar Here again, the Signature 284 has something to offer as an alternative way to process a source. There are several approaches — all yield different, but musical, results. If the acoustic guitar is a mono source, be sure to experiment using the guitar input, gain and tone controls as well as bypassing the preamp altogether and running directly into the power amps via the effects returns. If the guitar is stereo, patch into the effects returns. In either case, be sure to compare different sounds obtainable from the Slave and Recording outputs.

Digital Effects You can use the Signature 284 to “warm up” the characteristically cold sound of some digital effects processors. Connect the stereo outputs of the processor to the stereo effects returns of the Signature 284. Set the Volume controls to 5 or less. Different results will be obtained from the Slave and Recording outputs - be sure to compare.

Re-Amping Re-amping a guitar track means to take a previously recorded guitar track and process it through a guitar amp. This is not often done, but sometimes it's nice (or necessary) to go back and change the settings on the amp after the track has been laid down. The best way to do this is to record a separate track of direct (unamplified) guitar along with the amplified track. To do this, use a good quality, active direct box to split the guitar signal before it gets to the amp. (You must use an active direct box — as opposed to a passive Y-cord — so that the guitar amp input “sees” the correct impedance.) It's your choice as to whether to connect the direct box before or after any stomp boxes that are used between the guitar and the amp input.

Set the amp as you normally would, but when you hit RECORD, always record the direct guitar on a separate track. Once the track has been recorded, you have the option of replacing or augmenting the amplified track with additional versions of the original performance run through different amplifier settings and effects.

Precautions and Maintenance

The Signature 284 requires no maintenance. It is, however, good electrical practice to clean all connectors once a year. An occasional dusting of the exterior surface with a soft cloth helps maintain the unit's finish. Do not use any abrasive chemicals or cleaners as these will damage the surface.

Most tube amp problems are in the tubes themselves. A simple swapping of tubes can save a great deal of time, trouble and frustration. Although tube replacement is a simple procedure, it should be performed by experienced technicians.

General Maintenance

**The Signature 284 contains no user-serviceable parts.
Refer all service to qualified technical personnel!**

- Do not expose amplifier to moisture, rain, water, direct sunlight or extreme temperatures.
- Connect amplifier only to an AC power supply that meets the specifications listed on the rear of the unit.
- Always ensure that the amplifier is properly grounded.
- Make sure that the amplifier has adequate air circulation near the rear vents.
- To avoid damage to speakers and other playback equipment, turn off the power to all equipment before making connections.
- Do not use excessive force in handling controls.
- Remove the power plug from the AC mains if the amplifier is to be stored for an extended period of time.
- Disconnect the AC Power Cord before removing the cover for service.
- Avoid direct contact with heated tubes.

Precautions

Specifications

- Preamp** Tubes: 3 x 12AX7
Gain: pull for boost
Tone Controls: Bass, Midrange, Treble, Presence
- Effects Loop** Stereo send: 2 x 1/4" unbalanced, -20dB
Stereo return: 2 x 1/4" unbalanced. -20dB
- Power Amp** Type: Stereo, Class "A"
Tubes: 2 x EL 84
Power: 2 x 3 Watts RMS
Controls: Left Volume, Right Volume
- Outputs** Speakers: Left (8/4 Ω), Right (4/8 Ω)
Separate passive loads for left and right speaker outputs
- Recording: 2 x XLR, balanced, +4dB
Compensation: separate speaker simulators (smooth, bright)
Separate ground lift switches (push for ground lift)
- Slave: 2 x 1/4" unbalanced, +4dB
No compensation
- General** Dimensions: 19.0" x 3.50" x 10.5"
19" rack mount standard, 2U high
Weight: 24 lbs
Power: 115 VAC, 60Hz, 100 Watts
Safety Compliance: CLA (City of Los Angeles)

Specifications subject to change without notice.

Limited Warranty

Lexicon Incorporated offers the following warranty on the Signature 284 Amplifier.

Duration of the Warranty

This warranty will remain in effect for one (1) year from the date of original purchase. Tubes provided with the original unit are warranted to be free from defects for six (6) months from the date of original purchase.

Who May Enforce the Warranty

This warranty may be enforced by the original purchaser and subsequent owners during the warranty period, so long as the original dated sales receipt or other proof of warranty coverage is presented when warranty service is required.

What is Covered and What is Not Covered

Except as specified below, this warranty covers all defects in material and workmanship in this product. The following are *not* covered by the warranty:

1. Damage resulting from:
 - A. Accident, misuse, abuse, or neglect.
 - B. Failure to follow instructions contained in your Owner's Manual.
 - C. Repair or attempted repair by anyone not authorized by Lexicon.
 - D. Failure to perform recommended periodic maintenance.
 - E. Causes other than product defects, including lack of skill, competence, or experience of user.
2. Damage occurring during any shipment of this product (claims must be presented to the carrier).
3. Damage to any unit which has been altered or on which the serial number has been defaced, modified, or removed.

What We Will Pay For

We will pay all labor and material expenses for covered items. Payment of shipping charges is discussed in the next section of this warranty.

How You Can Get Service

If your unit needs service, please write or telephone us and we will advise you where the unit should be taken or sent. If you write us, include your name, complete address, daytime telephone number and description of the problem(s). ***Please do not return your unit to the factory without our prior authorization.***

If it is necessary to ship the product for service:

- A. You must pay for any initial shipping charges, but if the necessary repairs are covered by the warranty, we will pay the return shipping charges via a carrier of our choice to any destination within the United States.
- B. The unit should be packed securely, and we suggest that it be insured.
- C. Do not include accessories such as power cords or manuals.

Whenever warranty service is required, a copy of the original dated sales receipt must be presented.

Limitation of Implied Warranties

Any implied warranties, ***including warranties of merchantability and fitness for a particular purpose***, are limited in duration to the length of this warranty.

Exclusion of Certain Damages

Lexicon's liability for any defective product is limited to repair or replacement of the product, at our option. Lexicon shall not be liable for:

1. Damages based upon inconvenience, loss of use of the product, loss of time, interrupted operation, commercial loss; *or*
2. Any other damages, whether incidental, consequential, or otherwise.

How State Law Relates to the Warranty

Some states do not allow limitation on how long an implied warranty lasts and/or do not allow the exclusion or limitations of incidental or consequential damages, so the above limitations may not apply to you.

This warranty is not enforceable outside of North America. This warranty gives you specific legal rights, and you may also have other rights which vary from state to state.

Lexicon Inc.
3 Oak Park
Bedford MA 01730-1441 USA
Telephone 781-280-0300
Fax 781-280-0490
www.lexicon.com

Lexicon Part # 070-12856