

960L *Digital Effects System*

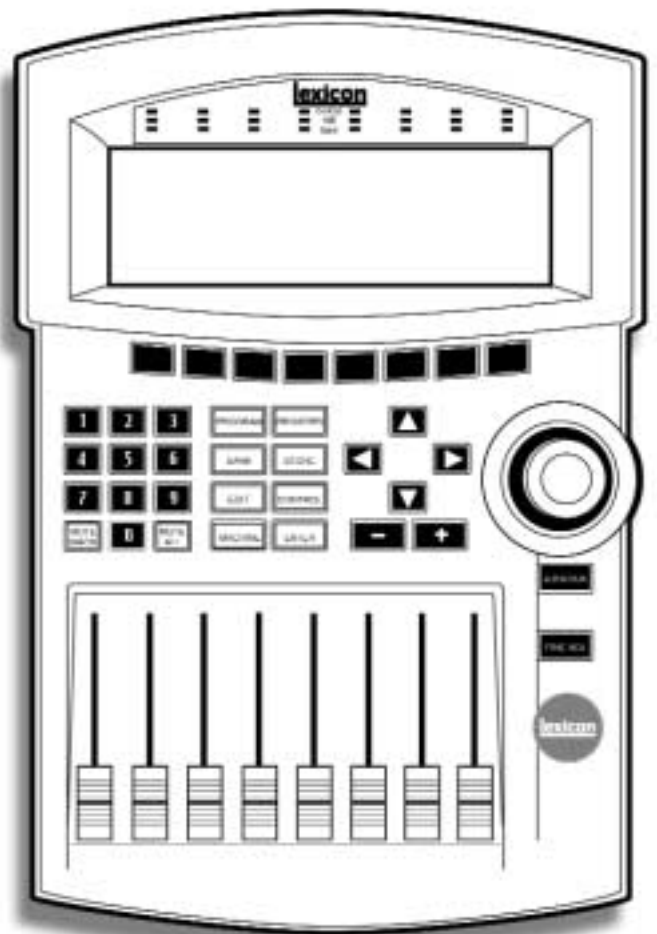

Owner's Manual

Important Safety Instructions

Save these instructions for later use.

Follow all instructions and warnings marked on the unit.

Always use with the correct line voltage. Refer to the manufacturer's operating instructions for power requirements. Be advised that different operating voltages may require the use of a different line cord and/or attachment plug.

Do not install the unit in an unventilated rack, or directly above heat producing equipment such as power amplifiers. Observe the maximum ambient operating temperature listed in the product specification.

Slots and openings on the case are provided for ventilation; to ensure reliable operation and prevent it from overheating, these openings must not be blocked or covered. Never push objects of any kind through any of the ventilation slots. Never spill a liquid of any kind on the unit.

This product is equipped with a 3-wire grounding type plug. This is a safety feature and should not be defeated.

Never attach audio power amplifier outputs directly to any of the units connectors.

To prevent shock or fire hazard, do not expose the unit to rain or moisture, or operate it where it will be exposed to water.

Do not attempt to operate the unit if it has been dropped, damaged, exposed to liquid, or if it exhibits a distinct change in performance indicating the need for service.

This unit should only be opened by qualified service personnel. Removing covers will expose you to hazardous voltages.

Notice

This equipment generates and uses radio frequency energy and if not installed and used properly, that is, in strict accordance with the manufacturer's instructions, may cause interference to radio and television reception. It has been type tested and found to comply with the limits for a Class A computing device in accordance with the specification in Part 15 of FCC Rules, which are designated to provide reasonable protection against such interference in a residential installation. However, there is no guarantee that interference will not occur in a particular installation. If this equipment does cause interference to radio or television reception, which can be determined by turning the equipment OFF and ON, the user is encouraged to try to correct the interference by one or more of the following measures:

Reorient the receiving antenna

Relocate the units with respect to the receiver

Move the units away from the receiver

Plug the unit into a different outlet so that the unit and receiver are on different branch circuits.

If necessary, the user should consult the dealer or an experienced radio/television technician for additional suggestions. The user may find the following booklet prepared by the Federal Communications Commission helpful:

"How to identify and Resolve Radio/TV interference Problems"

This booklet is available from the U.S. Government Printing Office, Washington, DC 20402, Stock No. 004-000-00345-4.

This triangle alerts you to important operating and maintenance instructions in this accompanying literature



CAUTION
RISK OF ELECTRIC SHOCK
DO NOT OPEN

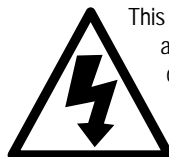

This triangle, which appears on your component, alerts you to the presence of uninsulated, dangerous voltage inside the enclosure; voltage that may be sufficient to constitute a risk of shock.

"Dolby", "Dolby Surround", "Pro Logic", and "Dolby Digital" are trademarks of Dolby Laboratories.
"Super Audio CD" and "SACD" are trademarks of Sony Electronics, Inc. "THX" and "Home THX Cinema" are trademarks of Lucasfilm, Ltd.

"Logic7", "LexiconLogic", and "3DPM" are trademarks of Lexicon, Inc.

Copyright © 2000
All Rights Reserved.

Lexicon Part No. 070-14353

Lexicon Inc.
3 Oak Park
Bedford, MA 01730 USA
Telephone 781-280-0300
Fax 781-280-0490

Table Of Contents

Chapter 1		Chapter 3	
DESCRIPTION	1-1	AN OVERVIEW OF THE CONTROLS	3-1
About the 960L	1-1	A QUICK GUIDE TO OPERATION	3-2
Unpacking the 960L	1-1	(1) Setup (Control Mode)	3-2
THE REAR PANEL	1-1	(2) Machine Selection	3-5
I/O Clock Card	1-2	(3) Program Loading	3-5
Option Plates	1-2	(4) Editing a Program or Register	3-6
Analog Input Card	1-2	(5) Storing Your Edits	3-6
Analog Output Card	1-2		
AES I/O Card	1-2	Chapter 4	
Mains Power Switch.	1-2	LOADING PROGRAMS AND REGISTERS	4-1
Mains Voltage Selector	1-2	Loading Programs	4-1
IEC Power Connector	1-2	Loading Registers	4-2
THE FRONT PANEL	1-3	CONTROL MODE: CLOCKS, CONFIGURATION, AND SYSTEM SCREENS	4-3
Floppy Drive	1-3	Wordclock	4-3
Thumbscrews	1-3	Input, Output, and Machine Configuration	4-4
Standby Switch and Indicator	1-3	System Screen	4-8
BEHIND THE FRONT PANEL	1-4	EDITING	4-9
DSP-Card Slots	1-4	Editing Algorithms	4-9
CPU Card	1-4	Editing With the Faders	4-9
INSTALLATION	1-5	Fine Adjust	4-9
Mounting	1-5	Editing with the Joystick	4-10
Ventilation	1-5	Quick Comparisons via the Lexicon Button	4-10
Location	1-5	Editing Inputs and Outputs	4-11
IEC Power Connector	1-5	Input Panning	4-11
Mains Voltage Selector	1-5	Output Panning	4-12
Analog Audio Connections	1-5	The 960L Surround Panning Rules	4-13
Digital Audio Connections	1-6	Setting Levels	4-13
MIDI Connections	1-6	Avoiding Overload	4-13
WordClock Connections	1-6	Assigning New Parameters to Faders or the Joystick	4-13
Chapter 2		The V-Page and Parameter Reassignment	4-14
THE LARC2	2-1	Using the Edit Algorithm Screen	4-14
About the LARC2	2-1	STORING AND LABELING YOUR EDITS	4-16
Unpacking The LARC2	2-1	Storing	4-16
LARC2 CONTROL SURFACE	2-2	Naming and Annotating	4-16
GETTING WHAT YOU WANT	2-3	ORGANIZING YOUR REGISTERS	4-17
LARC2 CONNECTIONS	2-3	Edit Tools for Registers	4-18
Control Port	2-3	Using the Floppy Drive	4-18
Aux Port	2-3	THE CD-ROM	4-18
External-Power Connector	2-3	MACHINE MODE	4-18
NAVIGATING TYPICAL DISPLAY SCREENS	2-4		
ABOUT THE FADERS AND JOYSTICK	2-5		
AUDIO INDICATORS	2-6		
FINE ADJUST	2-6		
THE LEXICON BUTTON	2-6		

Table Of Contents, continued**Chapter 5**

REVERBERATION AND REALITY	5-1
SOUND IN SPACE: A SHORT HISTORY OF STEREO AND SURROUND	5-5
ALGORITHMS	5-6
Random Hall	5-6
Surround Hall	5-7
Chamber	5-7
Plate & Surround Plate	5-7
Ambience & Surround Ambience	5-7
Ambient Chamber	5-8
Reverse & Surround Reverse	5-8
Inverse	5-8
PARAMETERS USED IN THE 960L ALGORITHMS	5-9

Chapter 6

MIDI	6-1
Nomenclature	6-1
MIDI Channel Allocation	6-1
Program Loading	6-2
Bank and Program Mapping	6-2
Card Configuration	6-2
Continuous Controllers	6-2
MIDI SYSEX	6-3
MIDI IMPLEMENTATION CHART	6-4
SPECIFICATION	
Mainframe	
LARC2	
APPENDIX	

Title of Section

Introduction

The Model 960L is a multi-channel reverb processor for audio professionals. It brings to surround all the virtues and facilities of the Model 480L— and then some. Like the 480L, it is a multiple-machine system — hardware and software expandable. The 960L's DSP card can support up to four stereo reverbs or two multi-channel surround reverbs at 48 Hz, or two stereo reverbs at 96 kHz. The 960L provides eight balanced inputs and outputs, eight channels of AES/EBU digital input and output, external word clock in/out, and MIDI In/Out/Thru.

The 960L is controlled by a new, dedicated remote, the LARC2. Its user interface is fashioned after the original LARC controller, so 480L users can get up to speed quickly, but it was also designed for fast, intuitive operation by those who have never used the 480L. Extensive visual feedback and a wide variety of input

devices (hard and soft buttons, motorized faders, and a joystick) provide access to everything you need to control.

The 960L and LARC2 were designed for maximum flexibility and control. The 960L's reverberation algorithms, based on Lexicon's 3DPM™ (for 3-Dimensional Perceptual Modeling) technology, embody the accumulated knowledge of more than 20 years of research and study into how humans perceive spaces.

With the 960L, engineers working in surround can create convincing 5.1-channel spaces — even spaces that sound better than real ones — from a reverb designed for the purpose, rather than an unconvincing assemblage of multiple stereo and mono reverbs. The 3DPM™ algorithms Lexicon developed for the 960L take the principles of physics and psycho-acoustics into account.

1

The Mainframe

DESCRIPTION	1-1
About the 960L	1-1
Unpacking the 960L	1-1
THE REAR PANEL	1-1
I/O Clock Card	1-2
Option Plates	1-2
Analog Input Card	1-2
Analog Output Card	1-2
AES I/O Card	1-2
Mains Power Switch.	1-2
Mains Voltage Selector	1-2
IEC Power Connector	1-2
THE FRONT PANEL	1-3
Floppy Drive	1-3
Thumbscrews	1-3
Standby Switch and Indicator	1-3
BEHIND THE FRONT PANEL	1-4
DSP-Card Slots	1-4
CPU Card	1-4
INSTALLATION	1-5
Mounting	1-5
Ventilation	1-5
Location	1-5
IEC Power Connector	1-5
Mains Voltage Selector	1-5
Analog Audio Connections	1-5
Digital Audio Connections	1-6
MIDI Connections	1-6
WordClock Connections	1-6

Description

About the 960L

The 960L system consists of two components: a rack-mounted Mainframe designed for remote mounting in machine rooms or elsewhere, and a dedicated controller, the LARC2.

Unpacking the 960L

The 960L system is shipped in two cartons, one containing the 960L mainframe, the other containing the LARC 2 dedicated controller. After unpacking, save all packing materials in case you ever need to ship the unit. Thoroughly inspect the 960L system and packing materials for signs of damage. Report any shipment damage to the carrier at once. The following accessories are packed with the 960L Mainframe (for the LARC2 carton, see Chapter 2):

- Lexicon 960L Mainframe, with cards installed
- IEC power cord
- CD-ROM, 960L Software
- This User Guide
- Warranty and Registration Cards
- CE compliance certificate
- License Agreement
- Bumper feet (4)

The Rear Panel

The 960L mainframe's rear panel holds four I/O cards, together with power connections, the mains power switch, mains voltage selector switch and option plates. The I/O cards can be removed for service and/or upgrades without removing the chassis from the rack.

The proper ordering (top to bottom) of the cards is I/O Clock Card, I/O Option Plate, AES I/O Card, Analog In Card and Analog Out Card. Cards should be kept in this order.

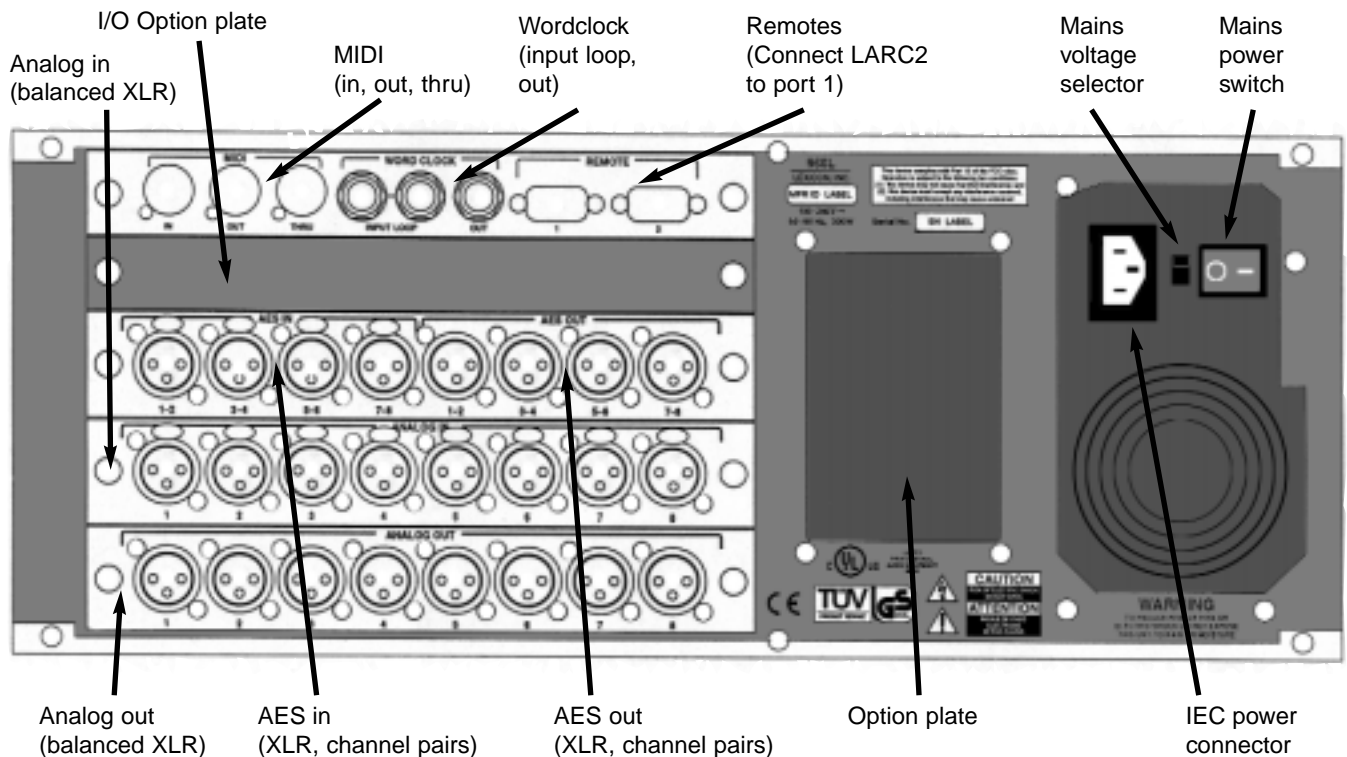

Figure 1-1 — 960L Rear Panel

The Rear Panel, continued

I/O Clock Card

MIDI Connectors (Five-pin DIN female)

- MIDI In
Accepts MIDI data from other MIDI-equipped devices.
- MIDI Thru
Retransmits, unchanged, MIDI data received at the MIDI In connector.
- Midi Out
Transmits MIDI data generated or modified by the 960L.

TTL WordClock (BNC)

- Input Loop
Allows the 960L to be synchronized to other studio equipment.
- Output.
Allows studio equipment to be synchronized to the 960L.
Note: The 960L can also derive wordclock from AES input 1-2, or generate it internally.

Remote-Control Connectors

The LARC2 must be connected to the Remote 1 9-pin D-connector. The 960L Remote connectors are for use only with the LARC2 controller.

Important:

Never connect either Mainframe remote port to anything other than LARC2. Doing so may damage your equipment.

Option Plates

Reserved for future use.

Analog Input Card

The 960L's analog audio input card has eight female XLR connectors, all electronically balanced. For impedances and signal levels, see the Specifications Section near the end of this manual.

Analog Output Card

The 960L's analog audio output card has eight male XLR connectors, all electronically balanced. For impedances and signal levels, see the Specifications Section near the end of this manual.

AES I/O Card

The 960L's digital audio inputs and outputs are combined on one card holding four XLR two-channel female connectors for AES input and four XLR two-channel male connectors for AES output.

Mains Power Switch

This switch turns the power in the 960L completely off or on.

Mains Voltage Selector

Before connecting the 960L Mainframe to power mains, make sure the setting matches your local mains voltage. Refer to the Installation section of this chapter for more information.

IEC Power Connector

Accepts IEC power cords with mains plugs specific to your country.

The Front Panel

Floppy Drive

This is a 3.5", High Density, IBM Format compatible, floppy drive. This is primarily used for saving user Registers.

Thumbscrews

To gain access into the front section of the chassis, unscrew both thumbscrews and lower the hinged panel.

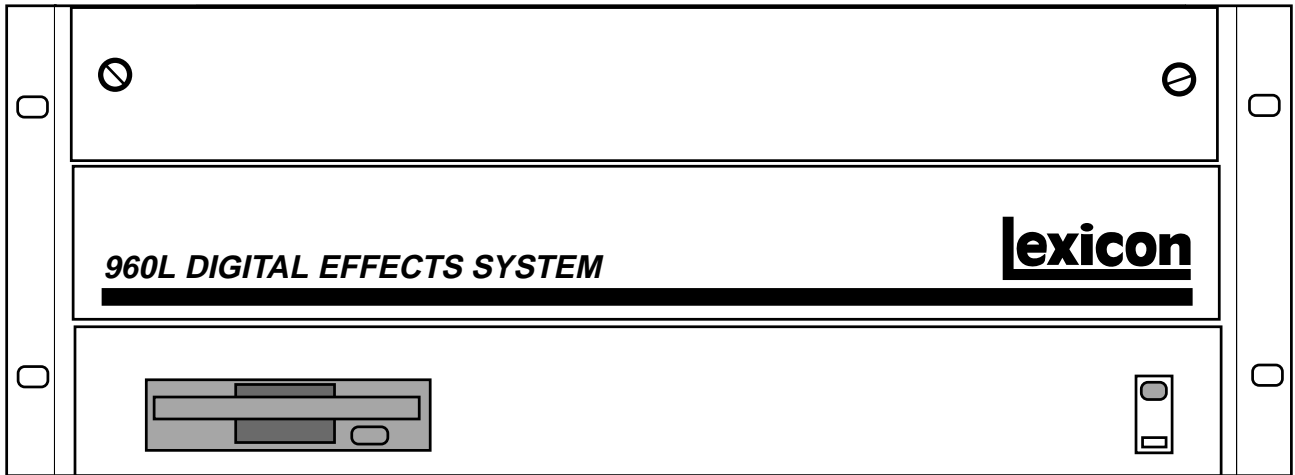

Figure 1-2 — Front panel, closed.

Standby Switch and Indicator

This switches the 960L between on and standby; the indicator LED lights when the unit is on.

When your 960L is in standby, the power to most circuitry is removed. To completely disconnect power from the 960L, either turn off the power by using the switch located on the rear panel of the 960L or unplug the power cable from the wall outlets.

Behind the Front Panel

DSP-Card Slots

Top slot occupied, others reserved for future Lexicon cards.

Important:

Do not plug any cards into these slots except those made by Lexicon for the 960L.

CPU Card

NLX-type montherboard.

Caution:

The motherboard has a lithium battery. Lithium is a hazardous substance. The battery should be replaced only by qualified service personnel, and disposed of properly.

Card slots for DSP cards. The cards can be removed for service, when instructed by Lexicon Customer Service.

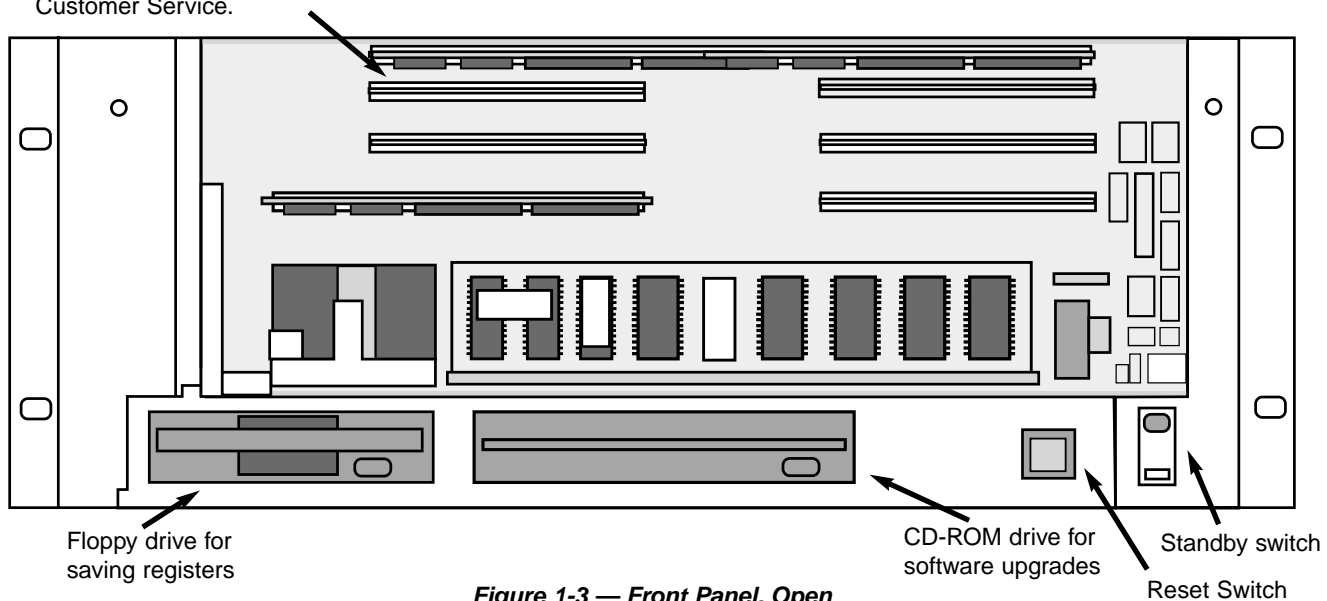

Figure 1-3 — Front Panel, Open

Installation

Mounting

The 960L mounts in stationary racks with four screws. Make sure the 960L Mainframe is securely screwed into the rack. For moving and in roadcases, be sure that support is provided for the rear of the chassis to avoid possible damage.

Ventilation

Provide adequate ventilation if the 960L is mounted in a closed rack with heat-producing equipment such as synthesizer modules, effects units, or power amplifiers. Avoid mounting the 960L Mainframe directly above power amplifiers.

Location

It may be desirable to place the 960L Mainframe in a location remote from the listening environment. The mainframe can be located up to 1,000 feet from the LARC2 controller with a remote power pack. See Chapter 2 for more information.

IEC Power Connector

The 960L is equipped with a 3-pin IEC power connector and detachable cord, providing chassis grounding to the AC mains line. Plug the female end of the power cord into the 960L mainframe and the male end into a wall outlet.

Mains Voltage Selector

Before connecting the 960L Mainframe to power mains, make sure the setting matches your local mains voltage.

Use a flat screwdriver to move the switch to the desired voltage.

Analog Audio Connections

For best results, the 960L should be connected to your console's Aux sends/returns, with wet/dry mixing and most input settings performed at the console. However, controls are provided within the 960L for situations where this is not possible or convenient.

For optimal performance, maintain balanced connections, and use high-quality, low-capacitance, shielded, twisted-pair cables, such as Belden 8412 (microphone cable with braided shield) or Belden 9461 (foil shield).

All connections should be Pin 2 high. For unbalanced operation, Pins 1 and 3 should be grounded. For mono inputs in a stereo configuration, connect the left and right input channels in parallel. Be careful to keep inputs and outputs of all channels wired consistently. Out-of-phase wiring can produce audible effects.

For I/O panning and level control, see Chapter 4, Operations in Detail. All signals sent to the analog outputs are also sent to the digital outputs.

Important:

Analog I/O connectors must be wired consistently (we recommend Pin 2 high), or channels will be out of phase.

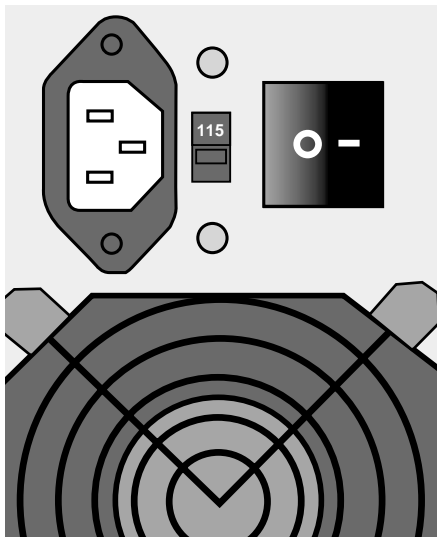

Figure 1-4 — Setting for 100-120 V AC

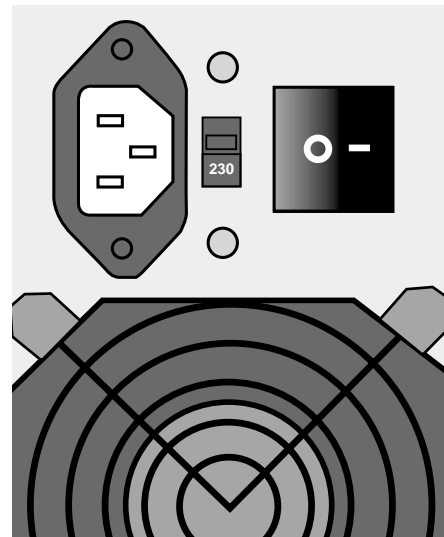
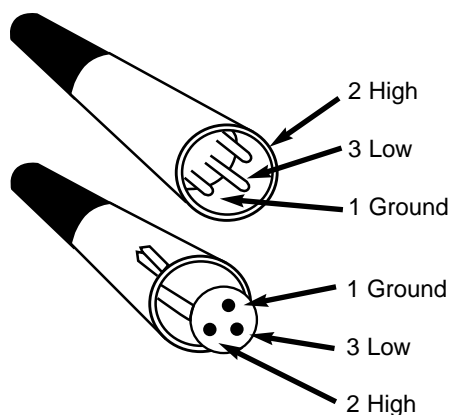

Figure 1-5 — Setting for 220-240 V AC

Installation, continued



Digital Audio Connections

The AES interface requires balanced connections, using high-quality, low-loss, controlled-impedance, shielded, twisted-pair cables designed for data communications, such as Belden 9860 (braided shield) or Belden 9271 (foil shield). The use of **ordinary microphone cable can cause digital interfaces to work unreliably**. Remember that the maximum recommended length for AES cabling is 100 feet (30 meters).

Following AES conventions, the odd-numbered channels are on the left channel of each AES stereo pair, the even-numbered channels on the right. The word length is 24 bits, at sample rates of 44.1, 48, 88.2, or 96 kHz. To use the digital inputs, the 960L can be synchronized to AES input 1-2 or to the TTL Wordclock input. Note that all digital inputs must be synchronized to the same master clock for operation without artifacts.

For routing and panning, see Chapter 4, Operations in Detail. All signals sent to the digital outputs are also sent to the analog outputs.

MIDI Connections

Use standard, 5-pin DIN MIDI cable assemblies, available from your local dealer. Chapter 6, MIDI describes the 960L MIDI functionality.

Wordclock Connections

Use standard, 75 ohm BNC cables, available from your local dealer. The self-terminating loop-thru TTL input facilitates daisy-chained clock distribution. The 960L will refer its internal wordclock to the falling edge of the input square wave. The 960L output is a TTL-compatible square wave with the falling edge aligned with the start of the 960L sample period.

2

The LARC2 Remote

THE LARC2	2-1
About the LARC2	2-1
Unpacking The LARC2	2-1
LARC2 CONTROL SURFACE	2-2
GETTING WHAT YOU WANT	2-3
LARC2 CONNECTIONS.....	2-3
Control Port	2-3
Aux Port	2-3
External-Power Connector	2-3
NAVIGATING TYPICAL DISPLAY SCREENS	2-4
ABOUT THE FADERS AND JOYSTICK.....	2-5
AUDIO INDICATORS	2-6
FINE ADJUST.....	2-6
THE LEXICON BUTTON	2-6

The LARC2 Remote

About the LARC2

The 960L is controlled from the LARC2. While the LARC2 is a completely new remote, its operation will seem familiar to users of the LARC remote used with the Lexicon 224XL and 480L. Like the original LARC, the LARC2 is compact enough to rest on or near the center of the console, while keeping the 960L Mainframe out of the way -- hundreds of feet away in the machine room, if necessary.

The 960L's user interface and the LARC2 were designed to be helpful to new users and fast for experienced 480L users. The LARC2's joystick and eight touch-sensitive motorized faders are always connected to and controlling audio parameters. The assignment of audio parameters to each of these controls has been individually optimized for each of the more than 200 factory Programs that ship with the 960L. Further, you can easily customize these assignments to put the parameters you use the most at your fingertips.

System status (input levels, machine configuration, clock source and lock status, mute state, etc.) is always visible on LARC2 through an LED meter bridge and a dedicated region of the color LCD display. Dedicated function keys, a numeric keypad, screen navigation arrows and eight soft buttons allow easy and quick navigation through the rest of the user interface.

Each screen has space for explanatory notes. Some of these notes are help messages, while others can be customized by the user, using either the LARC2's own text entry interface or a user-supplied PS/2 computer keyboard.

Unpacking the LARC

The 960L system is shipped in two cartons, one containing the 960L Mainframe, the other containing the LARC2 dedicated controller. After unpacking, save all packing materials in case you ever need to ship the unit. Thoroughly inspect the 960L system and packing materials for signs of damage. Report any shipment damage to the carrier at once. The following accessories are packed with the LARC2 (for the 960L mainframe carton, see Chapter 1):

- LARC2 remote console
- 50-foot cable for connection to 960L Mainframe
- Warranty & registration cards
- CE compliance certificates

Note: You will find the LARC2 to be a robust and reliable product. It does contain complex electronic and electro-mechanical assemblies. We suggest handling it with the same care you would apply to the use of a laptop or notebook computer.

Important:

- Never connect a LARC2 to anything but the 960L Mainframe.
- Never connect either Mainframe Remote Port to anything but the LARC2. Doing so may damage your equipment.

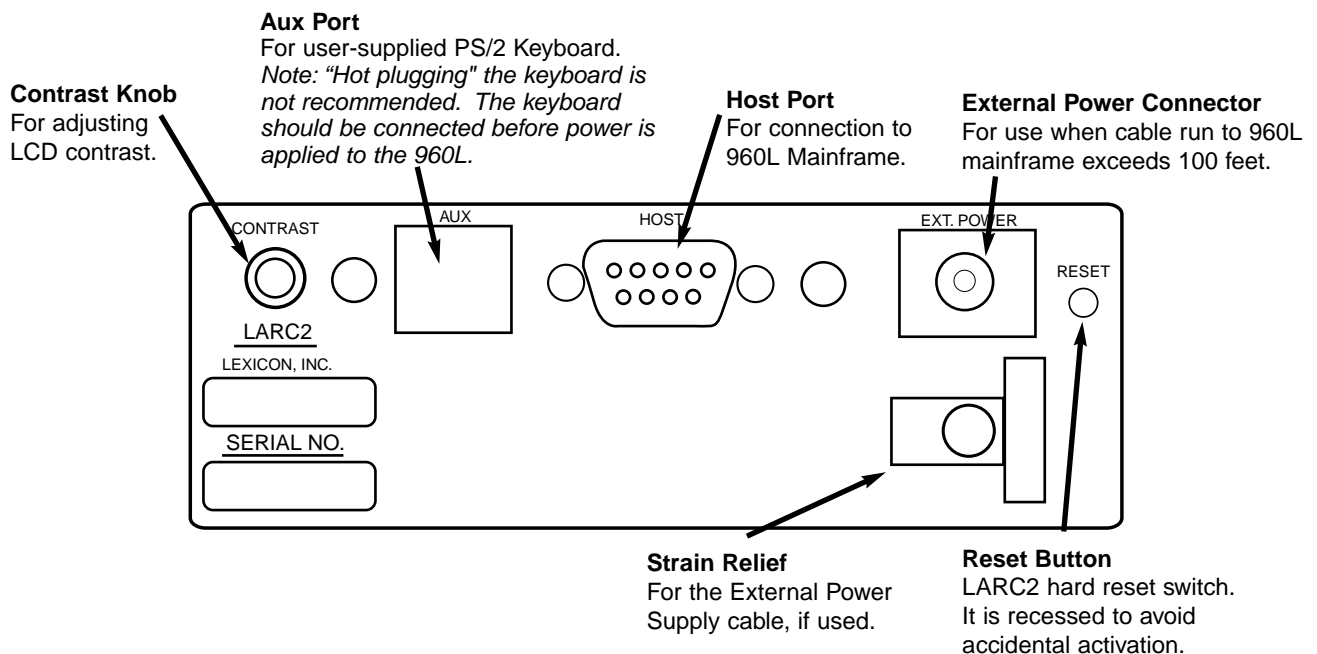

Figure 2-1 — LARC 2 rear panel

LARC2 Control Surface

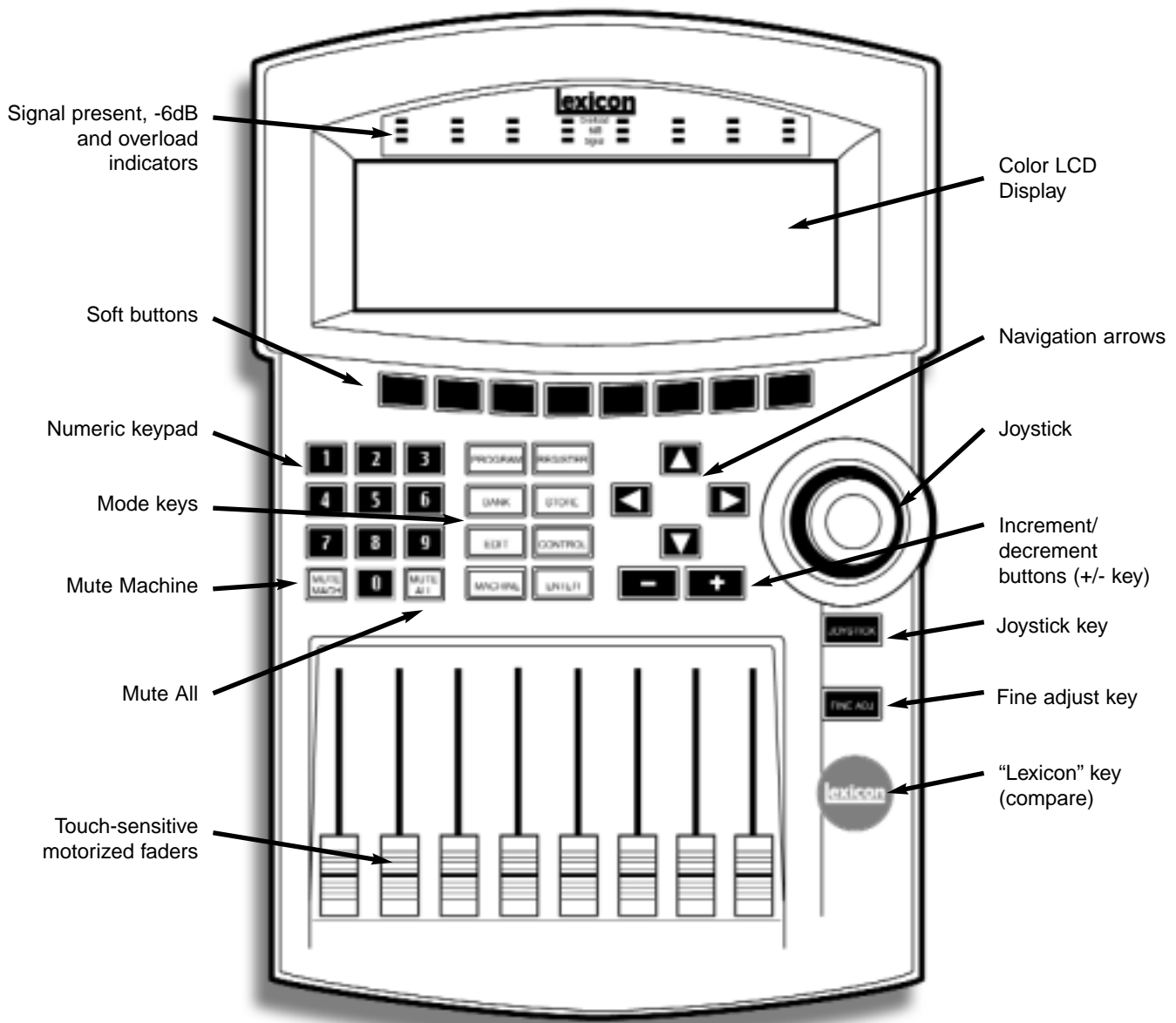

Figure 2-2 — The LARC2 Control Surface

Getting What You Want

In general, the LARC2's faders and joystick are used to control audio parameters of your choice, while all other buttons select operations and parameters. That means you have several fast ways to operate the 960L.

- Mode Buttons give you direct access to the most frequently used control actions. These buttons are: PROGRAM, REGISTER, BANK, STORE, EDIT, CONTROL, and MACHINE. The functions of some buttons are implied by their names, and all are explained below. When selected, each button glows red.
- ENTER is used to complete an action.
- The Numeric Keypad lets you quickly select any numbered option on the display.
- Navigation Arrows let you move up, down, or sideways within the display to select the action you want.
- Increment and Decrement (+/-) Buttons can be used to select items from lists or to make fine adjustments to parameters.
- Soft Buttons are context sensitive. Their labels therefore change dynamically and appear at the bottom of the LCD display, just above each button.

Additional LARC2 controls include:

- Joystick, primarily for input and output panning, but assignable to any desired parameters.
- JOYSTICK Button activates and deactivates the joystick.
- FINE ADJ Button toggles faders to and from fine-adjustment mode.
- Lexicon Button temporarily returns operation to the most recently loaded Program or Register for quick sonic comparison.
- Faders are touch-sensitive and motorized. Their positions are automatically updated (auto-nulling) to reflect the current values of their assigned parameters. The parameters controlled by each fader and their current settings are shown on the display, just above the soft-button labels. Touching any fader highlights its parameter and setting on the display.
- MUTE MACH and MUTE ALL buttons (flanking the numeric keypad's "0") mute the output of the currently selected machine or the outputs of all machines.

LARC2 Connections

Host Port

This port connects LARC2 to the 960L Mainframe. For distances of 100 feet or less, use Lexicon No. 022-14400 50-foot cables. One 50-foot cable is supplied with LARC2. For longer distances (up to 1,000 feet) use computer-grade cable with shielded twisted-pairs, for example Belden 9860 or 9271. Do not use microphone or other audio cable. The cable pin assignment is shown in figure 2.3. For distances over 100 feet, LARC2 requires an external power supply, as described below.

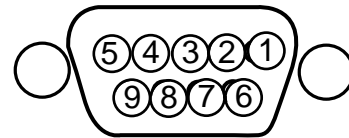

Pin	Assignment	Pin	Assignment
1.	Chassis/Shield Ground	6.	Receive Common
2.	Receive Data	7.	Receive Data
3.	Transmit Data	8.	Transmit Data
4.	Transmit Common	9.	Power Supply Ground*
5.	Power Supply (+)*		

* Not connected if external power supply is used.

Figure 2-3 — LARC2-connector Pin Assignments

Aux Port

You can connect a standard PS/2 computer keyboard to LARC2 via this port. This will allow faster text entry in NAME and INFO fields (see Chapter 4, Operations in Detail). "Hot plugging" the keyboard is not recommended. The keyboard should be connected before power is applied to the 960L.

External Power Connector

The LARC2 must be powered by an external power supply when located greater than 100 feet from the 960L. The power supply should deliver 12VDC at 2 A and should have a 5.5 mm O.D., 2.5 mm I.D. concentric (female barrel) connector, with the positive voltage on the inner contact. See the Lexicon web page (www.lexicon.com) for a current list of external power supplies and vendors.



Navigating Typical Display Screens

The use and navigation of the display will be illustrated with the screen shown in Figure 2-4, from Algorithm Edit Mode. Bring up this screen by pressing the EDIT and then ALGORITHM buttons. Note that the parameters currently assigned to the faders, and their current settings, are shown on the Scribble Strip, just above the Soft Button Labels.

The Action Display, which occupies the left half of the display's top line, will show the current operating mode when you first enter that mode. When you touch a fader, it will show the name of the attached parameter and its current setting, and will continue to show that information until you touch another fader. The action indications are "sticky" in that they remain on the display until another action indication is displayed. In Figure 2-4, the Action Display shows "Edit Mode" because pressing the EDIT button was the most recent action.

The Effect Display, which occupies the right half of the top line, identifies the Program or Register loaded in the active machine. Here, it shows that the 960L is using "Large Hall +", which is Register 1 in Bank 1.

The Main Operating Display, which changes from mode to mode, always occupies the same area shown, i.e. the center and left of the screen. In this screen, used for editing algorithms, it shows four algorithm pages, each consisting of parameters and their settings. The currently selected page has its page number highlighted, with a red outline.

Parameters in the rows not highlighted are not assigned to the faders and are set to the values shown.

Touching any fader will select the parameter controlled by that fader. At that point, the selected parameter and its setting will be highlighted on the Scribble Strip and also on any page of settings visible in this display. It will also be displayed in larger type on the Action Display.

You can also scroll to any desired parameter, whether on the current page or not, with the Navigation Arrows. If you scroll up or down to a different page, that page and all its parameters will be "connected" to the faders. Note that you can also select a page by pressing its number on the Numeric Keypad. Once a new page is selected, the faders automatically position to the appropriate value (auto-nulled).

You can move as many faders at a time as you like. All the connected parameters will be affected. If you touch several faders, the last fader you release will then be displayed as the "selected" parameter. In this mode (Algorithm Edit) you can use the +/- Buttons to make fine adjustments on the selected parameter.

The Paging Arrow along the right side of the Main Operating Display shows that more items are available than will fit the current listing. The total number of pages, 8 in Figure 2-4, is listed in the lower right corner of the Main Operating Display. This arrow is greyed out at the top, indicating that no further items are available in that direction. The rows wrap. After you key down to the last row, the next press of the Down Arrow will bring up the first row, and vice versa if you use the Up Arrow.

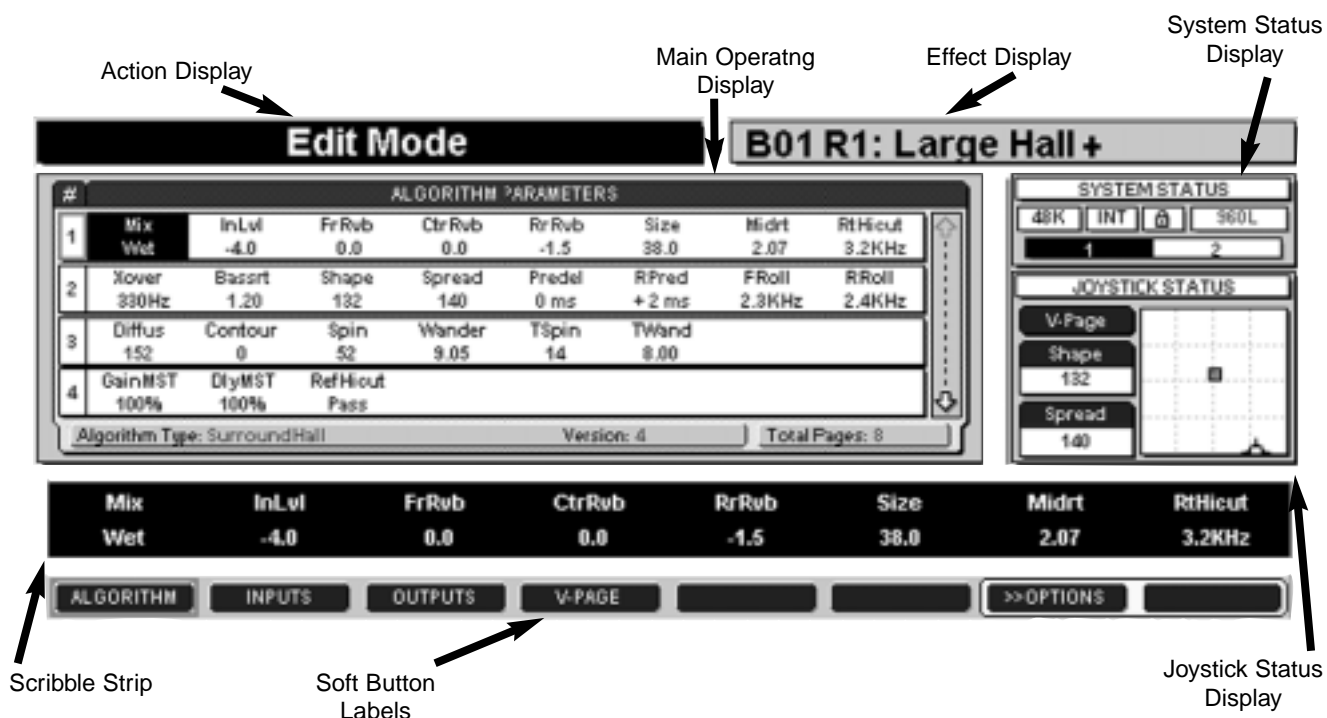

Figure 2-4 — A typical display screen

Navigating Typical Display Screens, Continued

Shortcut: Any numbered item available in the current mode, visible or not, can be brought up by entering its number with the Numeric Keypad on the LARC2 control surface.

Soft-Button Labels identify the currently available soft buttons. The currently active button is highlighted with a red outline. Buttons with grey backgrounds will cause a context change; those with yellow backgrounds cause an immediate action. Buttons with blank legends do nothing.

The System Status Display is present in all screens. In Figure 2-4, it shows that the current sample rate is 48kHz, that the wordclock source is internally generated, and that the 960L is locked to that clock source. On the line below, we see that the 960L is configured as two machines, and that Machine 1 is currently selected for editing. If a machine is muted, the machine number is overlaid with a red flashing "M". If all available machines are muted, the machine bar is overlaid with a red flashing "ALL MUTED" message. If the word clock was external (via either the AES input 1-2 or the BNC Wordclock input), the padlock symbol would show the state of wordclock lock. If lock was lost, the padlock box would flash red and the 960L outputs would automatically mute.

The Joystick Status Display is also present in all screens. In Figure 2-4, it gives the joystick position and the resulting Shape and Spread values. The parameters currently assigned to the joystick and their settings are listed in two boxes to the left of the Joystick Map. The small colored dot at the center of the map shows those parameter settings graphically. The dot is red if the joystick is not active and green if it is. The cursor shows the Joystick's current position. Pressing the JOYSTICK Button on the LARC2 control surface sets the parameters to the joystick's current position and activates the joystick.

The V-Page legend in the Joystick Status Display indicates that the joystick is set to a V-page, or virtual page, a Program- or Register-specific collection of parameters and settings assigned to the faders and joystick. (See Chapter 3, Basic Operation and Chapter 4, Operations in Detail.)

Fader labels are in the Scribble Strip just above the Soft Button Labels. These display the parameters currently assigned to each fader, and their settings. When a fader is touched, the associated parameter is highlighted in yellow.

About the Faders and Joystick

The faders and joystick always control some aspect of the audio, no matter what mode the 960L is in. It is the active control mode that determines which audio parameters are controlled. This table shows the mapping.

MODE	FADERS	JOYSTICK
Program	V-Page	V-Page
Register	V-Page	V-Page
Machine	V-Page	V-Page
Control	V-Page	V-Page
Edit -- Algorithm	Algorithm Parameters	V-Page
Edit -- Inputs	Input Levels	Input Panner
Edit -- Outputs	Output Levels	Output Panner
Edit -- V-Page	V-Page	V-Page

Audio Indicators

A simple meter bridge above the display holds three LEDs per channel. The lowest LED indicates that a signal is present, defined as a level of -60 dBFS or more. When levels exceed -6 dBFS, the middle LED lights as a warning of reduced headroom. Above -0.5 dBFS, the top LED lights to indicate imminent overload.

If all eight overload LEDs are illuminated, an overflow has occurred in the DSP accumulator. This can happen even with modest signal levels if the delay/reverb feedback coefficients (which are set by the algorithm parameters) combine to create some path with a gain greater than unity. Generally, you should mute the outputs (MUTE MACH or MUTE ALL), and then find and correct the offending parameter settings. This should not occur with factory Programs, unless they have been edited.

The Lexicon Button

The Lexicon button is used for quick A/B comparisons between the current version of a Program or Register, including your edits, and the effect as originally loaded. When the button is held down, the original, stored Program or Register will be loaded and the display will show a red banner that says "LISTENING TO ORIGINAL PRESET". When the button is released, your last Edit state will be reloaded and the red banner will disappear.

Fine Adjust

It is difficult to set parameters with large value ranges to precise values with the faders. For example, the fader range for some delays must allow for the fact that delays of 1,000 milliseconds are not uncommon, yet the value often needs to be set within a few milliseconds or even samples.

To make such fine adjustments, set the faders to the approximate values you want, then press the FINE ADJ Button. When this button is pressed, the faders all move to the center of their travel, but their settings do not change. The faders then operate in a vernier mode, with a limited adjustment range and far fewer steps per inch of travel. This makes it easy to set the parameter to the exact value you want.

Pressing FINE ADJ a second time returns the system to normal operation and the faders return to their appropriate full-range positions. The display warns when the system is in fine adjust mode, but the centering of all faders is a more obvious tip-off.

For fine adjustments of a single parameter while in Edit Algorithm mode, simply touch the appropriate fader, then use the Increment/Decrement (+/-) Buttons to get the setting you want. Each press of these buttons changes the parameter by its smallest possible increment.

3

Basic Operation

AN OVERVIEW OF THE CONTROLS	3-1
A QUICK GUIDE TO OPERATION	3-2
(1) Setup (Control Mode)	3-2
(2) Machine Selection	3-5
(3) Program Loading	3-5
(4) Editing a Program or Register	3-6
(5) Storing Your Edits	3-6

Basic Operation

This chapter provides a quick description of how to operate the 960L. Chapter 4, Operations in Detail, provides a more complete description of all available functionality.

An Overview of the Controls

Figure 3-1 is a general map to the LARC2's control keys and the ways they take you through the 960L's user interface.

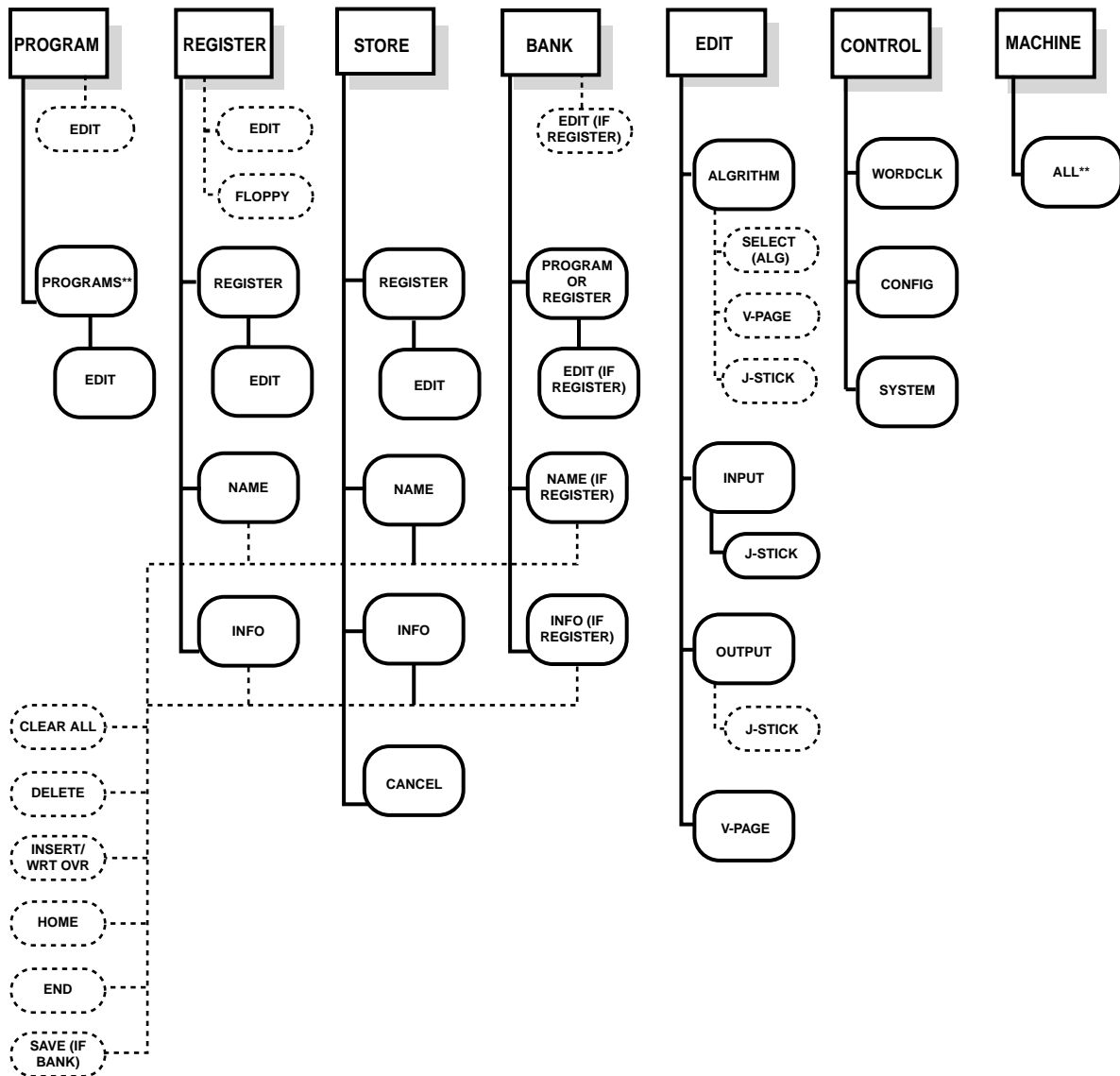

Figure 3-1 — Overview of 960L control system.
 Dedicated control keys shown with square corners, soft buttons with rounded corners,
 and Option soft buttons with dashed outlines. Controls with ** in their labels initiate no action.

A Quick Guide to Operation

Basically, using the 960L involves only the following:

- 1) Setting up the system for the job.
- 2) Selecting a machine.
- 3) Loading the Programs and Registers you want.
- 4) Editing the Program or Register parameters with the faders and joystick.
- 5) Storing your edits for quick recall at any time.

To make this overview as clear as possible, only one screen will be shown per operation. In practice, you may see slightly different screens depending on the selections you make. These are discussed further in Chapter 4, Operations in Detail.

(1) Setup (Control Mode)

Press the CONTROL key and then the WORDCLK Soft Button on the LARC2 control surface, to bring up the screen shown in Figure 3-2.

You can tell Figure 3-2 is in wordclock mode by the red highlight around the WORDCLK soft button. You can

tell that Source Selection is the active control because its name (SOURCE) has a blue background. The name of the inactive control, (RATE) has a yellow background. If the RATE control was active, pressing the Left Navigation Arrow would activate SOURCE.

- Press the number on Numeric Keypad for the clock source you want. (Refer to Chapter 4, Operations in Detail, to find out more about clock sources.)
- Use the Right Navigation Arrow to move to the RATE display.
- Press the number corresponding to the sample rate you want.

Note: A small padlock symbol in the System Status Display shows whether the 960L is locked to the clock source. If the 960L is not locked to the selected clock source, the padlock box will blink in red and the 960L will mute until lock is established.

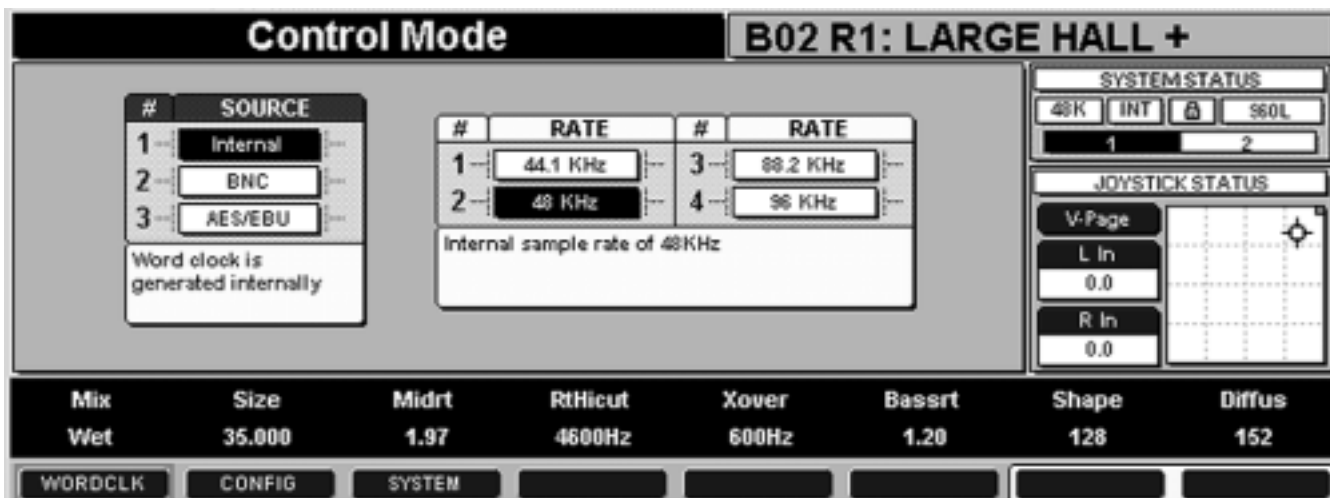

Figure 3-2 — Control Mode, wordclock selection.

A Quick Guide to Operation, Continued

Next, press the CONFIG soft button to select the input/output configuration.

Depending on the sample rate and input/output configuration you select, the 960L can be configured as up to four virtual machines, each of which can be programmed individually. In the configuration screens, each machine is shown as a separate, numbered rectangle in the Main Operating Display. The number of machines in the current configuration can be read from the Machine Strip in the System Status Display at the upper right of the screen.

If you selected a clock rate of 44.1 or 48 kHz, you'll get a screen like Fig. 3-3, which gives you a choice of four processing configurations:

- 1) Stereo in and out, using up to four machines.
- 2) One machine with five channels in and five out, and another with two channels in and five out.
- 3) Two machines, each with two channels in and five out.
- 4) A single 8-in/8-out machine, with a pass-through algorithm, which performs no processing, but is useful for wiring checkout and diagnostics.

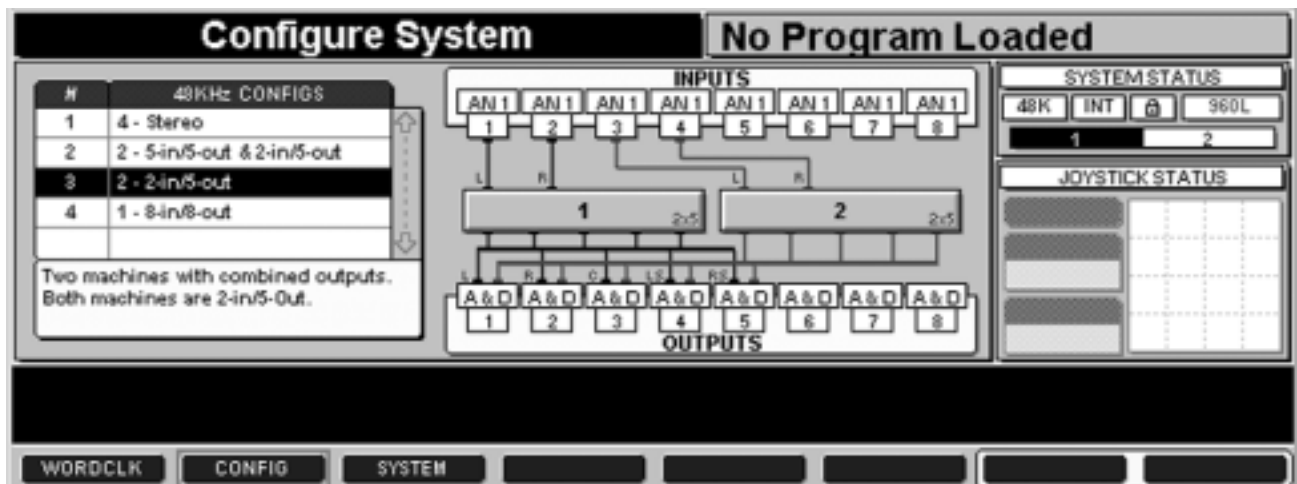

Figure 3-3 — Configuration screen for 44.1/48 kHz clock rate (2 in/5 out selected, two machines available).

A Quick Guide to Operation, Continued

If you selected a clock rate of 88.2 or 96 kHz, you'll get a screen like Fig. 3-4, which gives you a choice of two processing configurations:

- 1) Stereo in and out, using one or two machines
- 2) One machine, with 5 channels in and 5 channels out.
- 3) One machine, with 2 channels in and 5 channels out.
- 4) A single 8-in/8-out machine, with a pass-through algorithm, which performs no processing, but is useful for wiring checkout and diagnostics.

To select a configuration, enter its number with the Numeric Keypad (or scroll to it with the Navigation Arrows and press ENTER).

To select analog or digital input, first use the Navigation Arrows to position yourself on any of the Input Selection Boxes. Then, use the Increment/Decrement (-/+) keys to toggle back and forth between Analog and AES inputs. In Figs. 3-3 and 3-4, all inputs are analog ("AN1" on the INPUTS strip of the Main Operating Display). Pressing either the Increment or Decrement key will switch all inputs to digital ("AES" on the INPUTS strip). All inputs will be set alike.

The Analog and Digital Outputs receive the same signals at all times, mapped channel for channel, as noted by the "A & D" on the OUTPUTS strip.

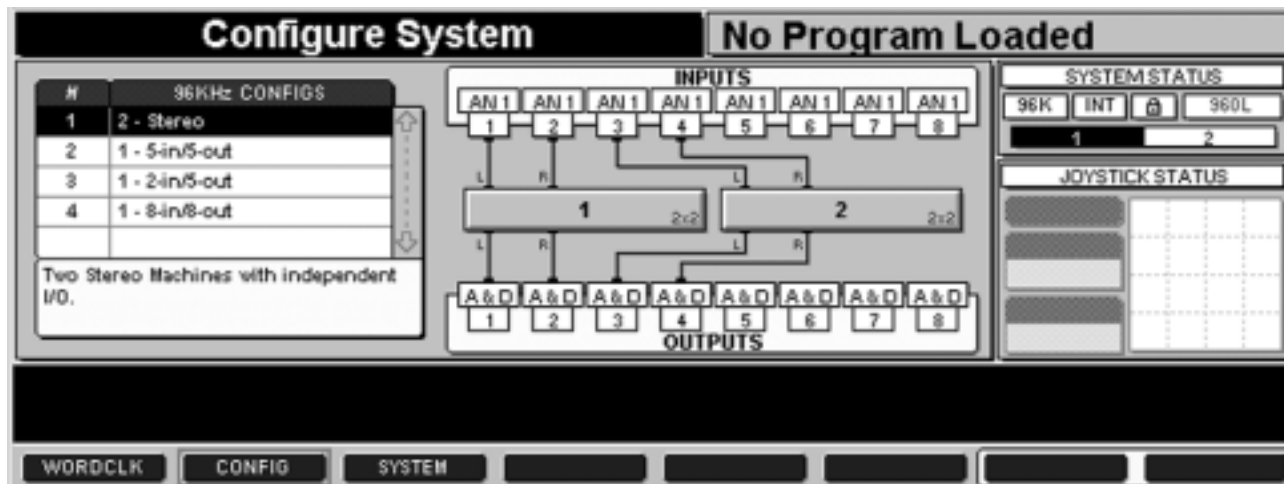

Figure 3-4 — Configuration screen for 88.2/96 kHz clock rate (stereo in/out selected, two machines available).

A Quick Guide to Operation, Continued

(2) Machine Selection

In most configurations, the 960L gives you more than one processing machine to work with, each of which can be programmed individually. To select the machine you wish to program, use the following steps:

- Hold down the MACHINE key on the LARC2's control surface.
- Using the Numeric Keypad, press the number of the machine you want.
- Release the MACHINE key
- The Machine Strip in the System Status Display shows which machine is currently selected
- Note that you can also select machines in Machine mode (see Chapter 4 for details)

(3) Program Loading

This manual has already used the terms Programs, Banks and Registers several times. The 960L comes pre-loaded with more than 200 factory Programs (such as "Large Hall" and "Bright Chamber"). Each Program is a complete effect that combines a processing algorithm with specific parameters settings, plus brief explanatory notes and comments. These Programs have been designed with parameters assigned to the eight faders and the joystick for easy, rapid control.

Related Programs are stored in descriptively named Banks so they will be easy to find. A Bank can hold as

many as ten similar Programs. For example, the Halls Bank contains reverberation Programs that simulate large spaces, while the Plates Bank contains Programs that simulate studio plate reverbs.

Programs can be edited by changing parameter settings, by re-assigning parameters to the faders and joystick, or by modifying the NAME or INFO. Editing does not change the factory Programs, but you can store up to 1000 edited effects as Registers, which are stored in separate Banks from the factory Programs.

To Load a Program (or Register):

- Press the PROGRAM (or REGISTER) key on the LARC2
- Press BANK. That should bring up a screen like Figure 3-5:
- Enter the number of the Bank you want, using the Numeric Keypad. If you don't know the number and the Bank you want is not on the display, scroll up or down with the Navigation Arrows until you find it.
- Using the right Navigation Arrow, jump to the Program list (or press PROGRAM).
- Enter the number of the Program you want, using the Numeric Keypad (or scroll to the desired Program with the Navigation Arrows or +/- Buttons, then press the ENTER key).

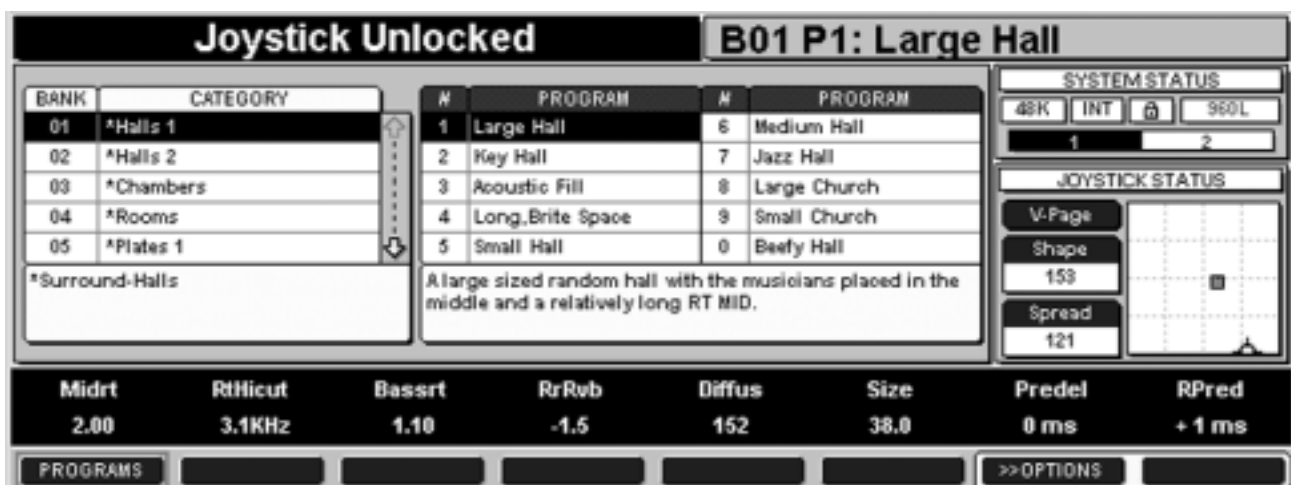

Figure 3-5 — Program Load screen (Register Load screen is similar)

A Quick Guide to Operation, Continued

(4) Editing a Program or Register

Once a Program or Register is loaded, you can edit it to get exactly the effect you want. The simplest way to do this is by changing the settings of the parameters assigned to the faders and joystick on the V-Page, which is available in Program, Register and Bank modes.

For parameters assigned to faders:

- Touch the fader you want to change. When you do, that parameter and its setting will be highlighted in yellow on the Scribble Strip and will appear, in larger lettering, on the Action Display. Move the fader to get the desired setting.
- If you can't move the fader in small enough increments to get the precise setting you need, get as close to that setting as you can, then press the FINE ADJ key and adjust the parameter with the fader in vernier mode. Press FINE ADJ again to leave Fine Adjust Mode.
- You can move several faders at once. The settings indicated on the Scribble Strip will change for all. When you release the faders, the last one you touched will be highlighted and appear on the Action Display.

For parameters assigned to the joystick:

- Press the JOYSTICK Key on the LARC2, then adjust the joystick until the Joystick Status Display shows the desired settings (Fig. 3-6).

(5) Storing Your Edits

Your edits will stay in force until you change them again or load another Program or Register. To save them for

future use, press the STORE key. The STORE key will blink to remind you that the store operation is pending.

- If you've been editing a user-created Register, the 960L will highlight the current Bank and Register. If you wish to replace that Register with your edited version, press STORE a second time to save your edit.
- If you've been editing a factory Program, the 960L will look for the first Register Bank with space available or the Register Bank you last stored to, and the first empty Register within that bank.
- If you'd prefer a different Register Bank, press the BANK key and enter the number of the desired bank (or scroll to it with the Navigation Arrows).
- If you'd prefer a different Register, press the REGISTER key and enter the number of the desired Register (or scroll to it with the Navigation Arrows).
- To Name a Register or Register Bank, press the NAME soft button and follow the directions below.
- To add explanatory information to a Register or Register Bank, press the INFO soft button and follow the directions below.
- When everything (target Bank, target Register, NAME and INFO) is the way you want it, press STORE again, to save.



Figure 3-6 — JOYSTICK STATUS Display

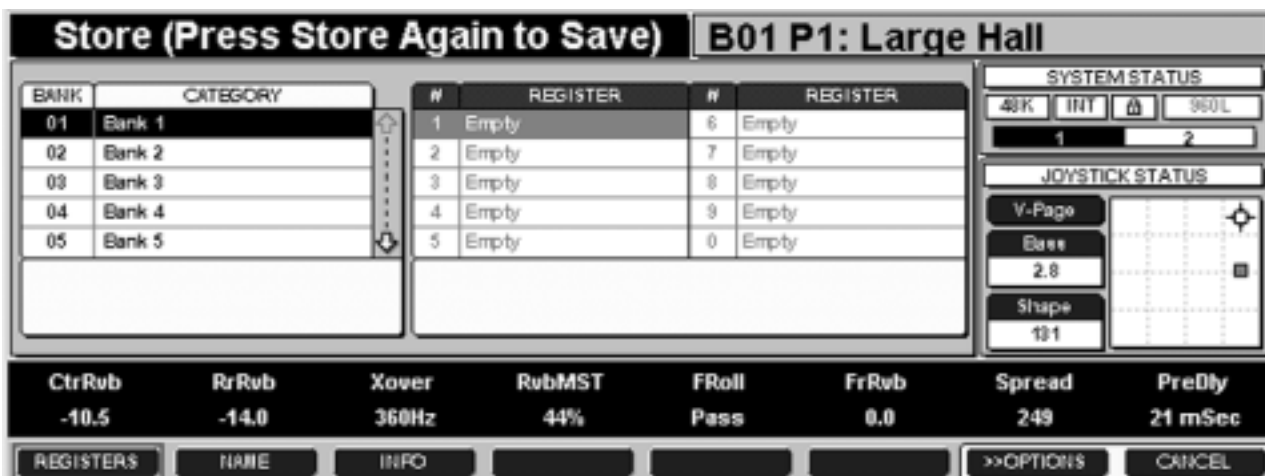

Figure 3-7 — Storing

A Quick Guide to Operation, Continued

To enter Name or Information:

- Using the LARC2, use the Increment/Decrement (+/-) keys to scroll between character positions in the Name or Information display and the Navigation Arrows to select the desired character from the matrix below, then press the ENTER key to finalize your selection.

- If you have a PS/2 keyboard connected to the AUX port on the LARC2's rear panel, you can type in names and info. It is recommended that you connect the keyboard before power is applied to the 960L.

Names of Registers and Register Banks can be up to 16 characters long. Information displays for Registers can hold 150 characters and Information displays for Banks can hold 100 characters.

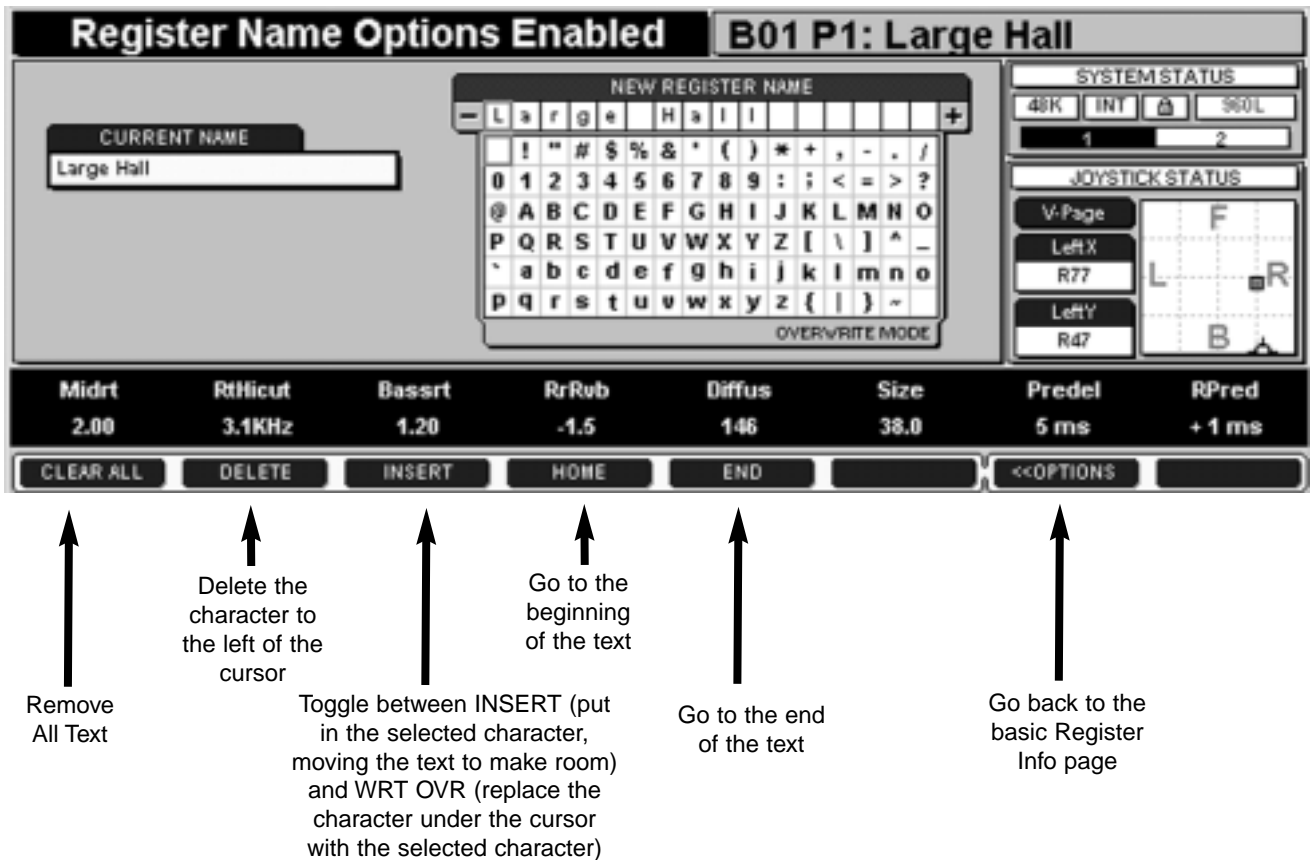

Figure 3-8 — Name screen; Info screens are similar.

4

Operations in Detail

LOADING PROGRAMS AND REGISTERS	4-1
Loading Programs	4-1
Loading Registers	4-2
CONTROL MODE: CLOCKS, CONFIGURATION, AND SYSTEM SCREENS	4-3
Wordclock.....	4-3
Input, Output, and Machine Configuration	4-4
System Screen.....	4-8
EDITING	4-9
Editing Algorithms	4-9
Editing With the Faders	4-9
Fine Adjust	4-9
Editing with the Joystick.....	4-10
Quick Comparisons via the Lexicon Button	4-10
Editing Inputs and Outputs.....	4-11
Input Panning	4-11
Output Panning	4-12
The 960L Surround Panning Rules	4-13
Setting Levels.....	4-13
Avoiding Overload	4-13
Assigning New Parameters to Faders or the Joystick	4-13
The V-Page and Parameter Reassignment	4-14
Using the Edit Algorithm Screen	4-14
STORING AND LABELING YOUR EDITS	4-16
Storing	4-16
Naming and Annotating	4-16
ORGANIZING YOUR REGISTERS	4-17
Edit Tools for Registers	4-18
Using the Floppy Drive.....	4-18
THE CD-ROM.....	4-18
MACHINE MODE	4-18

Loading Programs and Registers

With more than 200 factory Programs to choose from, plus up to 1,000 Registers of your own creation, you'll probably spend most of your time with the 960L loading the effects you want.

To simplify the selection of an appropriate effect, the 960L programs are organized as 24 Banks of up to ten related effects (see the Appendix for Program Descriptions). There are 100 Banks available for Registers and 10 Banks for Floppy storage and retrieval.

Loading Programs

When you first install the 960L, it will contain only factory Programs. There are several ways to select and load Programs. The simplest is designed to be familiar to users who know the Lexicon 480L:

Press the PROGRAM key, then the BANK key, to bring up a list of Program Banks (Fig. 4-1)

- Scan the list of Banks to find one you want (e.g., "Halls")
- Select that Bank by entering its number on the Numeric Keypad (or by scrolling to it with the Navigation Arrow keys).

- Press the Program key to get to the list of Programs
- Select the desired Program by entering its number on the Numeric Keypad (or by scrolling to it with the Navigation Arrow keys and pressing the Enter key).

Note: When you change Programs, the display will change and the motorized faders will move to the positions corresponding to that Program's parameter settings.

If you already know the location of the Program you want, you can do all this in just a few keystrokes:

- PROGRAM Key (Skip this step if going to the last Bank used.)
- BANK Key
- Bank Number
- PROGRAM Key
- Program Number

If you don't know the location of the Program you want, the procedure is similar, except that you can scroll up and down through the list of Banks to find the one you want.

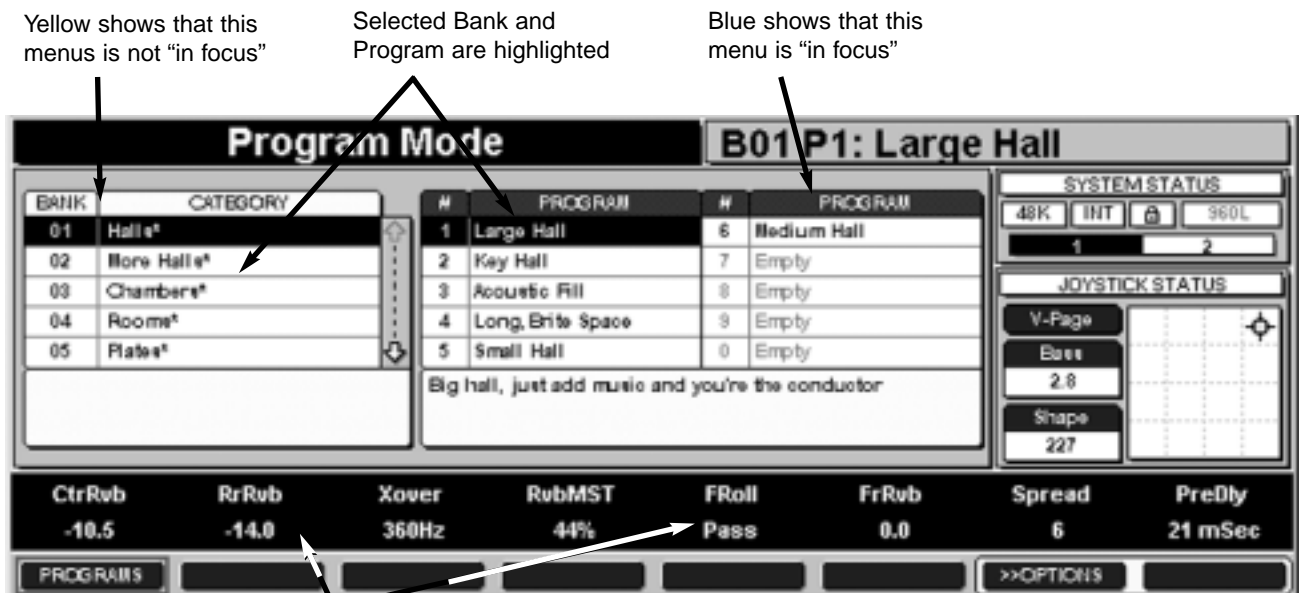

Fader Labels in Scribble Strip are from the currently loaded program.

Figure 4-1 — Program Load screen

Loading Programs and Registers, continued

Loading Registers

Loading Registers is similar to loading Programs. Press the REGISTER Key instead of the PROGRAM Key. This will bring up a similar screen (Fig. 4-2) The only differences are the use of the word "Register" instead of "Program" and the addition of two soft buttons for labeling. Note also that the last two Registers are unnamed and greyed out on the display, indicating that they're empty. Any selection that is greyed out, on any

screen, is unavailable. Programs and Registers can be unavailable if they are empty or if they are designed for sample rates and configurations that are not currently selected.

Shortcut: You can instantly load any Program or Register in the current Bank by pressing the corresponding key on the Numeric Keypad.



Figure 4-2 — Register Load screen

Alternative Loading Techniques

- You can use the Left/Right Navigation Arrows to move between Banks and Programs (or Banks and Registers).
- You can use the +/- Buttons or the Up/Down Navigation Arrows to scroll through Banks.
- You can use the +/- Buttons or the Up/Down Navigation Arrows to scroll through Programs and Registers. Press the ENTER key to load the Program.
- You can repeatedly press BANK, PROGRAM or REGISTER to scroll through the Banks, Programs and Registers.

Programming Machines

Depending on the configuration (see below), the 960L can be used as one, two, or four processing machines. The number of machines available in the current configuration is shown on the Machine Strip in the System Status Display. The machine whose settings you are

currently altering is highlighted. Machines that are muted have a blinking red "M" superimposed on their machine number.

You must program each machine individually. To switch to a different machine, press and hold the MACHINE key, then enter the desired machine number on the Numeric Keypad.

Control Mode: Clocks, Configuration, and System Screens

The LARC2's CONTROL key provides access to the 960L's wordclock, input/output configuration, and system information. Note that only three soft buttons

operate in this mode. The faders and joystick remain assigned to whatever audio parameters are on the V-Page.

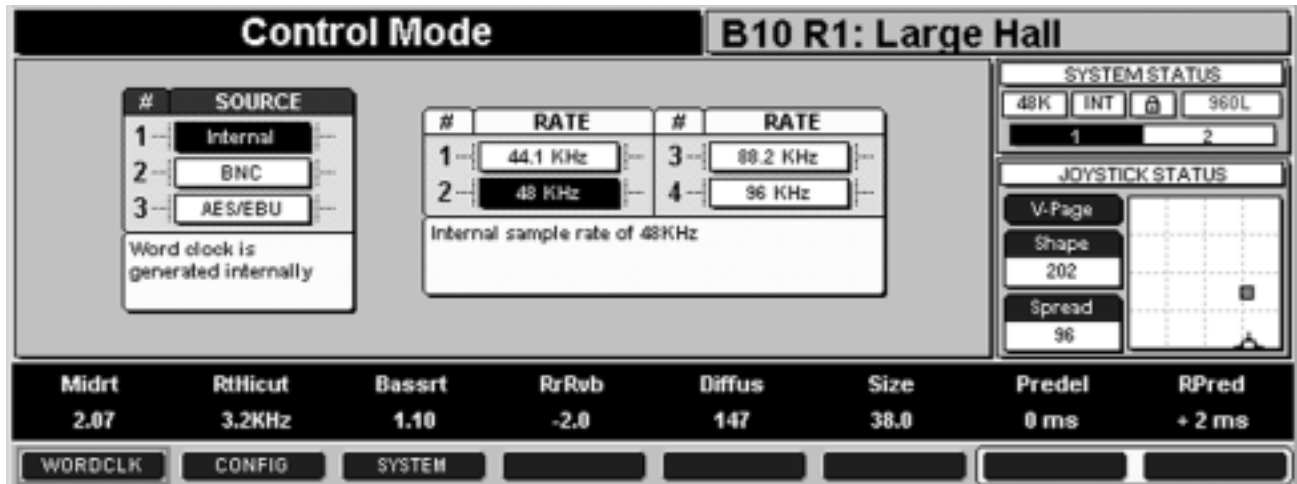

Figure 4-3 — Control Mode Wordclock Screen

Wordclock

From the Control Mode screen, press the WORDCLK soft button, then the number of the source you want:

1 Internal	Crystal-controlled. Use only with analog inputs, or if your digital inputs are from sources that are locked to the 960L.
2 BNC	For locking to your studio's master clock. Used with analog or digital input.
3 AES	Clocked from AES input 1-2. Used with analog or digital input. Note that if you are using AES as both the clock and audio source, and disconnect AES input 1-2 (the clock source) while other inputs remain active, you will hear artifacts on the non-clock channels, while the system detects the disconnect.

Entering the clock source number will select that source. You can also select a source with the Up/Down Navigation Arrows or the Increment/Decrement (+/-) keys.

Note: Use of the internal wordclock with digital inputs can introduce audible artifacts due to sample slip, even if the nominal sample rates are the same. When the 960L detects slipped samples in the AES input stream, the audio outputs are muted. To avoid this, do one of the following:

- Slave both the digital source and the 960L (BNC or AES) to a common wordclock.
- Allow the 960L to slave (BNC or AES) to the digital source's wordclock.
- Slave the digital source to the 960L, using the 960L AES or BNC output.

Control Mode: Clocks, Configuration, and System Screens, continued

Use the Right Navigation Arrow to get to the Rate display. For internal wordclock, you must select the exact rate, as shown in Fig. 4-3. For external wordclock via the BNC or AES inputs, you need only select 44.1/48 kHz or 88.2/96 kHz range. The 960L will then lock onto your source.

Wordclock Lock Status: A small padlock icon in the System Status Display shows lock status. If the wordclock becomes unlocked from the signal, the icon's background flashes red (Figure 4-4) and the 960L outputs are muted. This lock indicator is visible in the System Status Display during all operating modes.

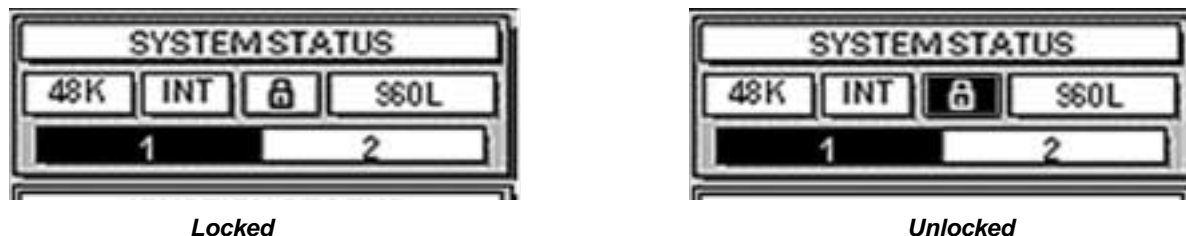

Figure 4-4 — Locked and unlocked wordclock.

Input, Output, and Machine Configuration

The 960L is an 8-input/8-output device. Input sources can be either analog or AES digital, and all inputs must be the same input type. Each output is sent to both analog and AES digital outputs. For any configuration, the mapping of physical channels to algorithm channels is fixed. The CONFIG soft button brings up the screens for selecting the 960L's I/O and machine configuration.

to two machines can be configured. Where multiple machines are available, each is programmed separately.

In stereo configurations (Figs. 4-5 and 4-6), all available machines are connected as two-channel in, two-channel out. Note that each machine is numbered and each machine's I/O configuration is displayed in red at the lower right corner of its diagrammed block.

The number of machines available varies with the sample rate. At 44.1/48 kHz, the 960L can be configured as up to four machines. At 88.2/96 kHz, up

When you switch to a new Configuration, no Programs or Registers are yet loaded, so the Scribble Strip is blank and the Joystick Status Display is greyed out.

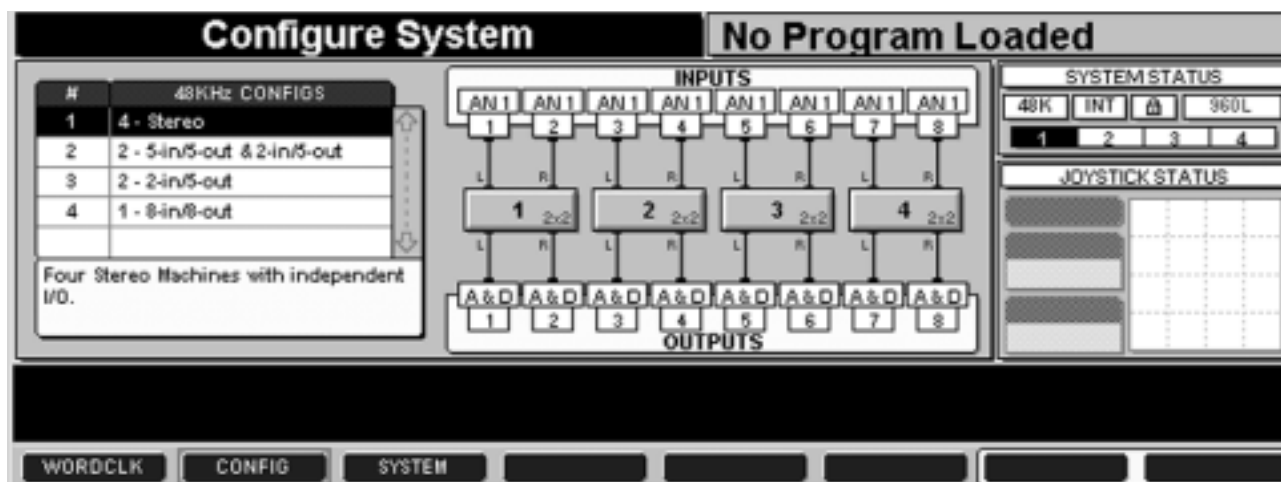

Figure 4-5 — Stereo configuration for 44.1/48 kHz sample rate; four machines available.

Control Mode: Clocks, Configuration, and System Screens, continued

Stereo 44.1/48kHz Configurations (the DSP card is divided into 4 stereo machines).

Input Assignment	1 Left	1 Right	2 Left	2 Right	3 Left	3 Right	4 Left	4 Right
Analog Input Channel	1	2	3	4	5	6	7	8
AES Input Channel	1 (L)	2 (R)	3 (L)	4 (R)	5 (L)	6 (R)	7 (L)	8 (R)
Output Assignment	1 Left	1 Right	2 Left	2 Right	3 Left	3 Right	4 Left	4 Right
Analog Output Channel	1	2	3	4	5	6	7	8
AES Output Channel	1 (L)	2 (R)	3 (L)	4 (R)	5 (L)	6 (R)	7 (L)	8 (R)

Note: As shown in these tables, AES inputs (and outputs) have two channels per physical connection. On the back panel, these are labeled 1-2, 3-4, etc. The assignment of the two channels conforms to AES conventions, that is, the odd-numbered channels will always be the left channel of that AES stereo pair, and the even-numbered channels will always be the right channel.

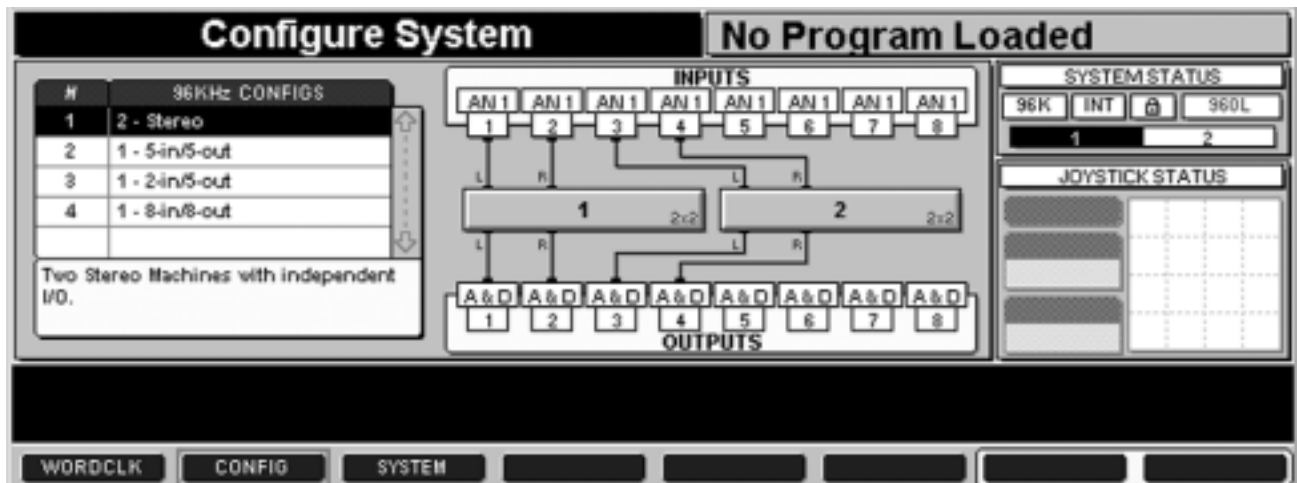

Figure 4-6 — Stereo configuration for 88.2/96 kHz sample rate; two machines available

Stereo 88.2/96 kHz Configurations (the card is divided into 2 stereo machines)

Input Assignment	1 Left	1 Right	2 Left	2 Right	Unused	Unused	Unused	Unused
Analog Input Channel	1	2	3	4	5	6	7	8
AES Input Channel	1 (L)	2 (R)	3 (L)	4 (R)	5 (L)	6 (R)	7 (L)	8 (R)
Output Assignment	1 Left	1 Right	2 Left	2 Right	Unused	Unused	Unused	Unused
Analog Output Channel	1	2	3	4	5	6	7	8
AES Output Channel	1 (L)	2 (R)	3 (L)	4 (R)	5 (L)	6 (R)	7 (L)	8 (R)

Control Mode: Clocks, Configuration, and System Screens, continued

In 5-Channel configurations, all available machines are configured for surround or other multi-channel uses. For one configuration (Fig. 4-7), one machine is configured as 5-in/5-out, the other as 2-in/5-out, both

sharing the same output channels. On the display, the output paths of the two machines are colored differently for easier visualization.

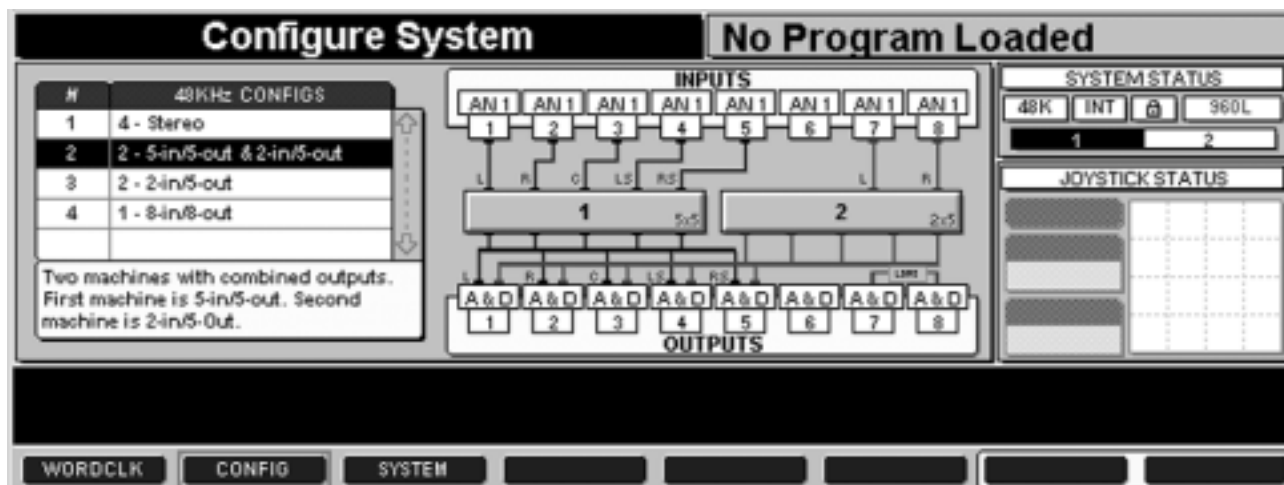

Figure 4-7 — 5-in/5-out and 2-in/5-out configuration for 44.1/48 kHz; two machines available

44.1/48kHz Dual machines (5-in and 2-in):

Input Assignment	1 Left	1 Right	1 Center	1 Left Surround	1 Right Surround	Unused	2 Left	2 Right
Analog Input Channel	1	2	3	4	5	6	7	8
AES Input Channel	1 (L)	2 (R)	3 (L)	4 (R)	5 (L)	6 (R)	7 (L)	8 (R)
Output Assignment	Left	Right	Center	Left Surround	Right Surround	Unused	Lt*	Rt*
Analog Output Channel	1	2	3	4	5	6	7	8
AES Output Channel	1 (L)	2 (R)	3 (L)	4 (R)	5 (L)	6 (R)	7 (L)	8 (R)

* Lt/Rt denotes a matrix-encoded version of the 5-channel surround effects. This is implemented as a LexiconLogic encode and is compatible with most matrix encoding.

Control Mode: Clocks, Configuration, and System Screens, continued

In 2-in/5-out configurations the 960L generates surround soundfields from stereo sources. Again, all available machines are configured for surround or other multi-channel output. At 44.1/48 kHz sample rates

(Figure 4-8) two machines are both sharing the same output channels. On the display, the output paths of the two machines are colored differently for easier visibility.

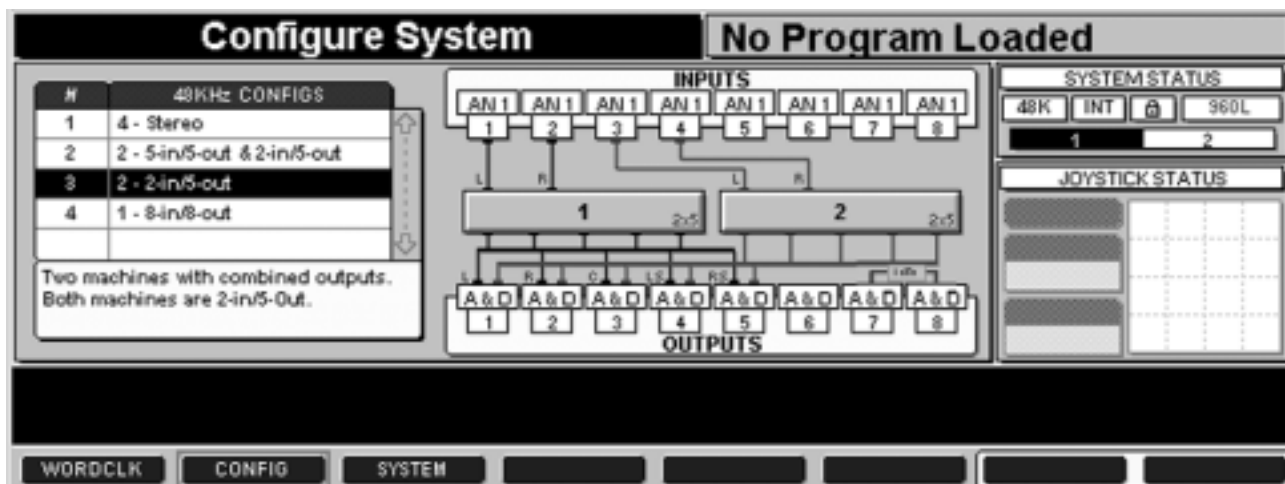

Figure 4-8 — 2-in/5-out configuration at 44.1/48 kHz; two machines available

44.1/48 kHz Dual machine (2-in and 2-in):

Input Assignment	1 Left	1 Right	2 Left	2 Right	Unused	Unused	Unused	Unused
Analog Input Channel	1	2	3	4	5	6	7	8
AES Input Channel	1 (L)	2 (R)	3 (L)	4 (R)	5 (L)	6 (R)	7 (L)	8 (R)
Output Assignment	Left	Right	Center	Left Surround	Right Surround	Unused	Lt	Rt
Analog Output Channel	1	2	3	4	5	6	7	8
AES Output Channel	1 (L)	2 (R)	3 (L)	4 (R)	5 (L)	6 (R)	7 (L)	8 (R)

Note: In the four configurations shown above, all available machines can be used for processing. Where more than one machine is available, each can be programmed individually.

There are also 8-in/8-out configurations (Figure 4-9). No effects processing is available in this configuration, but it is useful for wiring checks and diagnostics.



Figure 4-9 — 8-in/8-out configuration for 44.1/48 kHz (left) and 88.2/96 kHz (right).

Control Mode: Clocks, Configuration, and System Screens, continued

Analog and Digital I/O

The 960L may be set for either analog or digital input. In the Configuration examples shown above, the inputs are analog, as shown by the legend "AN1" above each input number. To select digital input, use the Navigation arrows to activate any Input Control, and press either the Increment (+) or Decrement (-) key. The input legends will change to "AES 1" (Figure 4-10). Note that all inputs are set to the same input type. The type can be set from any Input Control, and all inputs will change when a selection is made.

Note: The + and - keys both act simply as toggles when selecting input types; it does not matter which you press.

Although inputs to the 960 must be all analog or all digital, the processor always produces both analog and digital output, mapped channel for channel. As a reminder, all output channels carry the legend A&D (Figure 4-11).

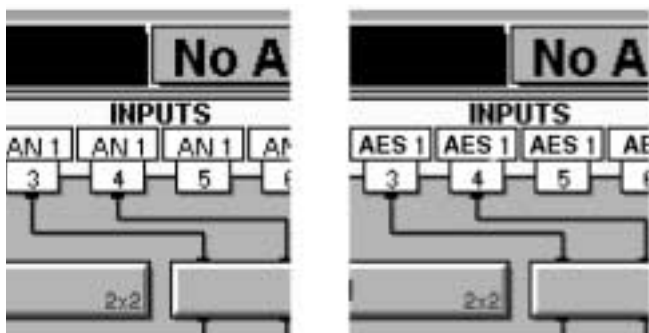

Figure 4-10 — Legends for Analog input (left) and AES/EBU Digital input (right)

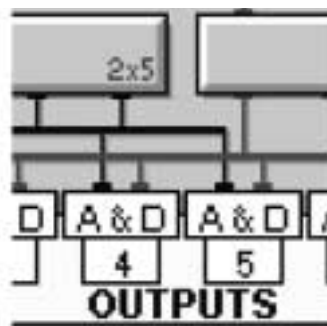

Figure 4-11 — All channels feed both analog and digital outputs.

System Screen

The system screen is useful for showing the software revision that is currently operating. If you ever need to

call your dealer, distributor or Lexicon Customer Service with questions about your 960L, make sure you know all the revision information.

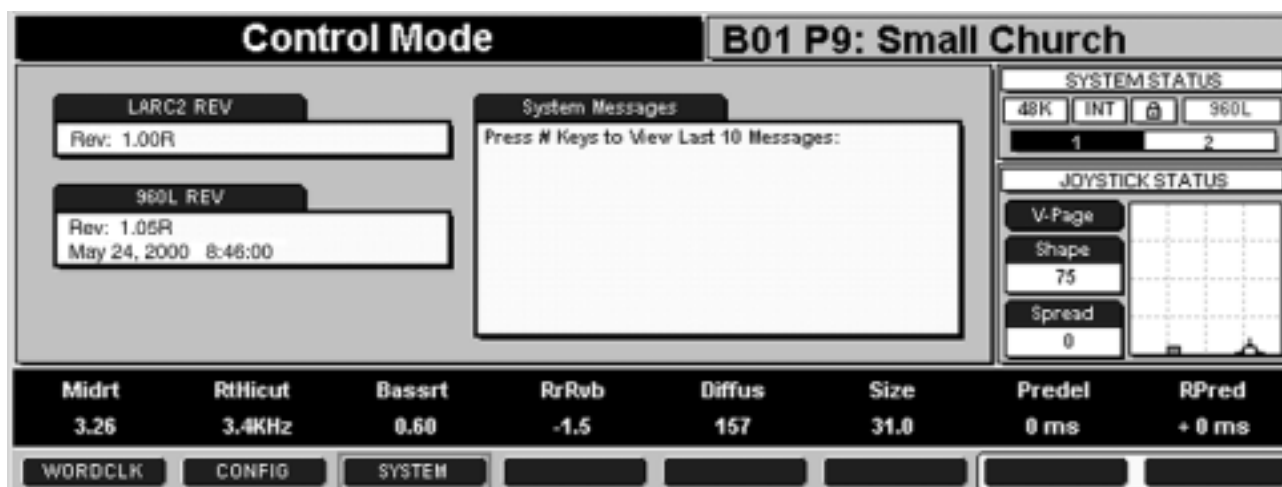

Figure 4-12 — Control Mode, System Screen

Editing

The 960L's Programs and Registers can be edited in several ways:

- Changing the settings of the parameters with the faders and joystick
- Adjusting input and output panning
- Adjusting input and output levels
- Assigning new parameters to any fader or to either joystick axis

Edits stay in effect until a new Program or Register is loaded, or can be saved as Registers. You cannot overwrite factory Programs, but you can save edited Programs as Registers. Registers, like Programs, reside on disk and can be recalled anytime. They can also be saved on floppy disk, for archiving or for copying to a second 960L.

Editing Algorithms

A Program or Register becomes edited any time you alter the current parameter settings with the faders or joystick. To save these—or any other—edits, just press the Store key, check to be sure the storage location is correct, then press Store again.

Editing With the Faders

- 1) Use the Numeric Keypad or Navigation Arrows to select the Edit page that contains the parameter you want to change.
- 2) Check the Scribble Strip to find the parameter to edit.
- 3) Touch the corresponding fader. That parameter will be highlighted on the Scribble Strip and its name and

setting will appear in large characters on the Action Display at the upper left of the screen.

- 4) Adjust the fader to the desired setting.

Fine Adjust

For some parameters, the range of possible values is so large that the smallest possible fader movements change the value too much.

To make fine adjustments, set the faders to the approximate values you want, then press the FINE ADJ Button. When this button is pressed, the faders all move to the center of their travel, but their parameter settings do not change. The faders then operate in a vernier mode, with a limited adjustment range and far fewer steps per inch of travel, so that full-range movement of the fader will alter the parameter value only a little from its coarse value. This makes it easy to tweak the setting to the exact value you want.

On entering fine adjust mode, the Action Display says "Fine Adjust Enabled". The centering of all faders is an additional indication.

Pressing FINE ADJ a second time will return the system to normal operation. The faders will return to their appropriate full-range positions.

When in the Edit Algorithm Mode, to make fine adjustments of a single parameter, simply touch the appropriate fader to select the parameter, then use the Increment/Decrement (+/-) buttons to get the setting you want. Each press of these buttons will change the parameter by its smallest possible increment.

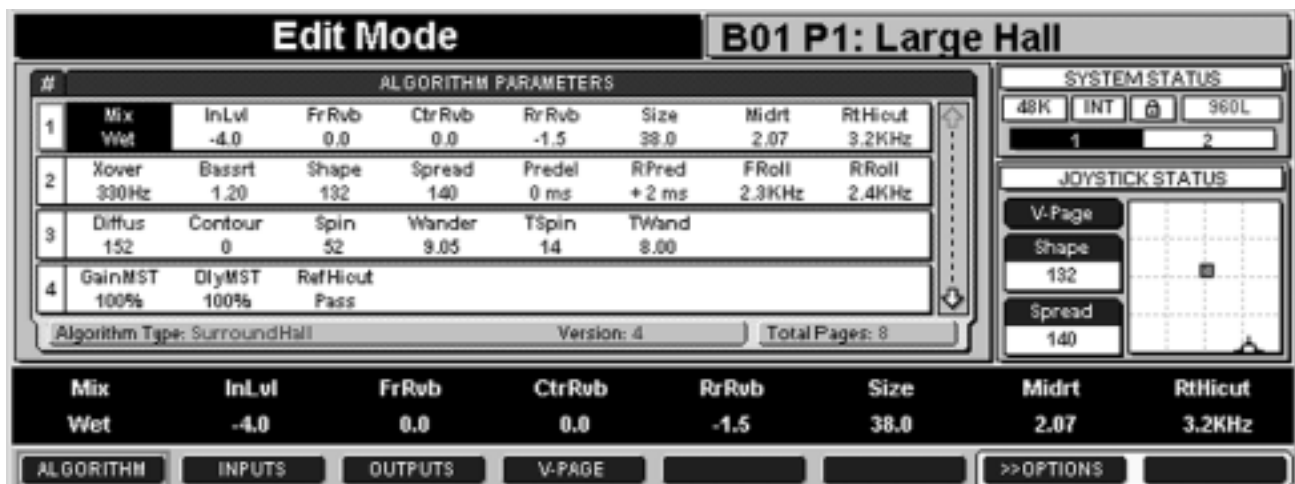

Figure 4-13 — Algorithm Edit Screen with one fader parameter selected

Editing, Continued

Editing with the Joystick

Check the Joystick Status Display to see what parameters are currently assigned to the joystick and what their current settings are.

Note whether the JOYSTICK Key on the LARC2 control surface is illuminated or not.

If the key is illuminated, the joystick is locked to the current parameter, and moving it will change the current settings. The setting dot is green and the joystick cursor will be superimposed on the Joystick Map section of the display, as shown on the right in Figure 4-14.

- Move the joystick. This immediately changes the parameter settings.
- The new settings can be read from the left half of the Joystick Status Display.

If the key is not illuminated, the joystick is not locked, and moving it will not affect parameter settings. The red setting dot and joystick cursor will normally be separated on the Joystick Map (as shown on the left in figure 4-14).

- Maneuver the joystick so its cursor lies near the red setting dot.
- Press the JOYSTICK Key on the LARC2 control surface, to capture the parameter. The setting dot will turn green and the JOYSTICK key will light. If the joystick cursor is not near the current values, the values will jump to the joystick position.

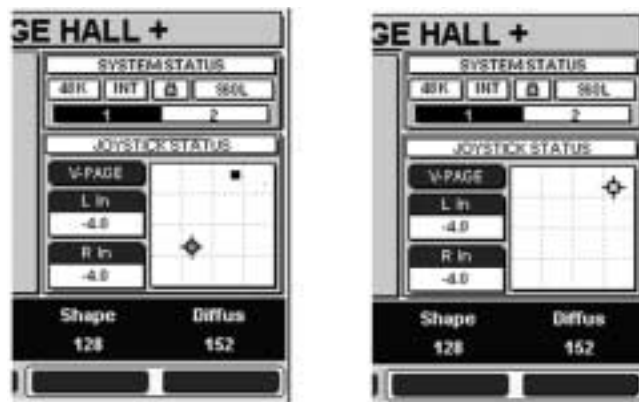

Figure 4-14 — Joystick Status Screen with joystick not locked (left) and locked (right).

Note: As it is possible for the joystick cursor to overlay the setting dot when the joystick is not locked, check that the JOYSTICK Key is illuminated or that the setting dot is green to confirm that the joystick is locked.

Quick Comparisons via the Lexicon Button

The Lexicon button provides a quick way to switch between the EDITS you have made on an Program or Register and the effect as originally loaded. When the Lexicon button is pressed, the original Program or Register will load and a red banner will be displayed at the bottom of the screen, saying "LISTENING TO ORIGINAL PRESET" (Figure 4-15). When the button is released, your last EDIT state will be reloaded and the red banner will disappear.

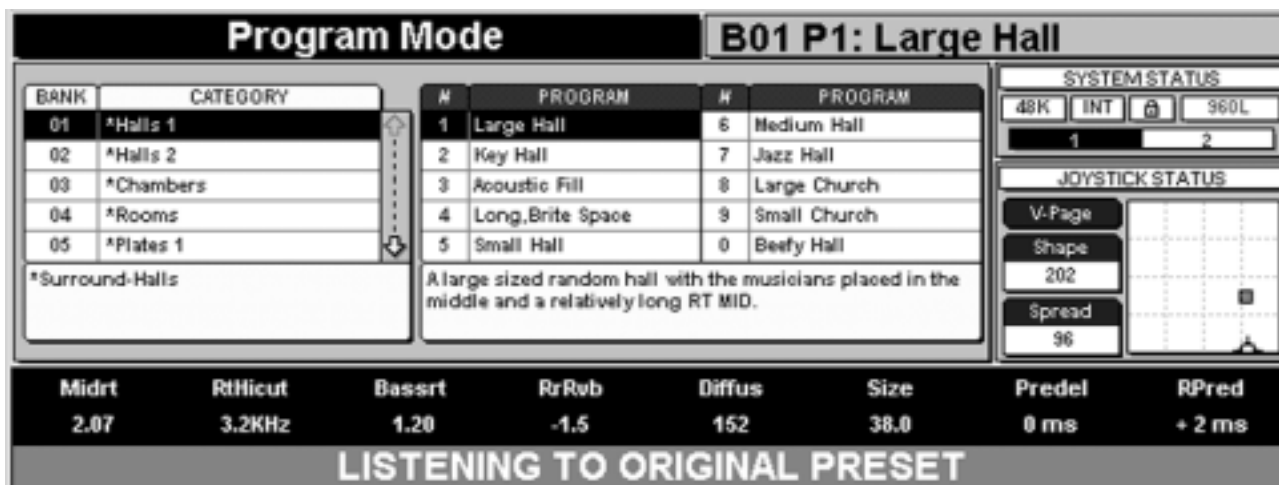

Figure 4-15 — Comparing edited with original Program or Register

Editing, Continued

Editing Inputs and Outputs

The LARC2's joystick can be used to place any input or output signals anywhere in the soundfield. Input and output levels can also be set, using the faders. Input panning and level adjustments are not "Global"; they affect only the current Program or Register.

You can see from the System Status Display at the upper right that two machines are in use and you are editing the inputs for Machine 1. The Main Operating Display shows that the current machine has five inputs and where each input signal is positioned in the soundfield.

Input Panning

To edit inputs, press the EDIT key, then the INPUTS soft button, to bring up the screen shown in figure 4-16.

In figure 4-16, the Left Surround input, channel 4, is currently selected, so its header is highlighted and its pan position is indicated on the Joystick Map. The JOYSTICK key is off, so the joystick has not captured the parameter – note the separate positions of the cursor and the setting dot.

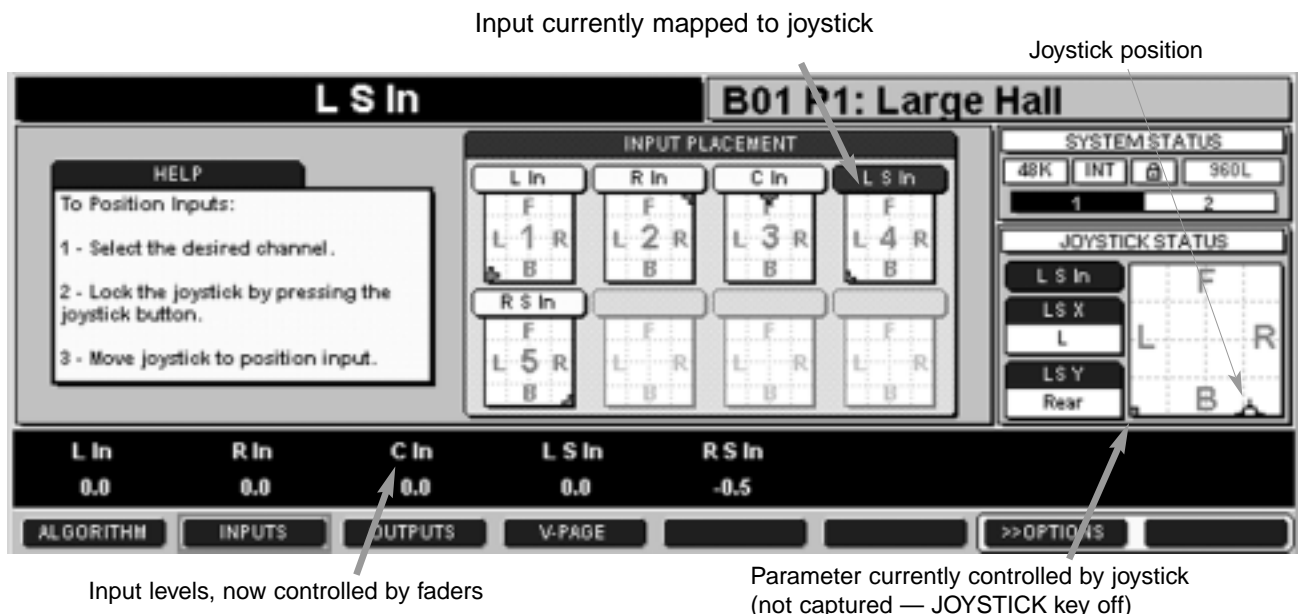

Figure 4-16 — Editing screen for input panning and levels, with joystick key off.

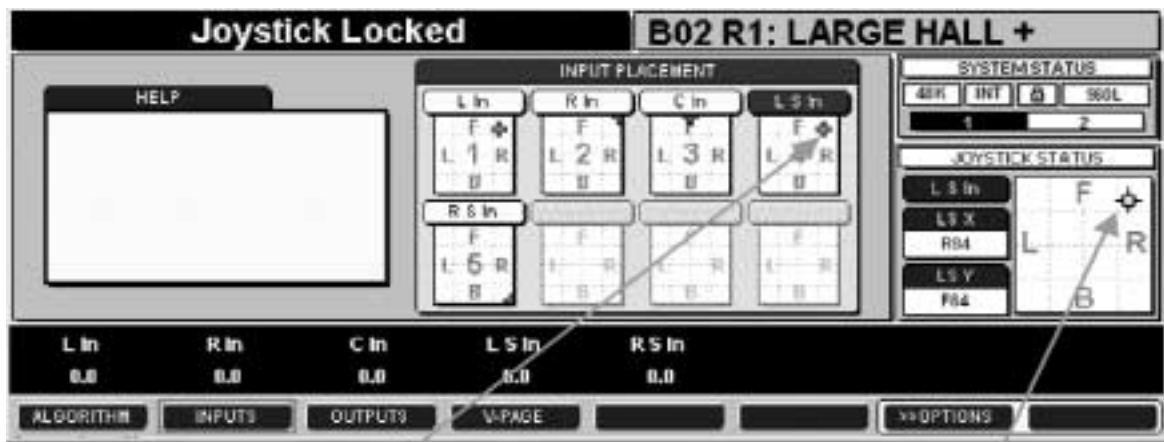

Figure 4-17 — Editing screen for input panning, and levels after panning with joystick.

Editing, Continued

When you press the JOYSTICK key, the input position jumps to the joystick position, and the setting dot turns from red to green, highlighting the joystick cursor (as shown on the Joystick Map and on the smaller map of the selected input). The legend "Joystick Locked" appears in the Action Display. Moving the joystick pans the selected input.

To pan a different channel, choose its number with the Numeric Keypad or shift to it with the Navigation Arrows and press the JOYSTICK key to lock.

Output Panning

To edit outputs, press the EDIT key, then the OUTPUTS soft button, to bring up the screen shown in Figure 4-18. You can see from the System Status Display at the upper right that two machines are in use and that you are working on settings for Machine 1. The Main Operating Display shows that five outputs are in use

and where each output signal is positioned in the soundfield.

In Figure 4-18, the Left output, channel 1, is selected, so its header is highlighted and its pan position is indicated on the Joystick Map. The Joystick has not captured the parameter, indicating that the JOYSTICK key is off.

Note: If you pan an output, keep the joystick moving! Panning an output signal permanently between channels causes a loss of spaciousness. (Due to the Haas effect, such signals will collapse into the speaker whose output reaches the listener first.) You can pan and position input signals at will – but don't pan output signals unless you keep them moving or finally place them in one speaker.

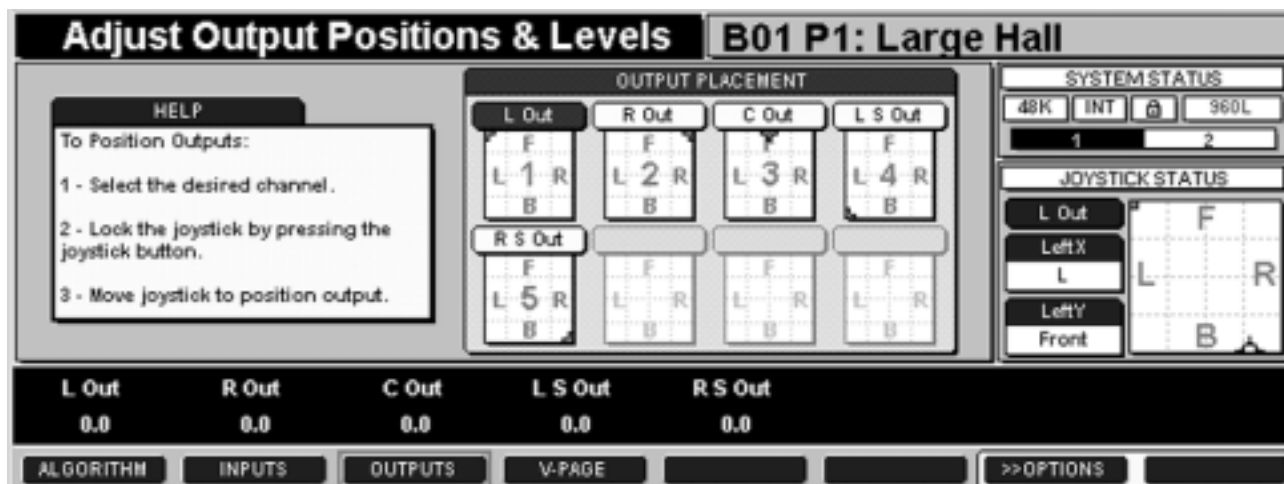
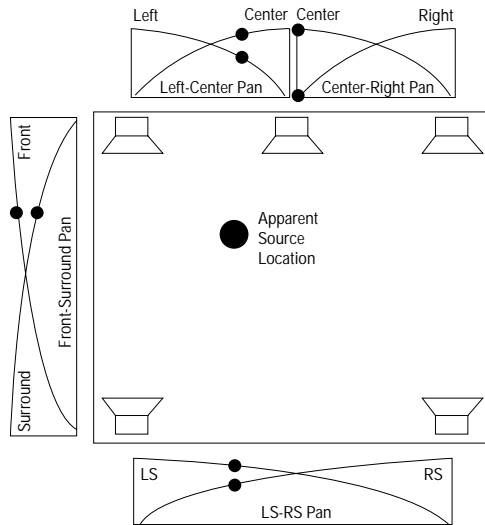

Figure 4-18 — Editing screen for output panning and levels, with joystick key off.

Editing, Continued



4-19 Panning Rules

The 960L Surround Panning Rules

The 960L does not produce a phantom center in surround modes, and no signal will appear in both the left and right output channels, no matter where you set the joystick. In other words, panning across the front is either between Left and Center or between Right and Center. For example, an output signal panned to position 1 in Figure 4-19 would appear in the left and center front channels and the left and right surrounds, but would not appear in the right front.

The 960L has true constant-power panning. As you pan a sound from one channel to the next, the sum of those channels' output powers will not change.

Setting Levels

In Input and Output Edit modes, moving any fader changes its associated signal level. The maximum level indication is 0.0 dBFS (digital full scale). You can move several faders at once. The channel assignments are grouped to facilitate this.

With outputs set to "0dB," a +4dBu analog input will produce a -20dBFS signal. This provides 20dB of "headroom." Optimum S/N is achieved when input levels are kept as close to digital full scale as practical.

Avoiding Overload

If all eight of the "Overload" LEDs on the LARC2's meter bridge light, the DSP is overloading internally. (Certain combinations of parameter settings can cause this.) Reducing input levels may or may not cure the problems.

If your edits create feedback, **press the MUTE MACHINE key** on the LARC2's Numeric Keypad to mute the output of the current DSP while you solve the problem.

If you're not sure which machine is causing the problem, press the **MUTE ALL** key on the Numeric Keypad.

Assigning New Parameters to Faders or the Joystick

Except in Edit modes, the parameter assignments of the faders and joystick make up what we call a virtual page, or V-Page. This is simply a convenient grouping of parameters to simplify operation, but you can group them any way you find convenient.

There are two ways to assign new parameters to the LARC2 controls:

- Assigning parameters from the V-Page
- Assigning parameters as an Edit option.



Figure 4-20 — Editing the V-Page

Editing, Continued

The V-Page and Parameter Reassignment

- Press the EDIT key on the LARC2 control surface.
- Press the V-PAGE soft button. The screen (Figure 4-20) shows the assignments for each of the eight faders and the joystick's X and Y-axes.
- Use the Navigation Arrows to highlight the Type or Parameter to change. (You can also select a fader or joystick axis with the Numeric Keypad, but you still have to navigate to the Type or Parameter.)
- Make your selection by cycling through the available Types or Parameters with the +/- keys or touch the fader of the desired parameter. The types are: "None", "Algorithm", "Input", and "Output". Some algorithms can have more than 50 parameters.
- The fader or joystick axis is now assigned to whatever parameter you've selected.

Using the Edit Algorithm Screen

This alternate method is a useful shortcut: If you're in the midst of editing algorithms, inputs or outputs, it enables you to quickly pick a parameter and assign it to a fader or the joystick.

- Push the EDIT key, then the ALGORITHM soft button, which brings up the Algorithm Edit screen. This holds all the parameters for the current algorithm, in up to ten "pages" of up to eight parameters apiece. (The highlighted down-arrow to the right of these pages shows that there are more pages below the screen; these pages can be reached by scrolling with the Navigation Arrow keys – or, if you know the

number of the page you want, entering that number on the Numeric Keypad.)

- Pick the parameter you need from this menu by navigating to it, which will highlight it.
- Press the Options soft button. This changes the soft buttons to "SELECT" (used for selecting algorithms), "V-PAGE" (for assigning parameters to faders), and "J-STICK" (for assigning parameters to the joystick.), and the soft-button background will change to yellow. See Figure 4-21.

Note: In Edit mode, the parameters and settings on the Scribble Strip are not a V-Page. They are the selected algorithm edit page, i.e., the row whose number is highlighted, in larger characters for easier reading.

On the Main Operating Display, parameters assigned to the V-Page appear in blue; all others are in black.

From the Edit (Algorithm, Inputs, Outputs) Options screen:

- Pressing the V-PAGE soft button pops up a numbered list of the eight faders and their assigned parameters (Figure 4-21). To assign your newly selected parameter to a fader, type the fader's number on the Numeric Keypad, or touch the desired fader.

Note: You must already have selected a parameter before you get to this screen.

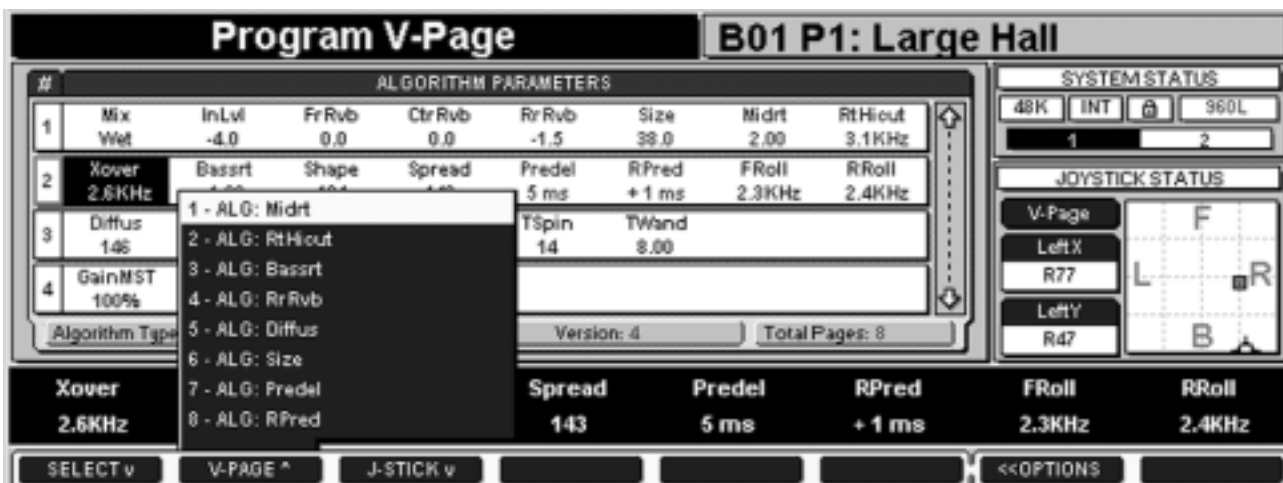

Figure 4-21 — Edit V-Page screen; programming faders.

Editing, Continued

- Pressing the J-STICK soft button pops up a numbered list of the two joystick axes and their assigned parameters (Figure 4-22). To assign your selected parameter to a joystick axis, type

the axis number on the Numeric Keypad.

Note: You must already have selected a parameter before you get to this screen.

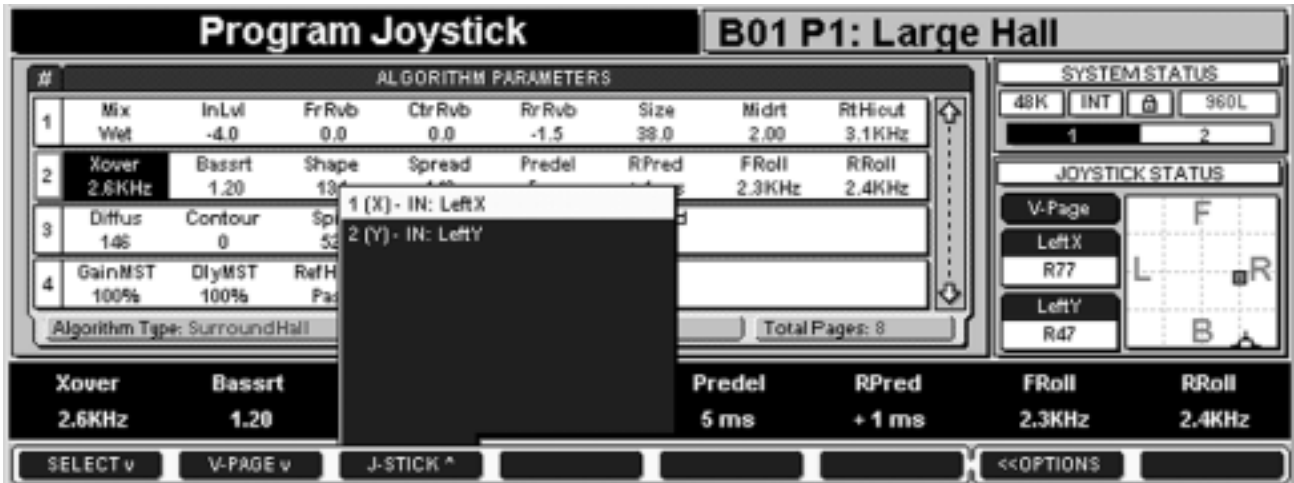

Figure 4-22 — Edit V-Page screen; programming the joystick

- Pressing the SELECT soft button pops up a numbered list of the algorithms applicable to your current configuration (Figure 4-23). If you select an algorithm here (by typing its number on the Numeric Keypad), a default Program will be loaded that is "typical" for that algorithm.

Note: This is a regular Program load and will destroy any parameter edits or V-Page creation you've done, if you haven't previously saved your work.

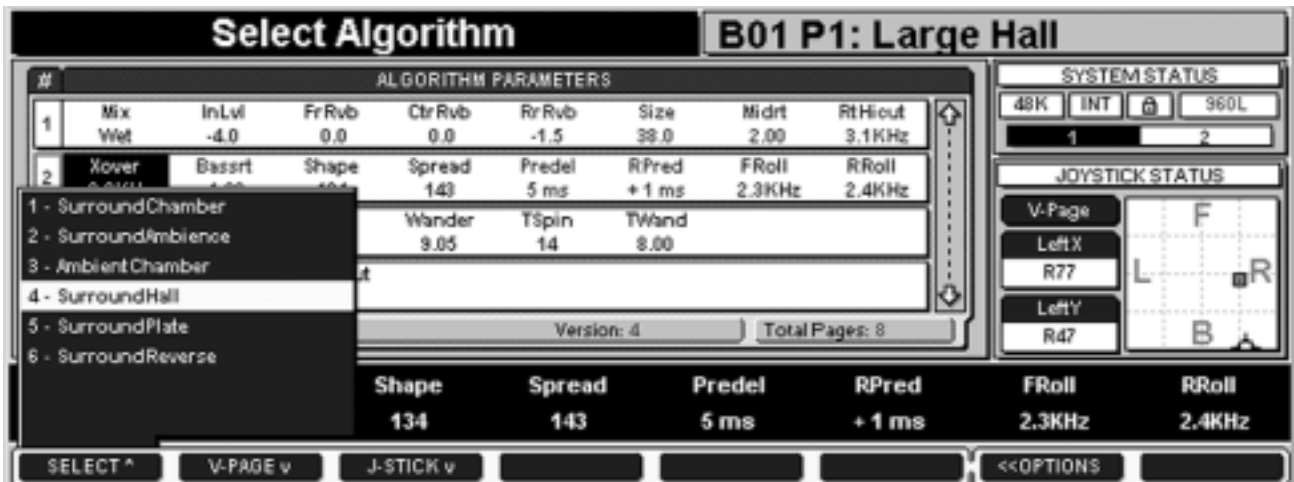

Figure 4-23 — Select Algorithm screen

Storing and Labeling Your Edits

When you've edited a Program or Register until it just meets your needs, you can store it as a Register and label it for future use.

Storing

- Press the STORE key on the LARC2 Control Surface.
- If you've edited a Program, the 960L will select the next empty Bank (or the Register Bank you last stored to) and Register.
- If you've edited a Register, the 960L will offer to overwrite the original version. To accept, press the STORE key again.
- To change the storage location, press the BANK key and enter the number of the desired Register Bank, or scroll to it with the Navigation Arrows. Then press REGISTER and select the desired Register in that Bank. Pressing STORE again will store your edits to that location. The Register you select can be an empty one, or you can choose to overwrite an existing Register.

Naming and Annotating

Registers and Register Banks can be given any desired name of up to 16 characters and can be annotated with up to 150 characters per Register and 100 characters per Bank.

- Press REGISTER to bring up the Register Load screen (Figure 4-2).
- Press BANK to name or add info to a Register Bank. Otherwise you will be working with the selected Register.
- Press the INFO soft button to bring up the annotation screen (Figure 4-24), which shows the information for the currently selected Bank or Register. (Pressing NAME brings up a similar screen.)
- The currently selected character will be outlined in red on the name line and in the character matrix below.
- Characters on the name line are selected with the increment and decrement keys (hence the "-" and "+" flanking the name line).
- Characters within the matrix below that line are selected with the navigation arrows.
- For faster text entry, a PS/2 keyboard can be plugged into the AUX jack on the back of the LARC2. The keyboard should be connected before power is applied to the 960L Mainframe.
- Just below the character matrix is a line that shows whether the system is in Insert or Overwrite mode.
- When editing the Information display, the screen will show the relevant name, Bank number, and Register number (if applicable) at the upper left.

When finished editing, either press the SAVE soft button or the ENTER key if you've annotated a Bank, or store the Register if you've annotated a Register.

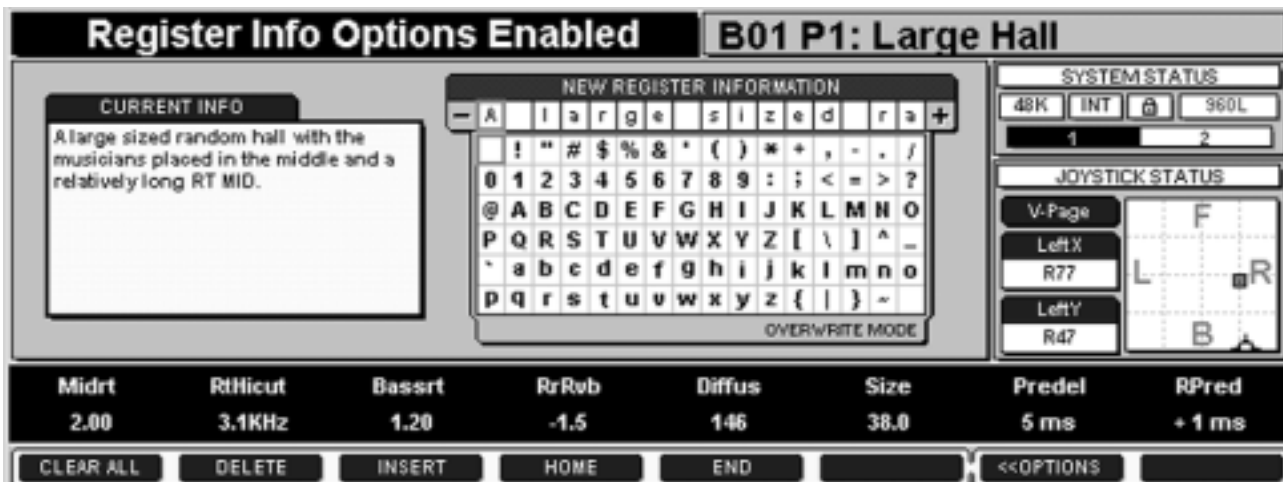

Figure 4-24 — Register Info Edit

Organizing Your Registers

The 960L provides tools to help you organize the registers you make. To access the tools, press the REGISTER key and then the OPTION soft button. Two soft buttons are displayed, EDIT and FLOPPY.

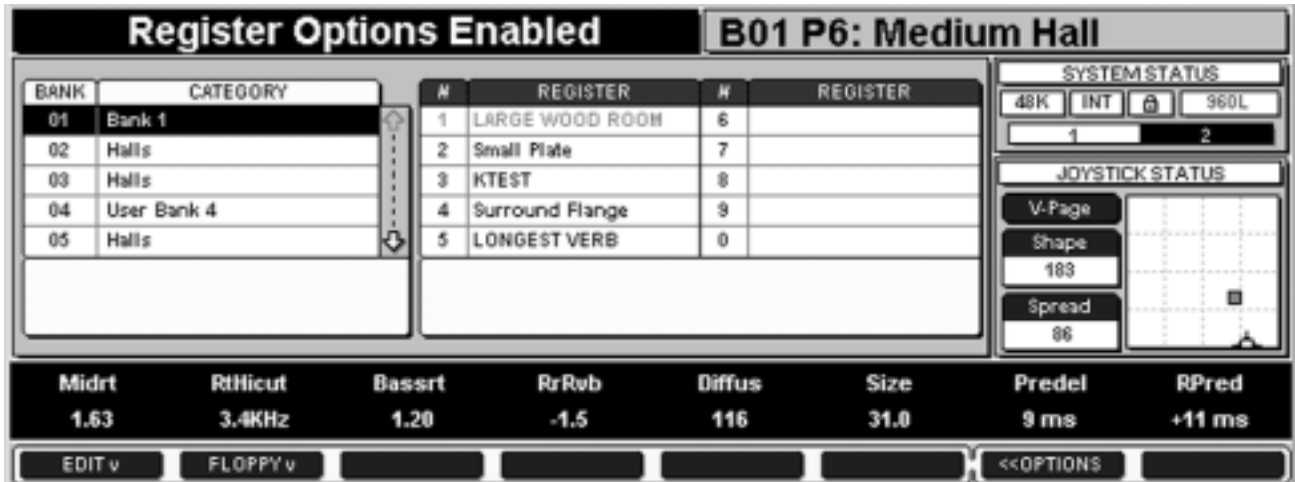

Figure 4-25 (a) — Register Info Options Enabled

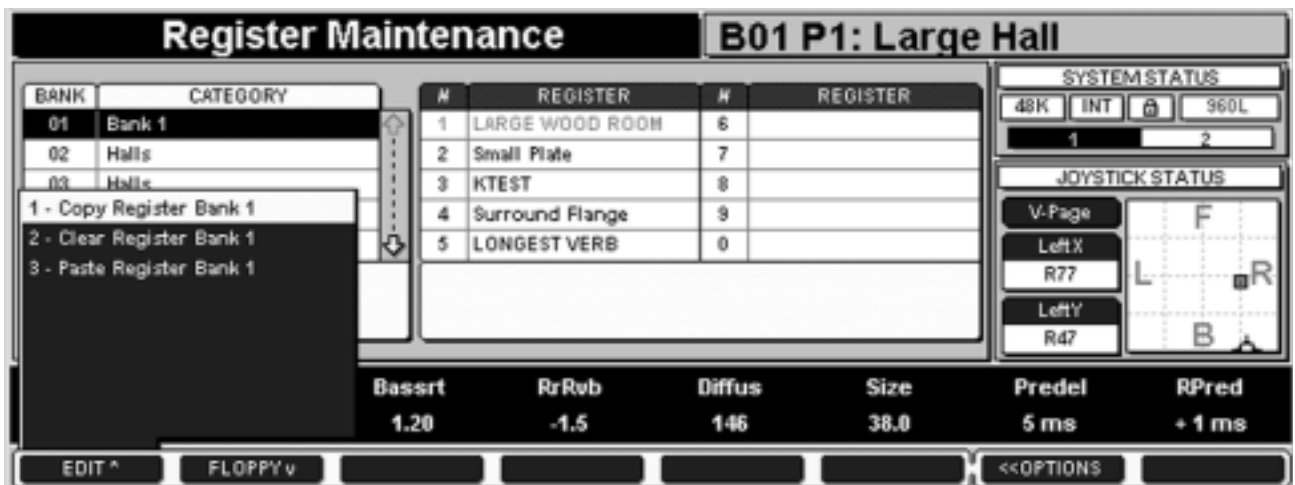

Figure 4-25 (b) — Edit Tools For Registers

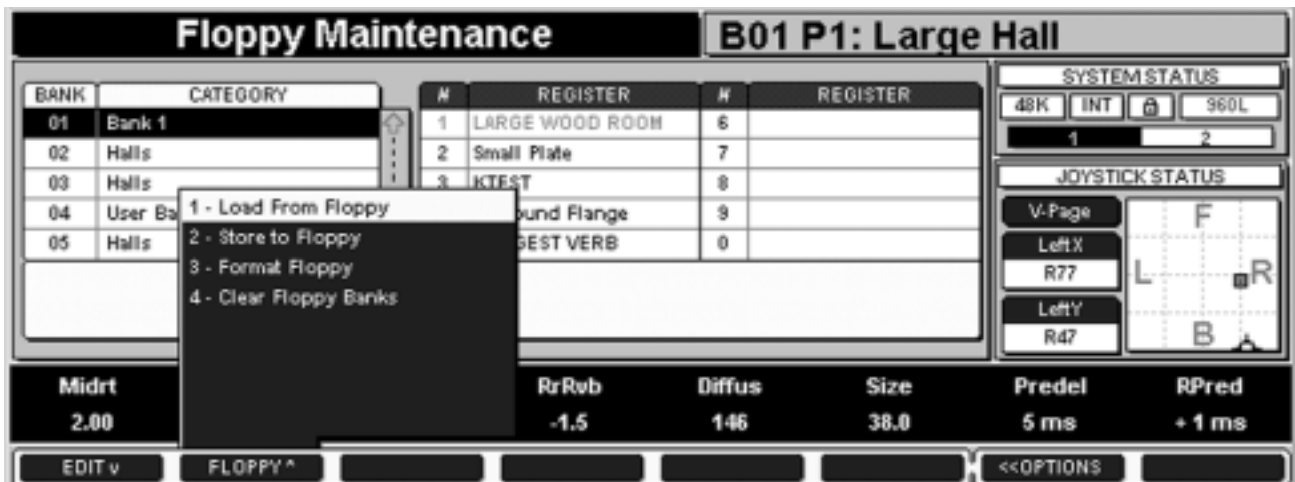

Figure 4-25 (c) — Floppy Tools For Registers

Edit Tools for Registers

Pressing the EDIT soft button accesses three tools:

- 1) Copy Bank -- When 1 is pressed on the Numeric Keypad, the contents of the currently selected Program or Register Bank are copied to an internal scratchpad.
- 2) Clear Register Bank – When 2 is pressed, the contents of the currently selected Register Bank are cleared. The Bank is made empty. For safety, the user is prompted before the clear is executed. Program Banks cannot be cleared.
- 3) Paste Register Bank – When 3 is pressed, the contents of the scratchpad are copied to the currently selected Register Bank. For safety, the user is prompted before the copy is executed. Program Banks cannot be pasted to.

Using the Floppy Drive

Pressing the FLOPPY soft button accesses four tools:

- 1) Load From Floppy – When 1 is pressed, the contents of the floppy disk are loaded into Register Banks 101-110. For safety, the user is prompted before the load is executed.
- 2) Store to Floppy – When 2 is pressed, the contents of Register Banks 101-110 are written to the floppy disk. For safety, the user is prompted before the load is executed.
- 3) Format Floppy – When 3 is pressed, the floppy is formatted in IBM 2HD format. For safety, the user is prompted before the format is executed.
- 4) Clear Floppy Banks – When 4 is pressed, Register Banks 101-110 are cleared. For safety, the user is prompted before the clear is executed.

The files written to the floppy disk can be read and archived on any PC running Windows 95, 98, or NT.

The CD-ROM

Software updates will be made available on CD-ROM. Instructions on how to load from CD-ROM will be provided with each disk.

Machine Mode

If the 960L is configured as multiple machines, which can be seen from the bottom line of the System Status Display, pressing the MACHINE key on the LARC2's control surface will show you which Program or Register each machine is running (Figure 4-26).

The currently selected machine will be highlighted in the list in the Main Operating Display and in the System Status Display. To switch to a different machine, enter its number on the Numeric Keypad (or scan up or down to it with the Numeric Arrow keys and press the ENTER key).

The fader and joystick assignments on the V-Page will then change to those for the machine you've selected.

Machine Shortcuts:

- 1) If you know the number of the machine you want to access, simply press and hold the Machine key on the LARC2 and enter the number – you needn't wait for the Machine Mode screen.
- 2) Hold down the MUTE MACHINE button and, on the numeric keypad, press the number of the machine you wish to mute or unmute.
- 3) Hold down PROGRAM or REGISTER and, on the numeric keypad, press the number of the machine you want, and you will be in PROGRAM or REGISTER mode for that machine.
- 4) Hold down STORE and press the number of the machine you want and you will be storing the edits currently on that machine.

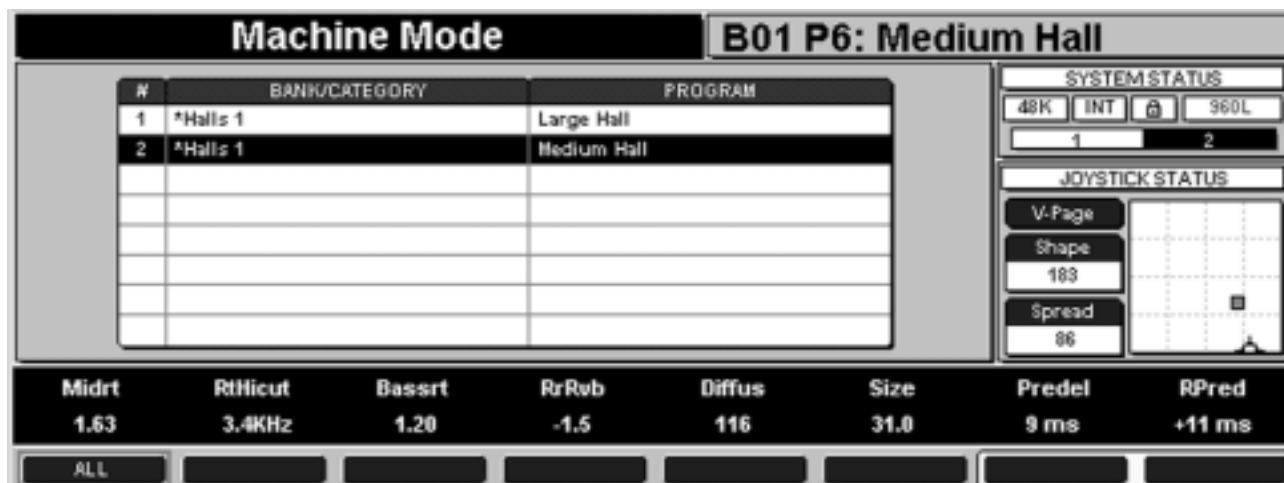

Figure 4-26 — Machine Mode

5

Using the Reverb Programs

REVERBERATION AND REALITY	5-1
SOUND IN SPACE: A SHORT HISTORY OF STEREO AND SURROUND	5-5
ALGORITHMS	5-6
Random Hall	5-6
Surround Hall	5-7
Chamber	5-7
Plate & Surround Plate	5-7
Ambience & Surround Ambience.....	5-7
Ambient Chamber	5-8
Reverse & Surround Reverse	5-8
Inverse	5-8
PARAMETERS USED IN THE 960L ALGORITHMS	5-9

Using the Reverb Programs

Music recorded in a typical studio sounds dull. In a performance space the music is enhanced by reverberation, but even in an ideal space capturing that reverberation can be chancy. Lexicon reverberators solve this problem by enabling you to generate exactly the reverberance that your recordings call for, even with multitrack originals made in imperfect spaces. You can make your listeners feel they are sitting in a real concert hall, even though they are in a small room with hard, flat walls. The object of the 960L is to create, in the studio, the acoustics of any real or conceivable space, and to reproduce these acoustics using the full directional capabilities of a modern surround system.

Reverberation and Reality

The acoustics of a given space are defined by its reflected energy – that is, the way sound is reflected and re-reflected from each surface. This is affected by the dimensions of the space, the complexity or flatness of the surfaces, the frequency characteristics of each surface's energy absorption, and the distance and direction of each surface to the listener. In addition, in large spaces there is a high-frequency rolloff caused by the sound's passage through air.

It is in principle possible to model the reflected energy pattern in a specific space, either real or imagined, and to reproduce this pattern as closely as possible through a five-loudspeaker array. Alternately, one could measure the reflection pattern from a specific source point in a real space to a specific receiver position, and reproduce this pattern through five loudspeakers. One might expect this technique would yield the most accurate sonic representations of halls and rooms.

Alas, the illusion of reality is not so easily achieved. First, real spaces are themselves a compromise. Small rooms (and stage houses) tend to provide a sense of blend and distance to music, but provide little warmth and envelopment, and often can make the sound colored or muddy. Large rooms can provide envelopment, but often the sound can be too clear and present, with the instruments seemingly stuck in loudspeakers.

To make matters worse, in a real space every musician will have a completely different reflection pattern from every other musician, and every listener will have a different pattern from every other listener. In addition, reproduction of a given sound field through a loudspeaker array is only possible if the listener occupies a single, known position. If our goal is to create a believable room impression over a wide listening area – and this should be our goal – then we better do something else.

Our solution has been to study the physics and the neurology of human hearing, to discover the mechanisms by which reflected energy patterns create the useful perceptions of distance and envelopment, and to discover how to recreate these perceptions without compromising clarity. Using a knowledge of these mechanisms we can create reverberation devices that can give the desired acoustic impressions – rooms that sound plausibly real, but that give the recording engineer complete control over the sense of distance and the sense of envelopment. These rooms seem real, but they are not. They are designed and adjusted by the engineer to the specific needs of the recording, and they create their magic uniformly over a wide listening area.

To see how this works, consider a concert space – a large hall. In this space we hear a sonic event as a whole package of sounds, consisting of direct sound, various early reflections, and finally the reverberant tail. The sound that reaches us directly from the performer tells us the horizontal (and possibly the vertical) direction of the sound source; the reflections that follow give us cues for determining the distance to the source, and give us some information about the space.

Yet describing acoustics through the concepts of direct sound, early reflections, and reverberation is misleading from the point of view of human perception. Direct sound, early reflections and reverberation are only meaningful when the sound source is a very short impulse, like a pistol shot. Real sound sources produce sound events of finite duration (notes). The duration of a note is typically longer than the time between the direct sound and the early reflections. The length of time a note is held dramatically changes the acoustics we perceive, as short notes excite primarily early reflections, and long notes excite the later reverberation.

For example, in real rooms the direct sound is primarily perceived at the onsets of sound events (notes.) When a sound starts abruptly there is a brief instant where we can hear the direct sound all alone, before it is corrupted by or overwhelmed by reflected energy. In this brief interval we can detect the direction, and sometimes the elevation of the source. The so-called "early reflections" are only audible after a note starts. They are sometimes audible as a change in localization or timbre while a note is held, but in general they affect perception most strongly only after a note ends. These reflections are heard in the space between notes – and then often only as a tendency to make the notes sound longer than they actually are. Reverberation also is nearly always heard after the ends of notes, either in the space between notes, or at the end of whole

Reverberation and Reality, Continued

phrases. Reflections alter our sense of direction, distance, and hall shape in ways that depend on the duration and complexity of the notes, and on the properties of the spaces between notes.

But human perception is more complex than just direction, distance, and room shape. We are reacting to the music on quite a different plane. Directional localization is not an object in itself – it is a tool that helps us separate one musical line from another, and thus helps us grasp the intellectual and emotional content of the music. The sense of space is also not particularly interesting in itself. It is the emotional effect of the space that makes the perception worth the trouble. It is hard to separate the awe inspired by the sound of a Gothic cathedral from Gregorian chant – chant was developed to work alongside this awe, and to enhance it. Listen to the cellos and basses play a pizzicato bass line in a dead opera house, and feel how each note falls lifeless. Add an enveloping reverberation and each note takes a life of its own – swirling around us as the notes decay and pull on our heart with sadness or joy. Are we aware of these effects? A trained listener can be, but most listeners can only describe the emotional impact. This impact can be very real.

The sense of distance has a similar emotional effect. When the direct sound is too strong voices and instruments seem to be stuck to the speaker – up front and in-your-face. This perception is particularly strong when an engineer tries a 5.1 mix for the first time. Put the vocals in the center speaker and Bam! they whack you in the face. The up-front perception is psychologically important. But you want to use it with great caution. Sometimes it is just the effect you want, but after a sustained period the listener can tire, and psychologically back away. This is probably one of the reasons many engineers raised on two channel stereo prefer a phantom center to a hard center. The phantom may be just as up-front, but there is no speaker in that position, so it seems more acceptable.

There is another solution. Humans perceive distance in large part through the strength and time behavior of reflected sound. In a typical room the direct sound arrives uncorrupted by reflections. If the sound has a fast rise-time the ear is able to determine the direction of the sound by using the interaural time delay and the interaural level differences as cues. After 10ms or more reflections start to arrive – contaminating the time and level differences and making localization difficult. Our brains are able to use this reduction in localizability of the sound as a distance cue – the degree to which

precise localization is reduced after the onset of a note is a cue to both the size and the furnishings in a room.

Reflections from almost any direction EXCEPT the direction of the sound source can create this sense of distance, and they can come at a great variety of times after the direct sound. However, there are optimal directions and optimal times. The optimal direction is frequency dependent. For frequencies below 700Hz the optimal direction is from the side (90 degrees from the front). At about 1500Hz the optimal direction is +/- 30 degrees from the front (the standard front speaker angle.) Reflections that arrive earlier than about 15ms from the direct sound begin to interfere with localization, and can cause comb filtering and timber alteration. Reflections that arrive more than 50ms after the direct sound can be heard as separate sound events, and can cause serious problems with intelligibility.

Thus if we add reflections to the left and right front speakers and the left and right rear speakers, and adjust the time delay so these reflections occur between 15ms and 50ms, we can move the vocals out of our center speaker. The vocals are pushed back into a space behind the front speaker array. It seems magical – we are increasing the perceived distance to a source in the center speaker by adding reflections to all the other speakers EXCEPT the center speaker – yet this is the result of some very simple psychophysics.

Remember that we are not perceiving the individual reflections separately – we are only perceiving their ability to mess up the localization of the direct sound. Because there is no actual perception of the reflections themselves the distance perception (perhaps the "room" perception would be a better description) is bound to the direction of the direct sound. If the direct sound comes from the center speaker, the "room" impression seems concentrated in the front of the listening space, even though the reflections that produce it are coming equally from the front and the rear. Switch the direct sound to the left rear, and the "room" impression also switches to the left rear, even without altering the reflection patterns at all.

Thus for producing the perception of "room" or "depth" it is not necessary to have reflection patterns that mimic a particular source position in a particular room. It is only necessary that the reflections be primarily in loudspeakers NOT in the same direction as the sound source, and that the time delays of the reflections in each loudspeaker should be different. This makes our life much simpler – we can use a two channel echo

Reverberation and Reality, Continued

send if we wish, and control the distance or depth of each sound source by controlling the amplitude of this source in the echo send.

But distance is not the only perception we need. We need the envelopment that makes notes come alive. How can we produce envelopment with a 5.1 system? Once again the key is the way reflections affect horizontal localization. Our brains have an exquisitely sensitive detector for differences in sound arrival times between our two ears. These time differences are converted into perceived horizontal angles, or azimuth. In the presence of reflected energy – particularly reflections not in the direction of the source – the time differences are not constant. As reflections come and go the time differences (and level differences) fluctuate, with the amount of fluctuation depending on the direction and strength of the reflections.

When the sound source is continuous – like legato strings, or pink noise – we perceive these fluctuations as an enveloping room impression. The time delay of the reflections does not matter very much, as long as they are longer than about 10ms. (Below 10ms there are severe combing effects we will try to avoid in this discussion.) But most musical sounds (and all speech sounds) are not continuous.

To understand what happens with speech or music we must learn how the brain separates sounds into streams. Streams are the perceptual equivalent of musical lines. Sentences from a single talker form a stream. A stream has in general a specific source and a single continuous semantic content. However the streams themselves are not continuous at all – in music the streams are composed of notes, in speech streams are composed of phones – little bursts of sound roughly equivalent to syllables. When we hear a string of phones, our speech apparatus goes into high gear. First we must separate the phones one from another, then we must use frequency and time information to assign an identity to each phone – at which point the phone becomes a phoneme, the basic building block of speech. From phonemes to words, from words to sentences, from sentences to meaning – all seemingly effortless and automatic – our brains decode the spoken word.

The perception of envelopment is a useful by-product of stream formation. To form a foreground stream the brain must separate the sound events related to a single source from the total sonic input. To do this we must be able to detect when a single phone starts, and when it stops. Detecting the start of sound events is easy – we just look for a rapid increase in level. How do we know when one phone stops and another starts?

There are only two ways possible – we can detect the stop of a phone, or we can assume it has stopped when we detect the start of another. Naturally, we do both. But if we are to hear background sounds at all, we must detect the stop of phones before a new phone starts.

How do you know if a phone has stopped? We can do an experiment – about a 2dB drop in level in a 20ms time period seems sufficient. What if the level drops more slowly? Experiment shows that even with a slow drop a 6dB change is sufficient. What if the sound drops in level by 2dB, and then within 30ms comes back up again? (This drop could be caused by a low-level reflection.) It turns out the level rise – if it occurs within 50ms of the first drop in level – tends to cancel the effect of the first level drop. The brain assumes the phone is continuing.

In general, to find the ends of phones the brain looks for a level drop, and waits for 50ms to be sure the level stays down. If it does, the sound event – the phone – is assumed to have ended. Now imagine another simple experiment. You are listening to someone talk in a noisy room. You can easily understand the person, but you are aware of the noise in the room – which is perceived as continuous. How can this be? It is clear that during the phones of the person who is talking you are unable to hear the room – the phones are masking the background. Yet you perceive the background as continuous.

The brain is clearly separating the sound of the room into a separate stream – the background stream. The neurology that detects the background stream works in the spaces between phones. Thus it cannot work without the participation of the mechanism that determines the ends of phones. Again we can experiment. It turns out that the background detection is inhibited during phones, as we would expect, and is still inhibited for the first 50ms after the end of each phone. After this time the inhibition is gradually released, so the background detector has full sensitivity within 150ms after the end of each phone. The loudness of the background is then perceived through a standard loudness integration, taking about 200ms for full loudness to develop.

It is the background perception of reverberation that gives us the sense of envelopment. Clearly it is the reflection level 150ms and more after the end of sound events that matters. Note that the relevant time is after the END of sound events. We are conditioned by years of looking at impulse responses to think about reflections as always coming from hand-claps or pistol shots. In speech and music it is the behavior of reflected energy at the ends of sound bursts of finite

Reverberation and Reality, Continued

length that is perceived, and the behavior of the reflections can be quite different when the sound event is short compared to when the sound event is long. Notes which are shorter than the time constant of the reverberation, $\sim RT/7$, will excite the reverberation less strongly than longer notes.

There is another peculiarity of background envelopment. It depends on the absolute level of the reverberation, and not the direct/reverberant ratio. If we play the music louder the reverberation will be louder, and the sound will be more enveloping. Thus when we mix for envelopment we must be very careful about our monitor levels, and aware of how loud the critical customer will play our mix.

The perception of background envelopment depends on the same fluctuations in interaural time delay that cause the sense of distance. But the background is only detected when the direct sound has ceased, and only reflections are hitting the ears. Thus if the reflections come from all around us the fluctuations, and the sense of envelopment will be maximum. If reflections come only from the front we will not get much envelopment at all.

The perception of envelopment requires that the interaural time delay and level differences should be fluctuating. In a small relatively dead room the only way these differences can fluctuate is if you have at least two sound sources, and the relative phase between these sources is fluctuating. (Ideally these sound sources should be reproducing decorrelated reverberation.) The optimum direction for these two sound sources (loudspeakers) depends on frequency. Once again below 700Hz the optimum direction is from the side, and as the frequency goes up the optimum angle moves toward the medial plane – closer to the front, or closer to the rear.

Although envelopment can be perceived at all frequencies, psychologically the low frequencies are particularly important. For example, even in a dead room a standard two channel loudspeaker system (± 30 degrees from the front) can produce envelopment if the sound source is decorrelated and contains primarily frequencies above 1000Hz – such as strings or applause. But low frequency envelopment, the life blood of lower strings and basses, is missing. Add low frequency uncorrelated reverberation to loudspeakers at the sides, and the life magically returns. (For a more thorough overview of this subject, see David Griesinger's web page at www.lexicon.com/links.)

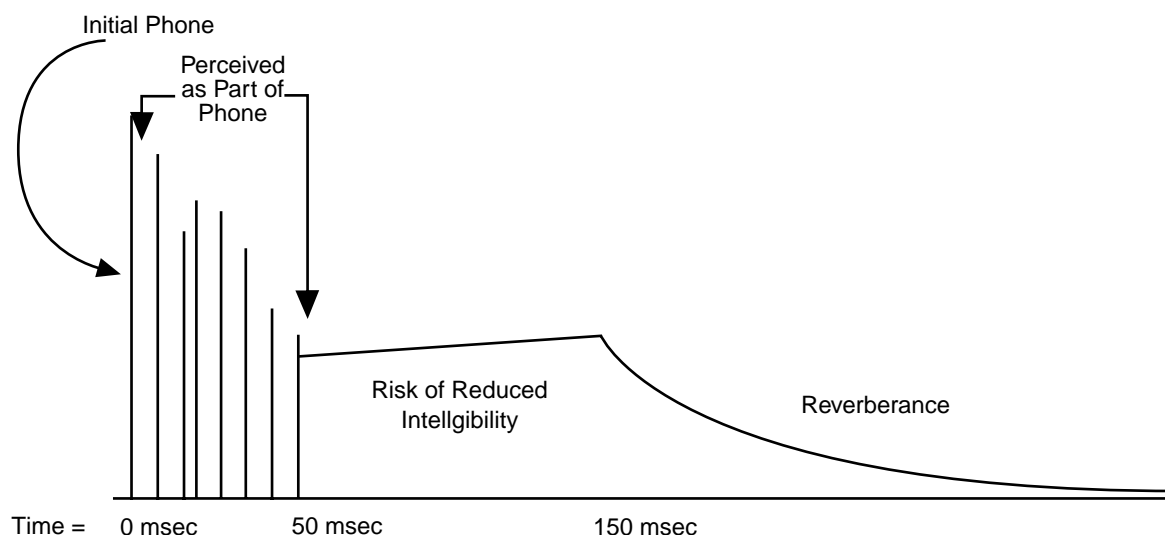

Sound in Space: A Short History of Stereo and Surround

The earliest efforts to improve sound reproduction concentrated on broadening frequency response and reducing distortion and noise. But even by the late 1930s, it was obvious that eliminating those barriers to sonic realism weren't enough. The spatial element was missing.

The first attempt to restore this missing element was stereophonic sound, introduced to the American public via the Walt Disney film *Fantasia*, in 1941. Its three-channel process could simulate surround directionality by steering signals to speakers around the theater, but was not true surround. Progress in stereo stalled during World War II, but in the early '50s, stereo reappeared with the advent of CinemaScope and similar widescreen processes. Shortly thereafter, stereo became available for home listening, first via tape, then phonograph records, and finally, via FM radio.

Stereo added directionality and ambience. The directionality was useful in movies and opera, but otherwise of minimal concern to listeners. Room ambience proved to be stereo's real selling point for music, helping create the illusion that the listener was in a better acoustic venue than his living room. Some of that illusion had been created in mono days by the inclusion of reverb in the final mix, largely produced in echo chambers (small, hard-surfaced rooms containing speakers to reproduce the original sound and microphones to pick up the added echoes). But in mono, reverb levels had to be limited to avoid muddying the sound. With stereo, the listener could more readily pick out specifically positioned performers from the general ambient background, enabling the amount of reverb to be increased.

At the same time, music was being recorded more and more with close-miked multi-track techniques that did not capture the original ambience, and in studios where there was little or no ambience to capture. This accounts in large measure for the popularity of reverb processors such as the Lexicon 480L.

Even with stereo, some spatial elements were missing. In real life, we hear sounds and ambience from all around us, not from just the front of the room. Adding additional channels at the sides or rear of the room seemed the answer, and surround sound made its appearance in movies and in the home in the 1970s. In films, where it served a dramatic purpose and where a three-channel front speaker arrangement was standardized, it succeeded.

For several reasons, surround sound flopped in the home. There was a confusing array of recording formats, each requiring slightly different playback gear. The few quadraphonic recordings available were split among these formats, reducing the choice still further for listeners who were not equipped for every format. Record producers could not decide whether to use the extra channels to encircle the listener with performers or to provide a front soundstage with surrounding ambience. Most surround setups placed the extra speakers in the rear corners of the room despite the ear's low sensitivity to lateral directional cues from behind. And many consumers balked at the idea of placing two more full-sized speakers in their rooms. A major reason for the failure of home surround was the recommended four channel format. Without a center channel, Quad sound did not improve the listening area over two channel stereo. To hear a recording one had to be in the "sweet spot", a requirement that was greatly reduced in cinema surround.

Surround's salvation came from the movies and the development of stereo VCRs. The widescreen films of the 1950s carried multi-track sound on magnetic stripes, but rear speakers mainly carried effects and were often shut off between effects to reduce noise from the narrow, hissy, mag stripes. With the advent of 70mm film, which had more room for soundtracks, mixers began using offscreen channels to carry low-level effects on a continuous basis, adding to the films' sonic realism.

But most theaters were equipped only for standard 35mm films. In 1976 Dolby Labs introduced Dolby Stereo, a matrix process that encoded surround sound into two-channel optical soundtracks that were compatible with standard cinema projectors. This enabled a single release print to be used in theaters with mono, stereo, or surround sound systems. When these films were released on stereo videocassettes in the early 1980s, the surround information encoded in their two-channel soundtracks was carried over to the home. With the addition of a low-cost matrix decoder and additional amplifier and speaker channels, a consumer could now have surround when watching movies at home via tape and, eventually, via broadcast. Even some made-for-TV programs incorporated surround.

At least for home video, there was now a substantial body of software with a common surround format. There was also general agreement on where speakers should be placed: three in front instead of two, and a pair of surround speakers on the side walls. Home theater began to take off, aided by the arrival of comparatively

Sound in Space: A Short History of Stereo and Surround, Continued

affordable large-screen TVs, Dolby Pro Logic, which added logic steering to the basic matrix decoder, and Home THX cinema, which imposed common standards on home surround equipment. Pure audio recordings with matrix surround encoding began to appear, although when reproduced with Pro-Logic or THX matrix decoders these recordings could be disappointing.

In the early 1990s Dolby Digital, DTS, and MPEG surround arrived. These systems provided discrete digital signals for each channel and a separate Low-Frequency Effects (LFE) that provided very low frequency sound effects. Squeezing 5.1 discrete digital channels into a recording involved some data reduction, but the reduction schemes used psychoacoustical principles to make the resulting artifacts less audible. Dolby Digital soundtracks were the first to make the transition from movie theaters to the home, via laser disc. With the advent of DVD, whose popularity rapidly eclipsed laser discs, Dolby Digital and DTS tracks became more widely available for home theater.

The discrete digital technologies require specialized hardware for playback, and the original source material cannot be recorded on home tape recorders, VCRs, or broadcast over conventional broadcast equipment. More importantly more and more consumers were installing surround sound systems in their homes, and there was a great need for a technology that would allow standard two channel recordings to be reproduced in a surround system. Not with Dolby Pro Logic, which narrowed the front image and provides a monaural surround signal, but with a system that offered a wide front image over a large listening area, and the listener envelopment present in the original recording location.

To solve both problems Lexicon developed LOGIC7 matrix technology, which provides a method for releasing surround recordings on standard stereo compatible CDs. More importantly, LOGIC7 and LexiconLogic provide a method of playing the millions of standard two channel music recordings with all the advantages of discrete surround.

LOGIC7 also allows Dolby surround films to be played with a wide frontal image and full rear envelopment. LOGIC7 encoded recordings can be broadcast or played on any currently available reproduction equipment, and yet they provide full five channel surround on a device with a LOGIC7 decoder, and decent four channel surround when played with Dolby Pro Logic. LOGIC7 uses matrix technology to compress the spatial aspects of a recording so it can be delivered on a two channel format. There is no data

reduction of the sound waveforms themselves, so the sound quality can be very high.

Competing with LOGIC7 and the current data-reduced discrete technologies are two audio disc formats based on DVD technology, DVD-Audio and SACD. These promise to deliver discrete 5.1-channel surround without data reduction. These encoding technologies promise higher fidelity than CD, thanks to 96-kHz/24-bit recording—a signal format for which the 960L is already prepared. The eight-channel design and modular construction of the 960L make it ready for future surround advances, whatever they may be.

Algorithms

Random Hall

Random Hall is a hall effect with gradual build-up, well suited to complex sounds like orchestral music. Its reverberators change over time in controlled random ways to avoid the buildup of tinny, grainy, metallic, or other colorations.

The early reflections are user adjustable in amplitude and delay. Some skill is needed to set useful reflection patterns. Since the reflections are adjustable, they are not randomized. Once set, the reflection pattern is fixed. The pattern can be expanded or contracted in time using the "Delay Master" control, and the overall level of the pattern can be set with the "Early Level" control.

The most important user parameters for Random Hall are the level controls – the "Early Level" and "Reverb Level". Early Level is a master control for all the early reflections. Lowering the control to zero eliminates the reflections, and their associated sense of distance from the sound source. The "Reverb Level" control is a master control for the late reverberation. With this control you can set the exact amount of reverberance and envelopment.

The apparent size of the space supplied by the late reverberation is set with the Shape, Spread, and Size controls. Of these controls the Shape and Spread are the most natural. As Shape is raised from zero to about 30% the onset of the late reverberation goes from abrupt to gradual. The effect on the apparent size of the space is quite dramatic. Spread has little or no effect until Shape is at about a quarter of its range, at which point Spread affects the length of both the buildup and sustain. At this point, the sustain will be approximately the time value indicated by the Spread display, in milliseconds. At still higher settings of Shape, a secondary sustain appears in the envelope at a lower

Algorithms, Continued

level; this simulates a very diffused reflection off the back wall of the hall, helping to create a sense of size and space. This reflection becomes stronger and stronger, reaching optimal loudness when Shape is at about 2/3 of its range. The highest Shape settings are typically used for effects. Near the top of the scale, the rear hall energy buildup becomes stronger than the earlier part of the envelope, an effect used to create an inverse sound (see Reverse).

To avoid colorations, the signal is randomized by the Spin and Wander parameters. The randomizers controlled by the Spin and Wander parameters principally affect the perceived acoustics of the space. High settings can be used to break up small-room modes, as when recording a voice-over in an announce booth, but extreme settings can have pitch effects.

Surround Hall

Surround Hall is a surround version of Random Hall having 16 delay voices, one for each possible channel pairing (LF to C, C to LF, LF to LS, etc.). It may be useful for Foley work by giving a more precise sense of a space's size.

Chamber

Chamber is a complex miniature-space effect resembling an echo chamber at its smaller settings and, at its larger ones, a small performance space with a more rapid build-up of reflection density than Random Hall. Reverberant tails are randomized.

Plate & Surround Plate

The Plate programs mimic the sounds of metal plates, with high initial diffusion and a relatively bright, colored sound. For this reason, they are good choices for percussion. They are designed to be heard as part of the music, mellowing and thickening the initial sound itself. The Plate sound is what most people associate with the word reverb, and it is useful for all popular music.

Ambience & Surround Ambience

Ambience generates the strong reflections that appear in the first few hundred milliseconds of the reverberation process. These early reflections become part of the direct sound without coloring it, giving it better blend and a definite position in space and conveying the impression of a hall surrounding you while the music is playing. It lends warmth, spaciousness and depth to a performance.

When a signal is supplied to a single input of Surround Ambience – for example the left front – the program

generates early reflections first in the front left and right output channels. If the FSLevel control is set to maximum, reflections are then generated in the left rear and right rear output channels. FSLevel and FSRolloff control the relative level and frequency response between the front early reflections and rear early reflections. In a large room the rear early reflections could be perhaps 3dB less in total level, and somewhat more rolled-off in frequency response. (However, it is unlikely that these differences are audible in practice.)

When a signal is supplied to a rear input, for example the the Left Surround input, the primary early reflections will come from the left surround and right surround outputs, and FSLevel and FSRolloff control the level and frequency response of the early reflections that come from the front. Thus with surround ambience the amplitude and frequency characteristics of a large room can be generated.

The Ambience algorithm is very useful for adding a room sound to recorded music or speech, making it easy to match a studio recording of dialog to a typical room environment. At delay settings of roughly 100 to 500 milliseconds, it can be used to simulate the ambience of very small rooms without the colorations often found in actual spaces of that size. When set to deal with the first 50 msec of the signal, the range perceived as being part of the initial phone, it can be used to realistically add distance to a close-miked signal without diminishing clarity. If an ensemble has been recorded with close miking and pan pots, Ambience can provide the missing blend and depth, increasing apparent distance while preserving the apparent positions of the instruments. It is also useful in matching a closely miked accent microphone to the overall ambience of the recording; this allows a soloist's level to be increased without changing the apparent distance.

The Ambience algorithm does not include extensive provisions for modifying the characteristics of the late reverberation; the Shape, Spread, and Bass characteristics are fixed. However the apparent size of the late reverberation is adjustable with the size control. High settings of the Size control can be very effective at generating the sound of a large space with high clarity. The lack of the BassMult control can be compensated by adding a low frequency shelving boost of 2 to 6dB below 200Hz to the reverberation sends or returns. This type of boost is often very useful when working with music that includes both vocals and instruments.

Algorithms, Continued

Ambient Chamber

Ambient Chamber is a hybrid of the stereo Ambience and Chamber algorithms. It applies front left, center, and right signals to the ambience algorithm and front LCR plus rear signals to the chamber algorithm. This can be used to change the apparent microphone distance of the front signals or to provide different acoustics for the front and rear (e.g., a stage house in front and a more reverberant auditorium behind it) that join into one integrated reverberant field.

The advantage of Ambient Chamber over the Ambient Surround is that there is more control over the late reverberation, with the inclusion of the Shape, Spread, and BassMult controls. However the early reflections generated by Ambient Chamber are more limited. There are no early reflection generators for signals coming into the rear inputs of the Surround version of this program, and the early reflections generated by the ambience section of the program are directed only to the front three loudspeakers. Later reverberation is provided to all the loudspeakers, and all inputs will generate appropriate late reverberation. Ambient Chamber is particularly useful in two channel mode, and whenever a surround program is being designed to play back primarily in a two-channel matrix form.

Reverse & Surround Reverse

Reverse is a new algorithm that is somewhat different from the effect other processors call "Inverse." Unlike traditional Inverse, which is a gated reverb whose reflection density increases until a cut-off time is reached, Reverse's reflection density decreases over time, while its reflection level increases over time, as if

you had recorded a signal through a reverb device, then played the recording backwards. This is the exact reverse of normal reverberant behavior, exactly like the time-honored effect of reversing a tape. The effect begins with a quiet, dense reverb and gradually becomes louder and thins out to reveal the original signal.

It's important to remember that in Reverse all the parameters work backwards. For example, if RtHicut (see parameter listing below) is low, the reverb will become brighter as it develops.

Reflections play an important part in this effect. They should be adjusted so that they occur at or near the end of the reverb. In other words, they play the role of the original signal, so they come last.

For Reverse to work as designed, the Mix parameter must be set 100% wet, both at the 960L and at the mixer!

Inverse

The traditional inverse effect can also be achieved, if desired, by using any of the Hall, Chamber, or Plate effects and doing as follows:

- Select a very large room Size.
- Bring Midrt all the way down.
- Set the Contour parameter to a high value (like 10).
- Control the overall shape and density using Shape, Spread and Size.

Parameters Used in the 960L Algorithms

<i>Parameter Name</i>	<i>Parameter Description</i>
AmbPreD	Ambience PreDelay (Ambience only) controls the time of a predelay that precedes the early reflection (ambience) component of Stereo Ambience. In the same algorithm, RvbDly controls the predelay that precedes the reverberation component.
AmbSize	Ambience Size scales all the delay elements of the early reflection and early energy components of Ambience and Ambient Chamber algorithms. To keep the early reflection energy within the 15ms-50ms window, this control should be set no higher than about 6 or 7.
AmbLvl	Ambience Level sets the overall level of the early reflection and early energy components of Ambience and Ambient Chamber algorithms.
BassMult	Bass Multiply controls the low frequency reverberation time relative to MidRT. If, for example, Bass Multiply is set to 2X and MidRT is set to 2 seconds, the effective low frequency RT is 4 seconds. For natural sounding results, use settings of 1.5X or less. Note that values less than 1.0X produce a low frequency RT that is shorter than MidRT.
BassXOV	Bass Crossover sets the frequency at which the transition between MidRT and Bass Multiply takes place. Except for special effects, there is seldom a need for this parameter to exceed 500 Hz.
Contour	Contour controls the profile of the energy decay in the reverberation tail. At a value of zero, this decay will be smooth and featureless. Large positive and negative values will add noticeable bumpiness of the decay. Use non-zero values with great caution.
CtrRvb	Center Reverb Level controls the reverberation level of the Center output in surround algorithms. This allows the Center Reverb Level to be set relative to both early reflection levels and the Front and Rear Reverb Levels. We recommend that the center reverb level be set about 4.5dB lower than the Front Reverb Level and the Rear Reverb Level. RvbLvl is a master control for CtrRvb, FrRvb and RearRvb.
Definition	<p>Definition is found only in the Chamber and Reverse algorithms. It models the irregularity of reflecting surfaces in the space.</p> <p>In Chamber, turning Definition up makes reflections more discrete, making the reflecting surfaces seem less diffuse. Except for special effects, it is recommended that this be set to zero.</p> <p>In Reverse, Definition controls density buildup; lower values produce more density.</p>
Diffus	Diffusion models the effect of irregular wall surfaces in a room by changing echo density. Very low values produce sharp, discrete early reflections. Higher values produce groups of reflections that are smoother but less articulated. Except for special effects, it is recommended that this control be set to a high value.

Parameters Used in the 960L Algorithms, Continued

<p>dL>L, dR>R, dL>R, dR>L, dLF>LF, dLF>LS, dLF>RF, dLF>RS, dLS>LF, dLS>LS, dLS>RF, dLS>RS, dRF>LF, dRF>LS, dRF>RF, dRF>RS, dRS>LF, dRS>LS, dRS>RF, dRS>RS</p>	<p>Early or Reflection Delays. In many real spaces, distinct reflections and echoes are an important part of the sound, so many of the 960L's reverbs have reflection delay and echo paths with appropriate controls.</p> <p>The Early or Reflection Delays set the delay time. For example, dLF>RS is the delay time in a path from the Left Front Input, through the diffusor, through a delay of dLF>RS duration, and finally to the Right Surround Output.</p> <p>Each of these delay paths has its own level control. The level of the example delay path is set by the related control LvLF>RS.</p>
<p>EchoL, EchoR, EchoLF, EchoLS, EchoRF, EchoRS</p>	<p>Echo Duration. Some reflection delays have echo capabilities. These appear as part of the input path; echoes are passed to the reverberators as well as the reflection outputs. Also, echo signal is fed back through the input diffusors. This means that each echo will be more diffuse and spread than its predecessor. The control EchoLS sets the duration of an echo (that is, a feedback path) on the Left Surround Input and FbckLS sets the amount of feedback for that path. Any echo pattern set with EchoLS and FbckLS will be heard in the surround reverb field and also in any reflection delay whose source is the Left Surround Input.</p>
<p>EchoMST</p>	<p>Echo Master Delay multiplies all echo delays by a percentage. This allows this single control to scale a complicated echo pattern.</p>
<p>EDlyMST</p>	<p>Early Master Delay multiplies all reflection delays by a percentage. For example, if Left Surround Delay is set to 24 msec and EDlyMST is at 50%, the actual Left Surround Delay time will be 12 msec and that figure will appear on the display. This allows this single control to scale a complicated reflection pattern.</p>
<p>ErILvl</p>	<p>Early Level Master Control Multiplies all individually selected early reflection levels by a percentage. This allows this single control to set the overall level of a complicated reflection pattern.</p>
<p>ErIRoll</p>	<p>Early Rolloff controls the cutoff frequency of a 6dB per octave low pass filter on the output of the early reflections.</p>

Parameters Used in the 960L Algorithms, Continued

- FbckL, FbckR, FbckLF, FbckLS, FbckRF, FbckRS** **Echo Feedback.** Some reflection delays have echo capabilities. These appear as part of the input path; echoes are passed to the reverberators as well as the reflection outputs. Also, echo signal is fed back through the input diffusors. This means that each echo will be more diffuse and spread than its predecessor. The control EchoLS sets the duration of an echo (that is, a feedback path) on the Left Surround Input and FbckLS sets the amount of feedback for that path. Any echo pattern set with EchoLS and FbckLS will be heard in the surround reverb field and also in any reflection delay whose source is the Left Surround Input.
- FbkMST** **Echo Feedback Master** scales all the echo feedbacks by a single percentage, allowing this one parameter to set the feedback of a complex pattern.
- FrRoll** **Front-channel Rolloff** (surround algorithms only). Like Rolloff in stereo, it controls the cutoff frequency of a 6dB per octave low-pass filter at the output of all processing. In the Surround algorithms, there are separate controls for the front (LF, C, and RF) channels (FrRoll) and rear (LS and RS) channels (RearRoll).
- FrRvb** **Front Reverb Level** (Surround algorithms only) controls the level of the reverberant tail, but to just the LF and RF outputs. This allows their levels to be set relative to the early reflection levels and the other reverb tails. We recommend setting the Front Reverb Level and the Rear Reverb Level approximately equal, with the Center Reverb Level less by about 4.5dB. RvbLvl is a master control for CtrRvb, FrRvb and RearRvb.
- FSDly** **Front-to-Surround Delay** (Ambient Chamber only) In surround ambiances, there is a signal path from front inputs to rear early reflections and also from rear inputs to front early reflections. The level of this path (in both directions) is set by FSLvl. The high frequency rolloff is set by FSRoll. The delay in the path (in both directions) is set by FSDly.
- FSLvl** **Front-to-Surround Level** (Surround Ambience and Ambient Chamber only) In surround ambiances, there is a signal path from front inputs to rear early reflections and also from rear inputs to front early reflections. The level of this path (in both directions) is set by FSLvl. The high frequency rolloff is set by FSRoll. In Ambient Chamber, the delay in the path (in both directions) is set by FSDly.
- FSRoll** **Front-to-Surround Rolloff** (Surround Ambience and Ambient Chamber only) In surround ambiances, there is a signal path from front inputs to rear early reflections and also from rear inputs to front early reflections. The level of this path (in both directions) is set by FSLvl. The high frequency rolloff is set by FSRoll. In Ambient Chamber, the delay in the path (in both directions) is set by FSDly.
- InLvl** **Input Level** sets level for all input channels simultaneously. Used to prevent processor overload by counteracting gain increases caused by high RTMid, BassMult, and Delay feedback levels. Unless extreme values of these controls are used, we recommend that you leave InLvl set at the factory preset position.

Parameters Used in the 960L Algorithms, Continued

- LvL>L,**
LvR>R,
LvL>R,
LvR>L,
LvLF>LF,
LvLF>LS,
LvLF>RF,
LvLF>RS,
LvLS>LF,
LvLS>LS,
LvLS>RF,
LvLS>RS,
LvRF>LF,
LvRF>LS,
LvRF>RF,
LvRF>RS,
LvRS>LF,
LvRS>LS,
LvRS>RF,
LvRS>RS
- Reflection Levels.** In many real spaces, distinct reflections and echoes are an important part of the sound, so many of the 960L's reverbs have reflection delay and echo paths with appropriate controls.
- The Reflection Delays set the delay time. For example, dLF>RS is the delay time in a path from the Left Front Input, through the diffusor, through a delay of dLF>RS duration, and finally to the Right Surround Output.
- Each of these delay paths has its own level control as well as a master control for all of the (ErlLvl). The level of the example delay path is set by the related control LvLF>RS.
- MidRT** **Midrange Reverberation Time.** The basic control for setting the duration in seconds of the reverberant tail. This is the control that is most like the physical RT60 parameter. The perceived time will also be affected by RtHicut and Bass. Generally, MidRT should be set to a value of about 1.2 seconds for small rooms and up to 2.4 seconds or so for halls.
- Mix** **Wet/Dry Mix.** Each of Lexicon's factory programs are typically shipped at 100% Wet, and we recommend controlling the mix at the console, rather than on the LARC2. Where a console is not available this control can be used to adjust the wet/dry ratio. When a console is being used to adjust the mix of the reverberation returns, be sure the wet/dry Mix control is set at 100%. Otherwise the direct path through the 960L will interfere with the direct path through the console and severe combing will occur.
- RefDly** **Reflection Delay** (Reverse algorithm only) operates very much like the reflection delays in other reverbs. In Reverse, it has a particular role, which is to supply the "dry" sound at the end of the apparently reversed tape. The Reflection Delay is connected to Size. Changes in Size will scale this delay. See also Reflection Level.
- RefLvl** **Reflection Level** (Reverse algorithm only) operates very much like the levels for reflection delays in other reverbs. In Reverse, it has a particular role, which is to supply the "dry" sound at the end of the apparently reversed tape. See also Reflection Delay.
- Rolloff** **Rolloff** (Stereo algorithms only) sets the cutoff frequency of a 6dB per octave low-pass filter at the output of all reverberation processing. Rolling off high frequencies with this filter can result in more natural-sounding characteristic. For a shelving characteristic, use Shelf. Rolloff does not affect the frequency response of the early reflections. See RefHicut.
- RPreD** **Rear PreDelay** (Surround algorithms only) is an additional predelay that can be added to rear input path to recreate the effect of the space's rear wall being farther from the listener than the front. The total rear-channel predelay is the sum of RvbPreD and RPreD, so the latter's values are always preceded by a "+" on the display. E.g., with RPred of +20 and RvbPreD of 100, the onset of reverberation from the rear will occur 120 msec after the initial acoustical event. For best results we recommend that the RPreD control be set to values less than 20ms. Greater values tend to make the reverberation from the rear separately audible from the front reverberation, and the room seems less natural.

Parameters Used in the 960L Algorithms, Continued

- RearRoll** **Rear Rolloff** (Surround algorithms only). Like Rolloff in Stereo, this controls the cutoff frequency of a 6dB per octave low-pass filter at the output of all processing, but affects the rear (LS and RS) channels only. A separate parameter, FrRoll, controls the rolloff for the front (LF, C, and RF) channels.
- RearRvb** **Rear Reverb Level** (Surround algorithms only). Like RvbLvl in Stereo, this controls the level of the reverberant tail, but only for the LS and RS outputs. This allows their levels to be set relative to the early reflection levels and the other reverb tails. RvbLvl is a master control for CtrRvb, FrRvb and RearRvb.
- RShape** **Rear Shape** (Ambient Chamber algorithm only) sets the contour of the initial reverberant-energy growth for the rear channels. Low values produce a very rapid onset, as you'd find in a small chamber. With larger values, the reverberation "blooms" over a few hundred msec, much as it would in a good, Romantic-era concert hall, and the listener's perceived position moves farther back into the hall. See also Contour, Rspread, Shape, and Spread.
- RSpread** **Rear Spread** (Ambient Chamber algorithm only) works with RShape to control the profile of initial reverberant-energy growth for the rear channels, stretching or compressing this contour in time to make reflections closer together or further apart. With complex material, it may be advisable to use a moderately high value for Shape and a moderately low one for Spread to create a bit of space around the original signal. See also Contour, RShape, Shape, and Spread.
- RtHicut** **Reverberation Time High Cut**. In real rooms, the timbre of the reverberant tail becomes darker over time due to the air's absorption of high-frequency sound energy. This control models that behavior, though over a much wider frequency range. When you set the cutoff to very low frequencies, the duration of the reverb will be much shorter than the value shown by MidRT.
- RvbLvl** **Reverberation Level** controls the level of the Reverberant tail, allowing its level to be set relative to the early reflection levels. It is normally set to Full, but may be reduced for effects where pre-echoes should dominate. In surround algorithms, this is a master control for CtrRvb, FrRvb and RearRvb.
- RvbPreD** **Reverb PreDelay** sets the number of milliseconds between a sound and the onset of the reverberations it excites, equivalent to the time of first reflection. In the algorithms that include the Shape and Spread controls it is better to extend the time period before reverberant decay using Shape and Spread. In general we recommend leaving the Reverb PreDelay set at the preset value.
- Shape** **Shape** works with Spread to control the profile of initial reverberant-energy growth. Shape sets the envelope of the energy build-up and Spread stretches or compresses this contour in time. Low values of Shape produce a very rapid onset, as you would find in a small chamber. With larger values, the reverberation "blooms" over a few hundred milliseconds, much as it would in a good, Romantic-era concert hall. Large values of Spread and Shape can create "inverse" effects (see note under Reverse algorithm).
- Shelf** **Shelf** (Random Hall only) controls a shelving low-pass on the reverb output. It modifies the low-pass characteristic of the rolloff control, turning it into a shelving filter. Both the pre-echoes and the reverberation are affected. For example, if Shelf is set to -6 dB, frequencies below approximately Roll / 2 will be boosted by 3.5 dB, while above approximately Roll / 2 response will be flat. For realistic musical acoustics, Shelf should be set between +12 and -6 dB and Roll should be set between 700 Hz and 1.5 kHz. While this control can occasionally be useful to increase the apparent low frequency content of the returns, it does so at the expense of eliminating the overall rolloff characteristic that typically begins around 2kHz. Thus it is probably best to leave Shelf set to zero. If more LF is desired in the returns, use console equalization to increase the low frequency content by ~3dB below 200Hz.

Parameters Used in the 960L Algorithms, Continued

- Size** **Size** is a scale factor that alters the length of most of the reverb's delay elements. This control is calibrated in units that approximate the longest dimension of the reverberant "space" in meters. In practice, perception of room size is also strongly determined by Shape. Size strongly affects the overall timbre of the reverberation. Values less than 25 have a noticeable "small room" coloration. For the most neutral sound with the programs that have Shape and Spread controls, set Size to about 30M, and then adjust the apparent size with Shape and Spread.
- Slope** **Slope** (Reverse algorithm only) multiplies low-frequency energy and is similar in its effect to Bass Multiply.
- Spin** **Spin** and Wander introduce small random variations within the reverberation, continuously altering the reverb timbre to create a more natural sound. Spin controls the relative rate of motion and the speed with which changes occur, expressed in arbitrary units. Wander controls the amount of change. At extreme settings, these parameters can introduce slight wobbles that are audible in critical material such as classical guitar or piano.
- Spread** **Spread** works with Shape to control the profile of initial reverberant-energy growth. Shape sets the contour of the energy growth and Spread stretches or compresses this contour in time to make reflections closer together or further apart. With complex material, it may be advisable to use a moderately high value for shape and a moderately low one for spread to create a bit of space around the original signal. Large values of Spread and Shape can create "inverse" effects (see note under Reverse algorithm). See also Contour.
- Steering** **Steering** (Stereo algorithms only) controls a matrix encoder that affects only the reverberant tails. This provides a reverberation that will decode into surround without strong early components that might trigger phase correction devices. Steering is not continuously variable, but offers the following choices:
- Mono -- Mono sum tail.
 - Narrow -- between mono and stereo.
 - Stereo
 - Wide -- Expanded Stereo.
 - Lex -- LexiconLogic™, a matrix that includes separate left and right surround signals when used with a Lexicon Logic decoder, but is also compatible with other commercial matrix codings and with stereo and mono.
 - Matrix -- 4-2-4 encoding.
- Wander** **Wander** and Spin introduce small random variations within the reverberation, continuously altering the reverb timbre to create a more natural sound. Spin controls the relative rate of motion and the speed with which changes occur, expressed in arbitrary units. Wander controls the amount of change. At extreme settings, these parameters can introduce slight pitch wobbles that are audible in critical material such as classical guitar or piano.

6

MIDI

MIDI	6-1
Nomenclature.....	6-1
MIDI Channel Allocation	6-1
Program Loading	6-2
Bank and Program Mapping	6-2
Card Configuration.....	6-2
Continuous Controllers	6-2
MIDI SYSEX	6-3
MIDI IMPLEMENTATION CHART	6-4

MIDI

The MIDI implementation for the Rev 1 960L is very basic. Since the implementation is fixed, there is no user interface for modifying it.

MIDI controller's lowest channel number is 1 (rather than 0), you should add one to the values found in channel table below.

Nomenclature

Numbering in MIDI, i.e. channel number, program numbers, etc., can be confusing, since some sources start counting from zero and others start from one. This description will start from zero. If, for example, your

MIDI Channel Allocation

The 960L uses a fixed channel allocation. All channels are used or reserved, which means that 960L should be the only device on its MIDI cable.

Channel	Usage	Description
0	Global Channel	Not currently in use
1	DSP Card	Configuration of card.
2	Unused	Reserved for Future Use
3	Unused	Reserved for Future Use
4	Machine 1	Program change for machine 1
5	Machine 2	Program change for machine 2, if present in current configuration
6	Machine 3	Program change for machine 3, if present in current configuration
7	Machine 4	Program change for machine 4, if present in current configuration
8	Unused	Reserved for Future Use
9	Unused	Reserved for Future Use
10	Unused	Reserved for Future Use
11	Unused	Reserved for Future Use
12	Unused	Reserved for Future Use
13	Unused	Reserved for Future Use
14	Unused	Reserved for Future Use
15	Unused	Reserved for Future Use

MIDI, Continued

Program Loading

Because of the large number of potential Programs in the 960L, Program Change messages are used along with the Bank Select extension to provide MIDI Program selection. Controllers 0 and 32 are sent to the system, followed by a Program Change message to select a program. In this method, Controller 0 provides the most-significant 7 bits of the Bank and Controller 32 provides the least-significant 7 bits. The Program within a Bank is selected with a Program Change message. Each Bank has 10 programs or less, so only Program Changes 0 – 9 will cause a program load.

The Bank values are "sticky", that is, the 960L will remember the Bank values for each MIDI channel. It is not necessary to send a Bank change with each Program Change unless the Bank has indeed changed. This is in full conformance the MIDI specification.

Bank and Program Mapping

There are 10 Programs or fewer in each Bank. Bank and Program Changes out of range will be ignored.

Bank	Description
0-19	Factory Preset (Controller 0 = 0; Controller 32 = 0-19)
2048-2147	User Registers (Controller 0 = 16; Controller 32 = 0-99)
8192	Floppy Disk (Controller 0 = 64; Controller 32 = 0-9)
16383 (highest Bank)	Card configuration. For Channel 1 (DSP card) only.

Card Configuration

The DSP card is partitioned through Program Change messages on channel 1. The highest Bank number

(16383, 0x7f on Controller 0 and 0x7f on Controller 32) is used for this purpose. Other Bank numbers are reserved for future use. Here are the values:

Program #	Description
0	Stereo (4 stereo machines at 48K. 2 at 96K)
1	Surround (5-in/5-out plus 2-in/5-out at 48K. 5-in/5-out at 96K)
2	Surround (dual 2-in/5-out at 48K. Single 2-in/5-out at 96K)
63	8-channel. Useful for wiring checks and diagnostics.

Continuous Controllers

The 960L does not respond to continuous controllers, except those used for Bank change.

MIDI Sysex

The only Sysex message supported by the 960L is the "Inquiry Message". The 960L will respond with the standard descriptor, as defined in the "MIDI 1.0 Detailed Specification", published by The MIDI Manufacturers Association (MMA)

Incoming Inquiry:

MIDI Byte	Description
F0	Sysex header
7E	Non-realtime header
XX	Device ID. The 960L will always respond to its own ID (0) or to 7F.
06	General Information
01	Device Inquiry
F7	EOX

960L's response:

MIDI Byte	Description
F0	Sysex header
7E	Non-realtime header
XX	Device ID. Always 0 in 960L Software V1.0
06	General Information
02	Device ID message
06	Lexicon ID
0C	960L Sysex ID (Device Family Code LSB)
00	Reserved (Device Family Code MSB)
00	Reserved (Device Family Member Code LSB)
00	Reserved (Device Family Member Code MSB)
XX	Major Software Revision
XX	Minor Software Revision
XX	Revision type. 'A' Alpha, 'B' Beta, 'R' Release
00	Unused Revision information
F7	EOX

MIDI Implementation Chart

Lexicon 960L

Date: 20 April, 2000

Version 1.0

Function	Transmitted	Recognized	Remarks
Basic Default	X	1-16	
Channel Changed	X	X	
Mode Default	X	Mode 1	
Messages	X	X	
Altered	X	X	
Note			
Number True Voice	X	X	
Velocity Note ON	X	X	
Note OFF	X	X	
After Keys	X	X	
Touch Channel	X	X	
Pitch Bend	X	X	
Control 1-119	X	OX	Bank Change Only
Change			
Program			
Change	X	0-9, 0-63	Channel 1 uses 0-63
Bank Select	X		
System			
Exclusive	Device ID	Device Inquiry	Device ID
System Song Position	X	X	
Common Song Select	X	X	
Tune Request	X	X	
System Clock	X	X	
Real Time Commands	X	X	
Aux Local ON/OFF	X	X	
Messages All Notes OFF	X	X	
Active Sensing	X	X	
System Reset	X	X	
Notes			

Mode 1: OMNI ON, POLY
 Mode 3: OMNI OFF, POLY

Mode 2: OMNI ON, MONO
 Mode 4: OMNI OFF, MONO

O : Yes OX : Selectable
 X : No

Specifications

Specifications

960L Mainframe

Analog Input

Connectors	Eight, Female XLR
Impedance	50Kohm, balanced
Level (for 0 dbFS)	+24dBu
Freq Response @48K	20Hz-20KHz, ± 1 db
Freq Response @96K	20Hz-40KHz, ± 1 db
A/D Conversion	24 bits
	128x oversampled
A/D Dyn Range	>110 dB (20-20kHz)
THD	<.002%
CMRR	>50db
Crosstalk @ 1KHz	< -100dB

Analog Output

Connectors	Eight, Male XLR
Impedance	50 Ohm, balanced
Level (at 0 dBFS)	+24dBu
Freq Response @48K	20Hz-20KHz, ± 1 dB
Freq Response @96K	20Hz-40KHz, ± 1 dB
D/A Conversion	24 bits
	8x oversampled @ 44.1/48KHz
	4x oversampled @ 88.2/96KHz

D/A Dyn Range	>110 dB (20-20kHz)
THD	<.002%
Crosstalk @ 1kHz	< -100dB

A/A Performance

Freq Response @48K	20Hz-20KHz, ± 1 dB
Freq Response @96K	20Hz-40KHz, ± 1 dB
Dyn Range	>107 dB (20-20kHz)
THD	<.002%

Digital Audio IO

Connectors	Four Male XLR Outputs Four Female XLR Inputs
Format	AES/EBU
Word Size	24 bits

Sample Rates

Internal Accuracy	44.1/48/88.2/96kHz within ± 10 ppm
External Lock Range	44.1/48/88.2/96kHz $\pm 1\%$

Group Delays (milliseconds)

	44.1 kHz	48 kHz	88.2 kHz	96 kHz
A/D	1.44	1.33	0.81	.0.74
A/A	2.42	2.23	1.80	1.66
D/A	1.59	1.42	1.35	1.25
D/D	0.54	0.50	0.36	0.33

Synchronization

TTL Word Clock Input *

75 Ohm, BNC
self-terminating loopthru

TTL Word Clock Output*

Low Z, BNC
(*Falling edge marks start of frame)

Clock Jitter

Intrinsic	Exceeds AES3 Amendment 1
Jitter Gain	Exceeds AES3 Amendment 1

Control Interfaces

LARC2 Ports	2
MIDI **	In/Out/Thru (**supports program change)

Algorithms

Ambience	(48K Stereo & Surround)
Chamber	(48K Stereo & Surround)
Plate	(48K Stereo & Surround)
Reverse	(48K Stereo & Surround)
Random Hall	(48/96K Stereo & Surround)
Ambient Chamber	(48K Surround)

Standard Hardware Configuration

DSP/CPU Card Compartment

One System CPU Card
One Reverb DSP Card
Two Spare DSP card slots
One MIDI Card

IO Card Compartment

One Analog Input Card
One Analog Output Card
One AES/EBU Digital IO Card
One IO/Clock Card
One Spare IO Card slot

Storage Media

Hard Disk
3.5" Floppy Disk Drive
CD-ROM Drive

Specifications, continued

Reverb Card Configurations

48K	
Stereo Machines	Four
2in x 5out Machines	Two
5in x 5out Machines	Two
96K	
Stereo Machines	Two
2in x 5out Machines	One
5in x 5out Machines	One

Internal Hard Disk Storage

Factory Programs	240
User Registers	1000

Removable 3.5" Floppy Disk Storage

User Registers	100
-----------------------	-----

Power

Requirements***	100-120 / 220-240 VAC
	50-60Hz, 300W max
	(***switch selectable)
Connector	3-pin IEC

Dimensions

Rack Units	4U
Size	19.0" W x 7.0" H x 17.4" L (483mm x 178mm x 442mm)

Weight

35 lbs

Regulatory Approvals

FCC	Class A
CE	EN55103-1, EN55103-2
UL	UL1419
cUL	C22.2
TUV	EN60065

Environment

Operating	10 to 40 °C
Storage	-30 to 70 °C
Humidity	95% max, non-condensing

LARC2 User Interface

Display

Type	Passive Matrix LCD
Resolution	640x240
Colors	256
Backlight	Fluorescent
Contrast	HW controlled (rear panel)
Brightness	SW controlled

LED Meter Bridge

Configuration	8 channels x 3 levels
Levels	-60dBFS (Signal) -6dBFS -0.5dBFS (Overload)

Control Surface

Faders	8 60mm throw, motorized, touch sensitive
Joystick	Two axis
Dedicated Function Keys	29 (12 backlit)
Soft Buttons	8

Connectors

960L	9-pin D-sub
Aux. PS/2 Keyboard	6-pin Mini-DIN
Ext. Power	concentric, 2.5mm

Operating Distance

With power from 960L	up to 100 feet
With Ext. Power	up to 1000 feet

Power

Requirements	12 VDC, 2 A (max)
--------------	-------------------

Dimensions

Size	12.7" L x 8.25" W x 5.0" H (323mm x 210mm x 127mm)
------	---

Weight

4 lbs

Regulatory Approvals

FCC	Class A
CE	EN55103-1, EN55103-2
TUV	EN60065

Environment

Operating	5 to 40 °C
Storage	-30 to 70 °C
Humidity	95% max, non-condensing

Appendix

Appendix: Program Descriptions

Surround Banks	Surround Program Names									
	1	2	3	4	5	6	7	8	9	0
1- *Halls 1	Large Hall	Medium Hall	Small Hall	Med Large Hall	Key Hall	Acoustic Fill	Long, Brite Space	Jazz Hall	Large Church	Small Church
2- *Halls 2	Large Choir Hall	Med Choir Hall	Med Vox Hall	Echo Hall	Big Reflex	Small Brite Hall	Short & Deep	Taj Mahal Deep6	Beefy Hall	Bottom Heavy
3- *Stage + Hall	Lg Stage + Hall	Med Stage + Hall	Sm Stage + Hall	Brite Stage + Hall	Small MT Stage	Verb Behind You	Front Row	Bright Stage	Big Stage	On
4- *Chambers	Round Chamber	Bright Chamber	Small Chamber	Short Chamber	Tight Chamber	Gately Chamber	Slap Chamber	Buck'N Chamber	Off the Back Wall	Hotel Foyer
5- *Stage + Chamber	Large + Chamber	Med + Chamber	Small + Chamber	Big Empty Church	Med Vocal Church	Bright Front	Bright Rear	Pulpit	Vocal Breeze	Snare Strainer
6- *Rooms	Studio C	Rock'n Room	Woomy Room	Gated Room	Small Room #2	Tiny Room	Ambience 4 Horns	Rock'n Echoes	Lulu's Room	Ziggy's Place
7- *Plates 1	Large Plate	Medium Plate	Small Plate	Drum Plate	Dessert Plate	Wavey Plate	Percussion Plate	Vocal Plate	Long Brite Space	Plated Gate
8- *Plates 2	A Plate	Snare Plate	Thin Plate	Fat Plate	Echo Plate					
9- *Ambience	Very Large Amb	Large Ambience	Medium Ambience	Small Ambience	Strong Ambience	Heavy Ambience	Ambient Hall	Announcer	Closet	Gated Ambience
10- *Wild Spaces	Brick Wall	Walls and Slaps	Back Up	Big Back Up	Ekoz All 'RoundR	Ekoz All 'RoundL	Giant Cricket	Silica Beads	Long Shadow	Ricochet
11- *Post 1	Large Closet	Medium Closet	Small Closet	Big Living Room	Living Room	Parlor	Poolroom	Poolhall	Bathroom	Big Bathroom
12- *Post 2	Oil Tank	Hospital Hallway	Yacht Club	Law Offices of:	Street Echo Slap	Lobby	College Lecture	Bat Cave	Warehouse	Coffin

Appendix, continued

Stereo Banks	Stereo Program Names									
	1	2	3	4	5	6	7	8	9	0
1- Halls 1	Large Hall	Medium Hall	Small Hall			Acoustic Fill	Auto Park	Jazz Hall	Large Church	Small Church
2- Halls 2	Large Choir Hall	Med Choir Hall	Med Vox Hall	Echo Hall	Large Brite Hall	Small Brite Hall				
3- Stage + Hall	Lg Stage + Hall	Med Stage + Hall	Sm Stage + Hall							
4- Chambers	Medium Chamber	Snare Chamber	Mini Chamber	SM Brite Chamber	Soft Chamber	LG Brite Chamber	LG Dark Chamber	LG Vocal Chamber	Huge Chamber	Slap Chamber
5- Stage + Chamber	Large + Chamber	Med + Chamber	Small + Chamber							Snare Strainer
6- Rooms	Large Room	Medium Room	Small Room	Very Small	Large Wood Room	Small Wood Room	Lg Brite Room	Med Brite Room	Small & Bright	Music Club
7- Plates 1	Large Plate	Medium Plate	Small Plate	Drum Plate	Dessert Plate	Wavy Plate	Percussion Plate	Vocal Plate	Long, Brite Space	Plated Gate
8- Plates 2	A Plate	Snare Plate	Thin Plate	Fat Plate	Echo Plate					
9- Ambience	Very Large Amb	Large Ambience	Medium Ambience	Small Ambience	Strong Ambience	Heavy Ambience	Ambient Hall	Announcer	Closet	Gated Ambience
10- Wild Spaces	Brick Wall	Buckram	Big Bottom	10W-40	20W-50					
11- Post 1	Large Closet	Medium Closet	Small Closet	Big Living Room	Living Room	Parlor	Poolroom	Poolhall	Bathroom	Big Bathroom
12- Post 2	Car Interior			Kitchen	Kellar's Cell	Small Foley	Reverb Tail	Airhead	Warehouse	

Appendix, continued

Surround Bank 1: *Halls 1			*Surround-Halls
Number	Name	Algorithm	Description
B1 P1	Large Hall	Surround Hall	A large sized random hall with the musicians placed in the middle and a relatively long MidRT.
B1 P2	Medium Hall	Surround Hall	A little smaller than Large Hall. Use for real acoustic instruments to add a gentle soft space.
B1 P3	Small Hall	Surround Hall	Obviously small, with some added reflections in the front and rear channels.
B1 P4	Med-Large Hall	Surround Hall	Medium sized with some added reflections at a lower level.
B1 P5	Key Hall	Surround Hall	For keyboards, short rev time and medium size, and for real acoustic instruments to add a gentle soft space.
B1 P6	Acoustic Fill	Surround Chamber	Use on just about everything, mix as needed.
B1 P7	Long, Brite Space	Surround Chamber	Use with caution: useful for single sources or staccato hit – long tails with lots of movement.
B1 P8	Jazz Hall	Surround Hall	Relatively small space with hard, bright walls and a short MidRT
B1 P9	Large Church	Surround Hall	A big space with musicians centrally located and a long MidRT.
B1 P0	Small Church	Surround Hall	A smaller version of Large Church.

Surround Bank 2: *Halls 2			*Surround-Halls
Number	Name	Algorithm	Description
B2 P1	Large Choir Hall	Surround Hall	Graduated surround delays widen the image of choirs and backing vocals. Large Hall gives space. Use Joystick to control the delay image.
B2 P2	Med Choir Hall	Surround Hall	Graduated surround delays widen the image of choirs and backing vocals. Medium-sized Hall gives space. Use Joystick to control the delay image.
B2 P3	Medium Vox Hall	Surround Chamber	Medium density, short reverb time. Solo or background vocals sound great in here.
B2 P4	Echo Hall	Surround Hall	Use Joystick to regulate the echo component.
B2 P5	Big Reflex	Surround Chamber	Use in small amounts – short sounding.
B2 P6	Small Brite Hall	Surround Chamber	Bright space with about 1 second MidRT
B2 P7	Short and Deep	Surround Hall	Strong bottom end – Use Spread to control the event . . .
B2 P8	Taj Majal Deep6	Surround Hall	Long MidRT and large Size with long echoes at a low level. Useful for single sources and dramatic accent effects.
B2 P9	Beefy Hall	Surround Hall	Large size, relatively short MidRT, and BassRT setting of 2.5 give this room some bottom. Good for drums.
B2 P0	Bottom Heavy	Surround Hall	Large Size and short MidRT. Adds bottom to thin source material. Good for drums.

Appendix, continued

Surround Bank 3: *Stage+Hall			*Surround-Halls+Ambience
Number	Name	Algorithm	Description
B3 P1	Lg Stage + Hall	Surround Ambience	A stage in the front and hall around you. This one is about a 33 meter stage and a 38 meter hall.
B3 P2	Med Stage + Hall	Surround Ambience	A stage in the front and hall around you. This one is about a 14 meter stage and a 25 meter hall.
B3 P3	Small Stage + Hall	Surround Ambience	A stage in the front and hall around you. This one is about a ten meter stage and a 15 meter hall.
B3 P4	Brite Stage + Hall	Surround Ambience	Medium-sized, bright stage and a fairly large hall.
B3 P5	Small MT Stage	Surround Chamber	Empty performance space with an empty stage.
B3 P6	Verb Behind You	Surround Chamber	Strong reverb sent to the rear channels keeps front dry and focused, while large space envelops the listener and gives great distance behind.
B3 P7	Front Row	Surround Ambience	Adjust reverb and ambience levels to bring yourself closer to or farther from the stage.
B3 P8	Bright Stage	Surround Ambience	Fairly bright stage with a darker large hall.
B3 P9	Big Stage	Surround Ambience	Early reflections mimic a very large stage area and reverb supplies the large hall around it.
B3 P0	On Stage	Surround Ambience	With outputs panned to the sides and reverb levels adjusted accordingly, this emulates the sound of being on a stage, with the reverb decaying in front.

Surround Bank 4: *Chambers			*Surround-Chambers
Number	Name	Algorithm	Description
B4 P1	Round Chamber	Surround Chamber	Big empty space with strong bottom end. Consider using this on anything from dialog to Tom-Toms.
B4 P2	Bright Chamber	Surround Chamber	Medium-sized, fairly bright space with about a one second MidRT. Good all around chamber.
B4 P3	Small Chamber	Surround Chamber	Small bright space. About half-second MidRT. Great on drums.
B4 P4	Short Chamber	Surround Chamber	Fairly small room Size and MidRT of around 0.7 seconds. Good multi-purpose utility chamber.
B4 P5	Tight Chamber	Surround Chamber	Very small bright space. Shortened MidRT lends a more abrupt release. Good for when you want the reverb short, but don't want to use a gated effect.
B4 P6	Gately Chamber	Surround Chamber	Extremely short MidRT setting gives a very abrupt cutoff, but is still more "natural" than a full gate.
B4 P7	Slap Chamber	Surround Chamber	Nice for adding strength. Slap delays are up front. Use Joystick to change effect.
B4 P8	Buck'N Chamber	Surround Chamber	This is a gate-type effect. Hold on!
B4 P9	Off the Back Wall	Ambient Chamber	Much movement from front to back. This program is useful for live concert ambiences as well as dramatic singular effects.
B4 P0	Hotel Foyer	Ambient Chamber	This airy space is like the medium-sized, reflective lobby in many hotels.

Appendix, continued

Surround Bank 5: *Stage + Chamber			*Surround - Chamber + Ambience
Number	Name	Algorithm	Description
B5 P1	Large + Chamber	Ambient Chamber	A Large recital hall with a stage.
B5 P2	Med + Chamber	Ambient Chamber	Medium-sized Ambience up front with about a 1.75 second MidRT setting, make this like a 40-80 seat recital hall.
B5 P3	Small + Chamber	Ambient Chamber	Small-sized ambient reflections coupled with a chamber reverb give this Program an intimate feel. Good for individual acoustic instruments.
B5 P4	Big Empty Church	Ambient Chamber	Large ambience up front, with long MidRT settings emulate a high-ceilinged altar and large reverberant seating area.
B5 P5	Med Vocal Church	Ambient Chamber	Large ambience in front spreads out early reflections. Lends a nice "doubling" effect to fatten up sources. Great for choirs and back-up vocals.
B5 P6	Bright Front	Ambient Chamber	Smaller bright ambience in front with dark reverb space. Keeps attention focused forward.
B5 P7	Bright Rear	Ambient Chamber	The opposite of Bright Front, this has the outputs panned so the bright ambience is in the rear and the dark reverb is in the front.
B5 P8	Pulpit	Ambient Chamber	Very small ambient reflections give the immediate sound of being under the canopy of a pulpit, with the reverberant space of the church around you.
B5 P9	Vocal Breeze	Ambient Chamber	Strong, large ambience with reverb gives an airy quality to vocals. Use sparingly for natural effect.
B5 P0	Snare Strainer	Ambient Chamber	Useful for adding more strainer to a snare that is all "attack."

Surround Bank 6: *Rooms			*Surround - Rooms
Number	Name	Algorithm	Description
B6 P1	Studio C	Surround Chamber	Small room, with thin carpeting on the floor and irregular, reflective surfaces.
B6 P2	Rock'N Room	Surround Chamber	A medium-sized, highly reflective space.
B6 P3	Woomy Room	Surround Chamber	Broad and diffuse, a good chunky sound for the band.
B6 P4	Gated Room	Surround Chamber	Extreme setting of MidRT gives an abrupt cutoff of reverb. Use Size, Shape and Spread to vary the duration and texture of the gate.
B6 P5	Small Room #2	Surround Chamber	Small, like a bedroom with bright characteristics.
B6 P6	Tiny Room	Ambient Chamber	Very small space with boosted ambient reflections
B6 P7	Ambience 4 Horns	Ambient Chamber	Trumpets, Sax, Tubas – any type of brass instruments work well with this Program – especially multiple horns in sections.
B6 P8	Rock'n Echoes	Surround Chamber	Multiple echoes make this program good for dramatic effects. Also ideal for screamin' lead guitar solos.
B6 P9	Lulu's Room	Surround Ambience	Medium-sized room with heavy early reflections. Good for Leslie cabinets. Reverb adds body while ambient reflections keep source changes distinct.
B6 P0	Ziggy's Place	Surround Chamber	Open living space, with lots of fine Italian tile and not much carpeting.

Appendix, continued

Surround Bank 7: *Plates 1			*Surround - Plates
Number	Name	Algorithm	Description
B7 P1	Large Plate	Surround Plate	A standard large plate. Plenty of sizzle. This program is great on pop vocals and guitars.
B7 P2	Medium Plate	Surround Plate	Larger version of Small Plate. Useful on most sources.
B7 P3	Small Plate	Surround Plate	Very small and short. Useful on just about any source.
B7 P4	Drum Plate	Surround Plate	Very bright, this medium-sized reverb accentuates high-end attack transients.
B7 P5	Dessert Plate	Surround Plate	Short and sweet. This one's good for just about anything.
B7 P6	Wavey Plate	Surround Plate	Medium to large Size with a modest MidRT setting.
B7 P7	Percussion Plate	Surround Plate	Good all-around percussion plate.
B7 P8	Vocal Plate	Surround Plate	Large and bright. Good pop vocal plate.
B7 P9	Long, Brite Space	Surround Chamber	Cavelike; good for dramatic accents or screams. Long reverb with lots of motion.
B7 P0	Plated Gate	Surround Plate	Shortened MidRT gives this preset an abrupt cutoff. Useful for drums, when you want that "gated" sound, but this is a little more natural sounding.

Surround Bank 8: *Plates 2			*Surround - Plates
Number	Name	Algorithm	Description
B8 P1	A Plate	Surround Plate	Basic plate program with a clear sound. Useful for everything from vocals to percussion.
B8 P2	Snare Plate	Surround Plate	A rapid buildup of high frequencies make this program a favorite on snare drums.
B8 P3	Thin Plate	Surround Plate	Another variation on the plate theme, this Program keeps out unwanted low frequencies.
B8 P4	Fat Plate	Surround Plate	Produces the sound of a large, highly colored plate.
B8 P5	Echo Plate	Surround Plate	Like Fat Plate, but with echoes.

Appendix, continued

Surround Bank 9: *Ambience			*Surround - Halls + Ambience
Number	Name	Algorithm	Description
B9 P1	Very Large Amb	Surround Ambience	Resembles a very large ambient space that has more "clutter" than a concert hall or performance space. Lowering the Rvb levels reduces the clutter.
B9 P2	Large Ambience	Surround Ambience	Similar to Very Large Ambience, but less spacious. Provides the ambience of a large symmetrical room.
B9 P3	Medium Ambience	Surround Ambience	Similar to Large Ambience, but smaller. Like a large courtroom, or a lecture room.
B9 P4	Small Ambience	Surround Ambience	Similar to Medium Ambience, but smaller – typical lobby, or small lounge.
B9 P5	Strong Ambience	Surround Reverse	The room size is larger than Medium Ambience, but the Rvb levels are reduced to provide a strong "wash" of ambience with a relatively short decay.
B9 P6	Heavy Ambience	Surround Ambience	Resembles a large rectangular space with performers in the middle. Microphone proximity can be simulated by adjusting the wet/dry mix.
B9 P7	Ambient Hall	Surround Hall	Fast, dense ambient attack. Reverberant characteristics of Large Hall.
B9 P8	Announcer	Surround Ambience	Adds a very useful ambient spaciousness to a dry announcer's dialog track.
B9 P9	Closet	Surround Ambience	Just as you would imagine – it even feels cramped.
B9 P0	Gated Ambience	Surround Ambience	Very strong ambience with fast decay – just add your favorite snare drum.

Surround Bank 10: *Wild Spaces			*Surround - Unnatural and Special Effect Spaces
Number	Name	Algorithm	Description
B10 P1	Brick Wall	Surround Ambience	Best described as a subtle gated inverse room. Its usefulness extends beyond just drum sounds.
B10 P2	Walls and Slaps	Surround Chamber	Delays and echoes with not much reverb. Use joystick to control delay time and feedback.
B10 P3	Back Up	Surround Reverse	A Reverse reverb with an abrupt release. Good for special effects or if you need a really long gated sound.
B10 P4	Big Back-up	Surround Reverse	Big Reverse Program that originates in the rear and decays to the front. Useful for special effects.
B10 P5	Ekoz all'RoundR	Surround Plate	Set to send individual delays consecutively to each output. This one starts a FL and goes around to RS. Use Joystick to control delay gain and time.
B10 P6	Ekoz all 'RoundL	Surround Plate	Same as Ekoz all 'RoundR, but this one starts at FR and goes around to RS. Use Joystick to control delay gain and time.
B10 P7	Giant Cricket	Surround Ambience	Large ambience setting spaces out early reflections. Use on short-duration transient material and these reflections are heard as closely spaced echoes.
B10 P8	Silica Beads	Surround Chamber	This one rides the line between a reverse reverb, a plate, and widely spaced ambient reflections.
B10 P9	Long Shadow	Surround Chamber	Provides phantom-like reiteration of source and smoothes it out with reverb. Ghostly on vocals.
B10 P0	Ricochet	Surround Chamber	Ricochet emulates a fairly large space with a dangerous slapback echo

Appendix, continued

Surround Bank 11: *Post 1			*Surround - Stylized Spaces for Post-Production Environments
Number	Name	Algorithm	Description
B11 P1	Large Closet	Surround Chamber	Big walk-in. Use Rolloff, RtHicut, and MidRT to fill it up or empty it out.
B11 P2	Medium Closet	Surround Chamber	Medium-sized closet. Use Rolloff, RtHicut, and MidRT to fill it up or empty it out.
B11 P3	Small Closet	Surround Chamber	Small closet. User Rolloff, RtHicut, and MidRT to fill it up or empty it out.
B11 P4	Big Living Room	Surround Ambience	Large, fairly bright living room with hard floors and lots of tile. Use Rolloff, RtHicut, and MidRT to add draperies and carpeting.
B11 P5	Living Room	Surround Ambience	Like Big Living Room, only smaller
B11 P6	Parlor	Surround Ambience	A small parlor, with heavy carpeting and draperies.
B11 P7	Poolroom	Surround Ambience	A wood-paneled room with a high ceiling and enough space for one regulation-sized table.
B11 P8	Poolhall	Surround Ambience	A fairly large space with wood floors, low ceiling and about 10 tables.
B11 P9	Bathroom	Surround Ambience	Medium-sized (for a bathroom) and bright, with tiled walls.
B11 P0	Large Bathroom	Surround Chamber	Same as Bathroom, only larger.

Surround Bank 12: *Post 2			*Surround - Stylized Spaces for Post-Production Environments
Number	Name	Algorithm	Description
B12 P1	Oil Tank	Surround Hall	Use Size to vary the resonance; Careful with reverb time!
B12 P2	Hospital Hallway	Surround Chamber	Just down the hall from the ER
B12 P3	Yacht Club	Surround Hall	A large empty space with many audible reflections
B12 P4	Law offices of:	Surround Chamber	Jacoby and Price
B12 P5	Street Echo Slap	Ambient Chamber	Famous police sound
B12 P6	Lobby	Surround Chamber	Bright and airy, mix return level for perspective
B12 P7	College Lecture	Surround Ambience	Level of return really sets the feeling
B12 P8	Bat Cave	Ambient Chamber	Hello is anybody there?
B12 P9	Warehouse	Ambient Chamber	Lower reverb time to fill up the warehouse
B12 P0	Coffin	Surround Ambience	A standard, unlined wooden model

Appendix, continued

Stereo Bank 1: Halls 1			Stereo - Halls
Number	Name	Algorithm	Description
B1 P1	Large Hall	Random Hall	Provides the sense of space and ambience of a Large concert hall with the source placed in the center of the hall, away from nearby walls.
B1 P2	Medium Hall	Random Hall	Medium Hall is very similar to Large Hall, but smaller.
B1 P3	Small Hall	Random Hall	Small Hall is a smaller version of Medium Hall.
B1 P4	Empty		
B1 P5	Empty		
B1 P6	Acoustic Fill	Random Hall	Use on just about everything, mix as needed
B1 P7	Auto Park	Random Hall	Auto Park reproduces the sound of a concrete parking garage.
B1 P8	Jazz Hall	Random Hall	A relatively small space with hard, bright walls, a short MidRT and high diffusion. It emulates a hall full of people, without the noise they make.
B1 P9	Large Church	Random Hall	Large Church is a big space with the source centrally placed and a comparatively long MidRT.
B1 P0	Small Church	Random Hall	A smaller version of Large Church.

Stereo Bank 2: Halls 2			Stereo - Halls
Number	Name	Algorithm	Description
B2 P1	Large Choir Hall	Random Hall	Graduated delays widen the image of choirs and backing vocals. Large Hall gives space. Use Joystick to control the delay image.
B2 P2	Med Choir Hall	Random Hall	Graduated delays widen the image of choirs and backing vocals. Medium-sized Hall gives space. Use Joystick to control the delay image.
B2 P3	Medium Vox Hall	Random Hall	Medium density, short reverb time. Solo or background vocals sound great in here.
B2 P5	Echo Hall	Random Hall	Use Joystick to regulate the echo component.
B2 P6	Large Brite Hall	Random Hall	Bright space with about 2 second MidRT.
B2 P4	Small Brite Hall	Random Hall	Bright space with about 1 second MidRT.

Stereo Bank 3: Stage + Hall			Stereo - Halls W/Stage Reflections
Number	Name	Algorithm	Description
B1 P1	Lg Stage + Hall	Random Hall	Similar to Large Hall, except that the source is placed at one end of the hall and several pre-echoes simulate the effects of a proscenium arch
B1 P2	Med Stage Hall	Random Hall	Medium+Stage is very similar to Large+Stage, but smaller.
B1 P3	Sm Stage + Hall	Random Hall	Small+Stage is a smaller version of Medium+Stage

Appendix, continued

Stereo Bank 4: Chambers			Stereo - Chambers
Number	Name	Algorithm	Description
B4 P1	Medium Chamber	Chamber	A medium-sized empty chamber with reflective walls and about one second MidRT.
B4 P2	Snare Chamber	Chamber	Smaller in size than Medium Chamber and about 1/2 second MidRT. As the name suggests, useful for snare drums.
B4 P3	Mini Chamber	Chamber	Similar to Snare Chamber, but even smaller.
B4 P4	SM Brite Chamber	Chamber	Medium-sized, but with a shortened MidRT and some added reflections.
B4 P5	Soft Chamber	Chamber	Medium sized, about 1/2 second MidRT, and the highs rolled off to soften the reverb.
B4 P6	LG Brite Chamber	Chamber	Large size setting, about 1.5 second MidRT, and some added reflections.
B4 P7	LG Dark Chamber	Chamber	Draw the curtains and put carpeting on the floor of LG Brite Chamber and it would sound like this.
B4 P8	LG Vocal Chamber	Chamber	Low diffusion setting with delays and echoes. Good starting point for a pop vocal.
B4 P9	Huge Chamber	Chamber	Size set at 40 meters with about 2.5 second MidRT. This one's huge
B4 P0	Slap Chamber	Chamber	Small, low diffusion, with delays and slight echoes, this one's slappy. Good starting point for a "Rockabilly"-type vocal sound.

Stereo Bank 5: Stage + Chamber			Stereo - Chamber + Stage Reflections
Number	Name	Algorithm	Description
B5 P1	Large + Chamber	Ambience	A Large recital hall with a stage.
B5 P2	Med + Chamber	Ambience	Medium-sized Ambience up front with about a 1.75 second MidRT setting, make this like a 40-80 seat recital hall.
B5 P3	Small + Chamber	Ambience	Small-sized ambient reflections coupled with a chamber reverb give this Program an intimate feel. Good for individual acoustic instruments.
B5 P4	Empty		
B5 P5	Empty		
B5 P6	Empty		
B5 P7	Empty		
B5 P8	Empty		
B5 P9	Empty		
B5 P0	Snare Strainer	Ambience	Useful for adding more strainer to a snare that is all "attack."

Appendix, continued

Stereo Bank 6: Rooms			Stereo Rooms
Number	Name	Algorithm	Description
B6 P1	Large Room	Random Hall	Large Room resembles a good-sized lecture room. It is smaller than Music Club, and more colored, with comb filtering and slap echoes.
B6 P2	Medium Room	Random Hall	Medium Room is a smaller version of Large Room.
B6 P3	Small Room	Random Hall	Small Room is much smaller and less reverberant than the Large and Medium Rooms. It resembles a typical American living room.
B6 P4	Very Small	Random Hall	Very Small Room has the intimate, close feel of a bedroom or den.
B6 P5	Large Wood Room	Random Hall	Large Wood Room is similar to Large Room, but has a lower Bass Multiply, simulating a room with thin wooden paneling, or a cheaply made warehouse or auditorium.
B6 P6	Small Wood Room	Random Hall	Small Wood Room is a smaller version of Large Wood Room.
B6 P7	Lg Brite Room	Random Hall	Simply large and bright.
B6 P8	Med Brite Room	Random Hall	A bit smaller than Lg Brite Room.
B6 P9	Small & Bright	Random Hall	Small and Bright adds presence to a sound without adding a lot of obvious reverberation.
B6 P0	Music Club	Random Hall	Music Club is similar to Jazz Hall, but is smaller and less reverberant – especially at high frequencies.

Stereo Bank 7: Plates 1			Stereo - Plates
Number	Name	Algorithm	Description
B7 P1	Large Plate	Plate	A standard large plate. Plenty of sizzle. This program is great on pop vocals and guitars.
B7 P2	Medium Plate	Plate	Larger version of Small Plate. Useful on most sources.
B7 P3	Small Plate	Plate	Another plate variation. As its name implies, this program produces the sound of a smaller plate.
B7 P4	Drum Plate	Plate	Very bright, this medium-sized reverb accentuates high-end attack transients.
B7 P5	Dessert Plate	Plate	Short and sweet. This one's good for just about anything.
B7 P6	Wavey Plate	Plate	Medium to large Size with a modest MidRT setting.
B7 P7	Percussion Plate	Plate	Good all-around percussion plate.
B7 P8	Vocal Plate	Plate	Large and bright. Good pop vocal plate.
B7 P9	Long, Brite Space	Plate	Cavelike; good for dramatic accents or screams. Long reverb with lots of motion.
B7 P0	Plated Gate	Plate	Shortened MidRT gives this preset an abrupt cutoff. Useful for drums, when you want that "gated" sound, but this is a little more natural sounding.

Appendix, continued

Stereo Bank 8: Plates 2			Stereo - Plates
Number	Name	Algorithm	Description
B8 P1	A Plate	Plate	Basic plate Program with a clear sound. Useful for everything from vocals to percussion.
B8 P2	Snare Plate	Plate	A rapid buildup of high frequencies make this program a favorite on snare drums.
B8 P3	Thin Plate	Plate	Another variation on the plate theme, this Program keeps out unwanted low frequencies.
B8 P4	Fat Plate	Plate	Produces the sound of a large, highly colored plate.
B8 P5	Echo Plate	Plate	Like Flat Plate, but with echoes.

Stereo Bank 9: Ambience			Stereo - Ambience
Number	Name	Algorithm	Description
B9 P1	VeryLG Ambience	Plate	Resembles a very large ambient space (large shopping mall, parking garage, warehouse) that has far more "clutter" than a concert hall or performance environment. Lowering the RvbLvl reduces the clutter while maintaining the sense of a very large ambient space.
B9 P2	Large Ambience	Ambience	Similar to Very LG Ambience, but less spacious. Provides the ambience of a large symmetrical room.
B9 P3	Medium Ambience	Ambience	Similar to Large Ambience, but smaller. Imagine a large courtroom, or a lecture room – then load the program.
B9 P4	Small Ambience	Ambience	Similar to Medium Ambience, but smaller – typical lobby, or small lounge.
B9 P5	Strong Ambience	Ambience	The room size is larger than Medium Ambience, but the RvbLvl has been reduced to provide a strong "wash" of ambience with a relatively short decay time.
B9 P6	Heavy Ambience	Ambience	Resembles a large rectangular performance space with musicians or performers positioned in the middle of the space. Microphone proximity to the musicians or performers can be simulated by adjusting the Mix control. If the 960L is used with a mixing console and interfaced with stereo sends and returns, the Mix control should be 100% Wet and the level of the sends will determine the proximity effect.
B9 P7	Ambient Hall	Ambience	Fast, dense ambient attack. Reverberant characteristics of a Large Hall.
B9 P8	Announcer	Ambience	Add a very useful ambient spaciousness to a dry announcer's dialog track.
B9 P9	Closet	Ambience	Just as you would imagine, it even feels cramped!
B9 P0	Gated Ambience	Ambience	Very strong ambience with fast decay – just add your favorite snare drum!

Appendix, continued

Stereo Bank 10: Wild Spaces			Stereo - Unnatural and Effect Spaces
Number	Name	Algorithm	Description
B10 P1	Brick Wall	Ambience	Brick Wall, as in running into, rather than sounding similar to. This program can best be described as a subtle gated inverse room, but it's really much more. Unlike most gated reverb effect, this one's usefulness extends well beyond drum sounds. Try this on a wide variety of material.
B10 P2	Buckram	Ambience	Buckram is a variation of Brick Wall. The difference is that Buckram doesn't sound as dense as the Brick Wall, and has a longer reverb tail.
B10 P3	Big Bottom	Chamber	Big Bottom has a relatively short MidRT and a much longer bass reverb time. This produces a big boom from low-frequency material, while leaving the high end more or less untouched. This is useful for adding a big bass and tom drum sound to an existing mix, or to a drum machine with premixed stereo outputs.
B10 P4	10W-40	Chamber	10W-40 emulates the sound of an oil drum. If your facility lacks an oil drum wired for sound, you will be please to discover that Lexicon has supplied one – before you even knew you needed it.
B10 P5	20W-50	Ambience	A more aggressive oil drum.

Stereo Bank 11: Post 1			Stereo-Styled Spaces for Post-Production Environments
Number	Name	Algorithm	Description
B11 P1	Large Closet	Chamber	Big walk-in. Use Rolloff, RtHicut, and MidRT to fill it up or empty it out.
B11 P2	Medium Closet	Chamber	Medium-sized closet. Use Rolloff, RtHicut, and MidRT to fill it up or empty it out.
B11 P3	Small Closet	Chamber	Small closet. User Rolloff, RtHicut, and MidRT to fill it up or empty it out.
B11 P4	Big Living Room	Ambience	Large, fairly bright living room with hard floors and lots of tile. Use Rolloff, RtHicut, and MidRT to add draperies and carpeting.
B11 P5	Living Room	Ambience	Like Big Living Room, only smaller
B11 P6	Parlor	Ambience	A small parlor, with heavy carpeting and draperies.
B11 P7	Poolroom	Ambience	A wood-paneled room with a high ceiling and enough space for one regulation-sized table.
B11 P8	Poolhall	Ambience	A fairly large space with wood floors, low ceiling and about 10 tables.
B11 P9	Bathroom	Chamber	Medium-sized (for a bathroom) and bright, with tiled walls.
B11 P0	Big Bathroom	Chamber	Same as Bathroom, only larger.

Appendix, continued

Stereo Bank 12: Post 2			Stereo - Stylized Spaces for Post-Production Environment
Number	Name	Algorithm	Description
B12 P1	Car Interior	Ambience	It's a 4-door. Raise the value of Shape to make it a station wagon or SUV. Raise the Ambience level to close the windows.
B12 P2	Empty		
B12 P3	Empty		
B12 P4	Kitchen	Chamber	Can you find your disposal sound effect?
B12 P5	Kellar's Cell	Chamber	No. It's not the padded cell. Small, deep, and the surfaces are hard.
B12 P6	Small Foley	Chamber	The program uses the Ambience algorithm for Foley applications. Moving AmbSiz from its 1.5M setting will cause the ambience bloom to "open up." Varying Mix from 100% Wet will present the dry delay into the audio path.
B12 P7	Reverb Tail	Chamber	Not infinite. A very war, very long reverberant wash that makes a great fade. Unlike infinite, the inputs are always active.
B12 P8	Airhead	Ambience	Take a pair of headphones, remove the elements and replace them with diffusor panels spaced 10" from your ears. Now, hold a diffusor panel above your head. This program eliminates the need for you to look as though you are communicating with aliens. Use aggressively!
B12 P9	Warehouse	Ambience	It's big – real big!
B12 P0	Empty		