

Chapter 2

Startup

If hooking up new gear is familiar to you, and you just want to get going, here's a quick description of all the basic things you need to cover to get started with your K2600. The procedure is pretty much the same whether you have a rack or a keyboard model. If you need more information, thorough descriptions of each step follow. In either case, check out *Playing the Presets* on page 2-5.

Quick Startup Checklist

All Models

1. Most likely, the lithium “coin” battery that preserves user-defined programs and other data is already installed, but it may be packaged separately. In that case, see *Battery Replacement* on page 8-2 of the *Musician's Reference*, and install the battery.
2. If you have one of the keyboard models, set it on a hard, flat, level surface. If you have a K2600R, mount it in a standard 19-inch MIDI rack, or set it on a hard, flat, level surface. Make sure to leave plenty of room for ventilation.
3. Connect the power cable.
4. Make sure your sound system is at a safe volume level.
5. Plug in a pair of stereo headphones or run standard (1/4-inch) audio cables from your amplifier or mixer to the MIX audio outputs on the K2600. (Use the MIX L out for mono.)

K2600R Owners Only

Your K2600R needs to be able to receive and interpret MIDI messages from whatever MIDI controller you're using.

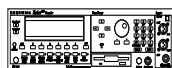

1. Connect a MIDI cable from the MIDI Out port of your MIDI controller to the MIDI In port of the K2600R.

To get setups (and other features) to work properly, you may need to make an adjustment to the K2600R.
2. Press the **MIDI** mode button (it's in the bottom row of buttons under the LCD display) to enter MIDI mode.
3. Look for the word **RECV** in the display, then press the button directly beneath it. The top line of the display now says **MIDIMode:RECEIVE**, which is where you configure the K2600R to respond to your MIDI controller.

The following figure shows you what the display looks like. Notice how one of the *parameters* (probably BasicChannel) has highlighting (reversed color) around its value. This highlighting is called the cursor, and it indicates which parameter (or value) is selected for editing. You can select different parameters using the cursor buttons (the ones

just to the right of the display; they're labeled with **Up/Down/Left/Right** arrows). Press one of the cursor buttons, and the cursor moves correspondingly. In our example below, the BasicChannel parameter is selected; its value is 1.

4. Select the LocalKbdCh parameter (that stands for Local Keyboard Channel), then use the dial (we call it the Alpha Wheel) to change the value so that it matches the channel that your controller is sending on.

```
MIDI Mode RECEIVE
BasicChannel:1      SysExID:  0
MIDI Mode  :Multi   SCSI ID:   6
AllNotesOff :Normal  BendSmooth:On
ProgChgType :Extended LocalKbdCh:None
VelocityMap: 1 Linear BankSelect:Ctl 32
PressureMap: 1 Linear PowerMode :User
EXIT  RECV  CHANLS ProgChg RsetOf Panic
```

5. Press the button labeled **Exit** to get out of MIDI mode. You're ready to go. See page 10-7 for more information about the local keyboard channel.

Start Jamming!

1. Power up your K2600 and check out some of the programs and setups. The K2600 starts up in either Program mode or Setup mode—whichever of the two modes it was in when it was last shut down (or given a soft reset). Press the button labeled **Program** or **Setup** to switch modes.
2. If you hear distortion, reduce the gain on your mixing board, or use the pad if it has one.
3. Scroll through the program list with the Alpha Wheel.
4. Press the **Quick Access** mode button and use the alphanumeric buttons to select from programmable banks of ten programs or setups.
5. If you don't hear anything, review these steps, or check the Troubleshooting section in the *Musician's Reference*.

Startup—the Details

This section walks you through the hookup of your K2600. We'll take a look at the rear panel, then describe the power, audio, and other cable connections.

Before You Start...

Don't connect anything until you make sure your K2600 is properly and safely situated. Also, if your K2600 has been out in the cold, give it time to warm up to room temperature before starting it, since condensation may have formed inside the K2600.

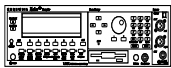

You'll probably be mounting a K2600R in a standard 19-inch MIDI rack (it takes up three rack spaces). If you will be transporting the rack containing the K2600R, be sure to support the back of the K2600R within the rack. If you're not installing the K2600R in a rack, it should rest on a hard flat surface. In this case, it *must* rest on its rubber feet (supplied in the packing carton), and *not* on the bottom panel.

Never block the ventilation openings on the bottom or rear panels; doing so can cause overheating and serious damage. To provide adequate ventilation, the rear panel should be at least four inches from any vertical surface.

Connecting the Power Cable (Line Cord)

The K2600 runs on AC power: 100, 120, 220, or 240 volts at 50–60 Hz. Your dealer will set the voltage selector to match the voltage in your area. The voltage level is set with a selector on the rear panel of the keyboard models of the K2600. You shouldn't have to adjust this, and we recommend that you don't.

When you've connected the cable at the K2600 end (as you face the back of the K2600, the power connection is at the left—on the K2600R, it's on the right), plug it into a grounded outlet. If your power source does not have the standard three-hole outlet, you should take the time to install a proper grounding system. This will reduce the risk of a shock.

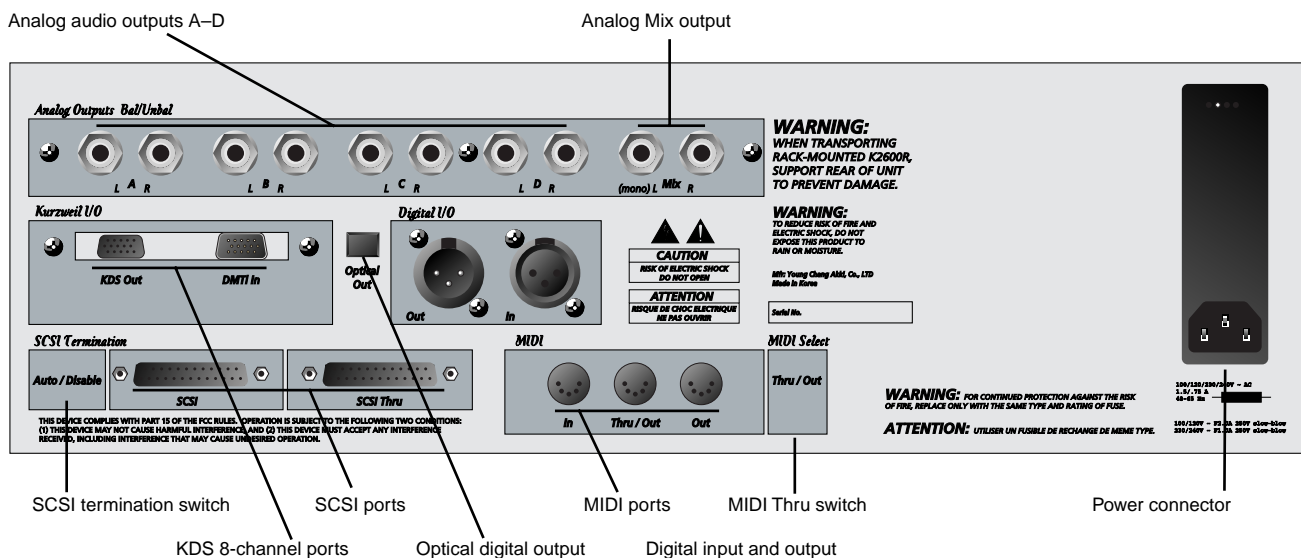
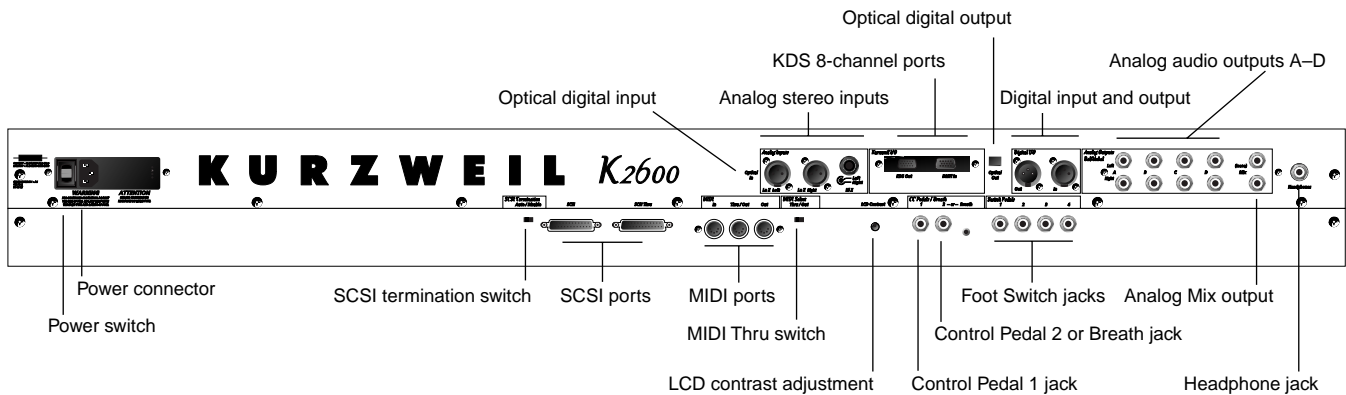

Connecting the Audio Cables

After you've turned down the level on your sound system, connect the K2600's analog audio outputs to your sound system using a pair of stereo or mono audio cables. Mono cables will always work, but if you're going into balanced inputs, use stereo cables for a better signal-to-noise ratio. The K2600's analog outputs are balanced, and generate a "hotter" signal than previous Kurzweil instruments.

You'll find ten 1/4-inch jacks near the top of the rear panel. For now, connect one end of each audio cable to your mixing board or PA system inputs, and connect the other end to the jacks marked MIX L and R on the rear panel of the K2600. If you have only one input available, use the K2600's MIX L output to get the full signal in mono. You'll find more about audio configurations—including digital output—in Chapter 19.

Connecting MIDI

The simplest MIDI configuration uses a single MIDI cable: either from the MIDI Out port of your K2600 to the MIDI In port of another instrument, or from the MIDI Out port of your MIDI controller to the MIDI In port of the K2600 or K2600R. There are all sorts of possible configurations, including additional synths, personal computers, MIDI effects processors, and MIDI patch bays. Depending on your system, you may want to use the K2600's MIDI Thru port to pass MIDI information from a MIDI controller to the K2600 and on to the next device in your system. You can also connect MIDI devices to the K2600's MIDI Out port, which can send channelized MIDI information from the keyboard or through the K2600 from your MIDI controller. See the discussion of the Local Keyboard Channel parameter on page 10-7.

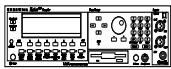

Note: You can perform a quick check of the K2600R and your audio system without a MIDI controller connected to the K2600R. Hold down the **Cancel** button on the alphanumeric pad and press any other alphanumeric button, and you should hear notes. See the discussion of the Panel Play feature on page 3-10 for more information.

Connecting SCSI

You may not have a hard disk or other SCSI device to connect to your K2600 right away, but if you do, you can connect it to either of the SCSI ports. Please read the following information carefully; it's very important. Also, there's a collection of SCSI tips in Chapter 6 of the *Musician's Reference*.



CAUTION: If you plan to connect any SCSI devices (a hard disk, for example) to the K2600, you must terminate your SCSI chain properly. Turn to Chapter 13 and read the section called SCSI Termination. You can lose data if your system isn't terminated properly.

Switching On the Power

- Keyboard models: the power switch is on the rear panel. If you're facing the keyboard, it's just to the right of the power cable connection.
- Rack-mount models: the power switch is located at the lower left of the front panel.

When you power up, the display briefly show some startup information. The Program mode display then appears. It looks like the diagram below (the programs shown in the diagram don't necessarily exist).

```

ProgramMode   %Pose:05   <>Channel:1
-----
KeyMap Info
Grand Piano
-----
198 James Jams
199 Default Program
 1 Righteous Piano
 2 Mondo Bass
 3 Killer Drums
 4 Weeping Guitar
Octav- Octav+ Panic Sample Chan- Chan+

```

The first time you power up (or after a reset), your instrument will be set to operate on MIDI Channel 1 (as shown in the top line of the diagram). After that, it will power up on whatever channel you were on when you powered down. If you'd rather have the K2600 reset certain parameters to default values when you power up, you can do that, too. See *Power Mode* on page 10-9.

Set the volume at a comfortable level. You'll get the best signal-to-noise ratio if you keep the K2600 at full volume, and adjust the level from your mixing board. You may also want to adjust the display contrast. On keyboard models, there's a small knob labeled **LCD Contrast** on the rear panel, between the MIDI ports and the Control Pedal jacks. On the rack-mount model, it's on the left side of the front panel, just above the power switch.

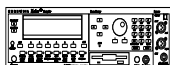

On the K2600R, as you trigger notes from your MIDI controller, you'll see the MIDI LED flash. If it doesn't flash, check your MIDI cables and connections.

Playing the Presets

There are three things you'll want to check out right away: programs, setups and Quick Access banks. In performance situations, you'll be selecting your sounds using one of these three methods. There's a mode (and a mode button) corresponding to each method.

Getting Around

In all three of these modes, the bottom line of the display identifies the function of each of the buttons beneath the display. We call these buttons *soft* buttons, because they do different things depending on what's currently showing in the display.

In Program and Quick Access modes, you can change MIDI channels with the **Chan-** and **Chan+** buttons under the display. In Program mode, you can also change channels using the **Chan/Bank** buttons to the left of the display. (In Quick Access mode, the **Chan/Bank** buttons change Quick Access banks; more about that on page 2-9.)

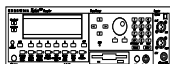

In all three of these modes, you can transpose an octave at a time by pressing the **Octav** buttons under the display. With the K2600R, this works only if the LocalKbdCh parameter on the RECEIVE page in MIDI mode matches the transmitting channel of your MIDI controller—see Chapter 10.

There are two more soft buttons that appear in these three modes: Panic and Sample.

The **Panic** button sends an All Notes Off message and an All Controllers Off message—both to the K2600 and over all 16 MIDI channels. You won't need it often, but it's nice to have.

The **Sample** button takes you to Sample mode (the SampleMode page), which, as you’ve probably guessed, is where you make your own samples—if you have the sampling option in your instrument.

Programs

The K2600 powers up in Program mode, where you can select and play programs stored in *ROM* or *RAM*. Programs are preset sounds composed of up to 32 *layers* of samples or waveforms. If you’ve left Program mode, just press the **Program** mode button or **Exit** button to return.

Take a minute to familiarize yourself with the Program-mode display. It gives you some helpful basic information, like the MIDI transposition, what MIDI channel you’re on, and which program is currently selected.

There’s a box at the left side of the display. The info box, as it’s called, displays information about the current program (there’s also an info box for Setup mode). The following diagrams shows how the information differs depending on the type of program you’ve selected.

VAST Programs

First is a “normal” VAST program, which is what most of the factory programs are. They have from one to three layers. In this case, there are two. For programs of up to three layers, the info box contains one line per layer, indicating the keymap used in that layer. The line under the keymap name indicates the layer’s keyboard range. In this case, both layers extend across the entire keyboard (A 0 to C 8).

```

ProgramMode  XPose:05  <>Channel:1
-----
Keymap Info
Grand Piano
Grand Piano
-----
5 Piano for Layers
6 DrkPno^ArakisPno
7 Honky-Tonk
8 Pno&Syn/HoString
9 ClassicPiano&Vox
10 E Grand Stack
Octav- Octav+ Panic Sample Chan- Chan
    
```

VAST programs with more than three layers are known as *drum* programs, as shown in the following diagram. Drum programs can use any sound you like, but the most common use for programs with more than three layers is to create a number of different sounds across the keyboard—which is perfect for combinations of percussion sounds (hence the name). For drum programs, the info box simply indicates the number of layers in the program—in this case, 26.

```

ProgramMode  XPose:05  <>Channel:1
-----
Drum Program
26 layers
-----
48 DG
49 Lowdown Bass
50 SquashStudio Kit
51 Retro Skins MW
52 2 Live Kits 2 MW
53 Garage Kit II MW
Octav- Octav+ Panic Sample Chan- Chan
    
```

KB3 Programs

The architecture of KB3 programs is different from that of VAST programs. KB3 programs don't have layers; they rely on oscillators that mimic the tone wheels used in many popular organs. Consequently, the info box shows only the waveform used in the program.

```

ProgramMode XPose:051 <>Channel:1
KB3 Program 751 Prog Rock Organ
Mellow Vox 752 Syn Rock Organ
753 Dirty Syn B
754 CleanFullDrawbar
755 Loungin
756 MildGrunge
Octav- Octav+ Panic Sample Chan- Chant

```

Because of their architecture, KB3 programs require different processing within the K2600, and they don't work on "regular" channels. They require a special channel to handle the KB3 program's voices. You can choose any of the 16 MIDI channels to be the KB3 channel, but you can have only one KB3 channel, and KB3 programs play *only* on that channel (VAST programs work just fine on the KB3 channel, by the way).

By default, Channel 1 is designated as the KB3 channel (you can change it in Master mode). If the current channel isn't the same as the KB3 channel, and you select a KB3 program, you won't get any sound, because a non-KB3 channel can't handle a KB3 program.

In the following diagram, Channel 2 is the current channel, but Channel 1 is the KB3 channel. The info box tactfully lets you know what the KB3 channel is, and parentheses appear around the names of all KB3 programs, to further remind you that KB3 programs aren't available on the current channel. To get Program 753 to work in this case, you'd have to change the current channel back to Channel 1, or go to Master mode and change the KB3 channel to Channel 2.

```

ProgramMode XPose:051 <>Channel:2
KB3 Program 751 (Prog Rock Organ)
Mellow Vox 752 (Syn Rock Organ)
753 (Dirty Syn B)
754 (CleanFullDrawba
KB3Chan is Ch 1 755 (Loungin)
756 (Mild Grunge)
Octav- Octav+ Panic Sample Chan- Chant

```

Live Mode Programs

Programs 740–749 are designed expressly for Live mode, a feature that enables you to take a signal from the Analog sampling input (this requires the sampling options, of course), and route it through the DSP algorithms. Programs 740–749 will not play unless you're receiving a signal at the Analog sampling input. See page 14-41 for more about Live mode.

Selecting Programs

When you want to change programs, you have several options.

The easiest method is the Alpha Wheel. Turning it left or right will scroll through the program list. You can also change programs using the cursor buttons (the arrow buttons to the right of the display), or the **Plus/Minus** buttons under the Alpha Wheel. To save time, you can enter the program number directly from the alphanumeric buttonpad to the right of the Alpha Wheel, pressing the **Enter** button to complete the selection. If you make a mistake, press **Clear**, then start over.

The K2600 has various settings for responding to MIDI Program Change commands from external sources. These are explained in Chapter 10, so we won't go into them here. You should be able to change programs by sending Program Change commands from your MIDI controller.

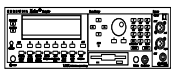

K2600R owners, be sure to try whatever performance controls your MIDI controller has: the Pitch Wheel, Mod Wheel, and switch or control pedals—different programs respond to them in different ways. Attack velocity and aftertouch also have varying effects. Check the list of programs in the *Musician's Reference*, describing how each program responds to specific MIDI control messages.

If you don't hear anything, see the troubleshooting section in the *Musician's Reference*. When you're ready to start doing your own programming, check out Chapter 6.

Setups

Setups are preset combinations of programs. Setups can have up to eight zones, each of which can be assigned to any range of the keyboard (overlapping or split). Each zone can have its own program, MIDI channel, and MIDI control assignments.

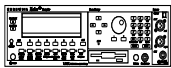

If you're a K2600R owner, you can make use of setups even if your MIDI controller can transmit on only one MIDI channel at a time. See *K2600R Owners Only* on page 2-1, or the discussion of the parameter called Local Keyboard Channel in Chapter 10.

Press the **Setup** mode button to the left of the display. Its LED will light, telling you that you're in Setup mode. Notice that the Setup-mode display is similar to the Program-mode display. If the setup has three or fewer zones, the box at the left shows you the programs assigned to each of the setup's three zones, and which MIDI channel is used for each program. If the setup is composed of more than three zones, then the box displays a series of horizontal lines illustrating the approximate key ranges of the zones. See page 7-1 for a more detailed description.

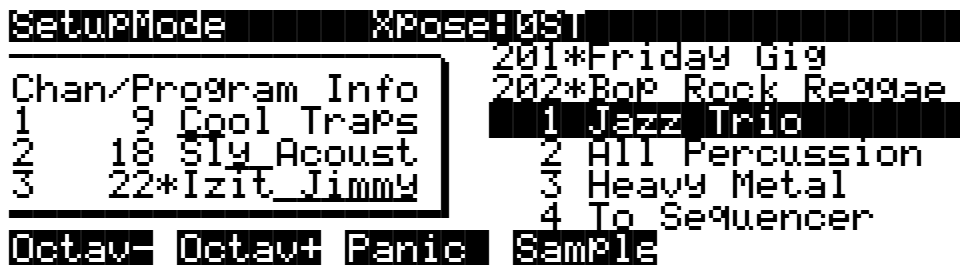

Many setups include arpeggiation and note-triggered songs to create some pretty amazing grooves that you can use as is, or as templates for your own material. As you play with these setups, experiment with the sliders and other controllers for a wide range of effects. Some of these grooves keep playing after you've released the keys that got them going. When you want to stop them, select another setup, or press the **Setup** mode button.

Quick Access

A really convenient way to select programs and setups is to use Quick Access mode, where you select a Quick Access *bank* from a list of factory preset or user-programmed banks. Each bank contains ten memory slots, or entries, where you can store any combination of programs or setups. While you're in Quick Access mode, you can select any program or setup in the bank with buttons 0 through 9.

The K2600 comes with a few Quick Access banks already programmed so you can get an idea of how they work. You'll probably create your own Quick Access banks to help you select programs and setups with a minimum of searching. Press the **Quick Access** mode button to the left of the display. Its LED lights, to tell you you're in Quick Access mode. You'll see a display that looks like this:

```
QuickAccessMode  <>Bank:1 For Show 1
Silk Rhodes      POLY TOUCH      Voice+String9
NastyTrombone    SINK MONSTA      Waterflute
Soon              Jazz Trio 2      Fretless Bas
                  VELVETEEN

Xpose:0ST      SINK MONSTA      Chan:1
Octav- Octav+  Panic Sample  Chan-  Chan+
```

The top line of the display tells you which Quick Access bank is selected. Use the **Chan/Bank** buttons (to the left of the display) to scroll through the banks. The names of each of the ten entries in the bank are listed in the center of the display. Many of their names will be abbreviated. The currently selected entry's full name is shown near the bottom of the display. The amount of transposition is displayed to the left of the entry name. If the current entry is a program, you'll see the current keyboard (MIDI) channel displayed to the right of the entry's name. If it's a setup, you'll see the word Setup.

The entries on the Quick Access page are arranged to correspond to the layout of the numeric buttons on the alphanumeric pad. On the page above, for example, the program **SINK MONSTA** is entry 5, and can be selected by pressing 5 on the alphanumeric pad.

When you're ready to create your own Quick Access banks, turn to Chapter 8 to learn about the Quick Access Editor.

The Other Modes

There are seven other modes, five of which have mode buttons on the front panel (Sample mode and Live mode don't have front-panel buttons). See page 3-2 and Chapter 4 for more detailed descriptions of each mode.

Effects mode	Create and modify effects presets, and define how they're applied to the K2600's programs and setups.
MIDI mode	Configure the K2600 for sending and receiving MIDI information.
Master mode	Define performance and control settings.
Song mode	Record and edit sequences (songs); play Type 0 and Type 1 MIDI sequences.
Disk mode	Load and save programs, setups, samples, and other objects.
Sample mode	Edit ROM samples; create and edit RAM (user-defined) samples.

Software Upgrades

Part of the beauty of the K2600 is the ease with which you can upgrade its operating system and objects (programs, setup, etc.) using the boot loader to install upgrades into flash ROM.

At Kurzweil and Young Chang, we have a long history of support for our instruments; the K250, K1000, K2000, and K2500 have been repeatedly enhanced, and these improvements have always been made available to instrument owners in the form of software upgrades.

Upgrading your K2600's software is simple, painless, and—generally—free! As upgraded software becomes available, you can either get new disks from your Young Chang dealer or download the new stuff from the Web.

To stay in touch, check out our Web site:

<http://www.youngchang.com/kurzweil/>

When you've acquired an upgrade, you can install it yourself in a matter of minutes. See Appendix A for details.