



SQ-R

Synthesizer Sound Module

**Musician's Manual
Version 1.00**

SQ-R Musician's Manual:

Written, Designed,
and Illustrated by:

Jim Boggia, Bill McCutcheon, John O. Senior,
Suzanne Kuldell

Copyright © 1990
ENSONIQ® Corp
155 Great Valley Parkway
Malvern, PA 19355

All Rights Reserved

If you have any questions concerning the use of this unit, please contact your authorized ENSONIQ dealer. For additional technical support, or to find the name of the nearest authorized ENSONIQ Repair Station, call ENSONIQ Customer Service at (215) 647-3930 Monday through Friday 9:30 a.m. to 6:30 p.m. Eastern Standard Time.

This Manual is copyrighted and all rights are reserved by ENSONIQ Corp. This document may not, in whole or in part, be copied, photocopied, reproduced, translated or reduced to any electronic medium or machine readable form without prior written consent from ENSONIQ Corp. The SQ-R software/firmware is copyrighted and all rights are reserved by ENSONIQ Corp.

Although every effort has been made to ensure the accuracy of the text and illustrations in this Manual, no guarantee is made or implied in this regard.

IMPORTANT:

"This equipment generates and uses radio frequency energy and if not installed and used properly, that is, in strict accordance with the manufacturer's instructions, may cause interference to radio and television reception. It has been designed to comply with the limits for a Class B computing device in accordance with the specifications in Subpart J of Part 15 of FCC rules, which are designed to provide reasonable protection against such interference in a residential installation. However, there is no guarantee that interference will not occur in a particular installation. If this equipment does cause interference to radio or television reception, which can be determined by turning the equipment off and on, the user is encouraged to try to correct the interference by one or more of the following measures."

- * reorient the receiving antenna
- * relocate the instrument with respect to the receiver
- * move the instrument away from the receiver
- * plug the instrument into a different outlet so that the instrument and receiver are on different branch circuits

"If necessary, the user should consult the dealer or an experienced radio/television technician for additional suggestions. The user may find the following booklet prepared by the Federal Communications Commission helpful: 'How to Identify and Resolve Radio-TV Interference Problems.' This booklet is available from the U.S. Government printing Office, Washington, D.C. 20402 Stock No. 004-000-00345-4."

In order to fulfill warranty requirements the SQ-R should be serviced only by an authorized ENSONIQ Repair Station.

The ENSONIQ serial number label must appear on the outside of the Unit or the ENSONIQ warranty is void.

*ENSONIQ, SQ-R, SQ-1, VFX, VFX^{SD}, Transwave, EPS, Smart Transmit and Poly-Key are trademarks of ENSONIQ Corp.

Introduction

Section 1 — Getting Started

Power	1 - 1
Grounding Information	1 - 1
AC Line Conditioning	1 - 2
Temperature Guidelines	1 - 3
Basic Connections	1 - 3
Running Your SQ-R Through a Home Stereo System	1 - 4
Rear Panel Connections	1 - 5
The Front Panel — Communicating with the SQ-R	1 - 6
Select Sound Button	1 - 7
Edit Sound Button	1 - 7
Select Preset Button	1 - 7
Edit Track Button	1 - 7
Track Buttons	1 - 8
System Button	1 - 8
Effects Button	1 - 8
Enter/Save Button	1 - 8
Bank Select Button	1 - 8
Arrow Buttons	1 - 9
Volume Knob	1 - 9
Phones	1 - 9
Parametric Programming	1 - 10
Screens	1 - 10
Multiple Parameters	1 - 10
Changing a Parameter	1 - 10
Playing Sounds:	
Sound Memory	1 - 12
Selecting a Sound	1 - 12
Choosing Internal, ROM, Card and Drum Sounds	1 - 12
Memory Cards	1 - 13
Re-initializing the SQ-R	1 - 13
Low Battery Voltage — When to Replace the Battery	1 - 14
SQ-R Accessories	1 - 14
Need More Help?	1 - 15

Section 2 — System Control

System Bank:	
Master Tune	2 - 1
Global Bend	2 - 2
Pedal/Edit Key Range	2 - 2
MIDI Track Name	2 - 2
Voice Muting	2 - 3
Base Channel	2 - 3
MIDI Mode — MIDI In Mode	2 - 4
Global Controllers in MONO Mode	2 - 4
MIDI Loop/Xctrl — External Controller	2 - 5
Controllers/System Excl — MIDI System Exclusive Enable	2 - 6
Program Change	2 - 7
Receiving Program Changes	2 - 7
Selecting a New Preset Effect from MIDI	2 - 7

Preset Prog — Preset Program Change	2 - 8
Retransmit/All Note Off	2 - 8
Store Sounds	2 - 9
Store Presets	2 - 9

Section 3 — Presets

About Presets	3 - 1
Selecting Presets	3 - 2
Editing Presets	3 - 2
Track Status	3 - 3
Compare-Using the Select Preset Button	3 - 3
Edit Preset Buffer	3 - 3
Abandoning Your Edits	3 - 4
Saving a New Preset Into Memory	3 - 4
Copying an Existing Preset to Another Location	3 - 4
About Tracks	3 - 5
Replacing the Sound on a Track	3 - 5
Putting a Sound onto a Track along with its Effect	3 - 6
Layering Sounds in a Preset	3 - 6
Using Effects with Presets	3 - 6
About Performance Parameters	3 - 7
Parameter Bank:	
Transpose	3 - 8
Key Range	3 - 9
MIDI Channel	3 - 10
MIDI Bank	3 - 10
MIDI Program Number	3 - 10
Program Changes in the SQ-R	3 - 11
Receiving Program Changes	3 - 11
Selecting a New Preset Effect from MIDI	3 - 11
Selecting a New Preset with Program Changes	3 - 11
MIDI Status	3 - 12
Pressure	3 - 13
Sustain Pedal	3 - 14
Mix Bank:	
Volume	3 - 15
Pan	3 - 15
Output	3 - 16
Timbre	3 - 16
Release	3 - 17
The Smart Transmit Function	3 - 18
Pressure	3 - 19
A Few Important Points About MULTI Mode	3 - 21

Section 4 — Effects

Understanding SQ-R Effects	4 - 1
Sound Effects	4 - 2
Preset Effect	4 - 2
Programming Effects	4 - 3
The Effect Busses	4 - 3
Effect Mixing	4 - 4
Selecting Effects	4 - 5
Sounds and Presets	4 - 5

When are new effects loaded into the ESP chip?	4 - 5
Performance Control of Effects in Preset mode	4 - 6
Controllers Routed to Effects	4 - 6
Effect Modulators	4 - 7
Effect Parameters	4 - 10
Single Effects:	
Concert Reverb	4 - 10
Hall Reverb	4 - 10
Room Reverb	4 - 10
Warm Chamber	4 - 10
8-Voice Chorus	4 - 12
Phase Shifter	4 - 12
Combined Effects:	
Chorus & Reverb	4 - 14
Flanger + Reverb 1 & 2	4 - 15
Phaser + Reverb	4 - 16
Rotary Speaker + Reverb	4 - 17
Distortion + Chorus + Reverb	4 - 18
Compression + Distortion + Reverb	4 - 19

Section 5 — Programming the SQ-R

What is a Sound?	5 - 1
Voices and Polyphony	5 - 1
Compare — Using the Edit Sound Button/LED	5 - 2
Edit Buffer	5 - 2
Abandoning Your Edits	5 - 2
Saving a New Sound into Memory	5 - 3
Copying an Existing Sound to Another Location	5 - 4

Section 6 — Standard Programming

SQ-R Standard Sound Configuration	6 - 2
SQ-R Voice Configuration	6 - 2
Modulators:	
About Modulation	6 - 3
Selecting a Modulator	6 - 3
Modulation Amount	6 - 3
Modulation Sources	6 - 4
Sound Edit Mode	6 - 8
Wave Bank:	
Select Voice/Voice Status	6 - 8
Wave Class	6 - 9
Individual Waves	6 - 11
Delay Time/Direction	6 - 12
Start Index/ Mod Source and Amount	6 - 12
Type-Specific Wave Parameters	6 - 12
Loop Length	6 - 13
Voice Restrike Decay Time	6 - 13
Change Sound Mode	6 - 13
Pitch Bank:	
Oct/Semi/Fine (Oscillator Tune)	6 - 14
Env1/LFO	6 - 14
Mod Source/Mod Amount	6 - 15
Keyboard Pitch Tracking	6 - 15
Glide Mode	6 - 15
Glide Time	6 - 15

ENV 1, ENV 2, (AMP) — SQ-R Envelopes	6 - 16
Levl	6 - 17
Time	6 - 18
LevV/AttckV/VelCurv	6 - 19
Mode (Env1 and Env2)	6 - 19
Mode (AMP) — Voice Triggering/Stealing Notes	6 - 20
KeyboardTrk	6 - 21
Select Defaults	6 - 21
LFO Bank:	
LFO Speed	6 - 22
Noise Rate	6 - 23
Level/Delay/Mod	6 - 23
Wave/Restart	6 - 24
LFO Waveshapes	6 - 24
Filter Bank:	
Filter1/Filter2	6 - 25
Filter Configurations	6 - 26
FC1 Cutoff/Envelope2	6 - 27
FC1 Keyboard	6 - 27
Mod Source/Mod Amount	6 - 28
FC2 Cutoff/Envelope 2	6 - 28
FC2 Keyboard/Mod FC1>FC2	6 - 28
Env2 and Amp Banks	6 - 29
Output Bank:	
Volume/Boost	6 - 29
Mod Source/Mod Amount	6 - 30
Keyboard Scale Amount/Key Range	6 - 30
Output Bus/Priority	6 - 31
Pan Location/Velocity Window	6 - 31

Section 7 — Drum Programming

SQ-R Drum Sound Configuration	7 - 1
Selecting Drum Sound Editing	7 - 2
Sound Edit Mode	7 - 2
Wave Bank:	
Current Key Number	7 - 3
Low Key/High Key	7 - 3
Creating "Holes" in the Key Map	7 - 3
Wave Class	7 - 5
Wave Name	7 - 5
Direction	7 - 6
Clear Key Map	7 - 6
Set Default Map	7 - 6
Change Sound Mode	7 - 7
Pitch Bank:	
Oct/Semi/Fine (Voice Tune)	7 - 7
Keyboard Pitch Tracking	7 - 7
Filter Bank:	
Filter Cutoff Frequency/Velocity Level Control	7 - 8
Amp Bank:	
Gate Time/Release Time	7 - 9
Velocity Level Control/Mode (Env1 and Env2)	7 - 9
Mode (AMP) — Voice Triggering/Stealing Notes	7 - 10
Output Bank:	
Voice Volume/Volume Boost/Pan Location	7 - 11
Output Bus/Velocity Curve	7 - 12

Section 8 — Storage Functions

Memory Card Storage:

Installing the Battery in a RAM Card	8 - 1
Memory Card Configurations	8 - 2
Formatting a Blank Memory Card	8 - 3
Copying Sounds between Internal and Card Memory	8 - 3
Sound Storage Prompts and Error Messages	8 - 4
Saving Preset Data to Memory Card	8 - 5
Preset Storage Prompts and Error Messages	8 - 6

MIDI Sys-Ex:

Sending MIDI Sys-Ex Messages to another SQ-R or to a Storage Device	8 - 7
Sending One or All Sounds out via MIDI Sys-Ex	8 - 7
Sending Presets out via MIDI Sys-Ex	8 - 8
Receiving MIDI Sys-Ex Messages	8 - 8

Appendix — SQ-R MIDI Implementation

Index

Welcome!

Congratulations, and thank-you for your purchase of the ENSONIQ SQ-R Sound Module. Your ENSONIQ SQ-R represents the latest advancements in affordable music technology. The SQ-R combines a great sounding synthesizer, 24 bit-digital effects, and powerful 8 track multi-timbral capabilities.

The Synthesizer

The ENSONIQ SQ-R's synthesizer section features 100 high fidelity sounds contained in ROM (Read Only Memory), with 80 additional slots in Internal Memory for sounds you create or edit. Optional RAM or ROM Cards allow access to 160 more sounds, for a massive 340 available at once. Each SQ-R sound is created with three digital oscillators that select from 121 sampled acoustic and synthetic waves, as well as ENSONIQ's unique Transwaves™, which possess great harmonic complexity and timbral motion.

The complement to this wide palette of tonal colors is an on-board programmable digital effects processor that adds a dimension of breadth and depth to each SQ-R sound. Various reverb, chorusing, flanging, delay, distortion, and even roto-speaker programs are provided with dynamic control over many settings.

Smart Transmit™

The SQ-R features ENSONIQ's Smart Transmit function. This unique and powerful feature which allows the SQ-R to add new MIDI master controller features to any keyboard hooked up to it. Connect your favorite keyboard and it becomes an eight zone controller with independent control over volume, transpose, key range, MIDI channel, program change remapping, and sustain pedal on/off. The major advantage of Smart Transmit is that it gives you the power and flexibility of a controller keyboard, even if your MIDI keyboard lacks these multi-channel capabilities.

Storage

The SQ-R uses credit card-style memory cards to store its sound data. Sounds can also be saved via MIDI System Exclusive to any MIDI device that accepts and stores such data.

The Manual

This manual is your guide to unlocking the full power of the SQ-R. At this point, you're probably anxious to plug your SQ-R in and get playing. The first section, *Getting Started*, is a quick guide covering all the basics for plugging in, hooking up, and getting down to playing the SQ-R.

After the initial "I just gotta hear it" phase has passed and you're ready to use the full potential of the SQ-R, please take the time to read the rest of the sections on programming and storage. They'll provide valuable information and tips, as well as speeding up the learning process and enjoyment of the instrument.

Thank-you again for choosing ENSONIQ. Enjoy the music!

Section 1 — Getting Started

Power	1 - 1
Grounding Information	1 - 1
AC Line Conditioning	1 - 2
Temperature Guidelines	1 - 3
Basic Connections	1 - 3
Running Your SQ-R Through a Home Stereo System	1 - 4
Rear Panel Connections	1 - 5
The Front Panel — Communicating with the SQ-R	1 - 6
Select Sound Button	1 - 7
Edit Sound Button	1 - 7
Select Preset Button	1 - 7
Edit Track Button	1 - 7
Track Buttons	1 - 8
System Button	1 - 8
Effects Button	1 - 8
Enter/Save Button	1 - 8
Bank Select Button	1 - 8
Arrow Buttons	1 - 9
Volume Knob	1 - 9
Phones	1 - 9
Parametric Programming	1 - 10
Screens	1 - 10
Multiple Parameters	1 - 10
Changing a Parameter	1 - 10
Playing Sounds:	
Sound Memory	1 - 12
Selecting a Sound	1 - 12
Choosing Internal, ROM, Card and Drum Sounds	1 - 12
Memory Cards	1 - 13
Reinitializing the SQ-R	1 - 13
Low Battery Voltage — When to Replace the Battery	1 - 14
SQ-R Accessories	1 - 14
Need More Help?	1 - 15

Power

Insert the line cord into the line receptacle on the rear panel of the SQ-R. Plug the other end of the cable into a grounded AC outlet. (The proper voltage for your SQ-R is listed on the Serial Number label on the side panel.) Turn the SQ-R power on and make sure the display lights up. If not, check your connections and power source.

Grounding Information

Like many modern electrical devices, your SQ-R has a three-prong power cord with earth ground to ensure safe operation. Some products have power cords with only two prongs and no earth ground. To ensure safe operation, modern products with two-prong power cords have polarized plugs that can only be inserted into an outlet the proper way.

Some products, such as older guitar amplifiers, do not have polarized plugs and can be connected to an outlet incorrectly. This may result in dangerous high voltages on the audio connections that could cause you physical harm or damage any properly grounded equipment to which they are connected, such as your ENSONIQ product.

To avoid shock hazards or equipment damage, we recommend the following precautions:

- If you own equipment with two pronged power cords, check to see if they are polarized or non-polarized. You might consider having an authorized repair station change any non-polarized plugs on your equipment to polarized plugs to avoid future problems.

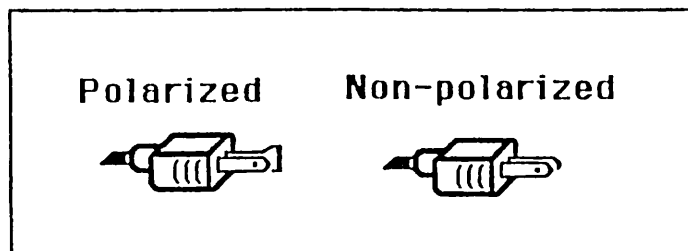

- Exercise caution when using extension cords or plug adapters. Proper polarization should always be maintained from the outlet to the plug. The use of polarized extension cords and adapters is the easiest way to maintain proper polarity.
- Whenever possible, connect all products with grounded power cords to the same outlet ground. This will ensure a common ground level to prevent equipment damage and minimize hum in the audio output.

AC outlet testers are available from many electronic supply and hardware stores. These can be used to check for proper polarity of outlets and cords.

AC Line Conditioning

As is the case with any computer device, the SQ-R is sensitive to sharp peaks and drops in the AC line voltage. Lightning strikes, power drops or sudden and erratic surges in the AC line voltage can scramble the internal memory and, in some cases, damage the unit's hardware. Here are a few suggestions to help guard against such occurrences:

- A Surge/Spike Suppressor. The cheaper of the options, a surge/spike suppressor absorbs surges and protects your gear from all but the most severe over-voltage conditions. You can get multi-outlet power strips with built-in surge/spike suppressors for little more than the cost of unprotected power strips, so using one is a good investment for all your electronic equipment.
- A Line Conditioner. This is the best, but by far the more expensive, way to protect your gear. In addition to protecting against surges and spikes, a line conditioner guards the equipment against excessively high or low line voltages. If you use the SQ-R in lots of different locations with varying or unknown AC line conditions, you might consider investing in a line conditioner.

Temperature Guidelines

The inner workings of the SQ-R contain computerized and electronic circuitry that can be susceptible to damage when exposed to extreme temperature changes. With this in mind, please follow these guidelines when storing and setting up your SQ-R:

- Avoid leaving the SQ-R in temperatures less than 50 degrees or more than 100 degrees Fahrenheit, or inside a vehicle exposed to direct sunlight.
- When bringing the SQ-R indoors after travel, allow the unit at least twenty minutes to reach room temperature before powering up. In the case of excessive outdoor temperatures (below 50 degrees or above 100 degrees), allow an hour or more before power up.

Basic Connections

In order to use your SQ-R, it must receive MIDI information. The SQ-R receives this information via its MIDI In Jack, located on the rear panel. Connect a standard, 5-pin MIDI cable from the MIDI Out jack of a MIDI keyboard, or alternative MIDI controller to the SQ-R's MIDI In jack. Make sure that the controller is transmitting MIDI information, and that both the controller and the SQ-R are set to the same MIDI channel (see Section 2 for more details).

Next, connect the Audio Outputs of the SQ-R to the line level inputs of a mixer, instrument amplifier, or any other sound system using 1/4 inch audio cables. If your system is stereo, connect the Left and Right Outputs to two channels of your mixer, stereo, etc. If it's mono, use either of the Audio Outputs but make sure nothing is plugged into the other output. For listening through headphones, plug the phones into the front-panel jack marked *Phones*. If you're running the SQ-R through a mixer, in stereo, be sure to pan the Left input fully left and the Right input fully right.

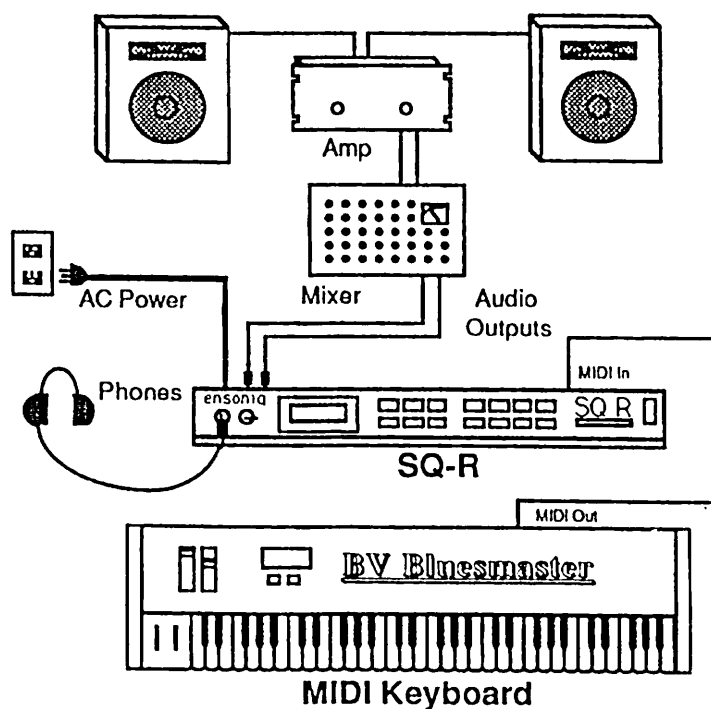

It is a good idea to turn your audio system off (or down) when making connections to avoid damaging speakers or other components.

Warning: The SQ-R outputs are line-level and are intended to be connected only to line-level inputs such as those on a mixer, stereo pre-amp, keyboard amp, etc. Connecting the SQ-R audio outputs to a mic-level input, such as a guitar amp or the microphone jacks on a tape deck is not recommended and might result in damage to the device input.

Switch the audio system on and adjust the amplifier volume for normal listening levels. If you hear no sound while playing the keyboard, switch the audio system off and check your connections.

Running Your SQ-R Through a Home Stereo System

If you are thinking about amplifying your SQ-R through your home stereo, a word of caution is in order. A home stereo is great for playing CD's, albums, tapes — the dynamic range of these media is limited, and your speakers aren't usually subjected to extreme volume changes and frequency transients. While the dynamic range of CD's is significantly greater than LP's or tapes, the output of a CD player is still conservative compared to the uncompressed, unlimited line-level output of a pro-level keyboard. Running your SQ-R — or any pro-level keyboard — through a home stereo at high volume levels can damage your speakers. If your only means of amplification is your home stereo, then try to keep your levels on the conservative side.

Rear Panel Connections

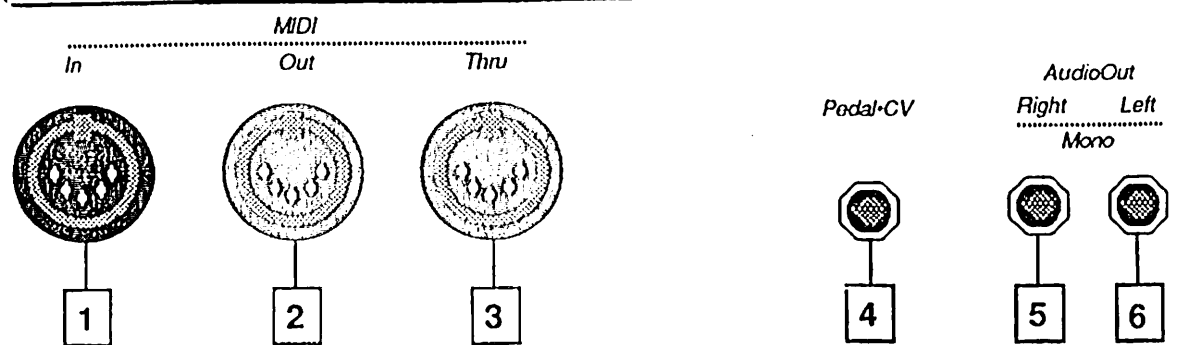

1) MIDI In

Receives MIDI (Musical Instrument Digital Interface) information from other MIDI instruments or computers. This is the jack you will use to "drive" the SQ-R.

2) MIDI Out

Sends out MIDI information to other instruments and computers.

3) MIDI Thru

"Passes on" all MIDI information received by SQ-R to other devices. Information generated by the SQ-R itself does not go to this jack — the Thru jack merely echoes what comes in at the MIDI In jack.

4) Pedal/CV

This jack is for connecting an optional ENSONIQ Model CVP-1 Control Voltage Foot Pedal, which is assignable as a modulator to various parameters within the SQ-R. The pedal gives you a handy alternative modulation source when, for example, you would want to use a mod wheel but both hands are busy. A CV pedal plugged into this jack can also act as a volume pedal, controlling the overall volume level of the SQ-R.

Pedal/CV Specs: 3-conductor (Tip=control voltage input, Ring=2 KOhm resistor to +12 Volts, Sleeve= ground). 68 KOhm input impedance, DC coupled. Input voltage range=0 to 10 volts DC. Scan rate=32mS (maximum recommended modulation input= 15 Hz). For use with an external control voltage, use a 2-conductor cable with the voltage on the tip and the sleeve grounded.

5) Right/Mono Output

To operate the SQ-R in stereo, connect this output to a channel of your mixer and pan that channel right. Note that *either* of the audio outputs can be used as a mono output. If you want to use this jack to listen to the outputs in mono, make sure that nothing is connected to the Left/Mono Output jack.

6) Left/Mono Output

When operating the SQ-R in stereo, connect this output to a channel of your mixer and pan that channel left. To use this jack to listen to the outputs in mono, make sure that nothing is connected to the Right/Mono Output jack.

The Front Panel — Communicating with the SQ-R

Everything you do on the SQ-R — whether it's selecting a sound, editing that sound, adjusting the tuning, etc. — is controlled from the front panel using the following controls:

- The 32 character LCD display
- The *Select Sound* and *Edit Sound* buttons
- The *Select Preset* button
- The *Edit Track* button
- The two *Track* buttons
- The *System* button
- The *Effects* button
- The *Enter/Save* button
- The *Bank Select* button
- The *Left/Right* and *Up/Down Arrow* buttons

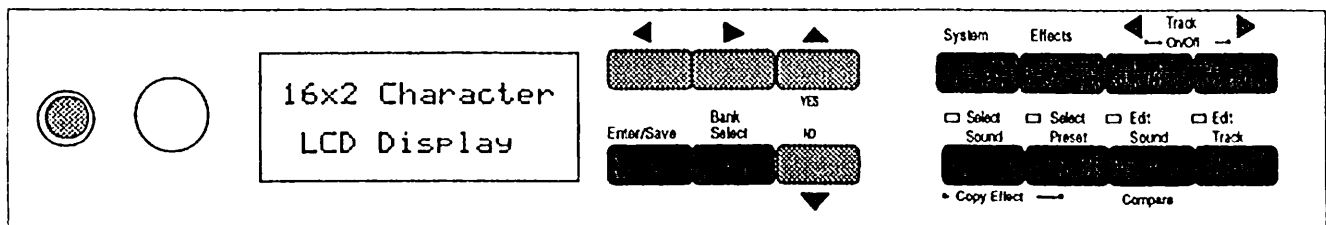

The SQ-R's user interface is designed to enable you to get around the instrument quickly and easily, whether selecting and playing sounds, or setting up and editing presets.

In order to accomplish this, the SQ-R is *always* in one of four *modes*. These are:

- 1 — Sound Select Mode
- 2 — Sound Edit Mode
- 3 — Preset Select Mode
- 4 — Track Edit Mode

You select these modes by using the following four *Mode Buttons* (once you have activated any of the SQ-R's modes using the buttons described below, you can use the *Bank* button and the *Left/Right Arrow* buttons to move around inside the selected mode):

1) Select Sound Button

Pressing the *Select Sound* button, located in the far left position in the bottom row of four buttons, displays the current track number and ON/OFF status, the sound location and name, lights its LED and places the SQ-R in Sound Select Mode. Whenever you would like to change a sound, this mode must be activated. After pressing the *Select Sound* button, using the *Bank Select* button in conjunction with the *Left/Right* and *Up/Down Arrow* buttons will select any of the available sounds.

If the MIDI In Mode is OMNI or POLY, only one track at a time can be played, effectively making this the "solo" track button. Any program changes received through MIDI while the SQ-R is in Sound Select Mode (with MIDI In set to OMNI or POLY) will select a new sound and its effect for the current track.

When the MIDI In Mode is set to MULTI, program changes received will select a new sound, but the effect will not change unless the program change is preceded by the load effect program change (see *Section 3 — Presets* for further details).

2) Edit Sound Button

Pressing the *Edit Sound* button, located in the third position in the bottom row of four buttons, lights its LED and places the SQ-R in Sound Edit Mode. This is where all sound editing is done. From this mode you can choose waveforms, change envelopes, etc. Pressing the *Bank Select* and *Up/Down* and *Left/Right Arrow* buttons takes you to the individual parameters within the Sound Edit Mode. An edited sound can be compared with the original sound by pressing this button while Sound Edit Mode is active.

Select Preset Button

Pressing the *Select Preset* button, located to the right of the *Select Sound* button, lights its LED and places the SQ-R in Preset Select Mode. The display will show the current preset location, the status of each track, and the name of the preset. After pressing the *Select Preset* button, the *Up/Down* and *Left/Right Arrow* buttons can be used to select and play any available preset.

The track status display also functions as a MIDI receive indicator. When a key down is received on a specified track, the track number will change to a musical note. When all keys are up on the specified track, the number will be redisplayed.

For more information see *Section 3 — Presets*.

4) Edit Track Button

Pressing the *Edit Track* button, located in the far right position in the bottom row of four buttons, lights its LED and places the SQ-R in Track Edit Mode. This mode is used for such tasks as setting MIDI channel and program number, track volume, panning, etc. Using the *Bank Select* and *Left/Right Arrow* buttons will select the individual parameters or commands within the Track Edit Mode. The effect is not changed when entering this mode.

Note: If the MIDI In Mode is set to OMNI or POLY, only the current track is heard in Track Edit mode.

Track Buttons

The two rightmost buttons in the top group of four are the *Track* buttons. The *Track* buttons are used to select which tracks are active. Pressing either button individually will scroll through the tracks (when on track 8, pressing the increment *Track* button takes the SQ-R to track 1).

When both buttons are pressed together, the ON/OFF status of the currently selected track toggles back and forth. This is how instruments are "stacked" in OMNI and POLY MIDI In modes (for more details see *Section 3 — Presets*). If the MIDI In mode is MULTI, the status of the currently selected track toggles between OFF and BOTH. There is always at least one track ON, and up to seven other tracks can be turned on (for layering) within a Preset (again, more details in *Section 3 — Presets*).

System Button

Pressing the *System* button, located in the far left position in the top row of four buttons, allows access to all global system and MIDI configuration parameters and all storage functions, regardless of the mode the SQ-R is in.

Hint: When the *System* button is double-clicked, it functions as a MIDI Panic button by resetting all of the SQ-R voices. When any of the four mode buttons are pressed after the *System* button, the SQ-R enters that mode.

Effects Button

Pressing the *Effects* button, located in the second position in the top row of four buttons, allows access to all effect parameters. The effect parameters are *mode dependent*; when in Sound Select or Sound Edit modes the parameters affect the Effect that is a part of the currently selected sound. When in Preset Select or Track Edit modes, the parameters will affect the selected preset's Effect.

Enter/Save Button

The *Enter/Save* button, located in the far left position in the bottom row of three buttons, performs various functions. When a command is selected, pressing the *Enter/Save* button will execute that command. When a command is not selected, pressing the *Edit/Save* button saves either the current sound or current preset, depending on the current mode.

Bank Select Button

The center button in the bottom group of three is the *Bank Select* button. The *Bank Select* button is used to select groups of parameters, commands, or sounds. Which banks are selected is determined by which mode the SQ-R is in. When in Preset Select Mode, this button has no effect.

When in Sound Select Mode, pressing the *Bank Select* button will change the sound group (INTERNAL, ROM, CARD A, or CARD B).

In either Sound Edit or Track Edit Modes, the name of the current bank will show while the button is held, returning to the previous display once the button has been released. If the *Up* or *Down Arrow* (*Yes* and *No*, respectively) button is pressed while the *Bank Select* is held, the previous or next bank within that mode will be displayed and selected.

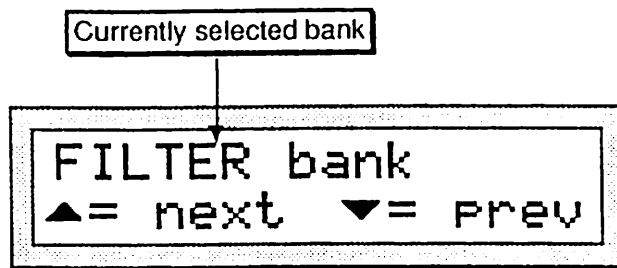

If the *Left* or *Right Arrow* button is pressed while the *Bank Select* button is held down, the previous or next screen within that bank will be displayed without the bank name screen.

Left/Right Arrow Buttons

The *Left/Right* buttons serve two functions. When the SQ-R is in either of the Select modes the *Left/Right Arrow* buttons select Sound or Preset locations by ten. For example, from sound INT 21 (Internal sound #21) the *Right Arrow* takes you to sound INT 31 and the *Left Arrow* takes you to sound INT 11. This allows you to move through the sounds and presets more quickly.

When in either of the Edit Modes, the *Left/Right Arrow* buttons select the next or previous parameter within the currently selected parameter bank.

Up/Down Arrow Buttons

The *Up/Down* buttons also serve two functions. When the SQ-R is in either of the Select modes the *Up/Down Arrow* buttons select Sound or Preset locations by one. For example, from sound INT 21 (Internal sound #21) the *Up Arrow* takes you to sound INT 22 and the *Down Arrow* takes you to sound INT 20.

When in either of the Edit Modes, the *Up/Down Arrow* buttons select the values within the currently selected parameter.

Volume Knob

The Volume Knob, located to the left of the LCD display, controls the overall volume output of the SQ-R. Under normal circumstances, turn the volume knob *all the way up*. As with any digital musical instrument, the SQ-R will give the best results if you keep the volume as high as possible without overloading your sound system and use the volume control on your mixer or amp to adjust its level.

Phones

Also found on the front panel is the headphone jack, located to the left of the volume knob. To listen to the SQ-1 in stereo through headphones, plug the phones into this jack. Headphone volume is controlled by the volume knob on the front panel. (Note that plugging headphones into this jack *does not* automatically turn off the audio in the regular left and right outputs.)

Parametric Programming

The method used to modify or edit sounds, presets and system parameters is called *Screen-driven Parametric Programming*, which sounds like a mouthful, but don't worry. Once you've grasped a few basic concepts you'll find that operating the SQ-R is quite simple, given its many capabilities.

You may have already encountered some form of parametric programming on other synthesizers. What this means is that instead of having a separate knob or slider for each function, you have *Arrow buttons* which adjust the value of whichever parameter you select.

This approach has many advantages, the most obvious of which is that it greatly increases the amount of flexibility and power that can be fit into a single rack-space package.

Screens

The 32-character LCD display makes it possible to display information in *Screens*. Each time you press one of the front panel buttons, you are in effect "tuning in" that function's screen. Once you have tuned in the screen you want, the display shows you which parameters are controlled from that screen.

Multiple Parameters

Some of the SQ-R screens contain more than one editable parameter. When a screen with multiple parameters is displayed, the *Left/Right Arrow* buttons are used. These buttons scroll through the parameters shown on the selected screen then continue on to the next screen.

Changing a Parameter

Suppose you want to adjust the master tuning of the SQ-R. This is a System parameter, so you first need to get to the System Bank. This is located by pressing the *System* button. The display shows the following screen:

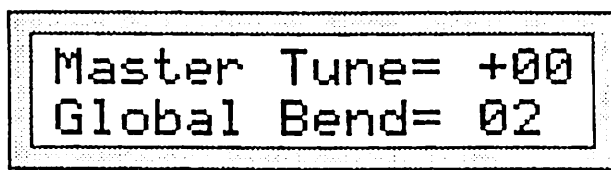

```
Master Tune= +00
Global Bend= 02
```

The Master Tune parameter comes up in the display. The value segment of the display will now be flashing, telling you that it has been *selected*, and can be modified.

The value of the currently selected parameter on a screen is always flashing.

Once you have selected a parameter to be modified, use the *Up/Down Arrow* buttons to adjust its value:

- Pressing the *Up/Down Arrow* buttons will increase or decrease the value one step at a time. Continuing to hold down either button will cause it to accelerate and run quickly through the values.

Hint: There is a quick way to center or "zero out" the value of any parameter which has a center value, as the Master Tune parameter does. While holding down the *Down Arrow* button, press the *Up Arrow* button, then quickly release both buttons. This automatically sets the parameter value to its center value.

Additionally, you can reach the maximum and minimum values of any parameter by pressing either the *Up Arrow* (for maximum) or *Down Arrow* (for minimum) button and, while continuing to hold it down press either of the *Left* or *Right Arrow* button.

If you select another screen, change some parameter on that screen, and then return to the Master Tune Screen, the parameter you had last selected will still be flashing. The SQ-R always "remembers" which parameter was last selected on a given screen.

Be sure that the parameter you want to edit is selected before pressing the *Up/Down Arrow* buttons. There is *always* a parameter selected on any given screen.

Playing Sounds

Sound Memory

Each SQ-R sound is a complex structure consisting of up to three voices per key and a programmable effects setup. The SQ-R can give you access to up to 340 different sounds from which to choose at any time:

- ROM — 80 sounds are permanently stored in its *ROM Memory*. These sounds can be either Standard sounds or Drum sounds. (See Sections 6 and 7 for details.)
- INT — 80 sounds can be stored in the SQ-R *Internal Memory* (RAM). Like the ROM sounds the INT sounds are contained within the SQ-R; but unlike the ROM sounds they can be replaced.
- CARD A and B — 80 additional sounds can be stored in both Group A and B of a sound card plugged into the card slot. As with the Internals, sounds stored in the Card can be Standard or Drum sounds.
- DRUM BANKS — Sound Banks 8 and 9 each contain ten dedicated Drum kits. These drum kits are available whether you're currently in the Internal, ROM, or Card sound banks. The Drum kits in Banks 8 and 9 are also permanently stored in ROM memory and cannot be modified or replaced.

Selecting a Sound

To select a SQ-R sound:

- Press the *Select Sound* button. This places the SQ-R in Sound Select mode and the Select Sound LED will light. Once in Sound Select mode, it is not necessary to press the *Select Sound* button again to select a new sound.
- Use the *Up/Down* and *Left/Right Arrow* buttons to select different sounds within a particular sound group (for example, the internals).

The *Up/Down Arrow* buttons scroll through all the sounds within the current sound group one at a time. The *Left/Right Arrow* buttons move through the sounds by ten. For example, from sound INT 21 (Internal sound #21) the *Right Arrow* takes you to sound INT 31 and the *Left Arrow* takes you to sound INT 11. This allows you to move through the sounds more quickly.

The arrows will scroll through all sounds within the current sound group and then continue scrolling up through the dedicated Drum kits. Try selecting and playing a few different sounds.

Choosing Internal, ROM, Card and Drum Sounds

Three methods can be used to choose between Internal, ROM and Card A and CARD B sound groups. The top line of the screen tells you the group and location of the sound.

- The *Select Sound* button — Repeatedly pressing the *Select Sound* button will step through the various sound groups.
- The *Bank* button — As with the *Select Sound* button, repeatedly pressing the *Bank* button will step through the various sound groups.
- *Direct Dialing* — You can reach any of the sound groups directly by pressing the *Select Sound* button, and while continuing to hold the *Select Sound* button down, press *System*, *Effects*, or the *Left/Right Track* buttons. These buttons take you to the Internal, ROM, Card A, and Card B sound groups respectively.

Note: These sound groups contain 80 sounds each, located in Banks 0-7. Banks 8 and 9 will always call up the dedicated Drum kits.

Memory Cards

Memory cards can be used to add more sounds to the SQ-R and allow you to store your sounds and presets. Before you can access sounds and presets from a card, you must first insert an ENSONIQ SC or ISC series card, an MC-32 or 64 RAM card, or other SQ card into the Card slot, with the label facing up. Take care to insert the card straight into the slot in a continuous fashion.

Cards can be inserted or removed at any time (except while you're writing sounds to them), even when the power is on, without doing any harm to the SQ-R or the card. For more information regarding cards, see Section 8 — Storage.

Reinitializing the SQ-R

The great power and flexibility of the SQ-R lies in the fact that it is really a computer — a computer disguised as a keyboard instrument, but a computer nonetheless. The software that operates the SQ-R is very sophisticated. In fact, there is a 128K computer program that runs inside the SQ-R (the Operating System code). That's as much as some personal computers. If you have ever used a computer, you should be familiar with the need to occasionally reboot your system when you get an error message, etc. Reinitializing the SQ-R is the equivalent of rebooting your computer.

There are many things that can happen to the SQ-R (or any computer system) that might scramble the system software — voltage surges, power failures, static electricity, etc. As with any computer, very infrequently some unforeseen event or combination of events can cause the software to become confused with strange and unpredictable results. Sometimes computers that appear to be broken have no hardware problem, just corrupted data in the internal RAM (Random Access Memory). Sometimes, simply turning the SQ-R power off and then on again will cure the problem. If that doesn't work, perhaps what is needed is to reinitialize the unit.

When to Reinitialize:

If your SQ-R begins to behave in peculiar ways, if the display shows words or lines that shouldn't be there, if you start getting Unexpected Event messages, if the edit functions start doing unpredictable things, try reinitializing the SQ-R before you seek factory service.

Warning:

When you reinitialize your SQ-R all your current internal sounds and presets will be lost. (The 80 ROM (Read Only Memory) sounds are automatically loaded back into the internal memory after reinitializing.) Therefore good backup habits should be an important part of your routine. Save any important data to a storage card or MIDI Sys-Ex before reinitializing the SQ-R.

To Reinitialize the SQ-R:

- Press the *System* button.
- While holding down the *System* button, press the *Down Arrow* button.
- The display reads "Re-initialize all RAM?"
- Press the *Up Arrow* button. The *Up Arrow* button also acts as a *Yes* button to respond to questions on the display (the *Down Arrow* button acts as *No*).

If reinitializing your SQ-R does not correct the problem, then contact an authorized ENSONIQ Repair Station.

Low Battery Voltage — When to Replace the Battery

The reason that the SQ-R "remembers" sounds and other parameters, even when the power is off, is that all of its internal RAM is "battery-backed-up." The battery that keeps the SQ-R memory intact is located inside the SQ-R, and when it becomes discharged, it must be replaced by an authorized ENSONIQ Repair Station.

The battery that came in your SQ-R is good for up to five years. You will know when it needs replacing, because the SQ-R will tell you so. One day you will switch the power on, and instead of its usual wake-up message, the display will read:

WARNING! Battery low
see manual.

Press any button to commence normal operation. Then, make sure that all sounds and presets are saved to a storage card, and take the SQ-R to an authorized ENSONIQ Repair Station as soon as possible to have the battery replaced.

SQ-R Accessories

These optional accessories are available from your ENSONIQ dealer:

- **CVP-1 PEDAL** — A *Control Voltage Foot Pedal* which can be assigned as a modulator within the voice section of the SQ-R or used as a volume pedal.
- **MC-32 and MC-64 RAM Cards** — For storing the sounds and presets you create or edit. Sounds and presets can be saved to the MC-32 or MC-64 in the same manner as saving data to internal memory.
- **SC series ROM Cards** — Contains 160 factory-programmed sounds. Unlike the MC-32 and MC-64, the sounds in SC cards are stored permanently and cannot be replaced.
- **ISC series ROM Cards** — Contains 160 sounds programmed by leading sound developers from around the world. Unlike the MC-32 and MC-64, the sounds in ISC cards are stored permanently and cannot be replaced.

Need More Help?

Whether you're an aspiring programmer looking for additional information about basic synthesizer and MIDI theory, or a professional sound designer working with advanced applications, you may want more detailed information that is beyond the scope of this manual. The following books can help enhance your understanding of synthesis, MIDI, and related topics. These, in addition to the numerous monthly magazines, provide a wealth of information. While we don't endorse any one of these publications, we offer this partial list as a resource.

Alexander Publishing

For prices and additional information call: 1-800-633-1123

MIDI

1989—*HOW MIDI WORKS*, Dan Walker
MURPHY'S LAW MIDI BOOK, Jeff Burger

SAMPLING

SAMPLING BASICS, Bob Maestas

SEQUENCING

SEQUENCING AND ARRANGING Vol's 1-4, Joseph Wagner

SYNTHESIZERS

RECORDING, SYNCING & SYNTHS, Paul Goldfield
TEACH YOURSELF KEYBOARD PLAYING & IMPROVISING,
Vol's 1 & 2, Dr. Jack Wheaton

The Mix Bookshelf

For prices and more information call: 1-800-233-9604

In California call: 1-800-641-3349

MIDI

MIDI FOR MUSICIANS, Craig Anderton
MUSIC THROUGH MIDI, Michael Boom
THE MIDI HOME STUDIO, Howard Massey
THE MIDI BOOK, Steve De Furia
MIDI RESOURCE, Steve De Furia
MIDI IMPLEMENTATION BOOK, Steve De Furia
THE MIDI SYSTEM EXCLUSIVE BOOK, Steve De Furia
USING MIDI, Helen Casabona, David Frederick
MIDI, THE INS, OUTS AND THURS, Jeff Rona

SAMPLING

THE SAMPLING BOOK, Steve De Furia, Joe Scacciaferro

SYNTHESIZERS

GUITAR SYNTH & MIDI, Guitar Player Magazine
SECRETS OF ANALOG AND DIGITAL SYNTHESIS, Steve De Furia
BEGINNING SYNTHESIZER, Helen Casabona, David Frederick
THE NEW COMPLETE SYNTHESIZER, David Crombie
SYNTHESIZER BASICS, Dean Friedman
THE KEYBOARD SYNTHESIZER LIBRARY, Keyboard Magazine
A SYNTHESIST'S GUIDE TO ACOUSTIC INSTRUMENTS, Howard
 Massey

GPI Books

For prices and more information call 1-800-999-9018

MIDI

ADVANCED MIDI APPLICATIONS
BASIC MIDI APPLICATIONS
MIND OVER MIDI
USING MIDI
WHAT IS MIDI?

Section 2 — System Control

- These parameters control instrument-wide system and MIDI functions.

System Bank:

Master Tune	2 - 1
Global Bend	2 - 2
Pedal/Edit Key Range	2 - 2
MIDI Track Name	2 - 2
Voice Muting	2 - 3
Base Channel	2 - 3
MIDI Mode — MIDI In Mode	2 - 4
Global Controllers in MONO Mode	2 - 4
MIDI Loop/Xctrl — External Controller	2 - 5
Controllers/System Excl — MIDI System Exclusive Enable	2 - 6
Program Change	2 - 7
Receiving Program Changes	2 - 7
Selecting a New Preset Effect from MIDI	2 - 7
Preset Prog — Preset Program Change.	2 - 8
Retransmit/All Note Off	2 - 8
Store Sounds	2 - 9
Store Presets	2 - 9

System Bank

The System Bank contains several screens. These screens give you control over some of the SQ-R's instrument-wide system and MIDI parameters. The settings of these parameters will remain in effect at all times and are preserved while the power is off.

Press the *System* button. You are now in the System Bank.

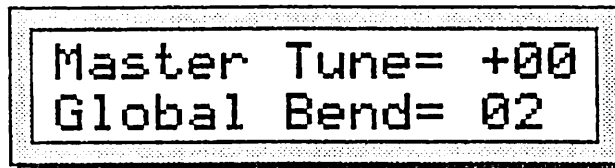

Master Tune

Adjusts the overall master tuning of the SQ-R up or down as much as one semitone. A value of +00 will set the SQ-R to concert A=440 tuning.

Range: -99 to +99 cents.

Global Bend

Adjusts the system pitch bend range, which is the maximum amount of pitch bend which can be applied with the pitchwheel of the controlling keyboard. Each increment represents a semitone.

When the amount is followed by an "H," only those notes held by hand can be bent. Notes held with a sustain pedal will remain at their original pitch. This feature can be used to create guitar-style pitch bends from the controlling keyboard. It is also useful in split keyboard set-ups, allowing you to bend lead lines that are played over a sustaining pad

Range: 0 to 12, 1H to 12H.

Pedal/EditKeyrange
System Bank

Pedal

Determines whether the optional CVP-1 foot pedal will act as a volume pedal or modulator.

- Volume #7 — the foot pedal will adjust the volume of the SQ-R.
- Mod #4 — the foot pedal will affect anything that has PEDAL selected as a modulation source. (The "#7" and "#4" refer to the controller number assigned in the MIDI Specification. See the MIDI Implementation chart.)

EditKeyrange — Edit Key Range

This parameter allows you to use your controller keyboard to define key ranges.

- ON — Any key range parameter can be set by simply playing keys on the controller keyboard connected to the SQ-R's MIDI In port. This allows a quick and convenient method for entering key ranges.
- OFF — When this parameter is set to MIDI or OFF, playing the controller keyboard connected to the MIDI In jack of the SQ-R will not enter values when a Key Range parameter is selected.

MIDI TrkName/Voice Muting
System Bank

MIDI TrkName — MIDI Track Name

This parameter determines whether preset tracks which have MIDI status will show the sound name (as do LOCAL and BOTH tracks) or show *MIDI-CHAN-# instead of the sound name.

- OFF — When a track's status is set to MIDI in the Edit Track PARAMeter bank, any displays which would normally show the track's sound name will show *MIDI-CHAN-# instead of the name.
- ON — The track's sound name will always appear on the Track screens and the performance parameter screen (in preset mode) no matter what the track's status.

Voice Muting

This parameter controls whether or not all voices currently playing will be shut off when a new sound is selected. This lets you avoid any audible discontinuity as the new sound's effect is loaded, but at the expense of being able to sustain a note from one sound while selecting and playing another.

- ON — Whenever you select a new sound, any voices that might be sustaining from the previous sound will be stopped.
- OFF — When you select a new sound, voices that are sustaining from previous sounds will continue to play as long as the key(s) are held down. The old voices will go through the effect of the new sound, so they might sound different, especially if the new sound uses a radically different effect.

Base Channel/MIDI Mode
System Bank

<p>Base Channel= 01 MIDI Mode=MULTI</p>

Base Channel

Selects the Base Channel on which the SQ-R transmits and receives MIDI messages. The base channel is used to transmit and receive MIDI data while the SQ-R is in Sound Select mode. When working within a preset, the SQ-R automatically transmits and receives MIDI data on the individual track channels. System Exclusive messages are always sent and received on the base channel.

Range: 01 to 16

Any of 16 MIDI channels may be selected as the basic MIDI channel of the SQ-R. The effect of setting the base channel varies depending on the MIDI Mode and whether data is being transmitted or received.

Receive In POLY mode, keys, controllers and program changes are only recognized if received on the base channel. In MONO A mode, program changes are received only on the base channel. The base channel is also used in both MONO modes as the first channel of the 8 channel range. In MULTI mode, program changes received on the base channel will select a new preset. For this reason, it is advisable to avoid having any tracks within a preset set to the same MIDI channel as the Base Channel (see *Section 3 — Presets* for more details).

Transmit The SQ-R transmits on the individual track channel (see the Retransmit parameter later in this section for a description of how and when the SQ-R transmits MIDI data).

MIDI Mode — MIDI In Mode

This parameter determines how MIDI information will be *received* by the SQ-R. MIDI Mode has no effect on what MIDI information is sent.

There are five MIDI modes implemented in the SQ-R:

- **OMNI** — In this mode the SQ-R will receive on any or all of the 16 MIDI channels. This mode is useful when you are only using a few instruments, and you are not concerned with setting up different channels for each device.
- **POLY** — In this mode the SQ-R will receive only on the Base MIDI channel. MIDI information on all other channels will be ignored.
- **MULTI** — An ENSONIQ innovation, MULTI mode is the key to unlocking the potential of the SQ-R as a multi-timbral receiver from an external MIDI sequencer. In MULTI mode the eight tracks of the current preset can receive MIDI information independently and polyphonically on up to eight different MIDI channels. You can easily create presets for use in multi-channel reception; see *Section 3 — Presets* for details.

Different MIDI channels should be selected for each track which you want to receive. This can be accomplished on the MIDI Channel screen (see *Section 3 — Presets* for more information).

In MULTI mode, independent of what sounds are selected on the front panel, the sounds you hear will depend entirely on what MIDI channel(s) the MIDI data is received on.

MONO Mode

MONO mode is particularly useful for driving the SQ-R from a guitar controller, or any other application where having up to eight independent, monophonic channels is desirable.

The SQ-R offers two types of MONO mode operation. In MONO A, the SQ-R will receive monophonically on eight consecutive MIDI channels starting with the Base channel (the base channel through base channel +7). In MONO B mode, each track on the SQ-R can be set to receive on any MIDI channel, operating similarly to MULTI mode, with the difference of each channel receiving monophonically.

- **MONO A** — This is another ENSONIQ development intended to make using multi-channel controllers like guitars easier. All notes and controllers received will play whatever programs are selected for the note that is played, just as if the note was played from a keyboard. You have the advantage of multiple tracks which will respond independently to controllers received on multiple channels, but you do not have to set up the programs for each track separately.
- **MONO B** — This is the more conventional type of MONO mode. It allows you to set up each track of the current preset as a monophonic synthesizer. Each track can have a different program assigned to it. This is the only way to get a different sound on each string when using a MIDI guitar controller.

Global Controllers in MONO Mode

Global controllers are controllers sent on one channel which affect all other channels simultaneously. They can be useful in reducing the number of MIDI events required to achieve particular effects, and can thereby reduce the delays sometimes associated with overloading MIDI. Some guitar controllers can transmit global controllers, and the SQ-R can respond to them.

In MONO mode (A or B) the base channel minus one becomes the MIDI channel for global controllers (pitch bend, pressure, etc.). For example, if the base channel is channel 3, any controllers received on channel 2 will be interpreted as global controllers and will affect *all* voices being played. If the base channel is channel 1, channel 16 becomes the channel for global controllers. Each track will also respond independently to controllers sent on its own channel. For example, each guitar string on a MIDI guitar can send independent pitch bend, while the "whammy bar" controller could be sent on the global channel to affect all voices. Program Changes received on this global controller channel will select different presets (see Section 3 — Presets for more details).

MIDI Loop/XCtrl
System Bank

MIDI Loop

This determines whether the SQ-R will treat incoming MIDI information as standard MIDI data or data that is "looped" from the SQ-R's MIDI Out.

Any time you can follow the MIDI path from the SQ-R's MIDI Out and trace it back into the SQ-R's MIDI In, you have created a MIDI Loop. When the SQ-R is used in this fashion, it is possible for MIDI volume commands created by the CVP-1 (Control Voltage Pedal) that go out of the SQ-R to re-enter the SQ-R through its MIDI In jack and cause it to behave irregularly (for example, MIDI Volume can have the effect of "looping" and causing the track volume to drop to zero). The MIDI Loop parameter will allow you to use the SQ-R in these situations without running into MIDI difficulties.

- OFF — The SQ-R receives incoming MIDI information in a normal fashion. This is the default setting.
- ON — The SQ-R filters incoming data, ignoring volume commands that would cause difficulty.

Set this parameter to "ON" whenever using the SQ-R in a MIDI Loop.

XCtrl - External Controller

Use XCtrl to assign external MIDI controllers to affect the SQ-R.

Range: 01 to 95

Most controllers on a synthesizer — mod wheel or breath controller for example — have a MIDI controller number which can be assigned to this parameter. Doing so will make a particular external controller available as a modulator to any of your sounds.

One of the modulation sources that can be selected in the programming section is XCTRL. The value of the "XCtrl" parameter is a MIDI controller number, ranging from 01 to 95. When the SQ-R receives MIDI Controller messages corresponding to this controller number, they will be routed to *all* parameters which have been programmed with XCTRL as a modulation source. Suppose, for example, you are playing the SQ-R from a keyboard with a breath controller. You can set up a program on the SQ-R in which the filter cutoff frequency is modulated by XCTRL. If you then set "XCtrl=02," the breath controller will now be able to modulate the filter, or whatever else has its modulation source set to XCTRL, in the sound you have created.

The following controller numbers have been agreed upon as MIDI standards:

Number	Controller	Number	Controller
1	Modulation wheel	66	Sostenuto pedal
2	Breath controller	70	Patch selects
4	Foot pedal controller	92	Tremolo Depth
6	Data Entry Slider	93	Chorus Depth
7	Volume	94	Celeste (Detune)
64	Sustain pedal	95	Phaser Depth

Although the range of this control is from 01 to 95, most of the values other than those listed above have no "approved" function, as yet. They are there to provide flexibility and to accommodate future MIDI standards.

Controllers/System Excl
System Bank

```

Controllers= OFF
System Excl= OFF

```

Controllers

This switch controls whether the SQ-R will send and receive MIDI controllers — pitch bend, mod wheel, pressure, volume, sustain pedal, etc.

System Excl — MIDI System Exclusive Enable

This switch determines whether the SQ-R is able to receive MIDI System Exclusive messages. When System Excl=OFF, the SQ-R is not able to receive any MIDI System Exclusive messages. The Sys-Ex messages which are sent from the Storage screens can always be transmitted regardless of the setting of this switch. (Refer to Appendix A for more information about the Sys-Ex implementation).

Prog Change/Preset Prog
System Bank

Prog Change — Program Change

This switch controls how the SQ-R handles MIDI program change messages.

- OFF — the SQ-R will *not* transmit or receive MIDI program changes.
- ON — the SQ-R will transmit and receive program changes over MIDI.

Important: Program changes are numbered and displayed from 001 to 128 in the SQ-R, though to comply with the MIDI specification they are transmitted and received as 000-127.

Receiving Program Changes

The way in which the SQ-R receives program changes is slightly more complex than some other systems because the number of sounds that are available to be selected from MIDI is *larger* than the number of program change messages available within the MIDI standard. To solve this problem, the SQ-R uses the last four program change numbers (125 to 128) to control how subsequent program changes will be interpreted. The following chart shows the effect of these four special program changes:

<i>After Program Change:</i>	<i>Subsequent program changes will select:</i>
125	000..079 - INT Sounds
126	000..079 - ROM Sounds
127	000..079 - CARD A Sounds
128	000..079 - CARD B Sounds

These special "control" program changes need to be sent only once. When the SQ-R receives. All subsequent program changes will be handled according to the range that was set by the last one received.

Note: Program Changes 080-099 *will always* select the default Drum kits.

The SQ-R has one other method of switching banks, the MIDI Bank controller. See *Section 3 — Presets* for more details.

Selecting a New Preset Effect from MIDI (Program Change 124)

There is another special program change, recognized only in MULTI mode which is used to select *both* a sound *and* its effect for one of the eight preset tracks. When program change 124 is received on a channel assigned to a preset track, the next program change received on that track will select a new sound and also install the effect from that sound into the preset effect. This is the only way to change the preset effect other than manually editing the settings or selecting a new preset. This can be useful when controlling the SQ-R from an external sequencer.

This special program change 124 does not change the way in which other program changes are received, including the other special messages. If the sound you wish to select also requires a special control program change, then send the control message immediately after the 124 followed by the program number you want to select.

Remember: All SQ-R program changes are referred to and displayed as 001 to 128, but the actual codes transmitted and received over MIDI are the number minus one (000 to 127).

Preset Prog — Preset Program Changes

This parameter determines whether program changes received by the SQ-R will select new presets when the SQ-R is in Preset Select mode (with the Select Preset LED lit).

- OFF — the SQ-R will *not* change presets from received program changes.
- ON — program changes received on the base channel (in OMNI, POLY and MULTI modes) or the global controller channel (in MONO A and MONO B modes).

Important: In order to respond to these changes, the SQ-R must first be in Preset Select mode. This can be accomplished either from the front panel, or a special program change (#123) can be issued to place the SQ-R into Preset Select mode via MIDI.

Retransmit/All Note Off
System Bank

Retransmit

A unique and powerful feature, retransmit turns on the SQ-R's Smart Transmit function, allowing the SQ-R to take incoming single channel MIDI data and, using its preset functions, retransmit the data from the SQ-R's MIDI Out jack in multi-channel form. See *Section 3 — Presets* for more details on this exciting feature.

- OFF — the SQ-R will *not* retransmit incoming MIDI data out its MIDI Out jack (MIDI information will still pass normally through the MIDI Thru jack, however).
- ON — the SQ-R will retransmit incoming MIDI data out its MIDI Out jack, with rechannelization.

All Note Off

This parameter determines whether the SQ-R will respond to a MIDI All Notes Off command. All Notes Off is a MIDI mode message which turns off all voices turned on via MIDI, with the exception of notes being held with a sustain pedal at the time the message is received. Also, All Notes Off is not recognized when the receiving instrument (the SQ-R) is in OMNI mode.

- OFF — the SQ-R will *not* recognize incoming All Notes Off messages.
- ON — the SQ-R will recognize incoming All Notes Off messages.

With this in mind, the SQ-R does not *transmit* an All Notes Off command (though it obviously "passes on" any such messages via its MIDI Thru jack). When double-clicking the *System* button to turn off all internal voices in the SQ-R, individual Note Off messages are sent via the MIDI Out jack.

Store Sounds

System Bank

This parameter is used to save sounds to card or via MIDI System Exclusive commands. See *Section 8 — Storage Functions* for details.

Store Presets

System Bank

This parameter is used to save presets to card or via MIDI System Exclusive commands. See *Section 8 — Storage Functions* for details.

Section 3 — Presets

About Presets	3 - 1
Selecting Presets	3 - 2
Editing Presets	3 - 2
Track Status	3 - 3
Compare-Using the Select Preset Button	3 - 3
Edit Preset Buffer	3 - 3
Abandoning Your Edits	3 - 4
Saving a New Preset Into Memory	3 - 4
Copying an Existing Preset to Another Location	3 - 4
About Tracks	3 - 5
Replacing the Sound on a Track	3 - 5
Putting a Sound onto a Track along with its Effect	3 - 6
Layering Sounds in a Preset	3 - 6
Using Effects with Presets	3 - 6
About Performance Parameters	3 - 7
Parameter Bank:	
Transpose	3 - 8
Key Range	3 - 9
MIDI Channel	3 - 10
MIDI Bank	3 - 10
MIDI Program Number	3 - 10
Program Changes in the SQ-R	3 - 11
Receiving Program Changes	3 - 11
Selecting a New Preset Effect from MIDI	3 - 11
Selecting a New Preset with Program Changes	3 - 11
MIDI Status	3 - 12
Pressure	3 - 13
Sustain Pedal	3 - 14
Mix Bank:	
Volume	3 - 15
Pan	3 - 15
Output	3 - 16
Timbre	3 - 16
Release	3 - 17
The Smart Transmit Function	3 - 18
Pressure	3 - 19
A Few Important Points About MULTI Mode	3 - 21

About Presets

A *Preset* is a combination of up to eight sounds with their corresponding performance parameters and an effects set-up which can be instantly recalled for use in performance. Presets are handy "performance memories" which allow you to create and save sound combinations, splits, layers, etc.

The eight sounds in a preset reside on eight *Tracks*. Each of these eight tracks, the SQ-R remembers which sound is assigned to the track, whether the sound is on or off, and the values of all the Performance parameters for that track (discussed later this section).

A preset also has one Effects program which is common to all eight tracks. Presets are also at the heart of the SQ-R's Smart Transmit function, allowing single channel MIDI data to be converted into an eight-zone controller.

Selecting Presets

Press *Select Preset*. The LED above the *Select Preset* button lights and the following screen appears:

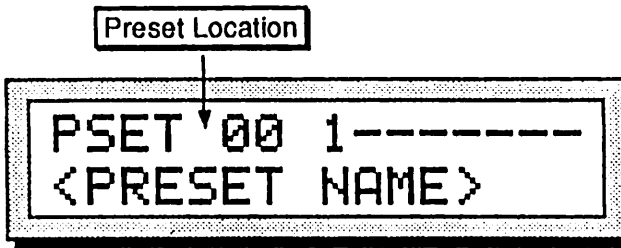

Whenever the *Select Preset* LED is solidly lit, this indicates that the SQ-R is in Preset Select mode, and the *Up/Down* and *Left/Right Arrow* buttons will now select presets (rather than selecting sounds, as they do when the *Select Sounds* LED is lit). The *Left/Right Arrow* buttons move through the presets in increments of 10, while the *Up/Down Arrow* buttons scroll through each preset individually.

Each time a new preset is selected, the following things occur:

- a new preset effect is loaded,
- new sounds are loaded into each track and program changes are sent via the MIDI Out jack on any track in which the status is set to MIDI or BOTH, and
- MIDI Volume, Timbre, and a sustain release command are sent via the MIDI Out jack on any track in which the status is set to MIDI or BOTH.

Editing Presets

Presets are at the foundation of many of the most powerful features of the SQ-R, such as multi-timbral sound generation and Smart Transmit. Editing presets enables that power to be extremely flexible.

One of the most basic editing features is the process of turning individual tracks on and off within a preset. While this can be done from the MIDI Status parameter in the PARAMeter bank (discussed later in this section), there is a very quick method to accomplish this from the Preset Select screen. Let's look at it again:

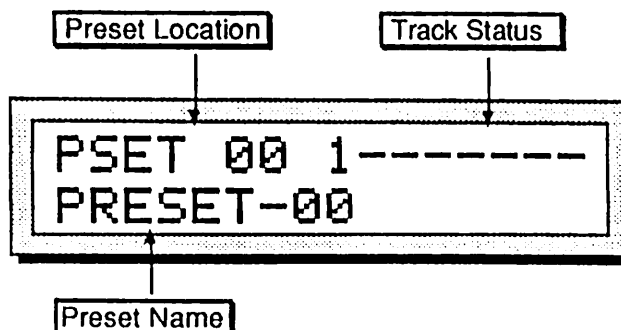

Across the lower line, the display shows the name of the preset. On the top line you see the current preset's location and the status of each track.

Track Status

When on this screen, the two *Track* buttons are used to turn the individual tracks on and off. This is done by using either of the two *Track* buttons to select the desired track, then pressing both *Track* buttons simultaneously to change the status. When a track is on, the track number appears in the indicator on the screen. When a track is turned off, a dash (—) appears in that track's indicator.

The track status indicators have another important purpose. When a channel is receiving incoming MIDI data, the status indicator for that track will change to a musical note. This allows you to determine which tracks are receiving MIDI.

Compare — Using the Select Preset Button

Once a track status has been changed, the bottom line of the Preset Select screen changes. Where originally the preset name appeared, the display now reads "***EDITED PRESET***", indicating that a parameter within the preset has been changed from its current setting. In fact, when *any* parameter within a preset is changed, returning to the Preset Select screen will indicate you are currently working with an edited preset.

To hear the original, unchanged preset, press the *Select Preset* button. You will hear the original preset and see the screen with its original settings. Press *Select Preset* again to return to your edited preset. You can toggle back and forth between the original and the edited sound as often as you like.

Edit Preset Buffer

You can edit a preset, while keeping the original preset intact, because the edited version is kept in a special area of memory called the *Edit Preset Buffer*. Whenever you change any parameter of a preset, the altered preset is put in the edit preset buffer, replacing whatever was previously there. Only one preset at a time can reside there — the buffer always contains the results of your last edit.

When you press the *Select Preset* button, you are alternating between the preset in the original memory location and the preset in the edit preset buffer. We refer to the preset in the edit buffer as the *Edit Preset*.

You can return to the edit preset, even after selecting another preset (as long as you don't change any parameters there) by pressing the *Select Preset* button. This puts you back in the edit buffer, and any changes you make will affect the edit preset.

As with sounds, the rule of thumb is this: Whichever preset you hear, that's what you're editing.

If you like the results of the changes you have made to a preset, you should rename it and save the new preset permanently, to another location. The procedure for this is covered under "Saving a New Preset Into Memory" later in this section.

Abandoning Your Edits

If you decide, while editing a preset, that you're not happy with what you've done, and you want to start over with the original preset:

Press the *Select Preset* button so the Preset Select screen displays the original preset name. Then you can start editing the preset again from scratch. You will lose the one you were working on before.

Saving a New Preset Into Memory

After creating a new preset, or editing an existing preset to better suit your needs, it must be saved into a memory location in order to be available for future access. New or edited presets can be saved into any one of the 80 preset locations with the following procedure.

- 1) Check the Preset Select screen to make sure that the Edited Preset is displayed. If not, press the *Select Preset* button. This indicates that the preset you're hearing is in the edit buffer.
- 2) Press the *Enter/Save* button. This tells the SQ-R that you've finished editing and are ready to save the preset to a memory location. The display will read "Save Preset <PRESET NAME>?" The name listed is the name of the preset you began with when editing.
- 3) Select a name of up to 16 characters for your new preset using the arrow buttons. The *Left/Right Arrow* buttons select the character to be edited, while the *Up/Down Arrow* buttons scroll through the letters, numbers, and icons that can be used to name the preset.
- 4) Press the *Enter/Save* button.
- 5) Select a memory location for your preset using the *Left/Right* and *Up/Down Arrow* buttons. These buttons will select the presets currently residing in internal memory.

Look for a memory location that contains a preset that you no longer want or use. Presets that are in memory can be "auditioned" at this point by pressing the *Select Preset* button to toggle between the preset listed on the screen and the preset in the edit buffer.
- 6) When a location has been found, press the *Enter/Save* button. The display will show a momentary "SAVED" message before returning to the Preset Select mode.

Hint:

If you would like your edited preset to be saved in its present memory location, simply "double-click" the *Enter/Save* button. As in the above procedure the display will momentarily read "SAVED" and then return to the Preset Select mode.

Copying an Existing Preset to Another Location

Sometimes you'll want to take an existing preset, one that you haven't been editing, and simply copy it to another memory location. For example, you might want to put several presets used within the same tune in order, for easy access during performance.

- Select the preset you want to copy.
- Press *Enter/Save*. The display shows "Replace edit preset?"
- Press *Yes*. The selected preset now resides in the edit buffer. Now proceed from step three as described above to write the preset to the new location.

About Tracks

In the SQ-R, the term *track* refers to one of the eight internal "channels," each containing a sound and a complete set of performance parameters, including volume, pan, controller settings, MIDI channel, keyboard range, and others.

When the SQ-R is controlled from an external MIDI sequencer, the various tracks of the sequencer can be assigned to different MIDI channels, which in turn control the sounds played by the SQ-R. Each MIDI channel can be thought of as an extension of the sequencer's track.

Whether playing from a MIDI controller, retransmitting MIDI to a remote device, or receiving MIDI from an external sequencer, we describe this logical construct, comprised of a MIDI channel and a program and various performance parameters, as a track.

Each SQ-R Preset has eight independent polyphonic *Tracks* which are selected from the two *Track* buttons. Let's take a look at the Preset Tracks:

- Press *Select Preset*. This puts the SQ-R in Preset Select mode.
- Press the *Edit Track* button. This takes you to the first Track. Pressing either of the two *Track* buttons will scroll through the other seven tracks.

Replacing the Sound on a Track

Once you have pressed the *Edit Track* button entered Track Edit mode, you can select a screen which lets you change the SQ-R sound on a track with a sound of your choice:

- 1) Press *Edit Track*, then press either of the two *Track* buttons to select the track in which you wish to replace the sound. The screen displays the track number on the upper line.
- 2) Press either the *Right* or *Left Arrow* button repeatedly until you see the following screen:

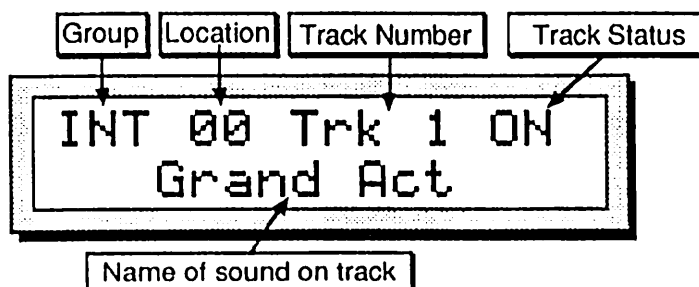

This screen has three *active* parameters and two *display only* parameters. The Track Number and two sound location parameters, Group and Location, are active, and can be selected and modified on this screen.

- 3) Use the *Left/Right Arrow* buttons to toggle between the Group and Location parameters, and use the *Up/Down Arrow* buttons to select a new sound for the track. The Group parameter scrolls between INT, ROM, CARD A, and CARD B (CARD sounds appear only if a sound card is installed) sound groups. The Location parameter scrolls through the individual sounds within the selected group. Notice that as you select new values for this parameter, the display only Sound Name parameter changes as well. This parameter tells you the name of the sound in that location.

While on this screen, you can use either of the two *Track* buttons to select other tracks for replacing sounds. Track Number is the third active parameter on the screen.

Putting a Sound onto a Track along with its Effect

To copy a sound *along with* its effect into the track/preset (replacing the current preset effect with the one in the sound):

- With the track selected that you wish to replace the sound on, press *Select Sounds*.
- Use the *Up/Down* and *Left/Right Arrow* buttons to find the sound/effect combination.
- Press and hold the *Select Sounds* button, and *while holding it down*, press the *Select Preset* button. The sound now appears in the selected Track, with the effect placed globally in the preset.
- Press the *Edit Track* again to return to the track editing functions. The Edit Track LED will light solidly to indicate its return to normal functions.

Layering Sounds in a Preset

In a preset, a maximum of seven sounds may be layered with the selected sound. You can have up to eight sounds layered (stacked) on one key, or up to eight different sounds split across the keyboard by using the Key Range function described later in this section. Layering works only when the SQ-R is in OMNI, POLY, or MONO A MIDI In modes (System bank).

To layer sounds in presets:

- Press *Select Preset*, then select one of the 8 tracks.
- Press both *Track* buttons simultaneously for each track you wish to layer. If a track is layered, it can be un-layered by pressing both track buttons.

Pressing both *Track* buttons in MULTI toggles the track status between *OFF* and LOCAL.

Using Effects with Presets

All eight tracks in a preset share the same effects program. If this effect is incompatible with any sounds in the preset (such as a delay which you want only on a selected sound), there are several options:

- Set the effects routing to DRY for any of the programs which are incompatible. (See Output Screen in the Mix Bank later in this section.)
- Change the preset effect to be something more suitable. (See Replacing the Sound earlier in this section.)

About Performance Parameters

A group of Performance Parameters is associated with each preset track. These parameters control various aspects of the track, including some important and useful sound controls which may be easily adjusted during performance. The settings of these parameters are saved with every preset. These instantly recallable presets include an effect setup and eight sounds on eight tracks with a full set of programmable performance parameters, including key ranges, transpositions, and others. The settings of all performance parameters are saved for each track and are maintained while the power is off.

The Performance/Track Parameters for each Preset are contained within two banks:

Parameter Bank:

KeyRange	set track key ranges
Transpose	key number transposition
MIDI Channel	track MIDI channel number
MIDI Bank	track MIDI bank number
MIDI Program	track MIDI Program number
MIDI Status	enable or defeat MIDI function
Pressure	type of pressure responded to (MIDI only)
SustainPedal	enables or disables the sustain pedal

Mix Bank

Volume	overall track volume adjust
Pan	stereo panning control for track sound
Output	controls routing of track to effects
Timbre	programmable sound variation control
Release	sound release time adjust

Holding down the *Bank Select* button displays the name of the current bank while the button is held, returning to the previous display once the button has been released. If the *Up* or *Down Arrow* buttons are pressed while the *Bank Select* is held, the previous or next bank within that mode will be displayed and selected (the *Effect* button still selects the Effect bank, however).

These parameters can be used to create complex performance set-ups for your SQ-R and other MIDI equipment. A full discussion of the performance/track parameters and their functions appears later in this section.

Unless otherwise noted in the detailed descriptions which follow, use the *Up/Down* buttons to adjust the value of the parameter.

Performance Parameter Banks (Parameter and Mix)

In order to edit any of the performance parameters described below, you must first press the *Edit Track* button. The LED above that button will light, indicating that the SQ-R is in Preset Edit mode.

Parameter Bank

The parameter bank is used to define performance controls within each track of a preset.

Transpose
Parameter Bank

The top line of the display indicates the track which is being edited and the play status of the track. This line is the same on each screen within the bank.

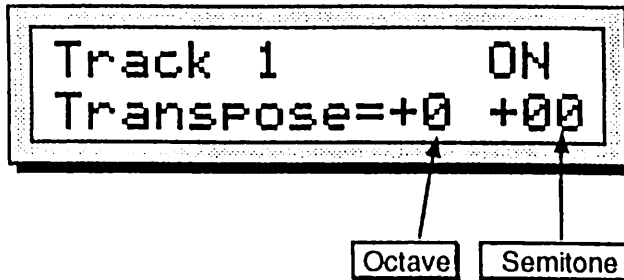

Transpose

Each track can have its pitch transposed (raised or lowered) by octaves and semitones within an eight octave range. The transpose setting affects both the pitch played by local SQ-R voices and the key number transmitted via MIDI.

Ranges: Octave parameter -4 to +4 octaves
 Semitone parameter -11 to +11 semitones

Warning: You should take care never to transpose a track whose status is MIDI or BOTH while that track is receiving incoming MIDI data. This could cause the key-up events to be missed, causing notes to "hang."

KeyRange
Parameter Bank

```

Track 1      ON
KeyRange=C2  C8

```

Key Range

Each track has its own independent Key Range within which the track will play. Key Ranges can be used to create simple two-sound splits, or to create more complex keyboard layouts. Key Ranges control which keys will be sent out via MIDI (with Retransmit = ON in the System Bank) as well as which notes received from MIDI In will trigger local voices on the SQ-R.

You can divide the keyboard into as many as eight different key ranges by using the eight preset tracks. In addition, you can set the Key Range so that each range overlaps the next, producing "layered" ranges in which you would hear the sounds from more than one track.

Range: A0..C8

The illustration below shows an example of three tracks with overlapping key ranges. The Piano is layered with, and partially overlaps, the Cellos on the lower end and the Flute on the upper end.

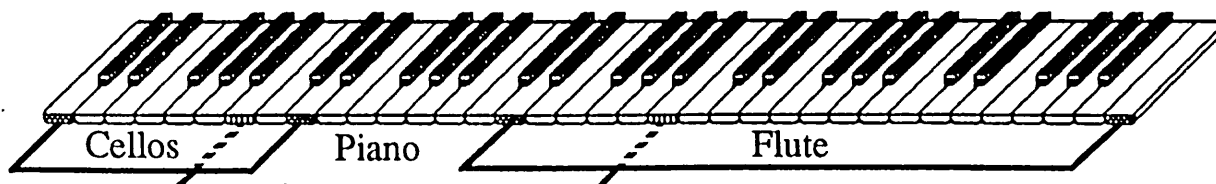

In order to set a Key Range from the keyboard of the controller, make sure the EditKeyrange parameter is ON (see *Section 2 — System Control* for more details), then:

- Play the key on the keyboard that you want to be the *lowest* key of the range. The flashing will automatically move to the right for the High Key of the range.
- Play the key for the *highest* key of the range. The new values for the range will be displayed and the flashing will stop.
- If you wish to change the range, simply reselect this parameter and repeat the process.

Warning:

If the Key Range parameter is accidentally set to where the High Key is *below* the Low Key, then the track will not play. To correct this situation, re-select the Key Range parameter and reset the key range values.

MIDI Channel
Parameter Bank

MIDI Channel

Use this screen to determine which MIDI channel a Track will use to transmit (when Retransmit = ON in the System Bank) and receive data. The difference in how this parameter controls the track for transmitting and receiving is important to understand and is described below.

Transmit Controls which channel the selected track of a preset will *send* data on. MIDI data will be transmitted *only* if the selected track has a MIDI Status of BOTH or MIDI and the Retransmit parameter found in the System bank is set to ON.

Receive Controls which channel an individual preset track will *receive* data on if MIDI Mode=MULTI or MONO B is selected in the MIDI bank. In POLY or MONO A modes the SQ-R will receive only on the base MIDI channel no matter which track, sound or preset is selected.

Range: MIDI channels 1 through 16

MIDI Bank
Parameter Bank

This parameter determines the MIDI bank number that will be sent via MIDI when the track is selected. The SQ-R transmits and responds to this new MIDI controller (transmitted as controller numbers 00 and 32, operating in tandem). MIDI bank allows instruments that have more than 128 sounds (which is the number of program changes provided for in the MIDI specification) to transmit and receive "MIDI Bank" numbers that tell an instrument to switch sound groups. This provides for 8,192 distinct sound locations. On the SQ-R, this will provide a standardized way for switching between INTERNAL, ROM, CARD A and CARD B sound groups. If the track MIDI status is set to LOCAL, the track will not send bank changes.

Range: MIDI banks 00 through 63

Important: Bank Numbers are transmitted and received *only* if the Controllers=ON in the System bank.

MIDI Program
Parameter Bank

MIDI Program Number

This screen lets you choose which MIDI Program Change number will be sent via MIDI when the track is selected. If the track MIDI status is set to LOCAL, the track will not send program changes.

The number which appears is usually the number of the internal SQ-R sound assigned to the track. This number is automatically set whenever a sound is selected from the Sound Select mode with the track status set to BOTH or MIDI. Assigning a new sound to a Preset track by replacing the sound (as described earlier in this section) does *not* change the program number automatically. This allows the internal program number to be different from the MIDI program number, which is useful when layering a SQ-R with a MIDI program when using the Retransmit function.

You can set this number to any other legal program number if you wish to override the default value. This can be useful in presets, which will transmit a program change for every MIDI-enabled track when the preset is selected.

Range: 001 through 128 (MIDI program numbers 0 to 127)

Program Changes in the SQ-R

All sound banks are assigned program numbers 001-079, with "smart" MIDI Out sending a bank change whenever the program bank (INT, ROM, CARD A, or CARD B) is changed.

- Internal RAM sounds (INT banks) are numbered from 001 to 079.
- Card programs (CARD A or CARD B banks) are numbered from 001 to 079.
- Internal ROM programs (ROM banks) are also numbered from 001 to 079.
- The Drum Kit sounds send their program numbers 080 to 099 when selected.

Receiving Program Changes

The way the SQ-R receives program changes is slightly more complex than some other systems because the number of sounds that are available to be selected from MIDI is *larger* than the number of program change messages available within the MIDI standard. To solve this problem, the SQ-R uses the last four program change numbers (125 to 128) to control how subsequent program changes will be interpreted. The following chart shows the effect of these four special program changes:

<i>After Program Change:</i>	<i>Subsequent program changes will select:</i>
125	000..079 - INT Sounds
126	000..079 - ROM Sounds
127	000..079 - CARD A Sounds
128	000..079 - CARD B Sounds

These special "control" program changes need to be sent only once. All subsequent program changes will be handled according to the range that was set by the last one received. When the SQ-R receives one of these bank select program changes, the SQ-R is placed in Sound Select mode.

Note: Program Changes 080-099 *will always* select the default Drum kits.

Selecting a New Preset Effect from MIDI (Program Change 124)

There is another special program change, recognized only in MULTI mode which is used to select *both* a sound *and* its effect for one of the eight preset tracks. When program change 124 is received on a channel assigned to a preset track, the

next program change received on that track will select a new sound and also install the effect from that sound into the preset effect. This is the only way to change the preset effect other than manually editing the settings or selecting a new preset. This can be useful when controlling the SQ-R from an external sequencer.

This special program change 124 does not change the way in which other program changes are received, including the other special messages. If the sound you wish to select also requires a special control program change, then send the control message immediately after the 124 followed by the program number you want to select.

Remember: All SQ-R program changes are referred to and displayed as 001 to 128, but the actual codes transmitted and received over MIDI are the number minus one (000 to 127)

Selecting a New Preset with Program Changes

When the SQ-R is in Preset Select mode (with the Select Preset LED lit) and the Preset Prog switch is ON (in the System bank), program changes received on the base channel (in OMNI, POLY and MULTI modes) or the global controller channel (in MONO A and MONO B modes) will select a new preset.

MIDI Status
Parameter Bank

```

Track 1      ON
Status = BOTH
  
```

MIDI Status

This screen determines the MIDI Status of a track. The four possible settings are:

- **BOTH** Incoming notes, controllers, etc., will play locally *and* will be retransmitted via MIDI over the selected MIDI channel when Retransmit=ON. Incoming MIDI will play internal voices.
- **LOCAL** The track will only play internal voices, and will not send any data out MIDI, even with Retransmit on. Incoming MIDI will play internal voices.
- **MIDI** Notes, controllers, etc., will be sent out via MIDI when the track receives incoming MIDI information and the Retransmit parameter is set to ON. However, MIDI data coming in on the track will not play any SQ-R voices at all. This is comparable to Local Off on some systems. Use this status when you want to create MIDI-only tracks for playing remote MIDI devices. When MIDI status has been selected for a track, instead of showing the program name, the display will show *MIDI-CHAN-#, indicating its status and what MIDI channel it is sending on (assuming the MIDI-TRK-NAMES switch in the MIDI bank is OFF; see *Section 2 — System Control*).

- **OFF** Incoming MIDI data will not play internal voices nor retransmit to the SQ-R's MIDI Out jack. This is useful for turning off certain tracks when using the SQ-R as a multi-timbral receiver in MULTI Mode, thereby limiting the number of channels to which the SQ-R will respond.

The chart below details the behavior of sequencer tracks for each status:

Track Status =	BOTH	LOCAL	MIDI	OFF
Incoming MIDI plays local voices	Yes	Yes	No	No
Incoming MIDI retransmits out MIDI	Yes	No	Yes	No

Pressure
Parameter Bank

Pressure

The Pressure screen enables you to assign one of three pressure modes to each Track. This parameter controls which pressure mode a track will respond to via MIDI. Pressure will be retransmitted according to the pressure mode (see the retransmit function later in this section).

- **NONE** — Pressure information will not be received from MIDI or retransmitted.
- **KEY** — This setting enables the track to receive the most expressive kind of pressure — Polyphonic Aftertouch. Polyphonic Aftertouch lets you add pressure modulation to each note independently. If you press down on any particular key within a chord, only that note will be affected by pressure — all others remain unaffected. This innovative and highly expressive type of pressure is found on many of ENSONIQ's keyboards, including the EPS, and VFX^{SD}. Only Key pressure will be retransmitted. If channel pressure is received it will be ignored.
- **CHANNEL** — This enables the track to receive via MIDI the most common type of pressure — channel pressure. With channel pressure, after a note is played, pressing down harder on a key modulates *every* note currently playing. Like a mod wheel, channel pressure is "global," it affects the entire keyboard when activated. Only Channel pressure will be retransmitted. If Key pressure is received it will be converted to Channel pressure before being retransmitted.

You should consult the MIDI implementation chart of the MIDI device you will be using in conjunction with the SQ-R to see which (if any) type of pressure it responds to and transmits. For best results, set the SQ-R Pressure parameter to match the type of pressure supported by the external MIDI device which will send to or receive from the track you are setting.

SustainPedal
Parameter Bank

Sustain Pedal

The Sustain parameter allows you to determine whether each of the individual tracks will respond to sustain controller events. The effect of all sustain commands received from MIDI is controlled by this switch. There are two settings for this switch:

- **ON** sustain events will affect all notes played within the active key range for this track. Sustain events will be retransmitted if the Retransmit parameter is ON.
- **OFF** sustain events will have no effect on the notes played on this track. Sustain events will not be retransmitted, even with the Retransmit parameter set to ON.

For example, it may be useful to turn off sustain events on a track set up as a bass sound in a split keyboard configuration. This allows you to play staccato bass lines on the lower part of the keyboard while playing chords on the upper part of the keyboard and using the sustain pedal. The bass notes will not be affected by the sustain pedal because the track is set to OFF, but the chords will sustain.

Mix Bank

The Mix bank is used to control the output aspects of the sounds in presets and sequences. Parameters found in the Mix bank include volume, panning, output, timbre, etc.

To enter the Mix bank from the Parameter bank, hold down the *Bank Select* button. The screen displays the name of the current bank, which should be PARAM. While the button is held, press the *Up Arrow* button.

Volume
Mix Bank

Volume

The Volume screen enables you to make volume changes to the individual tracks, allowing you to balance the SQ-R sounds and/or control the volume of external MIDI devices.

Range: 0 to 99

All tracks whose MIDI Status is set to MIDI or BOTH will send a MIDI Volume Change message (controller #7) with the indicated value whenever this parameter is edited. Preset tracks will also send the current volume for each track when a preset is selected.

Pan
Mix Bank

Track 1	ON
Pan =	SOUND

Pan

The Pan screen gives you control over the placement of the track's sound in a stereo field.

When a track is set to SOUND, the voices of a sound are panned according to the settings originally programmed in the Output bank for each voice. Setting this parameter to any other pan value will override the original settings and will force ALL of the voices of the program to be panned to that location.

Range: -98 (hard pan left) to +99 (hard pan right).

A setting of +00 places the sound in the center of the stereo field. The minimum setting is SOUND which indicates that the individual voice's pan settings will be used.

Output
Mix Bank

Output

Normally, different voices in a sound are assigned to the three different busses, as set in the Output bank. On this screen you can override the normal effects routing of the program for each track. This may be useful when two sounds are split or layered in a performance preset, and the effect is not appropriate for both.

The available settings are:

- DRY forces all voices to the dry bus
- FX1 forces FX2 voices to FX1; FX1 and DRY are unaffected
- FX2 forces FX1 voices to FX2; FX2 and DRY are unaffected
- VOICE uses normal voice routing
- CONTROL uses normal voice routing and also routes controller information to the effect. This is the default setting in the track after copying a sound to a track.

Timbre
Mix Bank

Timbre

The Timbre parameter provides an easy way to make useful changes to the character of a sound without getting into more complex programming. This performance parameter uses the *Up/Down Arrow* buttons to control various aspects of the sound, depending on what the programmer has decided would be useful.

As one of the voice modulation sources, TIMBRE can be assigned to anything that can be modulated in a program or effect. The Timbre control can be connected to parameters such as filter cutoff, waveform modulation, LFO depth, and others. It is a good idea to experiment with the Timbre setting to hear what it has been programmed to do in each program.

Range: 00 to 99

All tracks whose MIDI Status is set to MIDI or BOTH will transmit a MIDI Continuous Controller message (controller #71) with the indicated value whenever this parameter is edited.

Release
Mix Bank

Release

The Release parameter enables you to increase or decrease the release time of the program on a selected track. (Release time is the time it takes for the sound to fade away when the key is released.) This is useful when you need to adjust the release characteristics of a sound for a particular application without getting more deeply into programming.

Range: -64 to +64

Higher values lengthen release time.

Lower values shorten release time.

All tracks whose MIDI Status is set to MIDI or BOTH will transmit a MIDI Continuous Controller message (controller #72) with the indicated value whenever this parameter is edited.

The Smart Transmit Function — The SQ-R's Controller Capabilities

The SQ-R's Smart Transmit Function is a unique and powerful feature which allows the SQ-R to add new MIDI master controller features to any keyboard hooked up to it. Connect your favorite keyboard and it becomes an 8 zone controller with independent control over volume, transpose, key range, MIDI channel, program change remapping, and sustain pedal on/off. The major advantage of the Smart Transmit function is that it gives you the power and flexibility of a controller keyboard, even if your MIDI keyboard lacks these multi-channel abilities.

Let's take a look at how to implement and utilize the Smart Transmit function. First, we'll need to determine which SQ-R sounds and external MIDI devices should play across specific areas of the keyboard. For example:

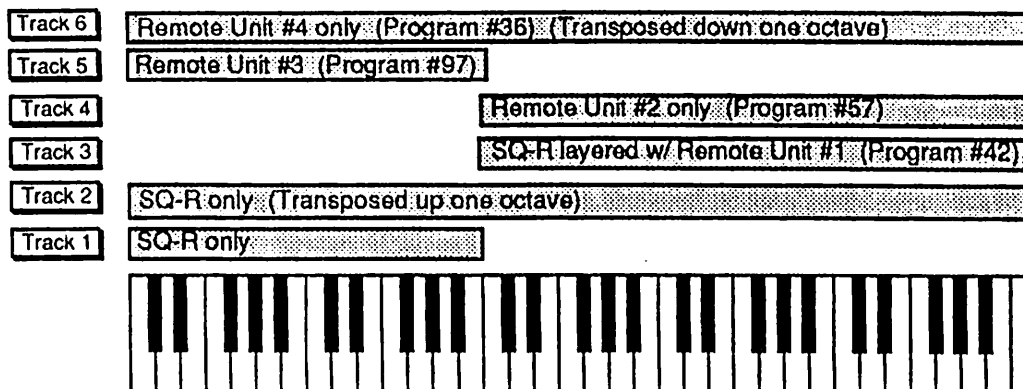

The next step is to make MIDI connections between all the modules and set their System controls to receive MIDI. The diagram below illustrates the connections and MIDI settings:

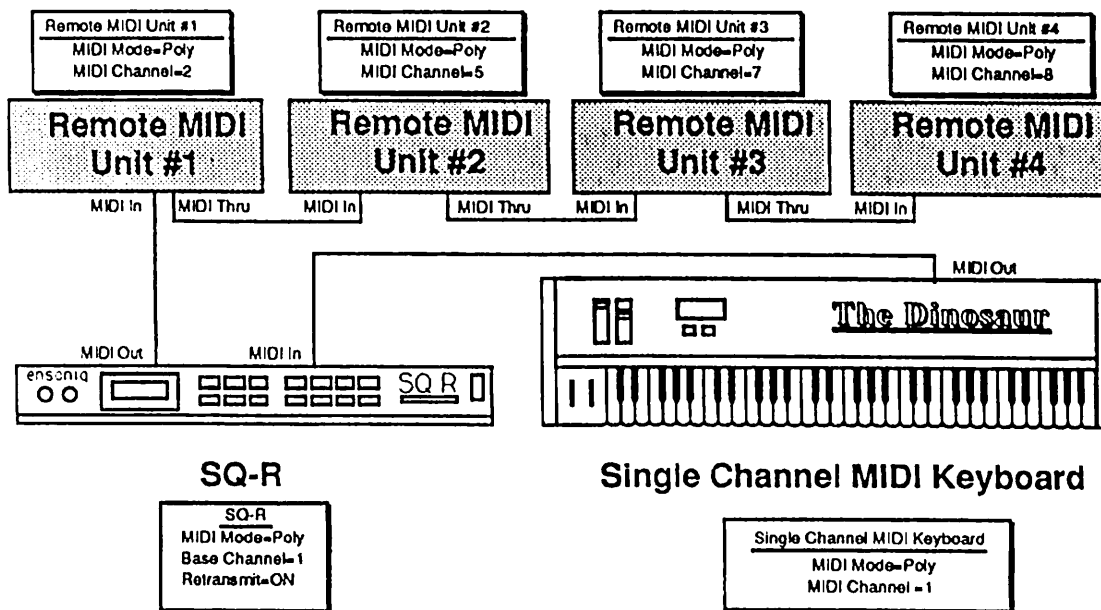

With the MIDI connection made and the parameters set properly, the final step is to select the proper settings in the PARAM bank.

The chart below shows the settings that would be used to create the multi-timbral split/layer combination in this example. Refer to the descriptions earlier in this section for detailed information on each of the parameters.

Track	1	2	3	4	5	6	7	8
Goal	Play SQ-R Sound	Play SQ-R Sound	SQ-R+ MIDI Ch. 2	Play MIDI Channel 5	Play MIDI Channel 7	Play MIDI Channel 8	OFF	OFF
Transpose	+0 +00	+1 +00	+0 +00	+0 +00	+0 +00	-1 +00	N/A	N/A
Key Range	C2-B3	C2-C7	C4-C7	C4-C7	C2-B3	C2-C7	N/A	N/A
MIDI Channel	N/A	N/A	2	5	7	8	N/A	N/A
MIDI Program	N/A	N/A	042	057	097	036	N/A	N/A
MIDI Status	LOCAL	LOCAL	BOTH	MIDI	MIDI	MIDI	OFF	OFF

Remember: You must have the Retransmit parameter in the System bank set to ON in order for Smart Transmit to work. Also remember to have the cables to any external MIDI devices connected to the SQ-R's MIDI Out, *not* the MIDI Thru jack.

After setting up these parameters, save the preset, giving it a name that describes the set-up. Once this is done, whenever you select the preset, either from the front panel or via a program change, each track with MIDI or BOTH status will send the appropriate program changes, volumes, etc. to the receiving instruments on its MIDI channel (tracks with LOCAL status will set up with correct parameters as well).

Pressure

The SQ-R's Smart Transmit function also allows you to retransmit (and in some cases alter) the type of pressure a track receives, using the Pressure parameter. The chart below shows the relationship between type of pressure received, track pressure type (Pressure parameter setting), and the type retransmitted:

When the SQ-R receives:	with Pressure set to:	The SQ-R will Retransmit:
Channel	None	No Pressure
Channel	Channel	Channel Pressure
Channel	Key	No Pressure
Key	None	No Pressure
Key	Channel	Channel Pressure
Key	Key	Key Pressure

MULTI Mode — Receiving on up to eight MIDI channels

Most of the previous discussion of presets has involved using the SQ-R in OMNI or POLY mode, in which they act as performance setups for creating complex splits and layers while sending to the SQ-R on a single MIDI channel.

However, when you select MIDI Mode=MULTI in the System Bank, the eight tracks of the current preset become like eight "virtual synthesizers," each receiving on its own MIDI Channel, but sharing the same 21 voices and the same effects set-up. To set the SQ-R for multi-timbral reception:

- Press *System*, then scroll right to MIDI Mode. Set to MIDI Mode=MULTI. The eight preset tracks will now each receive on its own MIDI channel, which you can select independently for each track.
- Press *Select Preset*. The eight Track Status indicators in the upper right of the display now indicate which tracks are enabled to receive and which are not. For example:

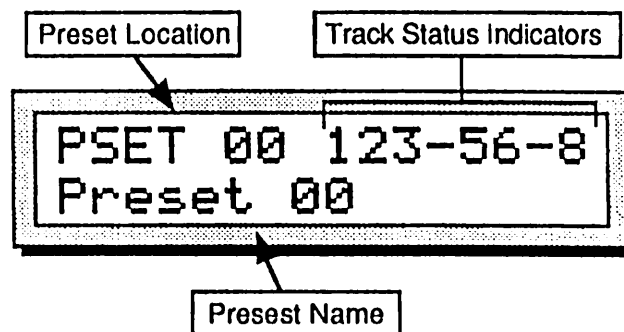

Any tracks which are On (indicated by the track number showing) are enabled to receive MIDI data. Tracks which are Off (indicated by a dash instead of a number) will not receive. In the above illustration, Tracks 1,2,3,5,6 and 8 are On and will receive on their own MIDI Channels; tracks 4 and 7 are Off, and will not receive any MIDI data.

By leaving some tracks on and turning others off you can determine how many MIDI channels (up to eight) the SQ-R will respond to. This allows you to use presets to create custom setups for different multi-timbral applications.

- By pressing *Edit Track* and scrolling to the MIDI Channel parameter, you can now select the Track MIDI Channel parameter, discussed earlier in this section, and assign the desired MIDI Channel to each track that is enabled.
- In a default SQ-R Preset the eight tracks are set to MIDI Channels 1-8 respectively, but these assignments are completely programmable, and can be changed to any channels you wish.

A Few Important Points About Multi Mode

- When the SQ-R is in MULTI mode, the sound you hear will always be the sound on the track whose MIDI channel is being received, even if you have a different track displayed.
- Only one track can receive on a given MIDI Channel. If two (or more) tracks are set to the same MIDI Channel, the lower-numbered track will receive on that channel and any higher-numbered track(s) set to the same channel will not receive at all.
- Each of the eight Preset tracks is completely independent and polyphonic. The SQ-R's *Dynamic Voice Assignment* means each track can have up to all 21 voices if it needs them. If all 21 voices are in use and a track needs a voice, it will "steal" the voice from the oldest note (or the one with the lowest voice priority).
- The eight tracks respond independently to MIDI program changes, allowing you to assign a new sound to a track via MIDI. The selected program's effect does not come with it — all of the eight tracks in the Preset share the same effects setup, which can normally be changed only by editing the effect from within Preset or by using the Copy Effect function from Sound Select mode.
- You can, however, cause a sound's effects set-up to become the Preset effect (which will then be applied to all eight tracks) by sending program change # 124 immediately before the program change which selects the new sound for the track (see "Receiving Program Changes" earlier in this section).
- In MULTI mode, if the Preset Prog parameter in the System bank is set to On, incoming program changes on the SQ-R's base MIDI channel will select new presets. Any individual track set to the same MIDI channel will *not* respond to program changes. Therefore:
 - > If you wish to change Presets via MIDI while in MULTI mode, you should set the base channel to one not used by any of the tracks.
 - > If you don't wish to change presets while in MULTI mode (as is often the case) simply set the Preset Prog parameter in the System Bank to Off.

Section 4 — Effects

Understanding SQ-R Effects	4 - 1
Sound Effects	4 - 2
Preset Effect	4 - 2
Programming Effects	4 - 3
The Effect Busses	4 - 3
Effect Mixing	4 - 4
Selecting Effects	4 - 5
Sounds and Presets	4 - 5
When are new effects loaded into the ESP chip?	4 - 5
Performance Control of Effects in Preset mode	4 - 6
Controllers Routed to Effects	4 - 6
Effect Modulators	4 - 7
Effect Parameters	4 - 10
Single Effects:	
Concert Reverb	4 - 10
Hall Reverb	4 - 10
Room Reverb	4 - 10
Warm Chamber	4 - 10
8-Voice Chorus	4 - 12
Phase Shifter	4 - 12
Combined Effects:	
Chorus & Reverb	4 - 14
Flanger + Reverb 1 & 2	4 - 15
Phaser + Reverb	4 - 16
Rotary Speaker + Reverb	4 - 17
Distortion + Chorus + Reverb	4 - 18
Compression + Distortion + Reverb	4 - 19

Understanding SQ-R Effects

The SQ-R has a powerful built in signal processor which can produce a variety of effects. More importantly, its functions are integrated into, rather than added onto, the rest of the synthesizer. The flexible bus routing scheme and the extensive real-time control give the SQ-R its *dynamic* effects capability.

The SQ-R is equipped with an advanced digital signal processing system based on the ENSONIQ Signal Processor (ESP) chip. The ESP is designed specifically for digital audio signal processing and in the SQ-R it has been integrated with a third generation version of the Digital Oscillator Chip (DOC III) and an external 16-bit digital-to-analog converter to provide a very high-quality output signal.

The digital effects processing has been designed to complement the advanced programming features of the SQ-R, and many of the effects can have specific parameters modulated by various performance controls such as the mod wheel.

The effects are fully programmable, and may be customized for particular applications. Effects are most often stored as part of a sound, although each preset has its own independent effect. Each effect is treated a little differently, and will be described individually later in this section.

Sound Effects

Each sound in the SQ-R contains an effect and a complete set of parameter values which determine how that effect will sound. The effect is present even if none of the voices in the sound are routed through the effect (e.g. all voices are sent to the DRY destination bus - see the Output bank in section 6). Whenever you save or write a sound, the effect settings are also saved with the sound.

The sound effect is displayed and edited by pressing the *Effect* button while in Sound Edit mode. The parameters that pertain to each effect are described in the Effect Parameters part of this section.

Preset Effect

Each preset contains an effect and a complete set of effect parameter values. The effect is present even if none of the tracks in the preset are routed through the effect (e.g. all tracks are sent to the DRY destination bus). This effect applies to all preset tracks (or their sound voices) which are routed to either FX destination bus.

The effect is saved with each preset. It will remain unaffected until a new preset is selected, unless it is specifically edited. A special program change message may be used to load new effects into a preset from MIDI in MULTI mode (see the description of special program changes in the *Section 2 — System Control*).

The preset effect is displayed and edited by pressing the *Effect* button when the SQ-R is in Preset mode.

Programming Effects

The SQ-R effects are highly programmable. There are several effect parameters for every effect type. The first screen contains the effect selector. The effect selector is a little different than all of the other parameters in that it controls how all of the other effect screens will be configured and displayed. When this parameter is changed, a new effect is selected which causes several important things to occur.

When a new effect is selected:

- a new effect is loaded, causing a brief pause in the audio output,
- the effect parameter screens are redefined for the particular effect selected, and
- the effect parameter values are reset to their default settings for the effect.

Hint: When editing the effect selector, it is possible to change the new effect type quickly and avoid the brief delay caused by the actions described above. Pass rapidly over the types between the old type and the new type, and then pause. The new effect will be recalled only after you stop changing the type.

The Effects Busses

The output of every voice in the SQ-R is assigned to a stereo bus. A bus, like the bus of a mixing board, mixes together all the voices assigned to that bus into a single stereo pair. Of the three busses on the SQ-R, two are inputs into the signal processor (FX1 and FX2), and the third is a direct path to the Main outputs which bypasses all effect processing (DRY). The Destination Bus assignment for each voice is set in the Output bank. The voice settings in the sound can be overridden for each preset track in the Parameters bank.

Single function effect

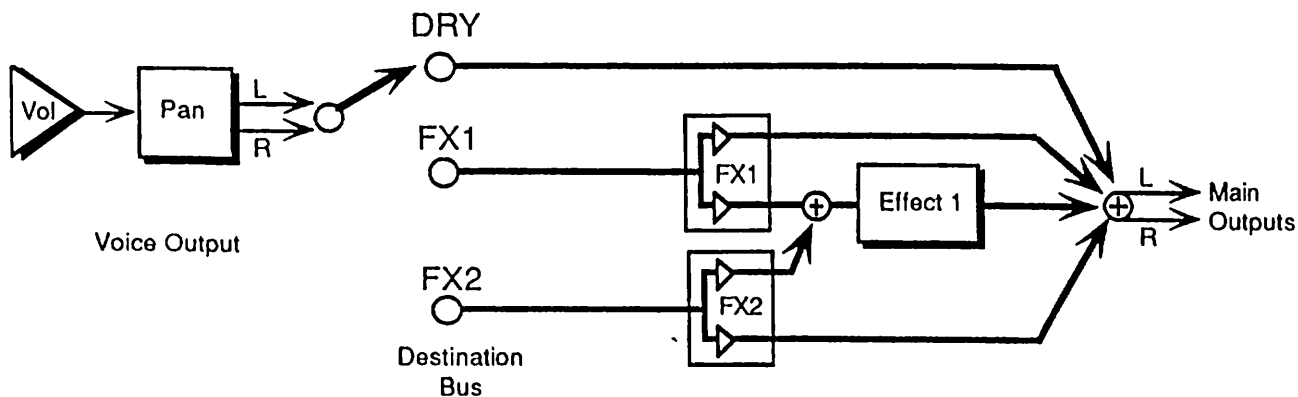

The above illustration shows the effects busses and the output mixing. Every voice is assigned to one of the three stereo busses, which go around or through the effects processing.

Effects Mixing

All effects have separate mixing controls for the FX1 and FX2 busses. They are found on the bottom line of the Effect Selector screen, which is the first screen of the Effect bank. The screen looks like this:

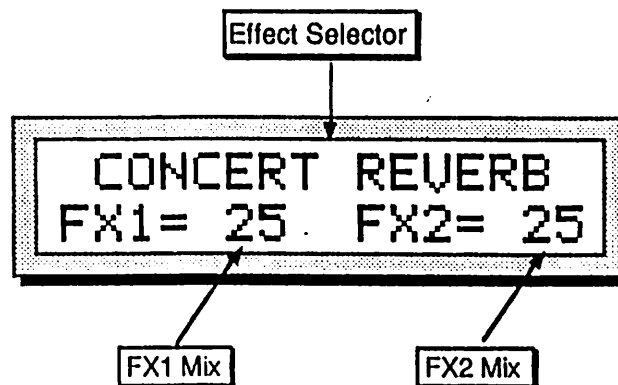

When an effect with a single processing function (such as reverb only) is selected, both busses FX1 and FX2 are routed to it. When using a dual or multi-effect, FX1 will generally route the signal through both or all effects, with FX2 routing only through the second effect.

Multiple function effect

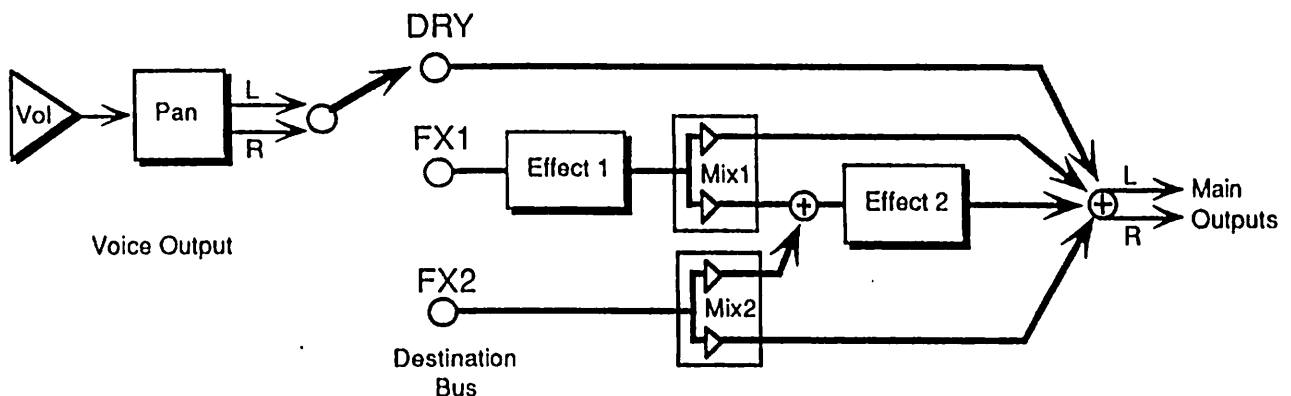

When the selected effect is a *combined effect* that has more than one signal processing function (such as chorus and reverb), the FX1 bus feeds Effect 1, and the FX2 bus feeds Effect 2. The FX2 Mix control sets the amount of Effect 2 (usually reverb) for voices assigned to that bus. FX1 Mix controls the amount of the output from Effect 1 sent to Effect 2 rather than directly to the output. By setting this control to its extremes, you can arrange the two effects to be either in series or in parallel. (For some multiple effects, there is also a separate Dry/Wet mix at the output of Effect 1.)

Selecting Effects

The first parameter of the Effects bank is the effects selector. Changing this parameter causes a new effect to be selected, which in turn changes the type of parameters that will be available on the rest of the screens. Selecting a new effect will automatically set all the effect parameters to their default values for the new effect. The available Effects are:

CONCERT REVERB	Concert hall reverb, high density reverberation
HALL REVERB	Hall, left to right (transverse) reflections
ROOM REVERB	Small room emulation
WARM CHAMBER	Chamber reverb with characteristic resonance
8-VOICE CHORUS	Eight voice chorus with complex modulation
CHORUS & REVERB	Four-voice chorus combined with reverb
FLANGER+REVERB.1	Flanger combined with reverb
FLANGER+REVERB.2	(variation with compound modulation)
PHASE SHIFTER	Stereo phase shifter with controllable rate and depth
PHASER+REVERB	Phase shifter combined with reverb
ROTARY SPKR+VERB	Rotating speaker simulator with reverb
DIST+CHORUS+VERB	Chorus with distortion plus reverb
CMPRSS+DIST+VERB	Compression, Distortion, and Reverb. Great for guitar and amp simulation with acoustic feedback.

Sounds and Presets

The complete effects setup, including the values of all effect parameters, is saved when you save a sound. It is *also* saved with each preset. The SQ-R tries to be smart about switching effects, since all sound must stop for an instant when it changes effects.

When are new effects loaded into the ESP chip?

- When you select a sound from Sound Select mode, the effect saved in that sound will be loaded into the ESP, and you will hear the sound with its effect.
- When you select a preset, the effect saved in that preset will be loaded into the ESP.
- When you select or layer sounds/tracks from a preset, the effect is *not* changed.
- When you change the sound on a track the effect will *not* be changed.

Whenever a new effect is loaded into the ESP, the audio output will pause briefly, allowing the instructions that create the new effect to be loaded into the ESP. If an effect differs only by variation in parameter values, then this pause may not occur.

These are the rules that the SQ-R follows in deciding when to change effects:

1. When you select a new sound it changes to that sound's effect.
2. When you select a new preset, it changes to that preset's effect.
3. Whenever you go from Sound mode to Preset mode (by pressing *Select Preset*) the preset effect is loaded. The same is true when going from Preset mode to Sounds mode (by pressing *Select Sound*).
4. When you choose a sound for a preset track it will not change the effect.
5. Saving either the sound or the preset will save the *current* effect.
6. When a special MIDI program change message (#124) is received in MULTI mode, the next program change received will cause the preset effect to be loaded with the one in the sound.

Performance Control of Effects in Preset mode

When the SQ-R is in Preset mode, the effect for the current preset is edited by pressing the *Effect* button.

The *Effect* button calls up the Effect bank. Repeated presses of the *Effect* button scrolls through individual Effect parameter screens. You can then use the *Left/Right Arrow* buttons to select the various parameters within the bank.

Normally, different voices in a preset are assigned to the three different busses, as set in the PARAMeter bank during Track Edit mode.

The available settings are:

- DRY forces all voices to the dry bus
- FX1 forces FX2 voices to FX1; FX1 and DRY are unaffected
- FX2 forces FX1 voices to FX2; FX2 and DRY are unaffected
- VOICE uses normal voice routing
- CNTRL uses normal voice routing and routes controller information to the effect. This is the default setting in the track after selecting a sound in Select Sound mode.

See Section 3 — *Presets* for more information.

Controllers Routed to Effects

In effects that allow real-time control, it is sometimes desirable to limit *which tracks* send controller information to the effect. This is particularly true when using multiple MIDI input channels from a sequencer. If more than one track is set to CNTRL, "controller fights" can occur. If set to VOICE, a track will remain routed to the effects, but its controllers (such as the TIMBRE control, MODWHEEL, etc.) will not affect the effect.

Effect Modulators

All the effects allow real time control of particular parameters and, with the exception of the Rotary Speaker simulator, share a common modulation control screen. (Modulation of the Rotary Speaker simulator will be covered in detail in the discussion of that effect.)

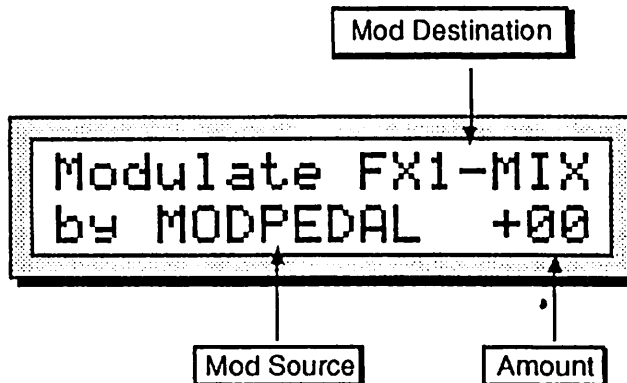

The exact location of this screen varies depending on the selected effect, but it is always the last screen in the Effect bank for the selected effect. The screen has three parameters:

- **Mod Destination** — This selects which effect parameter will be modulated. The list of options varies depending on the selected effect, with most parameters within a given effect being available for modulation.
- **Mod Source** — This selects the source for modulating the Mod Destination.
- **Mod Amount** — This sets the amount the Mod Destination will be modulated by the Mod Source.

The following modulation sources are available to alter the effects in performance:

<u>Mod Source</u>	<u>Modulation effect derived from</u>
KEYBOARD	the number of the last key played
VELOCITY	the average velocity of all keys played
PRESSURE	the channel or key pressure value for track
PITCHWHL	the value of the pitch wheel
MODWHEEL	the value of the mod wheel
MODPEDAL	the value of the CV/Pedal input
XCONTROL	uses the value of the assignable external MIDI controller, such as the breath controller
SUS-PEDAL	on when held down; otherwise off
TIMBRE	the value of the TIMBRE parameter for the track, if the track is set to CONTROL
*RAMPS 1-6	six separate envelope-type structures
OFF	no modulation

Ramps

Six of the available mod sources are called *ramps*. Ramps are envelope-type structures that modulate the mod destination to the level specified in the mod amount parameter over a period of time. There is also a release time in each ramp which occurs after the key is released. The illustrations below show the available ramps:

Ramp 1

Any Key Down

All Keys Up

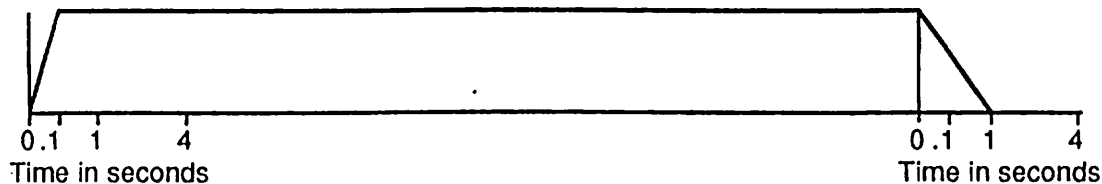
**Ramp 2**

Any Key Down

All Keys Up

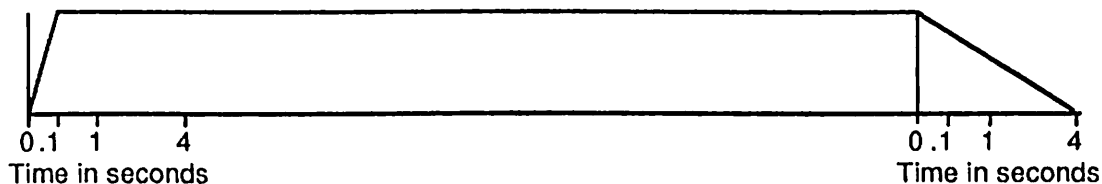
**Ramp 3**

Any Key Down

All Keys Up

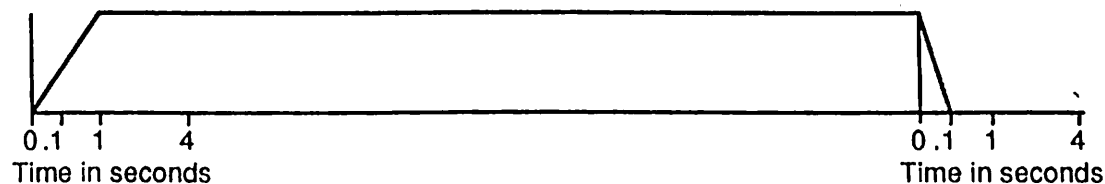
**Ramp 4**

Any Key Down

All Keys Up

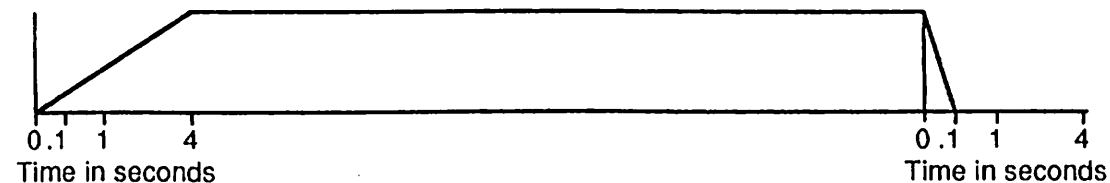
**Ramp 5**

Any Key Down

All Keys Up

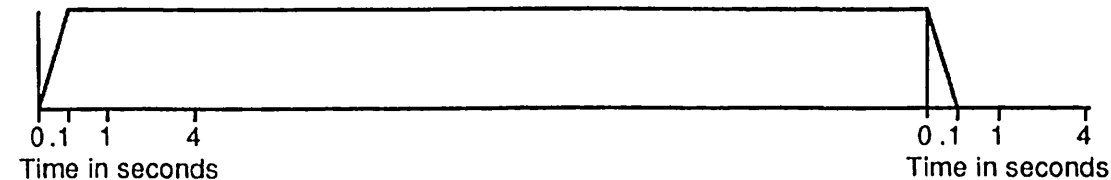

Ramp 6

Any Key Down

All Keys Up

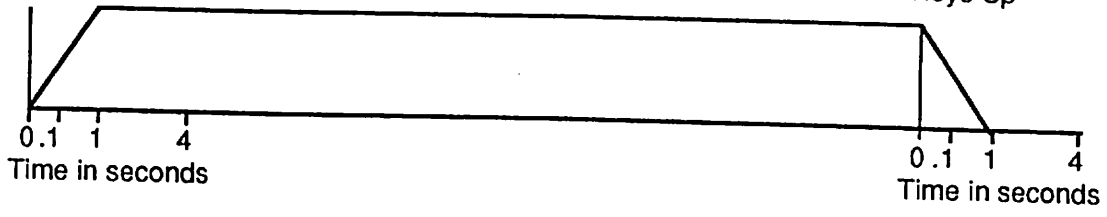

Effect Parameters

Each effect type has multiple screens containing a particular set of parameters associated with the effect. Some of the parameters are common to many effects and some are specific to certain effects. The first screen of parameters is very similar for all of the effects. Subsequent screens are more variable, and contain the specific parameters.

Each effect has an FX1 Mix and an FX2 Mix, plus a set of parameters which is relevant to the effect. All of these parameters are programmable, and provide much flexibility for customizing the effects.

Single Effects

The effects algorithms in this category provide a single highly optimized stereo effect, such as studio quality reverb or complex chorusing. The FX1 and FX2 busses may both be routed into the effect with different mixes

<i>CONCERT REVERB</i>	—	concert hall reverb, good for long decay times
<i>HALL REVERB</i>	—	hall with transverse reflections
<i>ROOM REVERB</i>	—	small room emulation
<i>WARM CHAMBER</i>	—	chamber reverb, having characteristic resonance

The parameters available in these four effects algorithms are:

DECAY TIME
 DIFFUSION
 DETUNE RATE
 DETUNE DEPTH
 HF-DAMPING
 HF-BANDWIDTH
 LOW FREQUENCY DECAY (not available on Warm Chamber)

Decay Time

Controls the amount of time it takes for the reverberation to decay away to a very low level (-60 dB) after the input signal stops.

Range: 0 to 99

Diffusion

This parameter determines whether the early reflections will appear as a series of discrete echoes (lower values) or will be more diffused (higher values).

Range: 0 to 99

Detune Rate

This parameter controls the LFO rate of detuning to be introduced into the reverb. Detuning creates a slight pitch shift into the signal, giving it a more natural sounding decay.

Range: 0 to 99

Detune Depth

This parameter controls the depth of the detuning, that is, how much the pitch will change. Low values yield a metallic sound. Some voices may require very low values.

Range: 0 to 99

HF Damping — High Frequency Damping

The High Frequency Damping parameter controls the amount of attenuation of high frequencies in the decay of the reverberation. As natural reverb decays, some high frequencies tend to get absorbed by the environment. Increasing the value of this parameter will filter out increasing amounts of high frequency energy.

Range: 0 to 99

HF Bandwidth — High Frequency Bandwidth

The High Frequency Bandwidth parameter acts as a Low Pass Filter on the signal going into the reverb, controlling the amount of high frequencies that will pass into the effect. The higher the setting, the more high frequencies are allowed to pass.

Range: 0 to 99

Low Frequency Decay

This control will boost or cut the rate at which low frequencies will decay.

Range: 0 to 99

8-VOICE CHORUS

This is a complex stereo chorus with eight different voices and separately randomized LFOs.

CHORUS RATE
CHORUS DEPTH
CHORUS CENTER
FEEDBACK

Chorus Rate

This parameter controls the eight rates of modulation of the delay time of the chorus. The delay modulation produces vibrato and tremolo.

Range: 0 to 99

Chorus Depth

This parameter controls the amount of delay modulation.

Range: 0 to 99

Chorus Center

This parameter controls the delay eight time centers within the chorus. Adjusting this parameter will change the tonal character of the feedback and the Dry/Wet mix.

Range: 0 to 99

Feedback

This parameter controls the amount of positive or negative feedback applied to the chorus.

Range: -99 to +99

PHASE SHIFTER

A stereo 12 pole phase shifter with controllable depth and rate, modelled after the classic analog "bi-phase" sound.

PHASER RATE
PHASER DEPTH
PHASER CENTER
FEEDBACK
STEREO CROSS FEEDBACK
PHASER LEVEL
INPUT INVERT

Phaser Rate

This parameter controls the rate of modulation of the phaser poles.

Range: 00 to 99

Phaser Depth

This parameter controls the amount of modulation applied to the phaser poles.

Range: 00 to 99

Phaser Center

This parameter controls the pole centers. A value of "50" places the poles half-way between their extremes, yielding maximum effect.

Range: 00 to 99

Feedback

This parameter controls the amount of local positive or negative feedback applied to the left or right channel of the phaser.

Range: -99 to +99

Stereo Cross Feedback

This parameter controls the amount of signal that will be fed from the output of one channel into the input of the other, creating a stereo feedback effect.

Range: -99 to +99

Warning:

Adjust the level of these parameters carefully. Some feedback combinations can cause very loud sinewaves to be produced that can be harmful to your speakers or your ears. Start with a low value and adjust upward *slowly*.

Phaser Level

This parameter controls the depth of the notches produced by the phaser. This parameter should normally be set to 99 for maximum effect.

Range: 00 to 99

Input Invert

This parameter inverts the input signal before combining it with the phase shifted version. It creates peaks instead of notches for a different effect.

Range: ON/OFF

Combined Effects

The other effects in the system generally include a standard reverb on the FX2 bus combined with a different effect on the FX1 bus. You can control the amount of FX1 that is sent into the reverb (FX2) with the FX1 mix control. Decay Time for the reverb appears on the first screen for all of these combined effects.

CHORUS & REVERB

This effect combines a four voice chorus with the standard reverb. Assign a voice to FX1 to get both chorus and reverb, or use FX2 for reverb only.

- DECAY TIME Reverb parameter
- HF-DAMPING Reverb parameter
- CHORUS RATE
- CHORUS DEPTH
- CHORUS CENTER
- FEEDBACK
- CHORUS LEVEL

Decay Time

HF Damping — High Frequency Damping

See the description under Reverbs in the Single effect section.

Chorus Rate

This parameter controls the eight rates of modulation of the delay time of the chorus. The decay modulation produces vibrato and tremolo.

Range: 00 to 99

Chorus Depth

This parameter controls the amount of delay modulation.

Range: 00 to 99

Chorus Center

This parameter controls the delay eight time centers within the chorus. Adjusting this parameter will change the tonal character of the feedback and the Dry/Wet mix.

Range: 00 to 99

Feedback

This parameter controls the amount of feedback applied within the chorus. The sign of the value determines the polarity of the feedback.

Range: -99 to +99

Chorus Level

This parameter controls the Dry/Wet mix of the chorus.

Range: 00 to 99

FLANGER+REVERB 1 & 2

Flanger 1 is similar to the chorus with a single LFO. Flanger 2 features two LFOs at different rates. Assign a voice to FX1 to get both flanger and reverb, or use FX2 for reverb only.

- DECAY TIME Reverb parameter
- HF-DAMPING Reverb parameter
- FLANGE RATE
- FLANGE DEPTH
- FLANGE CENTER
- FEEDBACK
- FLANGE LEVEL
- INPUT INVERT

Decay Time

HF Damping — High Frequency Damping
 See the description under Reverbs in the Single effect section.

Flange Rate

This parameter controls the rate of modulation of the flanger effect.

Range: 00 to 99

Flange Depth

This parameter controls the range of the high to low frequency sweep in the flanger effect.

Range: 00 to 99

Flange Center

This parameter controls the sweep center of the flanger effect.

Range: 00 to 99

Feedback

This parameter controls the amount of feedback applied to the flanger. The sign of the value determines the polarity of the feedback.

Range: -99 to +99

Flange Level

This parameter controls the depth of the notches produced by the flanger. This parameter should be set to 99 for maximum effect.

Range: 00 to 99

Input Invert

This parameter inverts the input signal before combining it with the flanged version. It creates peaks instead of notches in the flanger.

Range: ON/OFF

PHASER+REVERB

A 12 pole phase shifter with reverb. Assign a voice to FX1 to get both phaser and reverb, or use FX2 for reverb only.

DECAY TIME	Reverb parameter
HF-DAMPING	Reverb parameter
PHASER RATE	
PHASER DEPTH	
PHASER CENTER	
FEEDBACK	
PHASER LEVEL	
INPUT INVERT	

Decay Time**HF Damping — High Frequency Damping**

See the description under Reverbs in the Single effect section.

Phaser Rate

This parameter controls the rate of modulation of the phaser poles.

Range: 00 to 99

Phaser Depth

This parameter controls the amount of modulation applied to phaser poles.

Range: 00 to 99

Phaser Center

This parameter controls the pole centers.

Range: 00 to 99

Feedback

This parameter controls the amount of feedback applied to the phaser. The sign of the value determines the polarity of the feedback.

Range: -99 to +99

Phaser Level

This parameter controls the depth of the notches produced by the phaser. This parameter should normally be set to 99.

Range: 00 to 99

Input Invert

This parameter inverts the input signal before combining it with the phase shifted version. It creates a peaks instead of notches for a different effect.

Range: ON/OFF

ROTORY SPKR+VERB

A rotating speaker simulation with reverb. Assign a voice to FX1 to get both rotary speaker and reverb, or use FX2 for reverb only.

DECAY TIME	Reverb parameter
HF-DAMPING	Reverb parameter
SLOW SPEED	
FAST SPEED	
ROTOR CENTER	
ROTOR DEPTH	
SPEEDMODE	Modulation parameter
MODSRC	Modulation parameter

Decay Time

HF Damping — High Frequency Damping

See the description under Reverbs in the Single effect section.

Slow Speed

Determines the rate of the rotary speaker when in the "Slow" setting.

Range: 00 to 99

Fast Speed

Determines the rate of the rotary speaker when in the "Fast" setting.

Range: 00 to 99

Rotor Center

Determines the center point over which the LFO will sweep.

Range: 00 to 99

Rotor Depth

Determines the depth of the LFO.

Range: 00 to 99

SpeedMode

Determines how the rotary speaker will switch between slow and fast speeds.

- CONTIN — (Continuous) In this setting, the modulation source directly controls the rotor speed.
- SWITCH — The modulation source acts as a switch to turn on or off the fast rotor speed. The switch accurately reflects an actual rotary speaker, taking some time to speed up or slow down.
- TOGGLE — Every time the modulation source moves from zero in a positive direction, the speaker effect changes speeds, from slow to fast or fast to slow. This is a useful setting when using the foot switch.

ModSrc — Modulation Source

Determines the modulation source for the rotary speaker effect. The available sources are the same as those listed in the Effect Modulators earlier this section.

DIST+CHORUS+VERB

Chorus with overdrive and reverb. Assign a voice to FX1 to get chorus and reverb with or without distortion (see signal path diagram), or use FX2 for reverb only.

- DECAY TIME Reverb parameter
- DIST LEVEL
- CHORUS RATE
- CHORUS DEPTH
- CHORUS CENTER
- FEEDBACK
- CHORUS LEVEL

DIST+CHORUS+VERB Signal Routing

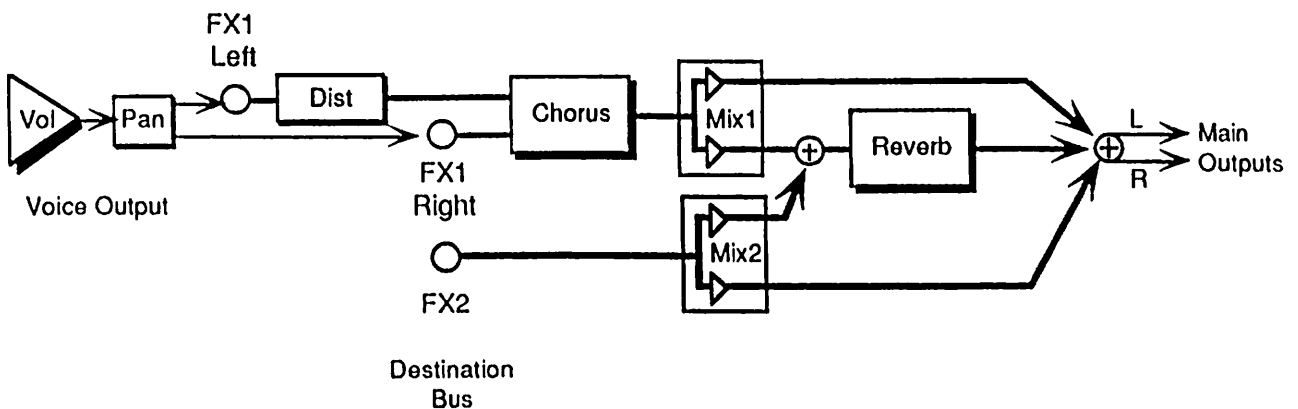

Decay Time

See the description under Reverbs in the Single effect section.

Distortion Level

This parameter controls the *output* of the distortion. The input is controlled by the individual voice volume and panning in the Output bank.

Range: 00 to 99

Chorus Rate

This parameter controls the rate of modulation of the delay time of the chorus.

Range: 00 to 99

Chorus Depth

This parameter controls the amount of modulation applied to the delay time of the chorus.

Range: 00 to 99

Chorus Center

This parameter controls the delay time of the chorus.

Range: 00 to 99

Feedback

This parameter controls the amount of feedback applied to the chorus. The sign of the value determines the polarity of the feedback.

Range: -99 to +99

Chorus Level

This parameter controls the amount of input in relation to the delay signal.

Range: 00 to 99

CMPRSS+DIST+VERB

A screaming guitar+amp simulator that features not only compression, distortion, and reverb, but flanger and a high pass/low pass EQ as well. FX1 routes the signal through each of these effect processors, while FX2 is used for reverb only.

- DECAY TIME Reverb parameter
- HF DAMPING Reverb parameter
- FLANGE RATE
- COMPRESSION
- DISTORTION LEVEL (In and Out)
- REVERB TO CMPRSS FEEDBACK
- HIPASS CUTOFF
- LOPASS CUTOFF

CMPRSS+DIST+VERB Signal Routing

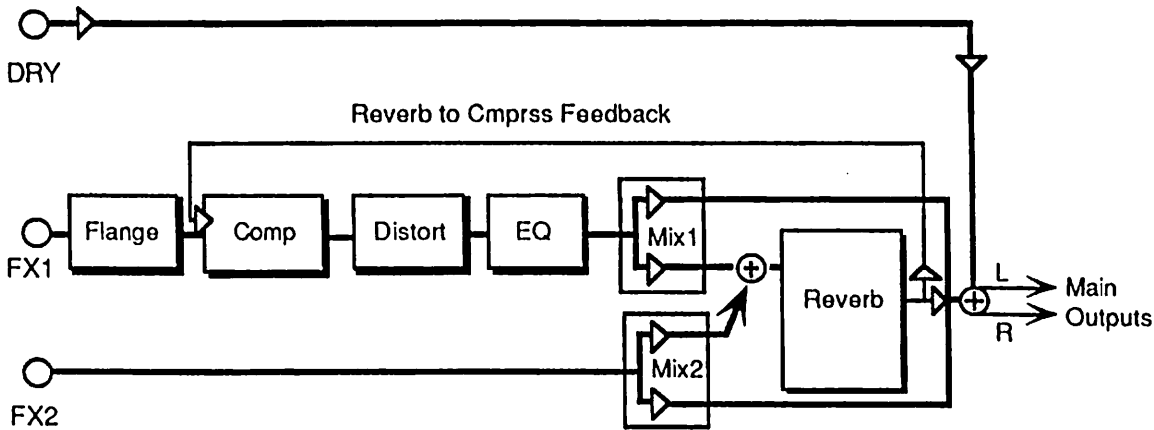

Decay Time

HF Damping — High Frequency Damping

See the description under Reverbs in the Single effect section.

Flange Rate

This parameter controls the rate of modulation of the delay time of the flanger. Set to 00 to eliminate the flanger effect.

Range: 00 to 99

Compression

This parameter controls the threshold level for the compressor. As the input signal dies away, the compressor will increase the gain of the system, causing feedback to increase as well. Normal compression is "72."

Range: 00 to 99

Distortion Level — (In and Out)

These two parameters control the levels going into and coming out of the distortion effect. The range for both parameters is 00 to 11, based on the Tufnel theorem, which states that making 10 louder isn't sufficient, since "these go to 11."

Reverb to Cmprss Feedback

This parameter controls the amount of signal applied from the output of the reverb back into the input of the compressor. The sign of the value determines the polarity of the feedback.

Range: -99 to +99

Note:

Since the feedback level is taken from the FX1 bus, if FX1 is set to 00 or a low value, feedback will have little or no consequence. Also, it is important to note that since the signal is being taken from the reverb, which is also fed by the FX2 bus, voices sent to the FX2 bus will enter the feedback loop along with the FX1 signals.

Hipass cutoff

This parameter filters out low frequencies after the distortion signal path. The higher the value, the less low frequencies pass through.

Range: 00 to 99

Lopass cutoff

This parameter filters out high frequencies after the distortion signal path. The higher the value, the less high frequencies pass through.

Range: 00 to 99

Section 5 — Programming the SQ-R

What is a Sound?	5 - 1
Voices and Polyphony	5 - 1
Compare — Using the Edit Sound Button/LED	5 - 2
Edit Buffer	5 - 2
Abandoning Your Edits	5 - 2
Saving a New Sound into Memory	5 - 3
Copying an Existing Sound to Another Location	5 - 4

What is a Sound?

SQ-R Sounds are divided into two categories; *Standard Sounds*, which are dynamic structures made up of three *voices* and an *effect*, and *Drum Sounds*, which feature 17 voices and an effect. Drum Sounds have slightly different programming features due to having the added voices.

Standard Sounds and Drum Sounds each have their own programming guidelines. See Sections 6 and 7 for details. This section of the manual will cover the "common ground" between the two types of sounds.

Voices and Polyphony

When referring to the number of voices in a SQ-R sound, we are *not* talking about polyphony (as in "you can only play so many notes," see below). We are referring to the number of voices that will sound on each MIDI note received as you play the sound.

The SQ-R has a total of 21 voices which are dynamically assigned among the different sounds that you play. How many voices a sound uses on each MIDI note received depends on the sound. Many sounds use only one voice — in the case of these sounds you can play 21 notes before "voice stealing" occurs. On sounds that use two voices, you can play 10 notes before any voices are stolen. Three voices, seven notes. Up to three voices can be active in one Standard sound.

Drum Sounds are inherently "one voice" sounds and always use only one voice per MIDI note received.

Bear in mind that the SQ-R is "smart" about voice allocation — there are many things that a programmer can do to increase the apparent polyphony of a sound and to minimize the effects of voice stealing. For example:

- As soon as a voice is done playing (either because it reached the end of the wave or because the volume envelope went to zero) that voice becomes free and a new note can use that voice rather than stealing one that is still sustaining. See "Voice Triggering/Stealing Notes," in Section 6.
- Also, you can assign low, medium or high priority to each voice in a sound, which allows you to control how voices are reassigned. See Output Bank in Section 6.

Compare — Using the Edit Sound Button/LED

As soon as you change any parameter in a sound, the LED above the *Edit Sound* button will begin flashing. It will remain flashing until you select another sound or save (write) the newly edited sound into memory. This is a constant reminder that something in the sound has been changed.

To hear the original, unchanged sound, press the *Edit Sound* button. The Edit Sound LED will remain lit without flashing and you will hear the original sound and see the screen with its original settings. Press *Edit Sound* again to return to your edited sound. You can toggle back and forth between the original and the edited sound as often as you like.

Edit Buffer

You can edit a sound, while keeping the original sound intact, because the edited version is kept in a special area of memory called the *Edit Buffer*. Whenever you change any parameter of a sound, the altered sound is put in the edit buffer, replacing whatever was previously there. Only one sound at a time can reside there — the edit buffer always contains the results of your last edit.

When you press the *Edit Sound* button, you are alternating between the sound in the original memory location and the sound in the edit buffer. We refer to the sound in the edit buffer as the *Edit Sound*.

You can return to the edit sound, even after selecting another sound (as long as you don't change any parameters there) by pressing the *Edit Sound* button. This puts you back in the edit buffer, and any changes you make will affect the edit sound.

The rule of thumb is this: Whichever sound you hear, that's what you're editing.

If you like the results of the changes you have made to a sound, you should rename it and save the new sound permanently, to another location. The procedure for this is covered under "Saving a New Sound Into Memory" later in this section.

Abandoning Your Edits

If you decide, while editing a sound, that you're not happy with what you've done, and you want to start over with the original sound:

Press the *Edit Sound* button so the Edit Sound LED remains lit. Then you can start editing the sound again from scratch. You will lose the one you were working on before.

Saving a New Sound Into Memory

After creating a new sound, or editing a current sound to better suit your needs, it must be saved into a memory location in order to be available for future access. New or edited sounds can be saved into any one of the 80 internal sound locations with the following procedure.

- 1) Check to make sure that the Edit Sound LED is flashing. If not, press the *Edit Sound* button. This indicates that the sound you're hearing is in the edit buffer.
- 2) Press the *Enter/Save* button. This tells the SQ-R that you've finished editing and are ready to save the sound to a memory location. The display will read "Save Sound <SOUND NAME>?" The name listed is the name of the sound you began with when editing.
- 3) Select a name of up to 16 characters for your new sound using the arrow buttons. The *Left/Right Arrow* buttons select the character to be edited, while the *Up/Down Arrow* buttons scroll through the letters, numbers, and icons that can be used to name the sound.
- 4) Press the *Enter/Save* button.
- 5) Select a memory location for your program using the *Left/Right* and *Up/Down Arrow* buttons. These buttons will select the sounds currently residing in internal memory.

Look for a memory location that contains a sound that you no longer want or use. Sounds that are in memory can be "auditioned" at this point by pressing the *Edit Sound* button to toggle between the sound listed on the screen and the sound in the edit buffer.

- 6) When a location has been found, press the *Enter/Save* button. The display will show a momentary "SAVED" message before returning to the Sound Select mode.

Hint:

If you would like your edited sound to be saved in its present memory location, simply "double-click" the *Enter/Save* button. As in the above procedure the display will momentarily read "SAVED" and then return to the Sound Select mode. INTERNAL sounds that come with the SQ-R are duplicates of the ROM sounds, so that you can safely create new sounds (or edit existing ones) without losing the factory sounds.

Copying an Existing Sound to Another Location

Sometimes you'll want to take an existing sound, one that you haven't been editing, and simply copy it to another memory location. For example, you might want to put the six most commonly used sounds in the same bank, for easy access during performance.

- Select the sound you want to copy.
- Press *Enter/Save*. The display shows "Replace edit sound?"
- Press *Yes*. The selected sound now resides in the edit buffer. Now proceed from step three as described on the previous page to write the sound to the new location.

Section 6 — Standard Programming

This section covers those functions which can be edited independently for each individual voice within a Standard Sound.

SQ-R Standard Sound Configuration	6 - 2
SQ-R Voice Configuration	6 - 2
Modulators:	
About Modulation	6 - 3
Selecting a Modulator	6 - 3
Modulation Amount	6 - 3
Modulation Sources	6 - 4
Sound Edit Mode	6 - 8
Wave Bank:	
Select Voice/Voice Status	6 - 8
Wave Class	6 - 9
Individual Waves	6 - 11
Delay Time/Direction	6 - 12
Start Index/ Mod Source and Amount	6 - 12
Type-Specific Wave Parameters	6 - 12
Loop Length	6 - 13
Voice Restrike Decay Time	6 - 13
Change Sound Mode	6 - 13
Pitch Bank:	
Oct/Semi/Fine (Oscillator Tune)	6 - 14
Env1/LFO	6 - 14
Mod Source/Mod Amount	6 - 15
Keyboard Pitch Tracking	6 - 15
Glide Mode	6 - 15
Glide Time	6 - 15
ENV 1, ENV 2, (AMP) — SQ-R Envelopes	6 - 16
Levl	6 - 17
Time	6 - 18
LevV/AttckV/VelCurv	6 - 19
Mode (Env1 and Env2)	6 - 19
Mode (AMP) — Voice Triggering/Stealing Notes	6 - 20
KeyboardTrk	6 - 21
Select Defaults	6 - 21
LFO Bank:	
LFO Speed	6 - 22
Noise Rate	6 - 23
Level/Delay/Mod	6 - 23
Wave/Restart	6 - 24
LFO Waveshapes	6 - 24
Filter Bank:	
Filter1/Filter2	6 - 25
Filter Configurations	6 - 26
FC1 Cutoff/Envelope2	6 - 27
FC1 Keyboard	6 - 27
Mod Source/Mod Amount	6 - 28
FC2 Cutoff/Envelope 2	6 - 28
FC2 Keyboard/Mod FC1>FC2	6 - 28
Env2 and Amp Banks	6 - 29
Output Bank:	
Volume/Boost	6 - 29
Mod Source/Mod Amount	6 - 30
Keyboard Scale Amount/Key Range	6 - 30
Output Bus/Priority	6 - 31
Pan Location/Velocity Window	6 - 31

Copying an Existing Sound to Another Location

Sometimes you'll want to take an existing sound, one that you haven't been editing, and simply copy it to another memory location. For example, you might want to put the six most commonly used sounds in the same bank, for easy access during performance.

- Select the sound you want to copy.
- Press *Enter/Save*. The display shows "Replace edit sound?"
- Press *Yes*. The selected sound now resides in the edit buffer. Now proceed from step three as described on the previous page to write the sound to the new location.

Modulators

About Modulation

To modulate something is simply to cause it to change. Within the voice architecture of the SQ-R we begin by setting basic, or manual, levels for the volume, pitch, brightness, etc. of a voice, and we then modulate those levels in various ways in order to create movement and dynamics.

Suppose you switch on your stereo, and turn the volume half way up. We can call this the manual volume setting. It will stay at that level until it's changed. Now suppose that you take the volume knob of your stereo and begin quickly turning it up and down, so the volume gets continuously louder and softer, louder and softer. What you would be doing is modulating the volume of your stereo. If you were to take the treble control, and do the same to that knob, you would be modulating the brightness of your stereo.

In much the same way we modulate various levels within the SQ-R (though generally the approach is less haphazard). There are 15 different *Modulation Sources* available, and they can each be independently assigned to vary the manual levels for a great many aspects of a voice, including real time control of some aspects of an effects program.

Selecting a Modulator

On those programming screens where a modulator can be selected to vary the level of some function within a SQ-R voice, the display shows "Mod=_____" (short for Modulation Source). A modulator is selected using the *Up/Down Arrow* buttons to choose among the 15 available modulation sources.

Hint: Holding the *Up Arrow* and pressing either the *Left* or *Right Arrow* button selects <OFF>, which is handy if you don't want a Modulator applied in a particular location.

Let's take, for example, the Pitch Modulation screen, which is where you apply modulation to the pitch of a voice. Press the *Edit Sounds* button to place the SQ-R in Sound Edit Mode. Then press the *Bank Select* button (this displays the name of the current bank). While the button is held, press the *Up Arrow* button until the PITCH bank is selected. Finally, press the *Right Arrow* button until you reach the Pitch Modulation screen (shown below). In addition to Envelope 1 and the LFO, which are always available, you can choose an additional modulator to alter the pitch:

```

Env1=-99 LFO=-99
Mod=LFO      * +99
  
```

Modulation Amount

As shown above, where a modulation source is selected, the parameter immediately to its right controls the *Modulation Amount* (the display shows "*±##") which controls how deeply the selected modulator will affect the level to which it is being applied.

SQ-R Standard Sound Configuration

Each of the three voices within a SQ-R Standard sound consists of:

- a digital oscillator playing one of the 121 waves from the SQ-R wave memory
- two multi-mode digital filters
- one LFO (Low Frequency Oscillator)
- three complex envelope generators for controlling volume, pitch, filter frequency, etc.
- a versatile matrix modulation scheme with 15 routable modulation sources.

The diagram below shows the configuration of one SQ-R voice.

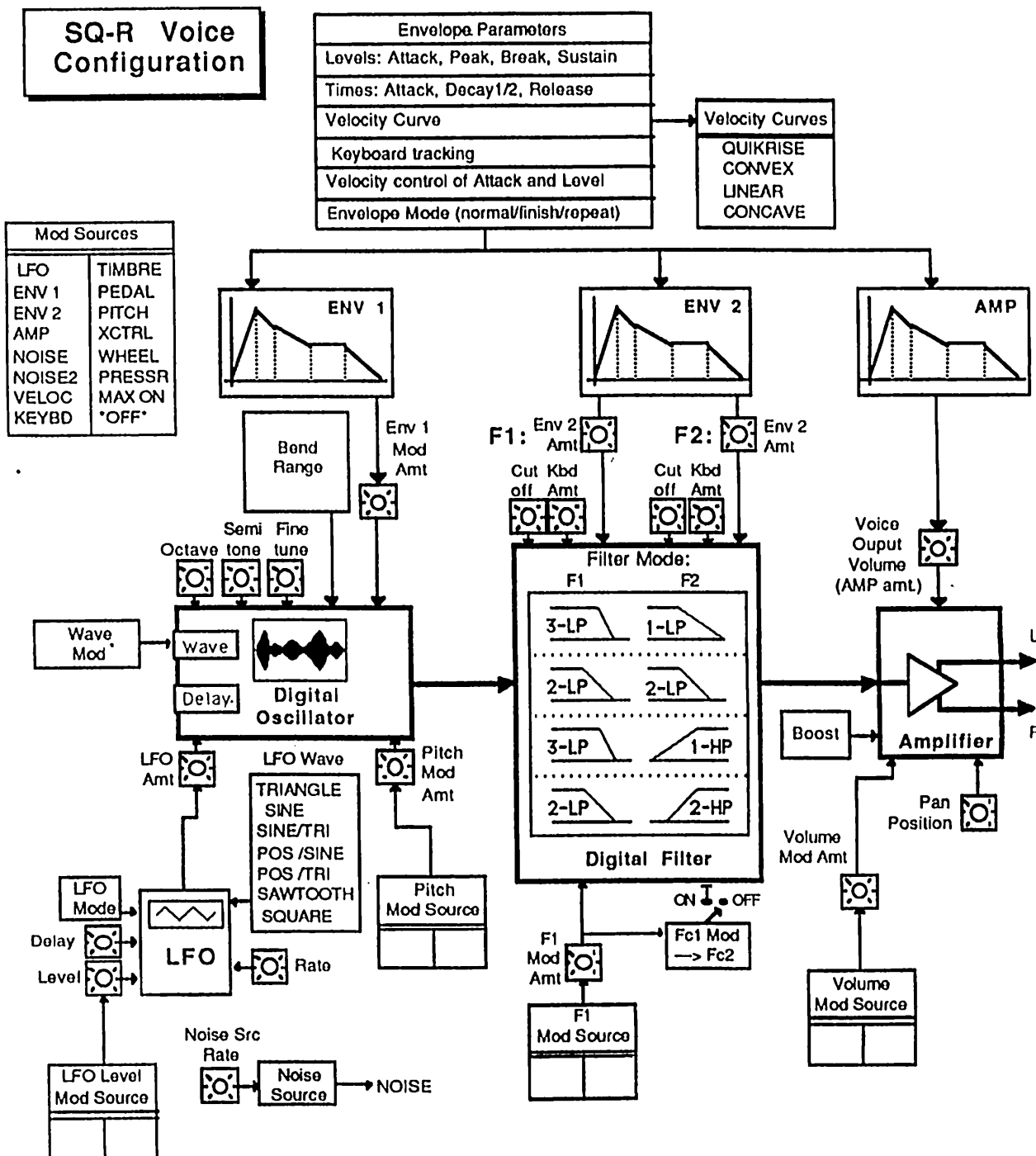

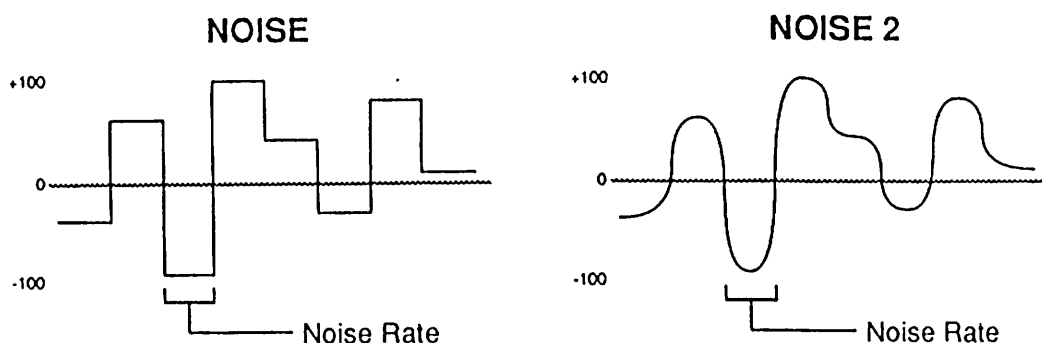

- **VELOC — Velocity**

Velocity means how hard you strike a key. Selecting VELOC as a Modulator allows you to modulate any manual level with velocity. Velocity as a modulation source only goes positive (though assigning a negative modulation amount will make the level reduce with increased velocity).

- **KEYBD — Keyboard Tracking**

This uses the position of a note on the keyboard as a modulator. The scaling effect of this Modulator is figured over the full 128 MIDI key numbers:

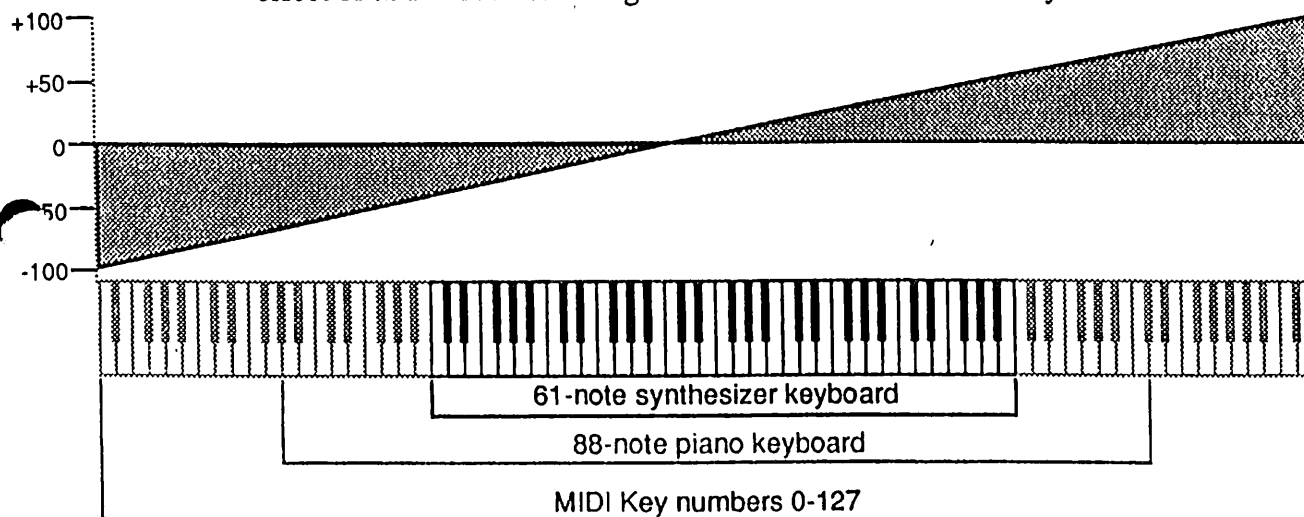

As the above illustration shows, the effect of KEYBD as a modulator goes negative as well as positive. The effect of KEYBD is to reduce the Level on notes below the break point (Middle C, MIDI Key #), and increase levels above that point. Negative Modulation depths will do the opposite.

- **TIMBRE — Timbre Control**

This is a special modulator, unique to ENSONIQ, which is intended as an "extra" real-time performance controller (MIDI Controller # 71). TIMBRE can be assigned like any other modulator wherever a modulation source is selected. A parameter in the Mix bank selects the TIMBRE amount.

- **PEDAL — Voltage Control Foot Pedal**

This selects the optional *CVP-1 Foot Pedal*, which can be plugged into the Pedal/CV jack on the SQ-R rear panel, as a modulator. Its effect will be the same as that of a mod wheel. It can be applied wherever a Modulator is selected.

Select the parameter "LFO=XX." Now, use the arrow buttons to adjust the modulation amount. Modulation amount can be positive or negative. A modulation amount of +00 has the same effect as turning the modulator <OFF>.

Hint:

With modulation amount, as with all parameter values that have a center value, there is an easy way to reach that value. With the "LFO=XX" selected, press the *Down Arrow* button, and *while holding it down*, press the *Up Arrow* button, then release both buttons. This automatically sets the modulation amount to +00. Similarly, you can reach maximum and minimum values by holding the appropriate *Up* or *Down Arrow* button (depending on the direction you wish to go) then pressing either the *Left* or *Right Arrow* button.

Modulation Sources

The 15 Modulation Sources available on the SQ-R are as follows:

- LFO — Low Frequency Oscillator
- ENV 1 — Envelope 1
- ENV 2 — Envelope 2
- AMP — Envelope 3 (Amp)
- NOISE — Noise Generator
- NOISE 2 — Noise 2
- VELOC — Velocity
- KEYBD — Keyboard Tracking
- TIMBRE — Timbre
- PEDAL — Voltage Control Foot Pedal
- PITCH — Pitch Bend Wheel
- XCTRL — External Controller (MIDI)
- WHEEL — Modulation Wheel
- PRESSR — Pressure (MIDI)
- MAX ON — Full Value
- OFF — Off

- **LFO — Low Frequency Oscillator**

The *Low Frequency Oscillator* generates only very low frequency waves, below the audio spectrum, which can produce vibrato, tremolo, and many other effects depending on the LFO wave selected and where it is applied as a modulator. There are seven possible waveshapes for the LFO. See the LFO Screen later in this section for a complete discussion of the LFO.

- **ENV 1, ENV 2, (AMP)**

The SQ-R has three complex *Envelopes*. Envelopes are used to create changes over time, in pitch, brightness, volume, etc.

- ENV 1 is permanently routed to the pitch of the voice, though it can be assigned as modulator elsewhere if you wish.
- ENV 2 is permanently routed to the filter cutoff frequency. It also can be assigned as a modulator elsewhere.
- AMP is a special case. AMP *always* controls the volume or *amplitude* of the voice and cannot be selected as a modulator anywhere else.

A discussion of the SQ-R Envelopes follows later in this section.

- **NOISE — Noise Generator**

The Noise generator creates a randomly changing level. It is useful for modulating, among other things, the pitch of a voice (Pitch Mod screen). Applied to pitch with large modulation amounts it tends to create strange "computer sound" effects. Small modulation amounts (around +02 to +04) can create a subtle random movement in the sound, which imparts a more natural quality.

- **NOISE 2 — Smooth Noise Generator**

This second Noise generator works on the same principles as NOISE, but NOISE 2 has a "smoothed" wave pattern. When applied to pitch, NOISE 2 has a siren-like quality, as compared to NOISE's computer effects. The following illustration shows the differences in the two Noise generators wave shapes.

Note that not all sounds are necessarily programmed to respond to pressure. If pressure seems to have no effect when you play certain sounds, it is likely that the programmer did not assign pressure as a modulator anywhere within the sound.

The effect of pressure as a modulator is positive-going only, though assigning a negative modulation depth will cause increased pressure to reduce manual levels.

- **MAX ON — Full Value**

MAX ON reaches the full value specified in the modulation amount at the instant of the keystroke and maintains it throughout the duration of the note. This can be useful in Drum Sounds, which can play back at their full volume regardless of the velocity of the keystroke. MAX ON can have a positive or negative effect, depending on the item which it is modulating.

Note that the CV Pedal will only act as a modulator when the Pedal Function in the System Bank is set to "Pedal=Mod #4." When that parameter is set to "Pedal=Volume #7" the CV Pedal will act as a volume pedal, not as a modulator (though this has no effect on incoming MIDI CV Pedal data). See *Section 2 — System Control* for more details.

- **PITCH — Pitch Bend Wheel**

This assigns a Pitch Wheel as a modulator. It allows you to have a Pitch Wheel, in addition to bending the pitch of a note (its normal function), also affect some other level. Applied to the filter cutoff frequency, for example, this would cause notes to become brighter as you bend them upwards and more muted as you bend them down (or the opposite with negative modulation amounts).

- **XCTRL — External Controller (MIDI only)**

An external controller such as a Breath Controller, etc., which is received via MIDI from another synthesizer or controller, can be assigned as a modulator within your SQ-R Sounds. In the System Bank, you select the number of the external controller that will be recognized by the SQ-R.

For example, if you have a keyboard with a Breath Controller;

- 1) Connect its MIDI Out to the SQ-R MIDI In;
- 2) Make sure both instruments have controllers enabled (System Bank);
- 3) Select Breath Controller as the external controller that will be received by the SQ-R (XCTRL=02, also in the MIDI Bank);
- 4) Assign XCTRL as a Modulator for LFO level, Filter Cutoff frequency, or some other manual level within a voice, as shown in the Programming section; and
- 5) Play the sound from the controller keyboard, while blowing into the Breath Controller.

- **WHEEL — Modulation Wheel**

A Mod Wheel is assignable wherever a modulator is selected. To use the mod wheel for vibrato (one common application) WHEEL must be assigned to modulate the LFO, and the LFO Amount set to some number other than 0 on the Pitch Mod Screen. The mod wheel's effect is positive, from 0 (wheel towards you) to +99 (wheel away from you). Negative modulation amounts will reverse the effect.

- **PRESSR — Pressure (After-touch — MIDI Only)**

Pressure, also called after-touch, is a modulator which varies a manual level within a voice depending on how hard you press down on a key or keys. When playing the SQ-R from a keyboard with pressure, after you have struck a key, and while the note is sustaining, continuing to press down harder on the key brings in pressure.

Pressure comes in two varieties — *Poly-Key™* pressure (or Polyphonic pressure), which affects each note individually, and *Channel* pressure (or Mono pressure) which affects all notes that are playing when you exert pressure on any key. Both types are received by the SQ-R.

EditVoice

This parameter determines whether you will be editing one or all voices within a sound.

- VOICE 1, VOICE 2, VOICE 3 — For each of these values, a single voice will be selected for editing. The voice named is the voice which will be affected by any edits to any programming parameters.
- ALL — All voices within the sound which are set to ON are selected and can be edited as a group. When "ALL" is selected, the SQ-R goes into *Group Edit Mode* and changes made to any of the programming parameters will affect all voices playing within that sound.

Voice Status

The three values on the bottom of the Oscillator Screen are known collectively as the Voice Status parameter. These values correspond to the three voices that make up an SQ-R sound. This parameter is used to determine the voice's playback status.

There are three status options that a voice can be set to on this screen;

- OFF — The selected voice is muted and will not play.
- ON — The selected voice will play.
- SOLO — The selected voice will play and all other voices will be muted. This is convenient for occasions when you'd like to hear how your edits are affecting a particular voice.

Important:

Once you have selected the particular voice you would like to edit (by selecting either VOICE1, VOICE2, or VOICE3 from the EditVoice parameter), *only* the voice chosen for editing can be selected on the lower line of the display. Pressing the *Right Arrow* button from the Voice Status parameter will cause the SQ-R to advance to the next parameter screen. When ALL is selected from the EditVoice parameter, none of the Voice Status parameters can be selected.

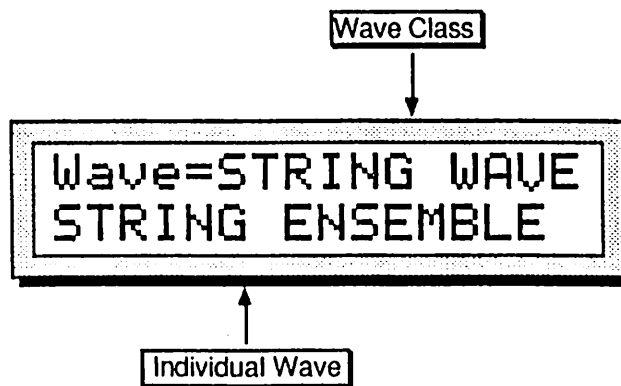
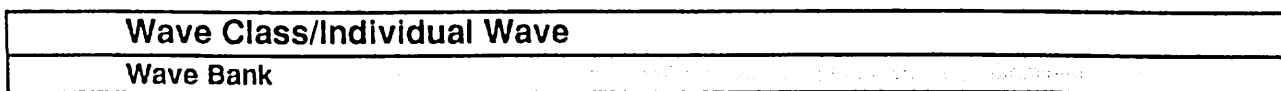

Wave Class

This parameter determines the class of waveforms which will be used for a particular voice. By selecting this parameter, you can use the *Up/Down Arrow* buttons to scroll quickly through the different wave classes to the category you want. Then select the wave name to choose a specific wave from that category.

Whenever the wave class is changed, the first wave in that class is selected and lower-line parameters are reset to default values for the new wave class.

The SQ-R waves are divided into 11 categories, or *Wave Classes*:

These wave classes contain samples of real acoustic and electronic sounds, which can be used as the basis for a wide variety of realistic musical sounds. Where necessary, these waves have been *multisampled* (sampled at many points through the range of the instrument) for maximum authenticity in reproducing the original.

- **STRING-WAVE** - Samples of stringed instruments — strings, pianos, guitars, etc.
- **BRASS-WAVE** - Samples of brass instruments — horns, sax, etc.
- **BASS-WAVE** - A variety of bass sounds — electric, acoustic and synthesized.
- **BREATH-WAVE** - Flute and vocal sounds with complex, breathy sustains.
- **TUNED-PERCS** - This category contains a wide variety of sounds — generally, these are percussive sounds which are looped (that is, they will sustain).
- **PERCUSSION** - This class contains unlooped (non-sustaining) percussion sounds.
- **DRUM-WAVE** - Individual drum sounds which are used to create customized drum kits. See Section 7 for more details on drum programming.

The next three wave classes contain a variety of sampled and algorithmically generated waves that are more "synthesizer" oriented:

- **TRANSWAVE** - Transwave™ is a special class of waves, unique to ENSONIQ instruments. Each Transwave consists of many single-cycle waveforms, each with a different harmonic spectrum. The playback parameters allow you to start the wave playing at any one of these waveforms and move through the wavetable, continually varying the timbre of the sound, using any of the 15 modulators.
- **WAVEFORM** - A waveform is a single cycle of a sound repeated over and over. The SQ-R contains both sampled and synthetic waveforms. Waveforms such as Sawtooth and Square can be used to reproduce a wide array of analog synth sounds.
- **INHARMONIC** - Inharmonic loops are similar to waveforms except that they contain many cycles of the sound and can therefore contain *inharmonics* — frequencies which are not exact multiples of the fundamental frequency.
- **MULTI-WAVE** - Contains only one wave, but it consists of ALL-WAVES in the SQ-R memory. Starting from any wave in memory, any number of waves can be played, forward or backward, to create effects and "jam-loops."

Individual Waves

Here you select the actual wave which the voice will play. When this parameter is underlined, pressing the *Up/Down Arrow* buttons will scroll through the individual waveforms within the selected wave class, then cross over into the next class.

Below is a complete listing of the 121 SQ-R Waves. The wave class is shown in bold at the top of each group.

<p>STRING-SOUND: STRING ENSEMBLE PIZZICATO STRING GRAND-PIANO PIANO VARIATION DIGITAL PIANO CLAVIER PIANO ACCORDION GTR V. GTR VAR. GUITAR-HAR. ELECTRIC GUITAR PLUCKED GUITAR CHUKKA-GUITAR</p>	<p>BREATH-SOUND: WOOD FLUTE CHIFF FLUTE VOX-OOOHS VOCAL ENSEMBLE</p> <p>TUNED-PERCUSSION: MARIMBA KALIMBA STEEL DRUM DOORBELL POT SYNTH PLUCK PLINK HORN PIANO PING ORCHESTRA HIT RACK-BELL</p>	<p>DRUMWAVE: DYNAMIC KICK GATED KICK ROOM KICK ELECTRIC KICK TIGHT KICK THUMP KICK THUMP SNARE SYNTH SNARE ROOM SNARE BRUSHED SNARE RIMSHOT SNARE SIDESTICK SNARE DRY TOM LOW DRY TOM HIGH ROOM TOM LOW ROOM TOM HIGH CLOSED HI-HAT 1 CLOSED HI-HAT 2 SYNTH CLOSED HAT PEDAL HI-HAT OPEN HI-HAT RIDE CYMBAL CRASH CYMBAL</p>	<p>WAVEFORM: ORGAN VARIATION1 ORGAN VARIATION2 ORGAN VARIATION3 ORGAN VARIATION4 SAWTOOTH SQUARE SINE TRIANGLE 1+2 HARMONICSS 2 HARMONIC SAW DIGITAL PNO GRIT DIGITAL PNO TINE BUBBAWAVE CLAVINET CLAV VARIATION WOODWIND WWIND VARIATION PIPE ORGAN BRASS ORGAN VOCAL BELL SYNTH BELL CLARINET</p>
<p>BRASS-SOUND: BRASS ENSEMBLE SOLO TRUMPET TRUMP VARIATION SAXOPHONE SAX VARIATION-1 SAX VARIATION-2</p>	<p>PERCUSSION: WOODEN HIT WOOD BLOCK TEMPLE BLOCK CLAVES TIMBALE BONGOS AGOGO-BELL COWBELL TAMBOURINE FINGERSNAPS CLAPS DINKY HIT TOY HAMMER SLINKY POP MUSICIAN'S TAPE STEAM DRUM BIG BLAST SPRAY CAN METALLIC DINK VOCAL PERCUSSION ANVIL-HIT SYNTH THUMP</p>	<p>TRANSWAVE: FORMANT-X PLANET-X ELECTRO-X PULSE 1-X PULSE 2-X RESONANT 1-X RESONANT 2-X RESONANT 3-X RESONANT 4-X</p>	<p>INHARMONIC: TRIANGLE LOOP ANVIL LOOP CLUSTER LOOP TUBULAR LOOP NOISE LOOP</p>
<p>BASS-SOUND: PICKED BASS THUMB POP BASS PLUCKED BASS ACOUSTIC BASS SYNTH BASS-1 SYNTH BASS-2</p>			<p>MULTI-WAVE: ALL-WAVES</p>

Delay Time/Direction
Wave Bank

Delay Time

The Delay Time parameter determines how long the voice will wait after a key down is received before playing. Adjustable from 000 to 250, with each value increasing the delay time by 4 milliseconds. A delay of up to 1 second is possible.

Triggering a voice with a Key up — In the highest position, Delay Time=KEYUP, the voice will wait until a key up is received before it plays.

Direction

This parameter determines the direction a wave will play, either Forward or Backward.

Waves found within the TRANSWAVE, WAVEFORM and INHARMONIC wave classes are based upon loops and therefore have a fixed direction. When one of these waves is selected, this parameter will not appear on the screen.

Start Index/Mod Source and Amount (Loop Length)
Wave Bank

```
Start Index=00
Mod=LFO * +00
```

Mod Source

Mod Amount

```
Start Index=00
Loop Length=000
```

Loop Length

Start Index

This controls where in the sample the wave will begin playing. When START=00, the whole wave will play. As the start point is adjusted upwards it will begin playing further into the wave. You can use this, for example, to skip the attack and play only the loop portion of looped (sustaining) sounds.

Range: 00 to 99

Type-specific Wave Parameters

The parameters shown on the lower line of this screen will vary depending on the current wave class. For each wave class, the lower line of the display will contain parameters controlling the features which are specific to that category.

As mentioned earlier, changing the wave class resets these parameters. However, if you scroll only one step away from the current class and then scroll back, any lower-line settings you had will be restored. Go more than one class from the current one and any lower-line settings will be lost.

Mod Source

Modulation Source - Here you can choose which of the 15 modulators will control the movement of the sound. Any of the modulators can be selected.

Mod Amount

Modulation Amount - Determines how much the selected modulator (above) will affect the wave; i.e. how far away from the start point the sound will move. If the mod amount is set to +00, the sound will remain static. Positive amounts will modulate the sound forward (toward the end of the wave); negative modulation amounts will move the sound back toward the beginning. Both Mod Source and Mod Amount are applicable to all wave classes except INHARMONIC, WAVEFORM and MULTI-WAVE.

Range: -99 to +99

Loop Length

Controls how many waves will be included in the loop. This parameter is found only when using MULTI-WAVE.

Range: 000 to 121

Note: Two wave classes, INHARMONIC and WAVEFORM, have no parameters on this screen. When programming a voice that uses a wave contained within these wave classes, choosing this screen will have no effect and the following screen will be displayed.

Voice Restrike Decay Time
Wave Bank

Wave Bank

Voice Restrike Decay Time

This parameter sets the amount of decay a note will have after it has been restruck. The higher the value, the longer the decay time.

Range: 00 to 99

Change Sound Mode
Wave Bank

Wave Bank

Change Sound Mode

Press the *Enter/Save* button to switch the current sound mode. When working in Standard Sound mode, this command will place the default Drum Sound into the edit buffer and place the SQ-R in Drum Sound mode.

Pitch Bank

In the Pitch bank you set the "manual" levels for the pitch of the voice and select the modulation sources for the Pitch.

Oct/Semi/Fine (Oscillator Tune)
Pitch Bank

Oct

Changes the pitch of the oscillator by octaves.

Range: -4 to +4 octaves

Semi

Changes the pitch of the oscillator by semitones. Incrementing/decrementing this control beyond +11 or -11 automatically increases/decreases the octave by one.

Fine

Changes the pitch of the oscillator by steps of one cent (1/100 of a semitone).

Range: -99 to +99

Env1/LFO/Mod Source and Amount
Pitch Bank

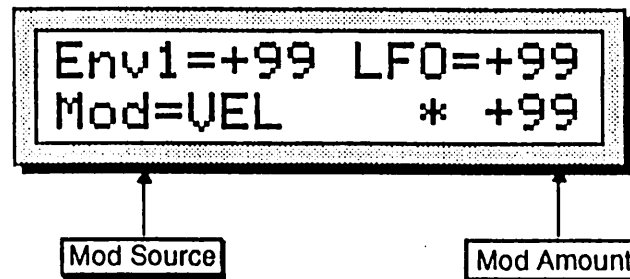

On the Pitch Mod Screen you apply modulation to the pitch of the voice. Envelope 1 and the LFO are always available to modify the pitch, and you can choose one additional modulator.

Env1

Envelope 1 — Determines the amount or depth by which envelope 1 will affect the pitch.

Range: -99 to +99

LFO

Low Frequency Oscillator Amount — Determines the amount by which the LFO will affect the pitch of the voice. LFO is most commonly used for vibrato, but can create many unusual effects, depending on the LFO waveform chosen.

Range: -99 to +99

Mod Source

Modulation Source — Selects an additional modulator for the pitch of the voice from among the 15 available modulation sources.

Mod Amount

Modulation Amount — Determines the amount or depth by which the additional modulation source will affect pitch.

Range: -99 to +99

Keyboard Pitch Tracking
Pitch Bank

Keyboard Pitch Tracking

Determines whether or not the pitch of the selected voice will change across the keyboard or remain static at C4.

- ON — The pitch of a voice tracks with the keyboard.
- OFF — All keys play at the same pitch; C4.

Glide/Glide Time
Pitch Bank

Glide

Enables Glide (portamento) and several forms of monophonic voice assignment in a sound. All three voices in a sound use the same Glide Time, but each voice selects whether it will glide or not. There are four Glide Modes:

- OFF — Glide is off. This is normal polyphonic operation, with no portamento.
- RETRIGGER — This mode plays monophonically, with the envelope and waveform retriggering, or restarting, each time there is a new key down.
- MINI — Similar to mono mode on old analog synths. The voice will play with one-note polyphony and new notes will always glide from the previous note (assuming Glide time is greater than zero). If you just want mono voice assignment without glide, set "GlideMode=MINI" and set the Glide time to zero.
- LEGATO — When GlideMode=LEGATO, if you release a note the SQ-R "forgets" that note. The SQ-R will not glide to notes when you play staccato — play a new key with no other keys down. It will glide when you play legato — play a new key while another key is down.

Note: RETRIGGER, MINI, and LEGATO feature "note memory" — if you release a key while still holding down another key, the pitch will return to note you are holding.

Glide Time

Determines the amount of time that it takes for the pitch to glide smoothly from one note to another.

Range: 00 to 99 (the higher the value, the longer the glide time)

ENV 1, ENV 2, (AMP) — SQ-R Envelopes

An *Envelope* is a shape, or contour, which we apply to a signal source to make it change over time. Each SQ-R voice has three envelopes. These envelopes are automatically routed to the pitch, filter frequency and amplitude of the voice, though ENV 1 and ENV 2 can also be assigned elsewhere, wherever a modulator is selectable.

- ENV 1 is routed to the pitch of the voice. There is a parameter always available on the Pitch Mod Screen which lets you adjust the amount by which ENV 1 will modulate the voice's pitch.
- ENV 2 is routed to the filter cutoff frequency of the voice. For each of the voice's two filters, the parameter labeled ENV 2=__ in the Filters bank controls ENV 2 depth.
- AMP is routed to the amplitude (volume) of the voice. The AMP envelope *always* controls the final volume contour of the voice. Any other volume modulators selected in the Output bank will occur before AMP in the signal flow.

The SQ-R envelopes are descended from the venerable ADSR (attack, decay, sustain, release) envelope, but with many refinements. While the ADSR envelope gives you control over three time segments and one level, the SQ-R envelopes give you control over *four* levels and *four* time segments.

The illustration below shows the make-up of a SQ-R envelope:

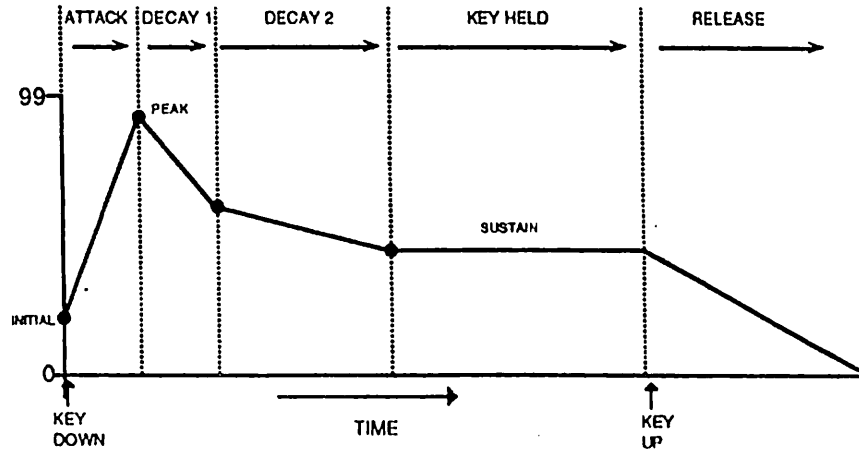

Levl/Time
Env1 Bank

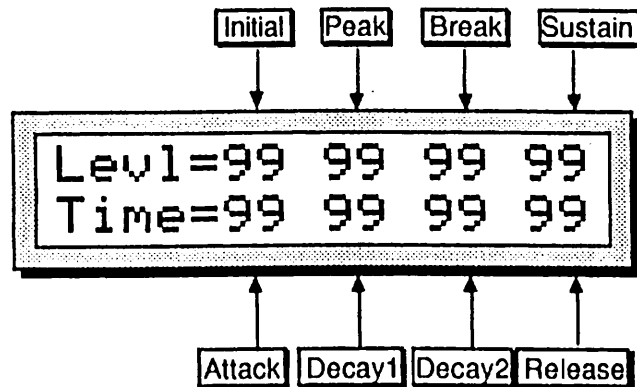

Levl

This parameter sets the levels for the four stages of the envelope. The four values correspond to the following levels:

INITIAL

Determines the level at which the envelope will start when a key down is received.

Range: 00 to 99

PEAK

Determines the level the envelope will reach at the end of the time defined by ATTACK (see below).

Range: 00 to 99

BREAKPOINT

Determines the level the envelope will reach at the end of DECAY 1.

Range: 00 to 99

SUSTAIN

Determines the level the envelope will reach at the end of DECAY 2 and retain as long as a key is held down.

Range: 00 to 99

Time

This parameter is used to set values for the four time segments. Note that the numbers shown here represent *times*, not rates. That is, the envelope will take a fixed amount of time to go from one level to another no matter what those two levels are.

ATTACK

The amount of time it takes for the envelope level to travel from the INITIAL level (when the key is struck) to the PEAK level. The higher the value, the longer the time. This doesn't necessarily have to be an "attack" in the usual sense — the INITIAL level could be set higher than the PEAK level, in which case this would become another decay stage.

Range: 00 to 99 (see the Envelope Times chart below for a listing of the time values).

DECAY 1

The time it takes the envelope to go from PEAK to BREAK.

Range: 00 to 99

DECAY 2

The time it takes the envelope to go from BREAK to SUSTAIN.

Range: 00 to 99

RELEASE

This defines the time it will take the envelope to return to zero after the key has been released.

Range: 00 to 99

ENVELOPE TIMES

value	time (in sec)	value	time (in sec)	value	time (in sec)	value	time (in sec)	value	time (in sec)
0	.00	20	.20	40	.82	60	3.2	80	13
1	.01	21	.22	41	.88	61	3.5	81	14
2	.02	22	.23	42	.94	62	3.7	82	15
3	.03	23	.25	43	1.0	63	4.0	83	16
4	.04	24	.27	44	1.0	64	4.3	84	17
5	.06	25	.29	45	1.1	65	4.6	85	18
6	.07	26	.31	46	1.2	66	4.9	86	19
7	.08	27	.33	47	1.3	67	5.3	87	21
8	.08	28	.35	48	1.4	68	5.7	88	22
9	.09	29	.38	49	1.5	69	6.1	89	24
10	.10	30	.41	50	1.6	70	6.5	90	26
11	.11	31	.44	51	1.7	71	7.0	91	28
12	.11	32	.47	52	1.8	72	7.5	92	30
13	.12	33	.50	53	2.0	73	8.1	93	32
14	.13	34	.54	54	2.1	74	8.6	94	34
15	.14	35	.58	55	2.3	75	9.3	95	37
16	.15	36	.62	56	2.4	76	9.9	96	39
17	.16	37	.66	57	2.6	77	10	97	42
18	.17	38	.71	58	2.8	78	11	98	45
19	.19	39	.76	59	3.0	79	12	99	49

LevV/AtckV/VelCurv
Env1 Bank

LevV

Velocity Level Control — The Velocity level parameter will lower all envelope settings with a softer keystrike. This means that the settings you assign to INITIAL, PEAK, BREAK, and SUSTAIN are maximum levels, the levels that will be reached with the hardest keystrike. The amount of "LevV" will determine how much those levels will be reduced as you play softer. With this parameter you can have continuous dynamic control over the four levels by varying how hard you play. Changing the Velocity Curve (VelCurv) gives you further control over the velocity response of the envelope.

Range: 00 to 99

AtckV

Velocity Attack Control — Velocity attack makes the envelope attack time respond to keyboard velocity. When the value of "AtckV" is increased, a harder keystrike will result in faster attack. Note that this parameter will have no effect if "AtckV=00."

Range: 00 to 99

VelCurv

This selects which of the four available velocity response curves the envelope will use if the velocity level control (LevV above) is set to some value other than zero.

Available values are: QUIKRISE, CONVEX, LINEAR, and CONCAVE.

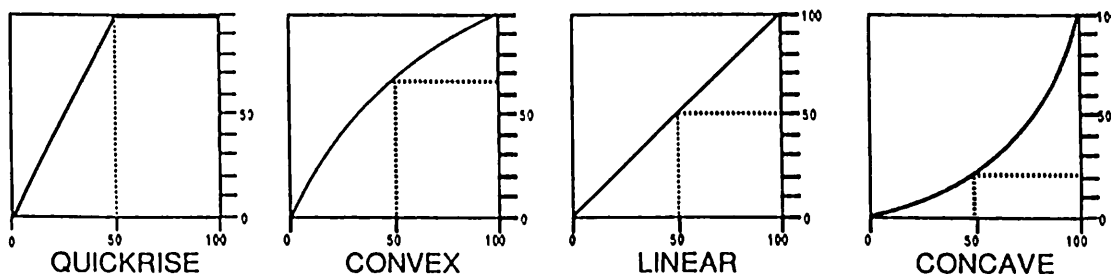

Mode/KeyboardTrk
Env1 Bank

Mode — (ENV 1 and ENV 2)

- **NORMAL** — The envelope plays through normally, as shown in the diagram on the following page.
- **FINISH** — The envelope runs its full cycle — *finishes* playing through all its stages — ignoring the key-up event. The envelope spends no time at the sustain stage. As soon as DECAy 2 is finished, instead of stopping at the sustain stage, the envelope immediately goes into the release stage. This is good for percussive-type sounds where you want the envelope to be the same for every note, no matter how long the key is held down.

- **REPEAT** — In this mode, at the end of the DECAY 2 stage, instead of sustaining, the envelope goes immediately back to the beginning of the envelope and repeats. When the key is released, the envelope stops repeating and moves into the release stage. This type of envelope can be used to create complex LFO-type effects.

MODE (AMP) — Voice Triggering/Stealing Notes

Since AMP controls the volume of the voice there are a number of special considerations to be aware of when using the the different envelope modes:

In **NORMAL** mode, if you set a delay on the voice, and you release the key before the designated delay time elapses, the voice will not sound, even if the sustain pedal is down.

In **FINISH** mode, if you set a delay on the voice and you release the key before the designated delay time elapses, the note will sound anyway. The envelope finishes what you set it up to do.

In **REPEAT** mode the SQ-R restarts the wave from the beginning every time the envelope repeats. When envelope gets to the **SUSTAIN** level, it goes back to the **INITIAL** level.

In order to maximize the use of the SQ-R's 21 voices, and to manage the "voice stealing" it is sometimes useful to understand when a given voice will be assigned and when it will be released, or "put back" into the pool for use by other sounds. This depends on a combination of envelope mode and the wave type.

A looped (sustaining) wave will continue to use the voice until the envelope reaches zero. For a sustaining wave, when the Envelope Mode is Normal:

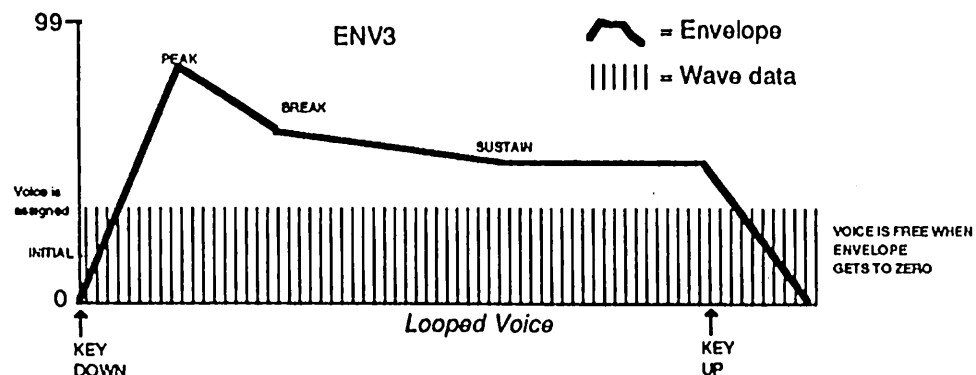

For a sustaining wave, when the Envelope Mode is set to Finish:

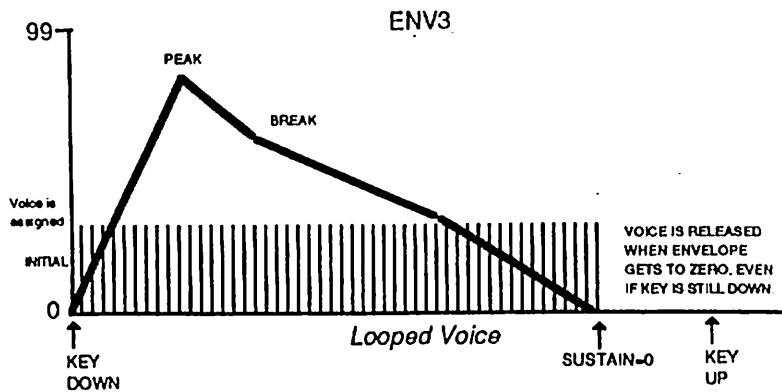

For unlooped, non-sustaining, waves (specifically those in the Percussion and Drum categories) the voice becomes free as soon as the sample has played through to the end, no matter where the envelope level is. The voice is released for use by another sound:

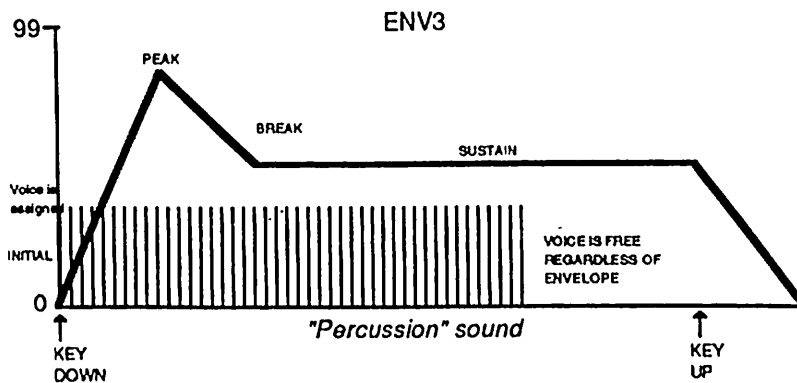

KeyboardTrk

Keyboard Tracking — Makes the Envelope time segments longer or shorter depending on the position of the key on the keyboard.

Raising the value of KeyboardTrk will make all envelope times (except Release) shorter as you play notes above middle C, and longer as you play below middle C — higher notes will have shorter envelopes than lower ones. The greater the value assigned to KeyboardTrk, the greater the difference in decay time between the highest and lowest note. Middle C will always remain the same and is not affected by this parameter.

Range: -98 to +98

Select Defaults
Env1 Bank

Press **ENTER** to select Defaults

Pressing the *Enter/Save* button lists a group of available "pre-set" envelope values which can be placed into the current envelope. This is particularly useful when setting up typical envelopes as starting points when you are creating new voices. After selecting the envelope shape, pressing *Enter/Save* again places it into the voice.

LFO Bank

The LFO Bank contains the parameters related to the Low Frequency Oscillator. Each voice within a sound has its own LFO which can be assigned as a modulator wherever a modulation source is selected. LFO's are commonly used to create vibrato, tremolo and other effects.

LFO Speed/Noise Rate
LFO Bank

LFO Speed

Determines the speed of the LFO.

Range: 00 to 99

The table below shows the frequency (in hertz) for each value:

LFO FREQUENCIES

value	freq (in Hz)	value	freq (in Hz)	value	freq (in Hz)	value	freq (in Hz)	value	freq (in Hz)
0	.08	20	1.25	40	6.25	60	11.25	80	16.25
1	.05	21	1.50	41	6.50	61	11.50	81	16.50
2	.06	22	1.75	42	6.75	62	11.75	82	16.75
3	.06	23	2.00	43	7.00	63	12.00	83	17.00
4	.06	24	2.25	44	7.25	64	12.25	84	17.25
5	.07	25	2.50	45	7.50	65	12.50	85	17.50
6	.07	26	2.75	46	7.75	66	12.75	86	17.75
7	.08	27	3.00	47	8.00	67	13.00	87	18.00
8	.08	28	3.25	48	8.25	68	13.25	88	18.25
9	.09	29	3.50	49	8.50	69	13.50	89	18.50
10	.10	30	3.75	50	8.75	70	13.75	90	18.75
11	.11	31	4.00	51	9.00	71	14.00	91	19.00
12	.13	32	4.25	52	9.25	72	14.25	92	19.25
13	.14	33	4.50	53	9.50	73	14.50	93	19.50
14	.17	34	4.75	54	9.75	74	14.75	94	19.75
15	.20	35	5.00	55	10.00	75	15.00	95	20.00
16	.25	36	5.25	56	10.25	76	15.25	96	20.25
17	.33	37	5.50	57	10.50	77	15.50	97	20.50
18	.50	38	5.75	58	10.75	78	15.75	98	20.75
19	1.0	39	6.00	59	11.00	79	16.00	99	21.00

Noise Rate

One of the SQ-R's 15 available modulation sources is NOISE. The Noise modulator is a signal whose level varies by random amounts. Typically, it might look like this:

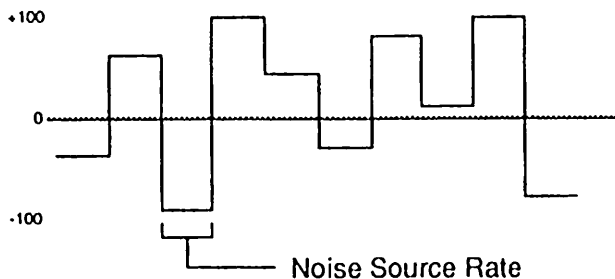

The Noise Rate defines how frequently the level will change. Low values will cause it to change very slowly; with high values the level will change quickly.

Range: 00 to 99

Level/Dlay/Mod
LFO Bank

```

Level=99 Dlay=00
Mod=WHEEL

```

Level

LFO Level — Sets the "manual" level (or depth) of the LFO. Level controls the initial amount of LFO. The effect of any LFO modulator will be added to this amount.

Range: 00 to 99

Dlay

LFO Delay — Determines the time it takes for the LFO to go from zero to the level set with the "Level" parameter. This is useful for creating delayed vibrato, tremolo, etc. Higher values give longer delay times.

Range: 00 to 99

Mod

LFO Rate Modulation Source — Selects a modulation source for "LFO Speed" from among the 15 available modulators.

Wave/Restart
LFO Bank

Wave

The Wave determines how the signal will rise and fall. There are seven possible values:

- **TRIANGLE** — the triangle wave is commonly used to modulate the LFO to produce vibrato.
- **SINE** — the sine wave is a pure fundamental frequency, more abrupt in its peaks and valleys than the triangle wave.
- **SINE/TRI** — a mixture of a sine and triangle wave, a sort of pointy sine wave.
- **POS/SINE** — the POS/SINE is similar in application to the POS/TRI.
- **POS/TRI** — the POS/TRI is a positive-only triangle wave useful for simulating vibrato on instruments like the guitar where vibrato techniques are limited to bending the note up.
- **SAWTOOTH** — the sawtooth wave is commonly used for special effects.
- **SQUARE** — the square wave is useful for producing trill effects.

LFO Waveshapes

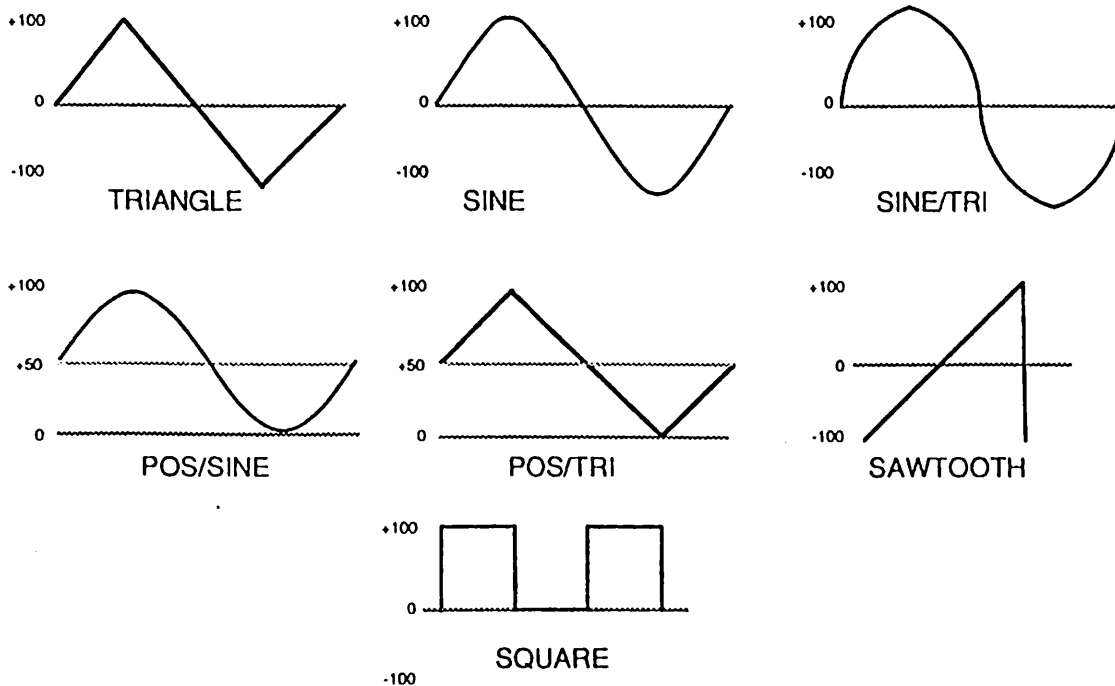

Restart

Determines whether the LFO will restart with each keystroke: When set to OFF, the LFO will cycle continuously without resetting. When set to ON, the LFO waveform will return to the beginning of its cycle each time a new key is struck.

Filter Bank

Each SQ-R voice has its own pair of digital filters, Filter 1 and Filter 2, which are connected in series. The filter settings determine which ranges of frequencies will be allowed to pass through to the output.

Low-pass/High-pass

A low-pass filter allows only those frequencies below the filter cutoff frequency to pass — higher frequencies are filtered out. The reverse is true for a high-pass filter — it lets frequencies higher than the cutoff frequency pass and filters out those below. In the SQ-R, Filter 1 is always a low-pass filter. Filter 2 can be either a high-pass or low-pass filter.

Poles: Rolloff Curves

"Pole" is an engineering term which describes the steepness of a filter, or the filter's cutoff *slope*. Each additional pole gives a filter a steeper rolloff curve. In the SQ-R, the filter modes are interdependent; that is, the combined number of poles in Filter 1 and Filter 2 is always four.

These four poles are divided between the two filters; either as 2 and 2, or as 3 and 1. A 1-pole filter will rolloff at 6 dB per octave; a 2-pole filter, 12 dB per octave; a 3-pole filter, 18 dB per octave; and 4-pole filter, 24 dB per octave. To reproduce a 4-pole low-pass filter (for that "classic" analog synth sound) you would set both low-pass filters to roll off at 12 dB per octave, resulting in a 24 dB per octave rolloff.

Cutoff Frequency

Every filter has a "knee" in the response curve, known as the cutoff frequency. This is the frequency at which the filter begins filtering out frequencies. The filter cutoff frequency can remain fixed over time, or it can be varied by modulating the filter with an envelope, LFO, velocity, etc.

Filter1/Filter2
Filter Bank

<pre>Filter1= 2LoPass Filter2= 2HiPass</pre>
--

Filter1

Filter 1 Mode — Determines whether Filter 1 will be a 2-pole or 3-pole low-pass filter.

Filter2

Filter 2 Mode — Filter 2 can be configured as a 2-pole or 1-pole high-pass filter, or a 2-pole or 1-pole low-pass filter.

These two parameters are "tied together" in that changing the value of either will result in a corresponding change in the other.

Filter Configurations

The diagrams below show a number of possible filter configurations. On the left are the response curves of the two filters shown separately. On the right are some of the possible shapes of the combined filters.

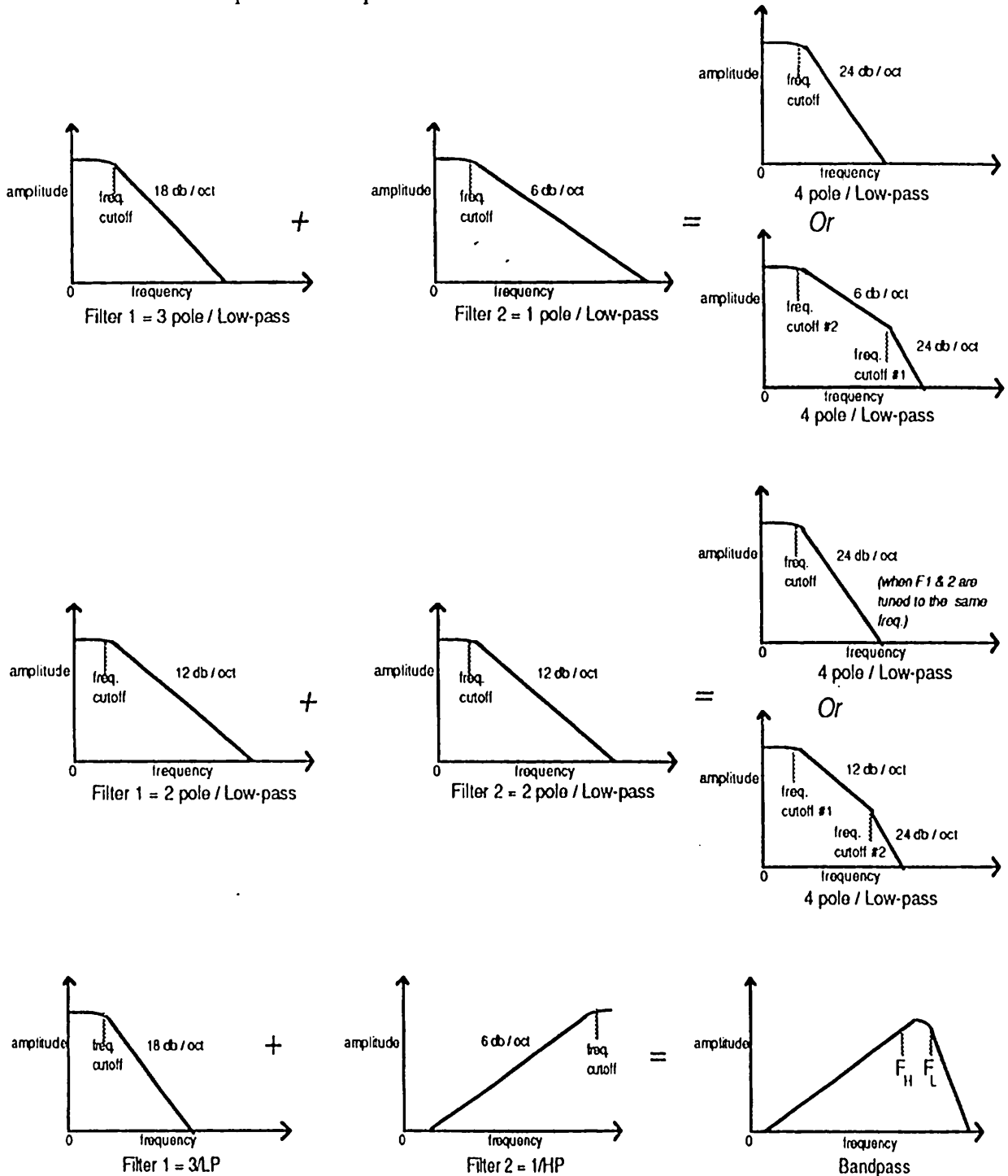

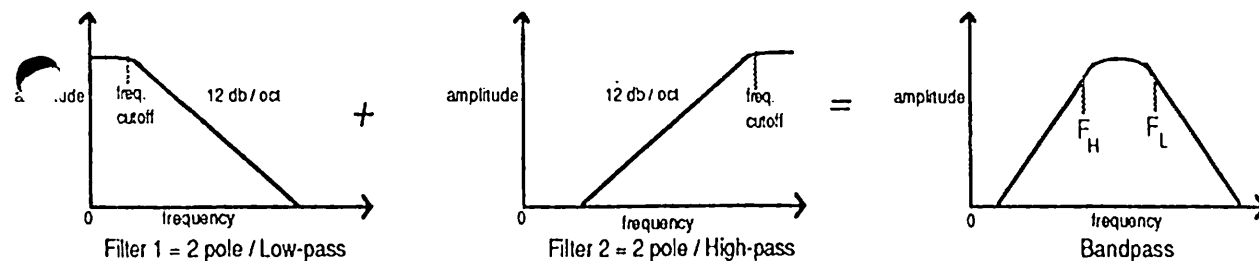

FC1 Cutoff/Envelope2

Filter Bank

FC1 Cutoff

Filter 1 Cutoff Frequency — Determines the initial, or manual, filter cutoff frequency. With a low-pass filter, a setting of 127 lets all the original signal pass through the filter. Lower settings lower the cutoff frequency, somewhat like turning down the treble on a stereo.

Range: 000 to 127

Envelope2

Determines the amount or depth by which envelope 2 will affect the filter cutoff frequency.

Range: -99 to +99

FC1 Keyboard/Mod Source and Amount

Filter Bank

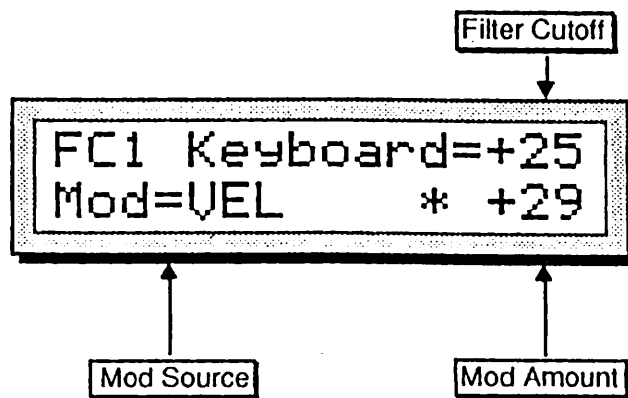

FC1 Keyboard

Sets the amount by which the location of a note on a keyboard will modulate the filter cutoff frequency (keyboard filter tracking). To have the filter track the keyboard exactly, set FC1 Keyboard=+50.

Range: -99 to +99

Mod Source

Selects the source of modulation for the filter cutoff frequency from among the 15 available modulation sources.

Mod Amount

Determines the amount or depth by which the modulation source will affect the filter cutoff frequency

Range: -99 to +99

FC2 Cutoff/Envelope2
Filter Bank

FC2 Cutoff

Filter 2 Cutoff Frequency — Determines the initial, or manual, filter cutoff frequency. With a low-pass filter, a setting of 127 lets all the original signal pass through the filter. Lower settings lower the cutoff frequency, somewhat like turning down the treble on a stereo.

Range: 000 to 127

Envelope2

Determines the amount or depth by which Envelope 2 will affect the filter cutoff frequency.

Range: -99 to +99

FC2 Keyboard/FC1 Mod—>FC2
Filter Bank

FC2 Keyboard

Sets the amount by which the location of a note on a keyboard will modulate the filter cutoff frequency (keyboard filter tracking). To have the filter track the keyboard exactly, set FC2 Keyboard=+50.

Range: -99 to +99

FC1 Mod—>FC2

Allows the modulator assigned to FC1 to also modulate FC2. The FC2 amount has no modulation source of its own, this is the only way to apply modulation to it. When "FC1 Mod—> FC2= ON" the modulation source for FC1 and its modulation amount will be applied to FC2.

Env2 and Amp Banks

The parameter screens in these banks correspond directly to those found in Env1 (Bank 2). See the section covering Env1 earlier in this section for details. Again, Env1 controls pitch, Env2 controls the filter, and Amp regulates volume.

Output Bank

The parameters in the Output Bank, along with the Amp envelope, regulate the overall volume and panning of the voice, along with keyboard scaling, effects routing and voice reassignment, or "voice stealing" priority.

Vol/Boost/Mod Source and Amount
Output Bank

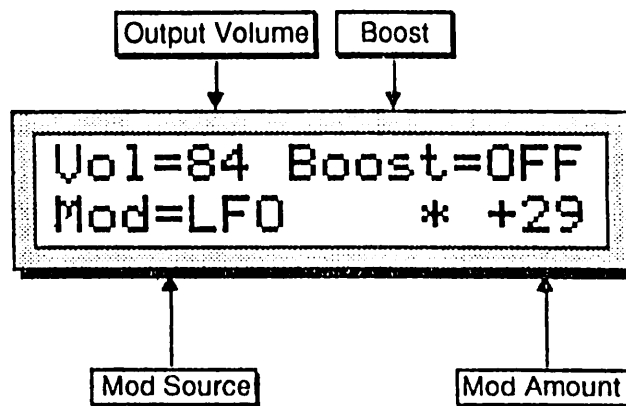

Volume

Voice Volume — Adjusts the overall volume of the voice. This is permanently routed to the volume of the voice, so this parameter could be thought of as Amp Amount.

Range: 00 to 99

Boost

Volume Boost — Setting this parameter to "ON" gives the selected voice a +12 dB boost. Not for the faint of heart.

- ON — A +12 dB boost is added to the selected voice.
- OFF — The voice plays normally.

Mod Source

Volume Modulator — Selects one of the 15 available modulators to affect the volume of the voice. This is in addition to the Amp envelope, which is always routed to volume.

Mod Amount

Volume Modulator Amount — Determines how much the modulator selected above will affect the volume of the voice.

Range: -99 to +99

The two parameters on the lower line of the display provide a powerful tool for shaping the volume of the sound across the keyboard:

KeybdScale/KeyRange
Output Bank

KeybdScale

Keyboard Scale Amount (or Zone) — Can be used to fade the voice in or out between the two keys specified to the right (see below). This is good for doing keyboard crossfades between voices, or for reducing the volume of a particular voice as you go higher up the keyboard. A value of +99 will fade the voice *in* from silence to full level between the low and high keys. A value of -99 will fade the voice *out* from full level to silence between the low and high keys. Intermediate values will scale the voice from full level to an intermediate level.

When set to ZONE, the voice will sound at an even level between the low and high keys. There will be no sound below the low key or above the high key.

KeyRange

Low and High Key — Sets the key range over which the fade-in, fade-out or keyboard zone will occur. When this parameter is selected, notes can be entered from the keyboard (with EditKeyrange=ON in System bank) or using the *Up/Down Arrow* buttons. Select this parameter and play the low key; that note is entered as the low key, and the cursor switches to the high key. Now play the high key; that note is entered as the high key, and the cursor disappears. If you made a mistake, or want to enter a different range of values, just select the parameter again and repeat the process.

Output Bus/Priority
Output Bank

Output Bus

Each voice within a sound can be routed to one of three stereo "busses."
The diagram below shows the routing of the signals for each bus. See the section on "Effects" for more on programming specific effects.

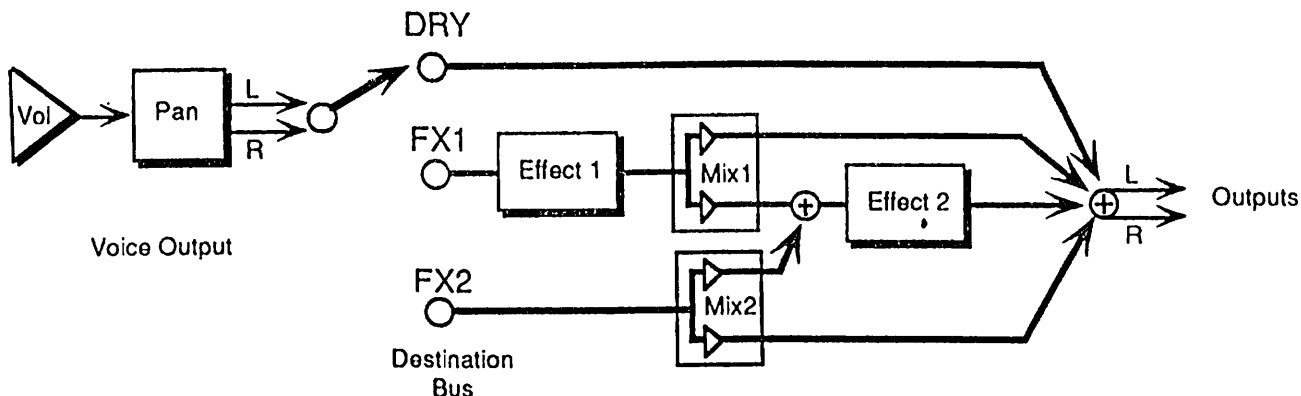

Priority

This parameter gives you some control over how voices will be reassigned, or "stolen," to play new notes when all of the SQ-R's voices are already playing. A voice can be assigned LOW, MEDIUM or HIGH priority. The rule is that a given voice will only be allowed to steal from voices with the same or lower priority.

MEDIUM is the usual state and should be used for most voices. LOW can be used for voices within a sound which would be missed the least if stolen (such as a voice playing the same wave as another voice but detuned a bit). HIGH is best used only for specific applications in which you want to protect a voice or voices from being stolen — such as drums or a sustaining "pad" sound in a sequencer track.

Pan/Vel Window
Output Bank

Pan

Pan Location — Pans the voice within the stereo mix.
Range is from 00 (panned left) to 99 (panned right). A value of 50 pans the voice center.

Vel Window

Selects a key velocity below which, or above which, the voice will not sound. This allows velocity switching between different voices within the sound. The range is from -127 to +127. When the value is +000, the parameter will have no effect. Values from +001 to +127 mean that the voice will only play when the key velocity is *greater* than the number shown. Values from -001 to -127 mean that the voice will only play when the key velocity is *less than* or equal to the number shown.

Section 7 — Drum Programming

- This section covers those functions which can be edited independently for each individual voice within a Drum sound.

SQ-R Drum Sound Configuration	7 - 1
Selecting Drum Sound Editing	7 - 2
Sound Edit Mode	7 - 2
Wave Bank:	
Current Key Number	7 - 3
Low Key/High Key	7 - 3
Creating "Holes" in the Key Map	7 - 3
Wave Class	7 - 5
Wave Name	7 - 5
Direction	7 - 6
Clear Key Map	7 - 6
Set Default Map	7 - 6
Change Sound Mode	7 - 7
Pitch Bank:	
Oct/Semi/Fine (Voice Tune)	7 - 7
Keyboard Pitch Tracking	7 - 7
Filter Bank:	
Filter Cutoff Frequency/Velocity Level Control	7 - 8
Amp Bank:	
Gate Time/Release Time	7 - 9
Velocity Level Control/Mode (Env1 and Env2)	7 - 9
Mode (AMP) — Voice Triggering/Stealing Notes	7 - 10
Output Bank:	
Voice Volume/Volume Boost/Pan Location	7 - 11
Output Bus/Velocity Curve	7 - 12

SQ-R Drum Sound Configuration

As discussed earlier, SQ-R sounds come in two distinct varieties: Standard sounds and Drum sounds. SQ-R Drum sounds differ from Standard sounds in two major areas:

Number of Voices — Standard sounds are made up of three voices. Drum sounds are comprised of 17 separate voices. Each voice can be used as a separate drum or percussion instrument. Drum sounds use only one voice per key.

Voice Architecture — Each of the 17 voices within a SQ-R Drum sound consists of:

- a digital oscillator playing any of the wavesamples from the SQ-R wave memory (except TRANSWAVES and MULTI-WAVE),
- two multi-mode digital filters that are fixed in a 4 pole low pass mode, and
- a set of parameters specific to Drum sounds.

Selecting Drum Sound Editing

Because the SQ-R has two types of sounds, it also has two Sound Edit modes: one which pertains to Standard sound editing and one for editing Drum sounds. In order to create or edit a Drum sound, you must use the Drum edit mode.

There are two methods for entering the Drum edit mode:

- **Change Sound Mode Command** — This is the standard method for switching sound edit modes. Located in both Standard sound edit mode and Drum sound edit modes, this command allows access into the other sound edit mode. The Change Sound Mode command is located in the Wave banks of both Sound Edit modes.
- **Selecting Sounds** — A second method for sound mode hopping is the simple process of selecting sounds. The currently selected sound determines the sound edit mode. You can enter the Drum edit mode by selecting a drum sound, then pressing the *Edit Sound* button.

Sound Edit Mode

Whenever you want to do any editing to a sound you must first place the SQ-R into Sound Edit Mode. This is accomplished by pressing the *Edit Sound* button. Once in Sound Edit Mode you can modify parameters of a sound to better suit your needs or create a completely new sound.

The parameters in Drum Sound Edit Mode are arranged into five **Banks**. Each Bank contains a series of **Screens** that feature one or more editable parameters.

Holding down the *Bank Select* button displays the name of the current bank while the button is held, returning to the previous display once the button has been released. If the *Up* or *Down Arrow* buttons are pressed while the *Bank Select* is held, the previous or next bank within that mode will be displayed and selected.

Additionally, once within in a particular bank, holding down the *Bank Select* button and pressing the *Left* or *Right Arrow* button takes you through the individual screens within that bank.

Wave Bank

In the Wave Bank you can choose which wave the currently selected voice will play, and modify various playback parameters of the wave.

Current Key Number/Key Range/Wave Name
Wave Bank

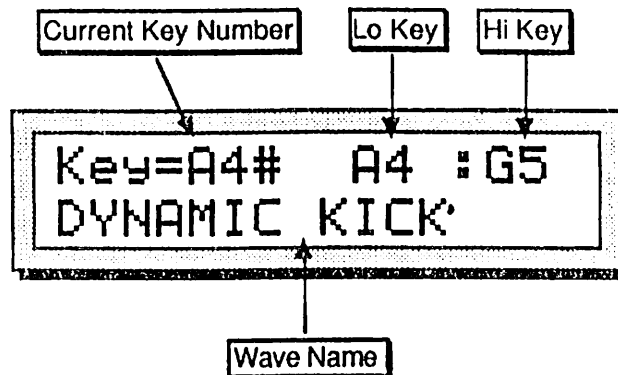

Current Key Number

This parameter is used to select each of the 17 voices for editing.

Select a Standard sound then use the Change Sound Mode command to enter Drum sound Edit mode (for information on the Change Sound Mode command, see "Change Sound Mode" later in this section). This will place the default drum map into the edit buffer. Take a moment now to play each key from your MIDI keyboard. You'll notice that each time you play a new key, the current key number changes. However, the key range parameters (Low Key and High Key) and the wave name change every several keys. If you count, you'll discover that there are 17 of these changes, corresponding to the 17 voices.

By playing keys on the keyboard, you are selecting a voice to be edited. You can then select a waveform, define a key range and tailor the voice to suit your needs.

Low Key/High Key

The Low and High key parameters work together to form a *key range*, which is the term used to describe the range of notes within which a particular voice will play.

After selecting this parameter, you can set the key range by simply playing the notes on the keyboard where you want the low and high keys to be located, provided the EditKeyrange parameter in the System bank is set to "ON.". (Low Note is set first, followed by High Note).

Creating "Holes" in the Key Map

It is possible, when setting the key range for a particular voice, for that voice to "cover up" one or more other voices. This would occur if the key range of one voice extended over the entire area of another voice's key range. The result would be something like this:

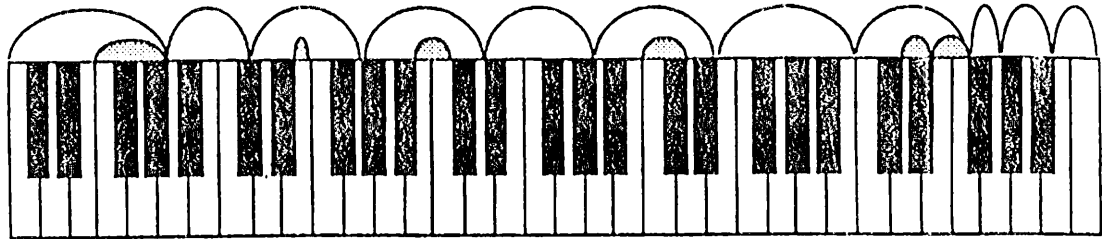

As you can see, the 11 voices defined cover the entire range of the standard 61-note keyboard. This has the effect of "covering up" the remaining six voices (shown in shading).

Now, suppose you wanted to add another voice to the sound (you've discovered you just can't live without tambourine). In order to make another voice available for the tambourine waveform, you must:

- First, select a key in the range where you'd like the tambourine to be placed. For this example, we'll choose F6.

Next, you'll need to "create a hole" in the sound's keymap on that particular key.

- Select the voice that currently occupies the F6 key (by playing the F6 key) and reset its key range to where the Low Key is above F6. Because you are not placing additional voices above F6 you can reset the High Key to its original value.

This will have the effect of creating a hole in the key map at F6, since there are no longer any voices with key ranges that cover F6.

- Play the F6 key to select its voice. You'll see the display read:

```

Key=???  F#6:G6
ANVIL HIT
  
```

Pressing the key has the effect of selecting the "covered" voices and bringing them into the newly created hole. If there is more than one voice covered (as there is in our example), repeatedly pressing the key where the hole has been created will select each of the covered voices in rotation.

The question marks in the key value indicate that there is no voice *defined* to that key.

- To complete the process, define a key range for the voice and it will become a permanent voice in the sound. You can then select which wave the voice will play and make other edits, just as you would with any of the voices.

Wave Class/Wave Name
Wave Bank

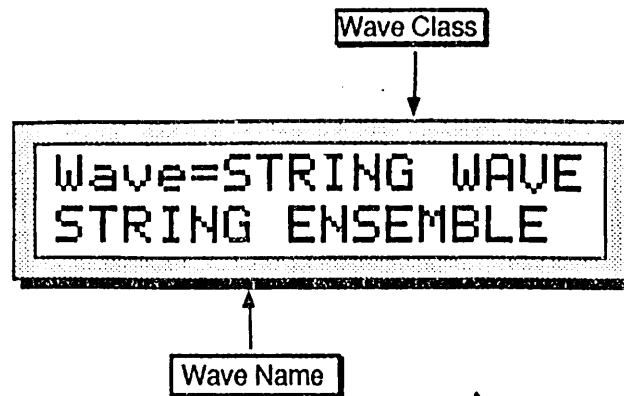

Wave Class

This parameter determines the class of waveforms which will be used for a particular voice. By selecting this parameter, you can use the *Up/Down Arrow* buttons to scroll quickly through the different wave classes to the category you want. Then select the wave name to choose a specific wave from that category.

Whenever the wave class is changed, the first wave in that class is selected, and lower-line parameters are reset to the default values of the new wave class.

The SQ-R waves are divided into 11 categories, or *Wave Classes*:

These wave classes contain samples of real acoustic and electronic sounds, which can be used as the basis for a wide variety of realistic musical sounds. Where necessary, these waves have been *multisampled* (sampled at many points through the range of the instrument) for maximum authenticity in reproducing the original.

(A descriptive list of Wave Classes can be found in the preceding section on Standard sound programming).

Note: Waves found in the TRANSWAVE and MULTI-WAVE categories cannot be selected as voices for Drum sounds.

Wave Name

Here you select the actual wave which the voice will play. When this parameter is underlined, pressing the *Up/Down Arrow* buttons will scroll through the individual waveforms within the selected wave class, then cross over into the next class.

(A chart showing the complete list of waves available can be found in the preceding section on Standard sound programming.)

Direction
Wave Bank

Direction

This parameter determines the direction a wave will play, either Forward or Backward.

Waves found within the WAVEFORM and INHARMONIC wave classes are based upon loops and therefore have a fixed direction. When one of these waves is selected, this parameter will not appear on the screen.

Clear Key Map
Wave Bank

Clear Key Map

This command erases the key map currently residing in the edit buffer, setting all the voices to a key range of A0-A0. You can press the *Enter/Save* button to activate the command. Use this command when you want to discard the drum voice key map that you've been working on and start over from scratch.

Set Default Map
Wave Bank

Set Default Map

This command clears out whatever sound is residing in the edit buffer and replaces it with the default key map settings and parameters. The illustration below shows the default map settings:

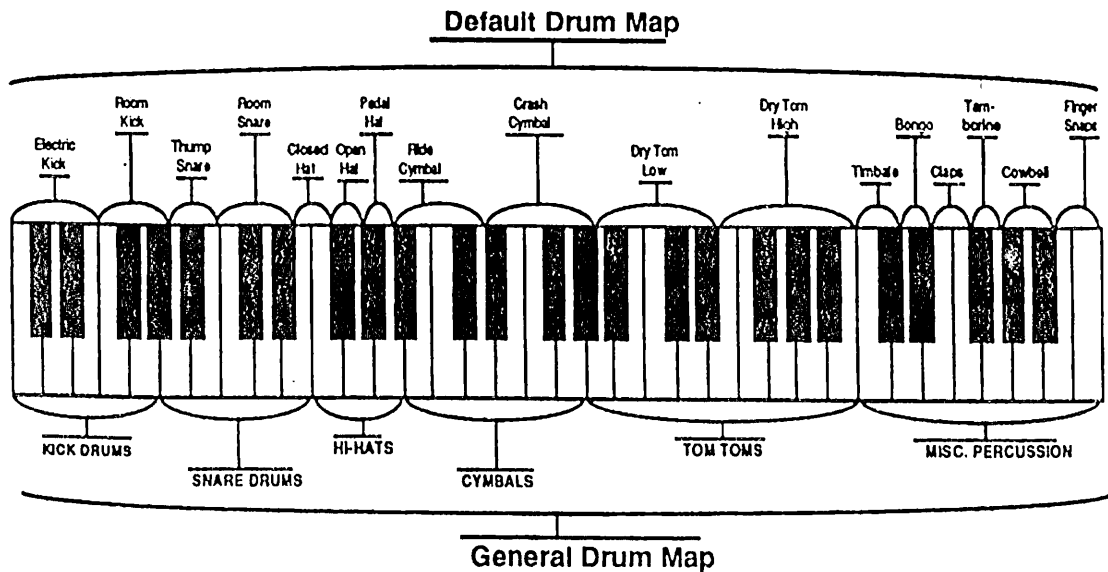

Change SoundMode

Wave Bank

Change SoundMode

Press *Enter/Save* to switch the current sound mode. When working in Drum sound mode, this command will place the default Standard sound into the edit buffer and place the SQ-R into Standard sound mode.

Pitch Bank

In the Pitch bank you set the "manual" levels for the pitch of the voice, and select whether the pitch will be tracked by the keyboard.

Oct/Semi/Fine (Voice Tune)

Pitch Bank

Oct

Changes the pitch of the voice by octaves.

Range: -4 to +4 octaves

Semi

Changes the pitch of the voice by semitones. Incrementing/decrementing this control beyond +11 or -11 automatically increases/decreases the octave by one.

Fine

Changes the pitch of the voice by steps of one cent (1/100 of a semitone).

Range: -99 to +99

Keyboard Pitch Tracking

Pitch Bank

Keyboard Pitch Tracking

Determines whether or not the pitch of the selected voice will change across the keyboard or remain static at C4.

- ON — The pitch of a voice tracks with the keyboard.
- OFF — All keys play at the same pitch; C4.

Filter Bank

The filter settings determine which ranges of frequencies will be allowed to pass through to the output. Drum sounds always have a fixed 4 pole low pass filter. See the Filter Bank description in the Standard sound programming section for further details.

Fc Cutoff/LevV
Filter Bank

Fc Cutoff

Filter Cutoff Frequency — Determines the initial, or manual, filter cutoff frequency. A setting of 127 lets all the original signal pass through the filter. Lower settings lower the cutoff frequency, somewhat like turning down the treble on a stereo.

Range: 000 to 127

LevV

Velocity Level Control — The Velocity level parameter will lower all filter cutoffs with a softer keystroke. This means that the setting you assign to Fc Cutoff is the maximum level, the level that will be reached with the hardest keystroke. The amount of "LevV" will determine how much that level will be reduced as you play softer. With this parameter you can have continuous dynamic control over the filter cutoff by varying how hard you play.

Range: 00 to 99

Amp Bank

In the Amp bank you control the volume of the individual voices within a drum sound.

Gate Time/Release Time
Amp Bank

Gate Time

Determines the amount of time the envelope stays at full level before entering the release stage.

Range: 00 to 99

Note: This parameter pertains to FINISH mode only.

Release Time

In NORMAL mode, this defines the time it will take the envelope to return to zero after the key has been released. When in FINISH mode, this controls the amount of time it takes for a voice to return to zero after the Gate Time.

Range: 00 to 99

LevV/Mode
Amp Bank

LevV

Velocity Level Control — The Velocity level parameter will lower the volume with a softer keystrike. This means that the settings you assign to Voice Volume is the maximum level, the level that will be reached with the hardest keystrike. The amount of "LevV" will determine how much that level will be reduced as you play softer. With this parameter you can have continuous dynamic control over the volume by varying how hard you play. Changing the Velocity Curve (VelCurv) gives you further control over the velocity response of the envelope.

Range: 00 to 99

Mode — (ENV 1 and ENV 2)

- NORMAL — The envelope plays through normally, as shown in the diagram on the following page.
- FINISH — The envelope runs its full cycle, ignoring the key-up event. The envelope waits to enter the release stage until the Gate Time is finished, instead of stopping as soon as the key is released. This is good for percussive-type sounds where you want the envelope to be the same for every note, no matter how long the key is held down.

MODE (AMP) — Voice Triggering/Stealing Notes

In NORMAL mode, if you set a delay on the voice, and you release the key before the designated delay time elapses, the voice will not sound.

In FINISH mode, if you set a delay on the voice and you release the key before the designated delay time elapses, the note will sound anyway. The envelope finishes what you set it up to do.

In order to maximize the use of the SQ-R's 21 voices, and to manage the "voice stealing" it is sometimes useful to understand when a given voice will be assigned and when it will be released, or "put back" into the pool for use by other sounds. This depends on a combination of envelope mode and the wave type. A looped (sustaining) wave will continue to use the voice until the envelope reaches zero. For a sustaining wave, when the Envelope Mode is Normal:

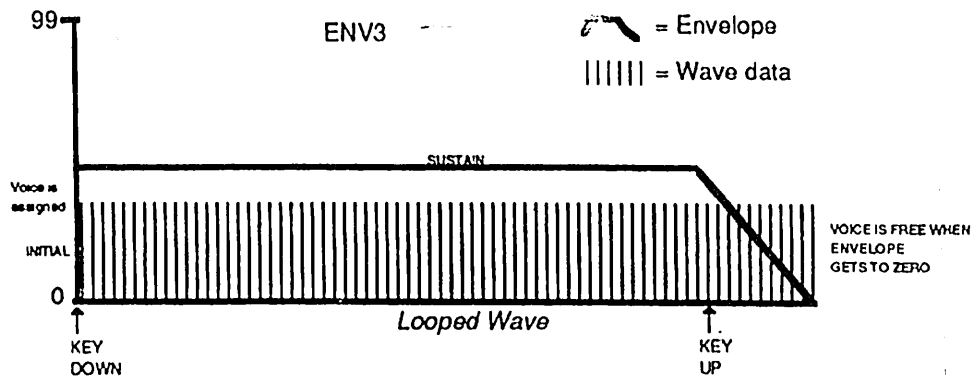

For a sustaining wave, when the Envelope Mode is set to Finish:

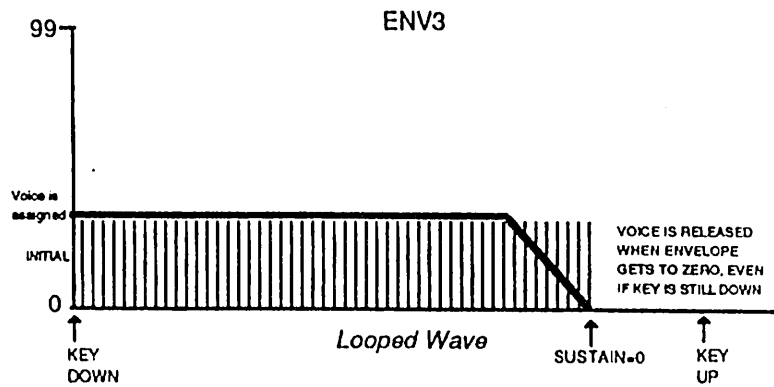

For unlooped, non-sustaining, waves (specifically those in the Percussion and Drum categories) the voice becomes free as soon as the sample has played through to the end, no matter where the envelope level is. The voice is released for use by another sound:

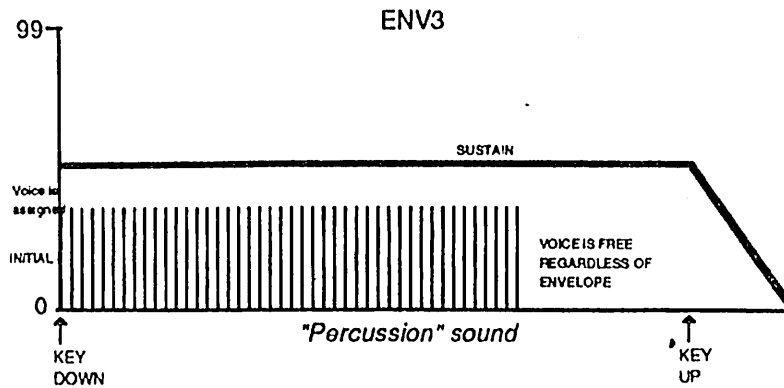

Output Bank

The parameters in the Output Bank regulate the overall volume and panning of the voice.

Volume/Boost/Pan
Output Bank

Volume

Voice Volume — Adjusts the overall volume of the voice. Since Envelope 3 is permanently routed to the volume of the voice, this parameter could also be thought of as Env 3 Amount.

Range: 00 to 99

Boost

Volume Boost — Setting this parameter to "ON" gives the selected voice a +12 dB boost. Not for the faint of heart.

- ON — A +12 dB boost is added to the selected voice.
- OFF — The voice plays normally.

Pan

Pan Location — Pans the voice within the stereo mix.

Range is from -98 (panned left) to +99 (panned right). A value of 00 pans the voice center.

Output Bus/VelCurv
Output Bank

Output Bus

Each voice within a sound can be routed to one of three stereo "busses." The diagram below shows the general routing of the signals for each bus. See the section on "Effects" for more on programming specific effects.

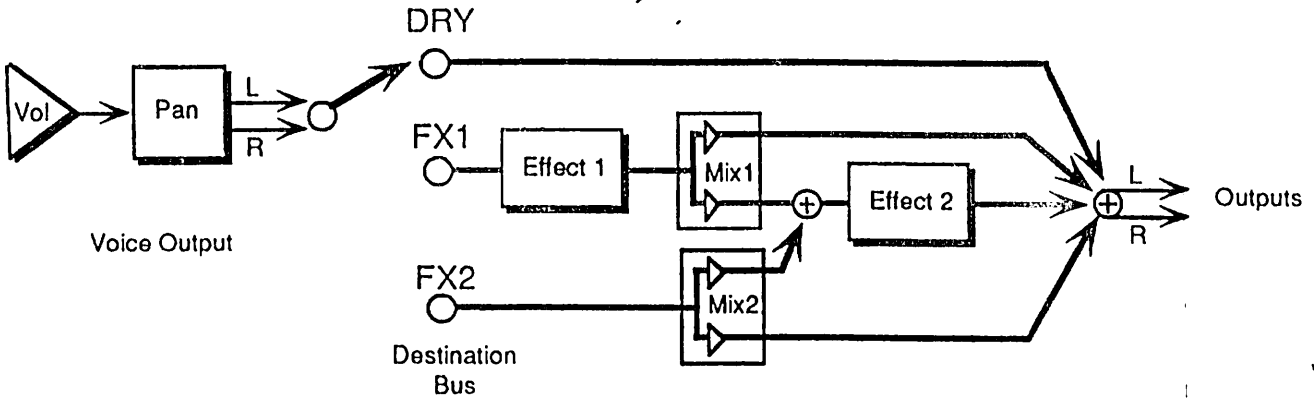

VelCurv

This selects which of the four available velocity response curves the envelope will use if the velocity level control (LevV above) is set to some value other than zero. Available values are: QUIKRISE; CONVEX; LINEAR, and CONCAVE.

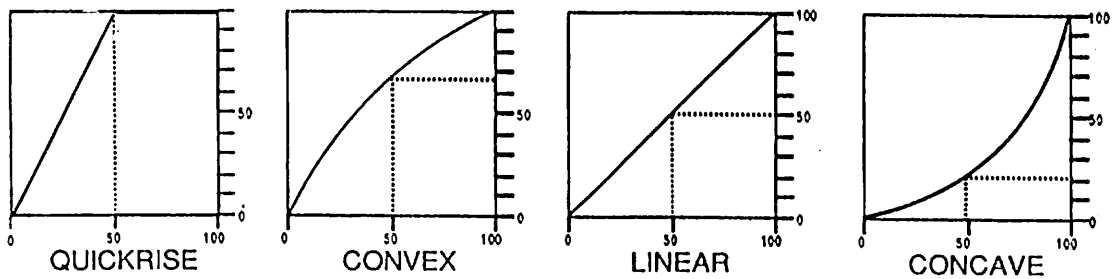

Section 8 — Storage Functions

The Storage functions on the SQ-R found in the System Bank enable you to:

- transfer Sounds or Preset data to or from SQ-R-compatible memory cards, and
- transmit dumps containing Sounds or Preset data via MIDI system exclusive messages.

Memory Card Storage:

Installing the Battery in a RAM Card	8 - 1
Memory Card Configurations	8 - 2
Formatting a Blank Memory Card	8 - 3
Copying Sounds between Internal and Card Memory	8 - 3
Sound Storage Prompts and Error Messages	8 - 4
Saving Preset Data to Memory Card	8 - 5
Preset Storage Prompts and Error Messages	8 - 6

MIDI Sys-Ex:

Sending MIDI Sys-Ex Messages to another SQ-R or to a Storage Device	8 - 7
Sending One or All Sounds out via MIDI Sys-Ex	8 - 7
Sending Presets out via MIDI Sys-Ex	8 - 8
Receiving MIDI Sys-Ex Messages	8 - 8

SQ-R/SQ-1 Storage Compatibility	8 - 9
---	-------

Memory Card Storage

The SQ-R uses credit-card-type memory cards for sound and preset storage.

Only ENSONIQ memory cards, or cards approved by ENSONIQ, can be used with the SQ-R. Similar memory cards sold for use with other manufacturers' products may be incompatible with the SQ-R, and may cause damage to the card or to the SQ-R itself.

Installing the Battery in a RAM Card

To maximize battery life, MC-32 and MC-64 RAM Cards are shipped with the battery not installed. Before using these cards, you must first install the battery, following the instructions below.

1. Using the supplied screwdriver, loosen the battery-drawer screw. Do not try to remove the screw; it remains attached to the battery drawer.
2. Pull gently on the plastic tab at the top of the card to open the battery drawer to the position shown at the far right. (Do not try to pull it out any further.)
3. Insert the Battery in the Battery Drawer with the flat (+) side of the battery facing up.
4. Slide the the battery drawer closed.
5. Retighten the battery drawer screw to lock the battery drawer.

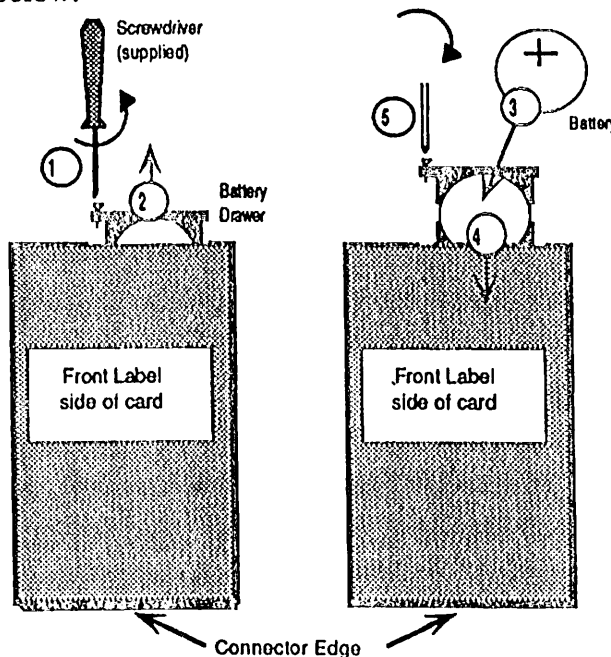

Memory Card Configurations

ENSONIQ MC-32 and MC-64 RAM Cards can be used to store up to two banks of sounds (which we refer to as CARD A and CARD B) and/or preset data.

There are a number of different ways that a memory card can be configured, depending on which size card it is, and what type of data is stored to the card first. The drawing below shows the possible configurations for the two types of cards:

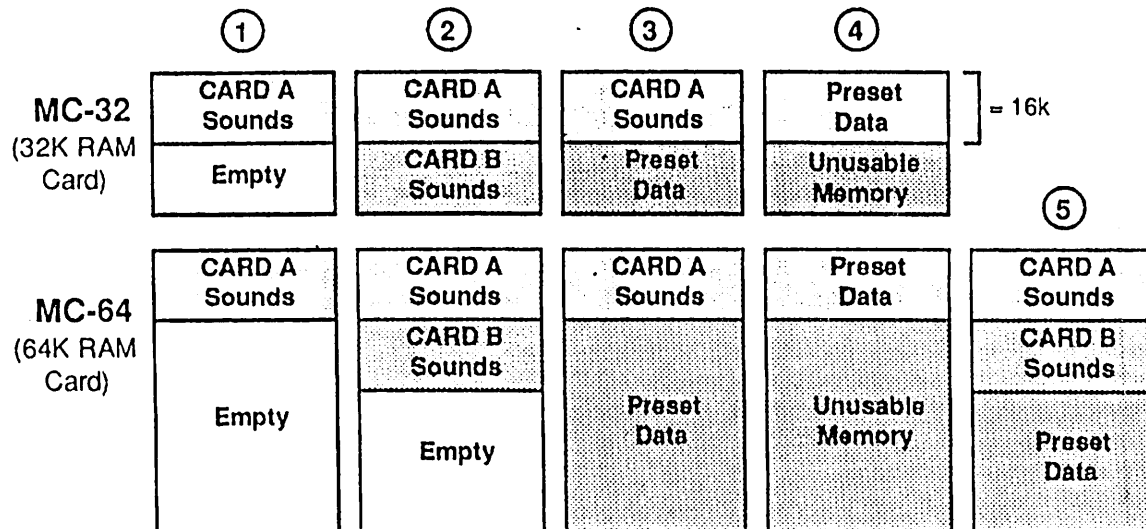

Possible RAM Card Configurations

- Starting from a blank memory card, copying the internal sounds (INT) to CARD A (described later in this section) will format the card, and will put 80 sounds in CARD A, leaving the rest of the card memory empty, as shown in Configuration 1 above.
- Once you have copied sounds into CARD A, you can copy another bank of sounds to CARD B (Configuration 2) or you can save the internal preset memory to the card (Configuration 3).
- Starting from a blank memory card, saving the internal preset memory to the card (described later in this section) will format the card, but will leave the remaining memory unusable, as neither sounds nor additional preset memory can be saved. Obviously, this is not recommended. (Configuration 4)
- Additionally, with an MC-64 only, it is possible to copy sounds to both CARD A and CARD B and still have 32K of additional card memory for preset storage (Configuration 5).

Important:

The amount of the card memory allocated to preset storage depends on what portion of the card is empty, or unused, at the time you first save presets to the card. That is, when you save presets to the card, the SQ-R will allocate all available card memory for preset storage. Thus, if you want to use the entire card memory (either an MC-32 or MC-64) for presets, be sure not to store any sounds to the card. If there are sounds already on the card, you can erase them by removing the battery for approximately 1 minute, then replacing it.

It is also important to note that sounds stored to a RAM card can be played directly from the cartridge, while preset data stored to the card must be transferred to the internal preset memory before it can be used.

Formatting a Blank Memory Card

When you first install the battery in a RAM card, the card will not be recognized by the SQ-R until it is formatted. *Formatting a card is done by simply storing a sound bank or preset data to the card.* With a new card, you first decide whether you want to use it to store sounds, presets or both (see the note on the previous page) and then format it, either by copying the internal sounds to Card A, or by saving the internal preset memory to the card.

SOUNDS

Copying Sounds Between Internal and Card Memory

The functions described here are used to do "bulk copies" of the 80 INT sounds to the memory card, or vice-versa. Also, as noted above, it is necessary to copy the internal sounds to Card A before the card can be used to store sounds at all. If you wish to copy a single sound to a different location, use instead the procedure described in Section 5.

To Copy sound banks between Internal and Card memory:

- Press the *System* button.
- Press the *Right Arrow* or *System* button repeatedly until the display reads:



Press ENTER to
Store Sounds

- Press *Enter/Save*. The display now lets you choose which type of storage to use.
- Use the *Up/Down Arrow* buttons to select "Storage Type=MEMORY CARD," as shown below:

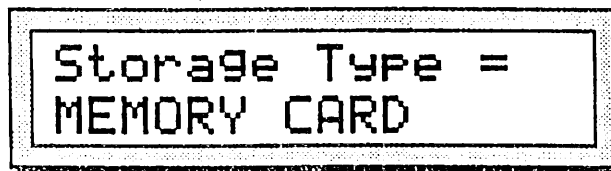

Storage Type =
MEMORY CARD

- Press *Enter/Save*. The display now offers four choices:
 - "Operation = COPY INT TO CARD A" — this command copies the entire contents of the eight INT Sound Banks (0-7) to CARD A.
 - "Operation = COPY INT TO CARD B" — this command copies the entire contents of the eight INT Sound Banks (0-7) to CARD B.
 - "Operation = COPY CARD A TO INT" — this command copies the entire contents of the eight CARD A Sound Banks (0-7) to the Internal (INT) memory.
 - "Operation = COPY CARD B TO INT" — this command copies the entire contents of the eight CARD B Sound Banks (0-7) to the Internal (INT) memory.

- Once you have selected the operation you want from the four options above, press *Enter/Save*.
- If the card was blank or unformatted and you chose COPY INT TO CARD A, the display asks "Card is wrong type, erase?" Press *Yes*.
- The copy function is almost instantaneous. The display will read "Command Successful" after the sounds have been copied.

Sound Storage Prompts and Error Messages

- "Sorry! Install a RAM Card First." — You will get this message if you attempt to copy INT TO CARD A or INT TO CARD B when there is no card installed, or when a ROM (Read Only Memory) card is installed.
- "Sorry! Install a Card First." — You will get this message if you attempt to copy CARD A TO INT or CARD B TO INT when there is no card installed.
- "Sorry! Write to Card A first." — You will get this message if you attempt to copy INT TO CARD B before you have copied sounds to CARD A. CARD A must be written before you can copy sounds to CARD B.
- "Sorry! Card B is empty." You will get this message if you attempt to copy CARD B TO INT when the card is formatted but does not contain sound data in Card B.
- "Erase preset data on card?" If you attempt to copy INT TO CARD B with a card which already has preset data stored in the area normally occupied by Card B sounds, you will get this message. Press *Yes* to proceed, or *No* to cancel the command.
- "Sorry, write to card failed." — This message will appear whenever the SQ-R fails to verify data that it has written to the card. It could mean that the card is a ROM card and cannot be written. It might also mean that the card is write-protected or possibly defective.
- "WARNING! Battery low. See manual." — If this message appears when a RAM card is inserted into the card slot, it means that the battery in the card is getting low and should be replaced as soon as possible. To replace the battery, you can use essentially the same procedure outlined earlier in this section under "Installing the Battery in a RAM Card." Also, if you replace the battery *while the card is plugged into the SQ-R, with the SQ-R power on*, you will not lose the data stored on the card. This will not harm the card or the SQ-R. (Make sure, though, that you do not turn off the SQ-R's power while the card is installed with the battery removed, or any data on the card *will* be lost.)

PRESETS**Saving Preset Data to Memory Card**

You can save the contents of the SQ-R preset memory to a MC-32 or MC-64 RAM card.

To Copy sound banks between Internal and Card memory:

- Press the *System* button.
- Press the *Right Arrow* or *System* button repeatedly until the display reads:



```
Press ENTER to
Store Presets
```

- Press *Enter/Save*. The display now lets you choose which type of storage to use.
- Use the *Up/Down Arrow* buttons to select "Storage Type=MEMORY CARD," as shown below:



```
Storage Type =
MEMORY CARD
```

- Press *Enter/Save*. The display now offers two choices:
- "Operation = COPY ALL TO CARD" — this command will copy the entire contents of the SQ-R preset memory to the RAM Card. This is the proper choice when you want to save, or "back up" your presets to the card.
- "Operation = COPY ALL FROM CARD" — this command will copy preset data from the card into the internal preset memory. This is the proper choice when you want to reload data previously saved to the card.
- Once you have selected either COPY ALL TO CARD or COPY ALL FROM CARD, press *Enter/Save*.
- The copy function is almost instantaneous. The display will read "Command Successful" after the preset data have been copied.

Preset Storage Prompts and Error Messages

- "Sorry! Install a RAM card first." — You will get this message if you attempt to copy ALL TO CARD when there is no card installed, or when a ROM (Read Only Memory) card is installed.
- "Sorry! Install a Pset card first." — You will get this message if you attempt to copy ALL FROM CARD when the card installed is unformatted or contains only sound data, or there is no card installed.
- "Erase Sound data on Card B?" — This prompt occurs whenever you attempt to store preset data to a card which already contains sounds in Card B. Answer *Yes* to erase the sounds stored in Card B and use that memory for preset storage. If you answer *No*, the SQ-R will use the remaining space (MC-64 only) for preset storage.

For example, with an MC-32, if both Card A and Card B contain sounds, and you get you this message, answering *Yes* will erase the sounds stored in Card B and replace them with preset data. Answering *No* will effectively cancel the command.

With an MC-64, if both Card A and Card B contain sounds, and you get you this message, answering *Yes* will erase the sounds stored in Card B and allocate a full 48k bytes for preset storage (see Configuration 3 on p. 8-2). Answering *No* will leave the Card B sounds intact and allocate the remaining 32k of card memory for preset storage.

- "Sorry, write to card failed." — This message will appear whenever the SQ-R fails to verify data that it has written to the card. It could mean that the card is a ROM card and cannot be written. It might also mean that the card is write-protected or possibly defective.
- "Sorry, need more space on card." — This prompt means that the amount of data in the preset memory exceeds the available memory in the card. If you get this message, you could erase some presets, erase any sound data already stored on the card (by removing the battery), get a larger card, or use a different form of storage, such as MIDI Sys-Ex, described later in this section.
- "WARNING! Battery low. See manual." — If this message appears when a RAM card is inserted into the card slot, it means that the battery in the card is getting low and should be replaced as soon as possible. To replace the battery, you can use essentially the same procedure outlined earlier in this section under "Installing the Battery in a RAM Card." Also, if you replace the battery *while the card is plugged into the SQ-R, with the SQ-R power on*, you will not lose the data stored on the card. This will not harm the card or the SQ-R. (Make sure, though, that you do not turn off the SQ-1's power while the card is installed with the battery removed, or any data on the card *will* be lost.)

MIDI SYS-EX Storage

Sending MIDI Sys-Ex Messages to Another SQ-R or to a Storage Device

The SQ-R is able to send system exclusive dumps of Sounds, either singly or in banks, as well as preset dumps containing either the entire preset memory or the current preset. These dumps can be understood by another SQ-R, or can be recorded by a remote device which has MIDI Sys-Ex Recorder capabilities (such as the ENSONIQ EPS or VFX^{SD}), to be stored and later re-transmitted to the SQ-R.

Banks of sounds are always transmitted from the internal RAM memory (INT). If you want to send card data, use the Sound Storage function to transfer data from the card into the internal RAM first.

SOUNDS

Sending One or All Sounds out via MIDI Sys-Ex

- Press the *System* button.
- Press the *Right Arrow* or *System* button repeatedly until the display reads:



Press ENTER to
Store Sounds

- Press *Enter/Save*. The display now lets you choose which type of storage to use.
- Use the *Up/Down Arrow* buttons to select "Storage Type=MIDI SYS-EX," as shown below:

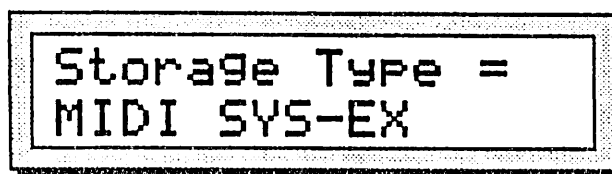

Storage Type =
MIDI SYS-EX

- Press *Enter/Save*. The display now offers two choices:
- "Operation = SAVE INT TO MIDI" — this command transmits the entire contents of the eight Internal Sound Banks (0-7) as a system exclusive message. The dump contains data for the complete set of 80 Sounds.
- "Operation = SAVE SOUND TO MIDI" — this command will transmit the currently selected sound as a system exclusive message. The sound to be transmitted can be in any bank, including the INT, ROM, CARD A or CARD B banks.
- Once you have selected either SAVE INT TO MIDI or SAVE SOUND TO MIDI, press *Enter/Save*. The display will read "Please wait . . . sending data" while the sounds are being transmitted.

PRESET DATA**Sending Presets out via MIDI Sys-Ex**

- Press the *System* button.
- Press the *Right Arrow* or *System* button repeatedly until the display reads:



Press ENTER to
Store Presets

- Press *Enter/Save*. The display now lets you choose which type of storage to use.
- Use the *Up/Down Arrow* buttons to select "Storage Type=MIDI SYS-EX," as shown below:

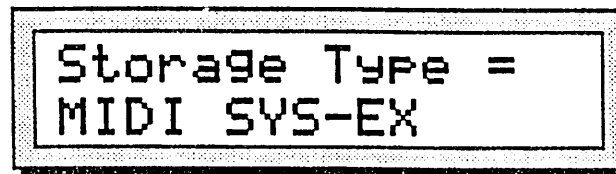

Storage Type =
MIDI SYS-EX

- Press *Enter/Save*. The display now offers two choices:
- "Operation = SAVE CURRENT PRESET" — this command will transmit the currently selected preset as a system exclusive message.
- "Operation = SAVE ALL PRESETS" — this command will transmit the entire contents of the preset memory as a system exclusive message. The dump contains data for the complete set of 80 preset locations.
- Once you have selected SAVE ALL PRESETS, press *Enter/Save*. The display will read "Please wait . . . sending data" while the sounds are being transmitted.

Receiving MIDI Sys-Ex Messages

The receiving of data dumps is initiated automatically by system exclusive messages sent from the transmitting unit. No front-panel commands are necessary to receive dumps if the receiving of System Exclusive messages is enabled on the System bank (System Excl=ON).

When a single-sound message is received, three things happen:

- the display briefly says "Press ENTER to save new sound,"
- the new sound is placed in the edit buffer, and
- the SQ-R enters Sound Edit mode, with the *Edit Sounds* LED flashing, so that you can hear, edit and/or save the new sound which has been received.

When a one-preset message is received, three things happen:

- the display briefly says "Press ENTER to save new preset,"
- the new preset becomes the edit preset, and
- the SQ-R enters Preset Select mode, with the *Edit Preset* LED flashing, so that you can hear, edit and/or save the new preset which has been received.

SQ-R/SQ-1 Storage Compatibility

The SQ-R is related directly to the SQ-1; a keyboard version of the SQ-R featuring a built-in 16 track sequencer. The sounds on both instruments are identical in format, and are completely compatible. However, there are some minor differences in the way each instrument stores preset/sequencer data to memory card. Because of this, there is not 100% storage compatibility between them. Use the following guidelines to determine if the storage transfer function you wish to perform will be compatible or not.

MIDI SYSTEM-EXCLUSIVE

All System Exclusive data transfers are functional and compatible between the SQ-R and SQ-1:

- Sound data can be sent via Sys-Ex from an SQ-R to an SQ-1.
- Sound data can be received via Sys-Ex from an SQ-1 to an SQ-R.
- Preset data can be sent via Sys-Ex from an SQ-R to an SQ-1. Once in the SQ-1, track data can be added to these presets, becoming sequences.
- Sequence data can be received via Sys-Ex from an SQ-1 to an SQ-R. When received, the SQ-R ignores all track data, leaving the preset information.

MEMORY CARD

Most data saved to card on either the SQ-R or SQ-1 can be read and understood by the other. There is one exception, listed below:

- Sound data can be saved to a memory card from an SQ-R and read by an SQ-1.
- Sound data can be saved to a memory card from an SQ-1 and read by an SQ-R.
- Sequence data can be saved to a memory card from an SQ-1 and read by an SQ-R. When the data is loaded from the card, the SQ-R ignores all track data, leaving the preset information.
- *Preset data that is saved to a memory card from an SQ-R cannot be read by an SQ-1.*

If you wish to send preset information from an SQ-R to an SQ-1 (to be used as the basis for sequencing, or on its own), use the Sys-Ex transfer methods described earlier in this section.

- AC line conditioning:
1-2
- Accessories:
1-14
- ADSR:
6-17
- AMP:
1-4, 9; 4-5, 19
6-1, 4, 16, 17, 21,
31, 32
7-1, 9, 10
- Amplification:
1-4
- Attack:
6-12, 17 to 20
- Bank:
1-1, 6 to 10, 12
2-1, 2, 7
3-1, 2, 6 to 12, 15,
16, 19, 20, 21
4-2 to 7, 18; 5-1, 4
6-1, 3, 5, 6, 8, 15,
17, 24, 27, 31,
32
7-1, 2, 3, 7, 8, 9,
11
8-1, 3, 4, 8, 9
- Bank Select Button:
1-6 to 9; 3-7, 15
6-3, 8; 7-2
- Battery:
1-1, 14
8-1, 3, 4, 5, 7
- Bend range:
2-2
- Boost:
4-11; 6-31; 7-1, 11
- Breakpoint:
6-18
- Bus:
3-16
4-1 to 4, 6, 14, 20
6-1, 33; 7-1, 12
- Card Sounds:
3-6; 8-4
- Cards:
1-12, 13, 14
8-1, 3; i-1
- Change Sound Mode:
6-14; 7-2, 3
- Changing a Parameter:
10
- Chorus&Reverb:
4-1, 4, 5, 10, 11,
12, 14 to 20
- Clear Key Map:
7-6
- Combined Effects:
4-1, 14
- Compare:
3-3; 5-1, 2
- Concert Reverb:
4-5, 10
- Connections:
1-1 to 5, 3-18
- Controllers:
2-1, 3 to 6
3-10, 12
4-1, 6; 6-6
- Controllers Routed to
Effects:
4-6
- Copy Preset Data:
8-6
- Copying an Existing
Sound to Another
Location:
3-4, 5-4
- Creating "Holes" in the
Key Map:
7-3
- Current Key Number:
7-3
- Cutoff Frequency:
2-5
6-4, 6, 17, 27, 29,
30
7-1, 8
- CV Pedal:
1-5, 4-7, 6-6
- CV Pedal Input:
4-7
- CV Pedal:
1-5; 4-7; 6-6
- Delay:
3-6
4-3, 12, 14, 18, 19
6-1, 12, 21, 25
7-10; i-1
- Delay Time:
4-12, 14, 18, 19
6-1, 12, 21; 7-10
- Direction:
4-17; 6-4, 12; 7-6
- Drum Edit Mode:
7-2
- Drum Sound Mode:
6-14; 7-7
- Drum Sounds:
1-12; 5-1; 6-7, 10
7-1, 2, 5, 8
- DRY:
3-6, 16
4-2, 3, 4, 6, 12, 14
- Edit Buffer:
3-3, 4
5-2, 3, 4; 6-14
7-3, 6, 7; 8-9
- Edit:
1-1, 6 to 11, 13, 14
2-1, 2
3-3, 4, 5, 6, 8, 20
4-2, 6
5-1, 2, 3, 4
6-1, 3, 8, 9, 14
7-1, 2, 3, 6, 7
8-9; i-1
- Edit Sound Button:
1-7; 5-1, 2, 3; 7-2
- Edit Track Button:
1-6, 7; 3-5, 8
- Editing Presets:
1-6; 3-2
- Effect Modulators:
4-7, 17
- Effects Busses:
4-3
- Effects:
1-1, 6, 8, 12; 2-4
3-1, 6, 7, 16, 20,
21
4-1 to 7, 10, 14
5-1
6-3, 4, 10, 15, 21,
24, 26, 31, 33
7-12; i-1
- Effects Mixing:
4-4
- Env2:
6-1, 31; 7-1
- Envelope 1:
6-3, 4, 15
- Envelope 2:
6-4, 29, 30
- Envelope Level:
6-19, 22; 7-11

- Envelope Mode:
6-21, 22; 7-10
- Envelope Times:
6-19, 22
- FC1 Keyboard:
6-29
- FC2 Keyboard:
6-1, 30
- Filter Configurations:
6-28
- Filter:
2-5; 3-16; 4-11
6-1, 2, 4, 6, 17, 27
to 31
7-1, 8
- Front Panel:
1-1, 6, 9, 10
2-4, 8; 3-19
- FX1 and FX2:
4-3, 4, 10
- Gate Time:
7-1, 9
- Glide:
6-1, 16
- Glide Time:
6-16
- Global Bend:
2-2
- Global Controllers:
2-1, 4
- Hall Reverb:
4-5, 10
- Home Stereo:
1-1, 4
- Installing the Battery
in a RAM Card:
8-1, 5, 7
- Internal Sounds:
1-13; 5-3; 8-3, 4
- Key Range:
2-2, 3-6, 9, 14, 18
6-32; 7-3, 4, 6
- Keyboard:
1-3, 4, 13, 15
2-2, 4, 5
3-5, 6, 9, 13, 14,
18
4-7
6-1, 4, 5, 6, 16, 20,
22, 29 to 32
7-1, 3, 4, 7; 8-10.
- Keyboard Pitch
Tracking:
6-16; 7-7
- Keyboard Scale
Amount:
6-1, 32
- Keyboard Tracking:
6-4, 5, 22
- Layering Sounds:
3-1, 6
- Legato:
6-16
- Level Control:
6-20; 7-1, 8, 9, 12
- LFO Bank:
6-1, 24
- LFO Delay:
6-25
- LFO Level:
6-6, 25
- LFO:
3-16; 4-10, 15, 17
6-1 to 4, 6, 15, 24
to 27
- LFO Speed:
6-24, 25
- LFO Waveshapes:
6-26
- Line Conditioning:
1-2
- Loop Length:
6-14
- Loop:
2-1, 5; 4-20
6-1, 12, 14
- Low Battery Voltage:
1-1, 14
- Master Tune:
1-10, 11; 2-1
- MAX ON:
6-4, 7
- Memory Cards:
1-12, 13; 8-1; i-1
- MIDI Bank:
2-7; 3-7, 10, 12
6-6
- MIDI Channel:
1-3, 7; 2-3, 4
3-5, 7, 10, 12, 18
to 21
- MIDI Connections:
3-18
- MIDI Controller:
1-3; 2-5; 3-5, 10
4-7; 6-5
- MIDI Controllers:
2-5, 6
- MIDI Implementation
Chart:
appendix
- MIDI In Mode:
1-7, 8; 2-4
- MIDI Loop:
2-1, 5
- MIDI:
1-3, 5, 7, 8, 13, 15
2-1 to 9
3-1, 2, 3, 5 to 21
4-2, 6, 7
5-1; 6-4, 5, 6; 7-3
8-1, 7 to 10; i-1
- MIDI Program Changes:
2-7; 3-21
- MIDI Program Number:
3-7, 10
- MIDI Status:
2-2
3-2, 7, 10, 12, 15,
16, 17
- MIDI System Exclusive:
1-15; 2-1, 6, 9
8-1, i-1
- MIDI Track:
2-1, 2
- MIDI Track Name:
2-2
- MIDI Volume Change
Message:
3-15
- Mix Bank:
3-1, 6, 7, 15; 6-5
- Mixing:
4-3, 4
- Modulation Amount:
6-3, 4, 5, 7, 14, 15,
30
- Modulation Source:
1-5; 2-2, 5; 4-17
6-3, 5, 14, 15, 24,
25, 30

- Mono A:**
2-3, 4, 8
3-6, 10, 12
- Mono B:**
2-4, 8; 3-10, 12
- Mono Mode:**
2-4; 6-16
- Mono:**
1-3, 5; 2-1, 3, 4, 8
3-6, 10, 12; 6-6, 16
- MULTI Mode:**
2-3, 4, 7
3-11, 13, 20, 21
4-2, 6
- Multiple Function Effect:**
4-4
- Multiple Parameters:**
1-10
- Need More Help:**
1-1, 15
- Noise:**
6-1, 4, 25
- Noise Rate:**
6-25
- Number of Voices:**
5-1; 7-1
- OMNI Mode:**
1-7, 8; 2-4, 8
3-6, 12, 20
- Oscillator:**
4-1
6-1, 2, 4, 9, 15, 24
7-1
- Oscillator Tune:**
6-1
- Output Bus:**
6-1, 33; 7-1, 12
- Output:**
1-2 to 5, 9
3-6, 7, 15, 16
4-1 to 5, 13, 18, 20
5-1
6-1, 17, 27, 31, 33
7-1, 8, 11, 12
- Pan Location:**
6-1, 33, 7-11
- Pan:**
1-3, 5; 3-5, 7, 15
6-1, 33; 7-1, 11
- Parameter Bank:**
1-9, 2-2
3-1, 2, 7, 8, 15; 4-6
- Parametric Programming:**
1-10
- Peak:**
6-18, 19, 20
- Pedal:**
1-5, 14
2-1, 2, 5, 6, 8
3-7, 14, 18; 4-7
6-4, 5, 6, 21
- Performance Parameters:**
3-1, 5, 7, 8
- Phase Shifter:**
4-5, 12, 16
- Pitch Bend:**
2-2, 4, 6; 6-4, 6
- Pitch:**
2-2, 4, 6; 3-8
4-7, 10, 11
6-1 to 4, 6, 15, 16,
17, 31
7-1, 7
- Playing Sounds:**
1-1, 6, 12
- POLY Mode:**
1-7, 8; 2-3, 4, 8
3-6, 10, 12, 20
- Polyphony:**
5-1, 6-16
- Power:**
1-1, 2, 3, 10, 13,
14
2-1; 3-2, 7, 18
8-5, 7; i-1
- Preset Edit Mode:**
3-8
- Preset Effect:**
2-1, 7
3-1, 2, 6, 11, 21
4-2, 6
- Preset Select Mode:**
1-6, 7, 8; 2-8
3-2, 4, 5, 12; 8-9
- Presets:**
1-6 to 10, 13, 14
2-3, 4, 7, 8, 9
3-1, 2, 4, 6, 7, 11,
15, 20, 21
4-5, 6
8-1, 3, 4, 6, 7, 9,
10
- Pressure:**
2-4, 6; 3-7, 13, 19
4-7; 6-4, 6, 7
- Program Changes:**
See MIDI Program Changes
- Programming Effects:**
4-3
- RAM Cards:**
1-14; 8-1, 3
- Ramps:**
4-7, 8
- Rear Panel Connections:**
1-5
- Reinitialize:**
1-13
- Release:**
1-11; 3-2, 7, 17
4-8
6-4, 16, 17, 19 to
22
7-1, 9, 10
- Release Time:**
3-7, 17; 4-8; 7-9
- Replacing the Sound on a Track:**
3-5
- Response Curve:**
6-27
- Reverb:**
4-1, 4, 5, 10, 11,
14 to 20
i-1
- ROM Cards:**
1-14; i-1
- ROM Sounds:**
1-12; 2-7; 3-11; 5-3
- Room Reverb:**
4-5, 10
- Scale:**
6-1, 32
- Select Preset Button:**
1-6, 7; 3-2, 3, 4, 6
- Select Sound Button:**
1-7, 12
- Select Voice:**
6-1
- Selecting a new Preset Effect from MIDI:**
2-7; 3-11

- Selecting Effects:
 4-5
- Selecting Presets:
 3-2
- Selecting Sounds:
 3-2; 7-2
- Set Default Map:
 7-6
- Signal Processing:
 4-1, 4
- Single Effects:
 4-1, 10
- Single Function Effect:
 4-3
- Sound Edit Mode:
 1-6, 7; 4-2
 6-3, 8; 7-2, 3; 8-9
- Sound Memory:
 1-12
- Sound Select Mode:
 1-6, 7, 8, 12
 2-3; 3-10, 11, 21
 4-5, 5-3
- Standard Sounds:
 1-12; 5-1; 7-1
- Start Index:
 6-1, 12
- Storage:
 1-8, 13, 14; 2-6, 9
 8-1, 3 to 10; i-1
- Store Sounds:
 8-4
- Sustain Pedal:
 2-2, 6, 8
 3-7, 14, 18; 6-21
- System Bank:
 1-10; 2-1
 3-6, 9, 10, 12, 19,
 20, 21
 6-6, 32; 7-3; 8-1, 9
- System Exclusive:
 1-15; 2-1, 3, 6, 9
 8-1, 8, 9, 10; i-1
- Temperature Guidelines:
 1-2
- Timbre:
 3-2, 7, 15, 16
 4-6, 7; 6-4, 5, 10
- Track Buttons:
 1-6, 8, 12; 3-2, 5, 6
- Track Editing:
 3-6
- Track Status:
 1-7
 3-2, 3, 6, 10, 20
- Tracks:
 1-8; 2-2, 3, 4, 7
 3-1 to 7, 9, 11 to
 17, 19, 20, 21
 4-2, 5, 6; 6-16; 7-7
- Transpose:
 3-7, 8, 18
- TRANSWAVE:
 6-10, 12; 7-5
- Tufnel Theorem:
 4-20
- Type-specific wave
 Parameters:
 6-12
- Velocity:
 4-7
 6-1, 4, 5, 7, 20, 27,
 33
 7-1, 8, 9, 12
- Velocity Attack
 Control:
 6-20
- Velocity Curve:
 6-20; 7-9
- Velocity Level Control:
 6-20; 7-1, 8, 9, 12
- Voice Muting:
 2-3
- Voice Priority:
 3-21
- Voice Restrike Decay
 Time:
 6-14
- Voice Status:
 6-9
- Voice Volume:
 4-18; 6-31
 7-1, 9, 11
- Voices and Polyphony:
 5-1
- Volume:
 1-1, 4, 5, 7, 9, 14
 2-2, 5, 6
 3-2, 5, 7, 15, 18
 4-18; 5-1
 6-1 to 4, 6, 7, 17,
 21, 31, 32
 7-1, 9, 11
- Volume Modulator:
 6-32
- Warm Chamber:
 4-5, 10
- Wave:
 5-1
 6-1, 2, 4, 8, 10, 11,
 12, 14, 21, 22,
 26, 33
 7-1 to 6, 10
- Wave Class:
 6-10, 11, 12; 7-5
- Wave Name:
 6-10, 7-3, 5
- What is a Sound?:
 5-1
- Wheel:
 1-5, 2-5, 6
 3-13, 4-1, 7
 6-4, 5, 6