



English

AIX-101/102
6/4-STRING
GUITAR/BASS
PICKUP

Owner's Manual



AIX-101/102 -6/4-STRING - GUITAR/BASS- PICKUP

The AIX-101/102 is a high-performance guitar synthesizer pickup/driver designed for use with the BLUE CHIP AXON Guitar MIDI Converter. When properly installed and adjusted it can add high-performance MIDI guitar synthesizer capability to just about any electric or steel-string acoustic guitar.

The pickup for guitar with 6 strings is called AIX-101. The pickup for the bass guitar is entiteled as AIX-102.

In the following operating instruction, all illustrations relate to the AIX-101. You mount the AIX-102 on the bass guitar in the same way.

Please read this owner's manual carefully, and follow the installation instructions within in order to ensure proper operation.



The interface and the handling are identical concerning guitar and bass. The function of the keys UP/DOWN, the selector GUITAR/MIX/SYNTH and the MIDI volume control are also explained in the user manual of the AXON.

Contents

Precautions	2
Nomenclature	3
Installation	4
Setup	12
Specifications	14



AIX-101 Hex Pickup for Guitar with 6 Strings



AIX-102 Pickup for Bass Guitar with 4 Strings

Precautions **!! PLEASE READ THIS BEFORE PROCEEDING !!**

■ Location

Do not expose the AIX-101/102 to the following conditions to avoid deformation, discoloration, or more serious damage.

- Direct sunlight (e.g. near a window).
- High temperatures (e.g. near a heat source, outside, or in a car during the daytime).
- Excessive humidity.
- Excessive dust.
- Strong vibration.

■ Connections

- When connecting the AIX-101/102 to the BLUE CHIP AXON Guitar MIDI Converter, be sure to use the specified multi-pin cable (supplied with the AXON Guitar MIDI Converter).
- Always connect the direct guitar cable (page 12), even if you don't intend to use the direct guitar sound. The direct guitar cable is essential for proper grounding, to minimize noise and prevent electric shock.
- Always unplug cables by gripping the plug firmly, **not** by pulling on the cable.
- Disconnect all cables before moving the instrument or any connected equipment.

■ Handling and Transport

- Never apply excessive force to the controls, connectors or other parts of the instrument.
- Physical shocks caused by dropping, bumping, or placing heavy objects on the instrument can result in scratches and more serious damage.
- Be careful not to damage the AIX-101/102 controller when placing the guitar in a case or on a stand.

■ Cleaning

- Clean the unit with a dry soft cloth.
- A slightly damp cloth may be used to remove stubborn grime and dirt.
- Never use cleaners such as alcohol or thinner.

■ Service and Modification

- The AIX-101/102 contains no user serviceable parts. Opening it or tampering with it in any way can lead to irreparable damage and possibly electric shock. Refer all servicing to qualified BLUE CHIP personnel.

BLUE CHIP is not responsible for damage caused by improper installation, handling, or operation.

Nomenclature

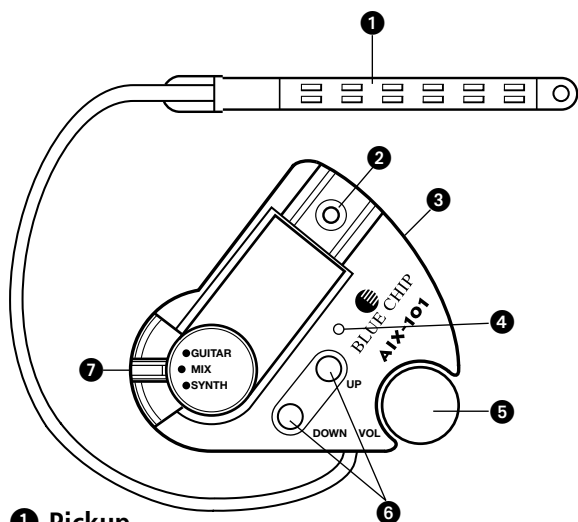

1 Pickup

This is the actual “pickup” unit which converts the physical motion of the guitar’s strings into an electrical signal which can be processed by the AIX-101/102 and transmitted to the AXON Guitar MIDI Converter.

■ CAUTION!

- Because of its slender dimensions the pickup unit is quite delicate and can be damaged if subjected to unnecessary force, bending, or twisting. **Handle the pickup carefully!**

2 Multi-pin Cable Connector

This is the main output from the AIX-101/102. One end of the multi-pin cable supplied with the AXON Guitar MIDI Converter is plugged in here, and the other end of the cable is plugged into the DIVIDED INPUT connector on the AXON. The multi-pin cable connector delivers both the individual string output from the AIX-101/102 pickup and the combined output from the guitar’s output jack to the AXON Guitar MIDI Converter. It also supplies power from the AXON to the AIX-101/102, and sends the control signals produced by the AIX-101/102 UP/DOWN buttons and VOL control to the AXON.

3 Direct Guitar Input Jack

This jack receives the combined output from the guitar’s normal pickups from the guitar’s output jack. The short cable supplied with the AIX-101/102 is used to connect the guitar’s output jack (large 1/4" phone jack end of the cable) to the AIX-101/102 direct guitar input jack (small mini-jack end of the cable).

4 Power Indicator

The AIX-101/102 is receiving power from the AXON Guitar MIDI Converter when this indicator is lit. The indicator lights when the AIX-101/102 is properly connected to the AXON via the multi-pin cable, and the AXON power is turned ON.

5 Volume Control

Controls the volume of the MIDI tone generator(s) connected to the AXON Guitar MIDI Converter (the AXON translates the position of this control to MIDI master volume data which is sent to the tone generator). Use the guitar’s original volume controls to adjust the volume of the direct guitar sound.

6 UP/DOWN Buttons

These buttons can be used to select different synthesizer voices and select other functions while playing the AIX-101/102. Press either button briefly to increment or decrement the AXON Guitar MIDI Converter memory number by one (and thereby the voice number of the synthesizer or tone generator it is driving), or hold either button for continuous scrolling in the corresponding direction.

7 GUITAR/MIX/SYNTH Selector

Selects the type of output to be delivered via the multi-pin cable connector to the AXON Guitar MIDI Converter, as listed below:

GUITAR	Only the direct guitar sound will be heard (i.e. no synthesizer sound will be produced).
MIX	Both the direct guitar sound and individual-string synthesizer output will be heard.
SYNTH	Only the individual-string synthesizer output is sent to the AXON (no direct guitar sound will be heard).

Installation

Installing the AIX-101/102 on a guitar is not a difficult process, but it does require care and at least a modicum of mechanical ability. If you don't feel totally confident that you can handle the job, it might be a good idea to leave the installation to someone experienced in guitar modification or repair.

IMPORTANT!

Make sure your guitar's neck (truss rod) and string height/intonation (bridge) are properly adjusted before installing the AIX-101/102.

Guitar Compatibility

The AIX-101/102 can be installed on most electric and steel-string acoustic guitars, with the following exceptions:

- Since the AIX-101/102 employs a magnetic pickup, it will **not** work with nylon or other non-metallic strings.
- The AIX-101/102 is designed for use with 6-string guitars. It will not work properly with 12-string guitars or other non-standard string configurations.
- The AIX-101/102 pickup should be installed between the guitar's bridge and bridge pickup. Installation may not be possible if there is not enough room between the bridge and bridge pickup of your guitar, or between the guitar top and strings.

Installing the Controller Unit

Install the controller unit before installing the pickup, being careful not to damage the pickup during the installation process.

A number of installation options are provided:

- Screw.
- Double-sided adhesive tape.
- Re-usable adhesive pads.
- Velcro fastener.
- Bracket.
- Suction cups.

Choose the method which is best suited to your guitar and playing requirements.

■ Hardware

The following parts are provided for installation of the controller unit. Please make sure you have all the parts.

- Self-tapping round-head screw (3x16mm) 1



- Double-sided adhesive tape 3



- Re-usable double-sided adhesive pads (transparent). 3

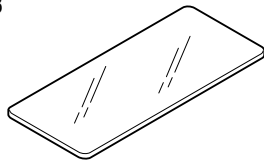

- Spacer (double-sided adhesive). 6



- Velcro fastener 1

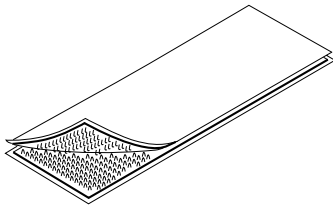

- Bracket 1

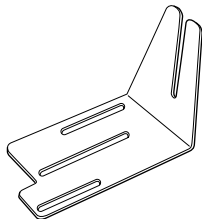

- Suction cups 3



■ Installation Procedure

1. Determine the optimum location for installation.

Normally, the controller should be attached somewhere behind the guitar's bridge, as shown in the illustration. It should be accessible, but it should not interfere with your playing or any of the guitar's controls or adjustments. Consider the following points carefully when deciding on the best location to install the controller:

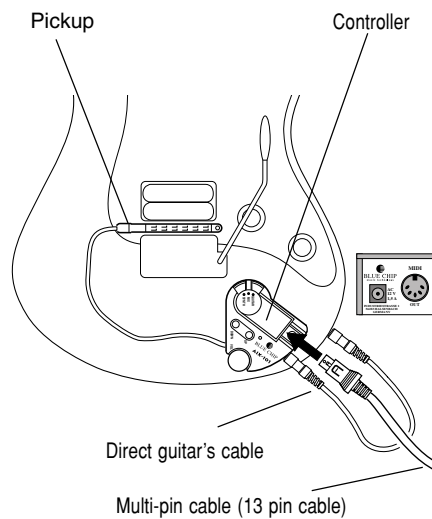

- The controller should not get in the way of your picking-hand at any time. Make sure the location you choose will not affect your playing style.
- The controller should not block or hamper access to any of the guitar's controls: tone, volume, bridge adjustments (especially watch out for intonation/saddle screws accessed from the rear of the bridge).
- The controller must be well within reach of both the pickup cable (when the pickup is in its final installed position) and the direct guitar cable
- Neither the controller unit itself nor any of the connected cable plugs should extend beyond the body of the guitar to prevent accidental damage.

2. Mark and drill the controller screw hole (see "NOTES" below) .

■ CAUTION!

- Make sure the multi-pin cable and direct guitar's cable are disconnected from the controller before installation.

While holding the controller unit in exactly the position it is to be installed, use a fine pen or scribe to mark the center of the screw hole (located in the multi-pin cable recess of the controller) on the body of your guitar.

Then set the controller unit aside and carefully drill a 2-millimeter (1/16" inch, approx.) hole at the marked location.

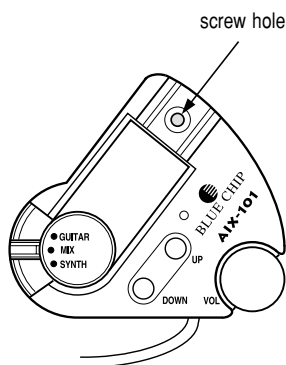

■ NOTES

- For acoustic or semi-acoustic guitars, or simply if the idea of drilling a hole in your guitar makes you shudder, the controller can be attached using only the adhesive tape, the Velcro fastener, or any of the other installation options described below. Please note, however, that screw installation is the most secure method, and is recommended wherever possible.
- The Velcro fastener is provided for players who will be frequently removing and reattaching the AIX-101/102. DO NOT use the adhesive pads if you use the Velcro fastener.

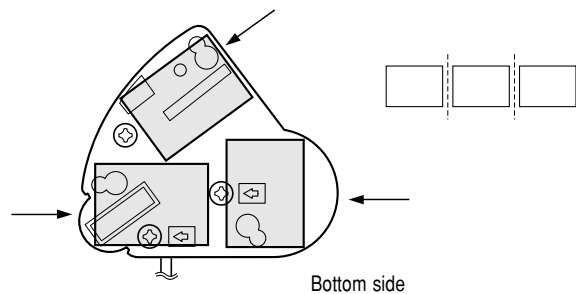

3. Attach the controller (screw/adhesive tape)

Remove the protective backing from one side of the adhesive tape patches and attach them to the bottom of the controller as shown in the illustration.

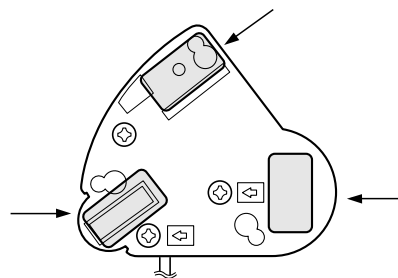

■ NOTES

- You can use the standard adhesive tape or the re-usable adhesive pads on just about any type of guitar. See "The Re-usable Adhesive Pads" below, for details.
- The adhesive tapelpads may react chemically with the finish on some guitars, causing discoloration or otherwise marring the finish. It might be a good idea to try attaching a small piece of tapelpad at some location that is not obvious for a few days before actual installation.
- If your guitar has an arched top or is shaped in such a way that the controller won't sit properly with only the standard adhesive tape, use as many of the spacers as required in the appropriate location(s) to position the controller as required. The spacers are adhesive on both sides, with protective backing like the standard adhesive tape.

Next, carefully clean the area on the guitar body to which the controller is to be attached to eliminate dust, dirt, and particularly any oil or grease which might prevent the adhesive from sticking. Then remove the protective backing from the exposed side of the adhesive tape, and carefully attach the controller to the guitar making sure that the screw hole in the controller is perfectly aligned with the screw hole in the body of your guitar (if you drilled one). Press firmly — but don't use excessive force — to ensure that the tape sticks securely.

Finally, screw the supplied self-tapping round-head screw (3 x 16 mm) into the pre-drilled hole in the guitar body through the hole in the controller. Screw only "finger tight" — **if you attempt to screw in too far or too tight you might damage the controller and or your guitar!**

The Re-usable Adhesive Pads

The re-usable adhesive pads can be used in the same way as the standard double-sided adhesive tape for controller unit installation. They can be re-used many times, and if their adhesive qualities deteriorate due to accumulated dust and dirt, they can be restored to virtually like-new conditions by washing carefully with a neutral detergent. If you do repeatedly attach and remove the re-usable adhesive pads, it is a good idea to replace the original protective backing when the pads are not in use to keep them in top condition.

Bracket Installation

This installation option has the advantages that no holes need to be drilled in the guitar.

To use the bracket, first unscrew the two screws marked with arrows on the bottom of the controller unit, then use the same screws to attach the controller unit to the bracket as shown in the illustration.

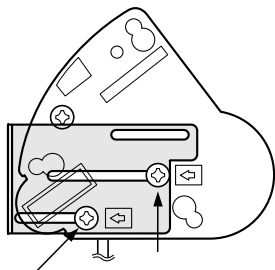

Next, attach the spacers (double-sided adhesive) to the bracket to protect the guitar surface from the screw heads, and attach the bracket to the guitar in the appropriate position, as shown in the illustration.

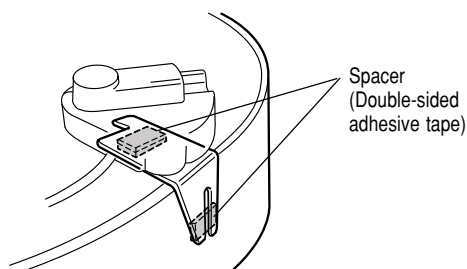

An alternative method is to attach the bracket using the guitar's strap pin (the spacers should still be used to prevent the controller/bracket assembly from scratching the surface of the guitar). Loosen the strap pin on the guitar body by unscrewing its attachment screw by a few turns, slide the slot in the bracket under the pin as shown in the illustration, then tighten the pin screw until the bracket is held firmly in position.

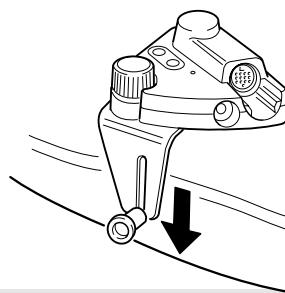

■ CAUTION!

- Repeated loosening and tightening of the strap pin, or application of excessive force to the bracket, can cause the strap pin screw to become loose.

Suction Cup Installation

The supplied suction cups are a handy and fairly secure way to attach the controller unit to guitars with a flat top and a smooth, shiny finish.

To use the suction cups, first insert the bases of the three suction cups into the large openings in the three holes on the bottom of the controller unit, then slide the bases of the cups toward the narrow section of the holes until they are held securely. Then, after making sure the surface of your guitar is free from dirt and grease, simply press the controller unit onto the guitar top at the appropriate location.

The suction cups can be removed by slightly lifting the edge of each cup.

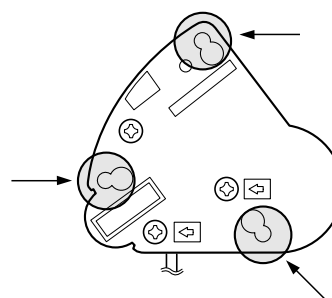

Installing the Pickup

Once you've installed the controller, the pickup can be installed using either double-sided tape or screws. Although the tape is convenient, screw-installation is recommended because it provides greater security and allows pickup height adjustment for optimum performance.

Hardware

The following parts, supplied with the AIX-101/102, are required or optional for installation of the pickup. Please make sure you have all the parts.

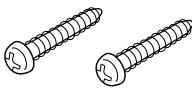
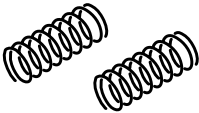
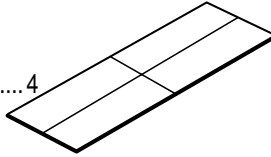
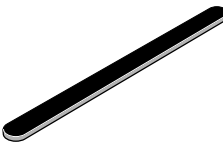
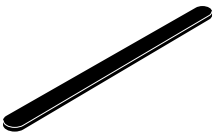
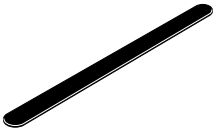
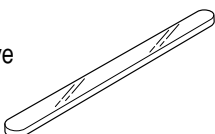
- Self-tapping round-head screws (3x25mm) 2 
- Springs 2 
- Double-sided adhesive tape 4 
- Pickup cushion 1 
- Pickup spacers A (1mm) 5 
- Pickup spacers B (0.3mm) 10 
- Re-usable double-sided adhesive pads 2 

Installation Procedure — Tape

1. Mark the optimum position for installation.

The pickup should be located between the bridge pickup and bridge, ideally 20-mm from the bridge. If the ideal 20-mm placement is not possible, the pickup should be located as far as possible, but no more than 20 millimeters away from the bridge. The cable end of the pickup should be oriented toward the sixth string (low E). One pair of the pickup's magnetic yokes should be under each string. String spacing varies somewhat on different guitars, and the pickup will function properly as long as each string passes over part of the corresponding yokes (not necessarily the exact center). Check that the strings pass over the yokes, even when bending the strings.

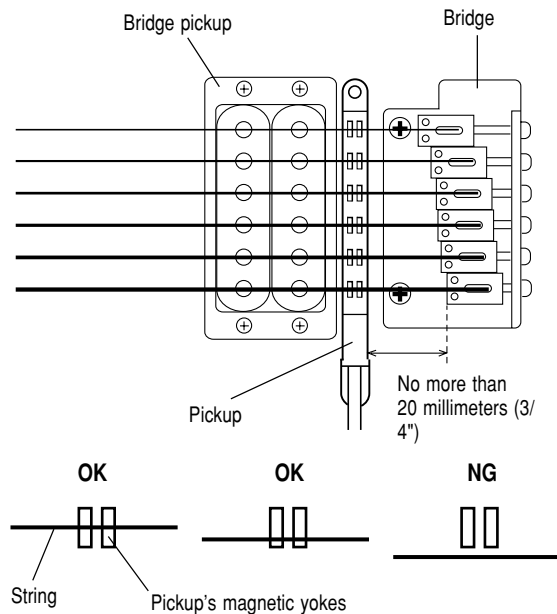

NOTES

- Make sure the pickup does not interfere with the operation of a tremolo arm or other guitar controls.

Once the pickup has been positioned correctly, carefully mark the position on the guitar body. Small pieces of marking tape can be used if you don't want to mark directly on the guitar body.

2. Set the pickup height.

First make sure the truss rod and string height are adjusted properly, then tune the strings to their normal pitch. Adjust the height of the pickup — using the appropriate spacer or combination of spacers (see “NOTES” below) — so that the distance between the top of the pickup and the bottom of each string is about 1 millimeter (0.04”) when each string is fretted at the highest note on the neck. The pickup height can be checked by using the supplied clearance gauge.

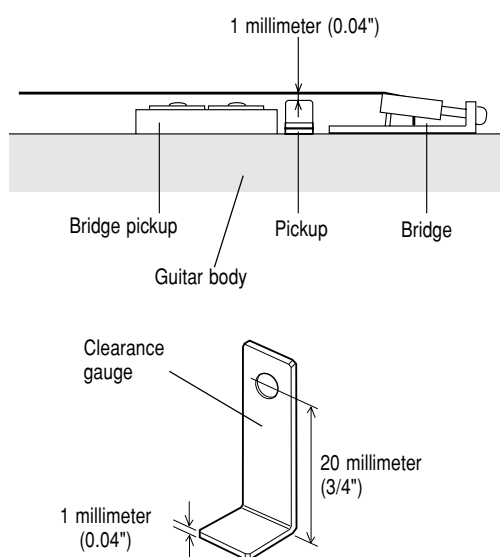

■ NOTES

- Don't remove the backing from the pickup cushion or spacers when initially setting up the pickup height. Please note that the cushion/spacer backing adds about 0.1 millimeter (0.004") to their thickness, so take this added thickness into account when using a number of spacers.
- To compensate for differences in height between the first and sixth strings (e.g. if your guitar has an arched top), use an appropriate number of one-quarter or one-third width spacers under the lower end of the pickup (the spacers can be cut easily with a good pair of scissors).

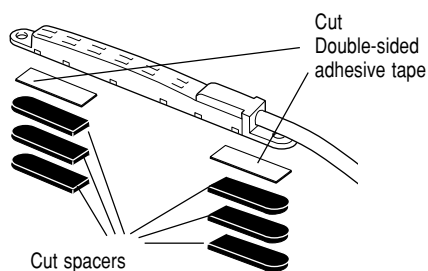

3. Attach the pickup.

Remove the strings from the guitar. Apply the double-sided tape to the bottom of the pickup and remove the backing. Remove the backing from the required pickup cushion/spacers and carefully attach them to the bottom of the pickup. Finally, carefully attach the pickup/spacer assembly to the guitar at the marked position, then re-string and tune the guitar.

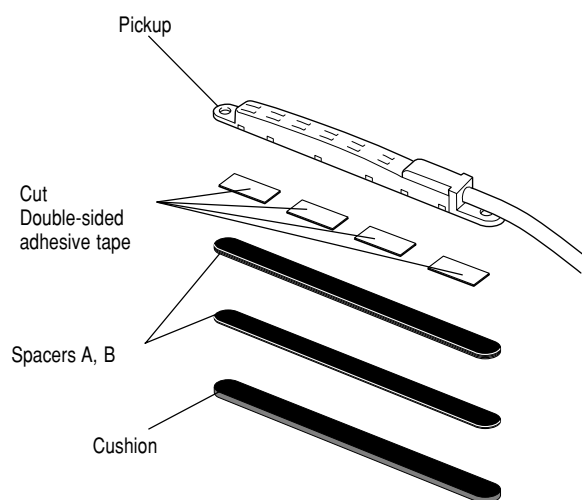

■ NOTES

- The re-usable double-sided adhesive pads (page 8) can be used in place of the bottom layer of adhesive tape (guitar side). Cut the pads to match the shape of the pickup, as required.

4. Check the height.

Check the pickup height again, and play the guitar in all ranges to ensure that the strings do not come in contact with the pickup. If all is well, then the installation is complete.

If you need to readjust the pickup height ...

If the pickup height needs to be re-adjusted, remove the strings and carefully pry the pickup from the guitar by sliding a thin, flat object (e.g. a small knife blade) under the sixth-string end of the pickup — between the pickup and top spacer — and gently lifting the pickup away from the spacer.

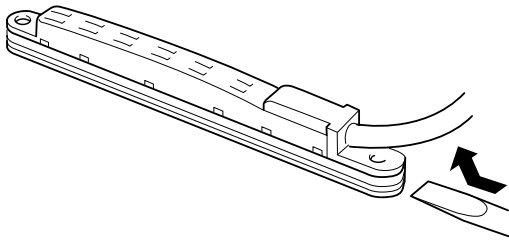

The double-sided tape can then be “rolled” off the bottom of the pickup as shown in the illustration.

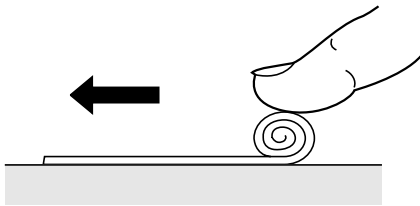

Readjust the height as required by adding or removing spacers:

- To add a new spacer in order to raise the pickup, remove any used double-sided tape from the existing spacer, then attach the new spacer to the top of the existing spacer after removing its backing.
- When removing a spacer to lower the pickup, be sure to remove both the spacer and its backing tape.

Finally, attach fresh double-sided tape to the bottom of the pickup, remove the backing, carefully attach the pickup to the uppermost spacer, then re-string and tune the guitar.

■ Installation Procedure — Screw

Screw installation has several advantages over tape installation: screw installation is more secure, the height of the pickup can be more precisely adjusted, and pickup height can be easily re-adjusted as required without having to remove and reattach double-sided tape.

■ NOTES

- Screw installation requires at least a 13 millimeter (1/2”) space between the guitar top and strings.

1. Mark the optimum position for installation.

The pickup should be located between the bridge pickup and bridge (see “NOTES” below). The cable end of the pickup should be oriented toward the sixth string (low E). One pair of the pickup’s magnetic yokes should be under each string. String spacing varies somewhat on different guitars, and the pickup will function properly as long as each string passes over part of the corresponding yokes (not necessarily the exact center).

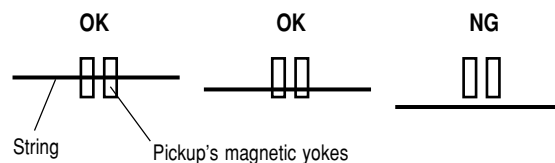
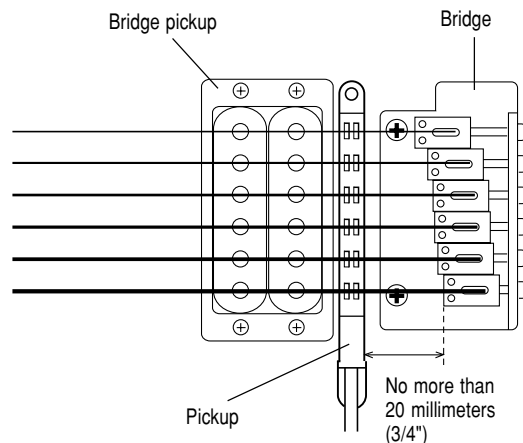

■ **NOTES**

- *The pickup should be located as far as possible but no more than 20 millimeters (3/4") from the bridge.*
- *Make sure the pickup does not interfere with the operation of a tremolo arm or other guitar controls.*

Once the pickup has been positioned correctly, carefully mark the centers of the two screw holes at either end of the pickup on the guitar body using a fine pen or scribe.

2. Drill the screw holes.

Remove the strings from the guitar and very carefully drill 2-millimeter (0.08", approx.) holes at the marked locations. The holes may have to be slightly larger in diameter if your guitar's body is made from a very hard wood such as maple, cherry, or rosewood.

3. Attach the pickup.

Insert the two self-tapping round-head screws (3x25mm) through the screw holes in the pickup, and place the springs over the screw shafts extending below the pickup. Screw the screws in the corresponding holes in the guitar top.

■ **CAUTION!**

- *Be careful not to damage the pickup cable when installing the pickup.*

4. Re-string and adjust the pickup height.

Re-string and tune the guitar, then carefully adjust the pickup height by loosening or tightening the pickup screws. The distance between the top of the pickup and the bottom of each string should be about 1 millimeter (0.04") when each string is fretted at the highest note on the neck. The pickup height can be checked by using the supplied clearance gauge.

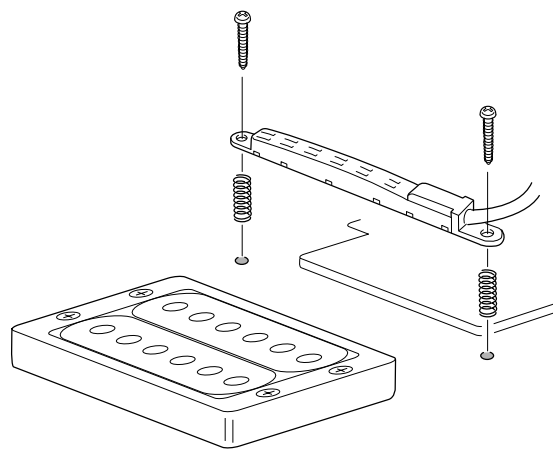

Setup

Once installation is complete, you're ready to connect and check out your MIDI guitar system (assuming you also have an AXON Guitar MIDI Converter and appropriate tone-generator/sound hardware).

1. Connect the direct guitar cable.

Connect the 1/4" mono phone plug end of the direct guitar cable (supplied with the AIX-101/102) to the guitar's output jack, and the mono mini-plug end of the cable to the AIX-101/102 direct guitar input jack.

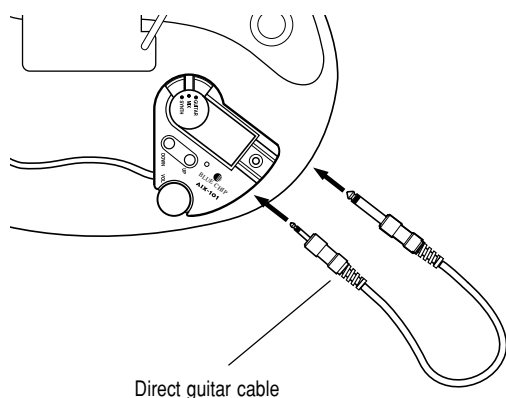

■ NOTES

- Always connect the direct guitar cable, even if you don't intend to use the direct guitar sound. The direct guitar cable is essential for proper grounding, to minimize noise and prevent electric shock.

2. Connect the AIX-101/102 to the AXON.

After making sure that the AXON Guitar MIDI Converter power is OFF, plug one end of the multi-pin cable supplied with the AXON into the AIX-101/102 multi-pin connector, and the other end into the DIVIDED INPUT connector on the AXON. The release button on the multi-pin plug should face outward.

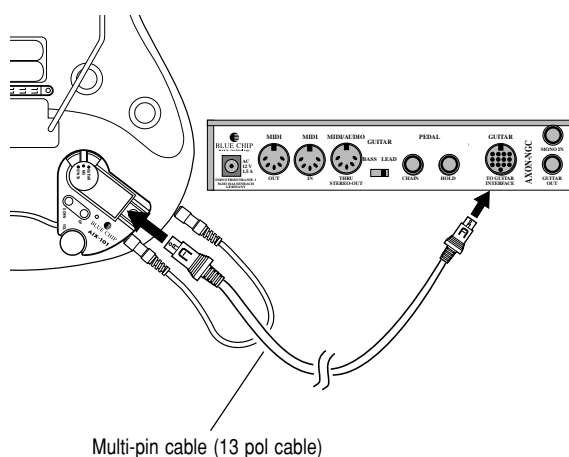

■ NOTES

- For extra security and damage prevention it is a good idea to pass the cable between the strap and guitar

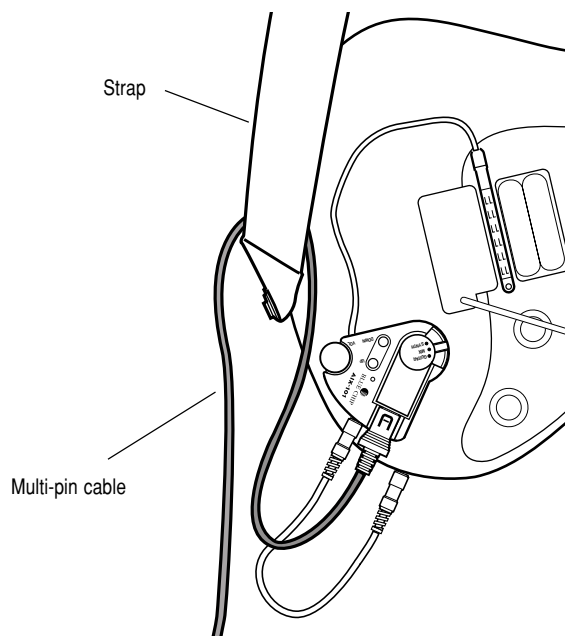

body near the body strap pin.

- See the AXON owner's manual for AXON setup and operation details.
- The multi-pin cable plug release button must be pressed when unplugging the multi-pin cable from the AIX-101/102.

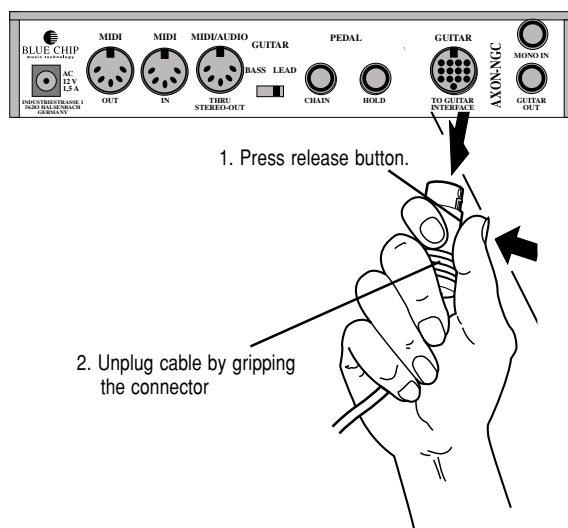

3. Turn on the AXON.

When the AXON power is turned ON, the AIX-101/102 power indicator should light indicating that it is receiving power from the AXON.

4. Play.

Assuming that your AXON, tone generator, and other equipment are set up properly (refer to the appropriate owner's manuals for details), you're now ready to play.

Specifications

■ Functions

- Volume Control (VOL)
- GUITAR/MIX/SYNTH Selector
- UP/DOWN Buttons
- Power Indicator
- Pickup (individual-string synthesizer output)
- Direct Guitar Input Jack
- Multi-pin Cable Connector
(individual-string synthesizer output + direct guitar sound)

■ Package Contents

- Pickup & Controller Unit
- Direct guitar cable (1/4" mono phone <--> mono mini-plug)
- Installing hardware parts

■ Dimensions (W x H x D)

85.1mm x 75.9mm x 28.8mm (3-1/3" x 3" x 1-1/8")

■ Weight

30 g (1 oz)