

V-AMPIRE/V-AMP PRO/V-AMP 2

User's Manual



Version 1.4 December 2005



V-AMPIRE

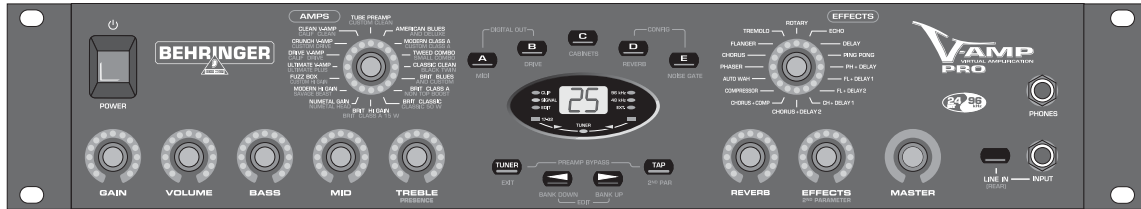

V-AMP PRO

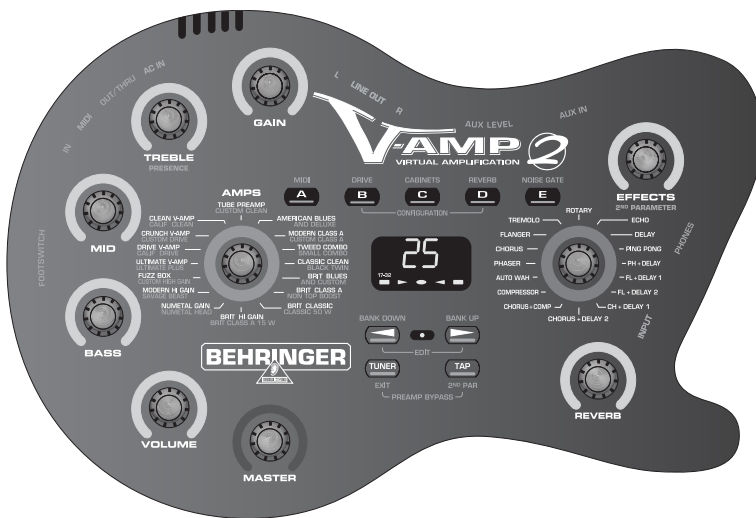

V-AMP 2



V-AMPIRE/V-AMP PRO/V-AMP 2

IMPORTANT SAFETY INSTRUCTIONS



CAUTION: To reduce the risk of electric shock, do not remove the top cover (or the rear section). No user serviceable parts inside; refer servicing to qualified personnel.

WARNING: To reduce the risk of fire or electric shock, do not expose this appliance to rain and moisture. The apparatus shall not be exposed to dripping or splashing and no objects filled with liquids, such as vases, shall be placed on the apparatus.



This symbol, wherever it appears, alerts you to the presence of uninsulated dangerous voltage inside the enclosure—voltage that may be sufficient to constitute a risk of shock.



This symbol, wherever it appears, alerts you to important operating and maintenance instructions in the accompanying literature. Please read the manual.

DETAILED SAFETY INSTRUCTIONS:

- 1) Read these instructions.
- 2) Keep these instructions.
- 3) Heed all warnings.
- 4) Follow all instructions.
- 5) Do not use this apparatus near water.
- 6) Clean only with dry cloth.
- 7) Do not block any ventilation openings. Install in accordance with the manufacturer's instructions.
- 8) Do not install near any heat sources such as radiators, heat registers, stoves, or other apparatus (including amplifiers) that produce heat.
- 9) Do not defeat the safety purpose of the polarized or grounding-type plug. A polarized plug has two blades with one wider than the other. A grounding type plug has two blades and a third grounding prong. The wide blade or the third prong are provided for your safety. If the provided plug does not fit into your outlet, consult an electrician for replacement of the obsolete outlet.
- 10) Protect the power cord from being walked on or pinched particularly at plugs, convenience receptacles, and the point where they exit from the apparatus.
- 11) Only use attachments/accessories specified by the manufacturer.
- 12) Use only with the cart, stand, tripod, bracket, or table specified by the manufacturer, or sold with the apparatus. When a cart is used, use caution when moving the cart/apparatus combination to avoid injury from tip-over.



- 13) Unplug this apparatus during lightning storms or when unused for long periods of time.
- 14) Refer all servicing to qualified service personnel. Servicing is required when the apparatus has been damaged in any way, such as power supply cord or plug is damaged, liquid has been spilled or objects have fallen into the apparatus, the apparatus has been exposed to rain or moisture, does not operate normally, or has been dropped.
- 15) CAUTION - These service instructions are for use by qualified service personnel only. To reduce the risk of electric shock do not perform any servicing other than that contained in the operation instructions unless you are qualified to do so.

V-AMPIRE/V-AMP PRO/V-AMP 2

Ultra-flexible virtual guitar amps with tube simulation and digital multi-effects processor

- ▲ 32 authentic virtual amp simulations, 15 speaker cabinets and preamp bypass
- ▲ Dedicated selectors for amp model, speaker cabinet and digital effects
- ▲ Amps selector allows you to directly select popular guitar amp simulations ranging from classic clean to crunch and modern Hi Gain sounds with the original tube amp character
- ▲ Effects selector selects first-class effects such as chorus, flanger, phaser, rotary, auto wah, echo, delay, compressor and various effects combinations—can be used without amp simulation!
- ▲ Dedicated reverb control adds 1 of 9 different reverb types
- ▲ 125 memory locations divided into 25 banks for easy editing
- ▲ Extensive MIDI implementation allows complete real-time remote control and automation, data transfer and access to additional parameters
- ▲ Five globally selectable configurations for various studio and live applications, some with additional 3-band live-EQ
- ▲ Built-in chromatic tuner for connection of your guitar or other electronic instruments
- ▲ V-AMPIRE: 2 x 60 Watt guitar combo with 1 x 12" BUGERA™ loudspeaker
- ▲ V-AMPIRE: Two additional outputs for connection of external loudspeakers
- ▲ V-AMPIRE/V-AMP PRO: Balanced stereo XLR DI Out with ground lift and switchable ULTRA-G speaker simulation
- ▲ V-AMPIRE/V-AMP 2: Adjustable stereo aux input for line-level signals (CD, drum computer, sound card etc.)
- ▲ V-AMPIRE/V-AMP PRO: Pre DSP send/return loop for dry recording and wet monitoring or as serial effects loop
- ▲ V-AMP PRO: AES/EBU and S/PDIF connectors allow usage as universal A/D converter with high-impedance input, 24-bit/96 kHz resolution and 100 dB dynamic range
- ▲ V-AMP PRO: BNC wordclock input for external sample rate synchronization up to 96 kHz
- ▲ V-AMP PRO: Post DSP stereo inserts for connection of external effects devices
- ▲ V-AMP 2: Gig bag and footswitch for preset selection and tuner control included
- ▲ Conceived and designed by BEHRINGER Germany.

V-AMPIRE/V-AMP PRO/V-AMP 2

FOREWORD



Dear Customer,

welcome to the team of BEHRINGER users, and thank you very much for expressing your confidence in us by purchasing this virtual guitar amplifier.

Writing this foreword for you gives me great pleasure, because it represents the culmination of many months of hard work delivered by our engineering team to achieve a very ambitious goal: to develop three outstanding devices, that give you maximum flexibility

and performance with their unique sound character and broad range of functions. The task of designing these new products certainly meant a great deal of responsibility, which we assumed by focusing on you, the discerning user and musician. Meeting your expectations also meant a lot of work and night shifts. But it was fun, too. Developing a product usually brings a lot of people together, and what a great feeling it is when all who participated in such a project can be proud of what they've achieved.

It is our philosophy to share our enjoyment with you, because you are the most important member of the BEHRINGER team. With your highly competent suggestions for new products you've made a significant contribution to shaping our company and making it successful. In return, we guarantee you uncompromising quality as well as excellent technical and audio properties at an extremely reasonable price. All of this will enable you to give free rein to your creativity without being hampered by budget constraints.

We are often asked how we manage to produce such high-quality devices at such unbelievably low prices. The answer is quite simple: it's you, our customers! Many satisfied customers means large sales volumes, enabling us to get better purchasing terms for components, etc. Isn't it only fair to pass this benefit on to you? Because we know that your success is our success too!

I would like to thank all of you who have made the V-AMPIRE/V-AMP PRO/V-AMP 2 possible. You have all made your own personal contributions, from the developers to the many other employees at this company, and to you, the BEHRINGER user.

My friends, it's been worth the effort!

Thank you very much,

Uli Behringer

TABLE OF CONTENTS

1. INTRODUCTION	5
1.1 ... before you get started	5
1.1.1 Online registration	5
2. CONTROL ELEMENTS	5
2.1 Front panel/surface	5
2.2 Rear panel/side	7
3. OPERATING MODES AND APPLICATIONS	8
3.1 Selecting an operating mode in CONFIGURATION mode	8
3.2 Rehearsal or recording at home	8
3.2.1 V-AMPIRE	8
3.2.2 V-AMP PRO	8
3.2.3 V-AMP 2	8
3.3 Live on stage or in a rehearsal room	9
3.3.1 V-AMPIRE	9
3.3.2 V-AMP PRO	9
3.3.3 V-AMP 2	9
3.4 Recording	9
3.4.1 V-AMPIRE	9
3.4.2 V-AMP PRO	9
3.4.3 V-AMP 2	9
4. PRESETS	10
4.1 Calling up presets	10
4.2 Editing presets	10
4.3 Storing presets	10
4.4 Discarding an edited preset/restoring a single factory preset	11
4.5 Restoring all factory presets	11
5. AMP/SPEAKER SIMULATION	11
5.1 Amp descriptions	11
5.2 Speaker descriptions	12
6. EFFECTS PROCESSOR	13
6.1 Wah Wah	13
6.2 Effect descriptions	13
6.2.1 Reverb and delay algorithms	13
6.2.2 Modulation effects	14
6.2.3 Combinations of effect algorithms (multi-effects programs)	14
6.2.4 Special effects	14
6.3 The separate reverb effect	14
7. TUNER	14
7.1 Tuning your guitar	14
7.2 Setting reference pitch "A"	15
8. INSTALLATION	15
8.1 Mains voltage	15
8.2 Audio connections	15
8.3 MIDI connections	16
8.3.1 Sending/receiving MIDI-Sysex data	16
8.4 AES/EBU and S/PDIF standards	16
9. APPENDIX	17
10. SPECIFICATIONS	18
11. WARRANTY	20

CAUTION!

 Please note that high volume levels may cause permanent damage to your hearing and/or your headphones. Turn all LEVEL controls to the left before you switch on the unit. Be sure to keep the volume at an appropriate level.

1. INTRODUCTION

Congratulations! With the V-AMPIRE, V-AMP PRO and V-AMP 2 you have acquired an up-to-date guitar amp of the newest generation. Each one offers you a range of sonic possibilities as wide as your own imagination.

With the V-AMPIRE you own the new combo version of our famous V-AMP 2. It's an allrounder with so many features that you hardly need any other equipment.

The V-AMP PRO is the "big brother" of the V-AMP 2. Besides the V-AMP 2 features, the PRO version offers digital output signals and you can even select the output format. External synchronization of your V-AMP PRO is possible via wordclock.

The V-AMP 2 is the revised and furtherly developed well-known V-AMP model. With this modern virtual guitar amp we have set a new standard. The V-AMP 2 offers 32 authentic amp and even special loudspeaker cabinet sounds without the usual transportation problems.

But enough of this talk: Nothing will convince you more than what you hear and feel when you test your virtual amp for the first time.

But ...

1.1 ... before you get started

The unit was carefully packed at the factory and the packaging is designed to protect the unit from rough handling. Nevertheless, we recommend that you carefully examine the packaging and its contents for any signs of physical damage which may have occurred during transit.

 **If the unit is damaged, please do NOT return it to BEHRINGER, but notify your dealer and the shipping company immediately. Otherwise, claims for damage or replacement may not be granted.**

Be sure that there is enough space around the unit for cooling and, to avoid overheating, please do not place the device near radiators etc.

 **Before you connect the unit to the mains, please make sure that the voltage setting on the unit matches the local voltage!**

The mains connection of the V-AMP 2 is made by using the enclosed power supply, which meets all of the international safety certification requirements. As soon as the V-AMP 2 is connected to the mains via its power supply, the unit is switched on automatically.

 **Please make sure that all units have a proper ground connection. For your own safety, never remove or disable the ground conductor from the unit or of the AC power cord. The unit shall always be connected to the mains socket outlet with a protective earthing connection.**

The MIDI connections (IN, OUT/THRU) are for standard DIN connectors. Data is transferred via ground-free opto-couplers. Further information can be found in chapter 8 "INSTALLATION".

1.1.1 Online registration

Please, do remember to register your new BEHRINGER equipment right after your purchase by visiting www.behringer.com (alternatively www.behringer.de) and kindly read the terms and conditions of our warranty carefully.

Should your BEHRINGER product malfunction, our goal is to have it repaired as quickly as possible. To arrange for warranty service, please contact the retailer from whom the equipment was purchased. Should your BEHRINGER dealer not be located in your vicinity, you may directly contact one of our subsidiaries. Corresponding contact information is included in the original equipment packaging (Global Contact Information/European Contact Information). Should your country not be listed, please contact the distributor nearest you. A list of distributors can be found in the support area of our website (www.behringer.com).

Registering your purchase and equipment with us helps us process your repair claims quicker and more efficiently.





Thank you for your cooperation!



2. CONTROL ELEMENTS

On the added view sheet you will find the corresponding illustrations for all control elements. The numbering of most of the control elements is the same for all three products. Because of the different design and some varying elements, the numbering is not always consistent. We therefore marked those differences adding a "V-AMPIRE only", "V-AMP PRO only" or "V-AMP 2 only".

2.1 Front panel/surface

-  1 Use the *POWER* switch to put the V-AMPIRE (rear) and the V-AMP PRO (front) into operation. The *POWER* switch should be in the "off" position (not pressed) if you want to connect the device to the mains.
-  **Attention: The *POWER* switch does not fully disconnect the unit from the mains. Unplug the power cord completely when the unit is not used for prolonged periods of time.**
- 2 The *GAIN* control determines the distortion level of an amp simulation.
- 3 The *VOLUME* control determines the volume of the selected preset.
- 4 The *BASS* control in the EQ section is for boosting or cutting the low-frequency range.
- 5 The *MID* control is for boosting or cutting the mid-range frequencies.
- 6 *TREBLE* controls the high-frequency range of the selected preset.
-  **The LED rings around the *VOLUME*, *BASS*, *MID*, *TREBLE*, *GAIN*, *EFFECTS MIX* and *REVERB* controls each have nine LEDs. On each ring either one LED or two neighboring LEDs (in between position) will light up at a time, indicating a total of 17 different positions.**
-  **If the *TAP* key 11 is down, the *TREBLE* control functions as a *PRESENCE* control. This enables you to boost/cut a high-frequency filter tuned to whatever amp model is active, thus simulating the frequency-dependent coupling of tube amps.**
- 7 The *AMPS* control is for selecting one of 32 different amplifier simulation models. The control is surrounded by a ring of 16 LEDs. Each LED corresponds to two types of amplifier. The first 16 simulations can be selected by turning the *AMPS* control (V-AMP PRO/V-AMP 2: white, V-AMPIRE: black).

V-AMPIRE/V-AMP PRO/V-AMP 2

To select the simulation models 17 - 32 (V-AMP PRO/V-AMP 2: gray, V-AMPIRE: white), press down the TAP key while making your selection by turning the AMPS control.

The LED “17 - 32” in the bottom left-hand corner of the DISPLAY indicates that one of the simulation models 17 - 32 has been selected.

In addition, you can activate a PREAMP BYPASS by pressing the key combination TUNER [9] and TAP [11]. If PREAMP BYPASS has been selected, none of the LEDs on the AMPS control lights up. To disable PREAMP BYPASS, simply select a different amp model or press both keys again.

[8] These five keys are for selecting a preset (A - E) within one bank.

In EDIT mode (activated by simultaneously pressing the arrow keys described in [10]), the keys perform the function printed directly above them:

▲ **A:** Accesses the *MIDI* functions. Use the arrow keys to set the MIDI channels (1 through 16) for transmitting and receiving MIDI data.

If you use key A in EDIT mode to select the MIDI function and then press the TAP key, the MIDI OUT connector is set to act as a MIDI THRU. In this setting (the TAP LED is lit) no MIDI data is sent, but the device passes on the signal received at the MIDI IN connection.

▲ **B:** Selects the *DRIVE* function. This noticeably raises distortion and volume. Use the arrow keys to switch DRIVE on and off. The DRIVE function is wired pre GAIN control.

While editing the DRIVE function, you can also activate and adjust the Wah-Wah effect by turning the EFFECTS control. The LEDs surrounding the EFFECTS control indicate the position of the pedal. If none of the LEDs lights up, the Wah-Wah is not activated.

▲ **C:** This key activates the *CABINETS* mode. Use the arrow keys to select the type of speaker or combination of speakers you want. You can also switch off the speaker simulation completely (“-”). For further details, please refer to chapter 5.2.

▲ **D:** Use this key to select the *REVERB* function. The arrow keys can be used to select one of nine different types of reverb in addition to the multi-effects processor. For further details see chapter 6.3.

▲ **E:** Here you can activate the *NOISE GATE* function. Use the arrow keys to adjust the noise reduction threshold.

After preset editing, please press TUNER/EXIT to quit (the EDIT MODE LED dies out).

DIGITAL OUT: The digital output (V-AMP PRO only) can be configured if keys A and B are pressed simultaneously. The display reads either “SP” for S/PDIF or “AE” for AES/EBU. Switch between these two formats using the TAP key. The LEDs in the display show whether you have chosen internal synchronization (with 44.1, 48 or 96 kHz sample rate) or external synchronization via word clock (see tab. 2.1 in this user’s manual). Use the arrow keys to select the appropriate sample rate with respect to the receiving device. The TUNER/EXIT key allows you to quit the DIGITAL OUT configuration.

CONFIGURATION: If you press the D and E keys simultaneously (B and D on the V-AMP 2), you can select the general operating mode of your device allowing adjustments to different studio and live situations (see chapter 3). Press TUNER/EXIT to quit configuration.

[9] The *TUNER* button is for switching on the tuner. In addition, this button can be used to quit EDIT mode (“Exit”).

[10] Use the two arrow keys to select a different bank (*BANK DOWN* and *BANK UP*). You can skip banks by holding each of the keys down. To activate the EDIT mode, press both keys simultaneously. If you press one of the keys A - E ([8]) in that mode, the arrow keys can be used for setting parameters.

[11] The *TAP* button performs seven functions:

▲ **“Tap”:** Tap the rhythm of a piece of music on the TAP button and the selected effect automatically adapts to the tempo of the music.

▲ **“Presence”:** While holding down the TAP button, you can use the TREBLE control to change the PRESENCE setting of the amp model you’ve selected.

▲ **“2nd parameter”:** You also can access the second effects parameter set by using the EFFECT control while holding down the TAP button.

▲ **“Amp models 17 - 32”:** Keep the TAP button pressed down and select an amp model using the AMPS control.

▲ **“MIDI Thru”:** The MIDI OUT connector can be set to act as MIDI THRU (see [8] A).

▲ **“Drive”:** Using the TAP button and the EFFECT control changes the sound of the Wah-Wah effect.

▲ **“Input Gain”:** By pressing the TAP button in the configuration menu (see [8]) you change the value (please refer to chapter 3.1 for further information).

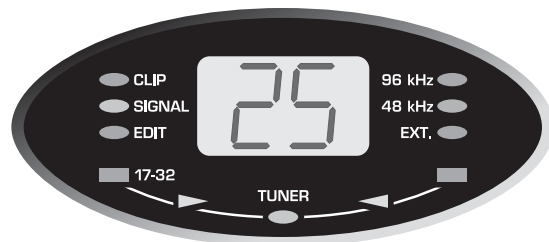

Fig. 2.1: V-AMP PRO display

Clock	LED ext.	LED 48 kHz	LED 96 kHz
internal 44.1 kHz	-	-	-
internal 48 kHz	-	✓	-
internal 96 kHz	-	-	✓
external (any frequency)	✓	-	-





Tab. 2.1: Output formats and display LED assignments

[12] The *DISPLAY* shows you which preset bank you have selected and gives you information on parameter changes when you are editing. In *TUNER* mode the *DISPLAY* shows the pitch of the instrument connected to the unit. If one of the amplifier simulations 17 - 32 has been selected, the LED in the bottom left-hand corner of the *DISPLAY* lights up. Additionally, the *DISPLAY* reads the digital format output and the sample rate (V-AMP PRO only) and illustrates whenever the V-AMP PRO is synchronized by an external word clock signal (EXT.). Applied signals are indicated by the green *SIGNAL* LED, overload signals by the red *CLIP* LED (V-AMPIRE and V-AMP PRO only).



[13] This control is for selecting an effect or a combination of effects. This encoder-type rotary control is also surrounded by a ring of 16 LEDs. Each LED corresponds to one specific effects preset.

[14] Using the *REVERB* control, you can add the reverb content of your choice to your overall sound. By turning it to the left until all the LEDs are off, you deactivate the reverb. To fade out the original signal, turn the control to the right until only the last LED lights up.

V-AMPIRE/V-AMP PRO/V-AMP 2



- [15] If an effect has been selected via [13], its part of the overall sound can be set using this *EFFECTS* control. If you select the “Compressor” effect, you can use the *EFFECTS* control to adjust the compression intensity. Turning the control to the left until all the LEDs are off disables the effect. This is known as an effects bypass.
-  **By pressing the TAP key, you can set a second effects parameter using the EFFECTS control (see tab 6.1).**
- [16] The *MASTER* control determines the overall volume of your device.
-  **This is, besides the AUX LEVEL control of the V-AMP 2, the only “conventional” and non-programmable control. All the other controls are encoder-type rotary controls whose settings can be stored in a preset.**
- [17] The *INPUT* socket is the 1/4" connector for your guitar. Please use a standard 1/4" TS connector.
- [18] The *LINE IN* (V-AMP PRO only) switch determines which signal source is processed by the V-AMP PRO, either (switch not pressed) the signal applied at the high-impedance *INPUT* connector, for example, your guitar, or (switch pressed) the line signal connected to the *PRE DSP INSERT* (*LINE IN*, [20]).
- [19] The stereo *PHONES* connector allows you to monitor the audio signal with standard headphones (e.g. BEHRINGER HP series).
-  **Your V-AMPIRE/V-AMP PRO/V-AMP 2 automatically activates studio mode 1 (S1) when connecting headphones. In this mode the digital speaker simulations are activated. With the headphones plugged in, you are able to select any other configuration, e.g. for monitoring purposes (see also chapter 3).**
-  **If you did not choose a speaker simulation with the current setting and connect headphones, the device will automatically switch to a speaker simulation. This will increase the listener’s sound impression. Please refer to table 5.2 for detailed information on the various speaker/amp combinations. However, you can intentionally change or deactivate the simulation when using headphones by selecting “-” in the CABINETS mode (see [8] C).**

2.2 Rear panel/side

- [20] Both V-AMPIRE and V-AMP PRO feature a serial insert path for external effects, such as a Wah-Wah pedal. Connect the *SEND/LINE OUT* connector to the input of your effects device. The *SEND/LINE OUT* output is taken directly pre-digital processor (*PRE DSP*), which means you can use this connector also to record a “dry” direct signal without any effect added. Connect the *RETURN/LINE IN* connector to the output of your external effects device.
-  **When using the serial insert path, please do not set the effects device to 100% effects signal (“wet”); otherwise, the direct signal will be missing.**
-  **Press the *LINE IN* key [18] to route the signal applied at the *RETURN/LINE IN* to the V-AMP PRO. This function is useful, for example, to monitor a “dry” guitar signal with the V-AMP PRO before adding any effects.**
-  **As soon as the VAMPIRE’s *LINE IN* (Return) is connected, the signal is automatically routed to the DSP. The input signal from the front will then be interrupted.**
- [21] The *ANALOG LINE OUTPUTS* provide the stereo signal without analog speaker simulation applied (V-AMPIRE and

V-AMP PRO only). Use these connectors, for example, to connect an external amp on stage.

The balanced *LINE OUTS* of the V-AMP 2 provide a stereo signal, e.g. for recording applications.

-  **You may use balanced or unbalanced plugs with the *LINE OUTS*.**
- [22] Connect the *POST DSP INSERT RETURN (IN)* pair of stereo 1/4" connectors to the outputs of your external stereo effects device and use this path to return the signal sent out from the *POST DSP SEND (OUT)* outputs [25].
- [23] The *GROUND LIFT* switch disconnects (switch pressed) the ground connection at the *DI OUT* outputs [24] to effectively eliminate hum noise resulting from ground loops.
- [24] The *DI OUT* output provides the balanced stereo signal of your V-AMPIRE/V-AMP PRO. Connect this output to two balanced microphone inputs on your mixing console. With configuration modes L1 and L2 the maximum level reduction is -10 dBu so that you can directly connect them to the mic inputs of your mixing console.
- [25] The *POST DSP SEND (OUT)* stereo output (V-AMP PRO only) allows you to connect the inputs of an external stereo effects device. The signal provided here is the same as the signal present at the digital outputs. Unlike the *SEND/LINE OUT* output [20] this signal is post-DSP. If the two corresponding *RETURN (IN)* connectors [22] are not used, the *ANALOG LINE OUTPUTS* [21] provide an identical signal.
- [26] The *S/PDIF* output provides the digital output signal of your V-AMP PRO.
- [27] The *AES/EBU* output (XLR connector) delivers the digital signal of your V-AMP PRO in an AES/EBU format, provided that AES/EBU has been selected as digital output format (please refer to the 2nd note under [8] E).
-  **The coax-type S/PDIF and balanced AES/EBU output are using the same output transformer and must therefore not be used at the same time. To change between the S/PDIF and AES/EBU formats please select the digital out menu (see [8]).**
- [28] The *WORDCLOCK* BNC connector is used to connect equipment for the external synchronization of your V-AMP PRO. This high-impedance connector has no internal terminating resistor (75 Ohms).
- [29] This is the *MIDI OUT/THRU* connector. It is configured as *MIDI OUT* but can be set to act as a *MIDI THRU* connector (see [8] A).
- [30] Use the *MIDI IN* to connect a foot controller, for example, the BEHRINGER *MIDI FOOT CONTROLLER FCB1010* (see chapter 8.3 for details).
- [31] *SERIAL NUMBER*.
- [32] *FUSE HOLDER/VOLTAGE SELECTOR* (V-AMPIRE/V-AMP PRO only). Before connecting the unit to the mains, make sure that the voltage setting matches your local voltage. A blown fuse should only be replaced by a fuse of the same type and rating. On some units, the fuse holder can be switched to one of two positions, i.e. 230 V and 120 V. When operating the unit outside Europe at 120 V, a higher fuse rating is required (see chapter 8 “INSTALLATION”).
- [33] The mains connection is on an *IEC* receptacle (V-AMPIRE/V-AMP PRO only). An appropriate power cord is included.
- V-AMP 2: Connect the enclosed power supply unit via the *AC IN* socket. If it is connected to the mains, your V-AMP 2 will switch on automatically.
- [34] Connect the stereo connector of your FS112V footswitch (included) to the *FOOTSWITCH* socket (V-AMPIRE/V-AMP 2 only). This will enable you to recall the presets from one

V-AMPIRE/V-AMP PRO/V-AMP 2

bank. To switch on the tuner, hold down the DOWN button on the footswitch for more than two seconds. You can also switch the tuner off again using the same button.

- [35] The *AUX IN* connector socket (V-AMPIRE and V-AMP 2 only) enables you to feed in additional stereo signals on the V-AMP 2, to play with a drum computer or playback etc.
- [36] The *AUX LEVEL* control (V-AMPIRE and V-AMP 2 only) is used for determining the volume of the signal received at the AUX IN input.
- [37] These outputs (V-AMPIRE only) are for connecting two external loudspeakers.

 **Without external loudspeakers the internal speaker runs at 70 Watts mono. The left output (the internal speaker automatically shuts off) allows to connect a loudspeaker with 4 Ω of impedance and 120 Watts power. At the right output you may connect an 8 Ω/60 Watts speaker that runs together with the internal speaker. Two speakers with 8 Ω/60 Watts each can be connected to the outputs (the internal speaker automatically shuts off). Our ULTRASTACK BG412 series suits this application ideally.**

3. OPERATING MODES AND APPLICATIONS

One outstanding feature of our V-AMP products is that you can choose yourself which parts of the signal you want to route to the outputs. To adapt your device perfectly to the various studio and live applications you can choose between 5 different operating modes (CONFIGURATIONS). Independent of the settings stored in the presets, these operating modes determine where the signal for the line outs and headphones comes from so that both left and right output signal can be used for different purposes.

The choice of your most suitable operating mode depends on where you use it. We have described some typical applications, distinguishing between particular features of the V-AMPIRE, V-AMP PRO and V-AMP 2 (see view sheet for details).

 **With the headphones plugged, the device automatically switches into studio 1 (S1) operating mode.**

3.1 Selecting an operating mode in CONFIGURATION mode

The settings of the configurations are made in the configuration menu by pressing the buttons D and E (B and D for the V-AMP 2). The display shows the current configuration. Use the arrow keys to select another configuration. Please refer to table 3.1 for information on the corresponding output signals.

 **By pressing the TAP key and adjusting the GAIN control you can additionally adapt the input amplification to particularly loud pick ups.**

In the configuration menu you can adapt the input gain to different pick up types. To do this, keep the TAP key pressed and the surrounding GAIN control LEDs show the current setting. Turning the GAIN control from its center position to the left you will reduce the input amplification which probably is recommendable with very loud pick up types. GAIN settings in clockwise direction are only recommended with very weak pick up types.

Quit the configuration menu by pressing TUNER/EXIT.

3.2 Rehearsal or recording at home

When using headphones, all three V-AMP models will switch into studio mode 1 (S1). This mode is particularly suitable for rehearsals or when recording/monitoring a stereo signal. You could also use live mode 1 (L1) which applies an additional 3-band EQ.

One advantage of rehearsing at home is that there is often a computer available which allows you to design, edit, send, receive and archive new presets comfortably and effectively. Download our V-AMP DESIGN software free of charge at www.v-amp.com. You can create your own presets even with minimum system requirements (Windows PC with MIDI interface or gameport MIDI adapter). On the V-AMP homepage you also find an online preset database (ULI, user library interface) with plenty of presets created by other V-AMP users and famous artists. Here, you can upload your own favourite presets and make them accessible for other users.

Using studio mode 2 (S2) at home can be a good idea when it comes to recording an amp sound without effects ("dry") but monitoring it with effects ("wet"). Working this way, you are able to choose the effects you want later during mixdown. In this case you would route the left output to the soundcard of your computer and monitor the right output via your mixing console.

3.2.1 V-AMPIRE

Figure 1.3 on the view sheet shows a typical home application. We recommend modes S1, L1 or L2.

S1 comprises all amp, speaker and effects simulations. The same applies to mode L1 which also includes the 3-band EQ for additional sound adaptation. Mode L2 works similarly but here the digital speaker simulation is switched off and our analog ULTRA-G simulation is enabled on the XLR or phones outputs.

 **When connecting headphones, the amp signal is automatically muted. Thus, if you unplug the headphones we strongly recommend to turn the MASTER control to the very left. The XLR output is independent of the MASTER control setting. This allows to take out a line signal for recording purposes while the MASTER control is set to minimum.**

As with the V-AMP 2 the stereo AUX input enables you to play back line signals like CDs, drum computer etc.

3.2.2 V-AMP PRO

In the studio, monitoring will be performed at the mixing console, and for this reason there is no need for an aux input on the V-AMP PRO.

Figure 2.4 of the view sheet shows how to connect the V-AMP PRO to the digital input of a PC in a recording application. Possible digital inputs on the PC are balanced AES/EBU or coax-type S/PDIF inputs. When the V-AMP PRO's digital output is set to 44.1, 48 or 96 kHz, the PC has to synchronize with the V-AMP PRO, i.e. in clock slave mode. If the PC or any other device is intended to work as clock master, the V-AMP PRO has to be synchronized externally via the wordclock input. The sample rate depends on the wordclock signal but must range between 32 to 96 kHz.

In addition, figure 2.4 shows an effects device connected to the Pre DSP INSERT in order to edit the input signal before any digital simulations. To do this, the LINE IN button has to be pressed.

Depending on your application, we recommend studio mode S1 or S2. Mode S1 includes all amp and speaker simulations with effects in stereo while S2 has the effects at the right output only allowing you to record this track "dry" and add effects later at mixdown.

3.2.3 V-AMP 2

While rehearsing with your V-AMP 2, you are able to connect any kind of playback or a metronome in the AUX stereo input and adjust its level with the AUX LEVEL control (see fig. 3.3 on the view sheet). For monitoring you can take the line outputs to an amplifier, like our EUROPOWER series, or to a stereo, or you can use headphones connected to the phones output.

Fig. 3.4 on the view sheet shows the previously mentioned arrangement for S2.

3.3 Live on stage or in a rehearsal room

Since neither the V-AMP PRO nor the V-AMP 2 are fitted with speakers, some additional gear will be needed to hear the sound. If you are using a sound reinforcement system, it is a good idea to make sure that either the analog ULTRA-G or one of the programmable digital speaker simulations is active.

3.3.1 V-AMPIRE

Not only does the V-AMPIRE has its own built-in speaker, which means you can plug in and play without further equipment, the V-AMPIRE also allows to connect a second external loudspeaker. Using the left speaker output mutes the internal speaker, diverting the full 120 W to the external 4 Ω speaker (see fig. 1.4). This makes sense particularly if the external speaker has a specific sound which cannot be recreated using the internal speaker.

You can also connect to an external stereo speaker arrangement, e.g. our BG412S. In this configuration the V-AMPIRE develops 2 x 60 W into 8 Ω per side. This lets you take full advantage of the V-AMPIRE's stereo effects (fig. 1.5).

Alternatively, an external 8 Ω speaker may be connected to the right speaker output. This also represents a stereo configuration, because the internal speaker is not muted, as shown in fig. 1.6.

The starting configuration for this application would be L2, i.e., a stereo signal with all effects, amp simulation and live EQ but no speaker simulation. The ULTRA-G speaker simulation is available at the XLR output and thus connectable to a sound reinforcement system. Here, the MASTER control only influences the stage volume but not the XLR output. If you want to listen to a digital speaker simulation using an amplifier, select L1.

3.3.2 V-AMP PRO

Because of its additional outputs and the analog ULTRA-G speaker simulation the V-AMP PRO is even more flexible on stage. Figure 2.5 shows a stereo application with active stage monitors which are connected to the unbalanced line outs. Use the MASTER control to set the volume of the monitor speakers while the XLR output signal is sent at full volume to a sound reinforcement system. The appropriate modes are S1 or L1 depending on whether the 3-band EQ is needed or not.

Since the receiver of the wireless system is connected to the rear line input, the line input switch on the front has to be pressed. Use this switch also to mute the signal while you change your guitar.

Figure 2.6 displays a very similar application: The monitor amp in this case is a guitar amp so that mode L2 (no speaker simulation) is recommendable.

3.3.3 V-AMP 2

Figure 3.5 on the view sheet shows the V-AMP 2 connected from its line out to the line input of the guitar amp or head. Using the instrument input would not be the best idea since the signal is passed through the whole pre amplifier stage. BEHRINGER offers a wide range of guitar amps which are equipped with an aux input and thus are perfect for this application. Since a guitar amp already has its own sound, a digital speaker simulation is not needed. We therefore recommend mode L2.

Figure 3.6 describes another speciality of the V-AMP 2 in mode L3: A guitar amp is used as monitor speaker on stage while simultaneously a second signal is sent to a sound reinforcement system. By doing so, you can completely eliminate the need for miking the amp.

A special feature of the L3 mode is that the signal to the guitar amp has no speaker simulation, instead it has an additional 3-band EQ which allows you to tailor your on-stage sound. The signal for the sound reinforcement system remains unaffected by the 3-band EQ, but it does include the speaker simulation. This simulation is necessary to reproduce the character of a guitar cabinet sound using the speakers of the sound reinforcement system.

3.4 Recording

For this applications we assume that at least a mixing console and a recording device is available.

3.4.1 V-AMPIRE

As with rehearsals at home or anywhere else, the V-AMPIRE can be connected directly to a mixing console or recording device via its XLR outputs. In addition, you can use the pre DSP insert send to record the same direct guitar signal without needing another DI-box for impedance adaption.

Since the usual volume problem does not exist in studio environments, the V-AMPIRE has more to offer than those features described in chapter 3.2.1. In the studio you can raise the volume to take full advantage of the V-AMPIRE's own sound. If you have a particular speaker cabinet with its own sonic character you can drive it via the speaker output. You will need to use a microphone to capture this special sound. If you want to create intentional feedbacks from the speaker, you can still feed the XLR output into the console to be recorded. We recommend mode L2, with 3-band EQ but without digital speaker simulation (see fig. 1.4).

3.4.2 V-AMP PRO

For studio applications we recommend modes S1, S2 or S3. S1 reproduces all amp and speaker simulations with effects in stereo (as with the V-AMP 2) while with S2, the effects are applied to the right channel only. In mode S3, the digital speaker simulation is shut off for the case that the speaker sound is to be determined later during mixdown. Therefore, in S3 mode the proven ULTRA-G speaker simulation is switched to the XLR and headphones outputs. When recording in S3 mode, the monitoring should thus be done at the analog XLR and headphones outputs and not at the digital outs. If you want to record the original guitar signal you could use the setup shown in fig. 2.3. Press the LINE INPUT switch if you want to monitor the recorded signal via the V-AMP PRO. We recommend to use modes S1 or L1. Mode S2 is an alternative if you want to adjust the effect ratio on the mixing console.

 **Please note that the ULTRA-G speaker simulation in modes S3 and L2 only affects the XLR and headphones outputs and does not have any influence on the digital outputs.**

3.4.3 V-AMP 2

To record a stereo signal with all effects, amp and speaker simulations, select modes S1 or L1 (with 3-band EQ) and connect the balanced line outs with the mixing console or recording device. This advantage is a disadvantage at the same time:

You hear the sound exactly the way you record it. So if you decide to make a change, you will need to record the whole track again.

With studio mode S2 all effects are therefore put out through the right channel only, while on the left channel you will find the amp and speaker simulations. This enables you to record the dry amp signal and determine the effects later on during mixdown (see fig. 3.4).



V-AMPIRE/V-AMP PRO/V-AMP 2

Configuration	V-AMPIRE/V-AMP PRO		V-AMP 2	
	OUTPUTS L	OUTPUTS R	OUTPUTS L	OUTPUTS R
Studio 1 (S1)	Stereo operation with effects, amp and speaker simulation		Stereo operation with effects, amp and speaker simulation	
Studio 2 (S2)	Amp and speaker simulation, dry without effects	Amp and speaker simulation with effects	Amp and speaker simulation, dry without effects	Amp and speaker simulation with effects
Studio 3 (S3)	Amp simulation, dry without effects	Amp simulation with effects		
	Phones/XLR outputs with analog ULTRA-G speaker simulation			
Live 1 (L1)	Stereo operation: Speaker and amp simulation, 3-band EQ + effects		Stereo operation: Speaker and amp simulation, 3-band EQ + effects	
Live 2 (L2)	TRS outputs Stereo operation: Without speaker simulation but with 3-band EQ, amp simulation and effects		TRS outputs Stereo operation: Without speaker simulation but with 3-band EQ, amp simulations + effects	
	Phones/XLR outputs with analog ULTRA-G speaker simulation			
Live 3 (L3)			Amp simulation with 3-band EQ and effects but without speaker simulations	Amp-, speaker simulation and effects but without 3-band EQ

Tab. 3.1: Configurations

If you want to go the safe way, we recommend to split up the input signal with a high-quality active DI-box, e.g. the BEHRINGER G1100. To do this, connect the guitar to the G1100 input, the direct link to the input of your V-AMP 2 and the XLR output to the recording device. In that manner, you can record the direct guitar signal with the amp simulation on one channel each and listen to the complete signal with all effects on your headphones (see fig. 3.4).

4. PRESETS

Your device features 125 overwriteable presets divided into 25 banks. In other words, there are five presets available per bank. Each preset consists of a maximum of five "ingredients":

- ▲ amp simulation (including GAIN, EQ and VOLUME settings)
- ▲ cabinet simulation
- ▲ pre-amp effect, such as noise gate, compressor, auto wah and wah-wah
- ▲ post-amp multi-effect, such as delay, modulation effect, or a combination of both
- ▲ reverb effect

The enclosed sheet shows an overview of all the presets.

4.1 Calling up presets

When the unit is switched on, it automatically loads the last used preset. In the following example, the last preset selected was preset D in bank 25:

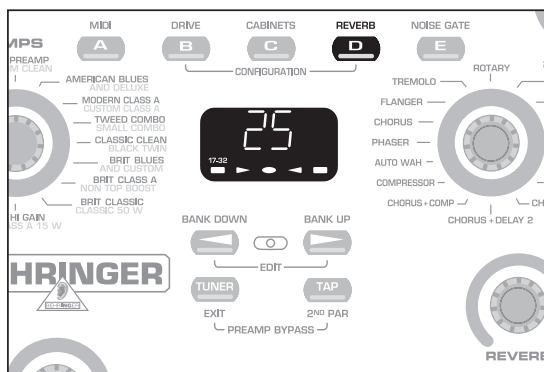

Fig. 4.1: Calling up presets on the V-AMP 2 (similar to V-AMPIRE and V-AMP PRO)

In this case, by pressing button A, B, C or E you can immediately call up another preset of the same bank. The two arrow keys (BANK UP and BANK DOWN) enable you to switch banks. The display always shows which bank has been selected. When you switch banks, the preset has to be called up by pressing one of the buttons A - E. One LED lights up to show you which preset in the respective bank has been activated.

4.2 Editing presets

Editing presets is fast and simple. One option is to call up a preset you like and then start editing it. Select an amp model by means of the AMPS encoder. The LED on the preset button flashes (e.g. D) and signals that you have made a change to the preset.

Now change the settings of the VOLUME, BASS, MID, TREBLE and GAIN controls as you like. If you select an effect, you can adjust its ratio in the overall sound using the EFFECTS control. You then switch to EDIT mode by pressing the arrow keys simultaneously. If you use buttons B - E to activate the DRIVE, CABINETS, REVERB and NOISE GATE functions respectively and then edit using the arrow keys, the value of the respective parameter is shown in the display. To quit EDIT mode, briefly press the TUNER button.

If you hold the TAP button down while using the TREBLE control, you can raise or lower an additional high-frequency filter (PRESENCE). This simulates the frequency-sensitive coupling of tube amps.

⚠️ Apart from compressor and auto wah, all the multi-effects have a speed-based parameter. Say you want to set the effect you've selected to the tempo of your playback: just tap the TAP button twice in time to the music and the effect tempo will match the tempo of your piece.

4.3 Storing presets

To store your edited preset, hold down the preset button required for approx. 2 seconds for the preset to be overwritten (the corresponding LED lights up throughout).

⚠️ You do not necessarily have to store your edited preset in place of the original preset selected. If you choose a different storage position, select the preset bank you want using the arrow keys (BANK UP and BANK DOWN). You can store your changes by holding down the preset button for approx. two

V-AMPIRE/V-AMP PRO/V-AMP 2

seconds. For example, you can edit a preset originally stored in bank 5, position D, and then store it in bank 6, position A.

4.4 Discarding an edited preset/restoring a single factory preset

If you have edited a preset and find that you don't like the edited version, you can, of course, discard it. Let's assume you've selected and then edited preset C (the corresponding LED has lit up), but you would now like to return to the configuration stored previously. Simply select another preset. The next time you call up the preset, the temporarily edited version is discarded. After editing, you can also hold down the two arrow keys until "Pr" appears in the display, which brings back the factory preset that was originally stored there. However, you then have to save it again by holding down the corresponding preset button for approx. two seconds.

4.5 Restoring all factory presets

All factory presets can be restored as follows: Hold down buttons D and E and then switch on the device. "CL" appears in the display. Now release the two buttons and press the two arrow keys simultaneously. This erases all the edited presets you have stored and restores the factory presets. Please refer to chapter 8.3.1 if you need information on how to save your settings via MIDI.

5. AMP/SPEAKER SIMULATION

The very heart of the V-AMP sound is its amp/speaker simulation. The 32 simulation models can make work in a home recording studio very much easier because it isn't necessary to mike up the guitar amp. With the V-AMPIRE/V-AMP PRO/V-AMP 2 it is child's play for you to choose one of the legendary guitar amps, be it for Brit Pop, Blues, Heavy Metal or whatever. In addition, you can tailor the sound of the respective amp to suit your ideas and then connect it virtually to one of 15 speaker simulations (cabinets). On top of all that, you can even choose digital effect and reverb types for your virtual amp. See chapter 6 "EFFECTS PROCESSOR" for more details.

When you switch on the device, it automatically loads the last preset selected. The LED ring around the AMPS control shows which amp has been selected. The corresponding LED lights up. To select another amp simply turn the control. Use the VOLUME, BASS, MID, TREBLE and GAIN controls to modify the basic sound of the amp. Hold down the TAP button and turn the TREBLE control to raise or lower an additional high-frequency PRESENCE filter (see [6]).

As a rule, you will want to select an amp first, then a cabinet and finally an effect. See chapter 4 for how to store your modifications. To give you a better overview of the extensive range of amp simulations, we have compiled the following descriptions of the different types of amp.

 **When you select an amp simulation, an appropriate speaker simulation is activated automatically (see tab. 5.2). Otherwise, the authenticity of the sound could be affected by an unsuitable cabinet—especially if you are using headphones. Naturally, you can combine the amp simulations with other cabinets according to taste.**

5.1 Amp descriptions

AMERICAN BLUES: This virtual amp is modelled on the Fender Bassman 4 x 10 Combo. Originally designed as a bass amp, it soon became a standard amp of blues legends such as Steve Ray Vaughan or Billy Gibbons due to its characteristic distortion. As you would expect, it packs a solid punch in the bass range, but is still flexible enough in the mid and treble ranges.

AND DELUXE: A synthesis of a 1960 Fender Blackface Deluxe and a '50s Fender Bassman. The result is a crystal-clear sound that still simulates the edge of the vintage amps. The sound control gives you even greater scope than the EQ controls on the originals.

MODERN CLASS A: This amp is characterized by its slight distortion and sounds almost like hi-fi. It is modelled on the Matchless Chieftain, a very expensive, hand-made amp.

CUSTOM CLASS A: The model for this simulation is the Budda Twinmaster. This Class A amp is renowned for its warm sound combined with irresistible tube distortion. Although the original amp does not have a mid control, we have given the capability of suiting the mid range to your taste.

TWEED COMBO: This was Jeff Beck's favorite when he recorded the albums *Blow by Blow* and *Wired*. This amp was not actually designed for heavy distortion, but due to its low power, it is ideal for uncompromising overdrive sound.

SMALL COMBO: This model is based on the 1960 Tweed Champ. The main attraction of this amp simulation is when the DRIVE function is used a lot. Although this amp was actually designed for beginners on the guitar, it soon became a favorite amp of many guitar aficionados. The reason for that was that it produced an amazingly distorted sound even at low volume.

The Tweed Champ had a volume control, but no EQ control. If you want to get the most authentic sound out of this amp, keep the sound control on your V-AMPIRE/V-AMP PRO/V-AMP 2 in the mid position.

CLASSIC CLEAN: Back in the '80s, the Roland JC-120 was the preferred sound of Buzzy Feiten (guitarist with the Dave Weckl Band). The unique quality of this transistor amp's sound is the way its brilliance cuts through any mix. It is ideal for the New Wave sound of the 80s that is making a come-back today. By the way, the JC-120 was also popular among Fender Rhodes pianists.

BLACK TWIN: This simulation was modeled on a Fender Blackface Twin from 1965. In the '60s this amp was used by jazz, country and even rock guitarists. What was unique about it was that it was exceptionally loud and was therefore mainly used for live performances. The secret of the Blackface Twin was that although you could play it extremely loud, the distortion remained relatively low.

BRIT BLUES: Modeled on the JTM 45, the first Marshall amp ever. This, by the way, was Eric Clapton's favorite amp when he was with Cream. The JTM 45 was the forerunner of many of Marshall's later amps with their distinctive, powerful sound. Extreme gain settings produce a highly compressed and really "dirty" sounding distortion. Combined with a 2 x 12" speaker simulation it produces impressive Bluesbreaker sounds.

AND CUSTOM: This simulation is based on a 1965 Marshall JTM 45 Bluesbreaker but has more flexibility of sound control. Turn the GAIN control to the left and this simulation sounds like a Marshall; turn it to the right and it is more reminiscent of the Budda.

BRIT CLASS A: This simulation is modeled on the Vox AC 30. This amp was originally designed in the '60s when guitarists wanted amps with enhanced brilliance, a feature that Vox successfully implemented by means of "revolutionary" bass and treble controls. Brian May and U2's The Edge are probably the best-known users of this sound.

NON TOP BOOST: This is a Vox AC 30 as used by Bryan Adams in the recording studio. Unlike the well-known AC 30 with treble boost, the former amp version did not have this feature. This simulation copies the original amp's "normal" channel.

BRIT CLASSIC: Based on a 1959 Marshall Plexi 100 Watt, this amp is ideal for producing clean sounds. It was used by Jimi Hendrix, Eric Clapton and Jeff Beck.



V-AMPIRE/V-AMP PRO/V-AMP 2

CLASSIC 50 W: This is also a Plexi, but we have extensively widened its sound range. The sound controls on the original Marshall Plexi 50 Watt hardly had any effect on the sound if distortion was high.

BRIT HI GAIN: Compare this model with a Marshall JCM 800. Although the original was renowned mainly for its distorted sounds, this amp also sounds very good with low gain settings. It's good at reproducing Steve Ray Vaughan's and Michael Landau's sounds. In distortion mode it sounds like Gary Moore in his early days, but it's also good for heavy metal.

BRITISH CLASS A 15 W: Another Vox model, based on the first channel of an AC 15 from 1960. Unlike the AC 30 this amp had only one 12" speaker, instead of two, and produced a warmer sound. Tip: to make this simulation sound as authentically as possible, leave the BASS and MID controls in mid-travel position and vary the TREBLE control only.

NUMETAL GAIN: This model is based on a 1994 Mesa Boogie Dual Rectifier Trem-O-Verb featuring a modern, high-gain sound that also comes over well in a band context. The tone control is post-gain, which allows you to tailor distorted sounds to great effect. This amp is perfect for heavy metal, but also for Steve Lukather sounds. The best-known user of this amp is Dream Theater's guitarist John Petrucci.

NUMETAL HEAD: This simulation is modeled on a Mesa Boogie Dual Rectifier top. Unlike the Trem-O-Verb, this amp produces a more modern high-gain sound. The tone control is most effective at high gain settings.

MODERN HI GAIN: Here, too, the tone control is post-gain, allowing the extremely distorted sound to cut through the mix. The MODERN HI GAIN sound is ideal for playing Grunge, but is also used by guitarists such as Steve Vai and Joe Satriani. Among others, Steve Lukather, Nuno Bettencourt and Steve Vai have all popularized the Soldano sound. If you're playing a Gibson Les Paul, MODERN HI GAIN sounds best when you turn down the volume control on the guitar a little.

SAVAGE BEAST: Engl is well-known for amps that really cut through. The Savage 120 in particular has built up a large following among guitarists. For some time now Ritchie Blackmore has been a major endorser of this German company, and Randy Hanson, the best Hendrix since Jimi, also swears by this amp. The unique feature of the Savage is its extreme power and is therefore highly popular with heavy metal guitarists. Silent Force/Sinner guitarist Alex Beyrod has been an enthusiastic Engl user for years. An amp for making yourself heard!

FUZZ BOX: This sound is not actually based on any one amp, but on a particular fuzz box. Jimi Hendrix was one of the first guitarists to recognize the potential in this legendary broadband transistor distortion. The humming distortion sound of the FUZZ BOX has returned to popularity with Alternative Rock and Grunge.

CUSTOM HI GAIN: This sound goes back to a 1969 50-Watt Marshall Plexi modified by Jose Arrendondo. Arrendondo was none other than Eddie Van Halen's guitar technician. The unique features of this amp are its fine mid-range sounds and its ability to produce the ultimate in gain without making the sound muddy. Warning: highly addictive!

ULTIMATE V-AMP: From clean to brutal hi-gain, this "brute" covers the entire range. The ULTIMATE V-AMP is basically a souped-up rectifier amp.

ULTIMATE PLUS: Those who find the ULTIMATE V-AMP too tame will find enough gain here for an overdose.

DRIVE V-AMP: This simulation is based on a more modern high-gain lead amp producing a soft but precise sound with plenty of drive, making it ideal for lead guitar work. The DRIVE V-AMP is modeled on the Mesa Boogie Mark III.

CALIFORNIA DRIVE: Based on the Mesa Boogie Mark II c, this is purely a simulation of its drive channel—definitely the right choice for Santana songs.

CRUNCH V-AMP: This amp is ideal for modern blues or jazz. Its sound is not too subtle, but not in-your-face either—it's crunchy, that's all.

CUSTOM DRIVE: This simulates the Dumble Overdrive Special—an amp that was at the top of many guitarists' wish-list but beyond their financial means. Dumble amps are hand-made and can be custom-built for the individual guitarist. What we've done here is simulate the drive channel of one of these rare Dumble amps.

CLEAN V-AMP: Here we have managed to simulate the sound of a Roland JC-120 and combine it with our BRIT CLASSIC model. The result is the brilliance of a transistor amp which, however, features the cutting power of a Marshall Plexi. Turn the GAIN control clockwise and the Marshall comes in.

CALIFORNIA CLEAN: This model is based on the clean channel of the Mesa Boogie Mark II c. It sounds a little like a Fender, but has more of a punch in the mid-range.

TUBE PREAMP: Sound engineers were quick to recognize the appeal of tubes. They used tube amps to add warmth to all kinds of sounds. This amp model is not only for refining guitar sounds. Try putting a vocal track through the V-AMPIRE/V-AMP PRO/V-AMP 2 and give it the finishing touch with TUBE PREAMP.

CUSTOM CLEAN: This simulation is of the clean channel on our Dumble amp. A clean sound that really cuts through, especially when used with compressor attack settings around 2 ms.

PREAMP BYPASS: In this setting, no amp simulation is selected. This makes it possible, for example, to play through an external guitar preamp and only use the effects or the speaker simulation. To activate the PREAMP BYPASS, press TAP and TUNER.

Fender™, Vox™, Marshall™, Mesa Boogie™, Gibson™, Soldano™, Matchless™, Dumble™, Budda™, Tweed™, Engl™, Roland™ and the names of musicians and groups are registered trademarks belonging to the respective owners and are in no way associated with BEHRINGER.

5.2 Speaker descriptions

The sound of any guitar combo depends largely on the type and combination of speakers used. In the past 50 years there has been widespread experimentation to find out what type of speaker is best suited to any one specific guitar sound and in what way the sound is modified when a certain speaker is combined with others.

 **When you select an amp simulation, an appropriate speaker simulation is activated automatically (see tab. 5.2). Otherwise, the authenticity of the sound could be affected by an unsuitable cabinet—especially if you are using headphones. Naturally, you can combine the amp simulations with other cabinets according to taste.**

The character of a loudspeaker is a combination of its power rating, impedance, sound pressure and size, as well as the material it is made of. 8", 10" and 12" speakers have established themselves as the best sizes for electric guitar amplification. The following table shows a list of all speaker cabinets on the V-AMPIRE/V-AMP PRO/V-AMP 2.

V-AMPIRE/V-AMP PRO/V-AMP 2

Cabinets	
-	BYPASS (NO SPEAKER SIMULATION)
1	1 x 8" VINTAGE TWEED
2	4 x 10" VINTAGE BASS
3	4 x 10" V-AMP CUSTOM
4	1 x 12" MID COMBO
5	1 x 12" BLACKFACE
6	1 x 12" BRIT '60
7	1 x 12" DELUXE '52
8	2 x 12" TWIN COMBO
9	2 x 12" US CLASS A
10	2 x 12" V-AMP CUSTOM
11	2 x 12" BRIT '67
12	4 x 12" VINTAGE 30
13	4 x 12" STANDARD '78
14	4 x 12" OFF AXIS
15	4 x 12" V-AMP CUSTOM

Tab. 5.1: V-AMPIRE/V-AMP PRO/V-AMP 2 cabinets

Amps 1 - 16	#	Loudspeaker simulation
AMERICAN BLUES	2	4 x 10" VINTAGE BASS
MODERN CLASS A	9	2 x 12" US CLASS A
TWEED COMBO	1	1 x 8" VINTAGE TWEED
CLASSIC CLEAN	8	2 x 12" TWIN COMBO
BRIT. BLUES	12	4 x 12" VINTAGE 30
BRIT. CLASS A	11	2 x 12" BRIT. '67
BRIT. CLASSIC	12	4 x 12" VINTAGE 30
BRIT. HI GAIN	12	4 x 12" VINTAGE 30
NUMETAL GAIN	15	4 x 12" V-AMP CUSTOM
MODERN HI GAIN	15	4 x 12" V-AMP CUSTOM
FUZZ BOX	14	4 x 12" OFF AXIS
ULTIMATE V-AMP	15	4 x 12" V-AMP CUSTOM
DRIVE V-AMP	15	4 x 12" V-AMP CUSTOM
CRUNCH V-AMP	15	4 x 12" V-AMP CUSTOM
CLEAN V-AMP	15	4 x 12" V-AMP CUSTOM
TUBE PREAMP	-	No cabinet simulation (for use with vocals)
Amps 17 - 32	#	Loudspeaker simulation
AND DELUXE	2	4 x 10" VINTAGE BASS
CUSTOM CLASS A	9	2 x 12" US CLASS A
SMALL COMBO	1	1 x 8" VINTAGE TWEED
BLACK TWIN	8	2 x 12" TWIN COMBO
AND CUSTOM	12	4 x 12" VINTAGE 30
NON TOP BOOST	11	2 x 12" BRIT. '67
CLASSIC 50 W	13	4 x 12" STANDARD '78
BRIT. CLASS A 15 W	6	1 x 12" BRIT. '60
NUMETAL HEAD	15	4 x 12" V-AMP CUSTOM
SAVAGE BEAST	13	4 x 12" STANDARD '78
CUSTOM HI GAIN	15	4 x 12" V-AMP CUSTOM
ULTIMATE PLUS	15	4 x 12" V-AMP CUSTOM
CALIF. DRIVE	4	1 x 12" MID COMBO
CUSTOM DRIVE	5	1 x 12" BLACKFACE
CALIF. CLEAN	4	1 x 12" MID COMBO
CUSTOM CLEAN	5	1 x 12" BLACKFACE

Tab. 5.2: Loudspeaker/amp simulation default settings

6. EFFECTS PROCESSOR

A special feature of your V-AMPIRE/V-AMP PRO/V-AMP 2 is its built-in multi-effects processor module offering 16 different groups of first-class effects such as chorus, flanger, delay, auto wah as well as various effects combinations.

The appendix gives an overview of all MIDI data transmitted and received by your device.

 **The standard operating mode of the multi-effects processor is stereo, so you can use stereo effects for recording purposes via the LINE OUT or play in stereo using a second amplifier.**

You can adjust up to 3 effects parameters on the V-AMPIRE/V-AMP PRO/V-AMP 2 by turning the EFFECTS control; by turning the EFFECTS control holding down the TAP button, and simply by pressing the TAP button while in time to the music.

 **To match speed-based effects to the tempo of the music, press the TAP button at least twice in time to the music.**



Effect No.	Effect	EFFECTS control	EFFECTS control with TAP key down	TAP key
1	ECHO CC49, val 1	Mix CC54	Feedback CC53	Delay Time CC50+51
2	DELAY CC49, val 0	Mix CC54	Feedback CC53	Delay Time CC50+51
3	PING PONG CC49, val 2	Mix CC54	Feedback CC53	Delay Time CC50+51
4	PHASER/DELAY CC55, val 1 + CC49, val 0	Delay Mix CC54	Mod. Mix CC59	Delay Time CC50+51
5	FLANGER/DELAY 1 CC55, val 5 + CC49, val 0	Delay Mix CC54	Mod. Mix CC59	Delay Time CC50+51
6	FLANGER/DELAY 2 CC55, val 5 + CC49, val 2	Delay Mix CC54	Mod. Mix CC59	Delay Time CC50+51
7	CHORUS/DELAY 1 CC55, val 3 + CC49, val 0	Delay Mix CC54	Mod. Mix CC59	Delay Time CC50+51
8	CHORUS/DELAY 2 CC55, val 3 + CC49, val 2	Delay Mix CC54	Mod. Mix CC59	Delay Time CC50+51
9	CHORUS/COMPRESSOR CC55, val 4 + CC44, val 1	Sense CC45	Mod. Mix CC59	Modulation Speed CC58
10	COMPRESSOR CC44, val 1	Sense CC45	Attack CC46	-
11	AUTO WAH CC44, val 2	Depth CC45	Speed CC46	-
12	PHASER CC55, val 1	Mix CC59	Feedback CC58	Modulation Speed CC56
13	CHORUS CC55, val 4	Mix CC59	Depth CC57	Modulation Speed CC56
14	FLANGER CC55, val 6	Mix CC59	Feedback CC58	Modulation Speed CC56
15	TREMOLO CC55, val 2	Mix CC59	-	Modulation Speed CC56
16	ROTARY CC55, val 0	Mix CC59	Depth CC57	Modulation Speed CC56

Tab. 6.1: Effects and MIDI controllers

 **Table 6.1 shows the MIDI controllers for the corresponding parameters. The settings are made via MIDI. A detailed list of all controllable MIDI parameters will be available free of charge on the BEHRINGER internet site: www.behringer.com.**

6.1 Wah Wah

The MIDI function enables you to use an additional Wah Wah effect. The optimum control of this effect is achieved by using a MIDI foot controller with expression pedal, e.g. our BEHRINGER MIDI FOOT CONTROLLER FCB1010.

 **Adjust the filter characteristic and grade in the DRIVE menu by simultaneously pressing TAP and turning the EFFECTS control (see also  B).**

6.2 Effect descriptions

The following section contains short descriptions of the effects that can be produced using the multi-effects processor.



6.2.1 Reverb and delay algorithms

REVERB: Reverb is still the most important effect for mixing or live performance. That's why we at BEHRINGER make a point of giving you as many as nine different reverb programs so that you can use the most suitable reverb program for any situation. The reverb effect can be added separately to all the other effects (see chapter 6.2).

ECHO: Echo is similar to the stereo delay effect in that it is a delayed repetition of the input signal. The main difference is that the high-frequency content of the repeated signals steadily decreases. This simulates a tape delay used in the pre-digital era, producing a "vintage sound". In addition, the reflections are routed in turn to the left and right channels, creating a quasi-stereo effect.

DELAY: This algorithm delays the input signal, with different tempo settings producing interesting delay effects. U2's The Edge has impressively demonstrated the potential of this effect.

PING PONG: A delay effect that changes position in the stereo image.



6.2.2 Modulation effects

PHASER: The principle behind the phaser is that a second, phase-shifted signal is added to the audio signal. This makes the sound richer and, above all, livelier. This effect is popular among guitarists and keyboard players alike, but was also used extensively in the '70s with other instruments, such as electric pianos. Depending on how you set it, the phaser can be used to produce slightly modulating or strongly alienating effects.

FLANGER: This effect is self-explanatory. Originally, the flanger effect was produced by running two synchronized tape recorders at the same time. The same signals (e.g. a guitar solo) were recorded on both machines. Putting a finger on the left reel of one of the machines caused it and the speed of the playback to slow. The resulting delay produced phase shifts of the signals.

CHORUS: This effect adds a slightly modulated off-key element to the original signal, thus creating a pleasant floating effect through variations in pitch.



6.2.3 Combinations of effect algorithms (multi-effects programs)

PHASER & DELAY: Phaser and delay combined.

FLANGER & DELAY: Here the input signal is delayed and processed with a pronounced wave-like effect. It is particularly effective for highlighting single notes, but can also be used to make solos more interesting.

CHORUS & DELAY: This algorithm combines signal delay with the popular chorus effect.

CHORUS & COMP: Incredible sustain effects can be produced with the compressor. This is especially useful for sustaining individual guitar notes. Combined with chorus, it can make the audio signal extremely dense.



6.2.4 Special effects

COMPRESSOR: A compressor limits the dynamic range of the audio material, thus producing audible and creative sound effects. Pronounced use of the compressor (using the EFFECTS control) allows you to compress the overall dynamic range of the material.

AUTO WAH: The legendary wah-wah effect owes its fame mainly to Jimi Hendrix. Describing it is certainly more difficult than simply listening to Hendrix using it on Voodoo Chile. In American funk music of the '70s you can hear auto-wah effects used in a variety of applications. The auto-wah alters its filter frequency automatically depending on the signal's magnitude, rather than being controlled by the position of a pedal.

TREMOLO: Simulates the classic Fender Tremolo. It has returned to popularity with trip-hop.

ROTARY: This is the quintessential simulation of the classic organ effect normally produced by speakers rotating at slow or fast speed in an extremely heavy speaker cabinet. This effect uses the physical principle of the Doppler effect to modulate the sound.

NOISE GATE: Noise gates are used to remove or reduce noise or other interference. Guitar signals in particular are very sensitive to interference. Not only do guitarists often use high-gain settings but guitar pick-ups can amplify unwanted interference. This can be painfully apparent during breaks in the music. And how does a noise gate work? It simply mutes the signal during breaks, eliminating any interference at the same time.

6.3 The separate reverb effect

The reverb effect is independent of the multi-effects processor and can be added to the mix signal at any time. To edit the REVERB function, press button D in EDIT mode (pressing the two arrow keys simultaneously) and use the two arrow keys to select one of the nine different reverb types available:

Reverb No.	Reverb Type	Quality
1	Tiny Room	Classic room simulation featuring various room sizes from bathroom to cathedral.
2	Small Room	
3	Medium Room	
4	Large Room	Special effect transforming guitar signals into heavenly pad sounds.
5	Ultra Room	
6	Small Spring	Simulations of typical spring reverbs.
7	Medium Spring	
8	Short Ambience	Simulates the early reflections of a reverberless room.
9	Long Ambience	

Tab. 6.2: The different reverb effects

7. TUNER

Press the TUNER button to activate the built-in tuner.

7.1 Tuning your guitar

The chromatic tuner automatically recognizes the frequencies of all the standard guitar notes. For the A-string this means a frequency of 220 Hz. When you plug your guitar into the device and play an open string, the tuner will recognize and display the note. Since the tuner uses an auto-chromatic scale, it can also recognize semi-tones, which are shown with a "b" in the display.

V-AMPIRE/V-AMP PRO/V-AMP 2

It may happen, however, that a note is displayed as “A” but is actually slightly out of tune. This is shown by at least one of the four LEDs at the foot of the display lighting up. In certain cases even two of the LEDs may light up, which indicates that the pitch of the note played lies between the pitches represented by the two LEDs. When the circular tuner LED in the middle lights up, this means the note played is in tune.

7.2 Setting reference pitch “A”

To give you maximum freedom for tuning your guitar, you can change the preset reference pitch “A”. For clarity’s sake, let’s look at this in more detail.

The so-called concert pitch “A” has been raised steadily over time. For example, the tuning forks used by Bach, Händel or Mozart were 415, 420 or 421 Hz (oscillations per second). Today’s orchestras tune to “A” at 444 Hz, and the Berlin Philharmonic Orchestra lead the field with their own concert pitch “A” at 447 Hz.

The reference “A” on your V-AMPIRE/V-AMP PRO/V-AMP 2 has been factory-programmed at 440 Hz. If you are going to play with a big orchestra tuning their instruments to a reference pitch of 444 Hz, you will need a function that allows you to change your reference pitch. To activate this function, switch on the tuner by pressing the TUNER button and switch to EDIT mode by pressing the two arrow keys simultaneously. The display will show “40”, which means 440 Hz. Use the arrow keys to raise or lower the reference pitch by up to 15 Hz. The display always shows the last two digits as the first digit is always 4. For example, if you start with a reference pitch of 440 Hz and press the right-hand arrow three times, the display will read 43, i.e. 443 Hz. To quit EDIT mode, press either the TUNER or the TAP button. Any changes will be stored automatically. The tones for the other strings on your guitar will automatically be adjusted to the new reference pitch.

8. INSTALLATION

8.1 Mains voltage

Before you connect the unit to the mains, please make sure that the voltage setting on the unit matches the local voltage! The fuse holder at the AC power connector has 3 triangular markings (V-AMPIRE/V-AMP PRO only). Two of these three triangles are aligned with one another. The unit is set to the voltage shown next to these markings and can be switched over by turning the fuse holder by 180°. **IMPORTANT: This does not apply to export models designed exclusively for 120 V operation!**

 **If you set the unit to a different mains voltage, be sure to use a fuse of the correct type and rating. Please refer to chapter 10 “SPECIFICATIONS” for details.**

 **Blown fuses must be replaced by fuses of the same type and rating! Please refer to chapter 10 “SPECIFICATIONS” for details.**

V-AMPIRE/V-AMP PRO: The mains connection is made using the enclosed power cord and a standard IEC receptacle. It meets all of the international safety certification requirements. V-AMP 2: the mains connection is made using the enclosed power supply.

 **Please make sure that all units have a proper ground connection. For your own safety, never remove or disable the ground conductor from the unit or of the AC power cord. The unit shall always be connected to the mains socket outlet with a protective earthing connection.**

8.2 Audio connections

The inputs of your BEHRINGER V-AMPIRE/V-AMP PRO/V-AMP 2 come as mono 1/4" connectors. All line out, line in and headphones outputs are configured as 1/4" stereo connectors. The line outputs work with both balanced and unbalanced connections. The DI OUT outputs of your V-AMPIRE/V-AMP PRO are on XLR connectors.

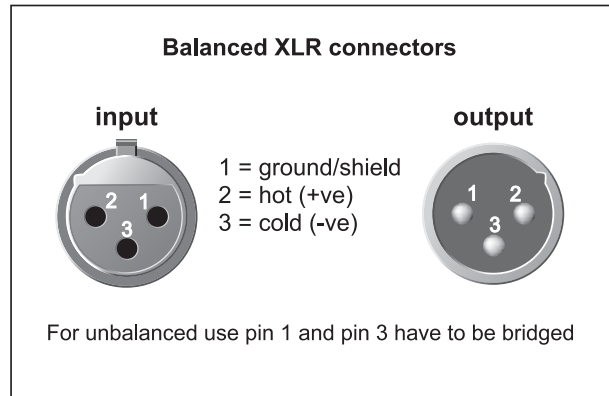

Fig. 8.1: XLR connectors

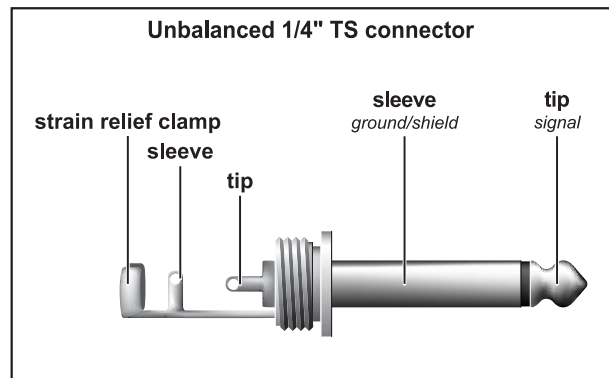

Fig. 8.2: 1/4" TS connector

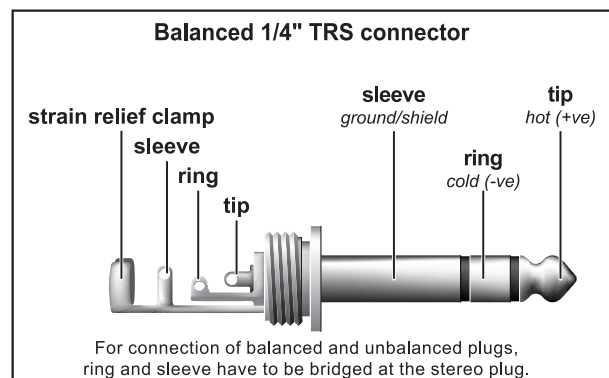

Fig. 8.3: 1/4" TRS connector

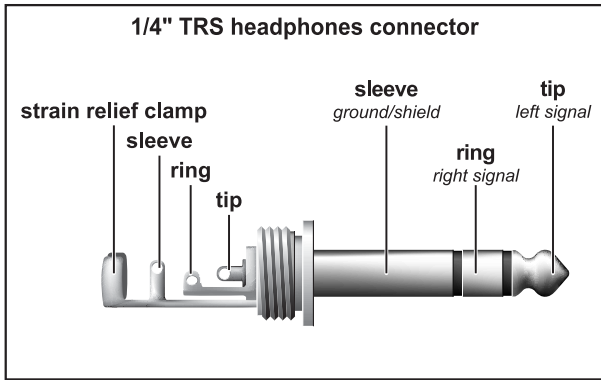

Fig. 8.4: Headphones connector

8.3 MIDI connections

The MIDI standard (**M**usical **I**nstruments **D**igital **I**nterface) was developed in the early '80s to enable different makes of electronic instruments to communicate with each other. Over the years the range of MIDI applications has constantly expanded, and today it is standard practice to network entire recording studios using the MIDI standard.

The heart of such a network is a computer with sequencer software that controls not only all the keyboards but also effects other peripheral devices. In such a studio set-up you can control the V-AMPIRE/V-AMP PRO/V-AMP 2 in real time from a computer. For live performances in particular, you can also use a MIDI foot controller to control both effect parameters and preset changes.

The MIDI connectors are international-standard 5-pin DIN connectors. To connect your device to other MIDI equipment you will need dedicated MIDI cables. They are commercially available in various standard lengths.

MIDI IN: receives MIDI controller data. The receiving channel can be adjusted in EDIT mode by pressing the A button and then using the arrow keys.

MIDI OUT/THRU: used for sending data to a computer or any other devices. You can transmit both preset data and parameter changes. If set to MIDI THRU, the V-AMPIRE/V-AMP PRO/V-AMP 2 does not send its own MIDI information, but passes on the signal received at the MIDI IN connector (see chapter 2.1, [8](#) A).

8.3.1 Sending/receiving MIDI-SysEx data

All V-AMP models can receive system-exclusive data from other MIDI devices provided that the MIDI function (button A) has been activated in EDIT mode. However, this means that all presets on your device will be overwritten automatically. You can also transmit MIDI data from your V-AMPIRE/V-AMP PRO/V-AMP 2 to other devices (total dump) by switching to EDIT mode and pressing the MIDI button until the display reads "d". The total dump function can be useful for transferring all the stored data from your device to a MIDI sequencer and storing it there.

To send individual presets to other devices: switch to EDIT mode by pressing both arrow keys on the transmitting unit simultaneously, activate the MIDI function and briefly tap the MIDI button. The preset data are first filed in the temporary buffer and can be stored in the preset position of your choice using the store function.

8.4 AES/EBU and S/PDIF standards

In principle, there are two standards for digital signal processing. AES/EBU is the professional, balanced connection via XLR connectors. This interface is based on two identical protocols published in November 1985 (EBU Tech. 3250-E) by the **E**uropean **B**roadcast **U**ion and in December 1985 by the **A**udio **E**ngineering **S**ociety (AES3-1985). Sony and Philips oriented themselves to this standard and developed a further interface with unbalanced signal routing and a few other major differences, predominantly related to the assignment of the channel status bits. This interface, named after the two companies and known as S/PDIF (Sony/Philips Digital Interface), uses either RCA connectors or optical connections with optical fiber cables. The procedure, standardized in IEC 958, made a name for itself mainly due to efforts to introduce a copy-protect technique. This standard also describes the revised AES/EBU interface, which was adapted to the S/PDIF format and named IEC 958 Type I (professional). The name of the S/PDIF interface is then IEC 958 Type II (consumer).

V-AMPIRE/V-AMP PRO/V-AMP 2

9. APPENDIX

MIDI Implementation Chart			
Function	Transmitted	Received	Remarks
MIDI Channel	1-16	1-16	-
Mode	N	N	-
Note Number	N	N	-
Velocity	N	N	-
After Touch	N	N	-
Pitch Bender	N	N	-
Control Change	-	-	-
1	N (request only)	Y	Wah Pedal
7	N (request only)	Y	Volume Pedal
12	Y	Y	Amp Gain (0-127)
13	Y	Y	Amp Treble (0-127)
14	Y	Y	Amp Mid (0-127)
15	Y	Y	Amp Bass (0-127)
16	Y	Y	Amp Vol (0-127)
17	Y	Y	Presence (0-127)
18	Y	Y	Reverb Mix (0-127) *2
19	Y (skipped on request)	Y	Amp Type (0-32) with default cabinet *3
20	Y (skipped on request)	Y	Fx Type (0-15) with defaults *1
21	Y	Y	Fx off/on (0/127)
22	Y	Y	Reverb Send off/on (0/127)
23	Y	Y	Cabinet Type (0-15) *5
24	Y	Y	Reverb Type (0-8) *4
25	Y	Y	Noise Gate Level (0-15)
26	Y	Y	Drive off/on (0/127)
27	Y	Y	Wah off/position (0/1-127)
44	N (request only)	Y	pre Effect Type (0-2) *6
45	Y	Y	pre Effect Par 1 *6
46	Y	Y	pre Effect Par 2 *6
47	N (request only)	Y	pre Effect Par 3 *6
48	N (request only)	Y	pre Effect Par 4 *6
49	N (request only)	Y	Delay Type (0-2) *7
50	Y	Y	Delay Time hi (0-117) *8
51	Y	Y	Delay Time lo (0-127) *8
52	N (request only)	Y	Delay Spread (0-127)
53	Y	Y	Delay Feedback (0-127)
54	Y	Y	Delay Mix (0-127) *9
55	N (request only)	Y	post Fx Mode (0-6) *10
56	Y	Y	post Fx Par 1 *10
57	Y	Y	post Fx Par 2 *10
58	Y	Y	post Fx Par 3 *10
59	Y	Y	post Fx Mix (0-127) *11
60	N (request only)	Y	Assign Effects Control (0-15) *1
61	N (request only)	Y	Amp Type (0-32) w/o cabinet change *3
64	N	Y	Tap (Value > 63)
80	N	Y	Request Controls (Value = 80)
81	N (request only)	Y	Set Pos (0-15), Set Character (32-127)
82	Y	Y	Tuner Bypass Volume (0-127)
83	Y	Y	Tuner Center Frequency (25-55)
84	Y	Y	Configuration (0-4=S1,S2,L1,L2,L3)
85	Y	Y	Live EQ Treble (0-127)
86	Y	Y	Live EQ Mid (0-127)
87	Y	Y	Live EQ Bass (0-127)
88	Y	Y	(V-AMP PRO only) Digital Out (44.1/48/96/ext; bit 2:pro)
89	Y	Y	Input Gain (0-127)
90	Y	Y	Wah character (0-127)
Program Change	Y (0-124)	Y (0-124,127)	127=Tuner
System Exclusive	Y	Y	see SysEx Documentation
System Common	N	N	-
System Real Time	N	N	-
Running Status	Y (2s Timeout)	Y	-

Tab. 9.1: MIDI-Implementation

V-AMPIRE/V-AMP PRO/V-AMP 2

10. SPECIFICATIONS

	V-AMPIRE	V-AMP PRO	V-AMP 2
AUDIO INPUTS			
INSTRUMENT INPUT	1/4" TS connector, unbalanced		
Input impedance	1 MΩ		
Max. input level	+9 dBu		
AUX IN STEREO	1/4" TRS stereo connector	-	1/4" TRS stereo connector
Input impedance	4.7 kΩ	-	15 kΩ
PRE DSP RETURN LINE IN	1/4" TS connector, unbalanced		
Input impedance	2 kΩ	20 kΩ	-
Max. input level	+9 dBu	+15 dBu	-
POST DSP INSERT RETURN L/R	-	1/4" TS connector, unbalanced	-
Input impedance	-	40 kΩ	-
Max. input level	-	+8 dBu	-
AUDIO OUTPUTS			
ANALOG LINE OUTPUTS L/R	1/4" TS connector, unbalanced		1/4" connector, balanced
Output impedance	approx. 680 Ω		2,2 kΩ
Max. output level	+9 dBu	+20 dBu	
PRE DSP SEND/LINE OUT	1/4" TS connector, unbalanced		
Output impedance	<1 kΩ		
Max. output level	+9 dBu		
POST DSP INSERT SEND L/R	-	1/4" TS connector, unbalanced	-
Output impedance	-	1 kΩ	-
Max. output level	-	+8 dBu	-
BALANCED LINE OUT	XLR, balanced		
Output impedance	100 Ω		
Max. output level	+14 dBu (Studio); 0 dBu (Live)		
HEADPHONES CONNECTOR	1/4" TRS connector, unbalanced		
Max. output level	+15 dBu/100 Ω (+23 dBm)		
DIGITAL OUTPUTS			
Format	-	AES/EBU or S/PDIF, switchable	-
Sample frequency	-	44.1/48/96 kHz internal; 32 - 96 kHz Wordclock, Sample rate converter	-
XLR	-	transformer-balanced	-
Output impedance	-	110 Ω	-
Nominal output level	-	3.5 V peak-to-peak	-
RCA	-	not grounded, unbalanced	-
Output impedance	-	75 Ω	-
Nominal output level	-	0.5 V peak-to-peak	-
WORDCLOCK INPUT			
BNC	-	coax-type	-
Input impedance	-	50 kΩ	-
Nominal input level	-	2 - 6 V peak-to-peak	-
MIDI			
Type	5-pole DIN jacks IN, OUT/THRU		
DIGITAL SIGNAL PROCESSING			
Converter	24-bit Delta-Sigma, 64/128 times oversampling		
Dynamics A/D	104 dB @ Preamp bypass		
Dynamics D/A	92 dB		
Sample rate	31.250 kHz		
DSP	100 Mips		
Delay time	max. 1933 msec.		
Runtime (line in → line out)	ca. 5 msec.		

V-AMPIRE/V-AMP PRO/V-AMP 2

	V-AMPIRE	V-AMP PRO	V-AMP 2
DISPLAY			
Type	7-digit LED		
AMPLIFIER			
Mono power (1 x 4 Ω)	120 W	-	-
Mono power (1 x 8 Ω)	70 W	-	-
Stereo power (2 x 8 Ω)	2 x 60 W	-	-
Sound pressure level	116 dB @ 1 m	-	-
INTERNAL SPEAKER			
Type	BUGERA™	-	-
Impedance	8 Ω	-	-
Load capacity	70 W (IEC) / 140 W (DIN)	-	-
POWER SUPPLY			
Mains voltage	USA/Canada 120 V~, 60 Hz		USA/Canada 120 V~, 60 Hz
	Europe/U.K./Australia 230 V~, 50 Hz		U.K./Australia 240 V~, 50 Hz
	Japan 100 V~, 50 - 60 Hz		Europe 230 V~, 50 Hz
	China/Korea 220 V~, 50 Hz		China/Korea 220 V~, 50 Hz
	General export model 120/230 V~, 50 - 60 Hz		Japan 100 V~, 50 - 60 Hz
Power consumption	200 W max.	15 W	13 W
Fuse	100 - 120 V~: T 5 A H 250 V	100 - 120 V~: T 400 mA H 250 V	-
	200 - 240 V~: T 2.5 A H 250 V	200 - 240 V~: T 200 mA H 250 V	-
Mains connection	Standard ICE receptacle		External power supply
DIMENSIONS/WEIGHT			
Dimensions (H x W x D)	491 x 611 x 265 mm	89 x 482.6 x 135 mm	63 x 236 x 180 mm
	19 1/3" x 24" x 10 2/5"	3 1/2" x 19" x 5 1/4"	2 1/2" x 9 1/4" x 7 1/8"
Weight	ca. 21.5 kg	ca. 2.6 kg	ca. 1.2 kg
	47 1/2 lbs	ca. 5 3/4 lbs	ca. 2 3/4 lbs

BEHRINGER continuously strives to assure the highest quality standards possible. Required modifications may be implemented without prior notice. Technical data and the appearance of the unit may deviate from the above values and/or illustrations.



11. WARRANTY

§ 1 OTHER WARRANTY RIGHTS AND NATIONAL LAW

1. This warranty does not exclude or limit the buyer's statutory rights provided by national law, in particular, any such rights against the seller that arise from a legally effective purchase contract.

2. The warranty regulations mentioned herein are applicable unless they constitute an infringement of national warranty law.

§ 2 ONLINE REGISTRATION

Please do remember to register your new BEHRINGER equipment right after your purchase by visiting www.behringer.com (alternatively www.behringer.de) and kindly read the terms and conditions of our warranty carefully.

Registering your purchase and equipment with us helps us process your repair claims quicker and more efficiently.

Thank you for your cooperation!

§ 3 WARRANTY

1. BEHRINGER (BEHRINGER International GmbH including all BEHRINGER subsidiaries listed on the enclosed page, except BEHRINGER Japan) warrants the mechanical and electronic components of this product to be free of defects in material and workmanship for a period of one (1) year* from the original date of purchase, in accordance with the warranty regulations described below. If the product shows any defects within the specified warranty period that are not excluded from this warranty as described under § 5, BEHRINGER shall, at its discretion, either replace or repair the product using suitable new or reconditioned parts. In the case that other parts are used which constitute an improvement, BEHRINGER may, at its discretion, charge the customer for the additional cost of these parts.

2. If the warranty claim proves to be justified, the product will be returned to the user freight prepaid.

3. Warranty claims other than those indicated above are expressly excluded.

§ 4 RETURN AUTHORIZATION NUMBER

1. To obtain warranty service, the buyer (or his authorized dealer) must call BEHRINGER (see enclosed list) during normal business hours **BEFORE** returning the product. All inquiries must be accompanied by a description of the problem. BEHRINGER will then issue a return authorization number.

2. Subsequently, the product must be returned in its original shipping carton, together with the return authorization number to the address indicated by BEHRINGER.

3. Shipments without freight prepaid will not be accepted.

§ 5 WARRANTY REGULATIONS

1. Warranty services will be furnished only if the product is accompanied by a copy of the original retail dealer's invoice. Any product deemed eligible for repair or replacement under the terms of this warranty will be repaired or replaced.

2. If the product needs to be modified or adapted in order to comply with applicable technical or safety standards on a national or local level, in any country which is not the country for which the product was originally developed and manufactured, this modification/adaptation shall not be considered a defect in materials or workmanship. The warranty does not cover any such modification/adaptation, irrespective of whether it was carried out properly or not. Under the terms of this warranty, BEHRINGER shall not be held responsible for any cost resulting from such a modification/adaptation.

3. Free inspections and maintenance/repair work are expressly excluded from this warranty, in particular, if caused by improper handling of the product by the user. This also applies to defects caused by normal wear and tear, in particular, of faders, crossfaders, potentiometers, keys/buttons, tubes, guitar strings, illuminants and similar parts.

4. Damages/defects caused by the following conditions are not covered by this warranty:

▲ improper handling, neglect or failure to operate the unit in compliance with the instructions given in BEHRINGER user or service manuals.

▲ connection or operation of the unit in any way that does not comply with the technical or safety regulations applicable in the country where the product is used.

▲ damages/defects caused by force majeure or any other condition that is beyond the control of BEHRINGER.

5. Any repair or opening of the unit carried out by unauthorized personnel (user included) will void the warranty.

6. If an inspection of the product by BEHRINGER shows that the defect in question is not covered by the warranty, the inspection costs are payable by the customer.

7. Products which do not meet the terms of this warranty will be repaired exclusively at the buyer's expense. BEHRINGER will inform the buyer of any such circumstance. If the buyer fails to submit a written repair order within 6 weeks after notification, BEHRINGER will return the unit C.O.D. with a separate invoice for freight and packing. Such costs will also be invoiced separately when the buyer has sent in a written repair order.

§ 6 WARRANTY TRANSFERABILITY

This warranty is extended exclusively to the original buyer (customer of retail dealer) and is not transferable to anyone who may subsequently purchase this product. No other person (retail dealer, etc.) shall be entitled to give any warranty promise on behalf of BEHRINGER.

§ 7 CLAIM FOR DAMAGES

Failure of BEHRINGER to provide proper warranty service shall not entitle the buyer to claim (consequential) damages. In no event shall the liability of BEHRINGER exceed the invoiced value of the product.

* Customers in the European Union please contact BEHRINGER Germany Support for further details.

Technical specifications and appearance subject to change without notice. The information contained herein is correct at the time of printing. The names of companies, institutions or publications pictured or mentioned and their respective logos are registered trademarks of their respective owners. Their use neither constitutes a claim of the trademarks by BEHRINGER® nor affiliation of the trademark owners with BEHRINGER®. BEHRINGER® accepts no liability for any loss which may be suffered by any person who relies either wholly or in part upon any description, photograph or statement contained herein. Colours and specification may vary slightly from product. Products are sold through our authorised dealers only. Distributors and dealers are not agents of BEHRINGER® and have absolutely no authority to bind BEHRINGER® by any express or implied undertaking or representation. No part of this manual may be reproduced or transmitted in any form or by any means, electronic or mechanical, including photocopying and recording of any kind, for any purpose, without the express written permission of BEHRINGER Spezielle Studiotechnik GmbH. BEHRINGER® is a registered trademark.

ALL RIGHTS RESERVED. © 2005 BEHRINGER Spezielle Studiotechnik GmbH,
Hanns-Martin-Schleyer-Str. 36-38, 47877 Willich-Münchheide II, Germany.
Tel. +49 2154 9206 0, Fax +49 2154 9206 4903

FEDERAL COMMUNICATIONS COMMISSION COMPLIANCE INFORMATION



Responsible party name: **MUSIC Group Services USA, Inc.**
Address: **18912 North Creek Parkway,
Suite 200 Bothell, WA 98011,
USA**
Phone/Fax No.: **Phone: +1 425 672 0816
Fax: +1 425 673 7647**

V-AMPIRE/V-AMP PRO/V-AMP 2

complies with the FCC rules as mentioned in the following paragraph:

This equipment has been tested and found to comply with the limits for a Class B digital device, pursuant to part 15 of the FCC Rules. These limits are designed to provide reasonable protection against harmful interference in a residential installation. This equipment generates, uses and can radiate radio frequency energy and, if not installed and used in accordance with the instructions, may cause harmful interference to radio communications. However, there is no guarantee that interference will not occur in a particular installation. If this equipment does cause harmful interference to radio or television reception, which can be determined by turning the equipment off and on, the user is encouraged to try to correct the interference by one or more of the following measures:

- Reorient or relocate the receiving antenna.
- Increase the separation between the equipment and receiver.
- Connect the equipment into an outlet on a circuit different from that to which the receiver is connected.
- Consult the dealer or an experienced radio/TV technician for help.

This device complies with Part 15 of the FCC rules. Operation is subject to the following two conditions:

- (1) this device may not cause harmful interference, and
- (2) this device must accept any interference received, including interference that may cause undesired operation.

Important information:

Changes or modifications to the equipment not expressly approved by MUSIC Group can void the user's authority to use the equipment.