

VIRTUALIZER PRO DSP2024P

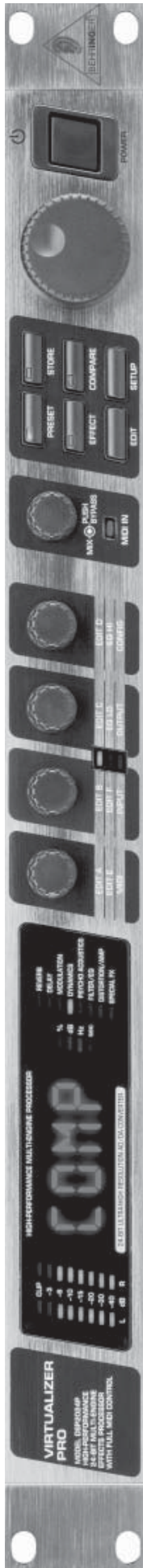

User's Manual

Version 1.2 September 2004

ENGLISH

www.behringer.com



IMPORTANT SAFETY INSTRUCTIONS



CAUTION: To reduce the risk of electric shock, do not remove the top cover (or the rear section). No user serviceable parts inside; refer servicing to qualified personnel.

WARNING: To reduce the risk of fire or electric shock, do not expose this appliance to rain and moisture. The apparatus shall not be exposed to dripping or splashing and no objects filled with liquids, such as vases, shall be placed on the apparatus.



This symbol, wherever it appears, alerts you to the presence of uninsulated dangerous voltage inside the enclosure—voltage that may be sufficient to constitute a risk of shock.



This symbol, wherever it appears, alerts you to important operating and maintenance instructions in the accompanying literature. Please read the manual.

DETAILED SAFETY INSTRUCTIONS:

- 1) Read these instructions.
- 2) Keep these instructions.
- 3) Heed all warnings.
- 4) Follow all instructions.
- 5) Do not use this apparatus near water.
- 6) Clean only with dry cloth.
- 7) Do not block any ventilation openings. Install in accordance with the manufacturer's instructions.
- 8) Do not install near any heat sources such as radiators, heat registers, stoves, or other apparatus (including amplifiers) that produce heat.
- 9) Do not defeat the safety purpose of the polarized or grounding-type plug. A polarized plug has two blades with one wider than the other. A grounding type plug has two blades and a third grounding prong. The wide blade or the third prong are provided for your safety. If the provided plug does not fit into your outlet, consult an electrician for replacement of the obsolete outlet.
- 10) Protect the power cord from being walked on or pinched particularly at plugs, convenience receptacles, and the point where they exit from the apparatus.
- 11) Only use attachments/accessories specified by the manufacturer.
- 12) Use only with the cart, stand, tripod, bracket, or table specified by the manufacturer, or sold with the apparatus. When a cart is used, use caution when moving the cart/apparatus combination to avoid injury from tip-over.



- 13) Unplug this apparatus during lightning storms or when unused for long periods of time.
- 14) Refer all servicing to qualified service personnel. Servicing is required when the apparatus has been damaged in any way, such as power supply cord or plug is damaged, liquid has been spilled or objects have fallen into the apparatus, the apparatus has been exposed to rain or moisture, does not operate normally, or has been dropped.
- 15) **CAUTION** - These service instructions are for use by qualified service personnel only. To reduce the risk of electric shock do not perform any servicing other than that contained in the operation instructions unless you are qualified to do so.

FOREWORD

Dear Customer,

Welcome to the team of VIRTUALIZER PRO users and thank you for demonstrating your faith in us by purchasing the DSP2024P.

Writing this foreword to you is an extremely pleasant task. After several months of intensive brainstorming and the subsequent realization of their ideas, our engineers finally achieved an ambitious goal: considerable improvement of an excellent piece of equipment. The VIRTUALIZER has been regarded as standard equipment for countless studios and P.A. distributors for quite a while now. As with any new product, the development of this new VIRTUALIZER PRO also meant a great deal of responsibility. Throughout the entire planning and development phases, we kept you—the discerning end-user and musician, your requirements and your requests at the focal point of our considerations. Meeting your professional expectations required a lot of effort and more than a few night shifts, but this is exactly the kind of challenge that keeps us alive and kicking. Developing a new product always brings a large number of people together, and it's a great feeling when all involved can take pride in the results.

It is an important part of our philosophy to share our gratification with you, since you're the most important member of the BEHRINGER team. With your highly competent suggestions for new products, you've contributed immensely to the development and success of our company. In return, we bring you uncompromising quality (manufactured under ISO9000 certified management system) as well as excellent technical and audio specifications, at an extremely favorable price. We hope that this will enable you to fully unfold your creativity without being hampered by budget constraints.

We are often asked how we manage to produce such high-grade devices at such unbelievably low prices. The answer is quite simple: it's you, our customers! Lots of satisfied customers means large sales volumes, which in turn enables us to reduce production and logistics expenses. We believe it's only fair to pass this benefit back to you—after all, your success is our success!

I would like to thank everyone who helped make our new VIRTUALIZER PRO project possible and successful. Each of those people made very personal contributions, from our engineers and designers to our numerous staff members and finally to you as a BEHRINGER user.

My friends, it's been worth the trouble!

Thank you very much,

A handwritten signature in black ink, appearing to read 'U. Behringer', with a long horizontal flourish extending to the right.

Uli Behringer

VIRTUALIZER PRO

High-Performance 24-Bit Multi-Engine Effects Processor

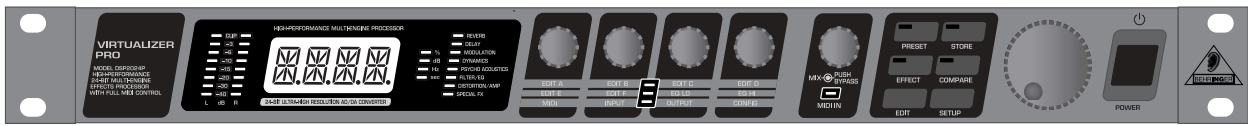

- ▲ 71 breathtaking new algorithms, most in true stereo
- ▲ Wave-adaptive VIRTUAL ROOM reverb algorithms for ultra-natural reverb and delay
- ▲ Awesome modulation, dynamic, psychoacoustic and EQ algorithms
- ▲ Innovative amp simulation, distortion and special effects
- ▲ 11 effect combinations with selectable serial/parallel configuration
- ▲ Up to 7 adjustable parameters plus HI and LO EQ per effect
- ▲ High-resolution 24-bit A/D and D/A converters with 64/128-times oversampling
- ▲ True stereo processing for realistic channel separation in stereo image
- ▲ 24-bit internal signal processing, professional 46 kHz sample rate
- ▲ 100 factory presets plus 100 user memory locations
- ▲ Extensive MIDI implementation
- ▲ Precise 8-segment LED level meters
- ▲ Internal power supply for professional applications
- ▲ Servo-balanced XLR and 1/4" TRS inputs and outputs
- ▲ Conceived and designed by BEHRINGER Germany

DSP2024P

TABLE OF CONTENTS

1. INTRODUCTION	6
1.1 The concept	6
1.2 Before you get started	7
1.3 Control elements	7
2. EFFECTS ALGORITHMS	10
2.1 Reverb algorithms	11
2.2 Delay algorithms	11
2.3 Modulation and Pitch Shifter effects	12
2.4 Dynamic effects	13
2.5 Psycho-acoustic effects	14
2.6 Filter/EQ effects	15
2.7 Distortion effects and amp simulations	16
2.8 Special effects	17
2.9 Effects algorithm combinations (multi-effects programs)	18
3. OPERATION	20
3.1 Effects structure	20
3.2 Calling up presets	23
3.3 Editing programs (edit mode)	23
3.4 Storing programs	23
3.5 Comparing an edited preset with the corresponding factory preset (COMPARE function)	24
3.6 SETUP mode	24
3.6.1 MIDI control	24
3.6.2 INPUT mode	25
3.6.3 OUTPUT mode	25
3.6.4 Dual engine configuration (CONFIG)	25
3.7 Restoring the factory presets	25
4. APPLICATIONS	26
4.1 Level setting	26
4.2 Using the VIRTUALIZER PRO in the aux bus	26
4.3 Using the VIRTUALIZER PRO in the insert path	27
4.4 Using the VIRTUALIZER PRO as an effects device for instruments	27
4.5 Using the VIRTUALIZER PRO in a MIDI setup	29
5. MIDI FUNCTIONS OF THE DSP2024P	29
5.1 Saving data via MIDI	29
6. INSTALLATION	30
6.1 Mains connection	30
6.2 Audio connections	30
6.3 MIDI connections	31
6.4 Selecting the operating level	31
7. APPENDIX	32
7.1 Parameter overview	32
7.2 MIDI implementation	34
7.3 Default settings	35
7.4 Parameter range of effects algorithms	37
8. SPECIFICATIONS	39
9. WARRANTY	40

1. INTRODUCTION

In purchasing the BEHRINGER VIRTUALIZER PRO you have acquired an extremely efficient multi-effects processor that offers first class reverberation effects and a number of other algorithms. The DSP2024P has 71 new effects types, and thanks to its logically structured user interface, it can be used easily and intuitively.

In order to generate an extremely natural reverberation, we at BEHRINGER have developed new kinds of algorithms for virtual acoustics. These algorithms will help you calculate all room and reverberation parameters with absolutely professional quality and naturalness.

In spite of this extensive and calculation-intensive work performed by the 24-bit processor in the DSP2024P, the VIRTUALIZER PRO is very easy to handle. Changing parameters to achieve a specific sound is simple. There are 100 presets available to store your own programs.

The DSP2024P includes excellent reverb and delay programs, but that's not all. Besides the classic plate reverb simulations, the VIRTUALIZER PRO will impress you with its excellent modulation effects (like chorus, flanger and phaser), which were extended to include special variations like a musical pitch shifter, a tremolo, and a rotary speaker simulation. The DSP2024P's dynamic and psycho-acoustic effects allow you to do without a number of additional pieces of equipment. The DSP2024P also offers you a series of distortion and amplification sounds that are combined with a speaker simulation. Thus, as a guitarist in recording situations, you can achieve an excellent sound on tape or hard disk, even without a speaker cabinet. Besides its logical and simple operation, the VIRTUALIZER PRO's technical equipment is also impressive. The following points ensure signal processing at a professional level:

- ▲ Extremely low-noise and exact 24-bit A/D and D/A converters.
- ▲ A professional sample rate of 46 kHz guarantees a high signal resolution for a frequency response of 20 Hz to 20 kHz.
- ▲ The 24-bit processor features dual engine software; these two sections process audio input independently.
- ▲ As for all BEHRINGER products, the highest quality components and controls are used.

 **The following instructions will give you a brief run-down on the terminology and functions of the VIRTUALIZER PRO. After reading, please store this manual in a safe place for future reference.**

1.1 The concept

BEHRINGER uses an uncompromising selection of components. The heart of the BEHRINGER VIRTUALIZER PRO is a 24-bit DSP, which, due to its exceptional technical specifications, is regarded as one of the finest building blocks. With it come the first class 24-bit A/D-D/A converters, guaranteeing a precise conversion of audio signals. Narrow-range tolerance resistances and capacitors, high-grade switches, and other selected components are all very high in quality.

The VIRTUALIZER PRO was manufactured on the basis of SMD technology (Surface Mounted Device). The use of sub-miniature building blocks known from space flights allows not only an extreme packing density but also ensures an increased dependability. The DSP2024P was manufactured under ISO9000 certified management system.

1.2 Before you get started

The VIRTUALIZER PRO was carefully packed in the factory to ensure safe transport. Nevertheless, if the box shows signs of damage, please check the equipment immediately for any signs of external damage.

 **Damaged units should NEVER be sent directly to us. Please inform the dealer from whom you acquired the unit immediately as well as the transportation company from which you took delivery of the unit. Otherwise, all claims for replacement/repair may be rendered invalid.**

- 👉 To assure optimal protection of your DSP2024P during use or transport, we recommend utilizing a carrying case.
- 👉 Please always use the original packaging to avoid damage due to storage or shipping.
- 👉 Never let unsupervised children play with the DSP2024P or with its packaging.
- 👉 Please dispose of all packaging materials in an environmentally-friendly fashion.

The BEHRINGER VIRTUALIZER PRO requires one standard 19" rack unit of space (1 3/4"). Please leave an additional 4" installation depth to allow connections at the rear side.

Make sure that there is adequate ventilation and do not place the VIRTUALIZER PRO on top of an amplifier, which could cause overheating.

- 👉 Before connecting the VIRTUALIZER PRO to the mains, carefully check that your equipment is set to the correct voltage:

The fuse holder on the female mains connector has 3 triangular markings, with two of these triangles opposing each other. The VIRTUALIZER PRO is set to the operating voltage printed next to these markers and can be set to another voltage by turning the fuse holder by 180°. **CAUTION: This instruction does not apply to export models exclusively designed, e.g. for 120-V operation!**

Connection to the mains is made by a mains cable with an IEC receptacle that complies with the required safety regulations.

- 👉 Please make sure that the unit is grounded at all times. For your own protection, you should never tamper with the grounding of the cable or the unit itself. The unit shall always be connected to a mains socket outlet with a protective earthing connection.
- 👉 Installation and operation of this equipment must be carried out by competent staff only. Both before and after installation, the staff using the equipment should make sure that it is properly grounded since otherwise electrostatic discharge etc. can lead to an impairment of its operation. For more information, see chapter 6 "INSTALLATION".

The BEHRINGER VIRTUALIZER PRO is equipped with electronically servo-balanced inputs and outputs. The circuit design features automatic hum suppression for balanced signals and thus ensures trouble-free operation, even at the highest operating levels. Externally induced mains hum, etc. can therefore be effectively suppressed. The automatic servo-function recognizes the presence of unbalanced connectors and adjusts the nominal level internally to avoid level differences between the input and output signals (6-dB correction).

The MIDI connectors (IN/OUT/THRU) are standard DIN plug connections. The data communication is isolated from ground by opto-couplers.

1.3 Control elements

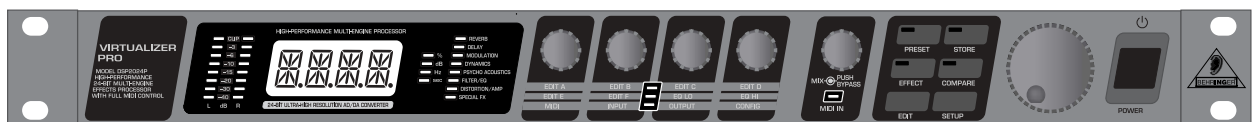

Fig. 1.1: VIRTUALIZER PRO front panel

The BEHRINGER VIRTUALIZER PRO's front panel includes five edit controls (non-intermittent rotary controls), a jog wheel (big rotary control), six parameter keys, an LED display and a mains switch. Each of the two fully independent channels can be monitored with an 8-digit LED meter.

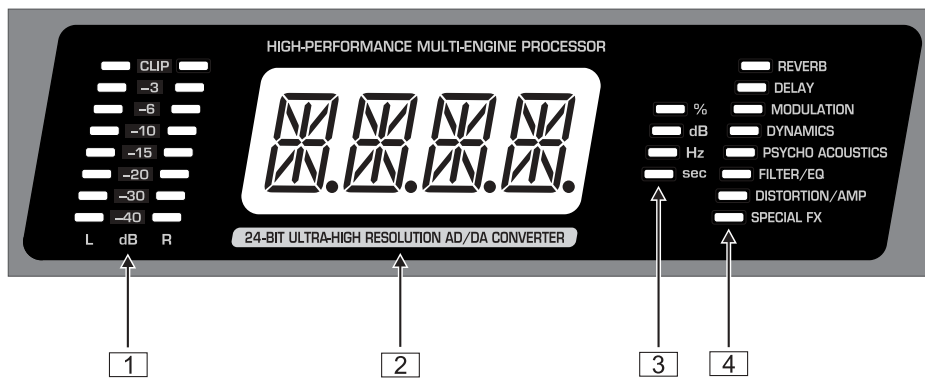

Fig. 1.2: Display section of the VIRTUALIZER PRO

- 1 Both the *LED CHAINS* display the intensity of the input signal in dB in relation to the nominal level, which is selected on the rear panel with the *OPERATING LEVEL* switch.
- 2 After you switch on the VIRTUALIZER PRO, you can read the name of the last used effect on the *LED DISPLAY*. When editing, the LED DISPLAY shows the parameter's name along with a 4-digit alpha-numeric display that shows the absolute parameter's value.
- 3 To the right of the LED DISPLAY are four *STATUS LEDs* which indicate the type of value you are working with. You may do any of the following:
 - ▲ set the absolute value of an effect parameter (“%”),
 - ▲ increase or decrease the amplitude or determine the threshold point of the compressor (“dB”),
 - ▲ modify a frequency (“Hz”) or
 - ▲ modify a time parameter (“sec”).
- 4 The *ALGORITHM GROUPS LED CHAIN* indicates which category the selected effect belongs to. Altogether the DSP2024P offers eight different algorithm groups.

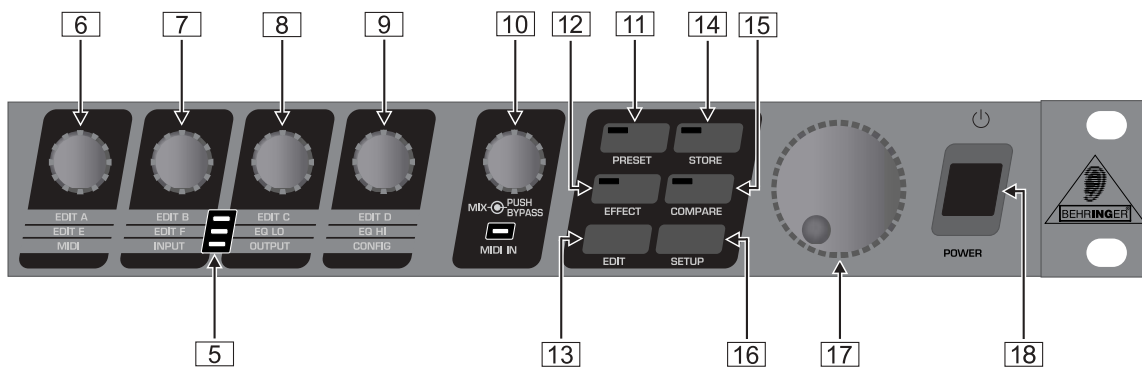







Fig. 1.3: Function keys, controls and jog wheel

- 5 Every preset in the DSP2024P allows you to edit at least four effect parameters. The *EDIT-LED-CHAIN* indicates which parameters are adjusted by the four EDIT CONTROLS. If the top LED lights up, 6 controls the parameter EDIT A, 7 controls EDIT B, 8 helps in changes of parameter EDIT C and with 9 you change the setting of parameter EDIT D. If the middle LED of the EDIT-LED-CHAIN lights up, the four EDIT CONTROLS modify the parameters that are arranged to its left and right. The lower LED functions correspondingly.



For the exact meaning of the individual effect parameters, see chapter 7.1.

- 6 With the *1st EDIT CONTROL* (non-intermittent rotary control) you change the values of the first (**EDIT A**) and fifth (**EDIT E**) effect parameters. You can also select MIDI functions (**MIDI**) with the 1st EDIT CONTROL. Press the EDIT key [13] to switch from EDIT A to EDIT E and vice versa. You reach the MIDI function by pressing the SETUP key [16].
- 7 The *2nd EDIT CONTROL* allows you to modify the values of effect parameters **EDIT B** and **EDIT F**. When you select the **INPUT** parameter with the help of the SETUP key, you can specify whether the DSP2024P functions mono or stereo mode (see chapter 3.6.2 for more information).
- 8 The *3rd EDIT CONTROL* modifies the values of effect parameters **EDIT C**, **EQ LO**, and the global **OUTPUT** parameter (see chapter 3.6.3). Here, as well, you select among them using the EDIT and SETUP keys.
- 9 With the *4th EDIT CONTROL*, you modify the values of effect parameters **EDIT D**, **EQ HI**, and the global parameter **CONFIG** (see chapter 3.6.4). Use the EDIT and SETUP keys to choose between the parameters.
-  **During editing, you can rotate one of the four EDIT CONTROLS minimally to display a brief description of the current parameter active. This can help you know that, for example, EDIT A controls the pre delay for all reverb effects of the VIRTUALIZER PRO. After approximately one second the name is erased and the parameter's current value is displayed. This function can be used only by operating one of the controls that has not yet been selected.**
- 10 By turning the *MIX/BYPASS CONTROL* the effect levels of most effect algorithms are set in the range from 0 to 100%. If you select 0%, the signal at the inputs of DSP2024P is transferred directly to the outputs without adding any effects (the signal is completely dry). If you select 100%, only the effected signal is sent to the outputs (the signal is completely wet).
-  **If you use the DSP2024P in the aux bus with your mixing console, you should always set this value at 100%. if you're using the DSP2024P with a guitar amplifier (in a serial effects loop), we suggest settings between 20 and 50% (depending on the amplifier type).**
-  **Please note that, for the effects “parametric” and “graphic EQ”, the MIX/BYPASS CONTROL allows a gain correction by rotation.**
- To bypass the DSP2024P's effects, press the MIX/BYPASS CONTROL. This allows you to compare between the original and the effected signals. Press the MIX/BYPASS CONTROL again to deactivate the bypass and return to your chosen effect. When the MIDI IN LED below the control flickers, it indicates that MIDI data is arriving at the MIDI IN port.
-  **Both the MIX/BYPASS CONTROL and the four EDIT CONTROLS react dynamically. This means that, depending how fast you rotate the wheels, the present parameter is changed in steps of 1, 2, 5 or 10. The faster the rotation, the greater the change in the parameter value.**
- 11 To select one of the 200 presets, press the *PRESET* key once, then rotate the JOG WHEEL [17].
- 12 To select one of the 71 basic effect algorithms, press the *EFFECT* key once, then rotate the JOG WHEEL. For information on the parameter values that are set for the basic effect algorithms, see chapter 7.4.
- 13 To select the EDIT CONTROL function (see [6] - [9]), press the *EDIT* key.
- 14 When you make changes to a user preset, the *STORE* key's LED begins to blink. The DSP2024P comprises 100 user presets for your own settings and 100 factory presets (see separate preset sheet). To save your changes, press the STORE key. Select a storage space (number) with the JOG WHEEL and confirm it by pressing the STORE key again.
- 15 If you have made changes to a preset and the LED of the STORE key is blinking, you can press the *COMPARE* key to temporarily restore the preset's original settings. While these settings are loaded, the COMPARE key's LED blinks and “COMP” appears in the LED DISPLAY. Press the COMPARE key again to return to edit mode and store your changes.
- 16 To enter SETUP mode, press the *SETUP* key. In setup mode, you can access the parameters shown below the four EDIT CONTROLS. For more information about SETUP mode, see chapter 3.6.

- 17 To change a parameter's value, rotate the *JOG WHEEL*. To increase the value, turn the wheel clockwise. To decrease the value, turn the wheel counterclockwise. If none of the edit functions is selected, you can select a program directly with the *JOG WHEEL*. When you do so, a spot lights up in the *LED DISPLAY*. As long as the spot is illuminated, a program can be selected without making the corresponding settings immediately audible. This brief signal suppression means that during quick selection of presets with the *JOG WHEEL*, not every preset is activated directly. If the *JOG WHEEL* is not turned for a second, the spot in the *LED DISPLAY* disappears and the program is loaded.
 - 18 Use the *POWER* switch to power up your DSP2024P. The *POWER* switch should always be in the "Off" position when you are about to connect your unit to the mains.
-  **To disconnect the unit from the mains, pull out the mains cord plug. When installing the product, ensure that the plug is easily accessible. If mounting in a rack, ensure that the mains can be easily disconnected by a plug or by an all-pole disconnect switch on or near the rack.**

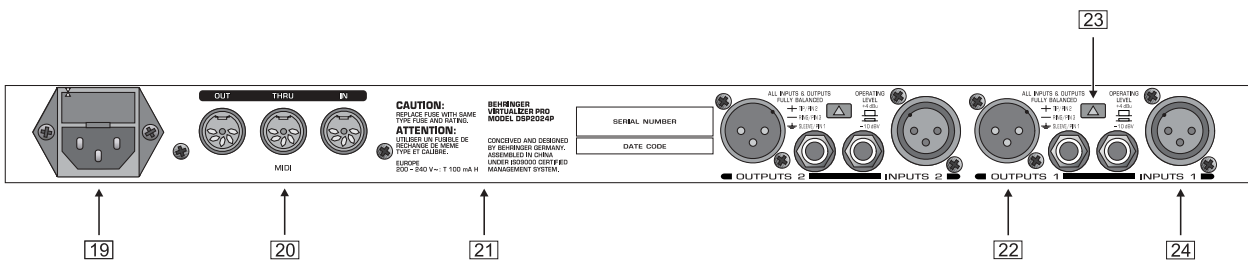

Fig. 1.4: VIRTUALIZER PRO rear panel

- 19 **FUSE HOLDER / VOLTAGE SELECTION.** Before connecting the DSP2024P, confirm that the voltage display matches your local mains voltage. When replacing the fuse, you must always use the same type. In many units the fuse holder can be installed in one of two positions, allowing you to switch between 230 V and 120 V. If you wish to operate a unit outside Europe at 120 V, then a stronger fuse must be used. (For more information, see chapter 8 "SPECIFICATIONS"). The mains connection is made via the IEC receptacle. An appropriate mains cable is included.
- 20 The DSP2024P has wide-ranging MIDI implementation. *MIDI IN*, *MIDI OUT*, and *MIDI THRU* connectors are available for transmitting MIDI commands.
- 21 **SERIAL NUMBER.** Please complete and return the warranty card within 14 days of the date of purchase. Otherwise, you will lose your right to the extended warranty. Alternatively, you can register online at our website under www.behringer.com.
- 22 The DSP2024P's balanced *OUTPUTS* are designed as 1/4" TRS and XLR sockets.
- 23 To switch between -10 dBV (home recording level) and +4 dBu (professional studio level), use the *OPERATING LEVEL SWITCH*. When you switch between the two, the level displays are automatically changed to the nominal level and the VIRTUALIZER PRO operates in its optimal working range.
- 24 Both of the VIRTUALIZER PRO's *INPUTS* are also available as balanced 1/4" TRS and XLR sockets.

2. EFFECTS ALGORITHMS

All effects of digital effects equipment are based on various algorithms. An algorithm for a reverb effect, for example, is programmed differently than a chorus algorithm. Each effect has a certain algorithm with which the digital input signal is processed. The processing takes place within the digital signal processor (DSP). After the effect is generated and the input signal is mixed, the digital signal is converted back into an analog signal with a D/A converter.

You can edit up to seven parameters for each preset in the VIRTUALIZER PRO. The changes you make will influence the sound in different ways. An overview of the DSP2024P's various effects algorithms follows.



2.1 Reverb algorithms

REVERB: As the term suggests, a “reverb” is a reverberation effect. The reverb can be considered as the most important effect in a mix-down or a live event. The DSP2024P offers 12 different reverberation programs so that you have a suitable reverb for every situation. **Cathedral** simulates the dense, long reverberation of a large cathedral, which is appropriate for solo instruments or vocals in slow pieces. **Gold Plate** simulates the sound of plate reverberators and hence is a classic for drums (snare) and vocals. **Small Hall** simulates a small, lively (strongly reflecting) hall. With **Room**, you can clearly hear the walls of the room. **Studio** represents a small- to middle-sized room. With **Concert**, you can select between a small theater and a large hall. **Stage** is well suited to dissipating the sound of a keyboard or an acoustic guitar. **Spring Reverb** simulates a classic spring reverberation. **Ambience** reproduces a room impression without late reflections. With **Early Reflections**, the initial reflections of a room are clearly audible.

GATED REVERB: This effect synthetically cuts off reverberation after a period of time. It is famous in the song “In the Air Tonight” by Phil Collins.

REVERSE REVERB: This is a reverberation in which the envelope is reversed—it slowly gets louder.

Parameter	Function
Pre Delay	Time until arrival of first reflection(s)
Decay	Duration until the reverb tail is damped
Hi Decay Damping	Damps high frequencies in the reverb tail
Size	Size of the plate reverb/the room impression
Diffusion	Degree of wall diffusion (reverb density)
Wall Damp.	Degree of damping of the wall material
Bass Mul.	Amplification/damping of low frequencies in the reverb tail
Low Cut	Frequency of Low Cut Filter ¹ at the input stage
Metal Resonance	Intensity of metal resonances
Reflections	Number of initial reflections
Shelver Damp.	Damps Shelving Filter ² at the input stage
Shelver Frequency	Frequency of Shelving Filter at the input stage
High Cut	Frequency response of the spring (Spring Reverb)
Stereo Width	Stereo depth of the effect
Threshold	Threshold point (Reverse Reverb)
Hold Time	Adds additional time until process starts (Reverse Reverb)
Gate Threshold	Threshold point of the gate (Gated Reverb)
Gate Hold	Time until release process sets in (release sets in, after the signal falls below the threshold point)
Reverb Mod.	Modulation intensity of the reverb tail
ER/Rev.	Intensity ratio between initial reflections and reverb tail

¹ High pass filter, allows the frequencies **above** a specific cut-off frequency to pass and damps the frequencies below that.

² Upper or lower cut-off frequency of an equalizer.

Tab. 2.1: Functioning of the reverb effects’ parameters



2.2 Delay algorithms

STEREO DELAY: A delay of the input signal. Different tempo settings allow interesting delay effects.

TAPE ECHO: Similar to the stereo delay, with the difference being that the repetitions have less presence. This simulates the character of the original tape echo that was used before the digital era and can be thought of as a “Vintage Sound”. The tape echo’s reflections include high and low pass filters.

PING PONG: A delay effect with changing stereo positioning, where the time intervals between the repetitions can be changed.

Parameter	Function
Delay Left	Length of left delay (Tape Echo / Ping Pong)
Delay Left Coarse	Length of delay time (left) in 100 ms steps
Delay Left Fine	Length of delay time (left) in 1 ms steps
Delay Right	Length of right delay (Tape Echo / Ping Pong)
Delay Right Coarse	Length of delay time (right) in 100 ms steps
Delay Right Fine	Length of delay time (right) in 1 ms steps
Feedback	Repetition(s) for both channels
Feedback Left	Repetition(s) for the left channel
Feedback Right	Repetition(s) for the right channel
Feedback Delay Left	Delay of the left feedback
Feedback Delay Right	Delay of the right feedback
Feedback HP	High pass cut-off frequency of repetition(s)
Feedback LP	Low pass ¹ cut-off frequency of repetition(s)
Bandlimit	Frequency response (input low pass)

¹ Filter, allows the frequency **below** a particular cut-off frequency to pass and damps the frequencies above that.

Tab. 2.2: Functioning of the delay effects' parameters



2.3 Modulation and Pitch Shifter effects

FLANGER: The word “flange” means “tape spool”, and this explains the characteristics of the effect. Originally the flanger effect was generated with two tape recorders which ran synchronously. The same audio signal was recorded on both machines. If you put a finger on the left spool of one of the machines, the spool and the playback speed are slowed down. The generated delay results in phase shifting of the signals. **Vintage Flanger** simulates a guitar flanger effect pedal and **Jet Stream Flanger** sounds like a classic analog flanger.

CHORUS: This effect slightly detunes the original signal. A very pleasant detune effect is created in connection with the pitch variation. The chorus effect is quite often and extensively used for dispersing signals. **Analog Chorus** simulates a guitar chorus effect pedal, while **Vintage Chorus** imitates a classic analog studio chorus. **Ultra Chorus** creates the sound of an eight-person vocal chorus.

PHASER: With the phaser, a second, phase shifted signal is added to the original audio signal. The resulting sound is thicker and above all livelier. This effect is often used for guitar sounds and keyboards. In the 70s, it was also extensively used for other instruments like electric pianos. Here, **Vintage Phaser** represents a guitar phaser effect pedal. **Dual Phaser** processes the left and the right channels separately.

ROTARY: The simulation of a classic effect that is normally generated with a very heavy enclosure with a (slow or fast) rotating speaker: The bass speaker (drum) is covered by a partly opened rotating cap, while both of the high pitch horns (horn), displaced by 180°, revolve around the same perpendicular axis. Here, the physical principle of the Doppler effect for modulation of signals is used.

PITCH SHIFTER: This effect changes the pitch of the input signal. You can generate musical intervals and harmonies or simply a single voice. Detuning by several semitones upward alienates voices (and is used often in cartoons). Here, you can choose among a stereo, two, and three vocal pitch shifter. At the left stop of Edit C the pitch shifters 1 and 2 are synchronized to a stereo pitch shifter. Pitch shifter 3 can be switched off by turning Edit E fully counterclockwise.

VIBRATO: For this effect, the peak frequency of a tone is periodically and uniformly changed (quickly or slowly). It is often used for guitar playing.

TREMOLO: This effect was originally found on guitar amplifiers, and is once again trendy. It is a fast or slow periodic variation of the volume.

AUTO PANNING: This sound effect, which was very popular in the beginnings of stereo technique, is achieved by allowing a sound source (often the lead guitar or a synthesizer) to wander from one end of the stereo image to another or by just letting it wander repeatedly.

Parameter	Function
Speed	Speed of modulation
LFO ¹ Wave	Sets the curve of the modulation (triangular, sinusoidal, rectangular)
Depth	Modulation depth (L & R)
Delay	Length of delay
Feedback	Routes back the processed signal to the input stage
Wave	Sets the curve of the LFO (Sine, Tri, Opto, Square, Saw Up, Saw Down)
Semitones 1	Pitch Shifter 1: detuning in semitones
Semitones 2	Pitch Shifter 2: detuning in semitones
Semitones 3	Pitch Shifter 3: detuning in semitones
Cents 1	Pitch Shifter 1: detuning in cents
Cents 2	Pitch Shifter 2: detuning in cents
Cents 3	Pitch Shifter 3: detuning in cents
Drum Depth	Intensity of amplitude modulation of the bass loudspeaker (Rotary)
Horn Depth	Intensity of amplitude modulation of the high pitch horn (Rotary)
Balance	Volume ratio between horn and drum
Spread	Effect intensity
Stereo Spread	Stereo effect intensity
Stereo Phase	Phase angle between left and right modulation
Bandlimit	Frequency band limitation of effect
Wideness	Parameter variation (Ultra Chorus)
Intensity	Intensity of modulation
Base	Starting point of modulation
Drive	Intensity of tube distortion
Mode	Selects various effect modes or between three modes with increasing modulation intensity (Stereo Phaser)
Auto Modulation	Influences LFO frequency (dependent on input level)
Feedback LP	Low pass cut-off frequency of feedback
Split Frequency	Split frequency of frequency crossover

¹ (Low Frequency Oscillator): determines the speed and nature of modulation effects.

Tab. 2.3: Functioning of the modulation and pitch shifter effects' parameters



2.4 Dynamic effects

COMPRESSOR/LIMITER: When the signal level exceeds the level control limit of the signal-processing unit, it must be limited dynamically to avoid distortions. This is achieved by installing a compressor or a limiter. The limiter abruptly limits the signal above a specified threshold, while a compressor acts “softly” over a large range.

EXPANDER: Background noises of all types (noise, humming etc) limit the dynamic range of the actual signal. As long as the level of the actual signal lies significantly above the background noise, the noise is inaudible. The interference signal in this case is masked by the actual signal. The expander is used to effectively expand the dynamic range of signals. Signals with small amplitudes (such as background noise) can be weakened, thereby reducing the background noise.

GATE: On stage and in studios, there are diverse applications where a noise gate is needed. For example, microphones that tend to cause feedback can be “defused”. In addition, you can use a gate to eliminate unwanted noise. When used on vocals, for example, the signal is simply masked during pauses, thus eliminating all noise. Needless to say, a gate used on vocals has to open very quickly—otherwise, the first syllables of soft or whispered passages would not be audible.

ULTRAMIZER: The ultramizer function divides the sound spectrum into two frequency bands and, as a result, allows inaudible but extremely effective compression. This is especially helpful during mix-down. The DSP2024P analyses the received audio material and automatically adjusts input gain and compression parameters.

DENOISER: The DENOISER is used to eliminate or reduce noise and other interference.

DE-ESSER: A problem often encountered in recording situations, is the sibilant (Ssss) sound of the human voice. The de-esser is used to remove strong hissing sounds from the audio signal.

WAVE DESIGNER: Using this effect, you can influence the envelope of a signal by specifying its volume. A (= Attack) indicates the time a tone needs to reach its full volume. R (= Release) determines how long it takes before a tone dies away.

Parameter	Function
Ratio ¹	Degree of compression (Compressor) / expansion (Expander)
Threshold	Threshold point of Compressor / Expander / Gate
Limiter Threshold	Threshold point of Limiter
M-Gain	Make-up gain
Gain L	Make-up gain for left channel
Gain R	Make-up gain for right channel
Soft Knee	Bending of the characteristic curve ² at the threshold point
Attack ³	Response time
Attack L	Response time of left channel (Wave Designer)
Attack R	Response time of right channel (Wave Designer)
Release ⁴	Release (right stop activates auto mode for Compr./Lim.)
Release L	Release of left channel
Release R	Release of right channel
Hold ⁵	Time until release process sets in
Range	Degree of damping (Gate); dynamic limitation (Ultramizer)
Density	Degree of compression (Ultramizer)
Speed	Recovery time (the higher the faster)
Split Frequency	Split point between high and low band
Stereo FX	Intensity of the stereo enhancer
Enhancer Frequency	Frequency of the HF ⁶ enhancer
Mix	Separates low, high band & wide (Ultramizer / De-Esser)
LP Frequency	Basic frequency (Denoiser)
LP Depth	Controls the amount of influence on the signal level (Denoiser)
LP Speed	Recovery time of low pass modulation (Denoiser)
Gate Hold	Time until the gate process sets in (Denoiser)
Gate Response	Gate recovery time (Denoiser)
Frequency	Lower cut-off frequency of compression process (De-Esser)

¹ Ratio determines the relation of input to output level for all signals which exceed the threshold point.

² The Soft Knee characteristic curve prevents a high compression rate (high ratio) from sounding unnatural.

³ Attack determines the time which the processor requires to react to signals which exceed the threshold point.

⁴ Release determines the time that the processor needs after falling below the threshold point to reach the original level.

⁵ Hold determines the time before the release process sets in (release sets in after the signal falls below the threshold point).

⁶ High frequency.

Tab. 2.4: Functioning of the dynamic effects' parameters



2.5 Psycho-acoustic effects

EXCITER: An exciter works with psycho-acoustic principles to add artificially generated overtones to the original signal, thereby increasing its presence and loudness (the subjective volume impression) without any significant increase of the signal level.

ENHANCER: The enhancer works like a dynamic pitch equalizer. Its effectiveness depends on the associated high frequencies and the intensity of the input signal.

ULTRA BASS: This awesome combination of sub-harmonic processor, bass exciter, and limiter adds a final touch to your music production.

STEREO IMAGER: This effect is used to process stereo main signals. The signal is first subdivided into middle and side signal (MS Matrix). Both parts can then be amplified when desired and placed on the stereo image.

ULTRA WIDE: This effect is suitable to pep up speaker systems with an especially broad stereo image.

BINAURALIZER: The binauralizer also extends the stereo image. Additionally, it compensates for inter-channel cross talk of both speakers (left loudspeaker on right ear and vice versa).

Parameter	Function
Gain	Gain correction
Frequency	Cut-off frequency of the side chain high pass filter ¹ (Exciter / Enhancer)
Filter Q	Resonance of the high pass filter (emphasizes cut-off frequency for Exciter / Enhancer)
Timbre	Ratio of straight and unstraight harmonics (Exciter / Enhancer)
Harmonics Kick	Activates an amplification of harmonics dependent on the input level (Exciter)
Bass Frequency	Frequency of the bass enhancer
Mix	Controls amount of harmonics (Exciter / Enhancer)
Process	Degree of synthetic harmonics (Enhancer)
Bass Gain	Degree of the bass enhancer
Bass Frequency	Cut-off frequency of the bass enhancer
Bass Q	Q factor of the bass enhancer
Sub-bass Frequency	Cut-off frequency of the sub-bass low pass filter (Ultra Bass)
Sub-bass Level	Degree of sub-harmonics
Harmonics	Degree of synthetic harmonics (Exciter)
Split Frequency	Cut-off frequency of the bass exciter (Ultra Bass)
Harmonics Gain	Degree of bass harmonics (Ultra Bass)
Harmonics Density	Density of harmonics (Ultra Bass)
Bass Gain	Degree of original bass signal (Ultra Bass)
Spread	Controls the influence on the stereo signal (Stereo Imager) / degree of stereo expansion (Ultra Wide)
Spread Mode	Selects between two different spread variations (Stereo Imager)
MS Balance	Ratio of middle and side signal (Stereo Imager)
Stereo Balance	Balance of stereo signal (Stereo Imager)
Mono Balance	Balance of mono signal (Stereo Imager)
Center	Degree of center signal (Ultra Wide)
Xover Frequency	Frequency of the crossover filter for the center signal (Ultra Wide)
Space	Degree of stereo wideness (Binauralizer)
Mode	Selects between headphones and speaker operation (Binauralizer)
Speaker Head	Switches between speaker and headphones, while "Speaker" selects the crosstalk compensation (Binauralizer)
Speaker Distance	Run time / speaker distance (Binauralizer)
Speaker Compensation	Degree of crosstalk compensation (Binauralizer)

¹ High pass filter, which allows frequencies above a specified cut-off frequency to pass and damps the frequencies lying below it.

Tab. 2.5: Functioning of the psycho-acoustic effects' parameters



2.6 Filter/EQ effects

FILTER: Filters, in general, influence the frequency response of a signal. A low pass filter allows low frequencies to pass and suppresses high frequencies, while a high pass filter allows high frequencies to pass and suppresses low frequencies.

PARAMETRIC EQ: The parametric equalizer is the most highly-developed form of equalization. You can control the three parameters which define the so-called gauss equalizer curve: bandwidth, frequency and amplitude boosting or lowering.

GRAPHIC EQ: Eight filter bands are arranged next to each other for this graphic equalizer. In contrast to the parametric equalizer, frequency and bandwidth are pre-determined here.

Parameter	Function
Base Frequency	Cut-off frequency
Depth	Degree of influence
Resonance	Resonance of the filter
Type	Operating mode of the filter
Attack	Response time of the envelope follower
Release	Release time of the envelope follower
Speed	Speed of the LFO
Wave	Sets the curve of the LFO
Gain 1/2	Boost/cut (param. EQ)
Freq. 1/2	Mid frequency (param. EQ)
Q 1/2	Q factor (param. EQ)
200 Hz	Boost/cut at 200 Hz (graph. EQ)
400 Hz	Boost/cut at 400 Hz (graph. EQ)
800 Hz	Boost/cut at 800 Hz (graph. EQ)
1.6 kHz	Boost/cut at 1.6 kHz (graph. EQ)
3.2 kHz	Boost/cut at 3.2 kHz (graph. EQ)
6.4 kHz	Boost/cut at 6.4 kHz (graph. EQ)
Bass	Boost/cut at 100 Hz (graph. EQ)
Treble	Boost/cut at 12 kHz (graph. EQ)
Mix	Gain correction (param. EQ / graph. EQ)

Tab. 2.6: Functioning of the filter/EQ effects' parameters



2.7 Distortion effects and amp simulations

VOCAL DISTORTION: This effect is very hip when used on vocals and drum loops, and is combined with a delay and flanger.

TUBE DISTORTION: This effect simulates the sound of different tube types. When an analog tube, as found in a guitar amplifier, is overamplified by raising the input signal (e.g. of a guitar), the original signal is mixed with the harmonic overtones. With rising overmodulation (also known as saturation of tubes), the original signal is distorted and the sound is fresh and full. This is a classic sound in rock music.

GUITAR AMP: This effect simulates the sound characteristics of a complete guitar amplifier. You can connect a guitar or bass (after appropriate pre-amplification) directly to the VIRTUALIZER PRO, and from there to a mixing console or recording device.

FUZZ: This is a special guitar distortion type. Jimi Hendrix was one of the first guitarists to recognize the appeal of this broadband transistor overmodulation. The humming distortion of the FUZZ BOX has again become popular with alternative rock and grunge. The VIRTUALIZER PRO's fuzz works in three different frequency bands.

SPEAKER SIMULATION: The VIRTUALIZER PRO is able to simulate various types of speakers. Typical guitar amplifying speakers as well as multimedia speakers are available. You can also use a parametric equalizer to further refine the sound.

RING MODULATOR: This effect allows a radical alienation of audio signals. Similar to the principle of FM radio, the signal is multiplied by a carrier frequency, so that frequency modulation (FM) takes place. This effect is very well suited for vocal alienation (robot voice).

LO-FI: For years, digital technique has been striving for high quality, low noise, and brilliant sounds. In the recent past there have been increasing calls for a return "to the roots" to achieve the warmth of the old analog sounds. The techno/dance group swears by vinyl and some music lovers miss the charm of good old vinyl discs and tape machines. This trend is known as Lo-Fi (instead of Hi-Fi). We have taken this tendency into account and included the relevant effect in the DSP2024P. Your recordings sound like 8-bit audio, complete with noise and humming like the old days! A true drum loop in TR808/TR909 style really gets going when it sounds thick and dusty.

Parameter	Function
Gain	Volume
Distortion	Distortion
Drive	Degree of tube distortion (Tube Distortion & Guitar Amp) / distortion at the output circuitry (Tri Fuzz)
Type	Nature of vocal distortion (Vocal Distortion) / selection of eight different loudspeakers (Speaker Simulation)
Delay	Length of delay
Delay Level	Degree of delay
Flanger Level	Degree of flanger
Flanger Speed	Speed of flanger
Pre HP	Frequency of the in-series connected high pass filter
Pre LP	Frequency of the in-series connected low pass filter
Bandlimit	Bandlimit of distorted signal (Tube Distortion) or limitation of high frequency parts (Ring Modulator & Lo-Fi)
Tube Selection	Selects between three tube types
Mid EQ	Mid equalizer
In Gain	Input gain
Low Fuzz	Distortion of low frequencies
Mid Fuzz	Distortion of mid frequencies
Hi Fuzz	Distortion of high frequencies
Cabinet Type	Selects between eight speaker types
Presence	Presence
Hi Damp	Damping of high frequency parts
Peak Gain	Raising or lowering of EQ
Peak Frequency	Frequency of EQ
Peak Q	Q factor of EQ
Speed	Speed of LFO
Depth	Modulation depth
Carrier Frequency	Modulation frequency
Mode	(Ring Modulator): LFO = The LFO modulates. ENV = Modulation through envelope follower. RAND = Modulation through random generator. SINE = The input signal is replaced by a sine tone and modulated by a random generator.
Slewing	Smoothing of modulation signal for RAND and SINE (Ring Modulator)
Bit Resolution	Resolution of D/A converter
Buzz Level	Intensity of the buzz level
Noise Level	Volume of the noise
Noise HP	Lower cut-off frequency of the noise
Noise LP	Upper cut-off frequency of the noise

Tab. 2.7: Parameter functions of distortion effects and amplification simulations



2.8 Special effects

VINYLIZER: This effect adds clicks and/or noise to your audio signal, simulating old vinyl records and tape recorders.

SAMPLER: This sampler allows you to record up to five seconds of program material. Use Edit A for recording and Edit B for playback of the sampled material.

 **To clear the contents of the sampler, select a different effect.**

VOCODER: The vocoder, an old acquaintance, has become popular again due to the disco renaissance (hear it in “Around the World” by Daft Punk or “California” by 2Pac). A control signal (usually a voice) is used in the right channel to modulate another signal which lies on the left channel (usually a synthesizer sound). It sounds as if the synthesizer is talking (robot voice).

VOICE CANCELER: The voice canceler is a very effective Karaoke effect. It allows removal of mono vocal parts in stereo recordings. The bass part, however, remains untouched.

RESONATOR: A resonator simulates an oscillating system that amplifies a specific frequency. The resonator implemented here has a resonance frequency that can be modulated with positive and negative feedbacks of up to 100%.

Parameter	Function
Speed	Rotations per minute (Vinylizer) / playback speed (Sampler) / speed of LFO (resonator)
Clicks Level	Volume of clicks
Scratch Level	Volume of "cracks in the record"
Noise (Level)	Volume of noise
Noise Frequency	Frequency response of noise
Bandlimit	Bandlimit of input signal
Record / Stop	Start / stop recording
Play / Stop	Start / stop playback
Mode	Forward, backward playback, number of repetitions (Sampler) / Resonator : LFO modulates (LFO), modulation through envelope follower (ENV), modulation through random generator (RAND)
Start Point	Playback starting point
Stop Point	Playback stop point
Sensitivity	Modulation intensity / input sensitivity
Attack	Response time of envelope follower
Release	Release time of envelope follower
Bass Frequency	Upper cut-off frequency of bass frequencies that are not effected
MS Balance	Degree of mid elimination
Treble Pan.	Panorama of high frequencies
Gain	Gain correction
Depth	Modulation depth
Carrier Frequency	Modulation frequency
Feedback	Degree of feedback
Slewing	(Resonator): Smoothing of modulation signal for RAND and SINE

Tab. 2.8: Parameter functions of special effects



2.9 Effects algorithm combinations (multi-effects programs)

Effects 61 to 71 are multi-effects algorithms, which allow different effects to be used simultaneously. Effect 61, for example, can make a solo guitar "wider" with chorus and simultaneously add a room reverb. Please note that you can modify the structure of a multi-effect (see chapters 3.1 and 3.6.4).

CHORUS & REVERB: This algorithm combines the popular chorus with a gold plate effect (as in algorithm 2).

FLANGER & REVERB: The combination of flanger and reverb effects.

ROTARY & REVERB: The input signal, modulated to a degree that you specify, is then processed with a reverb effect. This effect works especially well with keyboards and guitars.

PITCH & REVERB: The pitch shifter can be detuned in semitone or cent steps. The reverb, on the other hand, can be controlled in time and mixing ratio.

DELAY & REVERB: Delay and reverb are the most common combinations for vocals, solo guitars, etc. The reverb used here is a gold plate, a room that features a distinctive brilliance and can be used in many ways.

TREMOLO & REVERB: The intensive variation in volume of the tremolo gains more depth and wideness with the reverb.

PHASER & REVERB: The combination of a classic stereo phaser and a reverb effect.

CHORUS & DELAY: While the chorus can contribute to a wideness of the signal, interesting repetition effects can be adjusted with the delay. Vocals can be given a distinctive effect without making the voice sounding blurred.

FLANGER & DELAY: This effect is just right for creating a modern, slightly “spacey” vocal sound.

PITCH & DELAY: A repetition of the audio signal, with an oscillatory effect added by the pitch shifter.

TREMOLO & DELAY: A fast or slow, intensive variation of volume, which is additionally processed with a panorama effect.

Parameter	Function
Speed	Modulation speed
Reverb Mix	Wet/dry mix of modulation, delay and reverb effects (for algorithms 61 - 67)
Decay	Room size / duration of reverb tail
Depth	Intensity of delay, amplitude, or phase modulation
Doppler	Intensity of Doppler effect
Bandlimit	Damping of high frequencies
Type	(Delay & Reverb): Selects among mono, stereo and ping pong delay or a filter in the feedback chain
Delay (Time)	Length of the delay
Delay Mix	(Chorus & Delay): Ratio of chorus and delay
Feedback	Degree of feedback
Semitones	Detuning in semitones
Cents	Detuning in cents
Auto Mod.	Influence on LFO frequency (dependent on the input level)
Hi Damp	Damps the high frequencies of the reverb programs

Tab. 2.9: Parameter functions of multi-effects programs

 For an overview of the parameters available in the individual programs refer to chapter 7.1.

3. OPERATION

3.1 Effects structure

Algorithm No.	Effects structure
1-6, 8, 9	
7	
10	
11,12	
13	
14	
15	
17-19, 21 24, 26	

Fig. 3.1: Effects structure, part 1

Algorithm No.	Effects structure
16, 20, 22 23, 25, 28-30, 38-40, 45-48, 50, 53, 54, 57, 60	
27	
31-34	
35	
36	
37	
41	
42-44, 59	

Fig. 3.2: Effects structure, part 2

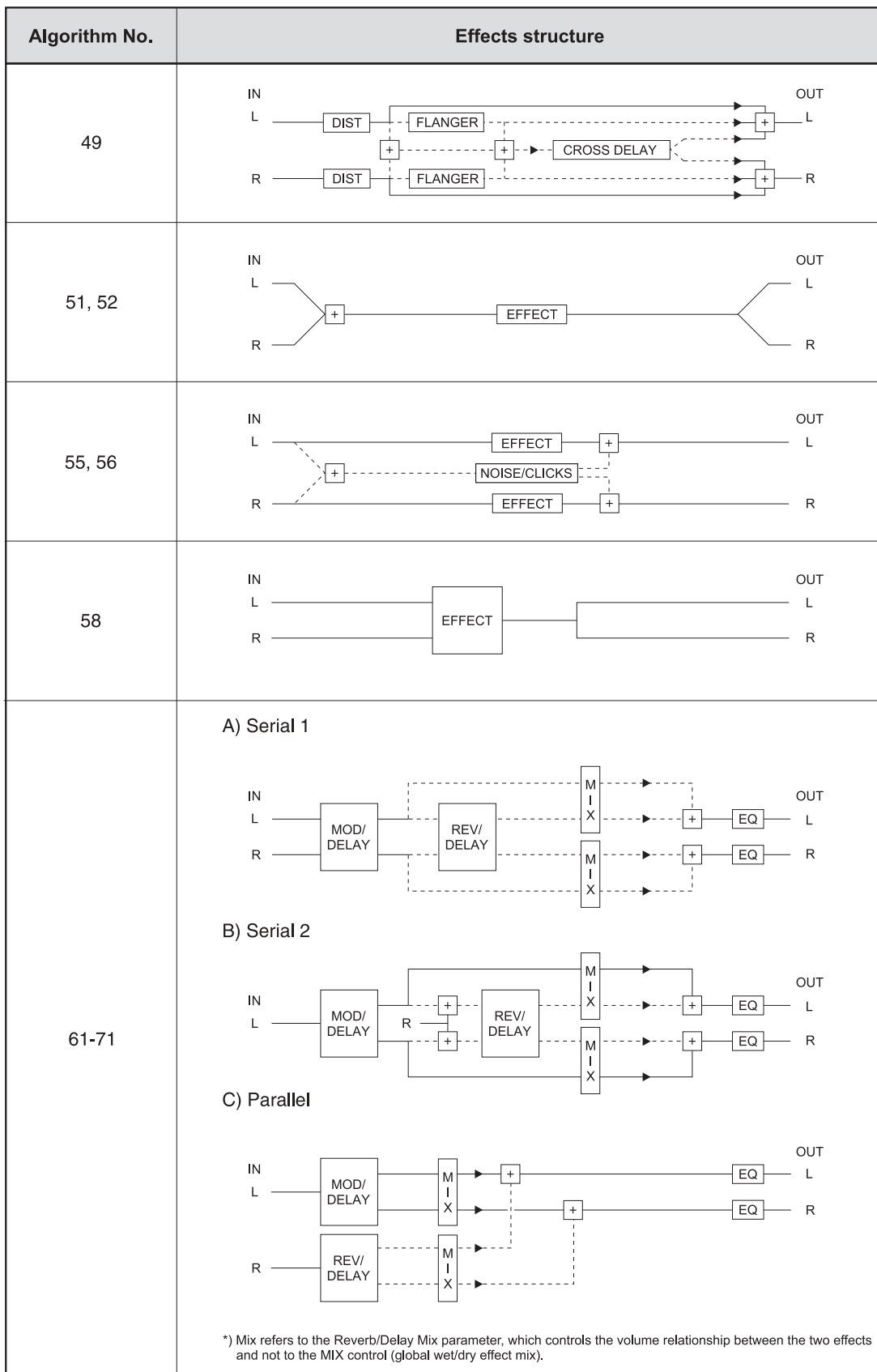



Fig. 3.3: Effects structure, part 3

3.2 Calling up presets

The VIRTUALIZER PRO has 100 **internal presets** and 100 **user presets** that can be overwritten. The two memory banks are located one after another. The internal presets (I.000 - I.100) come first and the user presets (U.000 - U.100) follow.

After switching on the unit, the last used preset is automatically restored. To choose a different preset, press the PRESET key, then rotate the JOG WHEEL. To see the presets in ascending order, rotate the wheel clockwise. To see the presets in descending order, rotate it counterclockwise.

 **Please note that it takes the VIRTUALIZER PRO about one second to activate each newly selected preset. The activation process is indicated by a blinking light on the display. After the new effect's data is loaded, the VIRTUALIZER PRO activates the preset and the light fades. This brief signal suppression means that during quick selection of presets with the JOG WHEEL, not every preset is activated directly. Otherwise, there could be partial "shreds" of various presets at the audio outputs of the DSP2024P. The VIRTUALIZER PRO gives you the security that unwanted programs are not loaded. In addition, you can quickly turn the JOG WHEEL and still have enough time to specifically select a preset without activating "neighboring programs".**

 **Please note that various effects algorithms may have different volume levels. Reduce the volume of your monitors while selecting new presets to prevent sudden changes in volume.**

3.3 Editing programs (edit mode)

Programs can be edited easily and quickly with the DSP2024P. The list on the right side of the LED DISPLAY gives you an overview of the effects algorithms that the VIRTUALIZER PRO can generate. To select these basic algorithms, press the EFFECT key and rotate the JOG WHEEL.

By turning the EDIT CONTROLS and the MIX/BYPASS CONTROL, you can extensively modify the sound of an effects program. You select the EDIT CONTROL function using the EDIT key. By repeatedly pressing the EDIT key, you can (for example) specify whether parameter EDIT A or EDIT E will be changed with the 1st EDIT CONTROL. The currently illuminated LED indicates which parameters will be edited. By modifying the EQ LO and EQ HI parameters, you can put the final touch on an effect. As soon as you start editing, the LED of the PRESET or EFFECT key (depending on whether you have already loaded one of the 200 presets or have selected one of the basic algorithms) dies out. Simultaneously, the LED of the STORE key starts to blink, indicating that changes have been made.

3.4 Storing programs

To store changes to one of the 100 user presets, as described in chapter 3.3, you use the STORE key. All changes to the DSP2024P's parameters can be stored when the STORE key's LED blinks. For your changes to be accepted, you must press the STORE key twice. An example:

▲ You call up a program and make changes to it using the four EDIT CONTROLS and the MIX/BYPASS CONTROL. Each EDIT CONTROL controls two parameters that can be selected by pressing the EDIT key. During this process, the STORE key blinks, indicating that the preset's settings have been changed. However, your changes are not yet stored. If you want to overwrite the original preset, simply press the STORE key twice to store your changes. If you wish to retain the original preset, press the STORE key once. The display shows the current preset number and starts blinking. Use the JOG WHEEL to select another preset, which you will overwrite. Press the STORE key again and your changes are stored in the selected preset.

 **If there is no input for about five seconds after pressing the STORE key, the unit goes back to edit mode.**

 If you make changes in a preset and press the STORE key twice, all of the preset’s original settings are overwritten and your new parameters are stored. If you want to retain the old preset, you must select another preset (using the JOG WHEEL) before pressing the STORE key for the second time.

3.5 Comparing an edited preset with the corresponding factory preset (COMPARE function)

When you have made changes in a preset but have not yet stored your changes, the COMPARE Function allows you to load the original factory preset and compare it with your changes. To do so, press the COMPARE key while in edit mode. As long as the COMPARE key’s LED blinks, further editing is (temporarily) not possible. Press the COMPARE key again to return to your edited preset. Here, you have the choice to either store your changes (see chapter 3.4), or continue editing (see chapter 3.3).

3.6 SETUP mode

In SETUP mode, you can make global adjustments to the VIRTUALIZER PRO as described in the sub-sections below. Among these are MIDI, INPUT mode, OUTPUT mode and dual engine configuration (CONFIG). To enter SETUP mode, press the SETUP key. The red LED below the EDIT CONTROLS lights up. The four EDIT CONTROLS can now be used to adjust the SETUP parameters. To exit this mode, press the SETUP key again.

3.6.1 MIDI control

The DSP2024P’s MIDI editing options are shown on seven pages. Enter SETUP mode (see chapter 3.6). With the help of the 1st EDIT CONTROL, you can select seven different MIDI functions. Data input is always carried out with the JOG WHEEL. the following pages can be selected:

- ▲ CHAN: You can set the MIDI channel on the first page. With the JOG WHEEL, the channel can be set from 01 to 16. If you select “OFF”, the MIDI function is switched off.
- ▲ OMNI: The second page gives access to omni mode. In this case, the unit receives MIDI data on all 16 MIDI channels. “ON” appears in the DISPLAY. With the JOG WHEEL, select “OFF” to deactivate omni mode.
- ▲ CONT: On the third page, you can configure the controller commands. You can choose between four controller modes:

Display	Mode
OFF	No controller data are transmitted / received.
RECV	Controller data are received but not transmitted.
SEND	Controller data are transmitted but not received.
BOTH	Controller data are transmitted and received.

Tab. 3.1: Controller settings

For controller functions see table 7.4 in chapter 7 “APPENDIX”.

- ▲ PRGM: Page four will bring you to the setup for the program changes. Once again, you have four modes to select from:

Display	Mode
OFF	Program Changes are not transmitted / received.
RECV	Program Changes are received but not transmitted.
SEND	Program Changes are transmitted but not received.
BOTH	Program Changes are transmitted and received.

Tab. 3.2: Program change settings

- ▲ **STOR:** On the fifth page, you can select the Store Enable mode. In the “ON” mode, the VIRTUALIZER PRO receives controller 112 as the direct storage command—the current settings are stored on the program location corresponding to the controller value without waiting for a confirmation. In the “OFF” mode, controller 112 is ignored.

 **CAUTION:** The Store Enable mode is aimed to transfer several presets at once from an external PC to the VIRTUALIZER PRO (see also chapter 5.1). In this mode, you can very easily overwrite your program locations by unintentionally sending controller 112 values to the DSP2024P! Therefore, we strongly recommend to switch off this mode immediately after use. When the DSP2024P is switched on, this mode is automatically set to off (“OFF”).

- ▲ **DUMP:** Select the System Exclusive mode (“SysEx”) using the sixth page. In this mode, the DSP2024P is ready to “dump” its complete storage content, including all settings, to a MIDI sequencer. Start your MIDI sequencer and turn the JOG WHEEL. The data transfer is indicated by “GO”.
- ▲ **DR.EN:** In this mode, the DSP2024P can receive SysEx data from another MIDI device. To load this data, turn the JOG WHEEL slightly so that the DISPLAY blinks. Start your sequencer, and all of your settings, including preset parameter settings, are received by your VIRTUALIZER PRO. Data transfer is interrupted by turning the JOG WHEEL slightly so that “----” appears in the DISPLAY.

 **During a SysEx data transfer, all audio functions of the VIRTUALIZER PRO are inactive.**

3.6.2 INPUT mode

With the help of the 2nd EDIT CONTROL, you can specify whether your DSP2024P works as a mono (“MONO”) or a stereo unit (“STER”). In mono mode, input 1 is used exclusively. Since the VIRTUALIZER PRO is a real “True Stereo” device, the DSP processes the signal for many effects separately for both channels (see chapter 7.1). For effects 13 - 15 and 38, right and left channel parameters can even be edited separately.

 **For effects 42 - 44, 58, and 59, a signal must be present at both inputs for optimal stereo results.**

3.6.3 OUTPUT mode

Use the 3rd EDIT CONTROL to determine the DSP2024P’s OUTPUT mode. The selection of settings depends on your DSP2024P’s application. If you’re using the VIRTUALIZER PRO in connection with a mixing console (aux bus), activate the Mix External (“EXTN”) output mode. The DSP2024P’s output signal is then 100% wet.

If you’re using the DSP2024P with a guitar amplifier that has an effects loop, select the Mix Internal (“INTN”) output mode. Then, use the MIX/BYPASS CONTROL to adjust the effect volume. For further information, see chapters 4.2 and 4.4.

3.6.4 Dual engine configuration (CONFIG)

You can use the 4th EDIT CONTROL to decide how the DSP2024P’s effects combinations (presets 61 - 71) should be structured. Since the DSP2024P is a true Dual Engine unit, you can choose between serial 1 (“SER1”), serial 2 (“SER2”) and parallel (“PARA”). See fig. 3.1, 3.2 and 3.3 to understand how these settings influence the composition of the effects combinations.

In the example of preset 61 (chorus & reverb), you can decide, whether the chorus and reverb effects run separately from each other or whether the signal, treated by the chorus, passes the reverb effect.

3.7 Restoring the factory presets

To restore the DSP2024P to its preset factory state, press and hold the STORE and PRESET keys while switching on the unit. "INIT" appears in the DISPLAY and counting takes place from R 1 to R 100.

 **This overwrites all changes you have made and restores the factory presets!**

4. APPLICATIONS

The BEHRINGER VIRTUALIZER PRO is a flexible unit that can be used in various applications. Prior to a presentation of the DSP2024P's many uses, please note the following remarks on how to set signal levels correctly.

4.1 Level setting

Take care to set all levels properly on the DSP2024P! Low levels deteriorate the dynamics of the music signal, which results in a poor, weak and noisy sound. On the other hand, excess levels overdriving the converters in the VIRTUALIZER PRO should also be avoided. Digital distortion is (unlike its analog counterpart) extremely unpleasant, since it does not occur gradually but abruptly.

Please use the OPERATING LEVEL switch and the input level meter of the DSP2024P. Make sure that the Clip LEDs flickers only rarely. Ensure that they never light up all the time!

4.2 Using the VIRTUALIZER PRO in the aux bus

Using the DSP2024P in the aux bus lets you feed signals from one, several or all channels of your console into the VIRTUALIZER PRO. When miking a drum kit, for example, you can use the aux controls to adjust the reverberation independently for each channel. Thus, you are able to assign a strong reverb to the snare rather than the toms. Cabling the VIRTUALIZER PRO in the aux bus should be carried out as follows:

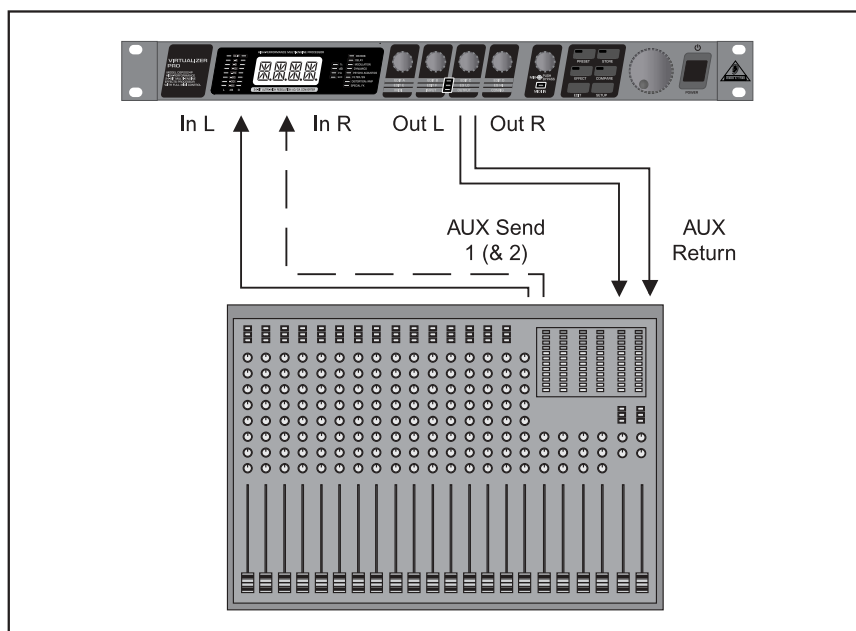

Fig. 4.1: Wiring aux busses

Connect both inputs of the VIRTUALIZER PRO to the aux send outputs of your mixer. The DSP2024P's output socket is connected to the aux return inputs of your mixer. If you want to operate the BEHRINGER VIRTUALIZER PRO in mono, connect one of its channels (left or right) to an aux bus. As a matter of principle, effects processors should always be connected to post fader aux busses.

- ☞ If your mixing console has aux busses that feature one jack for the aux send, use audio channel 1 on the DSP2024P. In this case, you must choose the mono mode (see chapter 3.6.2).
- ☞ To avoid damage to your equipment, turn down the volume level on your amplifier when making connections. Switch off the devices that you want to connect to one another until plug connections have been completed as described.

Let's assume you want to operate the DSP2024P in a live situation in connection with a mixing console, and use a chorus to enhance the guitar sound.

Connect the VIRTUALIZER PRO to the aux busses of your mixing console (fig. 4.1). Make the mains connection and set the operating level if necessary. Switch on the unit. In SETUP mode (output), select "EXTN" to ensure that the Mix External mode is activated. Press the EFFECT key and use the JOG WHEEL to select the stereo chorus effect (no. 16). Turn up the aux busses slowly till you have mixed the desired effect with the guitar signal. After this, you can start fine tuning. You will probably want to specify the chorus' modulation. Turn the 1st EDIT CONTROL to determine the speed of the modulation. To adjust the modulation depth, turn the 2nd EDIT CONTROL. Proceed further following this principle. If you want the 1st EDIT CONTROL to change EDIT E, you must first press the EDIT key. After all the parameters have been changed as you wish, you can store the modifications in the original (or a different) preset.

4.3 Using the VIRTUALIZER PRO in the insert path

Generally, you can use the DSP2024P on channel or subgroup inserts, using a standard insert cable. Connection to a channel insert makes sense when you want to process very specific signals (e.g. vocals) with the VIRTUALIZER PRO, or when all other options for connecting the DSP2024P are already used by other units. For compressors, expanders and gates, the channel insert is the best choice.

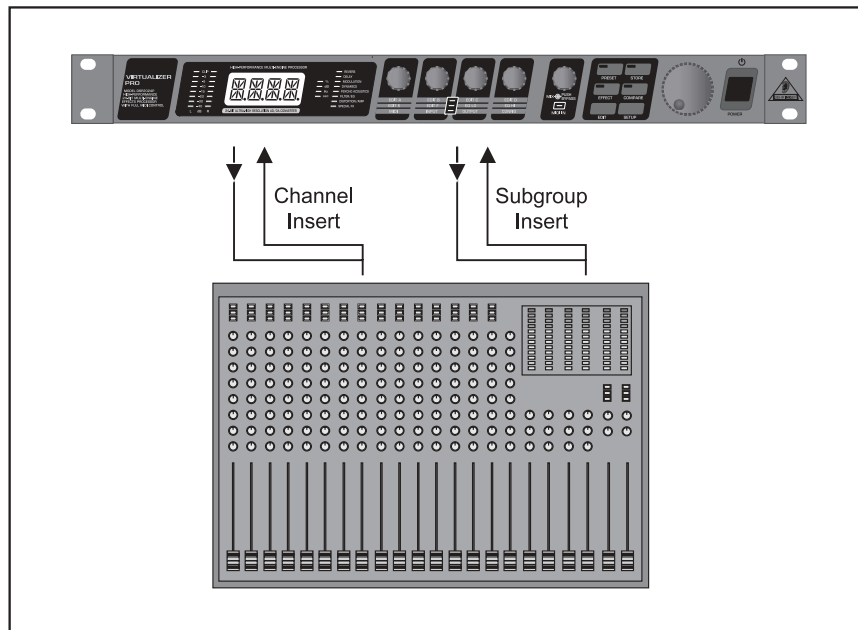

Fig. 4.2: Wiring the VIRTUALIZER PRO in the insert path

4.4 Using the VIRTUALIZER PRO as an effects device for instruments

Due to its MIDI implementation, the VIRTUALIZER PRO can also be used as multi-effects unit in a guitar rack. Naturally, the VIRTUALIZER PRO can be cabled both as mono and as stereo unit. The following examples show how to use the DSP2024P with a guitar setup.

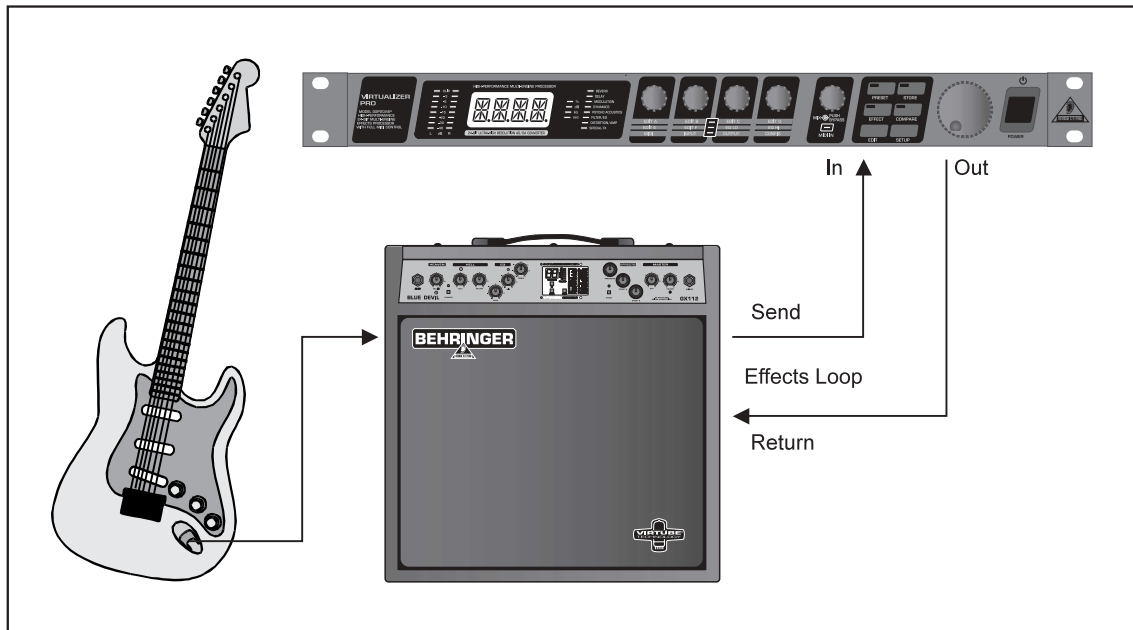

Fig. 4.3: Connecting the VIRTUALIZER PRO to a guitar amp (send/return mono)

Fundamentally, the following applies: The VIRTUALIZER PRO should be connected between preamp and output stage of your amplifier. For this purpose, most of the guitar amplifiers offer an effects loop, which allows the preamp signal of your amplifier to pass on to the audio input stage of the DSP2024P. Then, in the VIRTUALIZER PRO, the preamp signal is processed and sent back to its amplifier through the amplifier's return jack (Power Amp In). If you use a stereo rack system for amplification, you can also set up the VIRTUALIZER PRO in stereo mode. Connect the preamp to the audio inputs of the DSP2024P. Each of its audio outputs (left/right) is connected to a channel (left/right) of your amplifier.

👉 Since most guitar amps only feature a serial effects loop, you should make sure that the VIRTUALIZER PRO is set to Mix Internal mode. In Mix Internal mode, you can control the effects intensity that is applied to the guitar signal. If, however, your amp is equipped with a parallel effects loop, which allows for adding the effects signal portion (similar to an aux bus in a mixing console), then you should set the VIRTUALIZER PRO to Mix External mode. In this case, the effects intensity present at the outputs of the VIRTUALIZER PRO is 100%

Instrumentalists can benefit from a variety of advantages offered by the VIRTUALIZER PRO's MIDI implementation. With a MIDI foot controller, e.g. the BEHRINGER MIDI FOOT CONTROLLER FCB1010, you can transfer program changes via MIDI. Connect the MIDI out port of your foot controller to the MIDI IN port of the VIRTUALIZER PRO. If the DSP2024P does not respond to your foot controller's program changes, check your MIDI channel settings. Determine which MIDI channel your foot controller uses to send program changes (in most of the cases: omni mode). Set the VIRTUALIZER PRO's MIDI channel to the same number and switch program change receive mode on (see chapter 3.6.1).

If your MIDI foot controller can send MIDI controller data, you can change parameters while playing. For example, you can change the effect from 0% to 100% with the controller while playing. Set controller No. 116 to the Mix Internal function (value 1) and increase the effect (value 0 - 100) with controller No. 111. In this way, you can provide a guitar solo with chorus and delay, before removing the effects for a dry rhythm sound. You can even control the bypass function with your controller (contr. 113, value 0 = OUT, value 1 = IN). Bypassing the VIRTUALIZER PRO can be activated this way if you need an unprocessed signal. These procedures are generally possible with all MIDI devices which are capable of transmitting controller commands (like keyboards, sequencers, etc.).

The DSP2024P can also be used between the outputs of your keyboard and the inputs of your mixer. If necessary, adjust the operating level with the corresponding switch on the rear panel of the unit.

4.5 Using the VIRTUALIZER PRO in a MIDI setup

Thanks to the integrated MIDI interface, you can incorporate the DSP2024P in a MIDI setup. The VIRTUALIZER PRO can receive and send both program changes and controller changes. Thus, you can use program changes using MIDI with a sequencer or with any other MIDI device. Connect the DSP2024P e.g. as follows:

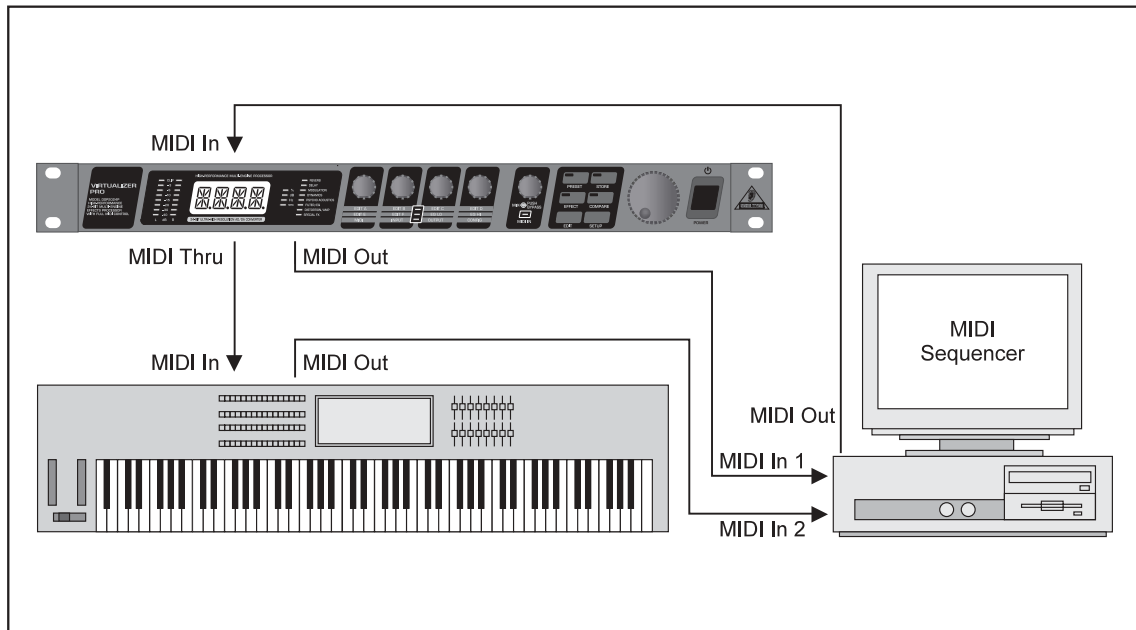

Fig. 4.4: VIRTUALIZER PRO in MIDI connection with a sequencer (computer) and a keyboard

5. MIDI FUNCTIONS OF THE DSP2024P

Due to the complete implementation of the MIDI interface, it is very easy to integrate the VIRTUALIZER PRO in a MIDI System.

▲ MIDI IN

All MIDI data that are sent to the DSP2024P (sequencer, MIDI foot controller, etc.) are received at the MIDI IN port. If you want to use the DSP2024P as an effects unit in a guitar rack, you can connect a MIDI foot controller to the MIDI IN socket, and use it to change the program presets. If you are simultaneously operating another MIDI device, you can transfer the control commands of the MIDI foot controller using the MIDI THRU socket of the VIRTUALIZER PRO.

▲ MIDI THRU

The MIDI THRU socket allows you to loop through incoming MIDI signals. All control commands that arrive at the MIDI IN socket can be passed on to other MIDI devices and instruments using the MIDI THRU socket.

▲ MIDI OUT

Use the MIDI OUT to send data to a connected computer or other VIRTUALIZER PRO.

5.1 Saving data via MIDI

To store all presets outside the VIRTUALIZER PRO, you can use a special form of MIDI communication called system exclusive data (SysEx). With SysEx, the VIRTUALIZER PRO sends information about its manufacturer, unit type, and all parameter settings for all presets to a sequencer or MIDI file recorder. To

activate this very practical function, press the SETUP key in SETUP mode. Turn the 1st EDIT CONTROL to select "DUMP". Your VIRTUALIZER PRO is now ready to transfer your system exclusive data. Select a track on your MIDI sequencer, get ready for recording, start the recording and turn the JOG WHEEL. The data transfer is indicated by a "GO" in the DISPLAY.

To load the data back into the DSP2024P, select "DR.EN" in SETUP mode (see chapter 3.6.1). Turn the JOG WHEEL until "DR.EN" blinks. Now, start your MIDI sequencer and the preset data is automatically transferred to the DSP2024P. In this mode, information sent from the MIDI sequencer is automatically stored while receiving, without asking for confirmation.

6. INSTALLATION

6.1 Mains connection

Before connecting the VIRTUALIZER PRO to the mains, please carefully check that your equipment is set to the correct voltage! The fuse holder on the mains socket has 3 triangular markings. Two of these triangles are located opposite each other. The VIRTUALIZER PRO is set at the operating voltage indicated beside the markings and can be changed by turning the fuse holder by 180°. **CAUTION: This is not applicable for export models, which were designed only for a mains voltage of 120 V!**

Connection to the mains is made by means of a mains cable with an IEC receptacle which complies with the required safety regulations.

 **Please note that all pieces of equipment must be grounded. For your own safety, under no circumstances should you remove or deactivate the grounding of the equipment or the mains cable.**

6.2 Audio connections

As standard, the BEHRINGER VIRTUALIZER PRO features electronically servo-balanced inputs and outputs. If possible, connect the unit to other devices in a balanced configuration to allow for maximum interference immunity.

 **Installation and operation of this equipment must be carried out by competent staff only. Both before and after installation, the staff using the equipment should make sure that it is properly grounded since otherwise electrostatic discharge etc. can lead to an impairment of its operation.**

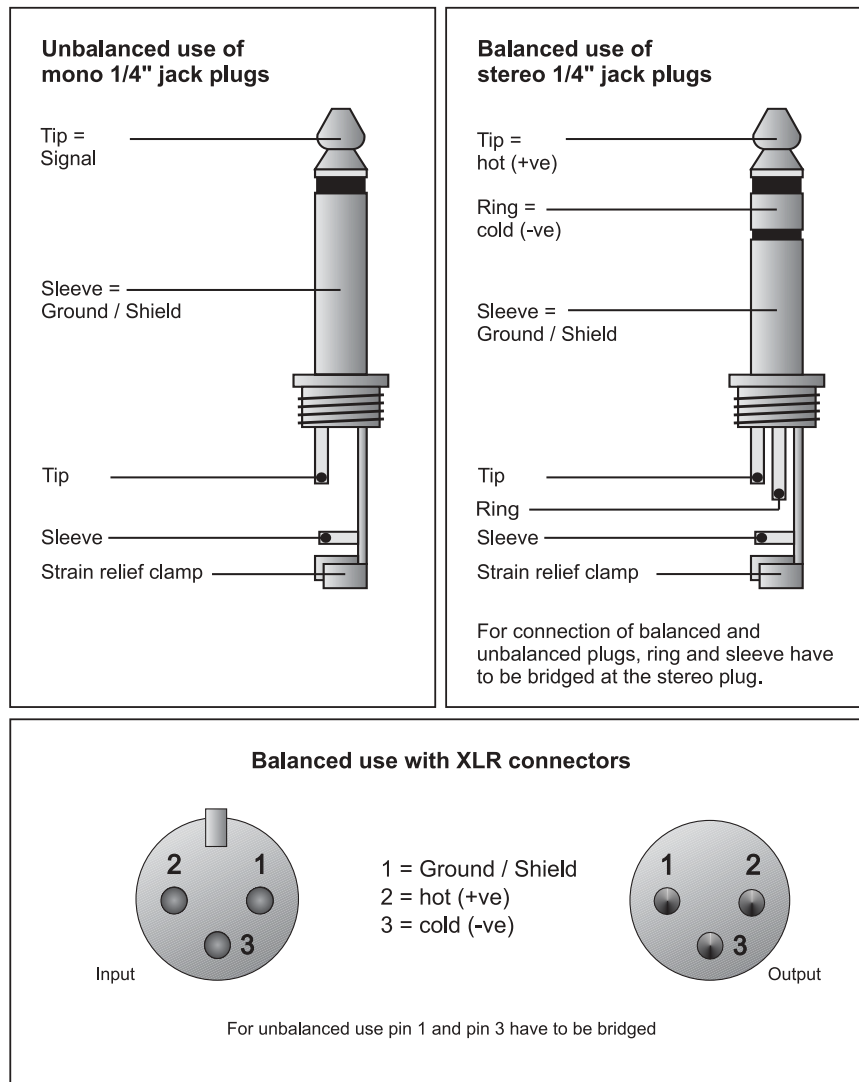

Fig. 6.1: Different plug types

6.3 MIDI connections

The MIDI connectors at the rear panel of the unit are equipped with internationally standardized 5 pin DIN sockets. You'll need a MIDI cable to connect the VIRTUALIZER PRO with other MIDI devices. As a rule, standard ready-to-use cables can be used. With a two core shielded cable (e.g. microphone cable) and two possible stable 180 deg. DIN plugs, you can also solder a MIDI cable yourself: Pin 2 (middle) = shield, pin 4 and 5 (right and left of pin 2) = Inner conductor, Pin 1 and 3 (both lying outside) remain free. MIDI cables should not be longer than 15 meters.

MIDI IN: is used for receiving MIDI data. The receiving channel is selected in the SETUP menu.

MIDI THRU: At the MIDI THRU socket, the MIDI data that arrive at the MIDI IN socket can be looped through. Several VIRTUALIZER PROs can be linked using MIDI THRU sockets.

MIDI OUT: Via MIDI OUT, you can send data to a connected computer or to other VIRTUALIZER PROs. Program data and status information are transmitted for signal processing.

6.4 Selecting the operating level

The BEHRINGER VIRTUALIZER PRO allows you to switch the internal operating level with the OPERATING LEVEL switches on the rear panel of the unit. Thus, you can choose between the homerecording level (-10 dBV) and the professional studio level (+4 dBu). With this adjustment, the VIRTUALIZER PRO is adapted to the optimal operating level. Use the input level meter on the front panel to find the appropriate operating level.

7. APPENDIX

7.1 Parameter overview

Nr.	Effect	True Stereo	Edit A	Edit B	Edit C	Edit D	Edit E	Edit F	Mix
Reverb									
1	Cathedral		Pre Delay	Decay	Hi Dec. Damp.	Bass Mul.	Shv. Damp.	Rev. Mod.	Mix
2	Gold Plate		Pre Delay	Decay	Hi Dec. Damp.	Size	Shv. Damp.	Diffusion	Mix
3	Small Hall		Pre Delay	Decay	Hi Dec. Damp.	Size	Shv. Damp.	Low Cut	Mix
4	Room		Pre Delay	Decay	Hi Dec. Damp.	Size	Shv. Damp.	Diffusion	Mix
5	Concert		Pre Delay	Decay	Hi Dec. Damp.	Bass Mul.	Shv. Damp.	Reverb Mod.	Mix
6	Studio		Pre Delay	Decay	Hi Dec. Damp.	Low Cut	Shv. Damp.	Shv. Freq.	Mix
7	Stage		Pre Delay	Decay	Hi Dec. Damp.	Size	Shv. Freq.	ER/Rev.	Mix
8	Spring Reverb		Pre Delay	Decay	Hi Dec. Damp.	Metal Res.	High Cut	Diffusion	Mix
9	Ambience		Pre Delay	Decay	Diffusion	Size	Shv. Damp.	Shv. Freq.	Mix
10	Early Reflections	x	Pre Delay	Size	Wall Damp.	Reflections	Stereo Width	-	Mix
11	Gated Reverb		Pre Delay	Decay	Hi Dec. Damp.	Shv. Damp.	Gate Threshold	Gate Hold	Mix
12	Reverse Reverb		Pre Delay	Decay	Hi Dec. Damp.	Shv. Damp.	Threshold	Hold Time	Mix
Delay									
13	Stereo Delay	x	Del. L. Co.	Del. L. Fine	Del. R. Co.	Del. R. Fine	Feedback L.	Feedback R.	Mix
14	Tape Echo	x	Delay Left	Delay Right	Feedback	Bandlimit	Feedback HP	Feedback LP	Mix
15	Ping Pong	x	Delay Left	Delay Right	Feedback L.	Feedback R.	Feedb. Del. L.	Feedb. Del. R.	Mix
Modulation									
16	Stereo Chorus	x	Speed	Depth	Delay	Stereo Phase	LFO Wave	Bandlimit	Mix
17	Analog Chorus		Speed	Depth	Delay	Spread	-	-	Mix
18	Vintage Chorus		Speed	Depth	Delay	Bandlimit	-	-	Mix
19	Ultra Chorus		Speed	Depth	Delay	Wideness	Stereo Spread	Bandlimit	Mix
20	Stereo Flanger	x	Speed	Depth	Feedback	Delay	Stereo Phase	Feedback LP	Mix
21	Vintage Flanger		Speed	Depth	Feedback	Delay	-	-	Mix
22	Jet Stream Flanger	x	Speed	Depth	Feedback	Delay	-	-	Mix
23	Stereo Phaser	x	Speed	Depth	Feedback	Stereo Phase	Mode	LFO Wave	Mix
24	Vintage Phaser	x	Speed	Depth	Feedback	Intensity	Stereo Phase	-	Mix
25	Dual Phaser	x	Speed	Depth	Feedback	Base	-	-	Mix
26	Rotary		Speed	Drum Depth	Horn Depth	Drive	Balance	Split Frequency	Mix
27	Pitch Shifter	x	Semitones 1	Cents 1	Semitones 2	Cents 2	Semitones 3	Cents 3	Mix
28	Vibrato	x	Speed	Depth	Wave	Auto Modul.	-	-	Mix
29	Tremolo	x	Speed	Depth	Wave	Auto Modul.	-	-	Mix
30	Auto Panning	x	Speed	Depth	Wave	Auto Modul.	-	-	Mix
Dynamics									
31	Compressor	x	Ratio	Threshold	M-Gain	Soft Knee	Attack	Release	On/Off
32	Expander	x	Ratio	Threshold	M-Gain	Soft Knee	Attack	Release	On/Off
33	Gated Reverb	x	Hold	Threshold	Attack	Release	Range	-	On/Off
34	Ana. Kompr./Lim.	x	Ratio	Threshold	M-Gain	Limiter Thresh.	Attack	Release	On/Off
35	Ultramizer	x	Density	Range	Speed	Split Frequency	Stereo FX	Enhancer Freq.	Lo/Hi/Wide
36	Denoiser	x	LP Freq.	LP Depth	LP Speed	Gate Threshold	Gate Hold	Gate Response	On/Off
37	De-Esser	x	Ratio	Threshold	M-Gain	Frequency	Attack	Release	Lo/Hi/Wide
38	Wave Designer	x	Attack L	Release L	Attack R	Release R	Gain L	Gain R	On/Off

Tab. 7.1: Overview of the individual parameters of effects types (continued on next page)

Nr.	Effect	True Stereo	Edit A	Edit B	Edit C	Edit D	Edit E	Edit F	Mix
Psycho Acoustics									
39	Exciter	x	Frequency	Filter Q	Harmonics	Timbre	Harmon. Kick	-	Mix
40	Enhancer	x	Frequency	Filter Q	Process	Bass Gain	Bass Freq.	Bass Q	Mix
41	Ultrabass	x	Subbass Freq.	Subbass Level	Split Freq.	Harmon. Lev.	Harmon. Density	Bass Level	On/Off
42	Stereo Imager	x	Spread	MS Balance	Spread Mode	Gain	Stereo Balance	Mono Balance	On/Off
43	Ultra Wide	x	Center	Spread	Xover Freq.	Gain	-	-	On/Off
44	Binauralizer	x	Center	Space	Spk/Head	Gain	Spk. Distance	Speaker Compens.	On/Off
Filter/EQ									
45	Auto Filter	x	Base Freq.	Depth	Type	Resonance	Attack	Release	Mix
46	LFO Filter	x	Base Freq.	Depth	Type	Resonance	Speed	Wave	Mix
47	Param. EQ	x	Gain 1	Freq. 1	Q 1	Gain 2	Freq. 2	Q 2	Gain
48	Graph. EQ	x	200 Hz	400 Hz	800 Hz	1.6 kHz	3.2 kHz	6.4 kHz	Gain
Distortion/Amp Simulation									
49	Vocal Distortion	x	Distortion	Delay Level	Delay	Flanger Level	Type	Flanger Speed	Mix
50	Tube Distortion	x	Drive	Pre HP	Pre LP	Bandlimit	Tube Selection	Mid EQ	Mix
51	Guitar Amp		In Gain	Drive	Presence	Gain	Cabinet Type	Mid EQ	Mix
52	Tri Fuzz		In Gain	Low Fuzz	Mid Fuzz	Hi Fuzz	Drive	Hi Damp	Mix
53	Speaker Simulation	x	Type	Peak Gain	Peak Freq.	Peak Q	-	-	Mix
54	Ring Modulator	x	Speed	Depth	Carrier Freq.	Bandlimit	Mode	Slewing	Mix
55	LoFi	x	Bit Resolution	Bandlimit	Buzz Level	Noise Level	Noise HP	Noise LP	Mix
Special FX									
56	Vinylizer	x	Speed	Clicks Level	Scratch Level	Noise Level	Bandlimit	Noise Freq.	Mix
57	Sampler	x	Record / Stop	Play / Stop	Speed	Mode	Start Point	Stop Point	Mix
58	Vocoder		Sensitivity	Noise	Attack	Release	-	-	Mix
59	Voice Canceler	x	Bass Freq.	MS Balance	Treble Pan.	Gain	-	-	On/Off
60	Resonator	x	Speed	Depth	Carrier Freq.	Feedback	Mode	Slewing	Mix
Combination									
61	Chorus & Reverb		Speed	Depth	Delay	Reverb Mix	Decay	HiDamp	Mix
62	Flanger & Reverb		Speed	Depth	Feedback	Reverb Mix	Decay	HiDamp	Mix
63	Leslie & Reverb		Speed	Depth	Doppler	Reverb Mix	Decay	HiDamp	Mix
64	Pitch & Reverb		Semitones	Cents	Bandlimit	Reverb Mix	Decay	HiDamp	Mix
65	Delay & Reverb		Delay	Feedback	Type	Reverb Mix	Decay	HiDamp	Mix
66	Tremolo & Reverb		Speed	Depth	Auto Mod.	Reverb Mix	Decay	HiDamp	Mix
67	Phaser & Reverb		Speed	Depth	Feedback	Reverb Mix	Decay	HiDamp	Mix
68	Chorus & Delay		Speed	Depth	Delay	Delay Mix	Delay Time	Feedback	Mix
69	Flanger & Delay		Speed	Depth	Feedback	Delay Mix	Delay Time	Feedback	Mix
70	Pitch & Delay		Semitones	Cents	Bandlimit	Delay Mix	Delay Time	Feedback	Mix
71	Tremolo & Delay		Speed	Depth	Auto Mod.	Delay Mix	Delay Time	Feedback	Mix

Tab. 7.2: Overview of the individual parameters of effects types (continuation)

7.2 MIDI implementation

MIDI Implementation Chart				
Function		Transmitted	Recognized	Remarks
Basic Channel	Default	OFF, 1 - 16	OFF, 1 - 16	memorized
	Changed	OFF, 1 - 16	OFF, 1 - 16	
Mode	Default	1,2,3,4	1,2,3,4	
	Messages	X	X	
	Altered	X	X	
Note Number		X	X	
	True Voice	X	X	
Velocity	Note ON	X	X	
	Note OFF	X	X	
After Touch	Key's	X	X	
	Ch's	X	X	
Pitch Bender		X	X	
Control		0,102 - 116	0,102 - 116	
Progr. Change		O (0-99)	O (0-99)	
	True #	1-100	1-100	
System Exclusive		O	O	
System Common	Song Pos	X	X	
	Song Sel	X	X	
	Tune	X	X	
System Real Time	Clock	X	X	
	Commands	X	X	
Aux Messages	Local ON/OFF	X	X	
	All notes OFF	X	X	
	Active Sense	X	X	
	Reset	X	X	
Notes				
O = YES, X = NO				
Mode 1: OMNI ON, POLY				
Mode 2: OMNI ON, MONO				
Mode 3: OMNI OFF, POLY				
Mode 4: OMNI OFF, MONO				

Tab. 7.3: MIDI implementation chart

Parameter Name	Display Range	MIDI Control Number	Control Value Range
Bank Select	I.001 .. 100/U.001 .. 100	0	0 = ROM / 1 = RAM
Algorithm	Algorithm Name	102	0 .. 70
Edit A	Depends on effect	103	Depends on effect
Edit B	Depends on effect	104	Depends on effect
Edit C	Depends on effect	105	Depends on effect
Edit D	Depends on effect	106	Depends on effect
Edit E	Depends on effect	107	Depends on effect
Edit F	Depends on effect	108	Depends on effect
EQ Low	-16 .. +16 dB	109	0 .. 32
EQ High	-16 .. +16 dB	110	0 .. 32
Mix	Depends on effect	111	Depends on effect
Store	U.001 .. U.100	112	0 .. 99
In/Out	BYP/0 .. 100%	113	0 = BYP / 1 = MIX
Combination Mode	SER 1, SER 2, PARA	114	0 = S1 / 1 = S2 / 2 = PA
Input Mode	MONO, STER	115	0 = MONO / 1 = STER
External/Internal Mix	EXTN/INTN	116	0 = EXTN / 1 = INTN

Tab. 7.4: Controller functions with MIDI

7.3 Default settings

Nr.	Effect	Edit A	Edit B	Edit C	Edit D	Edit E	Edit F	Mix
Reverb								
1	Cathedral	30 ms	5.11 s	10%	0	15%	7	50%
2	Gold Plate	10 ms	2.365 s	10%	33	32%	20	50%
3	Small Hall	2 ms	0.113 s	10%	23	15%	53 Hz	50%
4	Room	1.5 s	1.5 s	10%	25	0%	20	50%
5	Concert	10 ms	1.9 s	10%	-1.0	15%	7	50%
6	Studio	2 ms	0.252 s	10%	77 Hz	0 dB	437 Hz	50%
7	Stage	40 ms	2 s	40%	50	10.7 kHz	50%	50%
8	Spring Reverb	0 ms	1.465 s	25%	60%	5	6	50%
9	Ambience	2 ms	0.254 s	15	28	9 dB	9 kHz	50%
10	Early Reflections	20 ms	38	50%	15	100%	-	50%
11	Gated Reverb	10 ms	3.19 s	10%	40%	-21 dB	0.209 s	50%
12	Reverse Reverb	10 ms	3.19 s	10%	40%	-21 dB	0.376 s	50%
Delay								
13	Stereo Delay	350 ms	0 ms	450 ms	0 ms	35%	25%	50%
14	Tape Echo	190 ms	205 ms	50%	2402 Hz	176 Hz	5.32 kHz	50%
15	Ping Pong	320 ms	380 ms	45%	40%	190 ms	255 ms	50%
Modulation								
16	Stereo Chorus	0.247 Hz	50%	20.2 ms	180 d	Tri	0	50%
17	Analog Chorus	33	20	6	20	-	-	50%
18	Vintage Chorus	13	20	20	4	-	-	50%
19	Ultra Chorus	21	21	40	12	20	0	50%
20	Stereo Flanger	0.247 Hz	90%	80%	3.02 ms	45 d	4.54 kHz	50%
21	Vintage Flanger	13	16	20	11	-	-	50%
22	Jet Stream Flanger	16	6	20	11	-	-	50%
23	Stereo Phaser	1.526 Hz	100%	60%	180 d	2	Sin	100%
24	Vintage Phaser	28	100%	38	20	4	-	100%
25	Dual Phaser	28	100%	38	23	-	-	100%
26	Rotary	50	10%	20%	15%	50/50	316 Hz	100%
27	Pitch Shifter	+2	0 c	Ster.	0 c	Off	0 c	100%
28	Vibrato	1.27 Hz	85%	Sin.	25%	-	-	100%
29	Tremolo	2.2 Hz	50%	Opto	15%	-	-	100%
30	Auto Panning	3.21 Hz	80%	Sin.	0%	-	-	100%
Dynamics								
31	Compressor	4	-30 dB	+3 dB	3	37 ms	106 ms	100%
32	Expander	3.25	-9 dB	+3 dB	2	49 ms	167 ms	100%
33	Gated Reverb	54 ms	-12 dB	37 ms	37 ms	Mute	-	100%
34	Ana. Kompr./Lim.	3.00	-24 dB	+9.5 dB	0.0 dB	20 ms	Auto	100%
35	Ultramizer	36	9 dB	38	190 Hz	0%	12.5 kHz	Wide
36	Denoiser	916 Hz	75%	604 ms	-48 dB	33 ms	37 ms	100%
37	De-Esser	3.00	-36 dB	+6 dB	2.78 kHz	33 ms	Auto	Wide
38	Wave Designer	-25	+25	Ster.	0	Auto	0 dB	100%

Tab. 7.5: Parameter default settings of effects algorithms (continued on next page)

Nr.	Effect	Edit A	Edit B	Edit C	Edit D	Edit E	Edit F	Mix
Psycho Acoustics								
39	Exciter	7.08 kHz	1	25%	50%	Off	-	50%
40	Enhancer	11.0 kHz	2	10%	50%	251 Hz	11	40%
41	Ultrabass	110 Hz	25%	97 Hz	25%	3	50%	100%
42	Stereo Imager	50%	75%	Space	+1 dB	50%	50%	100%
43	Ultra Wide	40%	75%	1.01 kHz	-6 dB	-	-	100%
44	Binauralizer	40%	75%	Speaker	+6 dB	5	70%	100%
Filter/EQ								
45	Auto Filter	212 Hz	50%	LP.24	38	136 ms	442 ms	100%
46	LFO Filter	353 Hz	100%	BP.12	1..50	0.38 Hz	Tri	90%
47	Param. EQ	0 dB	1.43 kHz	2.24	0 dB	1.43 kHz	2.24	0 dB
48	Graph. EQ	0 dB	0 dB	0 dB	0 dB	0 dB	0 dB	0 dB
Distortion/Amp Simulation								
49	Vocal Distortion	51	25%	0.106 Hz	50%	3	0.321 Hz	100%
50	Tube Distortion	26	106 Hz	1.97 kHz	3.83 kHz	2	+8 dB	100%
51	Guitar Amp	60	65	100	51	8	0 dB	100%
52	Tri Fuzz	80	51	51	51	80	36	100%
53	Speaker Simulation	5	0 dB	1.43 kHz	2.24	-	-	100%
54	Ring Modulator	0.39 Hz	25%	179 Hz	2 kHz	LFO	-	100%
55	LoFi	7	2828 Hz	20%	40%	632 Hz	6.19 kHz	100%
Special FX								
56	Vinylizer	45.0 upm	75%	70%	60%	25	25	100%
57	Sampler	Stop	Stop	100%	Frwd	0.0 s	5.08 s	50%
58	Vocoder	25%	0%	24 ms	24 ms	-	-	100%
59	Voice Canceler	116 Hz	55%	50%	+1 dB	-	-	100%
60	Resonator	0.4 Hz	40%	298 Hz	-80%	LFO	-	100%
Combination								
61	Chorus & Reverb	0.285 Hz	100%	19.8 ms	60%	1.6 s	40%	65%
62	Flanger & Reverb	0.509 Hz	80%	+80%	40%	1.6 s	40%	62%
63	Leslie & Reverb	5.6 Hz	90%	50%	30%	1.0 s	40%	80%
64	Pitch & Reverb	+2	+0	0%	50%	1.6 s	40%	100%
65	Delay & Reverb	220 ms	50%	Ster.	55%	1.6 s	40%	50%
66	Tremolo & Reverb	3.97 Hz	100%	10%	40%	1.6 s	40%	80%
67	Phaser & Reverb	0.318 Hz	100%	-100%	40%	1.6 s	40%	50%
68	Chorus & Delay	0.318 Hz	100%	17.8 ms	30%	350 ms	40%	65%
69	Flanger & Delay	0.318 Hz	80%	+80%	30%	350 ms	40%	70%
70	Pitch & Delay	+4	+0	0%	30%	350 ms	40%	65%
71	Tremolo & Delay	0.73 Hz	95%	25%	15%	190 ms	40%	75%

Tab. 7.6: Parameter default settings of effects algorithms (continuation)

7.4 Parameter range of effects algorithms

Nr.	Effect	Edit A	Edit B	Edit C	Edit D	Edit E	Edit F	Mix
Reverb								
1	Cathedral	0 .. 200 ms	2.0 .. 8.0 s	0 .. 100%	-10 .. +10	0 .. 100%	1 .. 20	0 .. 100%
2	Gold Plate	0 .. 200 ms	1.2 .. 4.6 s	0 .. 100%	1 .. 50	0 .. 100%	1 .. 20	0 .. 100%
3	Small Hall	0 .. 50 ms	50 .. 380 ms	0 .. 100%	1 .. 50	0 .. 100%	20 .. 400 Hz	0 .. 100%
4	Room	0 .. 100 ms	1.0 .. 2.2 s	0 .. 100%	1 .. 50	0 .. 100%	1 .. 20	0 .. 100%
5	Concert	0 .. 200 ms	1.0 .. 5.0 s	0 .. 100%	-10 .. +10	0 .. 100%	1 .. 20	0 .. 100%
6	Studio	0 .. 50 ms	0.1 .. 1.0 s	0 .. 100%	20 .. 400 Hz	0 .. 30 dB	0.1 .. 10 kHz	0 .. 100%
7	Stage	0 .. 100 ms	0.6 .. 3.0 s	0 .. 100%	1 .. 50	15.0 .. 0.5 kHz	0 .. 100%	0 .. 100%
8	Spring Reverb	0 .. 50 ms	0.8 .. 2.0 s	0 .. 100%	0 .. 100%	0 .. 50	1 .. 20	0 .. 100%
9	Ambience	0 .. 50 ms	100 .. 640 ms	1 .. 20	1 .. 50	0 .. 30 dB	15.0 .. 0.5 kHz	0 .. 100%
10	Early Reflections	0 .. 200 ms	1 .. 50	0 .. 100%	1 .. 15	0 .. 100%	-	0 .. 100%
11	Gated Reverb	0 .. 200 ms	1 .. 10 s	0 .. 100%	0 .. 100%	0 .. -60 dB	0.02 .. 1 s	0 .. 100%
12	Reverse Reverb	0 .. 200 ms	1 .. 10 s	0 .. 100%	0 .. 100%	0 .. -60 dB	0.02 .. 1 s	0 .. 100%
Delay								
13	Stereo Delay	0 .. 5400 ms	0 .. 99 ms	0 .. 5400 ms	0 .. 99 ms	0 .. 100%	0 .. 100%	0 .. 100%
14	Tape Echo	0 .. 635 ms	0 .. 635 ms	0 .. 100%	0.1 .. 20 kHz	0.02 .. 10 kHz	0.1 .. 10 kHz	0 .. 100%
15	Ping Pong	0 .. 635 ms	0 .. 635 ms	0 .. 100%	0 .. 100%	0 .. 635 ms	0 .. 635 ms	0 .. 100%
Modulation								
16	Stereo Chorus	0.05 .. 5 Hz	0 .. 100%	5 .. 50 ms	0.45, 90, 180 d	Tri/Sine	0 .. 20	0 .. 100%
17	Analog Chorus	1 .. 50	1 .. 20	1 .. 20	1 .. 20	-	-	0 .. 100%
18	Vintage Chorus	1 .. 50	1 .. 20	1 .. 20	0 .. 20	-	-	0 .. 100%
19	Ultra Chorus	1 .. 50	1 .. 50	1 .. 50	1 .. 20	0 .. 20	0 .. 20	0 .. 100%
20	Stereo Flanger	0.05 .. 5 Hz	0 .. 100%	0 .. 100%	1 .. 10 ms	0.45, 90, 180 d	0.5 .. 20 kHz	0 .. 100%
21	Vintage Flanger	1 .. 50	1 .. 20	1 .. 20	1 .. 20	-	-	0 .. 100%
22	Jet Stream Flanger	1 .. 50	1 .. 20	1 .. 20	1 .. 20	-	-	0 .. 100%
23	Stereo Phaser	0.1 .. 10 Hz	0 .. 100%	0 .. 100%	0 .. 180 d	1, 2, 3	Tri, Sin, Squ	0 .. 100%
24	Vintage Phaser	1 .. 50	0 .. 100%	0 .. 50	1 .. 20	0 .. 20	-	0 .. 100%
25	Dual Phaser	1 .. 50	0 .. 100%	0 .. 50	1 .. 50	-	-	0 .. 100%
26	Rotary	1 .. 50	0 .. 100%	0 .. 100%	0 .. 100%	50/0 .. 0/50	0.1 .. 1 kHz	0 .. 100%
27	Pitch Shifter	-12 .. +12	-50 .. +50 c	St, -12 .. +12	-50 .. +50 c	Off, -12 .. +12	-50 .. +50 c	0 .. 100%
28	Vibrato	0.5 .. 20 Hz	0 .. 100%	Sin, Tri, Opto	0 .. 100%	-	-	0 .. 100%
29	Tremolo	0.5 .. 20 Hz	0 .. 100%	Sin, Tri, Opto, Squ, Sw, Up, Sw, Dw	0 .. 100%	-	-	0 .. 100%
30	Auto Panning	0.5 .. 20 Hz	0 .. 100%	Sin, Tri, Opto, Squ, Sw, Up, Sw, Dw	0 .. 100%	-	-	0 .. 100%
Dynamics								
31	Compressor	1.25 .. 100	-60 .. 0 dB	0 .. +24 dB	0 .. 6	50 .. 200 ms	0.05 .. 1 s	BYP, 100%
32	Expander	1.25 .. 100	-60 .. 0 dB	0 .. +24 dB	0 .. 6	50 .. 200 ms	0.05 - 1s	BYP, 100%
33	Gated Reverb	1 .. 1000 ms	-60 .. 0 dB	5 .. 200 ms	5 .. 500 ms	M, -60 .. 0 dB	-	BYP, 100%
34	Ana. Komp./Lim.	1.5 .. 100	-48 .. 0 dB	0 .. +24 dB	-24 .. 0 dB	1 .. 150 ms	50 .. 977 ms, A	BYP, 100%
35	Ultratizer	1 .. 100	0 .. 24 dB	1 .. 100	0.05 .. 10 kHz	0 .. 100%	2.5 .. 15 kHz	LO, HI, WD
36	Denoiser	0.04 .. 20 kHz	0 .. 100%	1 .. 1000 ms	-60 .. 0 dB	1 .. 1000 ms	5 .. 200 ms	BYP, 100%
37	De-Esser	1.5 .. 100	-48 .. 0 dB	0 .. +24 dB	0.5 .. 15 kHz	1 .. 150 ms	50 .. 977 ms, A	LO, HI, WD
38	Wave Designer	-50 .. +50	-50 .. +50	St, -50 .. +50	-50 .. +50	Auto, -24 .. +24 dB	Auto, -24 .. +24 dB	BYP, 100%

Tab. 7.7: Parameter range of effects algorithms (continued on next page)

Nr.	Effect	Edit A	Edit B	Edit C	Edit D	Edit E	Edit F	Mix
Psycho Acoustics								
39	Exciter	1 .. 10 kHz	1 .. 20	0 .. 100%	0 .. 100%	On, Off	-	0 .. 100%
40	Enhancer	2 .. 12 kHz	1 .. 20	0 .. 100%	0 .. 100%	50 .. 500 Hz	1 .. 20	0 .. 100%
41	Ultrabass	80 .. 150 Hz	0 .. 100%	30 .. 250 Hz	0 .. 100%	1 .. 7	0 .. 100%	BYP, 100%
42	Stereo Imager	0 .. 100%	0 .. 100%	Spread, Space	-6 .. +6 dB	0 .. 100%	0 .. 100%	BYP, 100%
43	Ultra Wide	0 .. 100%	0 .. 100%	0.1 .. 10 kHz	-12 .. +12 dB	-	-	BYP, 100%
44	Binauralizer	0 .. 100%	0 .. 100%	Phones, Speak	-12 .. +12 dB	0 .. 18	25 .. 100%	BYP, 100%
Filter/EQ								
45	Auto Filter	0.1 .. 15 kHz	0 .. 100%	LP12/24, HP12/24, BP12/24	1 .. 50	5 .. 2000 ms	5 .. 2000 ms	0 .. 100%
46	LFO Filter	Base Freq	0 .. 100%	LP12/24, HP12/24, BP12/24	1 .. 50	0.1 .. 20 Hz	Sin, Tri, Sw, Up, Sw, Dw, Squ	0 .. 100%
47	Param. EQ	-16 .. +16 dB	0.2 .. 10 kHz	0.5 .. 10	-16 .. +16 dB	0.2 .. 10 kHz	0.5 .. 10	-16 .. +16 dB
48	Graph. EQ	-16 .. +16 dB	-16 .. +16 dB	-16 .. +16 dB	-16 .. +16 dB	-16 .. +16 dB	-16 .. +16 dB	-16 .. +16 dB
Distortion/Amp Simulation								
49	Vocal Distortion	1 .. 100	0 .. 100%	0.05 .. 1 s	0 .. 100%	1, 2, 3	0.05 .. 2 Hz	0 .. 100%
50	Tube Distortion	1 .. 100	0.05 .. 1 kHz	1 .. 15 kHz	15 .. 1 kHz	1, 2, 3	-16 .. +16 dB	0 .. 100%
51	Guitar Amp	1 .. 100	1 .. 100	1 .. 100	1 .. 100	1 .. 8	-16 .. +16 dB	0 .. 100%
52	Tri Fuzz	1 .. 100	1 .. 100	1 .. 100	1 .. 100	1 .. 100	1 .. 100	0 .. 100%
53	Speaker Simulation	1 .. 8	-16 .. +16 dB	0.2 .. 10 kHz	0.5 .. 10	-	-	0 .. 100%
54	Ring Modulator	0.1 .. 10 Hz, 5 .. 500 ms, 1 .. 100 Hz	0 .. 100%	0.1 .. 10 kHz	0.2 .. 20 kHz	LFO, ENV, RAND, SIN	0 .. 100%	0 .. 100%
55	LoFi	24 .. 6	20 .. 0.4 kHz	0 .. 100%	0 .. 100%	0.02 .. 20 kHz	0.4 .. 20 kHz	0 .. 100%
Special FX								
56	Vinylizer	20 .. 80 upm	0 .. 100%	0 .. 100%	0 .. 100%	0 .. 50	0 .. 50	0 .. 100%
57	Sampler	Rec/Stop	Play/Stop	25 .. 400%	Back, Frwd, 1 .. 10 x	0 .. 5.04 s	0.04 .. 5.08 s	0 .. 100%
58	Vocoder	0 .. 100%	0 .. 100%	5 .. 200 ms	5 .. 200 ms	-	-	0 .. 100%
59	Voice Canceled	0.02 .. 1 kHz	0 .. 100%	0 .. 100%	-6 .. +6 dB	-	-	BYP, 100%
60	Resonator	0.1 .. 10 Hz, 5 .. 500 ms, 1 .. 100 Hz	0 .. 100%	0.2 .. 10 kHz	-100 .. +100%	LFO, ENV, RAND	0 .. 100%	0 .. 100%
Combination								
61	Chorus & Reverb	0.05 .. 5 Hz	0 .. 100%	5 .. 50 ms	0 .. 100%	0.5 .. 5 s	0 .. 100%	0 .. 100%
62	Flanger & Reverb	0.05 .. 5 Hz	0 .. 100%	-80 .. +80%	0 .. 100%	0.5 .. 5 s	0 .. 100%	0 .. 100%
63	Leslie & Reverb	1 .. 10 Hz	0 .. 100%	0 .. 100%	0 .. 100%	0.5 .. 5 s	0 .. 100%	0 .. 100%
64	Pitch & Reverb	-12 .. +12	-50 .. +50	0 .. 100%	0 .. 100%	0.5 .. 5 s	0 .. 100%	0 .. 100%
65	Delay & Reverb	30 .. 665 ms	0 .. 100%	Mo, St, PP, Tp	0 .. 100%	0.5 .. 5 s	0 .. 100%	0 .. 100%
66	Tremolo & Reverb	1 .. 10 Hz	0 .. 100%	0 .. 100%	0 .. 100%	0.5 .. 5 s	0 .. 100%	0 .. 100%
67	Phaser & Reverb	0.05 .. 5 Hz	0 .. 100%	-100 .. +100%	0 .. 100%	0.5 .. 5 s	0 .. 100%	0 .. 100%
68	Chorus & Delay	0.05 .. 5 Hz	0 .. 100%	5 .. 50 ms	0 .. 100%	30 .. 665 ms	0 .. 100%	0 .. 100%
69	Flanger & Delay	0.05 .. 5 Hz	0 .. 100%	-80 .. +80%	0 .. 100%	30 .. 665 ms	0 .. 100%	0 .. 100%
70	Pitch & Delay	-12 .. +12	-50 .. +50	0 .. 100%	0 .. 100%	30 .. 665 ms	0 .. 100%	0 .. 100%
71	Tremolo & Delay	0.05 .. 20 Hz	0 .. 100%	0 .. 100%	0 .. 100%	30 .. 665 ms	0 .. 100%	0 .. 100%

Tab. 7.8: Parameter range of effects algorithms (continuation)

8. SPECIFICATIONS

ANALOG INPUTS

Connectors	XLR and 1/4" TRS
Type	RF filtered, servo-balanced input stage
Impedance	80 k Ω balanced
Nominal Operating Level	-10 dBV or +4 dBu (selectable)
Max. Input Level	+15 dBu at +4 dBu nominal level, +1 dBV at -10 dBV nominal level

ANALOG OUTPUTS

Connectors	XLR and 1/4" TRS
Type	Electronically servo-balanced output stage
Impedance	80 Ω balanced
Max. Output Level	+15 dBu at +4 dBu nominal level, +1 dBV at -10 dBV nominal level

SYSTEM SPECIFICATIONS

Bandwidth	20 Hz to 20 kHz, +/- 3 dB
SNR	91 dB, unweighted, 20 Hz to 20 kHz
THD	0.018 % typ. @ +4 dBu, 1 kHz, 0 dBu input, gain 1
Crosstalk	< -76 dB

MIDI INTERFACE

Type	5-pin DIN-socket IN / OUT / THRU
------	----------------------------------

DIGITAL PROCESSING

Converters	24-bit Sigma-Delta, 64/128-times oversampling
Sampling Rate	46.875 kHz

DISPLAY

Type	4-digit 14 segment alpha-numeric LED-Display
------	--

POWER SUPPLY

Voltage	USA/Canada 120 V~, 60 Hz Europe/U.K./Australia 230 V~, 50 Hz Japan 100 V~, 50 - 60 Hz General export model 120/230 V~, 50 - 60 Hz
Fuse	100 - 120 V~: T 200 mA H 250 V 200 - 240 V~: T 100 mA L 250 V
Power Consumption	15 Watts max.
Mains Connection	Standard IEC receptacle

PHYSICAL

Dimensions (H x W x D)	1 3/4" x 19" x 8" (44 mm x 482,6 mm x 204,4 mm)
Net Weight	approx. 4 1/2 lbs (2 kg)
Shipping Weight	approx. 6 2/3 lbs (3 kg)

9. WARRANTY

§ 1 WARRANTY CARD/ONLINE REGISTRATION

To be protected by the extended warranty, the buyer must complete and return the enclosed warranty card within 14 days of the date of purchase to BEHRINGER Spezielle Studiotechnik GmbH, in accordance with the conditions stipulated in § 3. Failure to return the card in due time (date as per postmark) will void any extended warranty claims. Based on the conditions herein, the buyer may also choose to use the online registration option via the Internet (www.behringer.com or www.behringer.de).

§ 2 WARRANTY

1. BEHRINGER (BEHRINGER Spezielle Studiotechnik GmbH including all BEHRINGER subsidiaries listed on the enclosed page, except BEHRINGER Japan) warrants the mechanical and electronic components of this product to be free of defects in material and workmanship for a period of one (1) year* from the original date of purchase, in accordance with the warranty regulations described below. If the product shows any defects within the specified warranty period that are not excluded from this warranty as described under § 4, BEHRINGER shall, at its discretion, either replace or repair the product using suitable new or reconditioned parts. In the case that other parts are used which constitute an improvement, BEHRINGER may, at its discretion, charge the customer for the additional cost of these parts.

2. If the warranty claim proves to be justified, the product will be returned to the user freight prepaid.

3. Warranty claims other than those indicated above are expressly excluded.

§ 3 RETURN AUTHORIZATION NUMBER

1. To obtain warranty service, the buyer (or his authorized dealer) must call BEHRINGER (see enclosed list) during normal business hours **BEFORE** returning the product. All inquiries must be accompanied by a description of the problem. BEHRINGER will then issue a return authorization number.

2. Subsequently, the product must be returned in its original shipping carton, together with the return authorization number to the address indicated by BEHRINGER.

3. Shipments without freight prepaid will not be accepted.

§ 4 WARRANTY REGULATIONS

1. Warranty services will be furnished only if the product is accompanied by a copy of the original retail dealer's invoice. Any product deemed eligible for repair or replacement under the terms of this warranty will be repaired or replaced.

2. If the product needs to be modified or adapted in order to comply with applicable technical or safety standards on a national or local level, in any country which is not the country for which the product was originally developed and manufactured, this modification/adaptation shall not be considered a defect in materials or workmanship. The warranty does not cover any such modification/adaptation, irrespective of whether it was carried out properly or not. Under the terms of this warranty, BEHRINGER shall not be held responsible for any cost resulting from such a modification/adaptation.

3. Free inspections and maintenance/repair work are expressly excluded from this warranty, in particular, if caused by improper handling of the product by the user. This also applies to defects caused by normal wear and tear, in particular, of faders, crossfaders, potentiometers, keys/buttons, tubes, guitar strings, illuminants and similar parts.

4. Damages/defects caused by the following conditions are not covered by this warranty:

▲ improper handling, neglect or failure to operate the unit in compliance with the instructions given in BEHRINGER user or service manuals.

▲ connection or operation of the unit in any way that does not comply with the technical or safety regulations applicable in the country where the product is used.

▲ damages/defects caused by force majeure or any other condition that is beyond the control of BEHRINGER.

5. Any repair or opening of the unit carried out by unauthorized personnel (user included) will void the warranty.

6. If an inspection of the product by BEHRINGER shows that the defect in question is not covered by the warranty, the inspection costs are payable by the customer.

7. Products which do not meet the terms of this warranty will be repaired exclusively at the buyer's expense. BEHRINGER will inform the buyer of any such circumstance. If the buyer fails to submit a written repair order within 6 weeks after notification, BEHRINGER will return the unit C.O.D. with a separate invoice for freight and packing. Such costs will also be invoiced separately when the buyer has sent in a written repair order.

§ 5 WARRANTY TRANSFERABILITY

This warranty is extended exclusively to the original buyer (customer of retail dealer) and is not transferable to anyone who may subsequently purchase this product. No other person (retail dealer, etc.) shall be entitled to give any warranty promise on behalf of BEHRINGER.

§ 6 CLAIM FOR DAMAGES

Failure of BEHRINGER to provide proper warranty service shall not entitle the buyer to claim (consequential) damages. In no event shall the liability of BEHRINGER exceed the invoiced value of the product.

§ 7 OTHER WARRANTY RIGHTS AND NATIONAL LAW

1. This warranty does not exclude or limit the buyer's statutory rights provided by national law, in particular, any such rights against the seller that arise from a legally effective purchase contract.

2. The warranty regulations mentioned herein are applicable unless they constitute an infringement of national warranty law.

* Customers in the European Union please contact BEHRINGER Germany Support for further details.

Technical specifications and appearance subject to change without notice. The information contained herein is correct at the time of printing. The names of companies, institutions or publications pictured or mentioned and their respective logos are registered trademarks of their respective owners. Their use neither constitutes a claim of the trademarks by BEHRINGER® nor affiliation of the trademark owners with BEHRINGER®. BEHRINGER® accepts no liability for any loss which may be suffered by any person who relies either wholly or in part upon any description, photograph or statement contained herein. Colours and specification may vary slightly from product. Products are sold through our authorised dealers only. Distributors and dealers are not agents of BEHRINGER® and have absolutely no authority to bind BEHRINGER® by any express or implied undertaking or representation. No part of this manual may be reproduced or transmitted in any form or by any means, electronic or mechanical, including photocopying and recording of any kind, for any purpose, without the express written permission of BEHRINGER Spezielle Studiotechnik GmbH. BEHRINGER® is a registered trademark.

ALL RIGHTS RESERVED. © 2004 BEHRINGER Spezielle Studiotechnik GmbH,
Hanns-Martin-Schleyer-Str. 36-38, 47877 Willich-Münchheide II, Germany.
Tel. +49 2154 9206 0, Fax +49 2154 9206 4903

FEDERAL COMMUNICATIONS COMMISSION COMPLIANCE INFORMATION

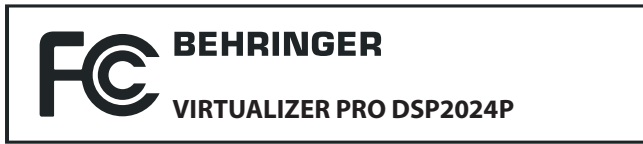

Responsible party name: **MUSIC Group Services USA, Inc.**
Address: **18912 North Creek Parkway,
Suite 200 Bothell, WA 98011,
USA**
Phone/Fax No.: **Phone: +1 425 672 0816
Fax: +1 425 673 7647**

VIRTUALIZER PRO DSP2024P

complies with the FCC rules as mentioned in the following paragraph:

This equipment has been tested and found to comply with the limits for a Class B digital device, pursuant to part 15 of the FCC Rules. These limits are designed to provide reasonable protection against harmful interference in a residential installation. This equipment generates, uses and can radiate radio frequency energy and, if not installed and used in accordance with the instructions, may cause harmful interference to radio communications. However, there is no guarantee that interference will not occur in a particular installation. If this equipment does cause harmful interference to radio or television reception, which can be determined by turning the equipment off and on, the user is encouraged to try to correct the interference by one or more of the following measures:

- Reorient or relocate the receiving antenna.
- Increase the separation between the equipment and receiver.
- Connect the equipment into an outlet on a circuit different from that to which the receiver is connected.
- Consult the dealer or an experienced radio/TV technician for help.

This device complies with Part 15 of the FCC rules. Operation is subject to the following two conditions:

- (1) this device may not cause harmful interference, and
- (2) this device must accept any interference received, including interference that may cause undesired operation.

Important information:

Changes or modifications to the equipment not expressly approved by MUSIC Group can void the user's authority to use the equipment.